

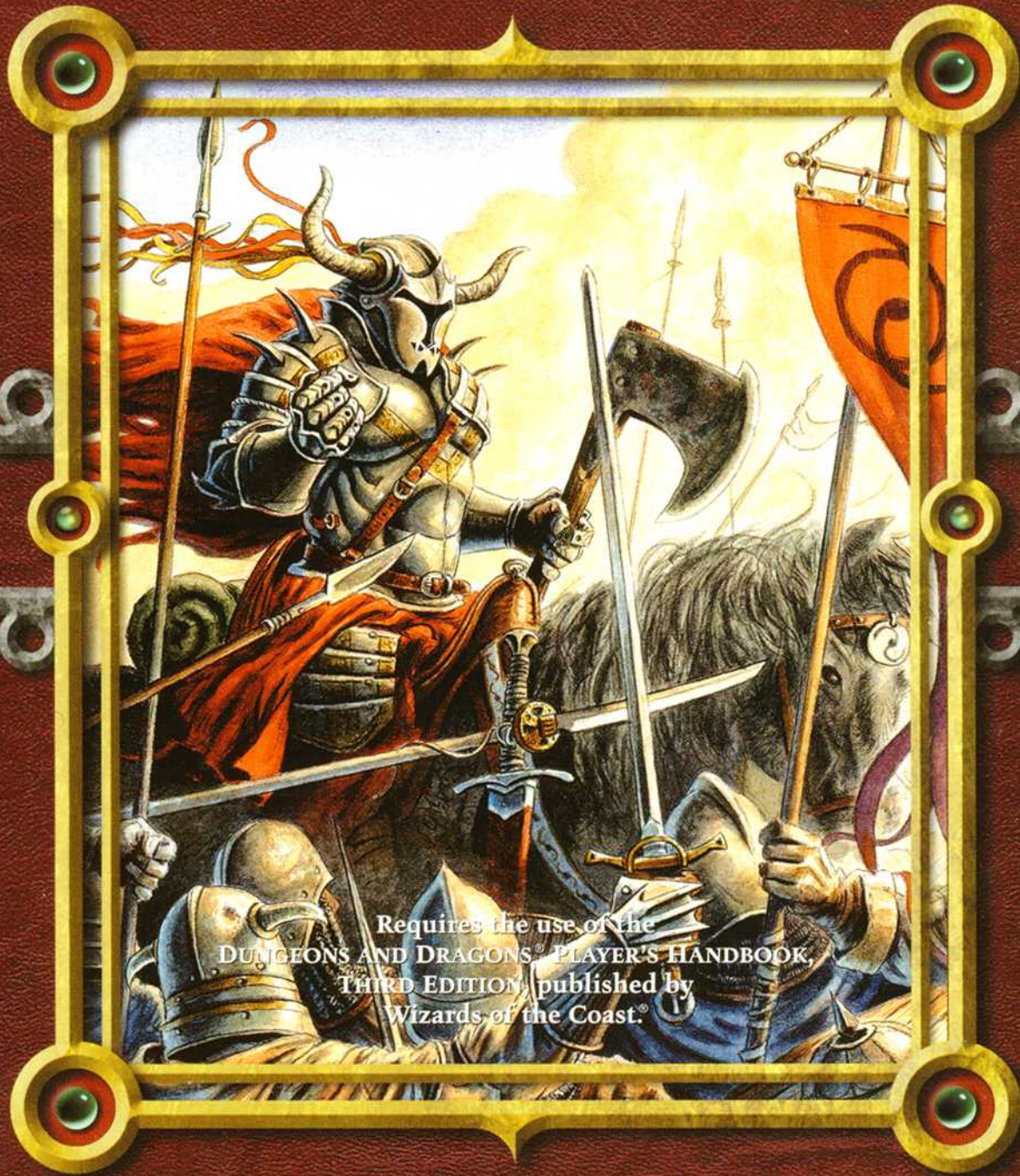

WAR™



Requires the use of the
DUNGEONS AND DRAGONS® PLAYER'S HANDBOOK,
THIRD EDITION, published by
Wizards of the Coast.®



WAR



The glory of combat, the honor of victory, and the valor of noble men waging war in the name of nobility and grace.

CREDITS

WRITING: Peter Flanagan, Andrew Getting, Travis Heermann, Mike Mearls, jim pinto, John Baxter Stringfellow, Eric Steiger, Douglas Sun and Rich Wulf

ART DIRECTION: jim pinto

COVER DESIGN: Justin Lawler and Mark Jelfo

COVER ILLUSTRATION: Jonathan Hunt

INTERIOR ARTWORK: Julian Aguilera, Andrew Baker, Darren M. A. Calvert, Troy Graham, Dominic Hamer, Scott James, Mike Sellers and Ethan Slayton

EDITING: Andrew Getting, Shane Lacy Hensley and jim pinto

INTERIOR DESIGN AND LAYOUT: Justin Lawler and Mark Jelfo

PROJECT MANAGER: jim pinto

PLAYTESTING AND ADVICE: John Baxter Stringfellow, James "Sparky" Sparling, Kevin Millard, Erik Yaple, Mike Leader and Jeff Ibach.

SPECIAL THANKS

jim pinto would like to thank everyone who worked so hard on this, especially Eric Steiger who lost sleep trying to finish the mass combat rules and Laura who made sure I didn't stay up too late worrying about it. Special thanks to Jon Hunt for doing more than his fair share on this cover. A very special thanks to Kitty, who — by the old adage — taught Eric exactly what is fair in war.

DEDICATION

This is for those who never came home.

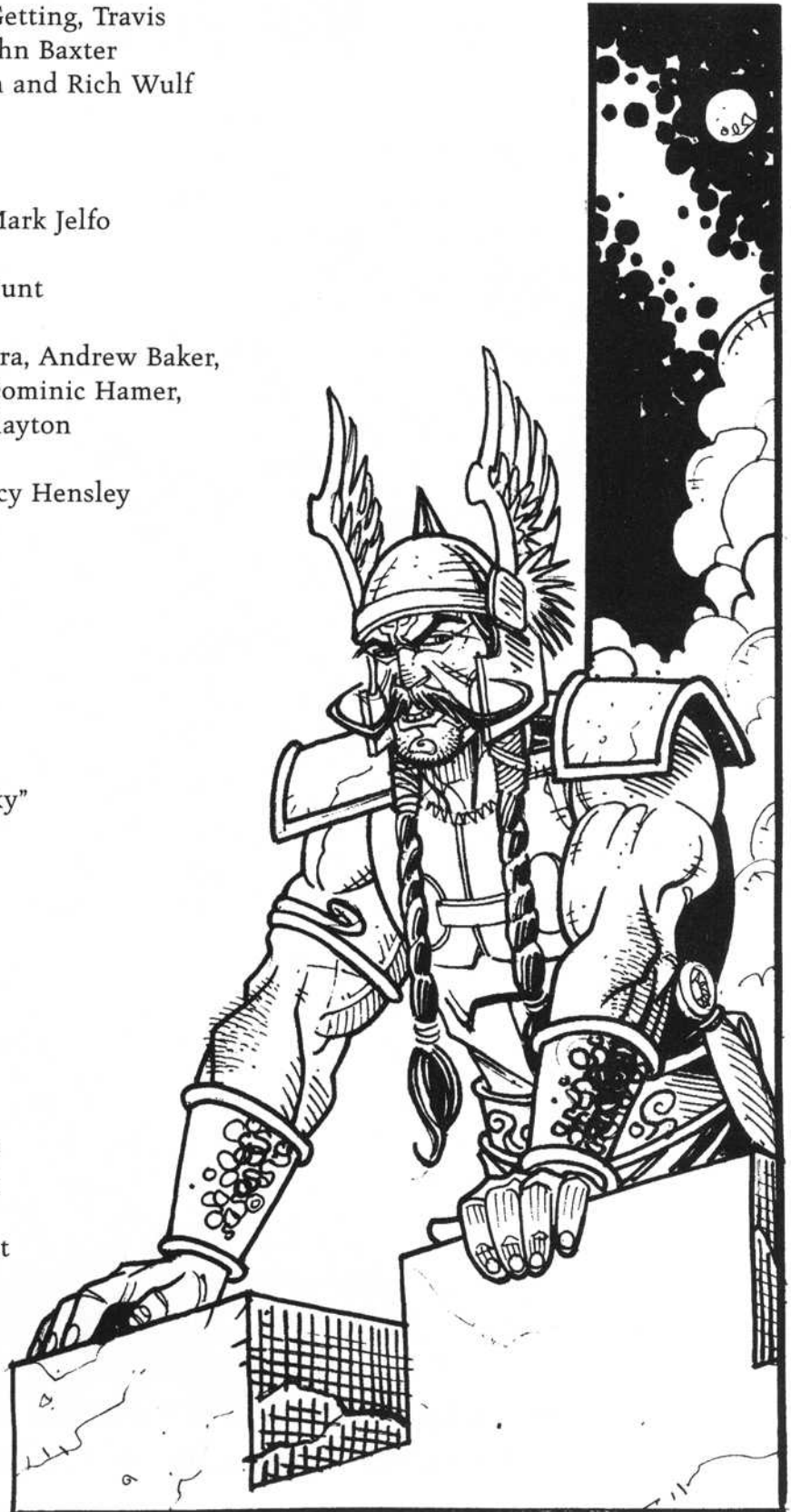

TABLE OF CONTENTS

INTRODUCTION	4
CHAPTER ONE: WAR WITHOUT END	5
CAUSE AND EFFECT	5
AGAINST THE AVALANCHE	9
INTO THE ABYSS	15
FOR WANT OF A NAIL	18
DIVISIONS	21
FORMATIONS AND TACTICS	25
LOGISTICS	32
MAGIC ON THE BATTLEFIELD	34
DIFFERENT RACES AT WAR	36
CHAPTER TWO: WARS MAKE SOLDIERS	40
NEW USES FOR OLD SKILLS	40
NEW FEATS	44
PRESTIGE CLASSES	48
CHAPTER THREE: THE SIEGE	88
SIEGE TACTICS	88
SIEGE IN A FANTASY WORLD	92
SIEGE ENGINES	92
CHAPTER FOUR: WAR MAGIC	106
DIVINE MAGIC	109
WORSHIPPING WAR	110
DOMAINS	112
NEW MAGIC	115
NEW SPELLS	117
MAGIC ITEMS	120
CHAPTER FIVE: DEATH OF NATIONS	122
TYPES OF WAR	122
BEHIND THE WAR	123
WINNING THE WAR AND CLEANING UP	125
WAR AS CAMPAIGN	125
STATS AND WAR	127
NEW SKILLS	136
UNIT BASED COMBAT	137
THE WEAR OF BATTLE	138
WINNING THE BATTLE	140
ABSTRACT BATTLE RULES	141

INTRODUCTION

INTRODUCTION

"War is politics at the end of a sword."

—From the journal of Lieutenant Allyn Wyrthorp

Field Marshall Gorin of Banikmoor called me into his tent today. We spoke at length of the coming battle with the orcs and the death of so many soldiers at Gorzhan Bluff. He seemed solemn, changed somehow. We've never been close and I always thought he regarded me as just another resource, like an oxen or a supply sergeant.

But somehow, today, things were different.

He called me by my first name, which was startling, though I tried not to show it. He said that he appreciated everything I'd done for him in this campaign and was glad we could serve together. I swear, if I didn't know any better I would think he intended to die tomorrow.

Before I knew it, he was drinking brandy and telling me war stories. I was surprised to learn that he was a rank and file soldier during The Red Summer Wars and Battles of Westbrink. I studied them as a cadet, but he spoke of them from such a different point of view, I almost thought he wasn't there.

Being in the trenches had an effect on him, I guess. Sure he cares about his men, but it made him understand why things are the way they are. He explained that life looked much different when you're facing down a hobgoblin horde, than when you're sitting in a room moving pegs across a map. He talked to me about the details, the little things. How a unit's defenses crumble, once a wall is breached and how you can spread their defenses thin with a simple spear charge.

It was all the things I learned at the academy, but it wasn't. It was a like a new breath instilled into an old tired subject. He told me that he never thought that cavalry was worth a damn. Said that infantry always got the job done. Shock troops were good in skirmish, but nothing beats 60 footmen standing shoulder to shoulder against a avalanche of goblins.

I stifled a chuckle as he danced around the room, talking in a manner I never thought a general could.

He continued to explain how archers and artillery were more important than any generals realized. He put great faith in their ability to suppress enemy units and demoralize irregular troops. "Most ogres aren't fit to plow, let alone withstand 30 minutes of constant trebuchet fire." He slammed his drink down and fell into his chair. "You've a lot to learn about being a soldier. And I don't have the time to teach you." He slurred as he nodded off. I was sure he was out for the night, so I gathered my things.

He stood up, a few minutes later, and told me to take Iv'ryk's Brigade to the north end of the gorge before day-break. There I would flank the orcs as we drove them out of their caves and into the valley floor. He wants to lead the rest of the troops from the east. He expects the charge to be over in a few hours and left me detailed instructions for organizing the hunting parties.

Before it was too late, he asked me to make sure his uniform was clean and his weapons sharpened. And as always, he called me Lieutenant, waved me off and returned to his papers.

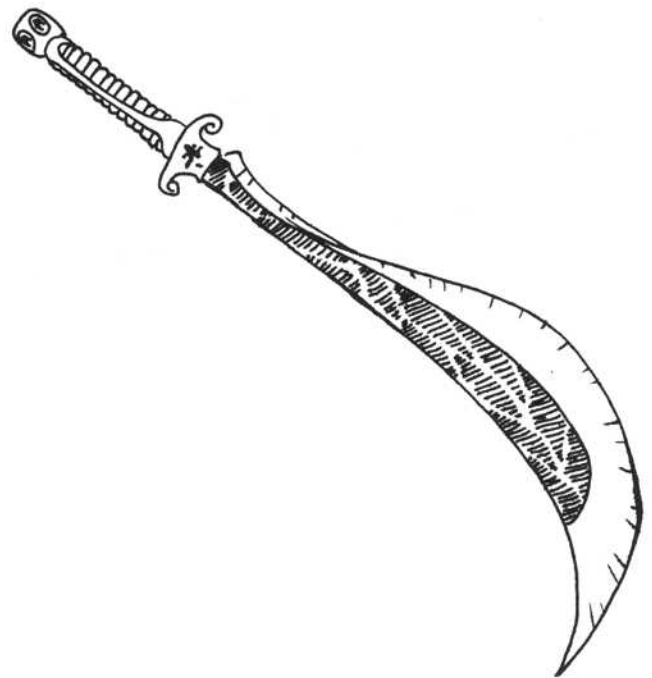

CHAPTER ONE: WAR WITHOUT END

CAUSE AND EFFECT

In the fantasy genre, the Epic Battle of Good and Evil begins with the vast hordes of villainous goblinoids wiping out the armies of the Noble Alliance. The Evil Overlord who sent them is likely to have an Implausible Plot Device that makes him/her/it all but invincible. Thus, the remaining ragtag forces must hold off the numerically superior monster army while Our Heroes search for the Dubious Resolution Artifact to defeat the Overlord and its armies.

Not surprisingly, most wars don't begin in any manner remotely like this.

Wars are almost always fought over three things: resources, political power, and religion. Sometimes, a war might be fought over something else, such as an insult or assassination, but these wars are a long time coming nonetheless. In the end, humans are endlessly inventive when it comes to finding excuses to kill one another.

Sadly, simple misunderstandings have caused their fair share of wars. Anything from ambiguous treaties to the vagaries of translation can begin the tragic road to war. A king thinks he is getting two-thirds of the disputed land between the nations, while the duke thinks they are dividing it evenly. An honorific in one language is a deadly insult in another. Bandits attack a diplomatic envoy, and the incident is mistaken for the foulest treachery. Diplomats can often smooth over such incidents, their efforts preventing more wars than have ever been fought. But, when diplomacy fails, both sides prepare to fight for what they believe is rightfully theirs, whether it's land, justice, money, or just regaining face.

Another ancient theme is the idea of innate superiority, often called *manifest destiny*. Sometimes, there is a demonstrable advantage one culture has over others (organization, technology, magic, etc.). However, equally often this *superiority* is merely one of numbers or resources. This culture attempts to rule others, whether the invaded societies like it or not. Sometimes, if the advantages of joining the empire are genuine and demonstrable (and the expanding culture is willing to negotiate), a nation can absorb others with little or no bloodshed. Most people, however, are disinclined to think of themselves as *inferior*, and many legends and tales arise around the resultant slaughters. It is worth noting, though, that many supposedly inferior cultures have decimated would-be conquerors. Legendary Thermopylae is only the most dramatic example of what a handful can do against much larger armies.

This becomes more problematic when *manifest destiny* is religious — it is much harder to doubt the will of the gods than it is to question conquest for simple power. There are enough belief systems in the world claiming to have the one and only Truth, that clashes become inevitable. Of particular difficulty in fantasy worlds are high priests with the power to prove their convictions. Unless the god or gods in question take action, a powerful cleric can perform literal miracles, making a divine call to arms extremely difficult to dispute. On the other hand, it does not take high-level spells to sway the fervent and fanatical. Simple charisma and dogma, potent even with inherently good religions, can turn believers into an implacable army. Particularly ironic are battles between members of the same

religion, sometimes over minutiae that would have an outsider struggling to figure out the difference between the two sides.

Just because a nation has fallen does not mean it will remain that way. One rabble rouser is all it takes to get a good rebellion in full swing. How well the dominant culture has treated its subjects determines the ease with which a charismatic leader can rally the conquered, but any people with a unifying culture and history can rebel if someone evokes enough pride in their *glorious past*. If the conquerors are arrogant, cruel, or both (as is often the case), a rebellion may form almost of its own accord. Either way, the Great Power may well find itself fighting a war from within if they do not maintain order. Even millennia later, people with enough cultural identity may find reason to fight for independence.

Sometimes, there is no misunderstanding or intention of sweeping conquest. Throughout history, nations have disputed borders. The area becomes one of cultural intermingling, and either side can get greedy. If the resources of this area are valuable, it can become particularly important during difficult times... especially if one side is waging another war somewhere else. However, equally often this area is

nothing more than a point of national pride — making it a target for rhetoric whenever an internal power struggle occurs. Many a would-be tyrant has parleyed the return of a nation's *rightful territory* into absolute power, at least for a little while. Tyranny is hardly a necessity for such an occurrence, however; even if the leaders of a nation are reasonable, any number of events can spark a popular movement to retake the nation's former holdings.

While these are among the more common reasons for war, there are many other possibilities, particularly in a fantasy world. A third party can raise tensions between nations in any world, but magic makes it so much easier. Shapeshifting spells can turn a skilled spy into an important diplomat or famous champion. Carefully-applied illusions can turn fantasy into rumor, and rumor into undeniable fact, no matter how outlandish the original fabrication. Subtle mental magics easily turn casual rivals into bitter enemies when applied imaginatively, as the most innocent comments twist in the victim's mind.

Even without magic, forged papers and counterfeit documents can turn rivals against one another in a clever ruse. Assassination requires no magic, just ruthlessness, and framing someone for the murder is



a lot easier in a more primitive age. In such cases, magic is only necessary to counter magical means of determining falsehood. The reasons for starting a war between two other nations vary, but usually involve greed, political influence, or both. Profit is a certainty when selling supplies during a war, and if a neutral party can manage to convince both sides of its trustworthiness, selling to both sides can result in riches beyond avarice. Sufficient greed guarantees the profiteers will care little of the thousands or millions who suffer as a result. In the latter case, getting two enemies who are rivals themselves to war with one another is a convenient way to dispose of them, while preventing the third nation from suffering the pain of war. A variant of this sort of thing is the war by proxy, where nations pit weaker allies against each other when direct warfare is impractical for whatever reason.

Disturbingly, a single wizard can become a world power with access to enough corpses and spell components. A goblinoid army is unnecessary when the dead can rise — an army without conscience, consciousness, hunger, or disloyalty, despite their simple-mindedness and common vulnerabilities. Nevertheless, an entire nation can find itself at war with a single megalomaniac who has access to powerful magic and raw materials. Sufficiently powerful artifacts can set whole worlds against a single evil genius with endless legions of slavish warriors and servants. Though the stuff of heroic fantasy quests, a magical setting makes it entirely too plausible.

Religious issues become more problematic when genuine gods become involved. While ambitious clerics can falter if a god disapproves of war-mongering, who can gainsay the gods themselves when they cry havoc? In most fantasy worlds, the concept of faith is not a necessary component to religion; divine power is an ever-present part of life, and defying a god has dire consequences. While the chances are that there are other gods to convert to should a particular deity's demands become intolerable, most divinities are leery of casual conversion. Of course, the divine call to battle can be one of good against evil, but that is hardly a require-

ment. The gods know that spirits will go to their just reward, so what are a few lives spent in service to them? After all, what could be more important than doing the will of the gods? The misery caused on the mortal planes is an ephemeral thing; divinity is eternal.

Finally, while pure and simple hatred is a rare cause for war, it is not unheard of. There is usually some pretext to justify hate, but in most cases it is exactly that — an excuse. The rivals are dishonest, ugly, dangerous, untrustworthy, or just plain *different*. Add one power-hungry opportunist, stir with jealousy or greed, feed with easy prey, and heat to a boil to get an instant recipe for a real war of good against evil. Good luck trying to convince the hate-ridden that they're the villains, though. After all, they're doing the world a service by getting rid of their hated foes!

A CALL TO ARMS

However the war comes, there are only two major factors to consider when determining how the various factions react: how much does each side know about what the other is doing, and how sophisticated is each side in its wartime activity?

Historically, many wars were amazingly *civilized* affairs by modern standards, particularly during the Middle Ages from which so much high fantasy draws its inspiration. Armies would politely line up on a relatively clean field, safely away from populated areas, stand opposite one another, and wait for the order to attack. Higher ranking members of each side would often treat with each other politely, sometimes even while their men were killing one another. Captured nobles could expect fine treatment and a certain amount of comfort, and a return to their homeland once their allies paid the reasonable ransom.

Of course, those were the ideal conditions. Conditions were often less than ideal, and when hatred or fanaticism crept into the equation, matters could — and did — grow ugly with alacrity. When they did, warfare became more... complex.

Whether a war is fought with genteel honor or vicious abandon, a few things remain constant. Primarily, a war needs *warriors*. Some nations are notorious for conscription, but in general, the best troops are the most loyal ones. Either way, unless a nation maintains a large standing army, these warriors have to leave other jobs to join up. Others must fill these gaps, or vital work may go undone. This also happens if any real casualties are suffered.

Rhetoric and propaganda keep both soldiers and civilians in favor of the conflict, and hopefully weaken the resolve of the opposing kingdom's population in the bargain. Nothing undermines a war more quickly than people with no stomach for its hardships and bloodshed.

Next, soldiers need *weapons*. The sort of resources required vary depending on the type of conflict, but follow certain patterns. These can be found in the sections on supplies and logistics later in the chapter.

Finally, even the most honorable warriors attempt to gather some sort of *intelligence* on their enemies. This is the single-most contentious factor of warfare, and can mean anything from advance scouts to torturing captured officers for information. Agents from spies to diviners seek out information in such situations. Just how far each side is willing to go depends on both their own honor and their estimation of the enemy's — and particularly in fantasy, different cultures have different ideas of honor.

The question of intelligence is particularly relevant when one side has no intention of declaring war in advance of an attack. With enough planning, the defenders may not discover they are at war until they see the invading army marching down on them. In this case, preparations by the attackers must be subtle, to hide them from the curious and suspicious. Depending on how much the targeted nation suspects, this may be a relatively simple affair, or a terribly risky gambit — once caught preparing to launch a sneak attack on a neighbor, the rest have cause to be angry and frightened.

This can result in the defenders becoming aggressors, with a great many allies attacking alongside them.

Regardless of the intent of each side, definite levels of sophistication (or deception) arise. Please keep in mind that these categories are meant to be broad and basic, and should be used as aids in role-playing rather than strongly defining characteristics of an army or society.

WAR AS AN ALIEN CONCEPT

Either the society is completely pacifistic, never having known true conflict, or has never organized battle beyond personal duels and tavern brawls. Any organized army can easily conquer this society, though keeping it may well be another matter.

WAR AS A DUEL OF HONOR

Conflict has very restrictive rules, or the most extensive strategy is to gather as many warriors as possible and throw them at the enemy. In this category, war is fought strictly on the battlefield, either in a carefully regimented manner or as two mobs. Either way, civilians find out what happened when the victors and any surviving among the defeated announce the results of the battle. Intelligence on the enemy amounts to looking across the battlefield and counting how many soldiers the foe has, and of what types.

WAR AS A CHESS MATCH

The battlefield is now more complex, with genuine strategies and misdirections possible balanced by well-defined rules or propriety. For whatever reason, cheating is unwise, or this sort of conflict will quickly evolve to the next stage. Troop movements can be subtle and misleading, and military intelligence begins to come into its own. Knowing where the enemy is moving, and what forces he brings to bear, becomes highly important. However, when opposing forces meet, the rules of engagement are similar to those in category one. War is kept on the battlefield, and a certain amount of civility is expected between enemies when they're not trying to kill one another.

WAR AS VIOLENT DIPLOMACY

Most warfare throughout history falls roughly into this category. While there are still many rules to the conflict, subterfuge and sabotage have joined the equation. Rules primarily affect how to treat civilians and prisoners, the sort of weapons allowed, and what actions special operatives may take. However, the undercover agent comes into existence at this point, and the strategic target emerges as a concept. The battlefield is no longer a set location, as armies attack resources as well. Armed forces are still the primary weapons of war, and honor remains valuable, but flexibility permeates this sort of conflict.

WAR AS MACHIAVELLIAN INTRIGUE

At this stage, the battlefield is as much behind the scenes as open. Betrayal, assassination and financial conflict play at least as much of a role in warfare as armed warfare. Indeed, potent nations may fight entire cold wars by shadowy proxy, through fiefdoms encouraged to fight small wars in service of the mighty. Even in this, there are rules. The civilians as a whole typically escape the full wrath of the battle, while assassins usually target only those within the circles of the shadow forces and military. No side truly desires wanton destruction, though such a threat may arise if the conflict lingers. The ethics may be situational, but even the most callous spy has limits. After all, what's the point in ruling a barren wasteland?

WAR WITHOUT END

When one side of a conflict adheres to no rules at all, the resultant cycle of hatred likely continues so

long as both sides exist. Terror, cruelty, and extremism reach terrible heights under the tacit approval of the leadership. Destruction of the enemy is an almost sacred task, sometimes literally holy in the case of crusaders. While some may maintain their restraint and integrity in the face of such vile behavior, all too often the response to hatred is hatred. One vicious act leads to another, the rhetoric of annihilation grows louder, and eventually both sides face total war... war without end.

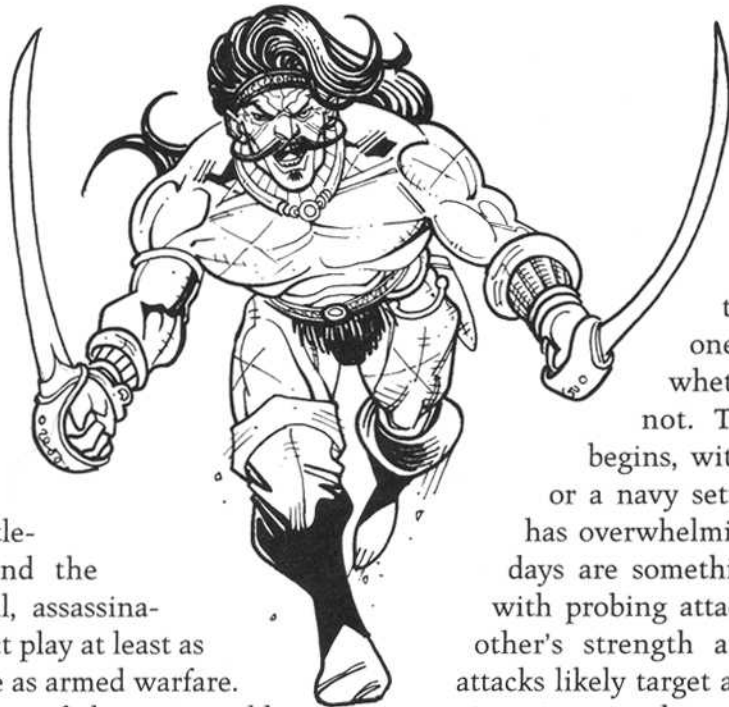

AGAINST THE AVALANCHE

With war, leaders strategize and arrange troop formations. When one side is ready, it moves, whether the other is ready or not. This is when war truly begins, with an army on the march or a navy setting sail. Unless one side has overwhelming force, a war's opening days are something like a fencing match, with probing attacks as each side tests the other's strength and resolve. The earliest attacks likely target any resources in the *border* regions. In a naval campaign, island ports constitute the border region. Eventually, one side (typically the aggressor) attacks in earnest and battle is truly joined.

At this point, both sides have most likely turned their entire societies to a wartime footing. Manufacturing must remain steady to serve both the armed forces and the home front. The focus on wartime supplies increases. Production of propaganda begins. If there is a significant chance the war will reach populated areas, leaders formulate evacuation plans, and able-bodied citizens likely take up arms if pressed.

On the battlefield, soldiers facing war for the first time learn its unique horrors. The grim realities of actual combat are not the only nightmare fresh

troops face, but they are the most immediately dramatic. Desertion, at a much higher rate than most officers ever report, follows, and even in the heat of combat it takes a certain act of will to end another person's life, with those unwilling to kill dying for their conscience. The slow and the reluctant either learn or die quickly. Even in the most lopsided battle, casualties mount on both sides. In addition to the dead, many injured are too crippled to continue to serve (again, particularly in melee) and return home unless transportation allows. The survivors often bury some friends and watch others leave broken in body, spirit, or both.

Blades and arrows aren't the only threats soldiers face. Disease is rampant in most warfare, as it has many routes into the camps of armies. The wounded are the most vulnerable to illness, as nearly any infection can take hold of them. Battlefields tend to be messy places, and no one sterilizes their weapons before battle. Many medieval cultures were notorious for their lack of hygiene, and between the lack of waste disposal and the close quarters, plagues spread easily. Animals carried disease as well. A number of illnesses are transferred by fleas found on the very horses necessary for pre-industrial war efforts. Other animals found in war efforts, including dogs, mules, and even fantastic creatures such as griffins, are potential vectors for plagues or illnesses. Disturbingly, some especially desperate cultures use the bodies of those killed by plague as weapons, employing siege engines to hurl them into the camp of the enemy.

Finally, no army can march without food. While protecting supply lines from the enemy is one thing, keeping rats and insects out of the grain is another matter entirely. Indeed, many cultures felt it far too much trouble to keep vermin out of the food. All manner of diseases can decimate an army — or even a populace, in desperate situations like sieges — simply because of diseased food.

As wars go on, food itself becomes a form of ammunition. Bows need arrows and soldiers need bread. Bows, however, don't wither away without arrows. If the enemy can cut off supply lines, the

threat of starvation may elicit surrender from even the most stalwart of foes. This is a major strategic coup, because the supply lines become more vital as they dwindle, pulling soldiers from the front lines to defend rations. If one side presses into the other's territory, farms and livestock become casualties as well. This makes hunger an issue not only for the army, but for the entire nation.

Finally, simple serendipity may serve an army, as perfectly normal storms or crop failures force terrible decisions on the other side about who eats and who starves. No matter how a shortage of food comes to pass, the effects are roughly the same. The soldiers tire and become irritable. Morale suffers. Most officers almost certainly have better rations than the enlisted men (usually for perfectly valid reasons, though some may use their positions for further advantage). This almost certainly causes resentment among the common infantry, which only increases as time goes on. The people either butcher the animals or continue to feed them, either choice worsening the situation still further. Unless the starving forces retreat or surrender, mutiny is almost inevitable as the choices become rebel or starve.

Back home, tension continues to mount unless reliable reports of victory return with the wounded or come from the government. If there is a large percentage of the population who consider the war unjust, they may work to end the war through a number of means. Outright betrayal is exceedingly rare, but everything from reasoned political efforts to end a war to propaganda for the enemy are possible. On the other hand, defensive wars rarely face this problem. Indeed, a losing war can result in a grim, proud determination never to bow to a conqueror. Most populations end up somewhere in between these extremes, supporting the war effort however they can but regretting the grim necessity. Some societies, of course, have been very militaristic and glorified war as a way to prove a nation's or people's greatness. Despite all its horrors, wartime can evoke some of the best in humanity — honor, courage, sacrifice, and dignity in the face of ultimate

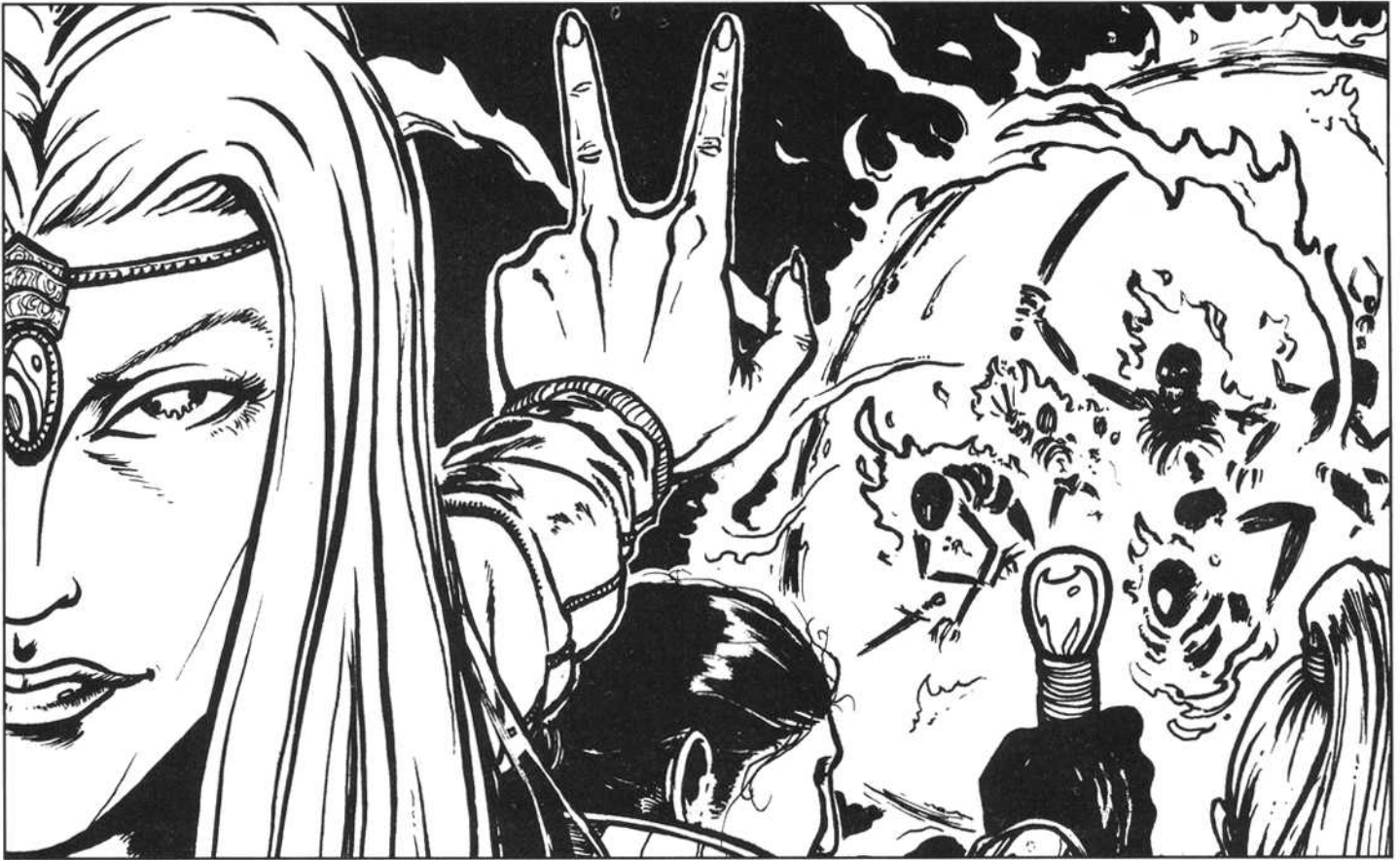

horror. For the most part, however, it is at best a necessary evil, and a slaughter in the name of hate at worst.

As products become scarce, profiteers make a (sometimes literal) killing. Bandits flourish on the losing (and even winning) side, as those who could oppose them are too busy fighting the war. Cowardice can devastate an army if even one soldier loses nerve at the wrong time. Battles can be terrifying, and while some may lose their fear in a frenzied red haze, others can understandably tremble at the roar of battle and the death all around them. Worse than cowards by far, however, are those who do betray their nation for gold. While it may not be true that every man has his price, many do. For some, that price is appallingly low; for others, the only reason the price is high is because they charge all the market can bear. And some people will do anything for the right amount of money. *Anything.*

All these are aspects of war that can be found on any world. When magic enters the equation, completely new fronts arise, with new weapons entering play that are otherwise possible only for much higher technologies, if not outright impossible. The most virulent diseases fade before priests, preventing otherwise unstoppable plagues. The most devastating wounds close, and clerics reattach or regrow lost limbs. Sieges and attacks on supply lines both become much more difficult when arcane powers circumvent space itself. Magic can save crops, or force them to grow again, should disaster strike. Even a successful assassination is no guarantee of the removal of a vital enemy leader — not when magic makes a temporary ailment of death. Such magic can result in a more *civilized* war and some very formalized rules, or completely alternate methods of conflict.

What magic gives, however, it can also take away. The most powerful healing magics are rare and

restricted to the mightiest of priests, but simple cantrips potentially deal out death. Missiles of pure energy, always striking true, make the ultimate sniper's tool. Enormous balls of flame and forks of lightning can wreak havoc on massed infantry. The elements themselves can turn on an army, while weapons and other supplies vanish with clever application of the right spells. When this sort of magic meets the battlefield for the first time, the devastation is likely to result in a sort of *spell shock*, with symptoms similar to the poor survivors of the First World War in our world. Battlefields can turn into charnel pits, and some wizards may stop attacking during a battle because their own massive success becomes sickening, as also happened during the Earth's Great War. Successful strategies take these spells into account, with different elemental effects sometimes determining targets. Wooden siege engines fall before gouts of flame, and ranks of knights in metal armor become literal lightning rods. War wizards almost certainly receive special status, possibly causing resentment among the foot soldiers — until the spells start flying.

Direct attack spells can completely change warfare, but in truth they are just the beginning. Mere death may not end the usefulness of a soldier — not with necromancy. For that matter, even enemy corpses may hold value for their potential as risen shock troops. (Banning these spells will certainly be part of any sort of international treaty on warfare on worlds with this sort of magic. Ruthless and/or desperate societies will, of course, not hesitate to break the ban.) Necromancy is also useful for intelligence. Even death is no protection from interrogation... not with magic.

Of course, necromancy is hardly the only magical method of gathering intelligence. Divination may be the single most effective magic in wartime — when it works. If competent scrying and precognition are available to both sides, the real war may be the magical effort to both deflect their diviners' efforts and penetrate their magical defenses. Much like modern warfare, a subtle duel between ACM (arcane countermeasures) and ACCM (arcane

counter-countermeasures) becomes a vital strategic component. Accurate knowledge of the enemy's plans, and even possible futures, becomes a linchpin of every war effort, as does preventing the enemy's ability to accurately gain such information.

These spells are only the beginning. Invisible saboteurs can devastate supplies and penetrate the most heavily-guarded outposts — unless countered with magic. Teleportation can drop soldiers into a castle as easily as it can transport food. Summoning spells can call forth terrifying forces into battle. Angelic warriors can *prove* the rightness of one side's cause while carving their way through the ranks of the enemy. Infernal monsters may not carry the same moral weight, but they are almost always more terrifying than their good-aligned counterparts. Beasts from the mortal plane make themselves useful in many different capacities. Creatures that can kill with a glance, or have elemental attacks make powerful, living strategic weapons. Monsters that evoke fear in an area around them, infect those they touch, or cast illusions, can devastate when dropped into the middle of the opposing force. Flying creatures of horse size or larger can create an aerial component to warfare, bringing glamour to the *knights of the sky* but adding a new terror to ground troops living in fear of descending boulders or fireballs. And then there are dragons...

Ironically, it's unlikely that any of these terrors of the battlefield will be the most frightening magical effect used in a war. For all the devastation invoked through spellcasting, what may well be the most disturbing effect is the power some wizards have over the mind. With certain spells, even free will becomes a casualty of war. Not only does interrogation become a formality, if the entire process is performed discreetly enough, a captured officer becomes a surpassingly effective agent. Of course, once the enemy discovers such tactics, their own mages will check for spells of this type routinely. The problem is that, unlike many other effects, magical loyalty checks are both bad for morale and difficult to maintain. On the other hand, successful-

ly capturing or enchanting a major enemy leader without discovery is no mean feat, and failure almost certainly puts the enemy on its guard. This is another risky, ethically questionable magic that most *civilized* nations likely outlaw, and then use in desperation when the need arises regardless.

Overall, war in all its forms hardens warriors spirits. They may become braver and more resilient, but they will also have seen horrors that most others can barely comprehend. Even the most primitive war is ugly and brutal, and advances in the capacity to wage war only make it more horrific, especially for the front line soldiers. Those not reduced to shattered remnants of their former selves are likely to become colder and more withdrawn, simply in self-defense. Of course, some can put war behind them when it ends, but others may not. During the war itself, this cold reserve allows them to do the things that war requires soldiers to do... and sometimes more, as well.

As the war drags on, sometimes a stalemate grinds both nations away. In most cases, however, the balance begins to shift in favor of one side over the other. This can happen in a matter of days, or it may take years. Regardless, the battlefield eventually moves into more populated areas, and progressively greater areas of the losing nation suffer from the advancing army. No longer does the army alone see the ravages of war, but the citizens as well. Sometimes, after a long advance, the tide of war turns and both sides of the conflict see their villages burned and people conquered or slain. Either way, as one side begins to suffer the effects of a losing battle, it becomes more desperate and fearful of what the victorious force will do afterwards. A losing army may use tactics that range from the questionable, including conscription of children and the elderly, to the abominable, such as the use of proscribed weapons and magic, to wild experimentation in the hopes of developing some weapon or spell that will turn the tide. The home front changes little for the side that is winning, save for hopes of loved ones finally returning home. On the losing side, however, civilians react — they

may become grimly determined to survive, or swear to die defending their land however they can. They might flee in terror of the advancing army, or begin to study the language and laws of those who will soon be their masters. Even those who go on with their everyday lives do so very deliberately, trying desperately to cling to their lives as they are, in the hopes they'll be able to do so when the war ends.

AFTERMATH

Fortunately, bad things end as inevitably as good ones, perhaps even *more so*. Eventually, a victor emerges, or in a stalemate forces both sides withdraw. Thus, the peace process begins.

This process bears enormous differences in the two different conditions. In a stalemate, life can return to normal with surprising speed. Essentially, the two sides get together, admit that the war isn't going anywhere, and put things back the way they were (as close as possible) while getting out of the situation as best as they can. While both sides to press their advantages, the prospect of continued, pointless war deters most serious power plays.

If one side or the other has won completely, or a losing party sues for peace, the situation changes drastically. How strong a position the victors have causes variations on the theme, but in general, the winners of a war dictate terms. If the losing side surrendered conditionally, they limit the victors' level of control, but overall, the fate of a defeated nation is in the hands of its conqueror. The most drastic result is the complete absorption of the conquered territory into the triumphant nation.

As noted above, total conquest can come at a high price, especially if the defeated people are proud to begin with. The process of returning to a normal life is most likely a long and slow one due to external changes in government and economy, with even local leadership positions filled by the victor. If one of the cultural differences is religious, a vanquished people may face conversion — at swordpoint, if necessary. Especially when the

gods themselves are involved, the priesthood of the defeated may find themselves literally powerless as their gods' divinity falls with them. On the other hand, if the gods remain aloof, rebellious clerics with divine powers constantly irritate the new regime and rally the other dissidents.

Cultural changes may arise, as well. The victor may enforce important customs on the defeated, depending on the importance of the customs and how magnanimous the conquerors feel. Reconstruction of devastated lands and cities goes more slowly than they could, as the victors put a higher priority on ensuring their control over the beaten nation than helping them regain their strength. In addition, the ravages that an overrun nation have faced leave it with fewer resources and reduced manpower, and it's most likely that even the victors have rebuilding to do.

In situations where the victors either don't have or don't want absolute control, the defeated nation may retain most of its political identity. Indeed, many successful nations have proven quite gener-

ous in victory. However, this doesn't mean that a beaten nation is left to its own devices after the war. Far from simply dismantling a defeated foe or leaving it in shambles, in most cases the vanquished find themselves under a number of restrictions — quite possibly severe ones. The victorious nation may demand reparations from a defeated nation, especially if the victors can justify them (truthfully or otherwise) by claiming naked aggression on the part of the vanquished. Even more likely restrictions are military ones. To ensure that a conquered nation remains quiet, laws may sharply restrict the weapons or spells allowed the nation, or the size of the armed forces, with the outlawing of necromancy and evocation in particular. Finally, there may be an interim period where the victors maintain control of the area with a temporary government. While this can be quite beneficial in some cases, with the most generous alliances helping to rebuild and restore a wounded society, in others there may be those who seek to profit from the misery of others. With a bit of favoritism and some mutual understandings back home, opportunists



may end up gaining positions in the temporary government. The corrupt may redirect valuable resources during this period, and violate them a second time to grow rich on the remaining plunder of a shattered nation.

Finally, victory is a relative thing. The term “Pyrrhic victory” comes from a battle that is won at a high cost. In some cases, the cost of defeating an enemy may be so great that the result may not differ much from a stalemate, or even a loss. Since the victorious armies can threaten the *losers* with so little, the winner may impose only token victory conditions, but ultimately there is just death and devastation. Ironically, victory may actually belong to those who lost the battles, especially if they were fighting a defensive war. Invaders who wipe out entire armies but aren’t left with enough to attack more than a few farmers can claim they’ve beaten their enemies, but the defending society may well remain all but untouched. In other instances, the destruction simply leaves both sides in ruins, and there is no victor. There is no peace process, no treaty hammered out by diplomats, leaving battlefields empty from sheer attrition rather than any real end to hostilities. Whatever else happens, both sides may well resent each other... and at the first excuse, the cycle begins again.

INTO THE ABYSS

Wartime changes everything. Even when a nation sends troops to a far-off land, the homefront feels their absence. If the war is between two forces that are remotely equal, spies and saboteurs make their presence felt as well. When the armies mass along the border and the drumming begins, nothing remains the same.

The first thing that changes society when war begins is tension. “How is our side doing?” “Where are the front lines?” “What will *they* do?” Unless they know their side is doing extremely well, the civilians at home become edgy and cautious. This can cause economies to slow down and hoarding to increase. Leaders likely order rationing, espe-

cially of resources vital to the war effort. These change with the level of technology and/or magic, but rationed goods almost always include food and metal. On the other hand, a war can actually *help* an economy initially, especially one in very dire straits or one that is recovering. As the government pays for increased production on a number of fronts, money flows into the system, allowing workers to purchase other goods, and so forth.

As rationing increases, black markets arise. If there are already organizations in place that specialize in illegal activity, they most likely take control of such ventures (if they were not the initial source). Ironically, some criminal organizations can be quite patriotic under the right circumstances, and may break some laws while quietly supporting the war. Nevertheless, in harsh situations these black markets flourish, though if people support the armed forces strongly, contraband is rare. The markets have to remain very discreet in the latter case.

As the war goes on, chances are the economy worsens. Embargoes, blockades, sieges, and other sanctions are ancient methods for bringing enemies to their knees. If a nation is not wholly self-sufficient, then imported goods vanish. A large, powerful nation with an abundance of many varied resources barely notices such efforts, while those countries which depend on trade for useful or even essential items may find their very existence at risk. Blockade runners become essential for survival, and successful ones are heroes to those in need. Even merely limited resources have value in such instances, as long as the essentials retain top priority.

Meanwhile, foreigners meet increasing suspicion, especially those from the rival nation. Racism is a useful propaganda tool, but the price for invoking such an inherently dangerous policy can be heavy. Worse, few people need prodding to hate those who are different. Such conditions exaggerate when the actual species are different; orcs are ugly, brutish and mean to the human eye, while humans look upon orcs as weak and cowardly. May the gods help any half-orcs on either side of such a conflict.

On the other hand, other minorities or second-class citizens may find themselves with a wealth of opportunities normally denied them. As conscripts come from the dominant culture, someone must replace the vacated positions. People usually barred from certain positions due to prejudice or misconceptions may find those restrictions lifted. They may also find themselves far more suited to those tasks than they were ever given credit for, and praised appropriately for a job well done. This can be quite intoxicating, and such second-class citizens may well throw themselves into their tasks with uncommon zeal. A nation willing to lift these barriers may find production increasing, or positions requiring skill and intelligence being performed with greater efficiency.

Problems can (and almost certainly do) arise when the war ends, however, if everyone expects to go back to their *rightful places*. Chances are that the minorities in question are reluctant to lose their hard-earned positions, while returning soldiers understandably want their jobs back. The resulting tensions can last for generations, and the society may never be the same. Nothing destroys myths of inferiority faster than empirical evidence to the contrary.

During wartime, however, these potential conflicts disappear. If a people view the war as just or the right thing to do, little more can bring them together. Patriotism is rarely as strong as when a nation is fighting for its life. While this can sour on occasion, with those not showing the *proper* loyalty potentially suffering for their lack of enthusiasm, there is a definite unity. Indeed, a new nation may arise through war, as disparate people develop a common identity, forged by the need to stand together against a powerful enemy.

Religion, too, can be a patriotic act, since becoming a priest provides a direct, tangible benefit to the war effort. In addition, few warriors turn down a blessing when it provides an undeniable benefit in battle. The immediacy and utility of even the minor miracles of divine magic make temples and other holy places even more attractive. Even simple devo-

tion and prayer become a service to the cause, if such activity means keeping the gods happy. While gods of war and healing become more prominent, any deity that might help finds donations and sacrifices on the rise. This increased religious fervor may well extend to everyday life, and could easily remain after the war for some time to come.

Arcane magic, however, arouses both suspicion and care. Loyal wizards may find popularity, but enemy wizards can expect fear demonization as their only welcomes. Advanced societies probably issue warnings to the populace to watch out for any signs that herald the use of unusual or dangerous spells. If magical energy itself is stronger in some places than others, these areas become strategic points as well. These places are important goals in the overall conflict, and any such areas within a nation's borders become sources of a mix of pride and apprehension. Worse, if magical energy changes due to massive amounts of spellcasting, entirely new problems may arise with polluted or even depleted magic. As neither the PHB nor the DMG offer such possibilities, any DM interested in the idea must make up some of the effects of such abuse. However, here are a few basic ideas for starting points: In the case of depletion, spells may have reduced effects, perhaps affecting a smaller range, doing less damage, or not taking full effect. Alternately, a spellcaster may regain fewer spells daily in an area of weakened magic. Fouled magic is worse. Spells take on a sinister cast, doing strange and malevolent things. Healed wounds leave ugly or obscene scars, possibly even growing tiny limbs. Attack spells do a little extra damage at the cost of control. The simple act of casting a spell may cause pain (requiring a Concentration check) or even injury. Spells that affect thoughts may cause disturbances in the caster's own mind. Gods help any fool who creates undead or summons entities things in an area with tainted energies.

Magic isn't the only thing that can foul the land, of course. The environment itself can be a weapon, resource or hostage, and possibly even all at once.

Even more vital than food is a source of clean water — even magic, which can generate pure water with great ease, can only provide so much at once. Rivers and lakes fall to both deliberate attack and the simple, gruesome side-effects of war. Bodies can taint water for years. For that matter, battles themselves can wreak havoc on local ecologies, with entire fields trampled, local woods razed for resources, and any edible animals hunted ruthlessly to preserve iron rations for as long as possible. Worse, fire can spread for miles before the fire dies naturally. Ash *snow* may fall for days after a particularly vicious battle involving fire-using wizards and dragons, a black abyss that reeks of pain and torment, where the screams of the damned echo across a barren plain. Still other religions claim that the afterlife is simply a resting-place where the souls of the dead meditate on past existences before seeking rebirth within a new form.

Such devastation isn't always accidental, either. Scorched earth policies are an old concept, though rarely used because of the terrible consequences. Both attackers and defenders can use this technique effectively; invaders burn fields and destroy towns to deny those resources to any who might return in their wake, while desperate local forces may do the same to prevent successful conquerors from using stolen territory. While a powerful weapon, the repercussions can last for months or millenia, depending on the methods used (the salting of Carthage by Rome has rendered the land barren even today). In the meantime, starvation and refugees become serious problems. Destroying an entire meadow or forest has vast, wide-ranging repercussions. Weather patterns can change, potentially causing droughts or floods. Wild game flees. Predators prey on livestock, and possibly the occasional humanoid. Again, magic makes matters worse, as necromancy turns fields into haunted wastelands, or magical acid burns away the soil itself. Curses can blight both crops and livestock for many seasons, with two-headed calves and stunted gray stalks making for post-war hardship. Monsters in the war, whether conscripted or independent, are likely leave without a fight. Positive and negative energies

can have sustained effects on a region, and powerful magic can warp even space and time.

Despite these unpleasant effects, war can advance technology. The war demands the creation of new devices, both magical and mundane, and anything from more efficient sword production to building a better golem may result from the desperation inherent in such conflicts. Experiments in alchemy, enchantment, and metalwork can all be expected in advanced societies.

Of course, in a fantasy world, experimentation need not end with the tangible. Spellcraft can flourish in such an environment, as mages conceive new and more useful spells. Turning the theory into practice is another matter entirely, which leads to the actual experimentation. To refine the spell, the crafter consults spirits, divines mystical secrets, and gathers portents. When his tower finishes its accidental tour of the planes, the wizard might dismiss the spell, or find favor with his mistake.

Magical experimentation exacts a heavy toll, however, even without considering the devastation of war itself. Even ordinary scientific exploration is hazardous, and tampering with magic leads to as many disasters as miracles. The comparatively massive explosion of technology owes its foundation to the wars fought since man first slew his neighbor.

Another aspect of war, particularly when societies must interact, is intercultural exchange. When two very different peoples, previously separated by spatial, cultural or religious boundaries, join together in combat, both sides introduced each other to many new concepts — humans first gained mithral after a war with dwarves, who themselves discovered wool during the conflict. Such cross-pollination also occurs among allies, with humans learning new magic from the elves during a war against orcs. New sciences, materials, languages, beliefs, spells, foods, and more spread across the known world as a result of these conflicts.

Most societies prefer more peaceful methods of such exchange, however. Brutal wars leave little civilization left for such study, and even the most fragile

pretexts can destroy centuries of learning in a matter of hours. Hatred and fear are powerful forces, and with national pride, racial superiority, or even the will of the gods, great civilizations can die, birthing new dark ages. Entire systems of magic and science can fall in such conflicts, condemning enlightened times to death.

FOR WANT OF A NAIL

Even the most primitive army needs at least a few supplies. As war grows more complex, the need for logistical organization increases dramatically. By the time a world reaches the level of typical high-fantasy societies, the process of waging a war is even more complex than the actual combat involved. With thousands of soldiers to coordinate, sometimes on several battle grounds, keeping them all fed, armed, and healthy is a daunting task. Add the needs of moving them in a coordinated fashion across fronts that may stretch for hundreds of miles, supplying special units such as cavalry and artillery, and gathering intelligence while denying the enemy information, the sheer enormity of the task becomes clear. Despite the difficulties, however, many well-coordinated armies arose throughout history. Many would-be leaders find logistics daunting, but each individual element tends toward the simple. The only serious difficulty is coordination.

The most immediate concerns for any large group of people are food and water. While magic can mitigate this problem, no known spells can eliminate it entirely. There are two primary means of feeding an army. One is living off the land, which is impractical for larger or rapidly-moving forces. While this may happen in especially bountiful regions, the food stores still run low during winter and incur the hatred of the locals. The other, far more common solution is the supply line. Transporting iron rations to the front lines allows a country to supply any armed force with relative ease. Cutting off an army or navy from its food is a good way to gain an enormous advantage, of course. This means that the lines remain intact, either through stealth (an

extremely difficult undertaking, even with magic) or by assigning valuable soldiers to their defense. Another problem is spoilage. Even the most resilient foodstuffs don't last forever, especially if vermin take hold. The final major problem is the matter of the transportation itself. Wagons break down, horses tire, and barges run aground. An army can only advance as quickly as its slowest elements, and for most armies those elements are the supply wagons. Despite all these problems, however, most armies prefer the supply line.

Unless the soldiers are all magical creatures, then the most important equipment they have are their arms and armor. Infantry need swords, shields and polearms. Cavalry need lances, and chain mail at the very least for both riders and horses. Archers need bows and large volumes of arrows. Wizards and sorcerers need materials for their attack spells, and combat engineers need all manner of equipment to do their jobs. All this equipment takes time and money to build, which is part of the reason that true surprise attacks are so rare. It is also a powerful argument for the standing army — in emergencies, having to provide not only equipment but the soldiers themselves on short notice can be a serious liability.

While time is not the factor with weapons that it is with food, nor are most weapons used up as quickly, they are not a self-renewing resource. Swords break, armor dents, bowstrings snap and wood splinters — and not just to the actual combat. Accident, inexperience and bad weather can all contribute to wear and tear on weaponry. Not only must a leader see to his army's equipment, but also to its maintenance. This adds to the supplies needed, including anvils, forges, woodworking and leatherworking tools, and the raw materials for all of the endeavors involved. Naturally, this means having the people who know how to do this work. Many soldiers either already have some of these skills or learn them quickly. Despite the dedicated smiths among the support staff, the more soldiers can take care of for themselves, the fewer noncombatants are needed alongside the warriors.

Armies need shelter as well as other basics, and while bedrolls beneath the open sky may suffice, no one refuses better living conditions. Tents are bulky, primarily because of the framework involved. Clever use of ropes can mitigate this, but then there are stakes and hammers needed. Setting up and breaking down camp can be a trial in itself, leaving armies vulnerable during the pack. Officers may have superior tents befitting their positions, which will only add to the bulk and the work.

SUPPLY LINES

Strategies which rest upon spells must also ensure an ample supply of components, and if both armies demand such, the battles over the components themselves may be among the bloodiest in the war. Some generals prefer divine spellcasters for precisely this reason, as almost all holy symbols require only relatively cheap, common materials.

Finally, armies must have all the other minutiae of battle: torches, bandages and medical herbs, clothing, tack for steeds, etc. Some of this equipment is vital, while other parts are merely convenient, but every trapping contributes.

Naturally, carrying all of this involves more than simple supply lines, a reason that sea travel is so effective a method of delivering troops. A good-sized vessel can carry both the soldiers and everything they need... until the ship weighs anchor. The soldiers carry a goodly portion of the equipment, but the bulk of the weight belongs to pack animals. Some wagons may serve double duty, carrying expendable supplies until empty, then returning to depots to pick up rations. Others have a set purpose, such as blacksmithing wagons and carts carrying siege engines. Such transports make fine targets for sabotage.

Mounts also provide a vital component of most armies, particularly fantasy armies. Horses, donkeys, and mules fuel the engine that keeps armies of any real size and power moving. Horses require food and groomsman as well. A good warhorse is going to need its own armor, which in turn is going to need someone to take care of that.

One of the most common complaints among the average foot soldiers of this time is that horses are better cared for than they are, which is understandable. Fantasy worlds, however, rarely limit the choices of steeds to mere horses. Dire wolves, giant eagles, even griffins and dragons serve as vital parts of some war efforts... for a price. No dragon tolerates a lowly stable and groomsman, and even unintelligent exotic mounts require special care. While many of these creatures are stronger, smarter, and tougher than a horse, they typically expect commensurately greater pampering, beginning with better and more food. Aerial steeds allow for entirely new tactics, but also provide new challenges. If the flying cavalry cannot walk (as with giant eagles, for example), they either announce the army's impending arrival or take refuge in horse-drawn cages — a dicey proposition, given that some flying mounts feast on horses. On the other hand, contact with the government and central command becomes much easier, as most flying steeds are faster than horses and ignore most land barriers. Air-borne cavalry also makes for excellent, if expensive, communication.

Communication of any sort is vital to the process of running an army and fighting a war. Magic truly shines in this regard, as most of the spells involved are low-level and cheap. Magic, however, is hardly the only method, or even the most common one, for remaining in touch. Carrier pigeons are a simple, useful method for sending short messages, and usually self-renewing (barring a good archer, of course). Actual couriers are more reliable and capable of defending themselves, and can deliver larger messages. On the other hand, unless they have magical or aerial steeds, the communication take more time, and couriers must fear ambush. Signal fires can communicate, but rely on unbroken codes, as the enemy can clearly see the fires. In addition, the greater the distance between fires, the larger (or higher) the signal fire must be if it's to work. This means using up a lot of fuel, as well as presenting other hazards.

A secondary series of *supplies* follows most armies, as contraband. The punishments for contraband generally vary with the nature of the goods. Gambling and mild alcohol warrant little more than confiscation and extra duties, while even the most forgiving of officers may execute men for proscribed arms or magic. Soldiers under neutral or evil leaders may expect harsh punishments for milder crimes (though bribery sometimes curbs this), but some of the good-aligned officers quietly allow mild vices for morale's sake.

In rare instances, magic is not merely a tool for war, but the only method of fighting it. Magic is almost certainly the primary factor in a war between air-breathing and water-breathing races. If only one side can attack, the other has almost certainly lost already. Even more rare (and more frightening) is inter-planar conflict, which typically relies on extraordinarily powerful individuals, or the whims of the gods. In such a scenario, few can hope for anything but a protracted, bloody war as normal tactics no longer apply. Fortunately, however, such wars are all but nonexistent.

ARMY ESSENTIALS

- **Food and Water:** Absolutely necessary. Requires constant supervision for defenders, and transport or scrounging for attackers. Vulnerable to enemy attack and natural attrition.
- **Weapons:** Absolutely necessary. Requires massive initial expenditure of money and resources for large armies, and regular upkeep to maintain combat readiness.
- **Transportation:** Indispensable. Necessary to maintain supplies at acceptable levels. Requires a large initial outlay and considerable upkeep. Numerous peripheral supply requirements. Vulnerable to enemy attack; highly favored secondary target. Pulls troops from front-line duty for defense.
- **Communication:** Virtually indispensable. Vital to coordinating the war effort. Enemies may take some methods, either through attack or interception. Favored target in protracted campaigns.
- **Shelter:** Highly useful. Helps maintain morale and shields both soldiers and supplies from the elements. Adds to transportation necessities for non-stationed armies.
- **Siege engines:** Usefulness varies. Absolutely essential against fortified positions, valuable otherwise. Large and bulky, siege engines will usually slow travel time. Extremely expensive to build and to maintain.
- **Other goods:** Varies. Few generals allow for anything other than essentials, unless it dramatically helps morale.

NAVY ESSENTIALS

- **Food and Water:** As above, and easier to transport in bulk on board, but takes up valuable space. When sailing in seas, the crew must also have room for fresh water. The open seas are not kind to fresh water and food, and vermin quickly infest both. Of course, magic may significantly diminish the need for fresh water.
- **Weapons:** As above. Before gunpowder, however, most naval weapons consist of ballistae and catapults, with flaming ammunition preferred. These are even more expensive than the land-based variations, as engineers typically build these into the ships.
- **Communication:** As above, but without magic, compasses, or highly accurate maps, ships have little to no chance to hold their positions in foreign seas.
- **Other goods:** As above, but captains must keep repair goods (typically rope, tar, and cloth) on board ship, lest the ship sink or drift far off course.

EXOTIC GOODS

- **Air Cavalry:** Specialty tack and barding. Unusual and expensive foodstuffs. Intelligent species normally make other, exorbitant demands.
- **Arcane Support:** Material components and spell foci. Bodyguards. Mishaps in spellcasting may result in collateral damages. Staff typically demands or requires magical items as part of their commission.
- **Clerical Auxiliary:** Various holy artifacts and supplies. Divine will may demand certain expenditures, from sacrifices to altar transportation. Material components useful, necessary for some powerful effects.
- **Outsider Divisions:** Many normal supplies replaced with exotic or unnatural requirements (devils may require contracts, for instance, or intelligent earth elementals may require rare gems).

DIVISIONS

With each successive war, victorious armies have pioneered refinements to both strategies and tactics, the most exceptional of which is the specialized unit. By limiting training in a unit, the unit's skill improves more rapidly, and allows for essentially modular armies, with certain types of units being the only requirement.

INFANTRY

The backbone of every human army in history is the infantry. The grunts get little of the glory, many officers (particularly nobles and cavalry officers) consider them expendable, and the infantry's provisions are the least of the army's, but they win the wars. Infantry forces are almost always the largest part of the army, as they are the easiest and cheapest to supply, require the least training, and need the least support. Ultimately, all other unit types revolve around the infantry divisions, either in how

they can aid the infantry, or by how the infantry will protect them.

The infantry does the drudge work of an army. They fight on the front lines and suffer (and inflict) the largest portion of casualties. Experienced infantrymen are typically the de facto leaders of their units, having survived war's worst. Even the most foolhardy mounted lord would think twice about charging battle-hardened infantry units, and some nobles have no qualms about rewarding fearless and skilled service with land and title.

Light infantry composes the largest percentage of footman, and are often divided into two ranks. The first rank has shields and a one-handed weapon (a short sword or handaxe), and padded or leather armor. The second rank, placed almost immediately behind the first, wields standard issue polearms, especially pikes. They also have light armor, possibly of a slightly higher grade. This is the main line of any military force using light infantry, with the shieldmen defending the pikemen. Less advanced armies lack the second rank of polearms, though particularly sturdy shield walls may allow archers to replace the pikemen. Despite their shoddy goods, however, the infantry training and experiences make the light infantry units some of the most skilled and frightening warriors in the battle.

Heavy infantry actually plays a rather odd role in fantasy warfare, being a midpoint between the mounted knight and the standard foot soldier. Distinguished by their superior equipment, especially regarding armor (chain or scale), heavy infantry have a greater variety of weaponry, as well. Though the sword and shield are the standard among these units, even here the tools differ from their light counterparts — normally a large sword and a small shield. More experienced units may prefer two-handed weapons, or two weapon styles of combat; generals typically deploy these elite units only in emergencies, fearing their loss.

The major drawback of heavy infantry is that they are the slowest units in the battle. While the similarly equipped knights have horses, the lack of large shields and movement renders the heavy

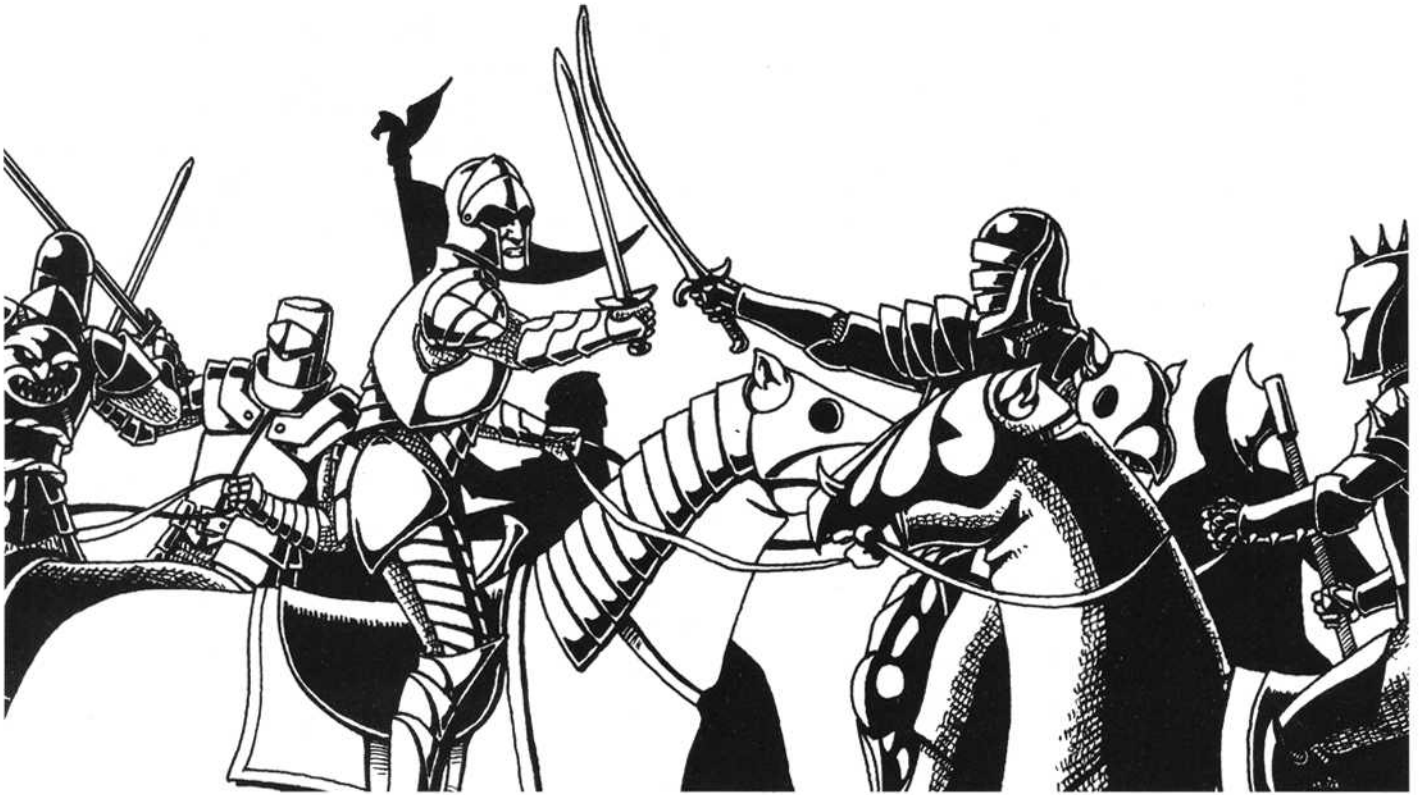

infantry extraordinarily vulnerable to massed archery attacks. If they can press an advantage won by the light infantry, however, by pouring through an opening in the line or flanking the main force of the enemy, the heavy infantry can devastate the enemy forces, even against cavalry. Between their armor and powerful weaponry, heavy infantry units inflict massive damage even on opponents with superior numbers. If they can close, there are few forces that can match them without an enormous numerical advantage.

CAVALRY

The infantry commonly complain that they do all the work and the cavalry gets all the glory. The complaint is understandable, but patently untrue. While cavalry units hold more glamor and favor, the enemy also targets them first. Even without orders to destroy the cavalry, enemy forces engage mounted units to gain reputaiton and reward.

Light cavalry units are, barring powerful magic or uneven or marsh-like terrain, the fastest forces on

the battlefield. Able to strike and run almost at will, they can harry any other unit type to great effect. On large, flat fields they can flank entire armies, with only other light cavalry as effective opposition. Light cavalry wears leather or hide armors (if any), and field javelins and spears. Truly adept cavalries can even wield short bows on horseback, though this is a sign of either phenomenal training or an entire culture based around riding skills. Most light cavalry soldiers also have longswords for close combat, or for when an enemy dismounts them. Unless the culture of the army exalts riding, light cavalry are primarily harrier units, using hit-and-run tactics to wear down enemy forces.

Perhaps more than any other conventional force, spellcasting suits light cavalry most. The quick tactics and the reduced need for armor allows arcane magic use in tactical situations, whereas in most other cases wizards remain in reserve for strategic magical strikes. The arcane spellcaster, of course, must have some riding skill to be effective in this endeavor.

These traits are all true many times over for light air cavalry, in which riders of airborne creatures can strike with greater impunity. Such mounts allow for entirely new tactics, and make spellcasting riders even more attractive. A single great eagle rider can perform the equivalent of a massed volley, dropping an entire mass of spikes on infantry units. Flanking takes on an entirely new meaning, as air cavalries swoop down behind enemy lines to wreak havoc on encampments. Archers snipe in nearly any terrain, as officers are no longer able to remain safely behind the lines. Air scouts disperse some of the fog of battle, capable of swooping up, getting an overview of the positions, and reporting back to the commanders. Duels between these daredevils should be vital components of any fantasy war.

Heavy cavalry takes all the advantages of the most advanced armor and adds to them a devastating further benefit — mobility. Considered for centuries both the most glorious and most effective forces, knights on horse were indeed all but invincible for a time. Massed arrow volleys and *hedgehog* tactics such as the shield wall/pike formation eventually ended the myths of invincibility, but it took an entirely new type of warfare to end the domination of the armored cavalry on the battlefield. Heavy cavalry units are traditionally known for having the most advanced armor available and for massive charging weapons, such as the lance. They also wore shields for added defense of their off-hand side, and typically carried large swords or other long, one-handed weapons for foot combat. Their horses were sometimes armored as heavily as the knights riding them, but in most cases the weight was too much, and lighter barding became more standard.

Ironically, for all the glory attached to heavy cavalry, their tactics vary little: heavy cavalry units do one thing — charge *en masse*. For all that, this one tactic is devastatingly effective against foes unable to evade the charge, except against other heavy cavalry or massed polearm defenses. Heavy cavalry units can rout nearly any lighter force, sweeping through them like a living scythe. Lances,

great swords and flails gain enormous power when backed by the combined mass of horse and rider at full gallop. These living engines of death drew enormous fire, however, and woe betide an unhorsed knight in a sea of infantry. Fortunately for some, fellow nobles were usually much more gracious in victory, and the knight would spend captivity in relative luxury until ransomed back. In addition to the major vulnerability of the armor's weight (often enough to keep a knight from standing on his own), arrow volleys and offensive spells pose a dangerous threat. Until the knight's horse is in full charge, archers and spellcasters have all the time they need to take aim.

Much rarer than its lighter counterpart, heavy air cavalry poses greater problems. Heavy armor typically robs weaker mounts of flight, so only the mightiest of flying creatures can serve as heavy cavalry — dragons being the leading exception. For more information on these lords of the sky, see *AEG's Dragons*.™

ARCHERS

In warfare, the bow is primarily a strategic weapon. Close ranks of archers stand together and operate almost as one, firing repeatedly until they have no more arrows, the enemy routs, or the battle comes to them. They usually have some light weapons with which to defend themselves, but bear light armor at best. Burning arrows, a popular variation, require greater coordination lest the fires burn out early. Archers typically have slightly better living conditions than infantry, but not nearly as good as cavalry units.

SPECIAL UNITS

While infantry, cavalry and archers are the primary forces in an army, many other support units can play vital roles. The best known secondary unit type are combat engineers, responsible for the maintenance and application of the siege engines. These monstrous machines see combat but rarely outside the sieges, but standard battles threaten only the most specialized of such weapons.

Catapults and ballistae fire enormous ammunition at the enemy, throwing everything from boulders to gigantic bolts to burning cauldrons at them. Siege engines do not attract the attention that heavy cavalry does, simply because these units remain at the rear lines and have ridiculously slow rates of fire. Given the devastation such weapons inflict, however, an opposing army will be very happy to destroy one at the first practical opportunity. Engineers are by definition an educated class, requiring greater pay for their services. Many are officers, with proportional rates.

Wizards also form special units. Educated, lightly armed and armored, and wielding massive destructive power, arcane spellcasters either hide or remain behind the lines, where they can use their magic in relative safety. Of course, wizards can do more than simply throw magical lightning; some serve as advisors and countermagic experts. A powerful wizard can expect treatment equivalent to a high-ranking noble or officer, getting the best rations and having a number of servants available. They can also expect assassination or kidnapping from the enemy. No one ever said a wizard's life was easy.

OTHERS

Finally, there are those units that defy normal military categories. Truly special forces, small groups of sappers, scouts and snipers use stealth, wit and intensive training to do damage far beyond their numerical value. These squads specialize in destroying fortifications, capturing enemy leaders or artifacts, and uncovering vital secrets. Due to the training involved, such units are rare, expensive, and skilled... or recruited from parties of adventurers, looking for gold and a just cause.

21 GP A DAY... ONCE A MONTH

Once inducted into service, existence consists of marching, training, eating bland food, and waiting for battle, and even nobles fare only marginally bet-

ter. Quartermasters must also struggle to divide rations and supplies evenly and as the situation demands, a logistical nightmare when armies number in the thousands and communication is limited. For the average infantryman, standard-issue armor is too large or too small, and the grueling pace will either kill them or remake their bodies as new.

Strangely enough, some people thrive in this environment. Soldiers experience friendships that they never knew before or will know again. This regimented lifestyle ill suits rebels or iconoclasts, but simpler folk may find themselves taking to it. Those unbroken by the terrors of the battlefield may gain an even greater zest for life. Those with a more serious bent can become leaders, and anyone with a penchant for organization will find themselves handling requisitioning and pay.

If there is a strong feeling that the cause is just, even greater bonds form between the soldiers. While the rivalries between unit types remain, the feeling that they are defending their homes and families forges them together. Only the most crushing defeats can break such armies. On the other hand, desertions plague any army, especially recruits of undisciplined brigands or reluctant conscripts.

CAMP FOLLOWERS

Whenever large groups of people migrate, others follow to take advantage. This isn't necessarily a bad thing for an army. Peddlers and merchants may well be a boon to an army long on troops but short on supplies. Entertainers can boost morale. Soldiers without a permanent home to take care of may even bring their spouses with them, making the nights less lonely and probably providing the army with another pair of skilled hands. For the most part, however, camp followers are nuisances at best and liabilities at worst. Beggars, professional companions, con artists, and all manner of human vermin can make officers wistful for garden-variety rats. These hangers-on can bleed an army's strength bit by bit, while ingratiating themselves to the naive.

FORMATIONS AND TACTICS

Though many would-be strategists find the stacks of treatises on the subject intimidating, the logic that drives the use of formations and battlefield tactics is quite simple: to emphasize strengths while hiding weakness. Soldiers of all races and all ranks tend towards practicality, using practiced methods and trial and error to create new ones.

What follows is a rough sampling of the most common formations and tactics.

In a certain sense, troop types, formations and tactics are so closely linked that separation, in strategic terms, is impossible. A soldier's skills and weaknesses suggest which formations and units best suit him, and expanding this understanding to the whole army is the basic foundation of strategy. As a character's class often suits his basic abilities, so too do types of soldiers have their different strengths and weaknesses. As a strategist understands this, he can better deploy his troops to maximize his chances of victory while minimizing his casualties.

CLOSE ORDER VS. OPEN ORDER

Whether considering archers in padded shirts, paladins on war-horses, or battle-crazed barbarians, all armies use formations and tactics that fall into one of two basic types: close order and open order.

True to their name, close-order formations involve soldiers formed up very close to each other — sometimes literally shoulder to shoulder — in geometric formations of evenly formed ranks and files. These tactics require soldiers to act in unison with each other, which means that the soldiers need training and discipline before battle. Close order formations operate on a very simple assumption: togetherness and coordination create strength, while isolation and lack of coordination lend to confusion. If ten disciplined soldiers acting as a single unit fight against ten soldiers acting independently of each other, the orderly unit almost always wins over the individuals. The disciplined unit can punch through the uncoordinated group like an

armored fist, scattering them and making it easier to pick them off singly. On defense, few chaotic groups can break the formation of ten soldiers fighting shoulder to shoulder as a team; these men close gaps in their ranks and protect each other with relative ease.

Due to this unity, close order formations tend to excel at what is known as shock combat: charging the enemy head-on before initiating melee. On the attack, the density of a close order formation concentrates its striking power, and sometimes looks so formidable that a wavering foe may break and run before the attackers even initiate hand-to-hand fighting. On defense, that density also makes it harder for a charge to break its ranks. In concrete terms, a large group (whether ten or one thousand) of paladins charging an orcish horde in perfect unison would likely cause the horde to flee.

The best way to break a close order formation is to strike from behind or the flank. Soldiers fighting in close order face the same direction at all times, with all of their weapons pointed the same way at any given moment. By definition, this side of the formation becomes its front. When an enemy strikes the unit from behind or the flank, the unit cannot retaliate effectively. This weakness, combined with a natural fear of being surrounded, causes even the most experienced and disciplined troops to panic and break if taken in the rear or flank.

By contrast, soldiers who use open order tactics place more faith in flexibility and mobility than in tightly knit formations and pure shock power. Instead of forming up in ranks and files, they come at their foe in swarms, in which they give little care to the arrangement of and spacing between individual soldiers. Open order troops usually don't fare well in shock combat against close order formations — a shock attack scatters them with ease, and their formation is too loose to generate much of an impact on the charge.

Instead, open order soldiers tend to strike and flee, even when fighting on the offensive. Instead of engaging in shock combat against an enemy formed

up in close order, the open order troops move to wear their foes down by harassment. Once the foe has suffered enough attrition, an otherwise weak shock could break the enemy unit, or simply surrender if surrounded.

Open order formations favor more flexibility than closed formations. When maneuvering on broken ground, for instance, close order formations lose their cohesion, and therefore their power. Open order formations, on the other hand, do not require their members to move in perfect synchronization to maintain their effectiveness in combat. They can also change the facing of their formation more quickly than close order formations, since they rely less on moving in unison and rigid obedience to commands. Flanking maneuvers are therefore less useful.

CLOSE ORDER FORMATIONS AND TACTICS

Phalanx

Phalanx is a generic term that covers just about any infantry formation composed of regular, close-set ranks that fights as a single block of soldiers. Properly speaking, a phalanx is a rectangular body of infantry, clad in medium or heavy armor and armed with longspears. On defense, the classic phalanx is very difficult to break unless attacked in the flank or rear. On the attack, phalanxes usually begin their advance at a walk, slowly building speed as they approach their target, preferring to close the final distance between them and the enemy at a full sprint.

Armies that make use of the classic phalanx usually achieve the most success when they have suitable forces of cavalry to cover their flanks.

Most heavy infantry formations are variations on the phalanx, as they all function on the same basic principle. One such variation is the shield wall, which consists of soldiers wearing medium or heavy armor (usually chainmail) and using tower shields to optimize their defensive strength. They fight shoulder to shoulder, so that their shields touch or overlap. As with all phalanx-like formations, it falls

quickly if assailed on the flanks or in the rear, but it can defend tight places where flanking maneuvers are difficult, like mountain passes or bridges.

A more sophisticated variation on the phalanx is known as the *hedgehog*, which consists of a square block of infantry in which the soldiers near the edges of the formation use longspears, while those closer to the middle use polearms to support the front ranks. The troops on the edges train to change facing quickly, so that they can meet any sudden attack to the flank or rear. A well-trained hedgehog unit presents a bristling wall of spear-points on all four sides of its formation at once, hence its name. Training, however, is the key, for functional hedgehogs require intensive drills.

Legion

The legion formation developed as a way of giving close order infantry the resiliency and tactical flexibility that phalanxes lack. When a phalanx gives way, it crumbles all at once. A legion, on the other hand, is really a coordinated group of three different lines of infantry, one deployed behind the other. Ideally, if one line gives way on the battlefield, the other two intact lines fall forward to save the day.

The first line consists of relatively lightly-armored troops, clad in nothing heavier than hide armor or a chain shirt, and armed with javelins, shortswords and shields. Their job is to open the fight by peppering the enemy with their missile weapons, then engage briefly in hand-to-hand combat. They then fall back toward the second line, who opens their ranks to let the first line through.

The second line consists of soldiers clad in heavier armor and carrying larger weapons such as chainmail and longswords. Once the first line has retreated, the second line closes ranks again and engages the enemy. In some legionary armies, the second line also carries javelins or spears that they throw before initiating hand to hand combat. In theory, the first line should have weakened the enemy somewhat, and the shock of having to fight fresh troops could discourage the foe enough to persuade them to turn tail and run.

If not, the second line withdraws while the third steps forward. The veterans of a legion generally take their places here. For the third-liners themselves, the back rank is a place of honor, as well as a chance to let the younger troops do the heavy lifting. They usually wear heavy armor and wield polearms or longswords — which are also useful for threatening cowards who cut and run from the first two lines.

Legions possess more tactical flexibility than phalanxes. When an enemy threatens their flank, a legion should simply slide out one of its lines and maneuver it to face the threat. In practice, however, such a maneuver takes time to execute, and legions are still vulnerable.

Shock Cavalry

Heavy cavalry covers a variety of troops who fight on horseback, whether clad in medium or heavy armor, wielding lances, swords or bashing weapons, using shields or not. They are paladins in shiny plate armor on shiny horses, and they are elite mercenaries serving anyone willing to pay their fees. No matter what type of armor or weapon they use or what their motivation for fighting, all heavy cavalry have but one reason for being on the battlefield: the shock charge. Their sole purpose is to smash through the enemy line, crushing anyone who stands in their way, and scattering the survivors beyond all hope of rallying and reforming. Their intended effect is psychological as well as physical; the sight and sound of well-armed soldiers thundering on large warhorses can unnerve, causing men to flee before the first impact. This is the classic cavalry charge, one of the most fearsome tactical maneuvers available to a military commander.

Heavy cavalry do have their soft spots, however. Like any close order formation, flank and rear strikes threaten them. Their mobility gives them some advantage over infantry, but should their horses tire (an inevitability after repeated charges), they are just as helpless as foot soldiers stuck in mud. Heavy cavalry massed to charge are also



vulnerable to missile fire, not only because of their closely-packed ranks, but because a soldier on horseback is a bigger target than a soldier on foot. Due to expenses, many heavy cavalry horses lack even the basic barding — making the horse's death or maiming a primary goal for enemy archers. A heavy cavalryman without his mount is just a man in armor, and if he escapes falling off of his horse without injury, he should count himself lucky.

Head-on shock charges work terribly against phalanx-like formations of disciplined and well-armed infantry. While the charges work well if the infantry behaves, not even a determined, full-out charge breaks a calm, centered infantry as the horses shy away from impaling themselves on a solid wall of spear or sword-points. In this case, the two sides hack and poke at each other in place, granting only a small advantage to the cavalry. Shock charges by heavy cavalry can devastate any type of formation when they strike in the flank or rear, and they can dissolve open order formations in an instant, but they fail utterly at striking disciplined infantry in close order.

Even when a shock charge does work and it scatters an enemy formation like grain in the wind, they can take themselves out of the battle as well. Cavalry are trained to exploit their successes and pursue a fleeing foe, running him to ground. In practice, this means riding down and killing or capturing as many of the enemy as possible. Cavalrymen like this part of the battle, because they get to fight the enemy when he is in no condition to fight back. It sometimes gives them access to the rear area of the opposing army as well, a prime spot for mayhem. At some point, however, pursuing cavalry has to reform and return to the field, or else they are useless for the rest of the battle. Figuring out when to break off a pursuit before it becomes counterproductive is a major test of discipline, and a general who loses his elite heavy cavalry to chasing down lightly-armed peasant militia has lost the exchange.

Archery Company

Organizing missile troops into close order formations allows a battlefield commander to concentrate and direct their fire with ease. Archers can also fight in open order as skirmishers (see below), but in that case they scatter their fire to harass and annoy the enemy rather than kill them directly.

Volley fire — shooting in unison and on command — proves quite effective against infantry or cavalry formed up in close order. The sight of a cloud of arrows or bolts (or even sling pellets) disconcerts even brave souls. In volley fire, missile troops do not bother to single out individual targets, as they do when skirmishing. Instead, their commander points them at a target and orders them to fire into it. At least some of those missiles will hit something, and even those that miss will put a proper, righteous fear into the enemy. If the target is a body of cavalry, it does not matter whether the arrows hit the horse or the rider; either way, the enemy's cavalry falls.

Whether fighting as skirmishers or in close order companies, archers tend to wear little armor and carry only light, secondary melee weapons like short swords or daggers. Considering the Dexterity penalties that come with wearing heavy armor, this makes sense, but this also makes them unsuited for melee combat. Archers therefore deploy with infantry protection. There are three standard methods for accomplishing this: placing them in front of the main battle line (the infantry behind either advance through their ranks to attack or open their ranks and allow the archers to withdraw through them if the enemy attacks), placing them in the line (with bodies of infantry on either side to protect them), or deploying the archers behind the infantry (as happened at Agincourt).

Cavalry enjoys charging the archers, who cannot defend themselves properly against an enemy already upon them. To protect against cavalry charges, archers sometimes protect their formations with large, wooden stakes, planting them in the ground with the pointed end directed outward.

Cavalry cannot penetrate these barriers without impaling themselves, thus allowing the archers to fire with virtual impunity. To add insult to injury, archers sneak out from behind their stakes in the wake of a failed charge by heavy cavalry, finishing off the wounded with their daggers.

Cataphract

The *cataphract* system is an ingenious attempt to give formations of armored, mounted warriors as much tactical flexibility as possible. It combines the mobility and shock effect of heavy cavalry with the defensive steadiness of heavy infantry and the missile fire of a company of archers.

Cataphracti soldiers wore medium armor such as chainmail or scale mail and carried a small arsenal of weapons: lances, longswords heavy maces, and missile weapons — usually composite bows or light crossbows. They also carried shields for use in melee.

The cataphract system was developed to maximize the military value of a relatively small core of professional soldiers, training each one to assume a variety of tactical roles, within the same battle if necessary. When a region faces invasion, it is a sound tactic to rush a force of cataphracti to the scene to stiffen the local garrisons and smash the invaders. In the case of the Vestillians it worked for the better part of two centuries, as a succession of skilled Vestillan generals used their small, highly-disciplined and heavily-armed armies to smash out-numbered foes. Other military societies since then have seen it fit to imitate their model.

OPEN ORDER FORMATIONS AND TACTICS

Rabble

Alas, not every soldier who takes the field is a trained and well-equipped professional. All too often, a society that goes to war fields troops that, because of their lack of training and equipment, have little military value, hoping against hope that they can do the job. Perhaps it is too poor, or lacks the technology to properly equip its soldiers. Perhaps it needs to scratch together an army in too much of a hurry to train and equip them. There are

also societies that believe that sheer weight of numbers rather than training and technology are the keys to success in war. Whatever the cause, here are some examples of when an army is not an army, merely a rabble:

Peasant Militia

Peasant militias usually organize to defend the area in which they live. True to their name, they fight with whatever weapons they have at hand (scythes, pitchforks, etc.), and they rarely have any useful armor. Employed properly, they garrison backwater areas (perhaps with a few professional soldiers to command them), providing military strategists with some peace of mind. Any general who takes peasant militiamen on campaign and expects them to do much more than guard the baggage, however, is probably asking for trouble. Peasant militias have fought bravely when defending their homes, but their morale breaks down under the rigors of campaigning, when their lack of experience and discipline show.

Hordes

When it comes to war, some societies put more stock in numbers than they do in training, discipline, and armament. When they go to war, they take whoever is willing to join the ranks, without much thought of organizing them into tactical units, teaching them how to maneuver on the battlefield or even giving them proper weapons. When they fight, they tend to come at their enemy in waves. If their morale is high and they are willing to suffer enormous casualties to defeat their foe, hordes can be effective. More often, however, disciplined soldiers will cut them to ribbons before they can make much of an impression.

Tribal Groups

When barbarian tribes war, their opponents generally find that valor is their long suit, but organization and discipline are their weak points. Barbarians fight on foot or horseback, wearing light or no armor, and wielding large weapons like bastard swords and greataxes. Their military

cultures regard physical strength and personal bravery over discipline, and so they fight in open order simply because they never bother to worry about formations and tactical coordination.

Barbarian tactics are quite simple as a general rule. They form up and charge the enemy, often screaming war cries that can curdle the blood of even the most hardened veteran. The impetus of such a rush can prove irresistible, especially if they attack in that state of berserk fury known as barbarian rage. Sometimes, this is enough to dissolve a professional army in panic. Barbarians cannot sustain their rages indefinitely, however, and the berserker rage leaves them weakened and fatigued. In this state, a good, sharp counterattack sends them flying, and their lack of discipline and organization places organizing a defense out of the question. Battles between barbarian hordes and professional armies therefore tend to be sharp, intensely violent, and short.

Filling an army with unprepared troops is cheap, but usually not cost-effective. They fight in open order not because they know how to gain tactical advantages by it, but because they lack the training

or discipline to do otherwise. When it comes down to hand-to-hand fighting, they crumble before well-armed professionals who understand how shock combat works. In fact, disciplined professionals beat poorly trained and under-equipped armies as much as ten times their size.

Skirmishers

Armies find it useful to keep on hand a number of lightly-armed and armored troops called skirmishers whose main job is to annoy the enemy during the opening stages of a pitched battle. Skirmishers fight with light missile weapons, like slings, javelins or shortbows, and they wear little if any armor so as to maximize their agility and mobility. They deploy in front of the army's main line of battle, often spread out in loose formation to make them less vulnerable to enemy missile fire. If the enemy chooses to open the battle by advancing, skirmishers harass them by firing or throwing their weapons at will, falling back and eventually taking refuge behind the main battle line as the enemy advance continues. They can also precede a friendly advance, harassing and softening up the enemy battle line for a good, solid shock attack.



In either case, skirmish troops rarely cause many casualties directly. They engage at long range and stay there, as their light weapons and lack of armor makes them ill-suited for melee combat. They also tend to be cowards, serving their purpose by disrupting enemy formations, wearing them down and creating little gaps that friendly troops can exploit when they come to handstrokes.

Once the battle is under way, skirmishers tend to flee to the reserves. They can, however, stay at hand to take a few shots at the enemy's flanks if the opportunity arises.

Light cavalry can also serve as skirmishers if equipped with light missile weapons usable from the saddle, like javelins. Mounted skirmishers can fight a little closer to enemy formations than foot skirmishers, since their speed allows them to get away and avoid melee a lot more easily. Light cavalry operating in an open, skirmish formation are also useful for scouting ahead of the main army, as well as screening the army's movements by harassing enemy scouts.

Light Cavalry Swarm

Not every cavalryman puts his stock in heavy armor, heavy weapons and the shock power of a stirrup-to-stirrup charge. Many military societies prefer mobility and flexibility in their use of cavalry. These light cavalry warriors wear only light armor (sometimes none at all) and fight with nothing heavier than rapiers or longswords. Sometimes, they throw javelins or shoot bows from the saddle, although the latter activity requires considerable skill and practice.

Armies that rely on light cavalry cannot and do not expect to fight a close order army in melee. They fight in loose order to maximize their unit speed, and a direct shock attack by a close order foe scatters them without much problem. Instead, light cavalry armies try to use their mobility to stay out of a close order army's attack range, and strike at times and points of their choosing.

Elves make efficient and formidable light cavalrymen, but light cavalry swarm tactics are most com-

monly used by nomadic tribes who hunt or herd for a living. Such people practically live in the saddle, learning riding skills at a very early age. They also use tactics in war learned from hunting and herding. They understand the value of wearing an opponent down, just as with a hunted beast. They know how to use their superior riding skills to control the movements of a group of creatures, and how to pick off stragglers when the opportunity arises. In essence, they treat their enemy as prey.

Light cavalry swarms can destroy enemy armies quite effectively, but capturing and holding territory often proves to be another matter altogether. Their most glaring weakness is engineering, since nomadic peoples tend to lack the technology to construct fortifications and lay sieges. They can crush a defending army and lay waste to the countryside, but a walled city or well-built fortress flusters them. The more successful light cavalry armies have therefore relied on outsiders to serve them as military engineers, either hiring them as mercenaries or impressing them as slaves.

Guerilla Warfare

Perhaps the ultimate open order soldiers are those irregulars who conduct what is known as guerilla, or partisan warfare. Guerilla-style fighters use stealth, cunning and daring to make up for what they usually lack in discipline, equipment and numbers. They like to strike from ambush, using cover of terrain and the element of surprise as a formidable weapon. If possible, they isolate part of their enemy's main force to even the numerical odds a bit, defeat or even destroy it, and then withdraw beyond range of pursuit, content with wounding their foe. Like skirmishers and light cavalry warriors, they prefer to hit and run rather than stand and fight. Very often, they use camouflage or their natural skills at concealment to disappear into the surrounding terrain. Their overall strategic goal is to wear down and frustrate their enemy so that he no longer regards it as worthwhile to fight them.

In fact, guerilla warfare is almost always waged on the strategic defensive, to wear down an invader

to strong to defeat in battle. At the strategic level, guerillas need to know the lay of the land better than their foe, to understand where to lay traps and set up ambushes. They can also benefit from working with a friendly civilian population, hiding amongst them and drawing supplies from them.

Guerilla fighters may be professional soldiers drilled to fight in close order who find themselves in situations where it makes sense for them fight as irregulars. Perhaps the enemy outnumbers them so strongly they take to the hills rather than risk open combat. Perhaps they operate in terrain, like a thick forest or a boulder-strewn mountainside, where no one can maintain close-order formations.

Just as often, however, guerilla fighters are people or creatures native to a place, using the terrain to their advantage — they know it intimately and their enemy does not. Fey in woods and marshes, elves in forests, certain species of giants in hills and mountains all draw strength from their intuitive relationship with native surroundings, and this allows them to out-think, outmaneuver, and out-fight enemies who dare to invade their home ground. Their bond with that particular environment allows them to employ guerilla tactics very effectively against foreigners. The same can be said of certain human tribal groups whose lives are intimately tied to certain environments, like the hunter-gatherer tribes who live exclusively in jungles and rain forests.

LOGISTICS

Logistics is the fine art of keeping an army fed, clothed, supplied and in fighting trim. The least exciting aspect of warfare, this drudgery is also absolutely crucial to military success. An army that neglects logistics could very well disintegrate from starvation and straggling without its enemy even firing an arrow. The officer who oversees these matters for an army on the march is the quartermaster, and a good quartermaster can engineer an army's success just as much as any battlefield leader, while an indifferent one can doom it.

THE MOST IMPORTANT ASPECT OF STRATEGY

When planning or analyzing a military campaign, generals and scholars alike tend to look at troop movements, large-scale maneuvers intended to set the enemy back, or strategies which proved in retrospect to be mistakes. Less glamorous are the other questions. How much food will troops need? How many carts and draft animals need to carry it, and how much food do these animals need? How many spare weapons? How many spare mounts for the cavalry? How many spare arrows will the archers need? How much money should the army set aside to pay the troops, especially the mercenaries? These are dull questions, but if no one answers them, the army could find itself marooned in hostile territory.

In addition, the quartermaster must address matters such as the condition of roads along the route of march — how much time can an army make in a day along them? Can heavy carts negotiate them? Will they dissolve into mud if it rains? If the army must cross a river, how sturdy is the bridge where they are to cross? Can the army ford the river if there is no suitable bridge? What will the weather be like when the army leaves its base of operations? If it rains or snows, the soldiers need heavy cloaks, but if the weather is blazing hot, they need plenty of fresh water and are better off not having to carry warm clothes with them.

On top of all of that, what will the army do with its wounded after a battle? Does it have enough physicians and clerics to treat them, and enough transport to get them away from the battlefield if they cannot walk or ride? How will the army guard or dispose of the prisoners?

Not even the best quartermaster can answer all of these questions ahead of time, and the vagaries of war always present campaigning armies with unexpected questions. These considerations can and ought to dictate a commander's strategic planning, just as they dictate strategic decisions in the midst of a campaign. Whether to press forward into hostile country or retreat may determine the difficulty

of feeding the army in either case. Perhaps the impending change of seasons makes it more or less difficult to keep the army in the field (as a rule, armies are better off spending winter in their barracks or homes than on the march).

LIVING OFF OF THE LAND

The simplest and least expensive way of keeping an army supplied is to take everything possible from the surrounding area. Whenever the army stops for any extended period of time, such as resting for the night, it sends out foraging parties to look for and acquire supplies. This can mean hunting or gathering food in the wilderness, but it most often entails stealing from the local inhabitants. This widely accepted practice of war tempts even the most scrupulous armies, and is a relatively quick and easy way to keep themselves supplied — though it may have long-term consequences.

Living off of the land only works in fertile or prosperous country, however. Where there is plenty, foragers have an easy time finding what they need, and the peasants may not even mind having some grain or chickens appropriated if they have enough to go around. In a poor country, however, relying on this method of supply brings about disaster in short order.

Another drawback to living off of the land is that the local inhabitants get angry at thievery, especially by an invading army. Not every civilian is passive and fatalistic when confronted by the ravages of war. An inflamed populace with the skill, means, and determination to wage guerilla warfare can make life quite miserable for an army in the field. A defending army can also create substantial logistical problems for an invader who counts on living off of the land, evacuating civilians in their path and destroying or carting away anything that might be of use to them. This “scorched earth” strategy can quite literally starve an army into retreat.

FIXED SYSTEMS OF SUPPLY

As living off the land is an unreliable goal at best, many generals prefer to organize a “supply train.” In theory, it provides the army with a steady stream of food and other necessities, and reduces the risk of alienating the civilians. It is also an expensive and difficult proposition to get a fixed system of supply to work properly, and problems can increase geometrically the further away from home one travels and the more difficult the terrain to traverse.

An army invading a neighboring kingdom must bring enough food for its soldiers to eat regularly enough to remain in marching and fighting shape for the length of their mission. If an army of 10,000 men plans to eat three times daily for 90 days, they must have 450,000 gp worth of iron rations, and a method to keep them edible for longer than their usual week.

Alternately, the quartermaster could issue each man a salary with which to buy food locally. In foreign lands, this runs the risk of poison or poor rations, but even on the home front profiteers may double or triple the cost of rations. Worse still, many soldiers waste their money elsewhere, foolishly choosing to fight on an empty stomach.

With supply lines, the army slows to meet the pace of the lines. Not only can the enemy prepare for the coming battles with this knowledge, but even minor problems such as a broken wheel could cause men to starve.

AD HOC SOURCES OF SUPPLY

Even an army that relies on fixed supply can augment its goods with informal means. Friendly or neutral civilians sell to soldiers whatever goods and services the merchants have. Some civilians even try to make a steady living by hovering around the edges of an army’s logistical needs.

Paid soldiers often attract small bands of merchants known as sutlers, who happily sell whatever goods they have at hand, often at grossly inflated prices. Sutlers usually carry a little bit of everything, from staple foods and clothes to holy symbols and items for personal amusement. Their presence

tends to generate some ambivalence among the rank-and-file, who appreciate the availability of things other than standard army issue food and clothing, but resent the gouging.

Sutlers are usually permanent camp followers who stay with an army from the start of a campaign to its conclusion, unless misfortune intervenes. Opportunistic civilians who see an army passing may use the occasion to hawk whatever they have to sell. A farmer by the roadside may try to sell fruit from his orchards, or an extra fowl or two. A village baker may see the army as a captive market for his bread. It is never a surprise, however, when such folk turn out to be just as greedy as any sutler.

MAGIC ON THE BATTLEFIELD

Whether crawling through a dungeon or guiding an army of 10,000 on a battlefield, magic can be a powerful aid or a dangerous hindrance. Ultimately, magic's nature causes as many to shy from its use as to embrace it.

MILITARY USES OF ARCANES MAGIC

Any mage who has slain a rival with *magic missile* or cast *sleep* on a horde of goblins knows how arcane magic can benefit in a combat situation. Arcane spellcasters can have a similarly powerful effect on mass combat situations in the following ways.

KILLING THE ENEMY

When armies of hundreds, thousands, or tens of thousands hack away at each other, throwing a few *magic missiles* at the enemy accomplishes little. Powerful area effect spells, however, like *fireball* and *meteor swarm* wreak havoc on a close order formation, where the enemy stands shoulder to shoulder. Even the fear of area effect spells can work to a general's advantage. If the enemy disperses his ranks to lessen the impact of *fireballs*, the general's shock attacks have greater effect, and the enemy's charges are less fearsome.

Spells that affect a single, powerful opponent, like *finger of death* or *phantasmal killer* can also deal a

fearsome blow to the enemy if the spells target an important individual. Sometimes the death of an important commander hurts an army more than the loss of a thousand soldiers. In most circumstances, finding an enemy officer is easy — he gives orders.

CONFUSING OR DISRUPTING THE ENEMY

Confusion can sap an army of its ability to fight just as surely as casualties, and to this extent spellcasters can play tricks that stop the enemy in their tracks. Casting *insanity* on an opposing commander could throw an entire army into turmoil. A *mass charm*, timed just as enemy troops enter range, could cause enough confusion to swing the battle. Even the simplest divinations can expose enemy plots. A spellcaster need not slay a single man to be useful.

COUNTERING ENEMY MAGIC

Most opponents will, of course, seek out their own magicians, and any general using the above tactics should expect to face them as well. All manner of defensive spells, from *dispel magic* to *guards* and *wards* can counter the damage that an opposing spellcaster might inflict. In fact, it is not uncommon for armies to detail arcane spellcasters to spot and track enemy spellcasters on the battlefield, following them and reserving their power to counter any offensive spells their foes might cast. Spellcasters who pursue careers as mercenaries often play on military commanders' fears of arcane magic in selling their services. Sorcerers especially favor this role, as their greater flexibility allows them to attack and defend without worrying about memorizing the wrong spells.

ARCANES SPELLCASTERS IN COMBAT

Most arcane spellcasters have little or no actual combat skill, and need protection from individuals while they mete out death to the masses. Most generals take this into consideration, arranging for a guard of infantry for every spellcaster. Others take a radically different approach, giving the spellcasters a bare minimum defense like a shield wall,

but forcing them near the front lines. Though risky, this wedged unit could cast *fireballs* or the like into the very heart of the enemy, bringing even the strongest armies to their knees.

Many generals take wizards as aides, particularly spellcasters who demonstrate a flair for divination or communication. Such generals can adapt their plans quickly in battle, and can afford more daring maneuvers.

MILITARY USES OF DIVINE MAGIC

Divine spellcasters also have their role to play in mass combat. Clerics take on special importance when two armies of opposing alignments fight, when divine spells aimed at the opposite alignment can have a definite impact on the course of the battle. If the opposing army deploys large numbers of undead, having the ability to turn or rebuke may prove more vital than mere spellcraft.

Druids go to war rather less often, unless their tribe or geographical region faces a grave threat. Because they focus on serving nature, they tend to take less interest in the affairs of man and other such creatures than do clerics. It is not unknown, however, for adventurous or outcast druids to offer their services as mercenaries, offering to cast an *entangle* or two for the right amount of coin.

AIDING FRIENDLY TROOPS

Protective divine spells have obvious uses on the battlefield. *Protection* and *magic circle* can help shield friendly troops when fighting an enemy of the opposite alignment. Enhancing spells like *bless* and *aid*, which also affect more than one ally at a time, can fortify troops before they engage with the enemy. A melee between two otherwise evenly-matched bodies of troops can turn on such an advantage.

Healing spells also have obvious uses in a military environment. Combat situations often present clerics with an interesting dilemma in this regard, however. With soldiers wounded and dying all around them, do they save their powers to heal those who might otherwise die without them,



or do they use their daily allotment of spells to help friendly troops kill the enemy? Commanders prefer to keep divine spells in reserve, never knowing when a *dispel magic* or *magic circle* might prove more useful than a *heal* or *cure*. The cleric himself, however, might bow to his divine calling to use a *cure* spell in its place to save or comfort a soldier in need. Though most commanders have as little compunction about punishing a disobedient cleric as they would a common soldier, enough men have made such errors that many clerics refuse to take to the field in anything other than a healer's role.

Healing spells prove useful once the battle is over, of course. Though few clerics can heal whole armies single-handedly, they often have weeks or months to tend to the fallen, and many generals credit clerics with saving their armies from pyrric victories.

COUNTERING ENEMY MAGIC

Since clerics have just as much potential to counter magic as arcane spellcasters, they are often useful in that role, and fill it in much a similar way. Amazingly, however, animosity between clerics grows more personal than it does among mages or sorcerers, who have mere arrogance to fight over. If opposing clerics serve opposing gods, clever generals can exploit this, forcing the clerics into personal conflict at key moments. Though few clerics care for such manipulations, others welcome the chance to best their enemies so publicly.

DIVINE SPELLCASTERS IN COMBAT

Since clerics tend toward greater military skill than do wizards and sorcerers, commanders have greater faith in allowing the clerics near the front lines. While they still advise against actual fighting, a general has little to fear if the clerics do so.

Clerics also serve as aides to commanders. Besides making their powers available for rapid deployment and countering magic targeted at their superiors, cleric-aides also serve as personal bodyguards and physicians, reserving their healing spells for use on commanders.

DIFFERENT RACES AT WAR

No race or species has a monopoly on soldiering. In a diverse campaign setting, diverse armies arise with multiracial warriors. Anyone who is crafty and charismatic enough to organize creatures into an army is cunning enough to use them effectively. While exceptionally foolish generals can do exceptionally foolish things, and even intelligent commanders can panic, most handle their troops with at least a measure of common sense.

The more powerful the creature, the more expensive and more difficult the task of fielding them becomes. Most large and potent creatures occur in small numbers in nature, so recruiting enough of them to fill out an army is a difficult proposition. No matter how attractive the idea is of ten legions of hydras, it is virtually impossible to recruit and convert them to a cause.

The more intelligent the creature, the more amenable it is to military discipline. While many view drilled soldiers as automatons, only a sophisticated brain understands the need for discipline, and to process and carry out orders that run counter to simple instinct. A soldier's life requires teamwork, self-denial and occasionally self-sacrifice. Most animals cannot become soldiers because its instincts to hunt and eat overwhelms any training imposed on them.

The more reasons a creature has to fight, the harder it does so. Armies rarely ever fight to the death. At some point, fatigue, fear, and the instinct for self-preservation set in, and soldiers can no longer function as a cohesive unit. They surrender, flee, or cower. The higher a soldier's morale, the longer he can resist these forces. Purely physical factors like hunger, wounds and lack of sleep influence morale. So do tactical considerations, like running out of arrows or the threat of a terrible death. Purely psychological factors like hatred of the foe, loyalty to the leader, or the desire for plunder are important, too. Everyone tends to fight harder, for instance, if they are defending their homes and families.

HUMANS, HOBGOBLINS AND ORCS

In warfare, humans, hobgoblins and orcs are the most versatile of all the races. They are equally at home in every branch of service. They all have the size to ride a horse and the intelligence to learn to do it well, so they can fight as cavalry. They can learn how to use bows. In fact, they can learn how to handle just about any type of weapon and fight with it on foot, as light, medium or heavy infantry.

Of the three, humans are the most adaptable and technologically adept. They embrace the widest variety of military roles, whether they are longspearmen standing shoulder-shoulder in a phalanx, or light horsemen executing lightning raids, or keen-eyed longbowmen. Their ingenuity also makes them excellent engineers, gifted at finding clever solutions to difficult problems of building fortifications, improving roads or conducting sieges.

Hobgoblins are natural warriors, whose cultural conditioning and innate skills allow them to master a variety of weapon types and adapt to various combat roles. A large host of hobgoblins could conceivably field a competent combined arms force by themselves, complete with heavy infantry, cavalry and archers, and offer their foe a serious challenge with it. Hobgoblins also possess a temperament that makes them effective leaders and amenable to military discipline.

Although orcs favor the greataxe, they can handle a wide variety of weapon types and learn how to ride horses well enough to form cavalry units. Their chaotic temperament, however, makes them less disciplined than hobgoblins or humans, but the proper persuasion or intimidation can force the proper results.

DWARVES

If humans master warfare through their versatility and adaptability, dwarves are perhaps the ultimate pure warrior race. They readily embrace the important martial virtues of physical courage, steadfastness and loyalty. Their legendary endurance shields them against the physical

demands of marching and fighting, and their densely-packed bodies of axemen can maintain their place long after their foes have worn themselves out. Many dwarves devote their lives to crafting arms and armor, particularly from the mithral they so cherish. Dwarven axemen are among the most highly-regarded heavy infantry troops, and their mercenary companies never find themselves wanting for employment.

Dwarves do not make great cavalymen, however, since their stature makes it difficult for them to ride a horse with the requisite skill, and war ponies just do not suffice for an all-out charge. Dwarven armies therefore rely almost exclusively on phalanx-like units of heavy infantry, armed with axes and swords and each led by a dwarven defender. Though vulnerable to flank attacks and hit-and-run tactics, these are rarities in underground tunnels. Dwarven soldiers have experienced their greatest success when integrating themselves into diverse armies that possessed skilled cavalry and missile troops to cover for the weaknesses.

Dwarves' gift for working and analyzing stone also makes them natural siege engineers, and many dwarves have made a name for themselves in this military specialty. Dwarven engineers always command a premium for their services, and for good reason.

Few can compare with the sheer intuition of a dwarven siegemaster, who can analyze a fortress' greatest weaknesses with a glance.

HALFLINGS AND GNOMES

Unless they square off against kobolds, goblins, or each other, halflings and gnomes are just too small to hold their own in mass melee combat. They rarely form units unless everything they know is at stake.

On the other hand, halflings make excellent skirmishers because of their legendary nimbleness and fearlessness. Any halfling with a shortbow or sling makes a good skirmisher. In fact, it sometimes happens that the male population of a halfling community signs up en masse to help defend the lands in

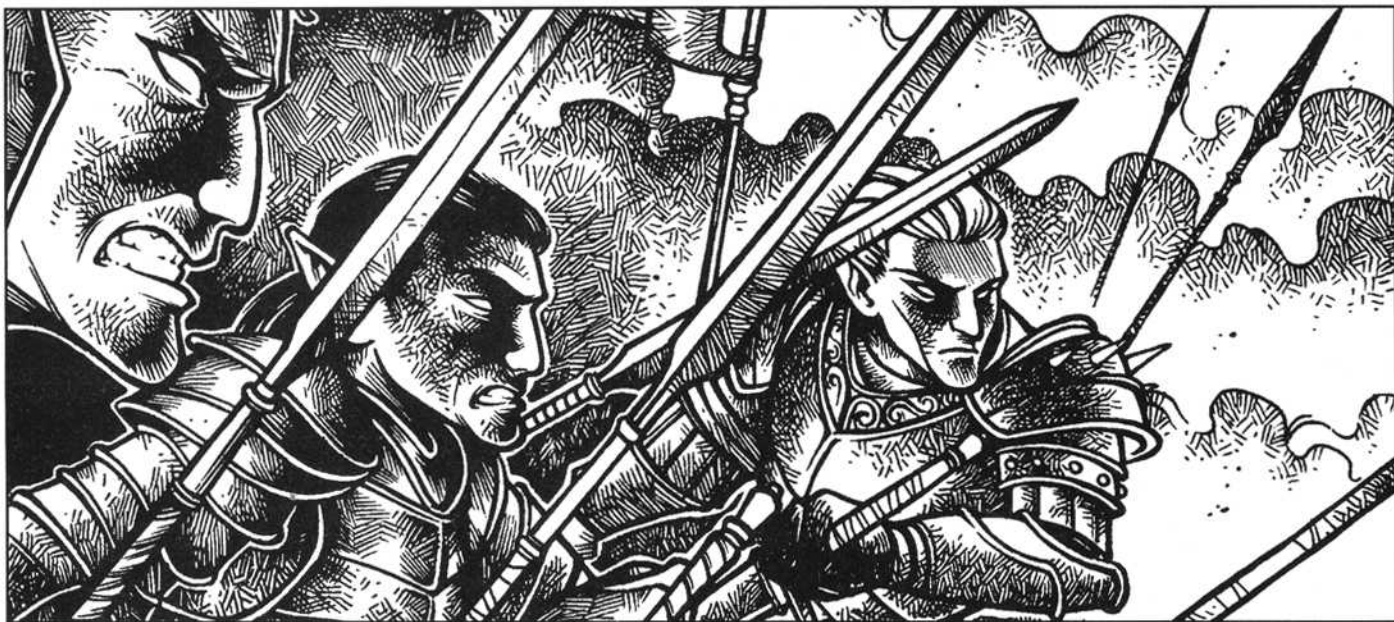

which they live, offering their services as a body of light missile troops. There have also been recorded instances of entire male halfling populations forming their own mercenary companies and selling their services to the highest bidder as a response to times of economic hardship. Their skill at hiding, sneaking and climbing also makes them skilled guerilla fighters, and any army that tries to occupy a halfling village had best prepare for a nasty and frustrating fight. Halflings are not a warlike people by nature, but like all hardy and adaptable creatures, they have learned how to use their unique traits to best advantage.

Gnomes are not a warlike people either, and they lack the martial temperament of their larger cousins, the dwarves. Sometimes, however, exiled gnomes band together into mercenary companies and sell their services as specialists against goblinoids and giants. They learn how to handle ponies or other small mount, and practice hit-and-run tactics that allow them to strike at larger foes and escape with minimal retaliation. Only against kobolds and goblins do they engage in melee.



ELVES

Unlike dwarves, elves are not an inherently warlike race — they are simply very good at it. Their agility and skill with the bow make them excellent missile troops, and they can fight equally well as skirmishers or in close order companies. Only a foolish commander would fail to appreciate having companies of elvish longbowmen supporting his battle line. Their relative frailty means that close order infantry fighting is not their strong point, but elves have mastered light cavalry tactics and they know how to execute hit-and-run attacks. When fighting on horseback, they either fire their bows from the saddle or close with rapier or longsword.

Like dwarves, elves tend to have the greatest military success when integrating their particular talents into a diversified army, so they can concentrate on what they know how to do best. Elven armies can be quite successful when fighting on their own terms, however, and they coordinate missile fire with quick light cavalry attacks that keep the enemy off balance. When the enemy is sufficiently weak, the cavalry strikes in an exposed flank with a shock attack. These tactics require a specific kind of battlefield in which the archers can take cover, and yet there is enough flat, open ground for the cavalry to operate efficiently. Forest boundaries serve well in this function.

Elves also make effective guerilla fighters when defending their homes. Invading a wood that belongs to elves causes a rash of snipers, and small bands of them jump out from cover and attack with swords before fading back into the trees. They are also fond of raiding enemy encampments at dusk or pre-dawn, using their low-light vision to give them an edge.

GIANTS

Because of their strength and size, all types of giants make formidable warriors. They can keep smaller creatures at bay regardless of the enemy's weaponry, and a charging unit of giants can trample even a disciplined phalanx of heavy infantrymen. Moreover, their rock throwing ability makes them fearsome missile troops, and valuable military assets on either side of a siege. With enough giants to work on a section of wall, catapults are slow and cumbersome; giants can cause an avalanche with a mere clap of their hands, and storming their fortifications is almost suicidal.

In melee combat, giants always fight in open order. They require so much room in which to swing their weapons without hitting each other, that, on a human scale, they cannot possibly maintain a close formation. A bold soldier of small size could slip in between two giants in the front rank of a formation and strike one of them from behind. From hard experience, giants have learned that the second and third ranks of the formation need to keep an eye out for infiltrators trying to sneak through the first rank.

Giants who inhabit mountains or hills like to fight guerilla-style when attacked, and anyone who does so had best prepare for a difficult fight. Giants like to strike from ambush in these situations, throwing rocks at their oppressors and setting off rockslides and avalanches when possible.

DRAGONS

If it deigns to play that role, a mature dragon can make itself the lord of the battlefield, the most dangerous thing in sight. Its breath weapon cutting swathes of death through the ranks of an army. If it jumps onto a close order formation, it can wipe out a dozen soldiers in a moment with its claws. Its spell-like abilities allow it to function as a flying high-level arcane spellcaster that can hold its own against all comers in hand-to-hand (or claw, wing and tail to hand) combat... if their mere appearance does not simply rout the enemy in the first place.

The problem, of course, is getting one to join an army. Dragons care little for the affairs of lesser creatures, and usually expect one of three things: a worthy cause, a chance to strike at an old foe, or enough money to bribe a god. None of these options are common, however, and most generals content themselves to a dragon-free battlefield.

UNDEAD

Every general dreams of having soldiers who do not waver, who fight without fear and without tiring. Unfortunately for them, all living beings are subject to fear, pain, and fatigue to some degree. A general who has a large number of undead in his service, however, can get around this problem.

It takes a fair amount of necromancy to create enough skeletons, zombies or ghouls to make an impact in a mass combat situation. If successful, however a general has at his disposal shock troops who never retreat and fight to the last extremity, if only because they are too mindless to do anything else. Undead troops may also panic the enemy by their very appearance. They require no provisions, can march endlessly without tiring, and care not a whit for winter camp. They are a logistical ideal.

On the other hand, undead are exceptionally vulnerable to enemy clerics, should they be present in the ranks. If turned or rebuked, only another cleric can attempt to rally them. Furthermore, undead troops are mostly or entirely mindless, requiring constant supervision lest they stop to feast upon their fallen foes.

CHAPTER TWO:

WARS MAKE SOLDIERS

NEW USES FOR OLD SKILLS

ALCHEMY (INT)

Normal Use: You can combine exotic ingredients to produce mundane items capable of amazing effects. You can draw upon your knowledge of alchemy to identify strange substances and poisons.

New Use: *Produce healing balm.* You can combine herbs, chemicals, and other substances to produce a balm that promotes healing and helps disinfect wounds. Producing a healing balm, you must make a DC 20 Alchemy check. In addition, consult the rules for using the Craft skill to determine how much time and money it takes to make a dose of healing balm. The balm normally sells for 10 gp per dose and weighs 1 pound per 10 doses.

Healing balm enhances long-term care provided by the Heal skill. When using the Heal skill to help a patient recover hit points or attribute points, use a single dose of balm to triple the rate of healing, rather than doubling it as normal.

ANIMAL EMPATHY (WIS)

Normal Use: You can use this skill to help change an animal's attitude. You can calm an angry dog, dissuade a frightened bear from attacking, or persuade a wild rabbit to sit still and allow you to pet it.

New Use: *Calm frightened animal.* You may spend a full-round action to soothe a frightened animal. If an animal fails its Will save against any fear effect or any effect that grants it a morale-based penalty, you can use this skill to grant the animal a second saving throw at a bonus. You must spend a full round action either petting the animal or talking to it in a soothing voice. Make an Animal Empathy

check (DC 20) to help soothe the animal's nerves. At the end of your action, the animal may immediately attempt a second Will save to against the effect it is under.

CRAFT (GUNSMITH) (INT; TRAINED ONLY)

This skill provides the knowledge to design and manufacture firearms of various sizes, from handguns to cannons.

Check: Using this skill to create weapons requires you to have a fully functional forge, available raw materials, and a complete set of both metallurgy and smithing tools. You can create a single weapon by making the DC numbers given in the table. Use the method in the Player's Handbook for producing an item.

Item	DC
Handgun (pistol or rifle)	25
Cannon, light	20
Cannon, medium	23
Cannon, heavy	25

Retry: You can retry a failed check, but if you miss by 5 or more, you ruin half the raw materials and have to pay half the original raw material cost again.

Special: If you have the skill Profession (artillery), Craft (blacksmithing), or Craft (weaponsmithing) at 5 or more ranks, you gain a +2 synergy bonus.

DECIPHER SCRIPT (INT)

Normal Use: You can puzzle out the meaning of ancient treasure maps or forgotten runic alphabets. You can get the gist of a letter or other short

message written in a foreign language, including planar or magical tongues such as Infernal or Draconic.

New Use: *Intercept signals.* While observing enemy armies, if you can catch a view of any visual signals they are using to coordinate attacks and plans, you can attempt to puzzle out the meaning of the signals and determine the enemy's short-term plans. Armies tend to use many false signals, leaving a chance that you may either pick up on a fake set of signals, or misinterpret a signal. When you use Decipher Script in this manner, the DM makes your check for you in secret. The DC to correctly interpret a signal is typically 20, though elaborate signals, those that use a series of false codes, or those that shift the meaning of signals over time may be more difficult to crack. However, once you crack a code it is much easier to subsequently decode it. If you correctly interpret a signal, you gain a +5 competence bonus to decode subsequent uses of that set of signals.

If you roll a natural 1 or the total result of your check is less than 10, you incorrectly interpret the signals. The DM should decide how exactly you misinterpret the signals.

DIPLOMACY (CHA)

Normal Use: Diplomacy covers a wide range of social interactions. You can use it to talk a guard into letting you into the rich part of town or to give a rousing speech to a crowd. In addition, this skill covers etiquette, proper methods of address and protocol when dealing with nobles or rulers, and general social grace and tact. Diplomacy allows you to fit into a wide range of social situations, allowing you to effortlessly fit in and get along with others.

New Use: *Bargain.* You may use this skill to talk a merchant into charging you less for his wares. When you buy something, you may make a Diplomacy roll opposed either by the merchant's Diplomacy or his Will save. If you succeed, you gain a 10% discount on the item. You may attempt to gain an additional 10% discount by using your Diplomacy skill additional times. With each success,

increase your total discount by 10%. You cannot talk a merchant down to dropping a price by more than 50%. The merchant gains a +2 circumstance bonus to his Diplomacy check or Will save for each previous Diplomacy check you made to decrease the price. If you fail a check to decrease the price, you may not attempt to reduce the price again that day.



Special: *Foreign diplomacy.* In situations where you know the language of the people you are dealing with, you gain a +2 synergy bonus to Diplomacy checks.

DISABLE DEVICE (INT)

Normal Use: You can use this skill to ruin a mechanical device, such as a trap, a lock, or a wagon wheel. You use your knowledge of mechanical items to damage their inner works and prevent them from functioning properly. You do not simply smash the item but instead pop a spring or shift a gear in order to disable it.

New Use: *Sabotage.* You can not only disable a device, but you can do so in such a manner that anyone who inspects the device might not notice that it no longer functions. When you disable a device, your work is difficult to notice. If you make a Disable Device check by 5 or more, casual observation notices no actual harm to the device. Anyone looking over the device must make a Spot check with a DC equal to the result of your Disable Device check to discover that the device no longer works properly. Obviously, the item's use reveals the sabotage.

GATHER INFORMATION (CHA)

Normal Use: You have a skill for turning up information on a particular subject. You can make the rounds at inns, taverns, and other public places to hear the current news and rumors and uncover tips and leads

New Use: *Recruit mercenaries.* You can track down a warrior or group of warriors who hire out to the highest bidder. Make a Gather Information check as normal. If you seek a single warrior, divide the

result of your check by 4 in order to determine what level warrior you find and may attempt to hire. If you seek a large group, you may turn up a total number of recruits equal to the result of your skill check. You must still negotiate a pay rate with your recruits. Obviously, you can't recruit warriors in an area where there simply aren't fighters of the appropriate level available. Assume that only 1% of military aged inhabitants of a town would have any interest in working as mercenaries. This percentage could fluctuate, depending on local conditions. For example, in a region

torn by fighting many more mercenaries are available, while in the heart of peaceful realm fewer warriors are available.

New Use: *Spy.*

Not all espionage revolves around breaking into highly-guarded installations or slipping behind enemy lines to snatch a set of plans or steal a secret weapon. By befriending guards, soldiers, functionaries, and others involved in the administration of a military campaign, you can glean important nuggets of information by sifting through the rumors and small talk you hear and collate it to help draw a big picture of what's going on. If you use Gather Information in a town or city that serves as the headquarters of an army or as a common relaxation point for troops, you can learn the general plans and disposition of that army by making a DC

25 Gather Information check.

INTIMIDATE (CHA)

Normal Use: Intimidate allows you to force people to do what you want them to do. You commonly use threats, either clear or implied, to push someone else to do something.

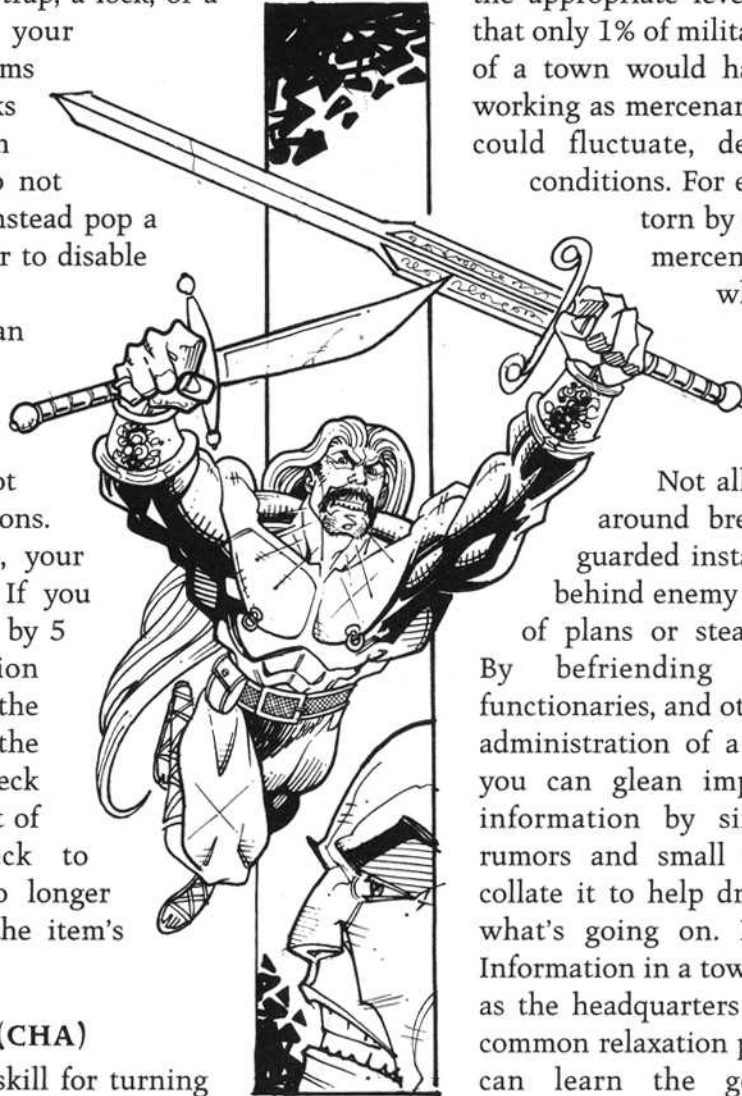

New Use: *Push to action.* You can use Intimidate to force a terrified or otherwise nervous person to take a specific action. You could browbeat a cowering warrior to attack or force someone cowering in hiding to get up and run from the enemy. You may use this skill against anyone who has failed a Will save against a *fear* effect that forces him to flee from combat or cower in place. Make an Intimidate skill check. If your check equals or exceeds the save DC of the spell that affected your target, the target may follow one specific order of up to five words that you give him. If your target completes his action and is still under the effects of *fear*, he acts as appropriate for his missed save.

PROFESSION (INT)

Normal Use: Profession covers a wide variety of vocations that you may use to earn a wage.

New Use: *Soldier.* You are a professional soldier or mercenary, schooled in military life and capable of finding employment with a fighting unit. To determine how much money (gp) you earn per week, add your highest base attack bonus to your Profession (soldier) skill check. If your base attack bonus is +5 or higher, multiply it by 5. If it is higher than 10, multiply by 25. If it is higher than 15, multiply it by 125.

This assumes that you merely seek work as hired muscle. You may also attempt to find a job as an officer, such as a captain of the watch or mercenary lieutenant. Make a Profession check (DC 25) without adding your base attack bonus to the check. If you succeed, you find work as an officer. Determine the wage you earn as above and multiply the final result by 10 to determine how much you earn as an officer.

PROFESSION (ARTILLERY) (INT; TRAINED ONLY)

This skill is used by those who employ annons and other gunpowder-type weapons and artillery devices. Anyone making an attack with a cannon uses this skill.

Check: This ability allows you to attack with a cannon or other artillery piece, and perform general service and maintenance on common artillery.

Most who have this skill are part of an army or organization that requires this kind of service. This skill is also used when firing artillery weapons to determine hits and misses.

Retry: Retries are not allowed.

Special: If you have the skill Profession (siege engineer) at 5 or more ranks, you gain a +2 synergy bonus.

WILDERNESS LORE (WIS)

Normal Use: You can survive in the wild, living off the land and shielding yourself from the elements. You can also provide for others, keeping them warm, sheltered, and fed. You also use Wilderness Lore in conjunction with the Track feat to pick out details left behind by others who have passed through an area.

New Use: *Reconnaissance.* If you have the Track feat, you may not only follow groups of enemy troops, but you can also draw some conclusions about their formation, composition, and plans. You may check separately for each piece of information listed below. Apply the modifier listed with each fact below to the Track DC you originally needed to beat.

Tracking Condition	DC Modifier
Unit's speed	+2
When unit moved through area (in days)	+2
Animals or siege weapons with enemy	+5
Weapons and armor used by enemy	+5
When unit moved through area (in hours)	+8
Composition of enemy force	+10

NEW FEATS

ACROBATIC STRIKE [GENERAL]

You may use your acrobatic skill to put your enemy off his guard and strike at his vulnerable points. You flip through the air and land behind him, bounce off a wall and attack him from the side, or otherwise launch an attack from an unexpected direction.

Prerequisite: Dex 13+, Tumbling skill.

Benefit: As a full-round action, you may make a Tumble check (DC 25). If you succeed, you may make a single melee attack at your highest bonus against an opponent who loses his Dexterity bonus to AC. If you fail your Tumble check, you stumble to the ground, fall prone, and may not attack.

Normal: You may use the Tumble skill to move through threatened areas, move through areas occupied by your opponents, or to gain a better AC bonus with the full defense or fight defensively actions.

Special: You remain in the same spot when using this skill, whether you succeed at your skill check or fall prone. As using this feat is a full-round action, you may not normally combine this feat with anything more than a five-foot step.

ADAPTIVE FIGHTING [GENERAL, FIGHTER]

You may fight with the blunt end of a polearm or large weapon.

Prerequisite: Power Attack.

Benefit: When using a weapon one size larger than yourself, you may make a second attack with the butt of the weapon as if it were a double weapon. The blunt end deals 1d6 points of bludgeoning damage with a x2 critical modifier. The blunt end is considered a light weapon. It is in all ways just like fighting with a double weapon.



COUNTER CHARGE [GENERAL, FIGHTER]

When an opponent charges you, you may step forward and meet him, using his momentum to make your own attack more effective.

Prerequisite: Combat Reflexes.

Benefit: If you ready an action to use this feat against a charging enemy, you may take a five foot step in order to force your opponent to end his charge five feet early. You may then attack your opponent before he has his chance to strike you. Your opponent suffers the -2 AC penalty for charging. In addition, you deal double damage on a successful attack. Stack this bonus damage with the weapon's critical multiplier on a critical hit. Your opponent may then attack you as normal, receiving any bonuses for charging.

Normal: Normally, you may only deal double damage against charging opponents with weapons that may be set against charging foes.

Special: If for any reason you may not take your five-foot step, you may not use this feat.

DISTRACT [GENERAL]

You excel at keeping your enemies off-balance. You can mislead them into anticipating one move when you in fact make another. When you drop your guard to take an action, your enemies hesitate for a split second before reacting, making their counterattacks rushed and inaccurate.

Prerequisite: Dodge.

Benefit: You receive a +4 dodge bonus to AC against attacks of opportunity caused by non-movement actions, such as when casting a spell or firing a missile weapon.

Special: Dodge bonuses, unlike other name modifiers, stack with each other.

EVASIVE FIGHTING [GENERAL, FIGHTER]

When a foe rushes you, you can leap aside, spoiling any benefits he gains from charging while still inflicting the penalties for charging.

Prerequisite: Dodge.

Benefit: When an opponent charges you, you duck aside at the last moment, ruining his attack.

Your opponent may attack you as normal, but he does not receive the +2 bonus for charging. He still takes the -2 AC penalty for making a charge. You may use this feat on once per round.

Special: When you use this ability you must immediately make a five-foot step as a free action. If you are unable to take this five-foot step, you may not use this feat. Your opponent stops in the space where his charge movement would normally end. You may not set a weapon against a charge when using this feat.

FOLLOW THROUGH [GENERAL, FIGHTER]

You are adept at pushing your way through the enemy. When striking down a foe, you have the reflexes and strength to steadily advance your assault, allowing you to step over his body and continue your attack.

Prerequisite: Str 13+, Power Attack.

Benefit: When you drop an opponent in melee, such as by reducing a foe to 0 or fewer hit points, you may immediately make a five foot step to occupy your enemy's position. This movement counts as a free action, allowing you to use Cleave or Great Cleave after making this movement. You must advance directly into the area occupied by your enemy. If this is physically impossible, such as if you dropped your foe with a reach weapon, you may not take this five-foot step.

Special: You may use the movement granted by this feat after dropping a foe but before resolving attacks granted by the Cleave or Great Cleave feats. You may only use this feat once per round. If you previously moved during a round in which you use this ability, the movement provided by this feat may allow you to move a total distance above your normal maximum movement rate.

FRENZIED ATTACK [GENERAL]

You may attack your foe with wild abandon, allowing you to rain many inaccurate blows upon him.

Prerequisite: Power Attack, base attack bonus +4 or higher.

Benefit: When you make a full attack action, you may take an additional attack at your highest base attack bonus. However, this additional attack and all of your other ones during that round suffer a -4 penalty.

Special: A monk may use this feat in conjunction with his flurry of blows ability to gain two additional attacks in a round. However, the penalties from both abilities stack, giving the monk a total -6 penalty to all his attacks.

IMPROVED BALANCE [GENERAL, FIGHTER]

You are built low to the ground and are very stable on your feet. This makes it difficult for others to tackle, overrun, push, or trip you.

Prerequisite: Strength 13+.

Benefit: You gain a +4 competence bonus to grapple checks to avoid being held by an opponent. You also gain a +4 competence bonus to Strength checks when someone attempts to bull rush, overrun or trip you.

Special: You only get the bonus to grapple checks when others attempt to grapple you. You do not receive it when you initiate the grapple attack.

OVERPOWERING ATTACK [GENERAL, FIGHTER]

You rely on your overpowering might to pummel your foes into submission. You can batter aside attempts to parry or ward off your blows.

Prerequisite: Strength 15+, Power Attack.

Benefit: When you attack an opponent who uses the fighting defensively or total defense, you gain a +2 bonus to hit. Your powerful attacks sweep aside your opponent's desperate attempts to ward away your attacks.

Special: You do not need to declare that you are using this feat. You automatically gain this bonus when attacking an enemy who uses either defensive maneuver. Note that this bonus applies only to those two specific actions. Other combat abilities or maneuvers that grant your opponent an AC benefit, such as Expertise, do not provoke this bonus.



NEUTRALIZE ENEMY [GENERAL, FIGHTER]

With a sudden flurry of blows, you can push your enemy on the defensive and disrupt his attacks. While you keep your opponent occupied, your allies can move by him or drop their guard without exposing themselves to attack.

Prerequisite: Base attack bonus +3.

Benefit: As a full-round action, you can unleash a wild flurry of blows at your opponent, forcing him on the defensive. Until either your or your opponent's next action, whichever comes first, your opponent does not threaten the area around him. You may only use this ability on creatures no larger than one size category above your own. This is not an attack and therefore, you do not roll to hit.

Special: While using this action, you are so focused on keeping your foe occupied that you may not take attacks of opportunity on any foes aside from the target of this feat.

POWER SHOT [GENERAL, FIGHTER]

Your missile attacks can cleave through your target and strike a second foe.

Prerequisite: Base attack bonus +5, Point Blank Shot, Power Attack.

Benefit: If you cause a creature to drop with a missile attack, such as by reducing it to 0 or fewer hit points, your missile rips through your target and potentially strikes a second foe. You may immediately make another missile attack at the same base attack bonus of your killing shot at an enemy directly behind your target. This target must stand behind your target relative to your position and must stand directly adjacent to your target. You may use this ability once per round.

POWER THROW [GENERAL, FIGHTER]

When you grapple an opponent, you can hoist him above your head and toss him into your enemies, sending them all sprawling.

Prerequisite: Str 15+.

Benefit: If you are grappling an opponent, you may make a grapple check to pick him up and throw him. Obviously, you must have a high enough Strength to lift your opponent's total weight above your head. You may then hurl your opponent up to 15 feet, inflicting 1d4 + your Strength modifier in subdual damage and leaving him prone where he lands. You may throw your opponent at someone. Resolve this as a ranged touch attack. If you hit, your target takes 1d4 plus your Strength modifier in subdual damage. If he is the same size or smaller than the enemy you threw, he is knocked prone. Your thrown opponent takes 1d4 + your Strength modifier in subdual damage whether you hit or not, and lies prone in a random spot adjacent to your target. Use the rules for scattering projectiles to determine where your thrown enemy lands.

Special: You may opt to carry your opponent over your head. You lose your Dexterity and shield bonuses to AC, but your opponent is largely helpless. He may make attacks at -4 to hit and deals half damage with physical attacks. He may cast spells, but must make a Concentration check (DC 25) to successfully use a spell. He may use special abilities and magic items, except weapons which suffer the penalties noted above, as normal.

RELENTLESS [GENERAL]

Even after sustaining life-threatening injuries you continue to fight on as normal.

Prerequisite: Con 13+, Too Tough to Die.

Benefit: You automatically make your Fortitude save to avoid dying from attacks that deal massive damage. Furthermore, you may continue to take normal actions when your current hit points are between 0 to -9. Make a Fortitude save (DC 15) each round to act as normal. Each round you do so, however, take 1 hp of damage. If your hit points fall to -10, you immediately die. At any time, you may choose to collapse to the ground unconscious, allowing you to check for stabilization as normal. You make attempt to stabilize on the same round that you drop if you do so willingly. If you choose to collapse, you may take no other actions that round.

If you fail your Fortitude save, you immediately collapse to the ground. You take 1 hp of damage as normal, but you may not check to stabilize on the round in which you missed your saving throw.

Normal: You must make a Fortitude save to avoid dying when hit by any single attack that does 50 or more points of damage. When reduced to -1 or fewer hit points, you fall automatically fall unconscious. When reduced to 0 hit points, you take a point of damage and fall unconscious if you take any strenuous action, such as attacking or casting a spell.

ROPE A DOPE [GENERAL]

You can trick your opponent into thinking you are badly injured, tired, or otherwise less capable in combat than you actually are. You lure him into underestimating your ability and dropping his guard, allowing you to make a devastating strike against him

Prerequisite: Dex 13+.

Benefit: The first time you attack an enemy, you may elect to automatically miss with your attack. The next time you strike that opponent, you gain a +6 circumstance bonus to hit. You do not necessarily have to strike on the very next round. You may, for example, cast a spell such as *chill touch* and then deliver an attack with that spell at +6 to hit. Note that if you attack anyone else while in your opponent's line of sight, he observes your true skill and you do not gain your +6 bonus. You may, however, make attacks of opportunity without losing this bonus.

SURGE [GENERAL]

You can push yourself in order to get the drop on an opponent. You are capable of taking short bursts of energy to seize the moment.

Prerequisite: Improved Initiative.

Benefit: At any point in combat, you may add up to a +5 bonus to your current initiative value. For the purposes of resolving actions for that round, use this new initiative value. After taking an action with your augmented initiative, subtract twice the

bonus you added to your initiative from your original initiative value. In essence, you subtract three times the bonus you took from your modified initiative. You may use this ability when rolling initiative in order to take advantage of it on your first action.

Normal: Once you have rolled initiative, you can only use the delay, refocus, or refocus actions to modify your initiative value.

SWARM ATTACK [GENERAL, FIGHTER]

You are used to fighting in close quarters with others of your size against larger foes. You are adept at overwhelming your enemies with sheer numbers.

Prerequisite: You must be smaller than medium-size to take this feat.

Benefit: You may occupy the same space as an ally who is the same size or smaller. You can take all actions as normal when sharing a space, such as attacking, casting spells, or using skills. In addition, the ally who shares you space may also act normally. For example, you may both attack the same target, or you may cast a spell at one enemy while your ally attacks someone else.

Normal: You cannot normally share the same space with anyone else who is not dead, unconscious, or otherwise incapacitated.

Special: While occupying the same square as another creature, you are still vulnerable to flanking attacks and other hazards. If two enemies flank your position, both you and your ally are considered flanked. No more than two people may ever share a space, no matter how many have this feat.

TOO TOUGH TO DIE [GENERAL]

You are incredibly tough. You can survive terrible wounds that would kill lesser men.

Prerequisite: Toughness.

Benefit: When reduced to less than 0 hit points, you have a 20% chance per round of stabilizing. You also have a 20% chance of becoming conscious after stabilizing due to outside help, such as a cure spell or a successful Heal check. If you stabilize on your

own and are left to fend for yourself, you have a 20% each hour of regaining consciousness. In addition, you have a 20% chance to begin recovering hit points naturally each day after regaining consciousness.

Normal: Characters without this feat have a 10% chance to stabilize, regain consciousness, and begin healing naturally.

PRESTIGE CLASSES

BEAST HANDLER

Many armies march to war with a full complement of animals to serve as beasts of burden, guards, and even as living war machines. Dogs, falcons, mules, and horses all serve their places in traveling war hosts, each as important as any archer, scout, or knight. A rampaging elephant can smash into the enemy lines with deadlier effect than a line of heavily armored knights, while a bloodhound makes a better tracker than many outriders.

Beast handlers combine a knowledge of animals with an inflexible will and a touch of magical talent. Beast handlers tend to keep a few animal companions as their personal charges, offering their spells and unique talent with a whip to keep others' animals in line. Beast handlers rarely invest the time and effort to train animals for the use of their clients, though many nobles hire on beast handlers not only for their skill in handling animals, but also to gain the use of the beast handler's highly skilled charges.

Some knights and cavaliers study as beast handlers in order to forge stronger bonds with their mounts. A heavily-armored knight mounted atop a highly-trained warhorse (often a deadly combatant in its own right) is a fearsome foe indeed.

Hit Die: d10

Requirements

To become a beast handler, a character must meet the following requirements:

Base Attack Bonus: +4

Handle Animal: 8 ranks

BEAST HANDLER ADVANCEMENT TABLE

Level	Attack	Fort	Ref	Will	Special
1	+1	+2	+0	+0	Ward Animal
2	+2	+3	+0	+0	Animal Training
3	+3	+3	+1	+3	Animal Training
4	+4	+4	+1	+4	Animal Training
5	+5	+4	+1	+4	Animal Training
6	+6	+5	+2	+5	Animal Training
7	+7	+5	+2	+5	Animal Training
8	+8	+6	+2	+6	Animal Training
9	+9	+6	+3	+6	Animal Training
10	+10	+7	+3	+7	Animal Training

Feats: Exotic Weapon Proficiency (whip), Skill Focus (handle animal)

Class Skills

The beast handler class skills (and the key ability for each) are Animal Empathy (Wis), Climb (Str), Craft (Int), Handle Animal (Cha), Intimidate (Cha), Knowledge (nature) (Int), Jump (Str), Ride (Dex), and Swim (Str).

Skill Points at Each Level: 2 + Int modifier.

Class Features

All of the following are class features of the beast handler prestige class.

Weapon and Armor Proficiency: A beast handler gains proficiency with all simple and martial weapons, and light and medium armor.

Spells: The beast handler casts arcane spells from the beast handler spell list. He casts these spells without having to prepare them beforehand or keep a set of spellbooks. Beast handlers receive bonus spells for a high Charisma score. To cast a spell the beast handler's Charisma must be greater than or equal to 10 plus the spell's level. The saving throw DC for spells cast by the beast handler is 10 plus the beast handler's Charisma modifier plus the spell's level.

Special: A beast handler is specifically useful for training and commanding animals. With the DM's permission, these abilities might also extend to

beasts (but not magical beasts or aberrations). Depending on style of play, a beast handler who trains manticores or hippogriffs could be very interesting.

Ward Animal: At 1st level, the beast handler can use his whip to force an animal into moving in a specific direction. So long as the beast handler has his whip, he can use the Intimidate skill on any animal. When using Intimidate in this manner, the beast handler gains a +4 competence bonus to his skill check. If the beast handler succeeds, he can direct the animal to move in a specific direction at up to the animal's full movement, or he may force the animal to remain in its spot, motionless. Each round, the beast handler must again use his Intimidate skill to direct the animal. If the beast handler's skill check fails, the animal may act as normal.

Animal Training: The beast handler is an expert at training animals in order to improve their effectiveness in combat. At 2nd level (and every level thereafter), if the beast handler spends one week and 100 gp per HD of the creature being trained, that animal gains a feat chosen by the beast handler. This feat may be chosen from the standard list of feats, though obviously metamagic feats and others are useless to most animals.

The beast handler gains this ability multiple times. Each time he gains this ability, he has an extra feat to grant to a chosen animal. In addition,

Spells per Day:

Handler's Level	1	2	3	4
1	—	—	—	—
2	0	—	—	—
3	1	—	—	—
4	2	0	—	—
5	3	1	—	—
6	3	2	—	—
7	3	2	0	—
8	3	3	1	—
9	3	3	2	—
10	3	3	2	0

the beast handler may grant multiple feats to a single animal. Furthermore, he may grant an animal a feat and then subsequently train that animal to use feats that require the first feat as a prerequisite. Thus, a beast handler could train a dog to use Power Attack then later grant it Cleave.

A beast handler may only train one creature in the use of one feat per week. Furthermore, the beast handler can never grant more feats than his total available uses of this ability.

Once an animal has mastered a feat, the beast handler must spend four hours per week with that animal for it to maintain the use of any feats granted to it by the beast handler. Seven days after the last training session the animal loses the use of its bonus feats and must be retrained in their use. At 6th level the trainer need only spend two hours per week with that animal and at 10th level only one hour per week.

Rally Beast: At 5th level, as a standard action, the beast handler can rally any animal under his control. Animals rallied in this manner are effected as if *aid* had been cast on them. The effects last for 10 minutes and the handler may rally a number of creatures per day equal to his beast handler level. A single animal may not be targeted more than one per day with this ability.

Special Mount: At 10th level, a beast handler gains a special mount just as a paladin. However, unlike a paladin, this mount is not summoned, but

Spells Known:

Handler's Level	1	2	3	4
1	—	—	—	—
2	2+	—	—	—
3	3	—	—	—
4	3	2+	—	—
5	4	3	—	—
6	4	3	—	—
7	4	4	2+	—
8	4	4	3	—
9	4	4	3	—
10	4	4	3	2+

rather caught in the wild and trained. After spending 1000 gp and four weeks in training, the mount (usually a horse, but it could be most any animal with the DM's approval), gains three additional hit dice, its natural armor increase by five, and its Strength and Intelligence increase by +2 each. The mount also gains a +2 competence bonus to all Reflex saving throws and improved evasion (per a paladin's mount).

Beast Handler Spells

Beast handlers choose their spells from the following list:

Level 1 Spells: *animal friendship, calm animals, enlarge, invisibility to animals, magic fang, reduce.*

Level 2 Spells: *animal trance, charm person or animal, detect animals or plants, hold animal, speak with animals, summon nature's ally I.*

Level 3 Spells: *animal messenger, dominate animal, greater magic fang, summon nature's ally II, summon swarm.*

Level 4 Spells: *charm monster, giant vermin, remove disease, repel vermin, summon nature's ally III.*

BRUTE

The brute uses his raw strength to batter his opponents into submission. His attacks are often wildly inaccurate, but when they connect the result is devastating. Even when the brute doesn't injure his opponent, his relentless attack can smash his foe's armor, shields, and weapons to pieces, leaving

the foe fatally exposed to the brute's vicious assault. Brutes often serve as hired muscle for a wide range of people, from criminals to governmental officials to mercenary captains. Though often ill-tempered and difficult to control, brutes face no shortage of demand for their skills.

In times of war, brutes often head up press gangs that sweep through the city streets, and sometimes even venture out into the countryside in an effort to round up recruits for the local lord's army. Brutes serve this role well, for they can quickly and easily beat most prospective recruits into submission.

While some may characterize brutes as bullies, many of them are simple warriors who prefer to smash a problem rather than think up a subtler plan. A brute's ferocious assault has turned many pitched battles into routs and few commanders or adventurers turn away a brute looking for work.

Hit Die: d10

Requirements

To become a brute, a character must meet the following requirements.

Base Attack Bonus: +7

Intimidate: 5 ranks

Feats: Power Attack, Toughness.

Class Skills

The brute class skills (and the key ability for each) are Climb (Str), Craft (Int), Intimidate (Cha),

Jump (Str), Ride (Dex), and Swim (Str).

Skill Points at Each Level: 2 + Int modifier.

Class Features

All of the following are class features of the brute prestige class.

Weapon and Armor Proficiency: Brutes gain proficiency with all simple and martial weapons, shields, and armor.

Improved Power Attack: The brute is a master at delivering punishing blows to his enemies. While he delivers tremendous damage, he often swings wildly and with little accuracy. When the brute uses his Power Attack feat, double the damage bonus he receives. In addition, the brute may opt to use this ability when making an attack of opportunity or at any other time in addition to during his action. Brutes are masters of the sucker punch, and when they have a chance to swing at an exposed opponent, they are capable of taking wild but devastating blows.

Toughness: At 1st, 4th and 7th levels, the brute gains 3 additional hit points as though he received the Toughness Feat.

Battle Cry: At 2nd level, the brute can channel his fury and strength into a wild display of howling. When charging, the brute's wild battle cry strikes fear into his enemies. Once per day, the brute may make an Intimidate check against an enemy he is charging upon, as a free action. If the check

BRUTE ADVANCEMENT TABLE

Level	Attack	Fort	Ref	Will	Special
1	+1	+2	+0	+0	Improved Power attack, Toughness
2	+2	+3	+0	+0	Battle Cry
3	+3	+3	+1	+1	Shield Breaker
4	+4	+4	+1	+1	Toughness
5	+5	+4	+1	+1	Relentless Assault
6	+6	+5	+2	+2	Onslaught, Battle Cry
7	+7	+5	+2	+2	Toughness
8	+8	+6	+2	+2	Batter Foe
9	+9	+6	+3	+3	Batter Steel
10	+10	+7	+3	+3	Brutal Assault, Battle Cry

succeeds, the brute's foe freezes in place with fear and loses his Dexterity bonus to AC until his next action. At 6th level the brute may do this twice per day, and at 10th level he may use this ability three times per day.

Shield Breaker: At 3rd level, a brute's powerful attacks can cleave through an opponent's shield, leaving it a splintered wreck. When using the Power Attack feat (or his Improved Power Attack ability) the brute can smash a shield into pieces. When the brute attacks an enemy and misses, compare the brute's attack roll to his foe's shieldless AC. If the attack would hit, the brute has smashed into his enemy's shield instead, dealing damage to it as per the rules for attacking an object. Obviously, this ability has no effect against an enemy who does not carry a shield. However, if the brute's enemy uses the Expertise feat to improve his AC, the brute may break his foe's weapon. If the brute's attack would have hit his enemy had he not used Expertise, the brute hits his enemy's weapon and deals damage to it.

Generally speaking, if the brute's opponent uses a weapon or shield to improve his AC, the brute, the brute strikes that item if he would have otherwise hit the foe. If the brute's target has more than one weapon or shield that boosts his AC, the brute has an equal chance to hit either.

Relentless Assault: At 5th level, the brute's powerful assault leaves his opponent reeling and drives him back. Whenever the brute uses his Power Attack feat (or his Improved Power Attack ability), his target staggers back with the force of the brute's pummeling attack. If the brute hits his target or his equipment, the brute's enemy must immediately take a 5-foot step away from the brute, or take an additional 1d6 damage. In addition, the brute may immediately advance 5 feet, but doing so keeps his opponent in his threatened area.

The brute must choose to use this ability before making his attack.

Onslaught: At 6th level, the brute may now use his Power Attack at twice its normal efficiency. The brute may subtract a number from his melee

attack rolls equal to twice his base attack number. In conjunction with Improved Power Attack and Batter Foe, the brute becomes a devastating opponent.

Batter Foe: At 8th level, the brute's assaults allow him to pummel his foe senseless. When using his Power Attack feat (or his Improved Power Attack special ability) the brute may choose to deal subdual damage. While the brute may suffer a penalty to his attack roll, depending on his armament, he deals double subdual damage. If he scores a critical hit, stack this double damage with the critical multiplier as per the standard rules for stacking multipliers.

Batter Steel: At 9th level, the brute now deals double damage to shields, weapon, armor and any inanimate object with a hardness.

Brutal Assault: At 10th level, the brute has mastered the art of using his raw strength to overpower and smash his foes. When using the Power Attack feat, the brute now triples the bonus damage he receives. Furthermore, the brute may now destroy his target's armor. If the brute's attack misses and does not strike his foe's shield or parrying weapon, the brute may hit and damage his foe's armor. Compare the brute's attack roll to his opponent's AC without both shield and armor. If the brute's attack hits this AC, he deals damage to his opponent's armor. Note that the brute may only use this ability to damage a suit of armor. He may not damage magic items that provide a deflection bonus to AC, or other items aside from shields, weapons, or armor.

ELF TREERUNNER

Elves cherish their woodland homes, and take great pains to adequately defend them. The foremost defenders of these forest realms are the treerunners, warriors who combine deadly martial skills with knowledge of the ambient magic of all forests. Treerunners serve as scouts, messengers, and elite strike troops. With their specialized training, treerunners can rapidly move through the forest unseen by mortal eyes.

Treerunners occupy an honored place in the ranks of the elven military. While other soldiers may be more deadly, or take on more dangerous foes, none can rival a treerunner's skill in rapidly traversing the forest and springing ambushes upon the enemies. They serve as the first line of defense, and provide rapid support in battles scattered across the forest. Many invading hosts have fled the elven forests with tales of terrible warriors who swooped down from (and sometimes directly out of) the trees, only to strike and disappear before any defense against them could be organized. The treerunners' tactics have confounded many invading warlords, defending the whole forest almost simultaneously.

Hit Die: d10

Requirements

To become a treerunner, a character must meet the following requirements:

Base Attack Bonus: +5

Balance: 6 ranks.

Climb: 8 ranks.

Jump: 6 ranks.

Wilderness Lore: 4 ranks.

Feat: Lightning Reflexes, Track.

Race: Elf, or half-elf raised in an elf community.

Class Skills

The treerunner class skills (and the key ability for each) are Balance (Dex), Climb (Str), Handle

Animal (Wis), Hide (Dex), Intuit Direction (Wis), Jump (Str), Knowledge (nature) (Int), Listen (Wis), Move Silently (Dex), Spot (Wis), Swim (Str), and Wilderness Lore (Wis).

Skill Points at Each Level: 4 + Int modifier.

Class Features

All of the following are class features of the treerunner prestige class.

Weapon and Armor Proficiency: The treerunner gains proficiency with all simple and martial weapons and light armor.

Treerunning (ex): At 1st level, the treerunner masters the first of his order's secrets. First, he may climb up a tree simply by running or walking up the side of a trunk. The treerunner automatically succeeds any Climb check when scaling a tree, he may move up a tree at his regular movement rate, and he does not lose his Dex modifier or shield bonus to AC when climbing a tree.

Trackless Step: At 2nd level, the treerunner learns to walk with a lighter step and cannot be tracked through forests. A treerunner gains trackless step as a 3rd level druid.

Weapons of the Order: At 2nd level, the treerunner begins his elite training with the longbow. He gains the feat Weapon Focus (longbow) if he does not already have it.

Treewalking (su): At 3rd level, the treerunner further refines his ability to move within the forest.

ELF TREERUNNER ADVANCEMENT TABLE

Level	Attack	Fort	Ref	Will	Special
1	+1	+0	+2	+0	Treewalking
2	+2	+0	+3	+0	Trackless Step
3	+3	+1	+3	+1	Treerunning
4	+4	+1	+4	+1	Speak with Plants
5	+5	+1	+4	+1	Arboreal ally
6	+6	+2	+5	+2	Arboreal ambush
7	+7	+2	+5	+2	Darkvision
8	+8	+2	+6	+2	Arboreal Gate
9	+9	+3	+6	+3	Arboreal Gate
10	+10	+3	+7	+3	Arboreal Gate

The treerunner may stand upon the topmost, slender tree branches, or at the extreme edge of a lower tree branch without fear of falling. The treerunner learns how to mystically distribute his weight, allowing even the slimmest tree branch to hold his weight. The treerunner may only use this ability when standing on a tree, as part of this power relies on drawing upon the tree's magical aura to help focus his ability. Furthermore, the treerunner may leap from branch to branch as if both branches were solid surfaces, and at no penalty for leaping on to a small surface. The treerunner need only make a successful Jump check to leap across the distance between the two branches.

Speak with Plants (sp): At 4th level, the treerunner may cast the spell *Speak with Plants* three times plus his Wisdom modifier per day. His caster level is equal to his level in the treerunner prestige class.

Arboreal Ally (su): At 5th level, the treerunner learns to use the forest as an active ally in his battles. While fighting beneath a tree canopy, the treerunner may call upon the plants around him to help him in his battle. Tree branches thrash down upon the treerunner's foes, while roots reach up to entwine their feet. By using a standard action that does not draw an attack of opportunity, the treerunner can call upon the surrounding foliage to hinder his enemies. Treat this as an aid another action taken with a base attack bonus of +3 by the trees or other plant life in the area. The treerunner decides each round whether this aid another action grants a +2 bonus to hit or a +2 bonus to his AC. When the treerunner activates this ability, he must designate a single opponent for the plants to target. He must use another action to change to a different target. The treerunner may only use this ability against a single opponent at any one time.

Arboreal Ambush (su): At 6th level, the treerunner may merge his body with a tree's and temporarily hide within it. The treerunner gains a +15 circumstance bonus to all Hide checks while within the tree, and may observe everything

that happens around him with any senses normally available to him. The tree must have a diameter of at least three feet for the treerunner to hide inside of it. A treerunner may remain hiding in this manner for up to a total of 12 hours per day. Moving out of a tree is part of a regular movement action and takes up half of the treerunner's standard movement allowance. The treerunner may enter and exit as many trees per day as he wishes so long as he does not spend more than 12 hours in a single day inside trees.

If for any reason the tree is harmed, the treerunner suffers half the damage the tree suffered during the time he was hidden. He does not suffer this damage until he exits or is expelled from the tree.

Darkvision: At 7th level, the treerunner gains darkvision to 60 ft. If he already has darkvision, it increase by 30 ft.

Arboreal Gate (su): At 8th level, the treerunner gains access to the ultimate secret of his order. The treerunner may now step into one tree and step out of any other tree within the same forest. The treerunner channels his spirit throughout the forest, moving from tree to tree. When using this ability, the treerunner takes along all of the equipment and items he can carry upon his body. This travel is not instantaneous, taking a full action to move into the tree and 1d6 rounds to come out in another tree within line of sight. It takes another full round action to exit a tree on the other side of the forest. Furthermore, the treerunner must select a general destination before using this ability, and may not change directions during his voyage. The treerunner may use this ability three times plus his Wisdom modifier per day. In order to activate this ability, the treerunner must spend five minutes in peaceful meditation each morning to attune himself with the trees around him. Once this meditation is complete, he may move through any tree in the forest, without further meditation.

At 9th level, it takes 1d4 rounds to move from one tree to another and at 10th level it takes only 1

round. In addition, at 10th level he may move up 250 feet (he need not see the tree he intends to exit from) and it becomes a standard action to move into and out of a tree. If a treerunner exits a tree next to an enemy, that enemy is considered flanked until the treerunner's next action.

When using this ability, the square the treerunner moves from when moving into a tree does not count as threatened, nor does the square the treerunner moves into when leaving a tree.

EPIC ATHLETE

The Epic athlete strives to achieve physical perfection. He spends his days in intense training, lifting great weights to build his physique and running miles each day to improve his endurance. While most warriors rely on stout armor and heavy weapons to carry them through battles, the epic athlete needs no other weapons than his bare hands and his brutal strength. He studies the art of wrestling and is capable of taking on lions, bears, and even giants with no more than his bare hands.

Epic athletes enjoy the limelight. Many of them call upon a god of war, strength, or health as a patron. Their great physical deeds spread far and wide across the land, as their competitive spirits cannot refuse any contest of physical skill. Often, epic athletes congregate in small groups centered on a gymnasium or other training school. These groups often hold competitions that feature wrestling, javelin throws, races, and other sports. Epic athletes are tremendously competitive, and the victor of such contests gains fame and renown amongst his fellows and the commoners who often flock to witness the events.

In an army, epic athletes are too few in numbers to form units by themselves. Often, they serve as champions and leaders for units. Many nobles hire epic athletes to serve as bodyguards, while some go as far as to fund and promote gymnasiums in a bid to increase their own fame and renown.

Hit Die: d12



Requirements

To become an epic athlete, a character must meet the following requirements.

Base Attack Bonus: +5

Balance: 4 ranks

Climb: 6 ranks

Jump: 8 ranks

Swim: 6 ranks

Tumble: 4 ranks

Feats: Improved Unarmed Strike, Run, Toughness

Special: Because epic athletes seek physical perfection for all the wrong reasons, a monk may never become an epic athlete.

Class Skills

The epic athlete class skills (and the key ability for each) are Balance (Dex), Climb (Str), Escape Artist (Dex), Heal (Wis), Intimidate (Cha), Jump (Str), Listen (Wis), Perform (Cha), Ride (Dex), Spot (Wis), Swim (Str), and Tumble (Dex).

Skill Points at Each Level: 4 + Int modifier.

Class Features

All of the following are class features of the epic athlete prestige class.

Weapon and Armor Proficiency: The epic athlete gains proficiency with all simple and martial weapons, but does not gain any special knowledge of armor. The epic athlete may use his special abilities only if he wears light or no armor.

Brawler: The epic athlete relies on his prodigious physique and conditioning to carry him through battles, preferring to pummel his foes senseless rather than rely on something as cowardly as a sword or bow. At 1st level, the epic athlete deals normal damage with his unarmed attacks. Furthermore, his attacks deal more damage than normal, as listed under the Punching Damage column below. An epic athlete makes unarmed attacks using his normal base attack bonus.

Fame: At 1st level, the epic athlete's deeds precede his journeys. His massive physique and intimidating air give him an advantage in social situations. When making a Charisma check, or when using a skill with Charisma as its key ability, the epic athlete gains a +2 competence bonus to his roll.

Improved Speed: At 2nd level, the epic athlete's physical training allows him to move faster than normal. His base speed increases by +10 ft. This bonus stacks with any improved movement granted by other classes. In addition, multiply his improved base speed to determine his double movement rate or running speed.

Far Throw: At 3rd level, the epic athlete is adept at hurling weapons to a great distance. Double the range increment of the epic athlete's thrown weapons. If the epic athlete has the Far Shot feat, triple the range increment.

EPIC ATHLETE ADVANCEMENT TABLE

Level	Attack	Fort	Ref	Will	Special	Unarmed Damage
1	+1	+0	+2	+0	Brawler, Frame	1d4
2	+2	+0	+3	+0	Improved Speed	1d4
3	+3	+1	+3	+1	Far Throw	1d6
4	+4	+1	+4	+1	Grappler	1d6
5	+5	+1	+4	+1	The Epic	1d8
6	+6	+2	+5	+2	Prodigious leap	1d8
7	+7	+2	+5	+2	Giant Killer	1d10
8	+8	+2	+6	+2	Bear Hug	1d10
9	+9	+3	+6	+3	Hearty Constitution	1d12
10	+10	+3	+7	+3	Epic Health	1d12

Grapppler: The epic athlete is a master of wrestling. At 4th level, he no longer provokes an attack of opportunity when he initiates a grapple or when he moves into his target's square. In addition, he gains a +2 competence bonus to all grapple checks, and uses his improved unarmed damage when he chooses to damage a grappled opponent. Optionally, the epic athlete may deal subdual damage at no penalty to his grapple check.

The Epic: At 5th level, the epic's amazing constitution and health reach impossible heights. When rolling hit points (at this level and every level afterwards) for any class, the athlete rerolls 1's, and 2's. At 8th level, he also rerolls 3's.

Prodigious Leap: At 6th level, the epic athlete's training and focus allow him to leap far further than normal. When making a Jump check, his jumping distance is no longer limited by his height. In addition, he gains a +4 competence bonus to all Jump checks while in light armor and unencumbered.

Giant Killer: At 7th level, the epic athlete learns to use his tremendous strength and bulk to overpower his opponent when wrestling. For the purposes of resolving grapple attacks, the epic athlete counts as one size category larger, allowing him to grapple opponents who are up to three size categories larger than his own. Furthermore, the epic athlete learns to leverage his strength against giant opponents. Against humanoid foes who are more than three sizes larger than the epic athlete, he may choose to flip his opponent prone or reduce the foe's speed by half.

Bear Hug: At 8th level, when grappling, the epic athlete can crush his foe in a tremendous bear hug. First, the epic athlete must grapple and deal damage to his opponent. On his next round, he makes an opposed grapple roll against his foe. If he succeeds, he crushes his enemy in a deadly bear hug. The athlete deals double unarmed damage. Furthermore, he immobilizes his victim, who may only take free actions. Each round, the epic athlete may attempt to

maintain the bear hug by winning an opposed grapple check against his enemy. Maintaining a bear hug is a full-round action.

The epic athlete may only attempt to bear hug opponents who are one size category larger than him or smaller.

Hearty Constitution: At 9th level, the epic athlete's superior health garners him improved awareness and fortitude. He gains a +4 competence bonus to all non-magical saving throws.

Epic Health (ex): At 10th level, the epic athlete achieves the apex of physical perfection. He gains immunity to disease and poison and regenerates a number of hit points per hour equal to his Constitution bonus.

FOOTMAN

On the battlefield, gnomes, goblins and other small humanoids face several distinct disadvantages. The small humanoids' short reach, poor physical strength, and slow movement pose trouble against many common enemies, such as orcs or hobgoblins, and while most gnomish armies rely on magic and complicated war machines to help even the odds, freelance small warriors on the other hand have access to none of the tools and advantages that an entire gnome army can field. Mercenary companies prefer to employ gnomes for their magical or engineering skills. To keep their skills in demand and to help boost the fees they command, many small warriors learn to perfect the art of fighting in close ranks with larger allies. While a group of gnomes or halflings in formation rely on many of the same tactics and principles used by massed human or dwarf forces, gnomes deployed in concert with human, elf, dwarf, or other, taller warriors develop a unique set of skills that enhance both their own and their allies' effectiveness.

Footmen are small warriors who learn to support and aid taller warriors. On the battlefield they stand in extremely close ranks with other, taller warriors, working to improve their defense and to time their

attacks so that the footman's blows come just as his ally's have left the enemy reeling or off-balance. Mercenary companies greatly value halfling and gnome footmen, as a single footman working with another soldier creates a team far more skilled than the two warriors working alone.

Hit Die: d8

Requirements

To become a footman, a character must meet the following requirements.

Base Attack Bonus: +3

Feat: Dodge, Expertise

Size: Small

Class Skills

The footman class skills (and the key ability for each) are Climb (Str), Craft (Int), Jump (Str), Profession (Int), Ride (Dex), Swim (Str), and Tumble (Dex).

Skill Points at Each Level: 2 + Int modifier.

Class Features

All of the following are class features of the footman prestige class.

Weapon and Armor Proficiency: The footman gains proficiency with all simple and martial weapons, shields, and armor.

Support Ally: Gnome and halfling footmen are experts at working with larger warriors in close quarters. However, trained goblins and kobolds also benefit from a master's tutelage. Due to their size and specialized training, a footman may occupy the same space as a medium-size or larger ally without hindering either his ally's or his own fighting ability. While using this ability,

the footman must fight with a weapon smaller than medium size. Medium or larger weapons require too much space to use for a footman to make proper use of them when closely supporting another. Otherwise, the footman may take all actions as normal, including attacking, using an item, casting a spell, and so on. Moving into his ally's square counts as a normal movement action for the footman. He moves into that square just as he would any other, unoccupied space.

For the purposes of the footman's abilities described below, the footman's ally is the friendly character whose space the footman occupies. Essentially, to gain any of these bonuses the footman must stand in the same square as a friendly PC or NPC. The footman cannot occupy the same space as an unfriendly character or anyone else who refuses to work with him. If the footman's ally turns against him, the footman must immediately move out of his current square or all his attacks that are not directed at his former ally are at a -2 competence penalty to hit. The footman may attack his former ally as normal.

This ability assumes that the footman's ally occupies at least a five foot by five foot area. The DM may rule that the footman may not occupy the same space as his ally under special conditions (example: if Rodrigo the rogue leaps atop a small, round table, Erzzerod the gnome footman cannot clamber atop the table and use this ability with Rodrigo; there simply is not enough space on the tiny table for the two of them to work effectively as a team). Generally speaking, an open, five foot by five foot area provides enough room for the footman and his ally to operate normally.

FOOTMAN ADVANCEMENT TABLE

Level	Attack	Fort	Ref	Will	Special
1	+1	+2	+0	+0	Shield Ally, Support Ally, Coordinated Strike +1
2	+2	+3	+0	+0	Protect Ally
3	+3	+3	+1	+1	Coordinated Strike +2
4	+4	+4	+1	+1	Defend Ally
5	+5	+4	+1	+1	Coordinated Strike +3



When the footman supports an ally that takes up more than one five foot by five foot square on the battlefield, such as a centaur or dragon, the footman's abilities and bonuses only work against enemies who stand within his threatened area. For example, the footman may only lend his shield ally AC bonus to help defend against attacks from enemies within the footman's threatened area.

Shield Ally: At 1st level, when a footman occupies the same space as an ally, he can help his friend defend himself against missile and melee attacks. If the footman spends a move-equivalent action aiding his ally's defense, he grants him a +1 dodge bonus to AC by warding off attacks with his shield or parrying them with his weapon. The footman must end his turn in his ally's space for this bonus to take effect.

Coordinated Strike: The footman learns to match his ally's fighting style and times his blows to come just as his ally's strike has left their mutual opponent off-balance or otherwise exposed. At 1st level, the footman gains a +1 competence bonus to hit and damage when he strikes the same target that his ally last attacked. At 3rd level this bonus

increases to +2. At 5th level, it rises to +3 and the footman so perfectly times his strike that he catches his foe flatfooted.

Protect Ally: Not only can the footman help ward off blows meant for his ally, but he can also place himself in harm's way and absorb strikes meant for his ally. At 2nd level, if the footman's ally takes an action that draws an attack of opportunity, the footman may use a move-equivalent action to force his opponent to target the footman rather than the footman's ally with his attack. The footman leaps in front of the blow or otherwise draws his enemy's attention away from his ally. Typically, the footman must ready his action to use this ability in response to an attack of opportunity.

Defend Ally: Not only does the footman provide additional defense for his ally, but he also gives a second set of eyes to watch for unexpected attacks. At 4th level, opponents cannot flank the footman and his ally so long as they occupy the same square. The two of them work together to put up a unified defense that denies their opponents any easy strikes. This ability automatically takes effect so long as the footman and his ally remain in the same square.

GUTTER FIGHTER

Most commanders look upon halflings as pathetic, cowardly fighters. Their small size and often pragmatic outlook on combat (what less polite societies refer to as “cowardice”) result in would-be conquerors and other invaders overlooking those traits that make halflings dangerous opponents. No race is quite so skilled at slipping unseen into enemy camps, or attacking from ambush. Halflings’ stealth is unparalleled, and as a race, halflings center their tactics on trickery and ambushes rather than open combat. Those who venture into halfling lands face bands of snipers, continual ambushes, and other nuisances that wear away at their horde’s willingness to fight.

Halfling gutter fighters are the personification of what passes as the halfling warrior ethos. Earning that sobriquet from opponents who see their tactics as cowardly and dishonorable, the gutter fighters specialize in striking from stealth and using their height as an advantage in combat. Gutter fighters use their height to strike at vulnerable points, such as the knee, ankle, or groin. Most human-sized warriors, used to fighting opponents of their own size, fall quickly before the gutter fighters’ unorthodox, no-holds-barred tactics.

Halflings aren’t the only race capable of becoming gutter fighters. Gnomes, goblins, and kobolds all have their share of fighters who aren’t

afraid to twist a knee or poke an eye in order to take down an enemy.

Hit Die: d10

Requirements

To become a gutter fighter, a character must meet the following requirements.

Base Attack Bonus: +5

Intimidate: 6 ranks

Hide: 6 ranks

Feat: Weapon Finesse

Alignment: Any non-good.

Size: Small

Class Skills

The gutter fighter class skills (and the key ability for each) are Bluff (Cha), Climb (Str), Craft (Int), Escape Artist (Dex), Hide (Dex), Intimidate (Cha), Jump (Str), Listen (Wis), Move Silently (Dex), Pick Pocket (Dex), Profession (Int), Search (Int), Spot (Wis), Swim (Str), and Tumble (Dex).

Skill Points at Each Level: 4 + Int modifier.

Class Features

All of the following are class features of the gutter fighter prestige class.

Weapon and Armor Proficiency: Gutter fighters are proficient with all simple and martial weapons, shields, and armor.

GUTTER FIGHTER ADVANCEMENT TABLE

Level	Attack	Fort	Ref	Will	Special
1	+1	+2	+0	+0	Dirty Blow
2	+2	+3	+0	+0	Stike and Fade
3	+3	+3	+1	+1	Sneak Attack +1 d6
4	+4	+4	+1	+1	Dodge
5	+5	+4	+1	+1	Scaling the Mountain
6	+6	+5	+2	+2	Sneak attack +1d6, +2 Natural Armor
7	+7	+5	+2	+2	Hobbling Strike
8	+8	+6	+2	+2	Uncanny Dodge (Dex bonus to ac)
9	+9	+6	+3	+3	Sneak attack +1 d6, +3 Natural Armor
10	+10	+7	+3	+3	Agonizing Strike

WARS MAKE SOLDIERS

Dirty Blow: At 1st level, the gutter fighter's small stature gives him an advantageous perspective on the humanoid anatomy. In melee combat with medium size or larger foes, the gutter fighter uses his small size to his advantage, striking at his enemy's knees, ankles, and vital organs. Against these enemies, the gutter fighter deals +2 points of damage on each successful hit. Note that this bonus applies only to humanoid opponents, those with the same basic body arrangement as a human. Against other foes, the gutter fighter's knowledge of weak spots and sensitive areas is useless. Any creature unaffected by critical hits is immune to this ability.

Strike and Fade: At 2nd level, the gutter fighter is an expert at making attacks from hiding. He strikes unseen, then quickly fades into the background. When firing a missile weapon from

hiding, the gutter fighter may remain hidden from view. Before firing, the gutter fighter must make a Hide check if has not already done so in the process of taking cover. Unlike most skill checks, however, the DM should make this one in secret and note the result. After each shot, the gutter fighter's Hide result (and thus the Spot DC needed to notice him) drops by 5. Normally, after a character attacks, his enemies may immediately notice him.

If the gutter fighter has the sneak attack ability, he gains this damage bonus while attacking from his hiding place.

Sneak Attack: The gutter fighter may sneak attack as per the rogue character class. At 3rd, 6th, and 9th level the gutter fighter's sneak attack damage increases by 1d6. This damage stacks with any sneak attack damage the gutter fighter gained from previous classes.



Dodge: At 4th level, the gutter fighter gains the Feat Dodge. If he already has this Feat, then the bonus increases to +2.

Scaling the Mountain: At 5th level, gutter fighters learn to target the throat, eyes, and other, upper areas of humanoid foes by leaping upon them. The gutter fighter uses belts, straps, and even an opponent's shield to rapidly clamber up and deliver a devastating blow. The gutter fighter makes either a Jump or Tumble skill check. His target then uses the result as the DC for a Reflex save. If the target makes the save, he pushes the gutter fighter aside and foils his attack. If the target fails the saving throw, the gutter fighter leaps upon his foe and delivers a wicked attack. The gutter fighter's opponent loses his Dexterity and shield bonuses to AC for this attack, and has the opportunity to deliver a sneak attack against his briefly helpless opponent. Using this ability counts as a full round action. The gutter fighter makes a single attack at his best base attack bonus. If the gutter fighter's opponent makes his saving throw, the gutter fighter makes a single, normal attack against his target.

Natural Armor: The speed and skill of a gutter fighter are as important as his ability to stay out of harms way. At 7th level, the gutter fighter gains a +2 natural armor class bonus. At 9th level, this bonus increases to +3.

Hobbling Strike: Small humanoids often run into trouble when fighting taller races because they

have trouble outrunning their foes. At 7th level, gutter fighters solve this problem by hamstringing or otherwise crippling their foes before turning to flee. In melee combat against a medium-size or larger humanoid foe, the gutter fighter may deliver an attack that slices his target's tendons, twists his joints, or otherwise makes it painful for him to walk. As a standard attack action, the gutter fighter makes a single attack against his enemy at a -6 penalty to the attack roll. Roll damage as normal. The gutter fighter's target must make a Fortitude save with a DC equal to the damage dealt. If the target fails, cut his movement rate in half. The target continues to move at this reduce rate until he receives a total amount of healing equal to the damage dealt by the hobbling strike.

Uncanny Dodge: At 8th level, the gutter fighter retains his Dexterity bonus to AC (if any) regardless of being caught flat-footed or attacked by an invisible attacker.

Agonizing Strike: At 10th level, the gutter fighter masters the art of pain. As a full round action, the gutter fighter may take aim at a particularly sensitive portion of his foe's anatomy in an attempt to leave him crippled in pain at a -4 penalty to the attack roll. Roll damage as normal. The gutter fighter takes a single attack. If he hits, his opponent must make a Fortitude save with a DC equal to the damage dealt. If he misses this saving throw, the gutter fighter's foe collapses in agony for

KNIGHT CHAPLAINS ADVANCEMENT TABLE

Level	Attack	Fort	Ref	Will	Special
1	+0	+2	+0	+2	Free Feats
2	+1	+3	+0	+3	Healing Focus
3	+2	+3	+1	+3	Bonus Feat
4	+3	+4	+1	+4	Field Medic
5	+3	+4	+1	+4	Healing Under Fire
6	+4	+5	+2	+5	Bonus Feat
7	+5	+5	+2	+5	Healing Under Fire
8	+6	+6	+2	+6	Last Rites
9	+6	+6	+3	+6	Bonus Feat Healing Focus
10	+7	+7	+3	+7	Combat Healing

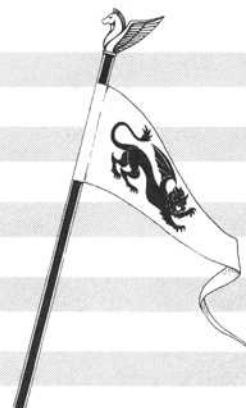

Spells per Day:

Knight's Level	0	1	2	3	4	5
1	3	1	—	—	—	—
2	4	2	—	—	—	—
3	4	2	1	—	—	—
4	5	3	2	—	—	—
5	5	3	2	1	—	—
6	5	3	3	2	—	—
7	6	4	3	2	1	—
8	6	4	3	3	2	—
9	6	4	4	3	2	1
10	6	4	4	3	3	2

1d4 rounds. During this time, he is completely helpless, falls prone, loses all Dexterity and shield bonuses to AC, and may take no actions. During this time, anyone may make a *coup de grace* attack upon this foe. This attack penalty increases by two for each successive use in a single combat encounter as opponents take care to guard against it.

KNIGHT CHAPLAINS

The Knights of the Dove are a military order that teaches a unique brand of arcane magic. The knights, much like any other military order, study the art of war and train with a wide variety of weapons. In addition, they master a set of magical spells that allow them to heal the wounded and attend to the injured in battle. Knight chaplains march to war alongside other warriors, often taking a spot at the front line and fighting shoulder to shoulder with elite units.

Most generals eagerly except knight chaplains into their ranks. The order's masters make few judgments on the moral character or motives of their students, viewing all warriors as equally deserving of the order's secrets. So long as a potential knight can prove some skill at arms and with the healing arts, he can petition for membership in the order.

Many lords and generals dispatch squads of volunteers to receive the order's training. The elders observe a strict policy of nonviolence within the order's isolated mountain fortress, and expect their

students to observe it unflinching. With warriors from several nations (and even the occasional hobgoblin or blackguard) applying for training, the elders often spend more time keeping their students from tearing each other's throats out rather than instructing them in the arts of healing.

In battle, knight chaplains provide front line healing. After a battle, their skills are even more important as many of their spells allow them to locate, care for, and transport the wounded. Many knight chaplains know that each time they march into battle they face two foes: the enemy they meet in battle and the wounds they struggle to heal in the aftermath. When most warriors set about looting, or slump down to rest, the Knight of the Dove's struggle is only half over.

Hit Die: d8

Requirements

To become a knight chaplain, a character must meet the following requirements:

Base Attack Bonus: +5

Concentration: 4 ranks

Heal: 4 ranks

Feat: Skill Focus (heal)

Class Skills

The knight chaplain class skills (and the key ability for each) are Alchemy (Int), Concentration (Con), Craft (Int), Heal (Wis), Listen (Wis), Ride (Dex), Search (Int), and Spot (Wis).

Skill Points at Each Level: 4 + Int modifier.

Class Features

All of the following are class features of the knight chaplain prestige class.

Weapon and Armor Proficiency: A knight chaplain gains proficiency with all simple weapons, shields, and all armor.

Spells: Knight chaplains learn a unique form of arcane magic that allows them to heal wounds and tend to the sick. A knight subtracts 25% from the arcane spell failure chance of the armor he wears. Knight chaplains use arcane magic and thus their Intelligence score to determine bonus spells, save DCs, and so forth.

Spellbook: Knight chaplains maintain spellbooks much in the same manner as wizards. The knight starts with all zero-level spells and a total number of first-level spells equal to 3 + his Intelligence modifier in his book. For each level gained in this class, he automatically adds one spell from the knight chaplain spell list to his book. A knight may scribe spells into his books as per the rules for wizards and their spellbooks. Knight chaplains cannot prepare or cast spells that do not appear on their list.

Because of the nature of the magic and the secret method in which it is taught, knights cannot share their spellbooks and cannot learn from scrolls or other spellbooks. Additionally, knight chaplain healing spells do not harm undead the way divine spells do.

Free Feats: At 1st level, a knight chaplain gains the feats Combat Casting and Skill Focus (concentration) for free.

Healing Focus: At 2nd level, the knight's effective spell casting level is augmented for healing. When calculating caster level for Conjunction (Healing) spells, increase the knight chaplain's level by 3. For example, a 10th level Cleric/5th level knight chaplain casts cure light wounds as a 10th level cleric when casting divine spells or as an 8th level knight when casting arcane versions.

At 9th level, his effective casting level increases by 5 for these spells.

Bonus Feats: At 3rd, 6th, and 9th level the knight chaplain gains a bonus feat chosen from the same list of bonus feats available to the fighter class.

Field Medic: At 4th level, when a knight chaplain uses the Heal skill to bind wounds, the effects of natural healing are tripled instead of doubled per the rules in the PHB.

Healing Under Fire: At 5th level, the knight chaplain learns to work his magic even while sorely pressed by enemy assault. When the knight casts a Conjunction (Healing) spell, he does not draw an attack of opportunity for casting the spell. The knight learns to maintain his guard when working this specific set of spells. If the knight has access to curing spells from other classes, he still draws attacks of opportunity, if applicable, when casting those spells.

Healing Touch: At 7th level, a knight chaplain can now heal at a distance. All Conjunction (Healing) spells cast by the knight have their range, effect, and area increased by 10 ft. Effectively, touch spells may now be cast at 10 ft. (although they still require a touch attack roll) and healing circle's effective area is now a 30-ft.-radius burst. If the knight has access to curing spells from other classes, he does not gain this bonus on those specific spells.

Last Rites (su): At 8th level, the knight chaplain may administer the last rites to a dying person. Those the chaplain tends to have a peaceful death and do not rise as undead due to an undead's supernatural ability, Necromatic spells such as *animate dead* still work, however, but lay no claim to the deceased's soul.

Combat Healing: At 10th level, the knight chaplain unlocks the full potential of his order's carefully crafted healing magic. When he casts a Conjunction (Healing) spell he may do so as a move-equivalent action. Thus, the knight may cast a cure spell and attack in the same round. If the knight has access to curing spells from other classes, he must still use a standard action to cast those specific spells.

Level 0 Spells: *create water, cure minor wounds, detect poison, light, mage hand, mending, resistance.*

Level 1 Spells: *alarm, bless, cure light wounds, deathwatch, enlarge, entropic shield, expeditious retreat, message, obscuring mist, reduce, sanctuary, shield, unseen servant.*

Level 2 Spells: *aid, blur, calm emotions, cure moderate wounds, delay poison, endurance, gentle repose, lesser restoration, protection from arrows, remove paralysis, shield other, whispering wind.*

Level 3 Spells: *create food and water, cure serious wounds, displacement, fly, negative energy protection, remove blindness/deafness, remove disease, slow, speak with dead.*

Level 4 Spells: *cure critical wounds, death ward, freedom of movement, locate creature, minor globe of invulnerability, neutralize poison, status.*

Level 5 Spells: *break enchantment, healing circle, prying eyes, raise dead, remove curse, sending, spell resistance.*

LANCER

"Any man can use a sword. You just stick the sharp end in the other fellow. A polearm on the other hand... that takes a true artist. Mostly because a true artist is smart enough to realize it's better to keep the other fellow far enough away that he can't stick you with his sword..."

— Hekur the Prudent

Some warriors feel the best strategy is to hit their opponent's first. Others feel it is best to never let their opponents hit them at all, dancing out of reach and using superior reach to strike from afar. For these individuals, no weapon can compare to the polearm. Simple in design, weapons such as the glaive and ranseur provide a wide array of versatility for a warrior who has mastered their use. Reach weapons not only provide a decided advantage in combat, but also require a fair degree of skill to master properly. A true lancer combines years of training with extraordinary acrobatic prowess and good common sense, and often comes through a battle completely unscathed.

Fighters become lancers more often than any other class, though the occasional multiclass rogue or barbarian also explores the potent combination of mobility and power the polearm offers.

Hit Dice: d10

Requirements

To qualify to become a lancer, a character must fulfill all the following criteria.

Base Attack Bonus: +6

Jump: 4 ranks

Tumble: 4 ranks

Feats: Dodge, Mobility, Skill Focus (jump), Weapon Focus (any polearm).

LANCER ADVANCEMENT TABLE

Level	Attack	Fort	Ref	Will	Special
1	+1	+0	+2	+0	Close Combat
2	+2	+0	+3	+0	Pole Vault
3	+3	+1	+3	+1	Extra Critical +1
4	+4	+1	+4	+1	Defensive Spin
5	+5	+1	+4	+1	Extended Reach
6	+6	+2	+5	+2	Set for Blood
7	+7	+2	+5	+2	Double Attack
8	+8	+2	+6	+2	Extra Critical +2
9	+9	+3	+6	+3	Spearpoint
10	+10	+3	+7	+3	Spin Attack

Class Skills

The lancer's class skills (and the key ability for each skill) are Balance (Dex), Climb (Str), Craft (all skills, taken individually, Int), Handle Animal (Cha), Jump (Str), Ride (Dex), Swim (Str), Tumble (Dex). See Core Rulebook I for skill descriptions.

Skill Points at Each Level: 2 + Int modifier.

Class Features

All the following are class features of the lancer prestige class.

Weapon and Armor Proficiency:

Lancers are proficient in all simple and martial weapons. They are also proficient in light and medium armor.

Note: The abilities of this prestige class make many references to polearms. For the mechanical purposes of these abilities, a "polearm" is any reach weapon composed of a long shaft with a slashing or piercing blade on the end. This includes the heavy lance, glaive, guisarme, longspear, and ranseur from the Player's Handbook. The DM may add other reach weapons to this list from other sourcebooks at his discretion.

Close Combat: At 1st level, the lancer has already learned to use the entire length of his weapon more effectively, drawing it closer to his body so that he may fight opponents at close range. He may attack adjacent opponents with a reach weapon.

Pole-Vault: At 2nd level the lancer learns to use his polearm as an acrobatic balance and vaulting tool as well as a weapon. Any Jump, Balance, or Tumble checks made while holding a polearm in both hands gain a circumstance bonus equal to the lancer's level.

Extra Critical: At 3rd level, the lancer learns to maneuver his weapon so that he can score more devastating blows. The critical threat range of any polearm is increased by one (from 20 to 19-20, for example). This bonus is applied after any other modifiers to the weapon's threat range from feats or spells. At 8th level, the threat range of the weapon increases by one again, applied in the same manner.

Defensive Spin: At 4th level, the lancer learns to spin his polearm in a distracting defensive blur. When performing the total defense action, the lancer gains an additional dodge bonus to AC equal to his Strength modifier. When fighting defensively, he gains an additional dodge bonus to AC equal to half his Strength modifier (round down).

Extended Reach: At 5th level, the lancer gains sufficient control over his weapon that he may extend its reach even further than normal, at the cost of accuracy. Any polearm he wields has its reach increased by 5 feet, but suffers a -4 circumstance penalty to all attack rolls when striking opponents beyond the normal reach. **Set For Blood:** At 6th level, the lancer gains the ability to work even greater leverage into his weapon. When setting a polearm against a charge, he does double damage. If the weapon already does double damage when set against a charge, it now does triple damage.

Double Attack: At 7th level, the lancer can shore up his weapon and use both ends against an opponent. This allows him to wield a polearm as a double weapon, inflicting 1d6 bludgeoning damage with the blunt end (the blunt end does not have reach). He may attack as if he had the Ambidexterity and Two-Weapon Fighting feats while using a polearm as a double weapon, even if

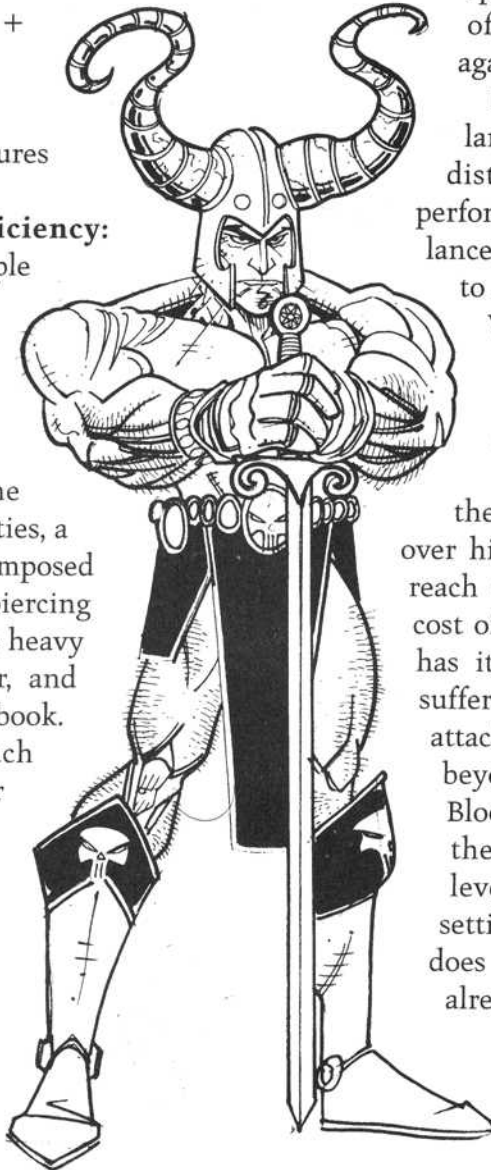

he would not normally meet the prerequisites for these feats. A lancer with this ability may also choose to gain the Improved Two Weapon Fighting feat even if he does not have the other prerequisites, though he may only make use of this feat while wielding a polearm as a double weapon. This ability may not be used in the same round as the Extended Reach ability.

Spearpoint: As a full attack action, the lancer can lodge the piercing or slashing end of a polearm into an opponent of Small or larger size. If the lancer strikes successfully, he may spear his opponent, rendering him immobile. This attack provokes an attack of opportunity from the attacker, so it is best done while the lancer is well out of reach. Once the lancer strikes his opponent, he begins a grapple as a free action. The lancer maintains the grapple as per the normal rules, except he does not move into the opponent's square, and if he chooses to damage his opponent, he does so with the slashing or piercing end of the polearm. If the polearm is destroyed, the grapple is broken.

Spin Attack: At 10th level, the lancer has learned to swing his weapon in broad, sweeping arcs. If the lancer successfully strikes an opponent with a polearm, he immediately gains another attack at the same attack bonus against another opponent the same distance away. He may gain a number of extra attacks per round with this ability equal to his Dexterity modifier (minimum one).

MERCENARY CAPTAIN

The mercenary captain is a grizzled veteran serving in a leadership position within a mercenary band or troupe. They are usually intolerant of mistakes from faulty or naive comrades. As their martial skills approach perfection, this intolerance grows. All traces of their youthful innocence disappear in the wake of their battle-hardened way of life. No matter good, neutral, or evil, all respect order and the tenants of law. The military unit thrives on order. They are as likely to use one weapon as another, but the vast majority prefer martial weapons, with a few favoring exotic weapons. Exceptional mercenary captains receive fame for specific weapons they have mastered, sometimes naming their mercenary band after the mythical blade (Hrothgar's Hammers, the Fist of Morgan, Captain Ragnar's Flashing Steel).

The mercenary captain is a professional soldier and a master tactician, selling his skills to the highest bidder. He usually cares nothing for nations, beliefs, or causes, only his coin purse and patron are important to him (in that order). He spends his time training soldiers and new recruits, leading men into battle, and spending his hard-earned coin. In all situations, he takes full advantage of his wealth of knowledge, extensive experience, and finely honed martial might.

Hit Dice: d10

MERCENARY CAPTAIN ADVANCEMENT TABLE

Level	Attack	Fort	Ref	Will	Special
1	+1	+2	+2	+1	Grizzled, War Cry
2	+2	+3	+3	+1	Attack Drill
3	+3	+3	+3	+1	Battle Music 1
4	+4	+4	+4	+2	Strategic Mastery, Attack Drill 2
5	+5	+4	+4	+2	Battle Music 2
6	+6	+5	+5	+2	Strategic Mastery, Attack Drill 3
7	+7	+5	+5	+3	Without Hesitation
8	+8	+6	+6	+3	Attack Drill 4, Battle Music 3
9	+9	+6	+6	+3	Battle Brother
10	+10	+7	+7	+4	Attack Drill 5, Battle Master

Requirements

To qualify to become a mercenary captain, a character must fulfill all of the following criteria.

Alignment: Any lawful.

Base Attack Bonus: +7

Bluff: 4 Ranks

Intimidate: 6 ranks

Ride: 4 ranks

Sense Motive: 4 ranks

Feats: Improved Initiative, Leadership, Weapons Focus (any), Weapon Specialization (any).

Special: Typically, mercenary captains choose their fellows from the ranks of a mercenary band, promoted by a superior officer. If the PC has the resources, he may start his own mercenary band and become a mercenary captain in his own right, but this is rare.

Class Skills

The mercenary captain's class skills (and the key ability for each skill) are Bluff (Cha), Climb (Str), Innuendo (Wis), Intimidate (Cha), Listen (Wis), Perform (Cha), Ride (Dex), Search (Wis), Sense Motive (Wis), and Spot (Wis). See the PHB for skill descriptions.

Skill points at Each Level: 2 + Int modifier.

Class Features

Weapon and Armor Proficiency: Mercenary captains are proficient with all simple and martial weapons, and with all types of armor and shields.

Grizzled (ex): Due to their years of military service, battle experience, and the atrocities they've witnessed, mercenary captains are all but impervious to fear and battle anxiety. They receive a +6 morale bonus to all saves made against fear and fear effects, both magical and mundane. Further, they exude an aura of fearlessness that provides all allies within a 10 ft. radius a +2 morale bonus to their saves against fear and fear effects.

War Cry (su): When a mercenary captain shouts his war cry, it lifts the spirits of his allies and inspires them to new levels of courage and bravery in battle. This ability functions as the bardic ability to *inspire courage*. This bonus lasts a number of

rounds equal to the captain's Charisma modifier. This ability may be used once per day for every level the mercenary captain has attained.

Attack Drill: Mercenary captains spend countless hours in rigorous training. Those who serve may take advantage of his knowledge and expertise by following his lead. For a number of rounds equal to his Charisma modifier +1, the mercenary captain and all troops/allies within a 20 foot radius receive an expertise bonus to their attack and damage rolls. This bonus is +1 per two levels of mercenary captain. The mercenary captain may inspire his troops once per day at 2nd level, twice per day at 4th level, and so on.

Battle Music: Using a horn or bugle, the mercenary captain can convey orders to his troops and/or allies. With a Perform check (DC 15), the mercenary captain can, as a standard action, use his horn or bugle to issue any of the following orders:

Charge: The mercenary captain orders his troops/allies to charge into battle. On the round following the issuance of the order, all those allied with the mercenary captain within 100 feet receive a +4 morale bonus to initiative and can take the Charge action with double the usual bonuses and none of the standard penalties.

Retreat: The mercenary captain orders his troops/allies to retreat. On the round following the issuance of this order, all those allied with the mercenary captain within 100 feet may move 5 times their normal full move (without armor penalties) and without provoking attacks of opportunity. Once he issues this order, all those affected continue running (at a full run/sprint) for 1d6 rounds or until the mercenary captain issues a Regroup or Rally command.

Rally: The mercenary captain attempts to allow his troops to throw off the effects of fear or panic. Once sounded, all allies within 100 feet who are currently under the effects of fear, panic, etc. are allowed a new Will save to throw off the effects of the fear, panic, or compulsion. This new save is at the same DC of the original save or a DC 20, if there

was no initial save. Further, those affected are granted a +2 morale bonus to this save.

Regroup: This order allows the mercenary captain to pull all of his allies back into formation. Once this issue is ordered, the mercenary captain's allies may immediately break off from combat, without provoking attacks of opportunity, and move to surround the mercenary captain. They then move into formation and prepare for battle once again. On the round following the regrouping maneuver, all those who regrouped suffer a -2 readiness penalty to attack rolls.

Defend the Line: For two rounds following the issue of this order, all allies within 100 feet are granted an additional attack of opportunity against any enemies that enter the area that they threaten. This attack of opportunity does not count against the total number of attacks of opportunity that a character receives per round.

The mercenary captain may use Battle Music 2/day for Battle Music 1, 3/day for Battle Music 2, and 4/day for Battle Music 3. Each use of Battle Music allows one of the previously mentioned orders to be issued.

Tactical Superiority: A mercenary captain may, prior to the start of a battle, spend 6 rounds instructing his allies/troops in tactics for the upcoming battle. If uninterrupted, the mercenary captain and all those he instructed (up to ten men per mercenary captain level) benefit from a +3

competence bonus to attack and damage rolls. This benefit lasts for the duration of the battle, or until he issues a Retreat Order. The mercenary captain can use this ability 1/day per 3 levels of mercenary captain.

Strategic Master: The mercenary captain must spend 1 turn instructing his troops/allies, and he may only affect five per mercenary captain level. If the turn is uninterrupted, those instructed and the mercenary captain gain a +3 competence bonus to their AC. This bonus persists until the end of the battle, the mercenary captain sounds the retreat, or the combatant leaves combat. The mercenary captain may use this ability 1/day per 3 levels of mercenary captain.

Without Hesitation: At this level, the mercenary captain has reached such a level of prestige, reputation, and respect among his troops, that they obey his orders without hesitation or thought. To represent this, after a mercenary captain has sounded the Charge, all men that fall under his Leadership (per the feat) will not deviate from the battle in any way. They become completely immune to all fear/panic effects or compulsions. Until the battle ends or the mercenary captain sounds the Retreat, those who follow the mercenary captain will think of nothing other than battle and following the mercenary captain's commands to the letter. This ability is constant as long as a battle is

RAKE ADVANCEMENT TABLE

Level	Attack	Fort	Ref	Will	Special
1	+0	+0	+2	+0	Sneak Attack Damage
2	+1	+0	+3	+0	Taunt: Intimidate
3	+2	+1	+3	+1	Sneak Attack Damage +2d6, Bonus Feat
4	+3	+1	+4	+1	Taunt: Enrage
5	+3	+1	+4	+1	Sneak Attack Damage +3d6
6	+4	+2	+5	+2	Humiliating Strike, Bonus Feat
7	+5	+2	+5	+2	Sneak Attack Damage +4d6
8	+6	+2	+6	+2	Taunt: Stun
9	+6	+3	+6	+3	Sneak Attack Damage +5d6, Bonus Feat
10	+7	+3	+7	+3	Taunt: Rally

underway. The mercenary captain may use this ability any time he is in battle.

Battle Brother: The mercenary captain attracts two additional followers that are fanatically loyal to him. One, the lieutenant, carries a bugle and, as a free action may sound orders for the mercenary captain, allowing the mercenary captain to continue battle while his lieutenant sounds the orders. The lieutenant follows the rules for cohorts, but does not count as the captain's one cohort. The second is the standard bearer, who carries either the mercenary captain's personal standard or the regimental standard. The presence of the standard gives all those following the mercenary captain a +1 morale bonus to all saving throws. The mercenary captain and his two battle brothers are completely loyal to each other. While in combat, they will always stay together, and may each fight until -10 hit points as long as one of the others is locked in combat. When they reach -10 hit points, they immediately drop dead.

Battle Master: The mercenary captain is now the consummate leader and soldier, nearly perfect in all aspects of leadership and martial ability. At this point, his troops are fanatically loyal, even unto death. All those allied with him or under his command fight beyond 0 hit points, staying completely active until their hit point total reaches -10. Should they ever reach -10, they immediately fall dead. If the battle ends, and they are below 0, they fall unconscious immediately and are considered stabilized. Furthermore, as long as they can see the mercenary captain, or see the standard, they receive a +4 competence bonus to AC, attack rolls, and saving throws.

RAKE

Throughout the civilized world, haughty duelists known as rakes strut through city streets. Only their blades are as sharp as their wits, and many rakes take more pride in the width and breadth of their jibes than in their swordsmanship. Rakes are typically young nobles who live off their families'

fortunes. They spend their nights hopping from tavern to tavern, looking for any opportunity to throw down the gauntlet and demonstrate their skill in a duel. By day, they nurse their considerable hangovers and often, if bored enough, take the time to practice their skill at arms. While rakes lack the skill and discipline of a professional warrior, their caustic invective often helps even the odds in their frequent fights.

Most rakes lack the discipline or material needed to seek out military service. However, if a rake's home city faces invasion, these indolent warriors can be one of the city's greatest military assets. What they lack in pure combat skill they more than compensate for with their ability to rally their fellows and demoralize the enemy. Even the most terrifying invading army falters when a rake has sliced its leader's belt in two, leaving the poor warlord capering about the battlefield with his pants at his ankles.

Rakes rarely take up the adventuring life, but sometimes circumstances (such as an angry mob or vengeful magistrate irate over his daughter's seduction) drives a rake out of his beloved city's walls. Rakes can be tremendously irritating, but in combat, the same insults and wit that proved annoying at times of quiet can drive foes mad.

Hit Die: d6

Requirements

To become a rake, a character must meet the following requirements.

Base Attack Bonus: +4

Bluff: 8 ranks

Intimidate: 8 ranks

Feat: Expertise

Class Skills

The rake class skills (and the key ability for each) are Balance (Dex), Bluff (Cha), Climb (Str), Gather Information (Cha), Innuendo (Cha), Intimidate (Cha), Jump (Str), Perform (Cha), Pick Pocket (Dex), and Tumble (Dex).

Skill Points at Each Level: 4 + Int modifier.

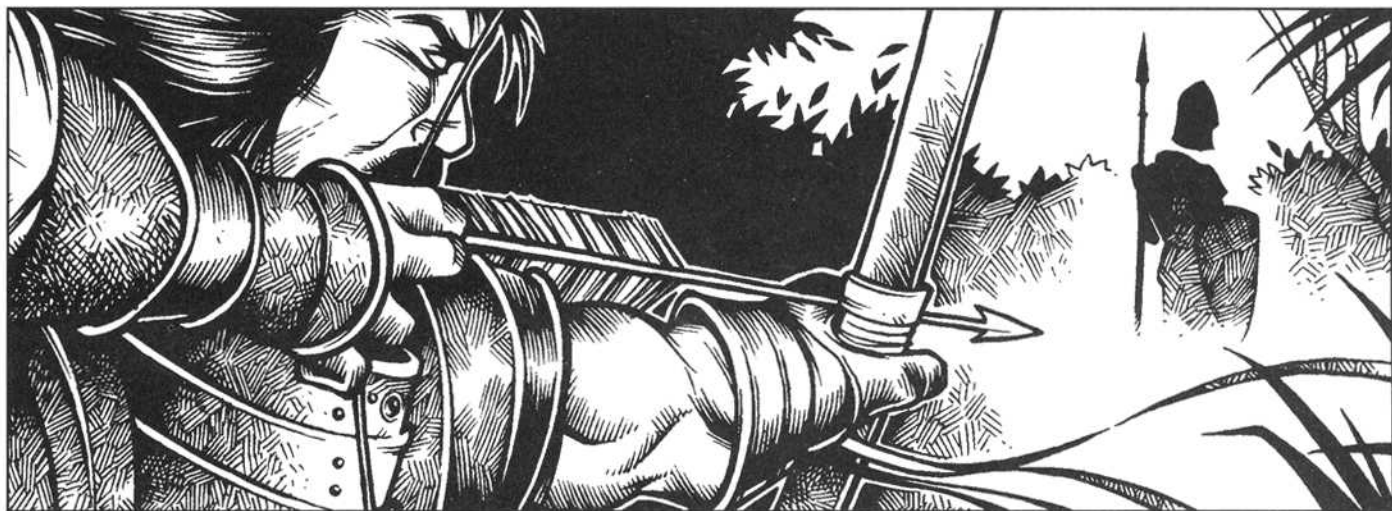

Class Features

All of the following are class features of the rake prestige class.

Weapon and Armor Proficiency: The rake gains proficiency with simple and martial weapons and light armor.

Sneak Attack Damage: Rakes rarely, if ever, fight far. When they see an opening in an enemy's guard, they exploit it to the utmost. Rakes gain sneak attack damage similar to a rogue. Whenever the rake's opponent loses his Dexterity modifier to AC, the rake deals extra damage. This bonus damage stacks with any sneak attack damage gained via any other classes, such as rogue or assassin.

Taunt: While the rake's blade is a deadly weapon, his repartee and cutting wit are just as useful, if not often more so, on the battlefield. Rakes trade not only cuts and parries with their enemies, but also an unending stream of insults, commentary on the melee, and incisive jibes. The rake relies on these to disrupt his enemy's concentration and rally his allies. At 2nd, 4th, 8th, and 10th levels the rake masters a different brand of taunt. The rake may use his taunts as a free action. Obviously, the rake must share a language with the target of his taunts for them to have any effect. A rake may use his taunt ability once per day for each level he has in the rake prestige class.

Intimidate: The rake disparages his opponent's fighting skill while demonstrating his own mastery with the blade. The rake makes an Intimidate skill attempt against an opponent that he is about to attack in melee. If he succeeds, his opponent suffers a -2 morale penalty to his attack rolls as long as the rake continues to attack him in melee.

Enrage: The rake makes cutting remarks about his opponent's lineage, his prowess, his wife's fidelity, or some other personal insult. This is an Intimidate skill attempt against an opponent he is about to attack in melee. If he succeeds, his opponent suffers a -2 AC morale penalty as he lunges at the Rake with little thought for his own safety.

Stun: The rake's ultimate insults so infuriate his foe that they temporarily freeze him in shock and outrage. The rake must make an Intimidate check. If he succeeds, the target of this ability loses his Dexterity bonus to AC until his next action. The rake may only use this ability once per encounter.

Rally: Not only can the rake's cutting remarks affect his foes, but he can also use them to energize his allies and spur them to redouble their attacks. This ability has two effects. First, it eliminates all morale penalties the rake's allies suffer from. Second, the rake's allies may add $+2$ to their current initiative counts, allowing them to catch their foes off-guard as they leap forward with renewed vigor.

Bonus Feats: At 3rd, 6th, and 9th level, the rake gains a bonus feat chosen from the same list of bonus feats available to the fighter class.

Humiliating Strike: The rake can calculate his attacks so that, while they leave his opponent unharmed, they leave no doubt to the observer as to who is the superior swordsman. In order to use this ability, the rake must be in melee with the effective leader of the group or unit he and his allies are fighting against. The rake spends a full round action to slash his initials into his opponent's chest, skewer his hat and toss it away, or cut apart his belt, forcing his pants to fall to his ankles. The rake makes a single attack at his highest base attack bonus. If he hits, the Rake's enemies all suffer a -1 morale penalty to hit for the rest of battle.

SHARPSHOOTER

The sharpshooter is an expert archer who can shoot an apple out of a man's hand or knock the hat off a passing merchant. Renowned for their deadly accuracy, sharpshooters command steep fees from mercenary captains, nobles, and others who wish to employ their services. Often, a sharpshooter serves as a sniper, raining punishing fire down upon the enemy and targeting their commanders for death.

Sharpshooters run the gamut from cold-blooded assassins who prefer to work from a distance to crack shots who have simply honed their talent to a razor's edge. Whatever their motivations, sharpshooters have proven their worth on countless battlefields. The mere rumor that the enemy has a sharpshooter on their payroll is often enough to keep most nobles and commanders under cover for the duration of a battle.

Hit Die: d8

Requirements

To become a sharpshooter, a character must meet the following requirements:

Base Attack Bonus: +5

Feats: Far Shot, Point Blank Shot, Precise Shot, Weapon Focus (any bow).

Alignment: Any lawful.

Class Skills

The sharpshooter class skills (and the key ability for each) are Climb (Str), Craft (Int), Handle Animal (Cha), Intimidate (Cha), Jump (Str), Ride (Dex), and Swim (Str).

Skill Points at Each Level: 2 + Int modifier.

Class Features

All of the following are class features of the sharpshooter prestige class.

Weapon and Armor Proficiency: A sharpshooter gains proficiency with all simple weapons and light armor.

Eagle Eye Shot: At 1st level, if the sharpshooter spends a full round action to take a single shot, he doubles his Dexterity modifier for ranged attacks for a single attack. In addition, he ignores his target's AC bonus due to size, if any. This ability only cancels an AC bonus, not an AC penalty due to size. At 6th level, this bonus is tripled.

Low-light Vision: At 2nd level, the sharpshooter's eye is trained to fire at night. He gains low-light vision. If he already has low-light vision, he instead gains darkvision up to 30 ft.

Disarming Shot: At 3rd level, the sharpshooter may use the disarm attack action with a ranged weapon. He aims for the weapon itself or strikes his foe's hand, forcing him to drop his weapon. Resolve the attack as normal, except that this version of disarm provokes an attack of opportunity as per a standard missile attack. If this attack fails, the sharpshooter's target does not receive a chance to disarm him.

Bonus Feat: At 4th and 8th level, the sharpshooter may pick a bonus feat from the following list: Exotic Weapon Proficiency, Improved Critical, Improved Initiative, Mounted Archery, Quick Draw, Rapid Shot, Shot on the Run, or Weapon Focus. Exotic Weapon Proficiency, Improved Critical, and Weapon Focus must be chosen for use with a ranged weapon.

Stumbling Shot: At 5th level, the sharpshooter may make a trip attack with a ranged weapon by

striking an opponent's knee or other critical portion of his legs. Resolve a ranged trip attack as a standard missile attack, not a touch attack as per the melee action. The attacker in this case is considered medium-size for purposes of resolving the attack. Obviously, if this attack fails the sharpshooter is in no danger of being tripped.

Intimidating Shot: At 6th level, the sharpshooter's startling accuracy can strike fear into his enemies. The sharpshooter may fire a shot at an opponent in order to scare him off rather than injure him, such as by barely grazing his skull, shooting off his foe's banner or holy symbol, or otherwise demonstrating his prowess. Resolve this attack as normal. If it hits, the sharpshooter may immediately make an Intimidate skill check against his target with a +4 competence bonus.

Covering Fire: At 7th level, the sharpshooter can hinder his opponent's attacks by laying down a concentrated burst of fire. This ability takes on two forms: the sharpshooter can use the aid another combat action with a missile weapon, or he can use this ability to neutralize attacks of opportunity. If the sharpshooter delays his action until an ally's turn, he may provide that ally with covering fire. Whenever that particular ally is the target of an attack of opportunity, the sharpshooter may fire at the attacker. If he hits, he does no damage but his target flinches under the sharpshooter's fire and loses his attack of opportunity. The sharpshooter

may take the full attack action in order to take multiple covering shots. If his ally's move ends and the sharpshooter still has unresolved attacks, those attacks are wasted. The sharpshooter may only take one shot to disrupt each attack of opportunity.

Immobilizing Shot: At 9th level, the sharpshooter becomes so accurate with his bow that he can drive an arrow through his foe's foot or arm, spiking him into place. This attack requires a full attack action that allows the sharpshooter to take a single shot at his highest base attack bonus. If the attack hits, the defender takes damage as normal and must make a Strength check (DC 5 + damage dealt by this attack); failure causes immobility as the sharpshooter's attack roots the defender to the spot. The defender may take most actions as normal, but if he wants to move out of his current spot he must either make a Strength check (DC 5 + damage dealt by this attack) or he must spend a standard action to remove the arrow. While immobilized, the defender loses his Dexterity bonus to AC, if any.

The sharpshooter may only use this ability if he is using ranged weapons which deal piercing damage.

Killing Shot: At 10th level, the sharpshooter is now so well-versed in hitting exact spots that whenever he hits a foe with a shot from a bow or crossbow, he always applies that weapon's critical multiplier to the damage roll. If the sharpshooter scores a critical hit, stack the weapon's critical

SHARPSHOOTER ADVANCEMENT TABLE

Level	Attack	Fort	Ref	Will	Special
1	+1	+2	+0	+0	Eagle Eye Shot
2	+2	+3	+0	+0	Low Light Vision
3	+3	+3	+1	+1	Disarming Shot
4	+4	+4	+1	+1	Bonus Feat
5	+5	+4	+1	+1	Stumbling Shot
6	+6	+5	+2	+2	Intimidating Shot, Eagle Eye Shot
7	+7	+5	+2	+2	Song of the Dead
8	+8	+6	+2	+2	Metamagic Feat
9	+9	+6	+3	+3	Item Creation Feat
10	+10	+7	+3	+3	Master of the Dead

multiplier on to itself to determine damage. For example, a longbow's critical multiplier is x3. Whenever a 10th-level sharpshooter damages a target, he deals x3 damage with a longbow. On a critical hit, he deals x5 damage, as two x3 multipliers stacked together yields a total multiplier of x5.

In order to use this ability, the sharpshooter must take careful aim against his target. He must use a full round action and may take only one shot at his highest base attack bonus.

SHILDBEARER

The shieldbearer learns to protect a particular charge from harm, but unlike most bodyguards, trains to protect a fellow warrior in battle as well. Most bodyguards train under the assumption that their charge is defenseless or otherwise ill-suited to physical combat. The shieldbearer not only protects his charge, but helps augment his combat abilities. Shieldbearers tend to flock to great heroes or warrior-kings. They view themselves as an important part of any great heroes' legacy. Any famed warrior who leads a host into battle typically values the shieldbearers who march at his side as much as a battalion of standard warriors.

Warriors who follow the path of the shieldbearer tend to shun the spotlight, preferring to work in the background to help a greater cause. Few formal schools or academies produce shieldbearers. Instead, those who join this prestige class tend to

develop the techniques on their own. Any warrior who places the glory of another warrior above his own can develop the skills of a shieldbearer. In kingdoms with a strong martial tradition, particularly those where the nobility march into battle at the head of an army, the king's bodyguards often develop these skills. They march into battle to protect their monarch, while at the same time helping him to gain glory in battle by overcoming powerful foes or fabulous monsters.

Shieldbearers also sometimes work as mercenaries, agreeing to watch over the highest bidder and aid him in combat. Many wealthy nobles who turn to adventuring hire experienced shieldbearers to help shepherd them through their dangerous quests.

Hit Die: d10

Requirements

To become a shieldbearer a character must meet the following requirements.

Base Attack Bonus: +5

Feats: Alertness, Combat Reflexes, Lightning Reflexes.

Class Skills

The shieldbearer class skills (and the key ability for each) are Balance (Dex), Climb (Str), Craft (Int), Escape Artist (Dex), Handle Animal (Cha), Jump (Str), Ride (Dex), Spot (Wis), and Swim (Str).

Skill Points at Each Level: 2 + Int modifier.

SHILDBEARER ADVANCEMENT TABLE

Level	Attack	Fort	Ref	Will	Special
1	+1	+2	+0	+0	Shield Another
2	+2	+3	+0	+0	Bonus Feat.
3	+3	+3	+1	+1	Hinder Enemy
4	+4	+4	+1	+1	Shield Push
5	+5	+4	+1	+1	Bonus Feat.
6	+6	+5	+2	+2	Stand Ground, Shield Another
7	+7	+5	+2	+2	Defend
8	+8	+6	+2	+2	Retributive Strike
9	+9	+6	+3	+3	Bonus Feat.
10	+10	+7	+3	+3	Fortify, Shield Another

Class Features

All of the following are class features of the shieldbearer prestige class.

Weapon and Armor Proficiency: The shieldbearer gains proficiency with all simple and martial weapons, all shields, and all armor.

Shield Another: At 1st level, the shieldbearer may grant his shield AC bonus, if any, to any ally who stands within five feet of his position. The shieldbearer may declare that he is using this ability on his action. The target gains the shield AC bonus until the shieldbearer's next action. While the shieldbearer uses this ability, he loses the AC bonus his shield provides. Using this ability is a move-equivalent action. The shieldbearer's shield AC bonus counts as a circumstance bonus for whoever receives the shieldbearer's protection. The protected character is the shieldbearer's charge. At 6th level, he no longer loses the AC bonus, and at 10th level, it is a free action to declare.

Bonus Feat: While the shieldbearer tends to focus on defending his chosen charge, he must also

have enough skill in battle to hold his own against the enemy. At 2nd, 5th and 9th level the shieldbearer gains a feat chosen from the fighter's list of bonus feats.

Hinder Enemy: At 3rd level, the shieldbearer is a master of slowing down enemies and limiting their mobility. When the shieldbearer makes an attack of opportunity, he has the option to instead hinder his target's movement. If the shieldbearer's attack of opportunity hits, his opponent takes no damage but instead must immediately stop his movement. The shieldbearer must declare he is using this option before rolling his attack.

Shield Push: At 4th level, as a standard action, the shieldbearer may force an opponent back by slamming into him with his shield. The shieldbearer makes a bull rush attack without having to move into his opponent's square. In addition, the shieldbearer cannot push his foe more than five feet. If this attack fails, the shieldbearer maintains his position. Resolve this attack as a melee touch attack made with the shieldbearer's shield.

Stand Ground: At 6th level, the shieldbearer learns to distribute his weight and better withstand attacks meant to dislodge him from his current position. He gains a +4 stability bonus to resist or perform bull rush and trip attacks. In addition, the shieldbearer may set any melee weapon against a charge in order to deal double damage, not just those weapons that specifically have this ability.

Defend: At 7th level, the shieldbearer not only improves his charge's defensive footing, but he can also now prevent opponents from even attacking his charge. When the shieldbearer attacks an opponent, that foe may not attack the shieldbearer's charge.

Retributive Strike: At 8th level, when the shieldbearer uses his shield another ability, he may also choose to hold as attack to strike at the next person who attacks his charge. When the shieldbearer subsequently attacks in response to an attack on his charge, he may time his blow such that he strikes just as his enemy commits to his own



attack. The shieldbearer gains a +2 circumstance bonus to his attack roll as his enemy leaves an opening during attack.

Fortify: At 10th level, the shieldbearer becomes a one-man walking fortress. When he uses the shield another ability, double his shield bonus to determine the total circumstance AC bonus his charge gains. The shieldbearer's charge also gains a +2 circumstance bonus to all Reflex saves.

SPELLBREAKER

While dwarven wizards are just as skilled in their craft as those of any other race, most dwarf spellcasters specialize in crafting and forging magical weapons, armor, and other items. Thus, while the fruits of their efforts prove quite useful in battle, the spellcasters themselves often lack the arcane spells necessary to rain destruction upon the enemy. Compounding problems, the dwarves are few in number and their war wizards often find themselves outnumbered and neutralized in battle.

To counter this weakness, dwarf wizards combine their knowledge with the ancient dwarven martial tradition to train and prepare an elite corps of anti-magic troops called the spellbreakers. In battle, spellbreakers use their arcane training to disrupt and destroy spells prepared and cast by the enemy. Furthermore, their specialized training makes them deadly foes when confronting spellcasters in melee combat.

Spellbreakers serve as elite troopers in dwarf armies. They often stay close to commanders or other important figures, waiting for orders to march to a specific point in the battle line to deal with their sworn enemies. Most dwarf generals hold spellbreakers in reserve, waiting for the enemy's wizards to appear so that he may deploy his spellbreakers in as effective a manner as possible.

Hit Die: d8

Requirements

To become a spellbreaker, a character must meet the following requirements:

Base Attack Bonus: +5

Knowledge (arcana): 5 ranks

Spellcraft: 5 ranks

Race: Dwarf

Special: Optionally, a non-dwarf may become a spellbreaker under a special set of circumstances. If a non-dwarf agrees to struggle against a particular wizard, cleric, or other spell user on behalf of a dwarven clan, the master spellbreaker may agree to instruct the clan's champion in the art of spellbreaking. Also, a non-dwarf to whom a clan owes a tremendous debt may claim spellbreaker training as his reward. This debt must be quite deep for the clan to impart such knowledge to an outsider (for example, a hero who drove a dragon from an ancient dwarven settlement or discovered and returned a lost dwarven artifact could gain

SPELLBREAKER ADVANCEMENT TABLE

Level	Attack	Fort	Ref	Will	Special
1	+0	+2	+2	+2	Neutraliz Magic (1/day)
2	+1	+3	+3	+3	Disrupt Spellcaster
3	+2	+3	+3	+3	Neutralize Magic (2/day)
4	+3	+4	+4	+4	Empty Mind (1/day)
5	+3	+4	+4	+4	Neutralize Magic (3/day)
6	+4	+5	+5	+5	Disrupting Strike
7	+5	+5	+5	+5	Neutralize Magic (4/day)
8	+6	+6	+6	+6	Empty Mind (2/day), Disruptive fist
9	+6	+6	+6	+6	Neutralize Magic (5/day)
10	+7	+7	+7	+7	Improved Disrupting Strike, Empty Mind

spellbreaker training). Only under the most extraordinary circumstances would a spellbreaker tutor an elf.

Class Skills

The spellbreaker class skills (and the key ability for each) are Climb (Str), Craft (Int), Handle Animal (Cha), Jump (Str), Knowledge (arcana) (Int), Ride (Dex), Spellcraft (Int), and Swim (Str).

Skill Points at Each Level: 2 + Int modifier.

Class Features

All of the following are class features of the spellbreaker prestige class.

Weapon and Armor Proficiency: Spellbreakers are proficient with all simple and martial weapons, shields, and armor.

Neutralize Magic (sp): At 1st level, the spellbreaker may cast *dispel magic* once per day using his level in this prestige class as his caster level. The spellbreaker uses this ability as a standard action. In addition to the standard uses of *dispel magic*, the spellbreaker may use it to counter an opponent's attempt to cast a spell. At 3rd level and every other level thereafter, the spellbreaker gains the ability to cast *dispel magic* one additional time per day.

Disrupt Spellcaster: At 2nd level, the spellbreaker learns the optimal moment to lash out at a spellcaster and disrupt a spell. When a spellbreaker holds his action in order to attack a foe in the midst of casting a spell, the spellbreaker may opt to make a disrupting attack. The spellbreaker must make a Spellcraft check (DC 15) in order to use this ability; if the check succeeds, resolve his attack as a touch attack and if successful, double his damage for purposes of Concentration checks.

At the spellbreaker's option, he may attempt a touch attack if he succeeds at his Spellcraft check. This attack deals no physical damage, but for the purposes of a Concentration check treat the target as if he received a blow that dealt 1d3 plus the spellbreaker's Strength modifier. The spellbreaker jostles the spellcaster or grabs at his arms in an effort to ruin the spell. Normally, a spellcaster can ignore such minor distractions, but the

spellbreaker's training allows him to lash out at precisely the right moment when the caster needs his utmost concentration. If the spellbreaker's Spellcraft check fails, his attempt to disrupt the spell automatically fails.

Empty Mind (ex): Starting at 4th level, a spellbreaker gains the ability to empty his mind completely, once per day. By focusing so strongly on a single target or goal, no mind-altering spell can affect him. In addition, his reflexes snap tight, leaving him ready to leap aside from a magical spell at a moment's notice. The spellbreaker becomes immune to mind-influencing effects and gains a +2 competence bonus to all Reflex and Will saves. Once activated, this effect last for ten rounds. At 8th level, this ability may be used twice per day. At 10th level, this power extends around the spellbreaker in a 10-ft.-radius burst.

Disrupting Strike: At 6th level, the spellbreaker learns the optimal moment to strike a caster in order to disrupt a spell. The spellbreaker makes a Spellcraft check (DC 15) before attacking to disrupt a caster. If this check succeeds, the spellbreaker attacks as normal. On a successful hit, any damage inflicted by the spellbreaker counts triple for purposes of the target's Concentration skill check. The spellbreaker may also opt to make a touch attack in conjunction with this ability, as outlined under the disrupt spellcaster ability, dealing 1d6 plus twice the spellbreaker's Strength modifier for purposes of the target's Concentration check.

Disruptive Fist: At 8th level, the touch of the spellbreaker is powerful enough to disrupt potent magic. Once per day, when the spellbreaker makes an unarmed strike against an opponent, he may opt to render a single magic item on his opponent inert as if struck by a rod of cancellation. The magic item is determined randomly.

Shattering Strike: At 10th level, the spellbreaker achieves the title Master Spellbreaker. His disrupting strike now deals triple damage for purposes of Concentration checks, while his touch attack as described above deals 1d8 plus triple the spellbreaker's Strength modifier.



WANDERING SQUIRE

They wander the lonesome road, appearing as little more than wandering vagabonds with a few scant possessions in a sack and a crude walking staff in hand. Few travelers pay them any mind. Bandits rarely attempt to trouble them, and those who do quickly learn the hard way that the wanderer's staff is a deadly weapon in his hands.

Wandering squires are heroic warriors who, for whatever reason, have chosen to spurn membership in a holy order or knightly organization. They often operate outside the law, dispensing vigilante justice to those whom they deem guilty. Some squires are warriors who failed to qualify for membership in a more formal order, while others are landless peasants who, tired of seeing commoners abused by those in power, have taken up the cause of justice.

Wandering squires rely on their harmless façade to avoid suspicion. As such, they master the use of the staff, pretending the weapon to be a walking stick or some other harmless item. Wandering squires often openly move through oppressive lands and other realms dominated by evil or greedy overlords. They strive to bring hope to the oppressed, and work tirelessly to overthrow dictators and ensure that the righteous and just rule in their place.

When a great evil threatens the land, the squires band together to lend their aid to the cause of good. Many beleaguered settlements facing destruction at the hands of a bandit gang or orc tribe have welcomed the sudden appearance of a band of squires who arrive, dispatch the enemy, and leave without seeking a reward.

Hit Die: d10

Requirements

To become a wandering squire, a character must meet the following requirements.

Base Attack Bonus: +5

Feats: Dodge, Two Weapon Fighting, Weapon Focus (quarterstaff).

Class Skills

The wandering squire class skills (and the key ability for each) are Climb (Str), Craft (Int), Diplomacy (Cha), Gather Information (Cha), Heal (Wis), Intimidate (Cha), Jump (Str), Listen (Wis), Profession (Int), Ride (Dex), Spot (Int), and Swim (Str).

Skill Points at Each Level: 4 + Int modifier.

Class Features

All of the following are class features of the wandering squire prestige class.

Weapon and Armor Proficiency: The wandering squire gains proficiency with all simple and martial weapons, light and medium armor, and all shields.

Expertise: At 1st level, when fighting with a quarterstaff, the wandering squire acts as if he had the Expertise feat. If he already has this feat, he may choose a bonus feat from the following list: Improved Disarm, Improved Trip, Sunder. He may use these feats only when fighting with a quarterstaff.

Staff Expert: While the squire focuses on using his quarterstaff in combat, he can also use it to help improve his use of several skills. At 1st level, while the squire has his quarterstaff in his hand, he gains a +2 competence bonus to all Intimidate and Jump skill checks.

Stunning Attack: At 2nd level, when fighting with a quarterstaff, the wandering squire may choose to deal a stunning attack in addition to inflicting normal damage. The wandering squire must declare that he wishes to stun his opponent before resolving the attack roll. On a successful hit, the squire's opponent must make a Fortitude save (DC 10 + the squire's level in this prestige class), or the blow stuns him for 1d4 rounds. A stunned opponent cannot act, loses his Dex bonus to AC, and is at -2 AC.

The wandering squire may use this ability once per day. At 5th level and beyond, he may use it twice per day.

Dodge: At 2nd level, while fighting with a quarterstaff, the wandering squire increases his Dodge bonus (from the Feat) by 1, to +2. At 5th level, this bonus increases to +3, at 9th level to +4 and at 10th level to +5.

Bonus Feat: At 3rd and 7th level, the wandering squire gains an extra feat that he may select from the fighter's list of bonus feats.

Deflect Arrows: At 4th level, the wandering squire uses his quarterstaff to knock aside incoming arrows, bolts, and other normal missiles. Whenever defending against a mundane missile weapon, he may make a Reflex save (DC 20 + the attack's magic bonus to hit, if any) to knock aside the projectile with his quarterstaff. He may only do this

WANDERING SQUIRE ADVANCEMENT TABLE

Level	Attack	Fort	Ref	Will	Special
1	+1	+2	+0	+0	Expertise, Staff Expert
2	+2	+3	+0	+0	Stunning Attack, Dodge +2
3	+3	+3	+1	+1	Bonus Feat.
4	+4	+4	+1	+1	Deflect Arrows
5	+5	+4	+1	+1	Dodge +3
6	+6	+5	+2	+2	Defensive Stance
7	+7	+5	+2	+2	Bonus Feat.
8	+8	+6	+2	+2	Dodge +4
9	+9	+6	+3	+3	Warding Attack
10	+10	+7	+3	+3	Staff Master, Dodge +5



against medium size or smaller missiles, such as sling stones, arrows, bolts, or thrown weapons. It does not work against magical spells or larger items. Using this ability counts as a free action, though the squire must have his quarterstaff in hand. The squire may not use this ability if he is flatfooted.

Defensive Stance: At 6th level, the wandering squire can use his quarterstaff to keep his enemies at bay and on their guard, even when he is surrounded. While he is wielding his quarterstaff, no enemies may flank the squire.

Warding Attack: At 9th level, the wandering squire uses his quarterstaff to reach out and strike opponents who are beyond the reach of a less-skilled quarterstaff user. The squire may threaten and attack into a larger area than normal for a creature his size. At the beginning of the squire's action in each combat round, he may nominate

three five-by-five foot squares beyond his normal reach that he now threatens. Each of these squares must be adjacent to the area normally threatened by the squire. Furthermore each square of these bonus threatened areas must also be adjacent to at least one of the other two bonus squares. The squire threatens these areas for purposes of resolving attacks of opportunity. He may also attack into them as if he had a reach weapon.

Staff Mastery: At 10th level, few warriors can equal the squire so long as he wields his quarterstaff. He now suffers no penalty for fighting with both ends of his quarterstaff, essentially gaining an extra attack at his highest base attack bonus each round. Furthermore, the squire is quite adept at warding off enemy blows with his quarterstaff.

WARLEADER

A single, skilled warrior makes a deadly foe. Epics tell of great heroes who could single-handedly drive back demons and defeat rampaging dragons. On the battlefield, though, a single warrior stands little chance against a horde. Even a great hero stands little chance when thirty foes overwhelm him and pull him down. In battle, a group of warriors working together towards a common goal is far more powerful than a fighter acting alone.

The warleader takes charge on the battlefield and directs the efforts of his fellows. Some warleaders are tribal champions who have earned the respect of their clan through their acts of bravery and cunning, while other warleaders are professional officers who have studied tactics and earned their positions through valor on the field or by mercenary appointments. Warleaders serve as field commanders and rallying points in battle. They can direct their allies efforts in order to improve their individual skills and help them work better together as a team.

Hit Die: d10

Requirements

To become a warleader, a character must meet the following requirements.

Base Attack Bonus: +6

Diplomacy: 4 ranks

Feat: Leadership

Class Skills

The warleader class skills (and the key ability for each) are Climb (Str), Concentration (Con), Craft (Int), Diplomacy (Cha), Intimidate (Cha), Profession (Int), Ride (Dex), Sense Motive (Wis), and Swim (Str).

Skill Points at Each Level: 4 + Int modifier.

Class Features

All of the following are class features of the warleader prestige class.

Weapon and Armor Proficiency: The warleader gains proficiency with all simple and martial weapons, shields, and armor.

Lend Counsel: At 1st level, the warleader can observe his allies' actions and provide them with advice and encouragement that helps improve their performance. In order to use this ability, he must observe and verbally communicate with the ally. The warleader makes a Concentration check (DC 15) in order to clear his mind and assess the situation. If the check succeeds, he provides his ally with a useful piece of advice that grants him a +2 competence bonus to a single attack or skill check. The warleader may use this ability once per battle. If the warleader's skill check fails, he does not provide any bonus and may not use this ability again during the encounter.

Inspire Bravery (ex): At 2nd level, the warleader serves as an example to his troops. In the face of the enemy, they look to him to provide them

WARLEADER ADVANCEMENT TABLE

Level	Attack	Fort	Ref	Will	Special
1	+1	+2	+0	+0	Lead Counsel
2	+2	+3	+0	+0	Inspire Bravery
3	+3	+3	+1	+1	Bonus Feat.
4	+4	+4	+1	+1	Concerted Attack
5	+5	+4	+1	+1	Charisma +2
6	+6	+5	+2	+2	Bonus Feat.
7	+7	+5	+2	+2	Snap to Attention
8	+8	+6	+2	+2	Motivate the Troops
9	+9	+6	+3	+3	Bonus Feat, Motivate the Troops
10	+10	+7	+3	+3	Rally the Troops, Motivate the Troops

with inspiration and to help allay their fears. Whenever the warleader's allies suffer a fear effect, they may use the warleader's appropriate saving throw bonus so long as the warleader is within their line of site. Even in the face of magical fear

effects or overwhelming odds, the warleader's steadying presence lends hope and bravery to his charges.

Bonus Feat: At 3rd, 6th, and 9th level, the warleader gains an extra feat that he may select from the fighter's list of bonus feats.

Concerted Attack: At 4th level, the warleader is a master of efficiency. When the warleader and his men have an opponent cornered, or have a chance to coordinate their attacks, they fight together in a more skillful and deadly manner. If the warleader spends a full round action shouting orders and directing his troops, he grants bonuses to their attack rolls if he makes a Concentration check (DC 25). The warleader must clear his mind and shout above the roar of battle to effectively lead his men; if his men cannot hear him, this ability is useless. The warleader's men receive a +4 bonus to hit flanked opponents, rather than the standard +2. In addition, they each gain an additional attack of opportunity. These effects last for the rest of the encounter. The warleader may use this ability once per day.

Charisma: At 5th level, the warleader's Charisma increases by 2. This effect is immediate and permanent.

Snap to Attention: At 7th level, the warleader's troops learn to immediately put up their guard at the commander's signal. At the beginning of combat, the warleader may make a Concentration check (DC 20). If he succeeds, the warleader and his allies are not flatfooted before they have a chance to act. The warleader may use this ability when he makes his initiative roll. He may not use this ability if he has lost his action for any reason, or has not yet rolled initiative, such as if he has been surprised or is otherwise unaware of the enemy's advance.

The warleader may also use this ability to warn his allies of any hidden threats or ambushes. If the warleader can see an opponent his allies are unaware of, he may use a free action to shout a warning. If the warleader succeeds at a Concentration check (DC 20) his ally notices the enemy and is not flatfooted against them. The warleader may use this ability once per round.



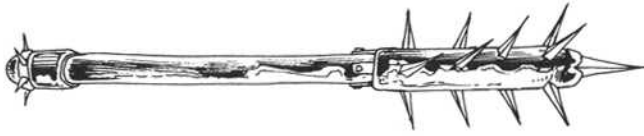

Motivate the Troops: As the warleader masters his ability to lead troops into battle, he fills his underlings with enthusiasm for the coming battle. At 8th level, the warleader can give a short, stirring speech as a standard action. For the rest of the battle, his allies receive a bonus to their initiative equal to the warleader's Charisma modifier. The warleader may use this ability up to thirty minutes before combat, at which point his allies receive this bonus when rolling initiative. Otherwise, if the warleader uses this ability in the middle of combat, his allies immediately gain the bonus to their current initiative values. The warleader may use this ability once per day at 8th level, twice per day at 9th, and three times per day at 10th.

Rally the Troops (ex): At 10th level, the warleader is a supreme veteran of war. He learns to effectively inspire and lead men in battle. As a full round action, he can deliver a stirring speech that causes his men to redouble their efforts in combat. For the next 1d4 + the Charisma modifier in rounds, the warleader's allies act as if they are under the effect of a *haste* spell. In addition, they gain a +1 morale bonus to hit and damage. The warleader may use this ability three times per day, though he may only use it only once per encounter.

WARMAGE

While the average warrior heads into battle in heavy armor, bearing a stout shield, and carrying a weapon, some of the most effective warriors place not a single layer of steel between themselves and their enemies. Calling upon the arcane energies of magic to carry the day, wizards and sorcerers can command powers making them the equal to an entire battalion of warriors on the battlefield.

Most arcane spellcasters shy away from direct combat. They take care to keep behind the main lines and use their spells from a distance. However, many arcane spells are best served when cast directly from the front line. Warmages train to wade into combat alongside elite shock troops. They train extensively in how to work magic under the most dire circumstances, heedless of taking fire while trying to work spells.

Hit Die: d6

Requirements

To become a warmage, a character must meet the following requirements:

Spellcasting: Ability to cast 3rd level arcane spells.

Concentration: 8 ranks

Knowledge (arcana): 6 ranks

Feats: Any one Metamagic Feat, Combat Casting, Dodge.

WARMAGE ADVANCEMENT TABLE

Level	Attack	Fort	Ref	Will	Special
1	+0	+2	+0	+2	Arcane Accuracy +1
2	+1	+3	+0	+3	Armored Mage +1
3	+1	+3	+1	+3	Superior Dodge +1
4	+2	+4	+1	+4	Armored Mage
5	+2	+4	+1	+4	Mental Toughness +1
6	+3	+5	+2	+5	Armored Mage +1
7	+3	+5	+2	+5	Dodge Missile Fire +1
8	+4	+6	+2	+6	Armored Mage +1
9	+4	+6	+3	+6	Arcane Tactician +1
10	+5	+7	+3	+7	Arcane Warrior +1



Class Skills

The warmage class skills (and the key ability for each) are Alchemy (Int), Concentration (Con), Craft (Int), Knowledge (Int), Profession (Wis), Scry (Int), and Spellcraft (Int).

Skill Points at Each Level: 2 + Int modifier.

Class Features

All of the following are class features of the warmage prestige class.

Weapon and Armor Proficiency: The warmage gains proficiency with all simple and martial weapons and light armor.

Spellcasting: At each even-numbered level, the warmage gains a level of spellcasting ability in one of his previous arcane spellcasting classes.

Arcane Accuracy: As many of the most useful combat spells require a wizard to aim at and hit his target, the warmage learns to focus his arcane energies and better aim his spells. At 1st level, the warmage gains a +1 competence bonus per level in this prestige class to attack rolls when attacking with a spell (ray, touch, etc.).

Armored Mage: At 2nd level, the warmage has trained long enough in his armor, to reduce chance of spell failure. The arcane failure chance is reduced by 5%. At 4th level, this reduces by 10%, at 6th level it reduces by 15%, and at 8th level it reduces by 20%.

Superior Dodge: At 3rd level, the warmage learns how to better defend himself in melee combat. The warmage gains a +1 dodge bonus to AC. In addition, when he uses his Dodge feat he gains a +2 dodge bonus to AC that stacks with the +1 AC bonus granted by this ability. The warmage loses this AC bonus whenever he loses his Dex bonus to AC.

Mental Toughness: At 5th level, the warmage learns to focus his thoughts even in the swirl of melee. The warmage gains a +4 competence bonus to all Concentration checks.

Dodge Missile Fire: In addition to the dodge AC bonus granted by the superior dodge class feature, the warmage gains an additional +1 dodge bonus to

AC when attacked by any ranged weapons. The warmage loses this AC bonus whenever he loses his Dex bonus to AC.

Arcane Tactician: The warmage learns to best utilize his spells in battle. When engaged in melee, the warmage may slightly alter the magical energies he weaves to create any area of effect spell. If he casts a spell with an area of effect, he may alter the spell so that it does not affect him or his allies. He must make a Spellcraft check (DC 10 + 5 per person, including himself, that he does not want affected). If he succeeds, that particular person is not affected by the spell. If the check fails, that person suffers the spell as normal. The warmage may attempt to avoid targeting up to a number of people equal to his Intelligence modifier.

Arcane Warrior: At 10th level, the warmage acquires the ability to maintain his guard even while casting his spells. He no longer draws attacks of opportunity while casting spells.

WILD RIDER

Across the wild, wind-swept steppes ride some of the fiercest mounted warriors the world has ever seen. Unlike knights, cavaliers, and other elite, civilized mounted warriors, the wild rider relies on his unstoppable passion and furious, overpowering

attacks to drive his enemies before him. While knights spend years training to fight from the saddle, the wild rider grows up around horses and needs no training. Mounted combat is a legacy that flows down through countless generations into him. He favors light armor, quick, devastating strikes, and mobility to the tactics used by ponderous, heavily armored cavaliers and knights of civilization.

Wild riders are the scourge of civilization. They sweep down upon settlements, peppering them with clouds of arrows, taking what they want, and sweeping away back to the steppe. When gathered together under a powerful khan, they can prove to be an unstoppable tide of furious violence. Wild riders are a fractious and rowdy bunch, however, difficult to gather together under a single leader and often lacking the discipline needed to commit to a long-term military campaign.

Wild riders often hire out as mercenaries, typically working in small groups as scouts, raiders, or specialized shock troops. In a direct charge, they often can't stand up to a massed cavalier assault. However, wild riders prefer to shoot and run, slowly whittling down their enemy's strength before swooping in, sabers drawn, for a deadly attack.

Hit Die: d10

WILD RIDER ADVANCEMENT TABLE

Level	Attack	Fort	Ref	Will	Special
1	+1	+2	+0	+0	Improved Mounted Archery
2	+2	+3	+0	+0	Inspired Horsemanship
3	+3	+3	+1	+1	Wild Rider
4	+4	+4	+1	+1	Furious Fire
5	+5	+4	+1	+1	Spirited Mount
6	+6	+5	+2	+2	Incite Rage
7	+7	+5	+2	+2	Exotic Mount
8	+8	+6	+2	+2	Ride Like the Wind
9	+9	+6	+3	+3	Spirited Mount
10	+10	+7	+3	+3	Ferocious Charge, Exotic Mount

Requirements

To become a wild rider, a character must meet the following requirements.

Base Attack Bonus: +5

Animal Empathy: 6 ranks.

Heal: 6 ranks.

Ride: 8 ranks.

Wilderness Lore: 6 ranks.

Feats: Mounted Archery, Mounted Combat

Special Ability: Able to rage, as per the barbarian class.

Class Skills

The wild rider class skills (and the key ability for each) are Animal Empathy (Wis), Climb (Str), Craft (Int), Handle Animal (Wis), Intimidate (Cha), Intuit Direction (Wis), Jump (Str), Listen (Wis), Profession (Int), Ride (Dex), and Swim (Str).

Skill Points at Each Level: 2 + Int modifier.

Class Features

All of the following are class features of the wild rider prestige class.

Weapon and Armor Proficiency: Wild riders are proficient with all simple and martial weapons, light armor, and all shields.

Improved Mounted Archery: The wild rider

was born in the saddle. He feels more at home with his feet in stirrups than with them on the ground. When firing from horseback, the wild rider is an unmatched archer. At 1st level, when making a double move while mounted, he has no penalty to his attack. When his mount runs, he suffers only a -2 penalty to hit. With his Mounted Archery Feat, the wild rider normally has a -2 penalty to hit when his mounts makes double move and a -4 penalty when his mount runs.

Inspired Horsemanship: At 2nd level, the wild rider establishes an almost empathic bond with his mount. Having grown up around horses and lived much of his life in the saddle, the wild rider gains an intuitive sense of a horse's emotions, fears, and needs. If the wild rider spends a week with a horse or other riding creature, he develops a close bond with it. When making Animal Empathy, Heal, or Ride checks with such a creature, the wild rider gains a +2 competence bonus. The wild rider



can also teach his mount up to three one-word verbal commands. In addition to the week needed to bond with a horse, the wild rider must spend one week training his mount for each one-word command he wishes to teach it.

Wild Rider: At 3rd level, wild riders fight most of their battles from horseback. Thus, they often use their barbaric rage while mounted. While raging on horseback, the wild rider becomes more enthusiastic and spirited in leading his mount, granting him a +4 competence bonus to Ride checks.

Furious Fire: Wild riders, unlike many barbaric warriors, depend on the bow as their primary weapon. As such, the wild rider often enters his rage while firing upon his enemies from horseback. At 4th level, the wild rider's frenetic burst of fiery energy allows him to let loose a rapid stream of missile fire. While raging, the wild rider gains the benefits of the Rapid Shot feat. If the wild rider already possesses the Rapid Shot feat, he may use that feat and make another missile attack at his highest base attack bonus, with an additional -2 penalty to each shot. In essence, the wild rider gains two extra shots for a -4 penalty to all his attacks.

Spirited Mount: At 5th level, the wild rider inspires his trusted mount. Any mount the wild rider is on is considered to have an additional HD. This increases its hit points as well, reflecting its morale and confidence. At 9th level, the mount gains an additional HD for a total of 2.

Incite Rage: At 6th level, while riding a mount with which he has established an emotional bond (as per the Inspired Horsemanship ability described above), the wild rider's enthusiasm and bravery spill over into his mount. If the wild rider uses his raging ability while in the saddle, his mount enjoys all the benefits and drawbacks of the wild rider's rage. These bonuses and penalties last for as long as the wild rider's rage does. In addition, the mount suffers any penalties suffered by the wild rider in the aftermath of a rage. While raging, the wild rider's mount may automatically use all of its attacks without a

Ride check from the wild rider. Furthermore, if the wild rider's mount would not normally attack, such as in the case of a regular riding horse, it fights anyway.

Exotic Mount: At 7th level, the wild rider's intuitive sense of animals allows him to ride more exotic creatures. Exotic mounts such as griffons, hippogriffs and pegasi. The rider may treat one exotic mount (such as a beast, but not a magical beast or aberration) as a normal mount for the purposes of his special abilities and training. At 10th level he may choose a second mount. The wild rider must establish a bond with his mount as per the Inspired Horsemanship ability described above.

Ride like the Wind: At 8th level, wild riders are inspired riders capable of coaxing tremendous efforts out of their mounts. When the wild rider's mount makes a double move, it may move up to triple its normal movement rate. When running, the wild rider's mount quintuples its movement rate rather than quadrupling it. The wild rider must establish a bond with his mount as per the Inspired Horsemanship ability described above.

Ferocious Charge: At 10th level, when raging, wild riders can deliver a devastating mounted charge. The wild rider gains the benefits of the Spirited Charge feat when he makes a mounted charge while raging. If the wild rider already possesses the Spirited Charge feat, he deals triple damage with a melee weapon and quadruple damage with a lance.

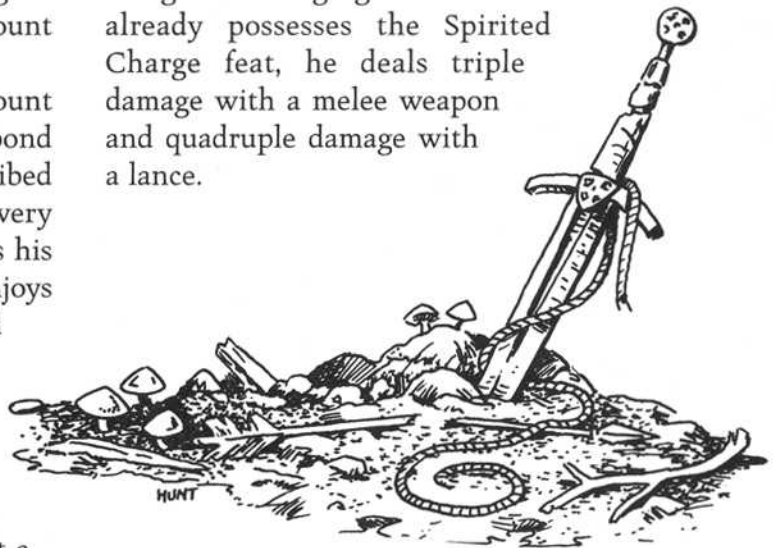

CHAPTER THREE:

THE SIEGE

Perhaps one of the most pervasive themes in medieval history and fantasy is the story of the great siege. The heroes stand watch, trapped behind their last bastion of defense while they bravely defend their lair against the evil horde battering at the gates. Or maybe the dashing party has the villain on the ropes, and the final battle consists of striving to stamp out the last power structure of the evil empire or to rescue the helpless captives imprisoned within its walls. Images of battering rams and scaling ladders, catapults and ballistae, siege towers and desperate last stands... the legends of medieval battles.

Sieges are long, ugly affairs, and no general enters into them lightly. Unless a village or fortress is vital to the war effort, a general prefers to either loot the location or pass it by. Most sieges occur during the final days of a war, or as one of its opening gambits. During most other times, the enemy armies' movements disturb a siege with ease, making it a useless tactic. More dangerous than normal maneuvers, a general lays siege to seize a portion of an enemy's power, rather than destroy it outright.

Medieval engineers build castles to secure and maintain military might at strategic locations, and to protect armies from surprise attack. As the individual lords of the castles win military battles and amass armies, they garner political power as well. As the political might of the castle's lord grows, it attracts people who wish his protection. Blacksmiths, fletchers, woodsmen, coopers, bowyers, and other artisans can find homes within a castle's halls, and their combined skills strengthen the castle's fortifications.

While the fortress' defenses make it an all but impregnable lair, a siege turns the castle into a prison. By keeping the military power of the local area trapped inside the fortification, the invading army can force those in charge to concede to the invaders' wishes, whether they might be food, wealth, or land. As the invaders themselves cannot leave without backing out of their threats, the two forces stand locked in a combat of will and time. A siege.

The siege begins when the attacking army surrounds the castle or fortification, cuts it off from communications and supply, and waits for lack of water and food or ammunition to force the defenders to surrender. If the besieging army has enough patience and supplies, the siege almost always succeeds. In fact, starvation and deprivation usually cause the end of almost any siege, for either side. If the castle's larders are full and the invading army is hungry, the defenders may outlast the invaders. Invading armies often rely on foraging the local area for food, so defending armies preparing for a siege often raid their own countryside for all the food they can. The defenders then lie in wait within the castle, quietly reinforcing the existing defenses.

The primary idea behind fortifications is not so much to keep people out as it is to make any entrance as time-consuming and deadly as possible. The aim is to outlast the invaders, perhaps killing more attackers as they attempt to take the castle by force, perhaps waiting for an allied army to arrive and force the invaders out.

CASTLES

Castles have many of the same basic features. The prime spots for building castles are hills, mountains, or at the forks of rivers, to make access as difficult as possible and limit the directions from which an attack can occur.

A moat or ditch surrounds a wall of wood or stone, from which bowmen shoot down on the attackers. These are typically left empty as water is too valuable to waste in sieges. In peacetime, people enter and leave over a drawbridge. A drawbridge need not be a complicated affair; it could be as simple as individual, retractable planks.

Ramparts on top of the castle wall provide openings for the defenders to shoot through and cover to protect them from the enemy's fire.

Towers placed at the corners or interspersed along the length of the wall give defenders the opportunity to view the foot of the wall and its front face, and to shoot at attackers from the flanks.

Inside the wall is an outer bailey, or courtyard, where the defenders gather or prepare for the fight. Inside the outer bailey is often another wall, perhaps surrounded by another moat or ditch also with its own drawbridge. This wall surrounds an inner bailey. Within the inner bailey is the keep. The keep is an immensely strong tower, difficult to access and well-protected. It acts as both a troop reserve and a final defensive position.

SIEGE TACTICS

The many similarities between castles give rise to several standard tactics used in a siege.

The beginning of a siege takes a few basic steps. The first step is to completely surround the castle, cutting off any means of supply or escape for the defenders. The second step is to scour the countryside for food, securing all available foodstuffs for the besieging army and preventing any midnight foraging by defenders who might sneak through the lines. Once the army has cut off the defenders, the attackers make a direct assault on the moat or ditch in an attempt to fill it up with

brushwood and earth. Though not strictly necessary to entering the castle, this allows the army to scramble along the walls without stumbling.

Once the attacking army has access to the wall itself, they have two options on how to deal with the fortification. They can go over the walls or through them. Each option requires its own set of techniques and tactics.

Going over the wall necessitates the construction of scaling ladders and perhaps siege towers (see Siege Tower, below). The siege tower draws near enough to the wall so that the tower's drawbridge allows direct access to the ramparts. The attackers storm out of the tower en masse to attack the defenders to gain a foothold within the castle walls. Scaling ladders are a simpler alternative to the siege tower, but the casualties are much higher. The invaders swarm the wall, lining up as many ladders, then climbing up them in an attempt to gain a position on the battlements. The attackers

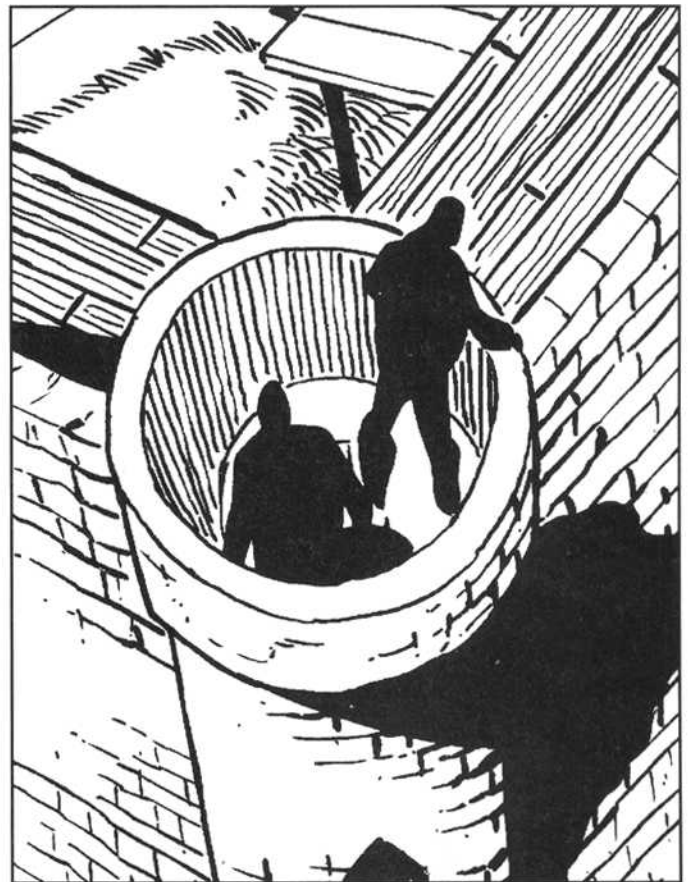

attempt to cover the assault with swarms of missile. Once the attackers have gained a foothold within the walls, they attempt to gain control of the castle gates to allow entrance for the besieging army. The best counters for siege towers are flaming pitch or oil flung against it, or shooting the men or animals attempting to move it into place. Defenders have far less difficulty with scaling ladders, knocking them aside with polearms designed specifically for this purpose (doubling as ladder hooks and weapons).

Breaching the wall is more dangerous, as a collapsing wall falls towards the breach. The two most common methods of creating a breach in the wall are siege gear and mining. The battering ram (see Battering Ram, below) attempts to hammer through the wall with its pointed iron or bronze tip. The thicker the walls of the castle, however, the less effective the ram. Attacking the gate with the battering ram is therefore preferable to attacking the wall, because the gate is usually made of weaker

materials. The besieging army therefore tries to bridge the moat nearest the gate.

Another option for creating holes in the walls is the use of siege engines or artillery, depending on the level of technology available. Catapults and trebuchets are capable of hurling projectiles weighing several hundred pounds against the walls or over them. Missiles with this kind of power can easily shatter parapets and battlements, killing defenders and eventually shattering the walls themselves.

The battering ram is particularly vulnerable to defensive fire, due to the crew's exposure. Many battering rams have sturdy roofs to protect the crew from arrows and stones, but the ram itself remains vulnerable. If the defenders can manage to set it afire, the crew must eventually abandon it. Another method of defense against the ram is to lower bales of straw or wool to absorb the ram's blow. Sometimes the defenders attempt to snare the ram's

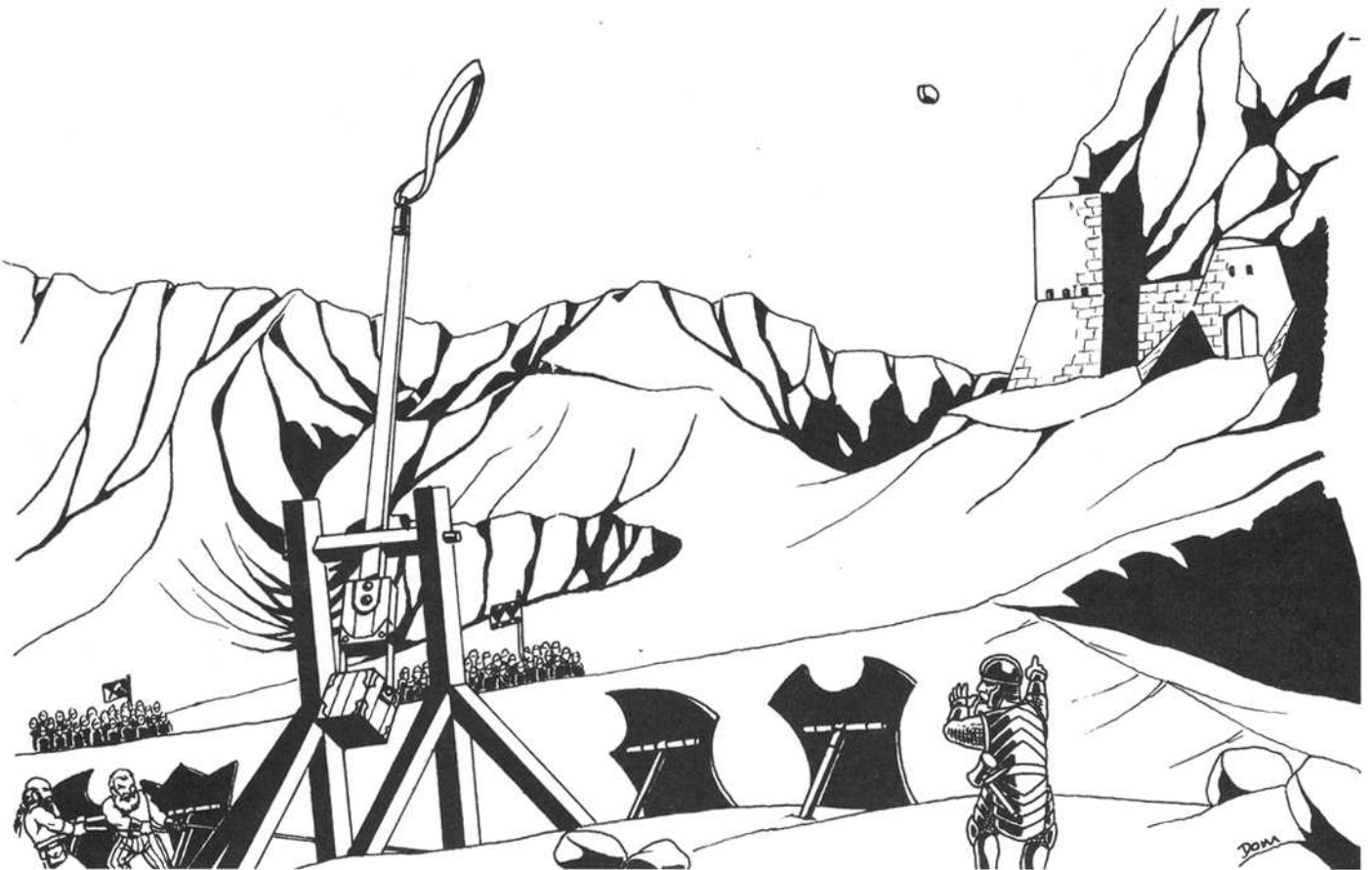

head with chains and drag it away from the wall, but attacking the crew is by far the easiest method of defense.

Mining requires considerably more patience than a frontal assault. Sappers must dig a tunnel in a location protected from defensive missile fire, either behind protective constructions or natural terrain, and continue to dig right up to the foundations of the castle wall. The workers then widen and expand the tunnel, to remove support for the stone wall above until it collapses under its own weight. Oftentimes the sappers pack the tunnel under the wall with brush and wood and set it alight. The heat from the fire weakens the mortar and burns away the wooden beams often used to align the foundations of a castle wall, hastening its collapse. A major drawback of mining is that it can take weeks or months for the sappers to complete their work, during which time the invading army is stationary and exposed. Even a small army of only 1,000 men costs 3,500 gp per week to feed, assuming a source of water is nearby and that supply lines are open. With the costs of paying the troops, and of weapons and siege equipment, the price of a siege weighs heavily.

Against mining, however, there is no ideal defense. The sappers are underground, protected from defensive fire. The defenders can countermine from inside the castle, attempting to break into the tunnel and attack the sappers. If they gain control of the tunnel, they can attempt to collapse it or use it as a stage for a counterattack. The risks associated with countermining are quite significant, however, and the defenders may weaken their own wall, potentially contributing to its collapse. If the defenders manage to break into the tunnel to attack the sappers, they run the risk of losing control of their own tunnel, creating an opening directly into the castle. Once the attackers breach the wall, they attempt to storm the outer castle. At this point, the siege is effectively over as the bulk of the defending army has died or fled, and the major defenses have fallen.

Many sieges resolve without any direct combat, as neither side can typically afford lost men. Breaking the enemy's will to fight is a large part of this goal, and siege engines can have a tremendous impact in this regard. The attacker can start fires within the castle by lobbing barrels of flaming pitch over the wall, forcing the defender to devote manpower to fighting the fires while an assault is in progress, and either side can set the other's siege gear aflame. The attacker can attempt to spread disease within the castle by hurling dead animals or prisoners over the walls where the defenders cannot easily dispose of the corpses. Even if the bodies cause no disease, the stench of several dozen carcasses or corpses forces morale to drop sharply. A thundering rain of stones and flaming projectiles, smashing or burning any interior buildings, can destroy the defenders' morale before any assault begins. Cannon fire and explosive projectiles leave the victims stunned and shaken. As bombardment continues, the number of casualties mounts, further reducing morale and fighting strength. In addition to the effects on spirit, sustained bombardment may eventually create breaches in the wall, which is why the development of cannons effectively ended the era of the medieval siege.

ARTILLERY

One favorable characteristic of some siege engines that counterbalances the use of magic is range. Some siege engines, especially the largest ones like the heavy trebuchet, are capable of shooting or lobbing projectiles a distance of half a mile or more, far beyond the reach of missile spells

SIEGE IN A FANTASY WORLD

As mentioned above, the development of gunpowder weapons and cannons in our own history largely ended the era of the medieval siege. Even thick, stone walls can not stand for long against the thunderous power of a sustained cannon barrage. For this reason, any DM who wishes to put a siege into his fantasy game must carefully plan how magic might affect such a siege. How much magic do the armies have? How will each side employ their spells? What steps can each side take to defend against the enemy's magic? Many historical siege machines and defenses become somewhat irrelevant in the face of wizards of even moderate level. How would the prospect of such an attack affect the invaders' deployment? Why would anyone spend the time and money to build a catapult when the grand vizier's *fireball* is more effective, or when their siege machines could be destroyed by a single spell? Why use a Trojan horse when a *dimension* door or *teleport* can put several infiltrators inside the walls to open the gate? Flying creatures and spells that allow flight essentially create an "air force," further introducing the idea of bombing. How important are walls when the invaders can simply fly over them? How would defenders protect themselves from flying creatures? For that matter, what about magical creatures? What castle could stand up to the wrath of even a young dragon?

For this reason, the DM should carefully consider in advance how much magic both armies have. The use of magic in taking a defended castle could become far more important than any frontal assault with scaling ladders and battering rams. In fact, it might be a fascinating twist for the DM to develop. Imagine a guild of powerful battle mages, trained in creating magical siege machines or the spells capable of breaching defenses. Their skills place them in high demand by anyone wishing to go to war. Their political influence would be extensive, because every government seeking more power and land for itself would have to court their favor.

Or would the governments of the region even allow them to exist in the first place, fearing the power they would gain for themselves? Perhaps in the past, just such a group caused tremendous devastation, causing the adoption of a code of war that outlaws the use of magic.

The siege engines and techniques described here are historical, non-magical devices.

SIEGE ENGINES

There is a great deal of inconsistency in the nomenclature of ancient siege engines, particularly with regard to the ballista and the catapult. These two machines were some of the most ubiquitous in ancient history, and used in literally thousands of variations in thousands of conflicts. In some cases, between different eras and regions, from the armies of Alexander the Great to medieval Germany, they were practically indistinguishable from one another. Their respective descriptions here reflect the most commonly held nomenclature.

The circumstances of the siege itself determine the size and type of the siege equipment. In most cases the engineers build the machines themselves on-site, using local materials or materials transported along with the invading army. When the siege ends, the engineers disassemble their machines for transport. Due to the nearly infinite variations possible with the size of siege machines, the following list divides the engines for the sake of simplicity into *light*, *medium*, and *heavy* categories. Some machines are not listed with all three categories, because their purpose or design is not consistent with all sizes. The ammunition type dictates damage caused by each machine, unless it is a machine that does not use ammunition.

The format for siege engine statistics is as follows:

Cost: Cost to build the device in gold pieces. Anyone who makes a Profession (siege engineer, or gunsmith in the case of cannons) check (DC 30) can build the device.

Range Increment: If the device is a projectile weapon, this is its range increment. When rolling

to hit with a siege engine, make a skill check (DC 20) with the appropriate skill: Profession (siege engineer) or Profession (gunnery). The range penalty applies to the skill check. The maximum range is ten range increments. Some siege engines have a minimum range.

Crew: This is the number of crew needed to operate the siege engine. The text will tell you the penalty for operating the device without the required crew, usually involving the aim and reload times. Some devices will specify a minimum number of crew, usually because the size of projectiles is too large for any fewer to handle.

Aim: This is the time required to aim the device at a target. Crews make minor adjustments to the machine between volleys, but this is part of the reload process.

Reload: This is the time it takes for the crew to reload the device after it fires.

Move: This is the distance the device can move as a move-equivalent action with a full crew. Devices listed with a “—” are too large to be moved by the crew alone, requiring instead a team of horses or an equivalent strength.

Dimensions: Describes the physical size of the device in length (L), width (W), and height (H).

TORSION

Several types of siege engines, notably the catapult and ballista, use bundles of twisted fibers to create the torsion necessary to fling projectiles great distances. The manufacture of these bundles comes from several types of fibers, from plant materials like hemp to animal sources like horsehair or even human hair. In wartime, noble ladies with long, luxuriant hair sometimes sacrifice their locks for the catapult cording. While machines using these fiber bundles are much stronger than bow-powered projectiles, they suffer from one major weakness: moisture. If the fiber bundles get wet, they stretch, quickly rendering the siege engine useless.

HOW TO MOVE A SIEGE ENGINE

Siege engines are bulky and hard to maneuver. To simulate the difficulty in turning such unwieldy contraptions, they must move forward or backward to effect any turns. The maximum any siege engine can turn is one-eighth of a turn (45 degrees) per ten feet moved forward or back. Therefore, if a siege engine moves 20 ft. forward or backward, it can make a 90-degree turn. No siege engine can turn more than 90 degrees in a single round.

Any siege engine with less than a full crew can only move at half its movement rate. If fewer than half the minimum crew man it, it cannot move.

HOW TO FIRE A SIEGE ENGINE

When the crew fires the siege engine, the leader (usually the most skilled) makes the appropriate skill check (DC 20) and subtracts any range penalties from his roll. If the check succeeds, the user rolls another d20. If the result is a natural 20 on the second roll, the projectile hits the desired location. On any other roll the cannon does not hit the desired location. Instead the DM rolls 1d4 and consults the 1 ft. to 5 ft. deviation chart in the DMG. The result is where the projectile hits. If the first check fails, the DM rolls 1d12 and consults the 10 ft. to 16 ft. deviation chart in the DMG, with the result being the actual hit location.

A siege weapon can attack at its full rate of fire only if it has a full crew. For every crew member missing, the number of full-round actions required to reload and aim the device increases by two.

ARCHIMEDES' CLAW

This rare device saw use in port cities fearing a sea attack. Designed by the Greek mathematician Archimedes, the Greeks used it to great effect in the siege of Syracuse in 213 B.C. and some historians credit it for saving the city from the Roman attack. The Greeks said it could easily capsize the largest of the attacking ships. Though the exact specifications of the device vanished, general speculation describes a device consisting of a large wooden or stone structure, perhaps twenty to thirty feet tall,

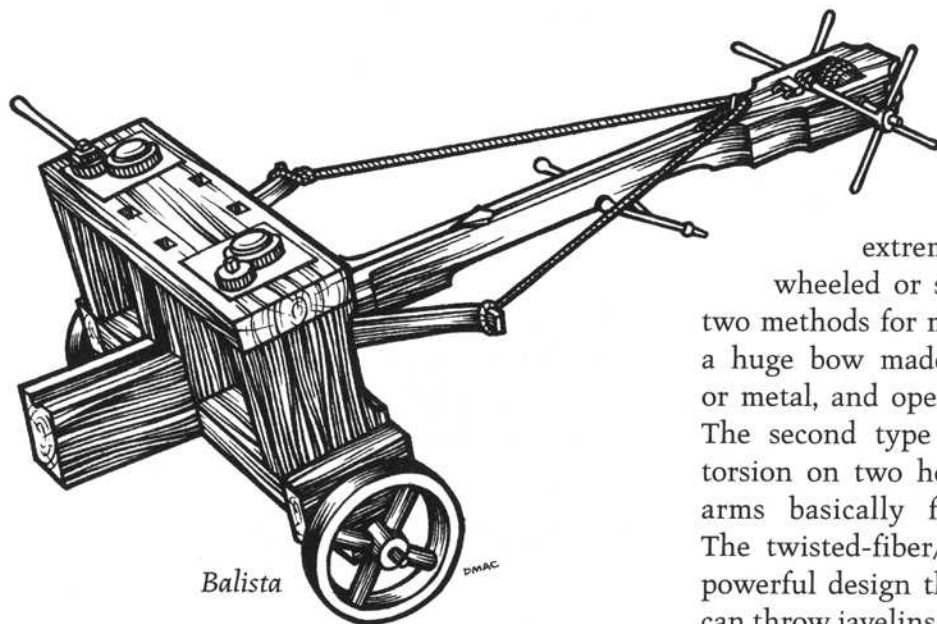

Balista

supporting a long, horizontal wooden arm that reaches out over the water. Attached to the end of the arm is a huge hook or claw on a chain, perhaps similar in appearance to a four-pronged anchor. The arm operated with ropes and pulleys, likely pulled by horses or oxen, with a tremendous mechanical advantage. When a ship came within reach of the claw, the arm lowered and the claw embedded itself into the prow or side of the ship. This accomplished, the arm arose and lifted the prow or side of the ship out of the water, capsizing the ship and throwing its crew and passengers into the sea.

To successfully hook the claw into an attacking vessel requires a Profession (siege engineer) check (DC 20), with no modifiers for range — if the ship enters range, the claw can strike. Successfully capsizing the ship requires another check (DC 20). If the second check succeeds, the ship capsizes. If unsuccessful, the claw remains attached but the ship is upright.

Cost: 1,000 gp

Reach: 30 ft.

Crew: 100 men, or 20 men and 20 horses or 20 oxen

Aim: 10 full rounds

Reload: 1 full rounds

Move: Archimedes' Claw is a constructed emplacement, and cannot be moved.

BALLISTA

The ballista is essentially an extremely large crossbow mounted on a wheeled or stationary platform, with one of two methods for missile propulsion. One type uses a huge bow made of wood, composite materials, or metal, and operates like an oversized crossbow. The second type uses twisted fibers to provide torsion on two horizontal metal arms. The metal arms basically form the ends of the “bow.” The twisted-fiber/torsion model is a much more powerful design than the simple bow. The ballista can throw javelins or spears great distances, and can pierce several ranks of armored troops at once. It can also launch small round projectiles (light ammunition only) like metal shot, stones, red-hot shot, incendiaries, and explosives. To fire the weapon, the crew makes a straight attack roll using only range modifiers (no modifiers for ability or character base attack bonuses). The ballista uses a straight attack roll, not a Profession (siege engineer) check, using only modifiers for range.

Ballista, Light

Cost: 500 gp

Range Increment: 125 ft.

Critical: x3

Crew: 3

Aim: 3 full rounds

Reload: 3 full rounds

Move: 10 ft.

Dimensions: L 5 ft., W 5 ft., H 5 ft.

Ballista, Medium

Cost: 750 gp

Range Increment: 250 ft.

Critical: x3

Crew: 4

Aim: 5 full rounds

Reload: 5 full rounds

Move: 5 ft.

Dimensions: L 7.5 ft., W 7.5 ft., H 5 ft.

Ballista, Heavy

Cost: 1,000 gp
Range Increment: 300 ft.
Critical: x3
Crew: 6
Aim: 8 full rounds
Reload: 8 full rounds
Move: –
Dimensions: L 10 ft., W 10 ft., H 8 ft.

BATTERING RAM

Commonly a huge, iron-shod timber or log suspended by chains from a wheeled frame, the battering ram's crew must otherwise provide all the force for both movement and attacks. A roof of turtle shells (see below) shields the crew. Once the battering ram maneuvers into place against the wall or gate, it can attack once every three rounds, if fully crewed. If the crew is reduced by up to half, it can attack every six rounds. If the crew is reduced to less than half, the ram does not function. Using the ram requires a crewman to make a Profession (siege engineer) check (DC 20). If successful, apply damage to the wall.

Battering Ram, Medium

Cost: 2,000 gp
Damage: 4d6 (bludgeoning)
Critical: x3
Crew: 10
Move: 15 ft.
Dimensions: L 15 ft., W 10 ft., H 8 ft.

Battering Ram, Heavy

Cost: 3,000 gp
Damage: 8d6 (bludgeoning)
Critical: x3
Crew: 20
Move: 5 ft.
Dimensions: L 30 ft., W 15 ft., H 10 ft.

BELLY CROSSBOW

The belly crossbow is essentially an extremely large, man-portable crossbow. It consists of the bow, a stock with ratchets attached, and a slider with a trigger mechanism. The stock is a half-circle held against the user's belly to steady and aim the device, with a wooden leg or other support helps displace the weight. After the device fires, the user braces the end of the weapon against the ground or a wall, and uses his body weight to assist in reloading the device by compressing the slider, one ratchet at a time. This use of a mechanical device to reload the bow allows a much greater draw strength

than is possible with a standard heavy crossbow. Its great size and weight (40 lb.) usually limits its use to sieges. Since this device is man-portable, it is not subject to the normal siege engine movement rules.

It requires two hands to load, aim, and fire. Its wielder can aim and fire as a full-round action.

Cost: 150 gp
Damage: 2d8 (piercing)
Critical: 18-20/x2

Range Increment: 150 ft.
Crew: 1
Reload: 3 full rounds
Move: 20 ft.
Dimensions: L 4 ft., W 4 ft.

CATAPULT

A catapult is a device designed to throw stones or other large projectiles great distances. The range of catapults is quite impressive; point blank range is 150 to 200 yards. At that range, a medium catapult can strip battlements from stone walls. The most common variation is the mangonel, a wooden arm tipped with a metal cup. Bundled fibers bind the

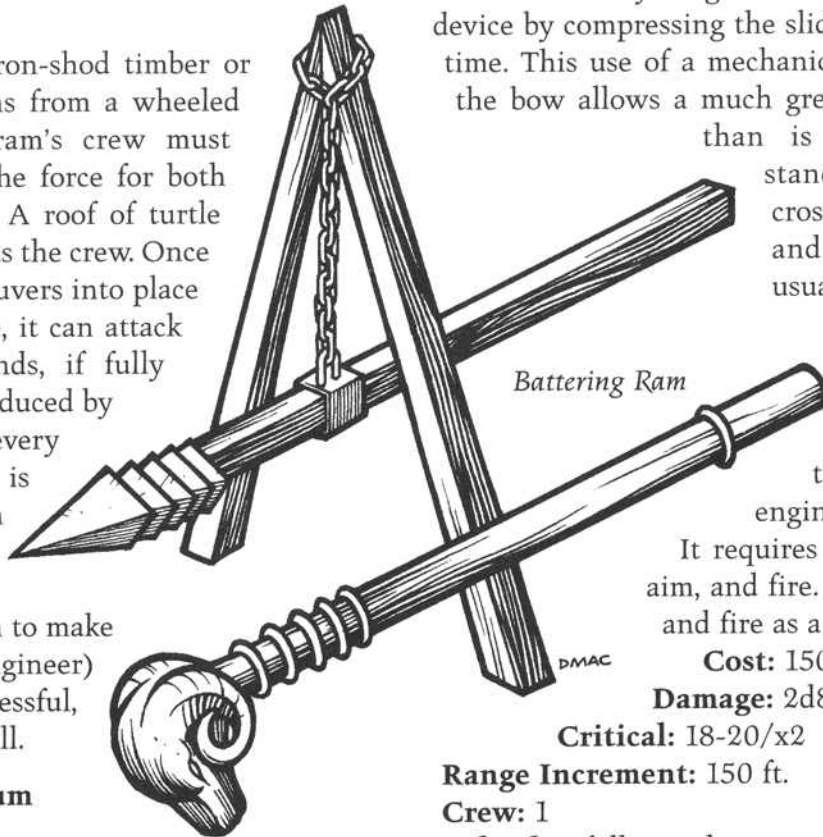

THE HELEPOLIS

Perhaps the largest siege tower ever built was the Helepolis, "the City Taker" Built by Demetrius the Besieger in 304 B.C. for the siege of Rhodes, this mammoth contraption stood over 130 feet tall and weighed well over 150 tons. The flanks and rear bore iron plating as protection from fire, and the tower itself did not have a drawbridge allowing for a wall assault.

The Helepolis provided covering fire for the attackers, and hammered at the defenders' fortifications. With a crew of 200 men, the lowest floor had two 200 lb. catapults, and two 60 lb. catapults. The second floor had three 60 lb. catapults. Each of the next five floors had two 30 lb. catapults, and the top two floors each had two light ballistae. All of these weapons fired through artillery ports in the front the tower.

The ports could open and close mechanically, and had leather and wool cushions to protect them from the shock of missile fire. The heavy stone-throwers could shatter stone ramparts and eventually bring down entire walls. Unfortunately for the army besieging Rhodes, the siege failed. The Helepolis lost some of its iron plating due to heavy missile fire, opening the massive structure to the danger of fire, and so it withdrew from battle before it fell.

The city of Rhodes withstood the siege, and the attackers eventually retreated, leaving the Helepolis and the rest of the siege machines strewn around the city. The scrap metal from these siege weapons provided the raw materials for the statue that the Rhodians subsequently erected at their harbor entrance: the Colossus of Rhodes, one of the seven wonders of the ancient world.

arm, providing propulsion for any projectiles in the cup. This arrangement stands upon a moveable wooden frame. The arm cranks into firing position using a windlass on the side the device, the crew fill the cup, and throw the trigger lever. The missiles travel an arching trajectory that can easily clear walls to hit targets inside a castle, if desired. Catapults cannot fire at targets at a distance of less than half the range increment, and they cannot cause critical hits. Firing a catapult requires a Profession (siege engineer) check by one of the crewmen.

Catapult, Light

Cost: 550 gp

Range Increment: 300 ft.

Crew: 2

Aim: 5 minutes

Reload: 5 full rounds

Move: 15 ft.

Dimensions: L 7.5 ft., W 5 ft., H 5 ft.

Catapult, Medium

Cost: 750 gp

Range Increment: 450 ft.

Crew: 4

Aim: 8 minutes

Reload: 8 full rounds

Move: 10 ft.

Dimensions: L 10 ft., W 7.5 ft., H 7.5 ft.

Catapult, Heavy

Cost: 800 gp

Range Increment: 600 ft.

Crew: 5

Aim: 10 minutes

Reload: 10 full rounds

Move: 5 ft.

Dimensions: L 15 ft., W 10 ft., H 10 ft.

PERRIER

The perrier is a projectile-throwing device bearing similarities to both the catapult and the trebuchet. It has a long, wooden lever arm, with a sling similar to the trebuchet's. The perrier is

unique among siege engines, however, in that sheer muscle power provides its propulsion. On the end of the lever arm are several ropes. Three to five men crew these ropes, and they fire the projectile by pulling down on them. When the arm movement hits its mechanical stop, one side of the sling unhooks itself, releasing the projectile. Since the weight of the lever arm resets it to firing position upon the ropes' release, this device can achieve a very high rate of fire for a siege engine, as many as 10 shots per minute, or once per round. This comes at the expense of requiring smaller projectiles and more crewmen. The range of the device is also shorter than a catapult. Perriers cannot fire at targets at a distance of less than half the range increment, and cannot operate with less than half crew. Perriers cannot cause critical hits.

Perrier, Light

Cost: 500 gp

Range Increment: 100 ft.

Crew: 8

Aim: 5 minutes

Reload: Can fire once per round

Move: 15 ft.

Dimensions: L 10 ft., W 5 ft., H 10 ft.

Perrier, Medium

Cost: 750 gp

Range Increment: 150 ft.

Crew: 11

Aim: 8 minutes

Reload: 1 full rounds

Move: 10 ft.

Dimensions: L 15 ft., W 10 ft., H 15 ft.

SAMBUCA

The *sambuca* was an ingenious type of siege ladder developed by the Greeks during the Peloponnesian War, circa 425 B.C., perhaps as a precursor to or variation of the siege tower. It holds several advantages over a conventional scaling ladder: it eliminates the need to accurately estimate the height of the wall, it can stand farther away without having to cross a surrounding moat or

ditch, and, most importantly, the defenders have no chance to push it away before the attackers are upon them.

The *sambuca* consists of a wheeled chassis supporting a long arm, slightly off center, with a compartment for a massive counterweight on one end of the arm and a carriage on the other end. The assault force of 10-12 men mount the carriage from the ground by a short ladder, then crew fill the counterweight compartment with several tons of stones or other ballast. This weight raises the carriage high into the air, above the level of the wall. The device then moves into position near the wall. A capstan at the fulcrum of the arm lowers the carriage, allowing the assault force to storm out onto the top of the wall. Turtle shells usually protect the carriage and structure, but the below prices do not include such armor. Ships even used this device when assaulting a fortified port city.

Cost: 800 gp

Crew: 4 to operate arm, 20 to move

Move: 5 ft.

Dimensions: variable, depending on the height of the wall and width of any moat or ditch

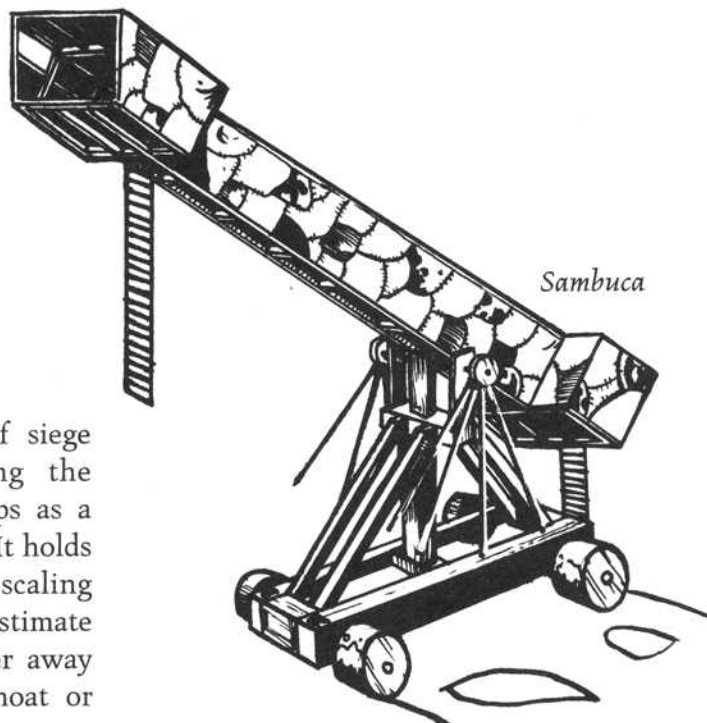

SIEGE TOWER

The siege tower is a device designed to allow the besieging army to assault the top of the wall directly, with minimal danger to the assault force during the approach to the wall. It consists of a tower with a protected enclosure and a drawbridge on top, at a level slightly higher than the height of the castle wall, built onto a wheeled chassis that allows the structure to be moved into position near the wall. The assault troops climb up stairs or ladders into the enclosure, and wait for the tower to move into position. The number of assault troops who can initially fit in the enclosure depends on the size of the structure, with reinforcements quickly following. The drawbridge is generally only 10-15 ft. long, so the army must first fill or bridge any moat. The armor of siege towers consists of wet hides or metal plates to protect the structure and the men inside from missile fire. Due to the varying heights of castle walls, engineers must build siege towers on-site.

Siege Tower, Light

Cost: 750 gp

Crew: 10

Assault Troop Capacity: 4

Move: 10 ft.

Dimensions: L 10 ft., W 10 ft., H 20-30 ft.
(depends on height of castle wall)

Siege Tower, Medium

Cost: 1,000 gp

Crew: 20

Assault Troop Capacity: 8

Move: 10 ft.

Dimensions: L 15 ft., W 15 ft., H 30-45 ft.

Siege Tower, Heavy

Cost: 1,500 gp

Crew: 30

Assault Troop Capacity: 16

Move: 5 ft.

Dimensions: L 20 ft., W 20 ft., H 45-60 ft.

Siege Tower



TREBUCHET

The trebuchet is a projectile-throwing device similar to the catapult, with two major differences. Instead of a cup on the end of the arm, the trebuchet uses a sling attached with hooks and loops. When the throwing arm reaches the limit of its travel, half of the sling slips off the hooks, releasing the projectile in a high, arching trajectory. The other major difference is in the throwing arm. The trebuchet's throwing arm rotates freely around a fulcrum, similar to a perrier. Whereas the catapult uses torsion applied at the base of the throwing arm, the trebuchet uses a heavy counterweight attached to the opposite end of the throwing arm.

This device is superior in some respects to the catapult, with mechanical failure being less common, and it has no torsion bundles that can become stretched. It relies only on gravity to throw its missiles. Because of the firing trajectory, the range of a trebuchet is greater

than a catapult. It is much larger and harder to move, however, and remains in battle once it arrives. Trebuchets cannot fire at targets at a distance of less than half their range increment. Firing the trebuchet requires a Profession (siege engineer) check (DC 20). Trebuchets cannot cause critical hits.

Trebuchet, Light

Cost: 750 gp
Range Increment: 450 ft.
Crew: 6
Aim: 10 minutes
Reload: 5 full rounds
Move: 5 ft.
Dimensions: L 10 ft., W 5 ft., H 10 ft.

Trebuchet, Medium

Cost: 1,000 gp
Range Increment: 600 ft.
Crew: 10
Aim: 15 minutes
Reload: 10 full rounds
Move: 2.5 ft.
Dimensions: L 15 ft., W 10 ft., H 15 ft.

Trebuchet, Heavy

Cost:
Damage: 1,250 gp
Range Increment: 750 ft.
Crew: 15
Aim: 20 minutes
Reload: 15 full rounds
Move: —
Dimensions: L 25 ft., W 15 ft., H 25 ft.

TURTLE SHELL

A turtle shell, also known as a tortoise, refers to any structure built to defend against missile fire. Engineers typically mount turtle shells on wheels and shieldings for assault troops as they approach the wall, as well as to protect sappers and laborers near the mouth of a tunnel. Most often built from metal plates attached to a wooden frame, other

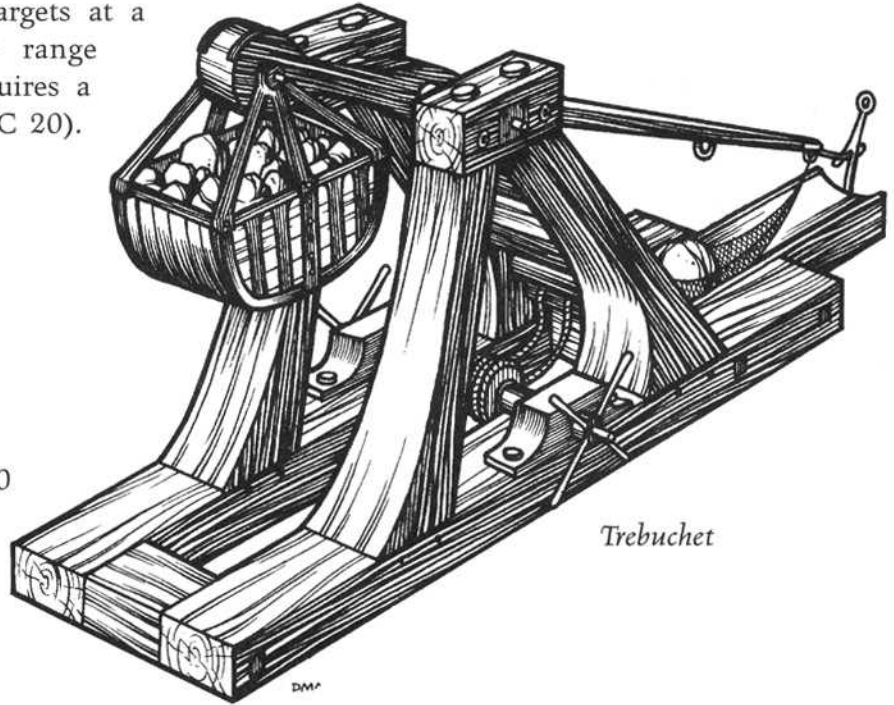

Trebuchet

designs include wooden planks covered by water-soaked hides (to protect from flaming arrows). The costs of siege equipment do not include turtle shells.

Cost: 150 gp (wood and hides), 350 gp (metal plates)

Move: 15 ft.

Dimensions: W 10 ft., H 10 ft.

CANNONS

Cannons come in an astonishing variety of sizes, here classified as light, medium, and heavy for the sake of simplicity. They are a special type of siege weapon, arguably more powerful than magic. They are incredibly effective at simply blasting enemy defenses and siege engines to bits. The DM may wish to use as much care with cannons as with magic in a siege, and many DMs will not use gunpowder weapons of any type in their campaigns.

Cannons fire much like other siege weapons, except the crew makes a Profession (gunnery)

check. Only one crew need fire a cannon, but a single man crewing it triples the reload and aim times. If two men aim and load the cannon, the time is doubled. This holds true for moving the cannon as well. Cannons cannot cause critical hits.

Cannon, Light

Cost: 1,500 gp
Damage: 7d6
Range Increment: 225 ft.
Crew: 3
Aim: 4 full rounds
Reload: 4 full rounds
Move: 10 ft.

Cannon, Medium

Cost: 2,500 gp
Damage: 10d8
Range Increment: 275 ft.
Crew: 3
Aim: 4 full rounds
Reload: 4 full rounds
Move: 10 ft.

Cannon, Heavy

Cost: 4,000 gp
Damage: 12d10
Range Increment: 300 ft.
Crew: 3
Aim: full round
Reload: full round
Move: 5 ft.

AMMUNITION

Each type of ammunition lists which type of siege engine can fire it, and each type comes in different sizes, usable in siege machines of commensurate size (i.e., light catapults use light ammunition, medium ballistae use medium ammunition, etc.).

ANIMAL CARCASS

Besieging armies wishing to spread disease and demoralization within the castle occasionally resort to throwing the carcasses of dead livestock, or even

prisoners, into the castle. For every day that castle defenders cannot dispose of the rotting animal carcasses, they must make Fortitude saves (DC 12) or suffer the effects of Filth Fever. Filth Fever has an incubation period of 1d3 days, and causes a loss of 1d3 Dex and 1d3 Con.

Cost: 0 gp
Light: Small size creatures
Medium: Medium size creatures
Heavy: Large creatures
Usable in: Catapult, perrier, trebuchet

CANNON SHOT

A cannon shot is a simple ball of metal, usually lead or iron. It is physically similar to the metal shot described below, but cannons cannot fire those primitive projectiles. The sizes and damage ratings are therefore different. Even though the missiles are smaller, however, they do considerably more damage when fired by a cannon than when lobbed by a siege engine.

Light: Damage: 7d6 bludgeoning; 6 lbs.;
 Cost: 1 gp.
Medium: Damage: 10d8 bludgeoning; 12 lbs.;
 Cost: 2 gp.
Heavy: Damage: 12d10 bludgeoning; 20 lbs.;
 Cost: 3 gp.
Usable in: Cannons

GRAPE SHOT

One of the deadliest anti-personnel weapons ever conceived, a cannon loaded with grape shot is the terror of any infantryman. Grape shot is actually hundreds of small metal balls or splinters, usually made of lead, about the size of grapes. A cannon loaded with grape shot essentially becomes an enormous shotgun, spewing a swath of death before it. Grape shot is only effective at close range against troops, not against other siege machines. When fired, it creates a cone area of effect of length equal to half the normal range increment of the cannon, and half the normal width. The shot hits everything exposed within this area, and anything at a range of

more than half the maximum distance takes only half damage. For example, a medium cannon has a range increment of 275 ft. When using grape shot, the area of effect is a cone extending from the muzzle of the cannon, where it is five feet wide, to about 140 ft. away, where it is 70 ft. wide. Any targets farther than 70 ft. from the cannon take half damage. A Reflex save (DC 20) reduces the damage to half (cumulative with range). The DM should consider that the grape shot is a swarm of direct-fired projectiles, so if fired into a mass of targets, individuals behind those unfortunate victims closest to the cannon may take reduced damage from the cover given by interposing bodies, or no damage at all, at the DM's discretion.

Light: Damage: 4d6 piercing. Cost: 3 gp.

Medium: Damage: 8d6 piercing. Cost: 6 gp.

Heavy: Damage: 12d6 piercing. Cost: 9 gp.

Usable in: cannons

JAVELIN

Similar to hand-thrown javelins, these are common ammunition for ballista, but reinforced to withstand the incredible force the ballista exerts to fling them such great distances. Ballista bolts also

use small, wooden fins similar to arrow fletching to stabilize the missile in flight. Ballista bolts fire with such force that they can run through multiple targets. Fired in a straight line from the end of the siege engine, the javelin has a chance to strike the first creature in its path. If it misses, roll to hit every creature in the missile's path until a hit is scored. If it hits, roll damage. If the target falls to the javelin's damage, it passes through the target's body and continues on to the next target in line. Roll to attack the next creature in its path, reducing any damage by a d6. Continue this until the javelin reaches its maximum range, fails to penetrate, until the damage falls to 0d6, in which case the javelin stops. For example, the medium javelin hits a line of orcs, killing the first in line. It passes through the first and hits the second. The damage rolled against the second is 3d6 (4d6-1d6). The second orc dies. If the javelin strikes the third orc, it inflicts 2d6 damage, and so forth.

Light: Damage: 2d6 piercing; 2 lb.; Cost: 1 gp.

Medium: Damage: 4d6 piercing; 4 lb.;

Cost: 2 gp.

Heavy: Damage: 6d6 piercing; 6 lb.; Cost: 3 gp.

Usable in: Ballista

JAVELIN, FLAMING

This is a normal javelin wrapped in pitch-soaked cloth or some other combustible substance to set the tip afire before launch. It is identical to a normal javelin in all respects, save that there is a chance that any target hit by a flaming javelin catches fire. The favored target of this ammunition is not troops, but rather enemy siege engines.

Light: Damage: 2d6 piercing plus 1d6 fire.; 2 lb.; Cost: 2 gp.

Medium: Damage: 4d6 piercing plus 2d6 fire.; 4 lb.; Cost: 4 gp.

Heavy: Damage: 6d6 piercing plus 3d6 fire.; 6 lb.; Cost: 6 gp.

Usable in: Ballista

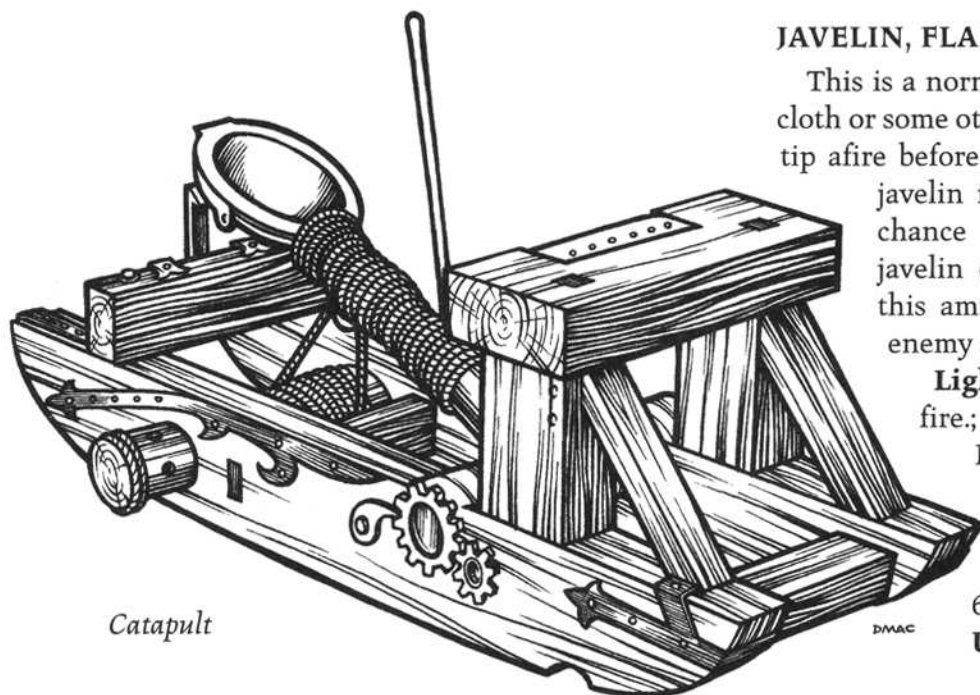

Catapult

DMAC



METAL SHOT

This is a large ball of metal, usually lead. They come in practically any size, but are divided here for the sake of simplicity into three categories. Metal shot thrown by siege engines can do tremendous damage to structures and walls and turn enemy troops into little more than pulpy smears. They do more damage than simple catapult stones, but they are also more expensive because they have to be cast from molten metal.

Light: Damage: 7d4 bludgeoning. 20 lb.; Cost: 5 gp.

Medium: Damage: 10d6 bludgeoning; 100 lb. Cost: 25 gp.

Heavy: Damage: 12d8 bludgeoning; 200 lb.; Cost: 50 gp.

Usable in: Ballista (light ammunition only), catapult, perrier, trebuchet

PITCH BARRELS

Barrels of flaming pitch are a devastating means of raining fire and destruction down upon the enemy. When they strike the target, the container splatters sticky, burning pitch all over everything within a certain burst radius. Anything caught within the burst radius takes damage from the fire, reduced by half on a successful Reflex save (DC 20). Furthermore, anything in the burst radius must make a Reflex save (DC 15) or catch fire. The fire burns for a duration listed below unless extinguished, and anything within the radius of the fire takes 1d6 fire damage each round until the flames disappear, in addition to any damage from being on fire itself.

Light: Burst radius: 5 ft.; Duration: 10 minutes; Damage: 2d6 fire; 10 lb.; Cost: 10 gp.

Medium: Burst radius: 10 ft.; Duration: 20 minutes.; Damage: 4d6 fire.; 30 lb.; Cost: 30 gp.

Heavy: Burst radius: 15 ft.; Duration: 30 minutes.; Damage: 6d6 fire.; 50 lb.; Cost: 50 gp.

Usable in: Ballista (light ammunition only), catapult, perrier, trebuchet

RED HOT SHOT

This type of ammunition is similar to standard metal shot in most respects. It is always cast iron. The crew heats it until it literally glows red-hot. This ammunition sets wooden objects aflame in addition to its impact, extremely useful for destroying siege equipment and buildings. Any combustible object red-hot shot strikes has a chance to catch fire.

Heavy shot requires 2-3 men to load it, who must then launch it quickly from a trebuchet or perrier, before it sets the sling afire. Siege engines that use a metal-lined cup or groove, like the catapult and ballista respectively, can use red-hot shot without this danger. The tremendous amount of heat stored inside the glowing shot causes fire damage and the possibility of ignition every round for 2d6 minutes.

Light: Damage: 7d4 bludgeoning plus 1d6 fire; 20 lb.; Cost: 5 gp.

Medium: Damage: 10d6 bludgeoning plus 2d6 fire.; 100 lb.; Cost: 25 gp.

Heavy: Damage: 12d8 bludgeoning plus 3d6 fire.; 200 lb. Cost: 50 gp.

Usable in: Ballista (light ammunition only), catapult, perrier, trebuchet

STONES

Simple stones of various sizes are the cheapest, most plentiful type of siege engine ammunition. A stone launched from several hundred feet away has tremendous destructive power, capable of flattening battlements, splintering buildings, and punching holes in thick walls, not to mention any unfortunate creatures in their path. For the sake of simplicity, assume the size of stones classed here. Unless fighting in locales without large stones, armies may scavenge for these stones without charge.

Light: Damage: 5d6 bludgeoning; 20 lb.

Medium: Damage: 8d6 bludgeoning; 100 lb.

Heavy: Damage: 10d8 bludgeoning; 200 lb.

Usable in: Ballista (light ammunition only), catapult, perrier, trebuchet

THUNDER CRASH BOMBS

Similar to flaming pitch, but far more destructive, are thunder crash bombs. They are metal canisters, usually fashioned like a clamshell, filled with gunpowder, and fitted with a specially-timed fuse. The bomb hopefully explodes nearest the moment of impact. In addition to the normal Profession (siege engineer) check to hit the desired location, the crew must make a Profession (gunnery) check at DC 15 to ensure the device explodes at nearly the moment of impact. This second check is independent of hit location, occurring even if the bomb deviates. If this second check fails, the device explodes prematurely during its trajectory, causing no damage.

Light: Burst radius: 5 ft.; Damage: 4d10 piercing plus 1d4 fire; 10 lb.; Cost: 50 gp.

Medium: Burst radius: 10 ft.; Damage: 8d10 piercing plus 1d6 fire; 50 lb.; Cost: 100 gp.

Heavy: Burst radius: 15 ft.; Damage: 12d10 piercing plus 1d8 fire.; 100 lb.; Cost: 150 gp.

Usable in: Ballista (light ammunition only), catapult, perrier, trebuchet

PICK-AXE OF DOLMIR

Medium Wondrous Item

Appearing as a well-worn pickaxe of dwarven make, this was the favored tool of Dolmir, one of the greatest miners in all of dwarf history. When he died in a cave-in, his friends never recovered his body, finding only this curious item instead.

The user of this item can tunnel through solid rock and earth at a rate of 20 ft. per hour. Three times per day the user can cast the spell *soften earth and stone*. This makes tunneling or mining using this tool extremely easy, greatly increasing tunneling speed.

Caster Level: 8th, *Prerequisites:* Craft Wondrous Item, *soften earth and stone*. *Market Value:* 40,000 gp. *Weight:* 8 lb.

DEFENSIVE WEAPONS

Defenders have many options and special weapons unavailable to the attackers. Since the attackers usually expose themselves when approaching the castle walls, a favorite tactic of defenders is to throw weapons down on the attackers, trying to kill or injure as many as possible while they are exposed and vulnerable. Below is a list of things used for this purpose. Unless otherwise noted, each type of material is considered to have a 5 ft. burst radius when dropped from above. Anyone caught in the burst radius takes damage, reduced to half by a successful Reflex save (DC 15).

BOILING OIL

This is often a defense of last resort due to the enormous expense of such a large amount of oil. It is, however, one of the most effective. When dumped, the boiling oil splatters over everything within the burst radius, causing damage from its tremendous heat. A dropped torch or lantern can easily set it alight, causing a firestorm to erupt that lasts for 2d6 rounds. This almost certainly destroys any siege engine caught in the blaze, as well as killing most any unfortunate crewmen.

Damage: Initial 4d6 fire, secondary damage 4d6 fire per round, plus catch fire; Cost: 500 gp.

BOILING WATER

A favorite of defending armies, scalding hot water and steam can cause horrible burns to anyone caught in the area of effect. Defenders do not use this unless they have a renewable supply of water.

Damage: 2d6 fire

BOILING SEWAGE

The usual retort to flung animal corpses, this is a disgusting mess from chamber pots, stables, and kitchens, cooked up into a scalding hot goop and dumped on the enemy. Any defenders within 20 ft. of the cauldron before it is dumped must make a Fortitude save (DC 15) or become nauseous as if the area is a stinking cloud. Anyone within 20 ft. of the burst radius must make a Fortitude save (DC 25) or become nauseous.

Damage: 2d6 fire, plus nausea.

BURNING PITCH

The next best thing to boiling oil, burning pitch does not burn as fiercely, but it does burn longer. Once poured and set aflame, the resulting conflagration lasts for 2d6 minutes, almost certainly destroying any siege engine and its crew.

Damage: Burst radius: 10 ft.; Initial 2d6 fire, secondary damage 1d6 fire per round, plus catch fire.; Cost: 300 gp.



HOT SAND

A desert equivalent of boiling water, sand easily settles into joints in armor, especially chain mail, causing painful burns constantly irritated by grit. Victims lose 1d3 Dex temporarily, until they clean the sand out of their burns, clothing, and armor. Unless used in an exotic locale, hot sand has no cost.

Damage: Initial 1d6 fire, secondary damage 1d3 damage for 1d4 rounds.

MOLTEN LEAD

One of the most horrible of all siege defenses, molten lead splashes like water, spilling through cracks and crevices in armor, splattering over exposed flesh, and searing into skin like white-hot agony. Sometimes called 'death rain,' the molten metal burns deep into flesh and hardens as it cools. Healers must then dig out the hardened droplets of lead from the heat-ravaged flesh. Any creature within the burst radius takes 3d6 damage from initial heat blast, and 1d3 damage per round for the next 1d10 rounds until the lead cools. Since the lead is not hot enough to set wooden structures ablaze, defenders use it only against enemy troops.

Damage: Burst radius: 10 ft.; Initial 3d6 fire, plus 1d3 damage per round for 1d10 rounds; Cost: 200 gp.

**THE ORB OF OKIRSI****Major Artifact**

This powerful artifact is an obsidian black orb about one foot in diameter, and may be mistaken for a *sphere of annihilation*. Its surface is completely smooth, almost frictionless, and it rests in a rusty iron bowl. It is so black that onlookers claim that it devours the light around it. No magic of any kind functions within 100 yards of this object. Spells originating from outside the shell, such as *fireball*, *ice storm*, etc., cast at anything within the area will not penetrate, dissipating into nothingness when they contact the boundary. Creatures *summoned* outside the area can move into the shell normally. Creatures sustained by magic, like undead and golems, collapse when subjected to the shell's influence, but are otherwise unharmed. Creatures with spell-like abilities, such as dragons, cannot use those abilities within the boundary of the shell. Supernatural and extraordinary abilities function normally.

The use of this artifact has a dangerous price, however, one not immediately apparent. The Orb draws out the life force of anything within its sphere of influence. Every living creature ages 1d3 years for every day spent within the shell's protection.

There is no magical way to prevent these effects, since magic does not function within the shell.

CHAPTER FOUR:

WAR MAGIC

Magic is a real and powerful force in a fantasy setting, possibly the most powerful. Wizards and sorcerers use arcane rituals to rain fire from the heavens, trick the eye, and even grant wishes. Divine powers trust to the wisdom and judgment of their clergy, and grant clerics phenomenal powers of healing and miracles, making them the guardians of life and death. With such power at people's fingertips, how is the face of war changed?

The DM should first consider magic's place in his campaign setting. A world with magic as a rare or hidden force is little different from reality, but high magic worlds approach or surpass modern technology's effect on warfare.

A spellcaster in military service can provide all manner of support, either as a relatively simple artillerist, or as a spy or tactical leader. Offensive spells have their uses, but the true uses of a spellcaster shine when they integrate with the general's already existing strategy. Hallucinatory Terrain is merely the most obvious practical application of magic in a tactical setting. Even a simple gust of wind can wreak havoc on a unit of archers, and the effects of an improved invisibility spell on an experienced barbarian are better left seen than described.

While the above are some uses of magic in a tactical setting, the overall strategic abilities of a powerful wizard, sorcerer, or cleric should not be overlooked, either. Teleportation and similar spells make communication a far simpler proposition. The counterintelligence capabilities of modify memory are endless. The magical wall spells make fortification a matter of minutes instead of months. Nearly any spell can have tactical or strategic applications with enough cunning.

Below is a list of the common applications of arcane magic, grouped by school. It is by no means exhaustive, nor does it limit the most crafty spellcaster.

Abjuration: Abjuration is the art of barriers and wards. In war, this school is particularly effective when creating fortifications and protecting resources (such as soldiers). Abjuration spells are a wizard's first line of defense against ambush, surprise, or siege. Such abilities are equally useful to a general, reinforcing normal precautions such as sentries. Abjuration spells are especially useful in a siege situation, stopping and slowing down an invading force indefinitely, or at least until reinforcements can be brought in.

Alarm is an ideal spell for use in war, with even a moderately powerful spellcaster able to protect an encampment for a night. Barring their own magics, no invading force can gain surprise on the camp. Spells such as hold portal, arcane lock, and others that reinforce or trap entrances make for excellent use during a siege, giving a defending force time to gather and regroup. Even the various protective spells, like protection from arrows, shield, and stoneskin, while useless on large groups, can protect important leaders and officers from enemy attacks during a battle. Finally, abjuration spells are the first line of defense against hostile magic, making them especially important against enemy spellcasters. Even if a spellcaster does nothing but maintain the status quo by negating enemy spellcasters, he serves a valuable purpose.

Conjuration: Conjuration, while not as direct as other schools, can still provide a valuable asset in battle. The art of creation is valuable even in war,

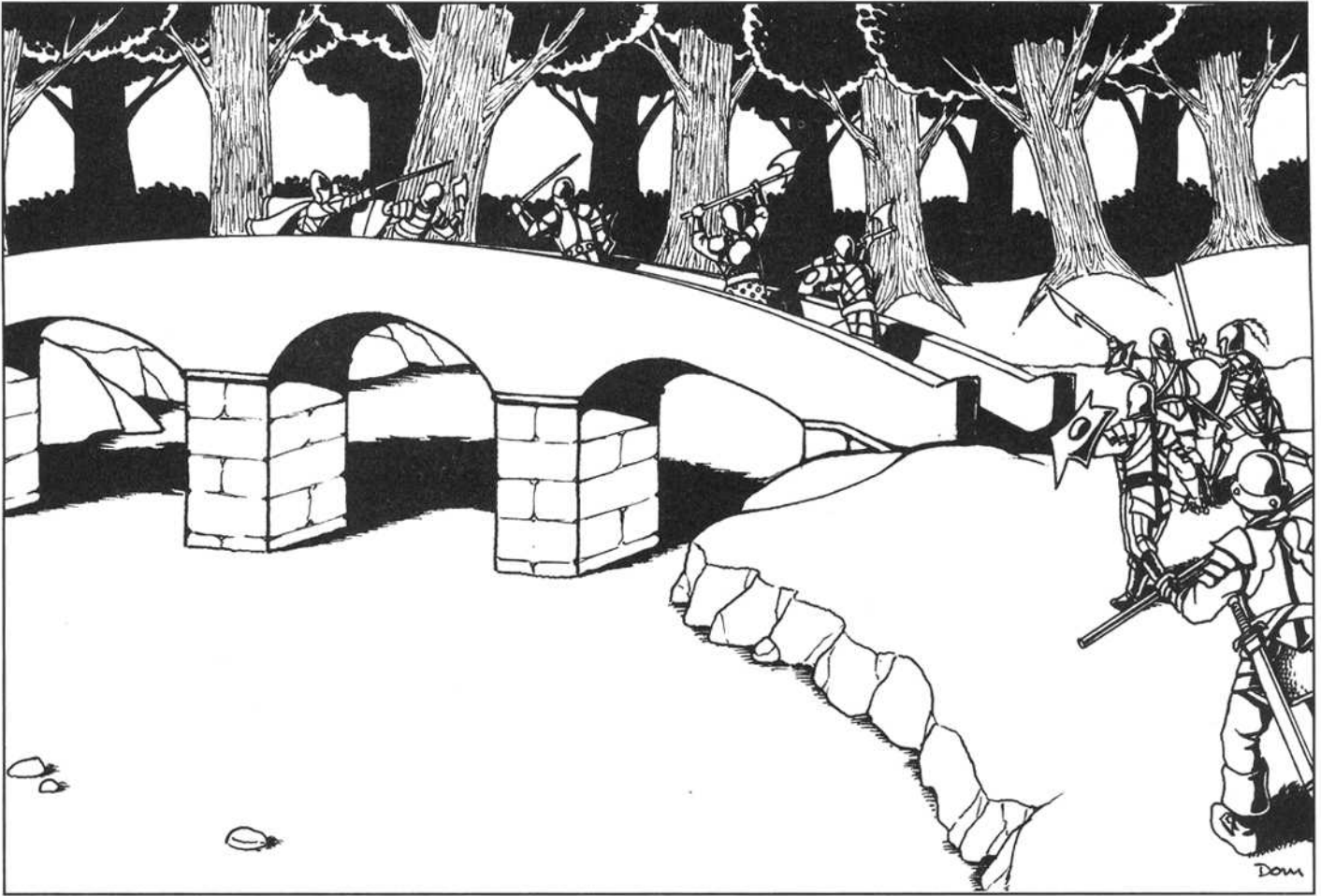

when generals must use every resource wisely. Due to the variety of conjuring spells available, there are no guidelines for the school as a whole, but certain individual spells stand out for their efficacy in war.

The summon monster spells provide reinforcements on a small scale, but is of dubious ability when put up against an entire army. Instead of summoning a creature to directly combat an enemy force, spellcasters can summon monsters anywhere within range, such as in front of (or better yet, behind) an enemy officer or spellcaster. Many other conjuration spells can benefit an intelligent tactician, as well. The various weather spells (fog cloud, sleet storm, etc.) can hide an ambushing army, or hinder a ranged unit. Cloudkill is an especially gruesome spell on the battlefield, since not only are most armies made up of low-level characters, but the cloud moves along the ground.

Properly placed and timed, this spell could potentially destroy entire units at a time. Finally, while the least spectacular member of any spellcaster's repertoire, power word, kill is neat, efficient, and deadly. There are very few things more demoralizing to a soldier than seeing an entire rank of an army simply die simultaneously.

Divination: Many would doubt the value of the divination school in war. They are fools, for divination is arguably the most powerful school. Perhaps the most important aspect of war is information, and a general who knows his opponent's plan has a significant advantage in battle.

Detect thoughts, used in the right circumstances, gives a crucial edge. In fantasy warfare, opposing sides often meet outside of the battlefield, without bloodshed. Courts, negotiations, and even outright

espionage are excellent opportunities to spy on an enemy's surface thoughts. *Clairaudience* /*clairvoyance*, if cast at the right time, removes the necessity for face-to-face contact to spy on an opponent. The virtues of scrying are innumerable, and while deities are often quiet about the mysteries of the universe, they are usually not so tight-lipped about the specific movements of a certain army (contact other plane). Finally, the various spying spells are naturally useful for tracking important personages in enemy forces.

Enchantment: Enchantment spells, dealing with minds and motives, have excellent uses against an enemy. The right spell can cause a loyal follower to betray his leader without a thought, and without a trace of interference. An enchanted character, entrusted with military secrets, could wreak havoc upon his own allies. While this strategy requires a bit of forethought and planning, it can go a long way towards victory. Less flashy but no less devastating than a fireball into the ranks, enchantment can make an enemy an ally.

Charm person has a short-lived effect, but is nevertheless quite useful. A *charmed* character might not blindly face death for the enchanter, but such is rarely necessary. Espionage and sabotage are perfectly reasonable actions to ask a *charmed* person to perform, and the charmed character will be hard-pressed to explain himself once the spell wears off. *Suggestion* can have an even even greater effect, causing rebellions in the enemy ranks.

Evocation: The art of channeling power, evocation is usually the most impressive and loudest of magical schools. Evocation is simple war magic; it causes a great deal of destruction in a certain area. Just because evocation is the easiest school to use directly, however, is by no means the extent of the school's versatility.

Anybody can throw a fireball or lightning bolt, but like any other offensive weapon, there are ways to maximize their efficiency. Mowing down a rank of enemy soldiers is all well and good, but destroying an enemy's artillery, siege weapon, or other specialized equipment is better.

Furthermore, while people generally do not ignite particularly well, wood does. Even the seemingly inoffensive gust of wind has valuable tactical merit, rendering a volley of arrows useless, or putting out enemy fires (such as torches, flaming arrows, or signal fires). The various light-affecting spells (*daylight*, *darkness*, etc.) can reveal or obscure different parts of a battle, either giving or removing the benefit of surprise. In addition, evocation has its share of *wall* spells, usually far more dynamic (but less solid) than those covered by conjuration. Consider the implications of creating a *wall of fire* directly in front of a unit of charging cavalry. Finally, sending may just be the single most useful spell in a spellcaster's repertoire for military purposes. The importance of sending and receiving orders and intelligence to anybody, anywhere cannot be overstated. Such capability has revolutionized warfare in the real world, and should be no less valuable in fantasy settings.

Illusion: The art of illusion is that of deceit, and misdirection certainly has its place in warfare. Much like enchantment spells, the major use of illusion is in intelligence and espionage, but illusion also has an application mostly unique to itself: counter-intelligence. By disguising important aspects of his force, a spellcaster can prevent an enemy from learning valuable information, or even cause them to believe a fallacy.

Even such minor spells as *dancing lights* and ghost sound can hide a night ambush, distracting a target from one direction while the true threat comes from another. *Change Self* is an ideal tool for a spy or saboteur, enabling them to get close to enemy resources by pretending to be one of them. Just as useful on the battlefield, the spell can cause great mischief with a spellcaster posing as an officer or other person of power, hindering an army's efficacy. The various image spells can wreak havoc on a battlefield, creating the illusion of enemy units, monsters, or other effects. *Hallucinatory terrain* deserves special mention for its usefulness in a battle, making the landscape more conducive to the army's goals.

Necromancy: For an arcane spellcaster, necromancy is usually an all-or-nothing proposition in war. Most living soldiers are squeamish about fighting alongside the undead, and so armies containing the undead are usually composed entirely of them. Furthermore, most necromantic spells are limited to a single target, limiting their effectiveness in mass combat. While certain necromantic spells can have wartime applications, for the most part, the school is too personal for open war.

Fear is an exception to the rule of necromancy being a personal school, working in a wide cone. The spell is especially useful to a spellcaster on the front lines, in danger of hand-to-hand combat. *Clone* can be useful insurance for a general who leads from the front lines, ensuring that his death does not end his campaign.

Transmutation: Transmutation is a surprisingly useful and versatile school of magic, enabling a caster to perform a wide variety of effects. The major limiting factor of transmutation in warfare is the fact that, like necromancy, its effects tend to center around a single target. With the more powerful transmutation spells, however, that target can be an entire mountain or river, dropped on an enemy army.

Message is a useful spell for sending and receiving battlefield communications, and *passwall* makes sieges a thing of the past. *Stone shape* and *move earth* make for instant fortifications. *Teleport* is an invaluable tool for communication, espionage, and intelligence. *Reverse gravity* is a truly interesting spell to cast upon an enemy unit, leaving them open to missile fire and long falls. Finally, *time stop* is as effective in war as it is anytime else, giving a capable spellcaster several seconds uninterrupted to hinder the enemy.

DIVINE MAGIC

To ignore the power of divine magic is to invite the wrath of the gods, who are as active in war as they are in anything else. War is often a contest of ideals, and as immortal personifications of ideals, the gods have a vested interest in the outcome of any war. When nations and concepts all have patron deities, every war is a holy crusade.

Followers of militant gods are most likely equally aggressive, and unlikely to remain aloof from a conflict they feel strongly about. On the other hand, a cleric of a healing or peaceful god shies away from combat, no matter how justified they may consider it.

One important question arises in the case of enemy followers of the same god. Whether the war is between nations or races, if a church is widespread, they may have members on both sides of a war. How do the clergy, and their lay followers, deal with this? Do they consider the enemy counterparts to be heretics, or do they distance themselves from the conflict, separating matters of faith from those of state? While the god's domains may answer these questions, they do not always do so.

In a setting where the wills of the gods are rarely in question, the gods' place in war becomes far more than a semantic question. Most often, divine intervention is dependent upon the scale of the war. A minor border dispute rarely attracts the notice of the gods, but a war that spans the entire world is far too important to ignore. How do the gods react to war, and what do they do to intervene? Most often, a god will react to protect or further the interests of their followers, but how?



WORSHIPPING WAR

War is one of the more complex concepts to assign deities and domains to, because of its inherent lack of alignment. While justice, peace, cruelty, and other such concepts tend to align themselves towards a certain mindset, war is far more universal. War is an ideal held by the lawful, the chaotic, the good, and the evil equally, even if in different ways. Even characters who favor neutrality often find themselves embroiled in wars, if only to restore balance.

The deities below are merely a sample of the war gods and goddesses available for worship. War is a complex enough concept that literally hundreds of deities could find a sphere of influence within it, and never intersect. The DM, as always, should create other such deities as needed.

CORLEIN

Corlein (KOR-layn), god of justice, is lawful good. Known to his followers as the Crusader, he embodies righteous warfare. His followers are primarily paladins and those who have seen evil firsthand, knowing that it must be destroyed at any cost. Corlein's faithful believe in forgiving those who wish to quit the evil ways, and favor mercy, but are willing to die to stop true evil. The highest honor in Corlein's church is to die protecting an innocent or fighting against evil. Corlein's domains include good, law, conquest, and war. He appears as a radiant paladin on a shining warhorse, brandishing his favored weapon, the warhammer.

BRANYEN

Branyen (BRAN-yen), the herald of revolution, is chaotic good. He is the patron of the oppressed, the downtrodden, and all those who believe that life should be better for all, not the few. Many oppress his followers because of the threat they represent to those who use their power for themselves. He is known as the Bringer of Freedom, because of his followers' belief in equality and free will. His domains are war, good, luck, and trickery. He is pictured as a bard, preaching freedom for everyone. His favored weapon is the longsword.

ALIARA

Aliara (Ah-li-AH-ra) is the goddess of strategy and tactics. Lawful neutral, she represents the intellectual side of war, the interaction of minds working their utmost to achieve victory against each other. Her followers include generals and all those whose lives depend upon intelligent strategy. Especially worshipped by soldiers, Aliara grants guidance to the officers of her faithful. She is known as Aliara the Wise, and her followers strive to act strategically in all things. Her domains are war, knowledge, and law. She is pictured as a general, surveying her troops, holding her favored weapon, the spear.

ARNLON

Arnlon (ARN-lon), lawful neutral, is the god of design. His title is the Great Maker, and he is the patron of inventors, engineers, and all others who would use reason and invention to solve a problem. Scientists in a world of magic, his followers often face derision, but none can deny their innovations. Explosives, siege engines, and artillery are only some of their creations. Arnlon's domains include creation, war, and law. He is rarely pictured, but when he is, he is always pictured at work. His favored weapon is the warhammer.

ERGETHEN

Ergethen (ER-geth-en), god of defense and protection, is neutral. He is the patron deity of jailors, bodyguards, and masons. Often called upon by defending generals, he protects those who face overwhelming odds. His title is the Defender. He is depicted as a fully-armored fighter on a wall, carrying his favored weapon, the quarterstaff. His domains include protection, strength, and war.



WAR DIETY DOMAIN TABLE

Diety	Alignment	Domains	Typical Worshippers
Corlein	Lawful Good	War, Good, Law Conquest	Paladins, Justicars, Celestials
Branyen	Chaotic Good	War, Good, Luck, Trickery	Rebels, Oppressed Peoples
Aliara	Lawful Neutral	War, Knowledge, Law	Generals, Officers, tacticians
Arnlon	Lawful Neutral	War Creation, Law	Inventors, engineers, students
Bronegh	Chaotic Neutral	War, Conquest, Chaos, Destruction	Barbarians, Conquerors
Londalia	Lawful Evil	War, Tyranny, Law	Tyrants, Evil Nobles
Boraal	Neutral Evil	War, Evil, Trickery	Traitors, Spies, War Profiteers
Layan'kul	Neutral Evil	War, Evil, Death	Grave Robbers, Cannibals, Scavengers
Pleiagh	Chaotic Evil	War, Destruction, Death	Demons, Conquerors

ARTOH

Artoh (AR-toe), neutral, is known as the Lord of Battles. He is often worshipped, and always acknowledged, by those who wage war as a way of life. He is the tide of battle, the stroke of fate that determines the destiny of armies. He is impartial, swayed by neither law nor chaos, good nor evil, only by love of the battle. His domains are war and luck. He is often depicted as a gray-armored warrior, holding a scale in one hand, and his favored weapon, the longsword, in the other.

BRONEGH

Bronegh (BRO-negh) is the god of conquest. Chaotic neutral, he is the god worshipped by those who seek to conquer others and gain power from war, including many barbarians. Known as the Conqueror, he revels in the way war gives and takes power, and believes those who can conquer, should. While this mentality may imply evil, he does not condone senseless death and destruction, nor does he believe in making war upon the innocent. Neither of those acts bring power, and so are signs of weakness. Bronegh's domains include war, conquest, strength, and chaos. He is depicted as a barbarian astride a mighty warhorse, carrying his favored weapon, the greataxe.

LONDALIA

Londalia (LOAN-dahl-ya) is the goddess of tyranny. Lawful evil, she is worshipped by those whose iron grip upon their power is unwavering. Known as the Tyrant Queen, she believes in acquiring power for its own sake, through any means necessary. While her followers often use war to gain power, to limit their ambition in such a way is to offend their goddess. In war, her name is whispered by those officers whose ambition outstrips their morality, and are willing to pay any price to satisfy it. Her domains include law, war, and tyranny. She is depicted as an erinyes, with her favored weapon, the mace.

BORAAL

Boraal (BORE-all), Lord of Betrayal, is neutral evil. He is worshipped by those who have placed no higher goals than their own well-being, and is the patron god of traitors, war profiteers, and all those who have broken trust. Followers of Boraal are untrustworthy, backstabbing individuals, and owe loyalty to none but themselves. His domains include evil, trickery, and war. Boraal is depicted as a cloaked thief, concealing his favored weapon, the dagger.

LAYAN'KUL

Layan'kul (LIE-an KUL), the Scavenger King, is neutral evil. His worshippers include grave robbers, cannibals, ghouls, and others who take sustenance from the dead. Those who would rob corpses on the battlefield call to him for guidance. His clergy excel at stealing and profiting from the secrets of the dead, and their rites nearly always include cannibalism and tomb desecration. He is a skeletal god, naked and obscene, waving around a headsman's axe with glee. Layan'kul's domains include evil, death, and war.

PLEIAGH

Pleiagh (PLEE-ach), the Wasted, is Lord of Famine. Chaotic Evil, he embodies much of the worst in mankind and war. Worshipped by those who would scour the land of all life, Pleiagh and his followers bring starvation and death to all they encounter. He is also occasionally called to by the starving, who beg his mercy. His clergy are typically either gaunt or obese, symbolizing great waste or want. Pleiagh appears as a gaunt, starving man carrying his favored weapon, a scythe. His domains include war, destruction, and death.

DOMAINS

Domains marked with an asterisk (*) are reprinted from the PHB for the player's convenience.

CHAOS DOMAIN*

Deity: Bronegh

Granted Powers: You can cast chaos spells at +1 caster level

Spells:

1. Protection from Law
2. Shatter
3. Magic Circle against Law
4. Chaos Hammer
5. Dispel Law
6. Animate Objects
7. Word of Chaos

8. Cloak of Chaos
9. Summon Monster IX

CONQUEST DOMAIN

Deity: Corlein, Bronegh

Granted Power: Once per day, you gain the cleave feat

Spells:

1. Command
2. Enthrall
3. Prayer
4. Divine Power
5. Righteous Might
6. Greater Dispelling
7. Repulsion
8. Holy/Unholy Aura
9. Storm of Vengeance

CREATION

Deity: Arnlon

Granted Power: *Minor creation*, 1/day as a spell-like ability.

Spells:

1. Summon Monster I.
2. Make Whole
3. Create Food and Water
4. Restoration
5. Wall of Stone
6. Heroes' Feast
7. Resurrection
8. Mass Heal
9. Summon Monster IX

DEATH*

Deity: Layan'kul, Pleiagh

Granted Powers: You may use a death touch once per day. Your death touch is a spell-like ability that is a death effect. You must succeed at a melee attack against a living creature (using the rules for touch spells). When you touch, roll 1d6 per your cleric level. If the total at least equals the creature's current hit points, it dies.

Spells:

1. Cause Fear
2. Death Knell
3. Animate Dead
4. Death Ward
5. Slay Living
6. Create Undead
7. Destruction
8. Create Greater Undead
9. Wail of the Banshee

DESTRUCTION*

Deity: Bronegh, Pleiagh

Granted Powers: You gain the smite power, the supernatural ability to make a single melee attack with a +4 attack bonus and a damage bonus equal to your cleric level (if you hit). You must declare the smite before making the attack. It is usable once per day.

Spells:

1. Inflict Light Wounds
2. Shatter
3. Contagion
4. Inflict Critical Wounds
5. Circle of Doom
6. Harm
7. Disintegrate
8. Earthquake
9. Implosion

EVIL*

Deity: Boraal, Layan'kul

Granted Powers: You cast evil spells at +1 caster level.

Spells:

1. Protection from Good
2. Desecrate
3. Magic Circle against Good
4. Unholy Blight
5. Dispel Good
6. Create Undead
7. Blasphemy
8. Unholy Aura
9. Summon Monster IX

GOOD*

Deity: Corlein, Branyen

Granted Powers: You cast good spells at +1 caster level.

Spells:

1. Protection from Evil
2. Aid
3. Magic Circle against Evil
4. Holy Smite
5. Dispel Evil
6. Blade Barrier
7. Holy Word
8. Holy Aura
9. Summon Monster IX

KNOWLEDGE*

Deity: Aliara

Granted Power: All Knowledge skills are class skills. You cast divinations at +1 caster level.

Spells:

1. Detect Secret Doors
2. Detect Thoughts
3. Clairaudience/Clairvoyance.
4. Divination
5. True Seeing
6. Find the Path
7. Legend Lore
8. Discern Location
9. Foresight

LAW*

Deity: Aliara, Arnlon, Londalia

Granted Powers: You cast law spells at +1 caster level.

Spells:

1. Protection from Chaos
2. Calm Emotions
3. Magic Circle against Chaos
4. Order's Wrath
5. Dispel Chaos
6. Hold Monster
7. Dictum
8. Shield of Law
9. Summon Monster IX

LUCK*

Deity: Branyen, Artoh

Granted Power: You gain the power of good fortune, which is usable once per day. This extraordinary ability allows you to reroll one roll that you have just made. You must take the result of the reroll, even if it's worse than the original roll.

Spells:

1. Entropic Shield
2. Aid
3. Protection from Elements
4. Freedom of Movement
5. Break Enchantment
6. Mislead
7. Spell Turning
8. Holy Aura
9. Miracle

PROTECTION*

Deity: Ergethen

Granted Power: You can generate a protective ward, a spell-like ability to grant someone you touch a resistance bonus on her next saving throw equal to your level. Activating this power is a standard action. The protective ward is an abjuration effect with a duration of 1 hour that is usable once per day.

Spells:

1. Sanctuary
2. Shield Other
3. Protection from Elements
4. Spell Immunity
5. Spell Resistance
6. Antimagic Field
7. Repulsion
8. Mind Blank
9. Prismatic Sphere

TRICKERY*

Deity: Branyen, Boraal

Granted Power: Bluff, Disguise, and Hide are class skills.

Spells:

1. Change Self
2. Invisibility
3. Nondetection
4. Confusion
5. False Vision
6. Mislead
7. Screen
8. Polymorph Any Object
9. Time Stop

TYRANNY

Granted Powers: +2 bonus to all Intimidation checks, spell-like ability command 1/level/day.

Spells:

1. Cause Fear
2. Silence
3. Bestow Curse
4. Dismissal
5. Greater Command
6. Geas/Quest
7. Dictum
8. Shield of Law
9. Astral Projection

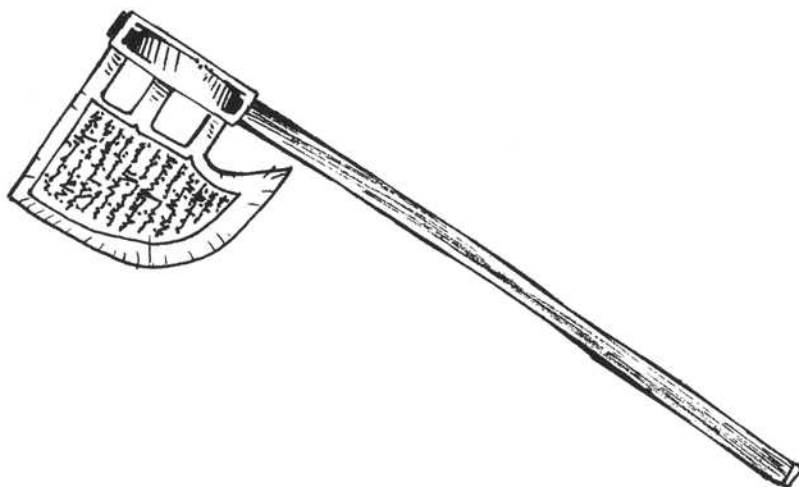

NEW MAGIC

“My brothers, we must use every fraction of power available to us in the coming fight, whether they be physical, moral, divine or arcane in nature. For the Most Holy Saint Cuthbert of the Cudgel grants us only a short time for war.”

— Prelate Adhemar of Kashgham,
addressing his generals

Magic has always held an important aspect in warfare, and its utility on the battlefield probably owes as much to Adhemar, Prelate of the Church of St. Cuthbert in the ancient city-state of Kashgham, as to any other individual. The sheer urgency with which this ambitious spellcaster-general pursued his remarkable military career drove him to find new and better ways to use his powers to win the battles that he so ruthlessly forced upon his enemies.

During Adhemar's lifetime, Kashgham was a member of the Elrec League, an alliance of powerful trading cities located along the Katras River and near its delta. Although an intricate web of commercial agreements and political treaties bound them together in theory, these various principalities intrigued against each other constantly, as did various factions within each principality. To many, talk of conspiracy and treachery ruled the gossip in the marketplaces and public houses. Power and wealth became supreme values rather than means to an end, and shallow cynicism and hedonism held sway everywhere.

Among those who held this view was Kashgham's Prelate of St. Cuthbert, Adhemar. A man as stern and severe as the deity he served, Adhemar thundered from his pulpit that the ruling elites of the League had proven themselves unworthy of the gods' favor. It did not matter which deity one served, the rulers of the various city-states had offended all of them in some fashion through their licentiousness and corruption. For this, most of the nobles, merchants and landowners of Kashgham either laughed at him or cursed him, depending on

how seriously they took him. The city's ruler, Prince Napolis, took him seriously enough to send him into exile.

Enough Elrec citizens agreed with Adhemar that wherever he went in his exile, preaching his message as he went, people came to hear him. The wealthy among them gave him money, while others simply followed him from place to place. Within a shockingly short time he had accumulated enough followers and money to sustain an army. Adhemar realized that he now had the means to overthrow the princes of the League and institute a republic of virtue in their places. Along with his adherents, he melted away into the woods east of the Katras to organize and drill his new soldiers.

The next spring, Adhemar's new army emerged and descended on the city of Argom, located at the midpoint of the river, and took it by storm. With this bold stroke, he cut the Elrec League in half, severing communications between the upriver and down-river cities. Using Argom as his main base of operations, he spent the next 20 years fighting off the rest of the League's princes, taking their cities when he could, smashing their armies when he could not. He accomplished all of this even though his enemies outnumbered him, and at the peak of his success he controlled about half of the cities of the League.

Daring, relentlessness, and strategically cunning, Adhemar augmented his natural leadership with his magic. When he was not in the field or attending to affairs of state, Adhemar locked himself in his study and worked on new ways to channel the power of the gods into practical military applications. The fruits of his labors stunned his foes and greatly aided him in winning victories against odds that would have daunted lesser commanders. In turn, his soldiers regarded his uniquely powerful magic as a sign that St. Cuthbert had directly bestowed his favor upon him, and this inspired them to fight for him with even greater determination.



Adhemar ended his military career with the rare distinction of never having lost a battle in which he personally led an army. When he fell from power, the push came from within. In the lands under his control, Adhemar established an austere theocracy that invested ultimate authority in committees of clerics of St. Cuthbert. He outlawed anything that resembled a political faction, tolerated no public dissent from his edicts and forbade any sort of ostentatious display by the wealthy. Quite naturally, he made many enemies among the elite classes in the cities under his rule. Many citizens also tired of endless warfare and the relative joylessness of everyday life. In Adhemar's capital of Argom,

a cabal of wealthy merchants and aristocrats plotted to overthrow him. They mustered a small mercenary force and one night in the dead of winter, they stormed his palace and took him prisoner. The next morning, the people of Argom filled the streets and prevented loyal soldiers from freeing their priest-general, and they cheered at his beheading that afternoon.

Before his downfall, Adhemar recorded his innovative contributions to the magic of warfare in his private journals, and for public record with the help of his official historians. Here are some of his more noteworthy inventions.



SPELLS

DETECT ALLEGIANCE

Divination

Level: Brd 3, Law 2, Clr 3, Sor/Wiz 4

Component: S

Casting Time: 1 action

Range: 30 feet

Targets: One creature

Duration: Instantaneous

Saving Throw: Will negates

Spell Resistance: Yes

Spies are among the deadliest agents of war, and many generals fear them as none other. This spell represents Prelate Adhemar's contribution to the fine art of counter-espionage.

Detect allegiance reaches into the target's innermost thoughts to divine its true motives and intentions. While no substitute for a proper interrogation, it does provide a simple answer as to whether the target shares the same allegiance as the caster, or their loyalties are opposed. If the target's allegiance is neutral relative to the caster's, the spell reveals that as well. If the target makes a successful Will saving throw against the spell, however, the caster receives no information. This only works if the target knowingly sides with or against the caster, or if the target chooses no sides. It does not detect a manipulated fool, nor does it automatically reveal the identity of the ally or enemy. If the target owes no loyalties to anyone other than himself, the spell reflects his current temperament.

Adhemar devised a somatic component for this spell that is so simple that, with practice, the caster can conceal it as an innocent act of stretching his muscles. The target may try to detect the spell by making a successful Spot check against the spellcaster's DC.

FIELD OF CALTROPS

Transmutation

Level: Clr 5, Sor/Wiz 4

Component: V, S, M

Casting Time: 1 round

Range: Long (400 ft. + 40 ft./level)

Area: 50 ft. diameter + 10 ft./level

Duration: 1 minute/level

Saving Throw: Reflex half

Spell Resistance: No

Adhemar, who often relied on tactical maneuvers that other generals found unconscionably risky, knew that no army lacked weaknesses, and so he developed *field of caltrops* as a hedge to use in situations when he needed a bit of insurance against his enemy.

Field of caltrops hardens and contorts the ground in an affected area to make it hazardous for creatures to pass over it. For each round a creature spends moving in or through the area of effect, it must make a Reflex saving throw (DC 15). If it fails, it suffers 1d4 damage. If it succeeds, it takes half damage. If for some reason the creature falls inside the area of effect, it must make another Reflex saving throw (DC 15). If it fails, it suffers 2d4 damage. If it succeeds, it takes half damage. This has no effect against creatures with natural armor of 2 AC or better, nor does it affect foes wearing metal or magical boots.

In addition, horses and other animals will not cross the area of effect, and resist all non-magical attempts to force them to do so. If the spell catches an animal within its area of effect, it flees if possible as its next action. It still takes damage for moving through the area of effect. An animal that has not yet entered the area of effect shies away from it. For this reason, the spell is particularly effective in warding off cavalry charges.

Material Component: An iron spike.

MASK ALLEGIANCE

Enchantment

Level: Brd 1, Clr 2, Trickery 0, Sor/Wiz 3

Component: V, S

Casting Time: 1 action

Range: Personal

Targets: Caster

Duration: 1 hour/level

In its own way, spying is at least as difficult a job as soldiering. A spy operates in enemy territory, alone, and has no hope for survival if caught.

Adhemar relied heavily on information gathered by secret agents to track enemy troop movements, gauge the mood of enemy cities, and read the thoughts and intentions of the princes arrayed against him. To help his spies protect themselves in hostile territory, he devised a spell to help them deceive anyone who could do them harm, inscribing it onto scrolls that they could use before entering risky situations. Mask allegiance conceals the caster's thoughts from penetration by magical means (e.g., *detect thoughts* or *detect allegiance*) to the extent that other casters may not detect his true loyalties unless he chooses to reveal them. The spell does not protect him from revealing any other sort of information under interrogation, but it helps him avoid detection during a spy mission. For obvious reasons, Adhemar kept this spell a close secret, and its existence did not become public knowledge until its discovery in his personal papers after his execution.

Adhemar designed the somatic and verbal components of this spell to be as inconspicuous as he could make them. With practice, casters could disguise them to appear as though simply brushing aside a lock of hair and clearing their throats.

PROTECT MOUNT

Enchantment

Level: Clr 1, Drd 2, Pal 2

Component: V, S

Casting Time: 1 round

Range: Touch

Targets: One animal/2 levels

Duration: 1 minute/level

When heavy cavalry charge, their greatest asset is often their greatest weakness. Their horses grant them speed and truly ferocious impetus, but at best, the animals only wear partial armor. A charging lancer in full plate armor had best pray that his mount survives, lest he himself fall with it.

Protect mount affords cavalry warhorses a measure of protection, something they usually receive only as an afterthought. While affected, animals struck by non-magical weapons may make Will saving throws. If successful, the animal takes no damage. If failed, it takes normal damage. Missile weapons have a DC equal to 10 + opponent's Dexterity modifier + opponent's level. Melee weapons have a DC equaling 10 + opponent's Strength modifier + opponent's level. Due to the spell's potential cost of a healing spell, Adhemar preferred to use it on the mounts of his lieutenants and their best field commanders.

Although Adhemar of Kashgahm designed this spell to benefit soldiers fighting on horseback, it can protect any animal or mount, including beasts or magical beasts.

QUAGMIRE

Transmutation

Level: Clr 5, Drd 5, Sor/Wiz 7

Component: V, S, M

Casting Time: 1 round

Range: Long (400 ft. + 40 ft./level)

Area: 50 ft. diameter + 10 ft./level

Duration: 1 hour/level

Saving Throw: None

Spell Resistance: No

Adhemar developed field of caltrops primarily as a ward against charging cavalry, but determined footsoldiers may still force themselves through its area of effect. To deal effectively with situations in which infantry charge to initiate shock combat at a spot where he did not welcome it, he developed another spell, *quagmire*.

Quagmire turns its area of effect into nearly impassible mud in an instant. All creatures caught in the spell's area of effect may move at only one-fourth of their normal speed. In addition, any creature wearing heavy armor that attempts to move must make a successful Reflex saving throw (DC 15), or else it cannot move at all (assume that it thrashes helplessly in the mud). If it fails, it may try again next round.

Quagmire must target relatively dry ground to have any useful effect. It does not stack penalties for moving across ground that is already muddy or swampy.

Material Component: A handful of mud.

SLOW MISSILES

Abjuration

Level: Clr 4, Sor/Wiz 6

Component: V, S, M

Casting Time: 1 round

Range: Long (400 ft. + 40 ft./level)

Area: 30 ft. diameter + 10 ft./level

Duration: 1 round/level

Saving Throw: None

Spell Resistance: No

Unfortunately, arrows and bolts travel too fast for most to side-step. Only certain skilled monks can even attempt to do this, and even then rarely against multiple foes.

Slow missiles can help others mimic the monk, however. Cast upon a body of missile troops, it causes all projectiles they fire for the duration of the spell to travel at half-speed. In effect, projectiles reach their target the round after they are fired, not in the same round. Missiles' targets may not have the option to flee, but may still brace themselves for a +6 circumstance bonus to their AC.

Slow missiles falls to such spells as *dispel magic*, of course, but must target the troops affected by *slow missiles* in the first place, and has no effect on missiles already fired.

Material Component: A sliver of wood and a feather.

SPEED REINFORCEMENTS

Level: Clr 9

Component: V, S, M

Casting Time: 1 round

Range: see text

Target: up to 500 friendly troops + 100/level

Duration: 1 hour

Saving Throw: None

Spell Resistance: No

In one of his battles against the princes of the Elrec League, Adhemar centered his battle plan around a promise by a chieftain of sylvan elves to arrive on the enemy's flank in the middle of the battle. Until then, Adhemar's outnumbered army would have to withstand a frontal assault by their foe. As the day wore on and his battleline shuddered under repeated attacks, he fretted over when his allies would reach the field. One of his generals later recalled, "Time seemed to have stuck fast. At one point My Lord General said to me, 'Either nightfall or the elves must come.'"

To mitigate this problem in the future, Adhemar created one of his most powerful works of magic. The caster must use *speed reinforcements* in conjunction with some means of locating the body of friendly troops to target. Adhemar himself used crystal balls for this purpose, focusing on the commander whose soldiers he needed most urgently.

When casting the spell on the reinforcements, it warps the fabric of time so that time and fortune favor the troops' speed. In practical terms, it doubles the movement rates of the affected troops.

Speed reinforcements has no effect on enemy troops.

Material Component: A piece of parchment with the name of at least one of the summoned commanders written on it.

MAGIC ITEMS

BANNER OF RALLYING

At first thought, flags are wasted expenses on the battlefield, more show than substance. They lack sharp points or edges, and they make very poor shields. In fact, battle standards are essential instruments of command and control, and every army that knows its business treats them as such. The standardbearer holds a position of honor, all the moreso because he cannot fight while clutching the flag. In the confusion of battle, a flag rising above the fray lets a soldier know where his commander is, and when all else goes wrong, it serves as a point around which the troops can rally and reorganize.

Adhemar devised a way to enchant his battle standard to enhance its effectiveness as a rallying point for his troops. All items created using his formula are known as *banners of rallying*. The bearer of a banner of rallying may activate it once per day, and its effects last for 1 hour. When active, it affects all friendly troops within 100 yards of it. Any friendly soldier who looks upon a *banner of rallying* may move toward it at his double movement rate. For the duration of the activation, he also gains a +1 attack bonus and a +1 morale bonus to all Will and Fortitude saving throws.

Banners of rallying can also counter morale effects induced by spells and extraordinary, supernatural and spell-like abilities, like *cause fear* or even a dragon's frightful presence. In all cases, friendly soldiers receive an additional saving throw against such spells or abilities at the moment that they come under the influence of a banner of rallying, with a +5 morale bonus for this saving throw. If turned undead come under the influence of a banner of rallying, they dispel the effects of turning by making a successful Will saving throw against a DC of 10 + the turner's level + the turner's Charisma modifier. This saving throw also receives a +5 morale bonus because of the banner's magical influence.

Soldiers already under the effect of a *banner of rallying* gain no additional benefits from subsequent or overlapping activation of another *banner of rallying*. They simply keep fighting for the leader who activated the first banner.

Enemy troops are not affected by *banner of rallying*.

Caster level: 13th; *Prerequisites:* Craft Wonderous Item, greater restoration, remove fear; *Market Value:* 50,000 gp; *Weight:* 15 lbs.

BANNER OF ROUTING

As important as they are to friendly troops, standards also make valuable prizes for the enemy, who can show them off as material evidence of their triumph. Capturing a battle flag is, if nothing else, an exhilarating propaganda victory.

Ever the sly tactician, Adhemar used his magical craft to create cursed standards that were, in fact, booby traps for his enemies. Activated by holding it aloft, the *banner of routing* works the next time it changes hands. When touched the first time after activation, the curse affects all enemy troops within 100 feet of the banner. The banner casts *cause fear* on intelligent troops in the area, and non-intelligent creatures must make a successful Will saving throw (DC 19) or they, too, must flee. Undead are affected as if turned. Friendly troops are not affected by a banner of rout.

Adhemar combined the *banner of routing* with feigned retreats calculated to lull his enemy into carelessness. At a discreet pre-arranged signal, his troops would cut and run, pretending to rout. The standardbearer would activate the banner and drop it. When the "victorious" enemy picked it up and set off the curse, Adhemar's soldiers turned and counter-attacked.

Caster level: 9th; *Prerequisites:* Craft Wonderous Item, *cause fear*, greater command; *Market Value:* 30,000 gp; *Weight:* 15 lbs.

DRUMS OF WAR

Many of Adhemar's armies went into battle accompanied by the martial beat of *drums of war*, an item he created to inspire his troops at crucial

moments. Drums of war can only activate twice per day, so Adhemar saved them for the moment he sensed his enemy wavering, ready to cut and run if pressed by an energetic attack. When the item is activated, all friendly troops within 100 yards receive a +2 morale bonus to attack rolls, a +1 deflection bonus to AC, a +2 morale bonus to Will saves and a +1 morale bonus to Fortitude saves. It does not allow friendly soldiers to dispel negative morale effects induced by spells and extraordinary, supernatural, and spell-like abilities.

Drums of war does affect enemy troops. All enemy soldiers within its area of effect suffer a -1 morale penalty to Fortitude saves and a -2 morale penalty to Will saves. Bonuses and penalties from overlapping *drums of war* do not stack.

Caster level: 12th; *Prerequisites:* Craft Wondrous Item; *Market Value:* 50,000 gp; *Weight:* 10 lbs.

SNIPER'S LONGBOW AND ARROWS

Adhemar first learned of the *sniper's longbow* and *sniper's arrows* from a team of sylvan elf mercenaries, whose people had long used the weapons to deal with poachers, bandits, and other such unwanted intruders in the forests outside Argom. He had never seen their like before, and never saw anyone else using them again, so he deduced that this particular race of elves had invented these potent weapons. Adhemar employed these elven archers whenever he could. When he found himself on a battlefield where he could anchor one of his flanks against a dense wood or forest, he would station his snipers up in the trees and order them to pick off anyone who looked like an enemy commander.

Sniper's longbow confers a +1 attack bonus and has a critical hit range of 18-20. Using a *sniper's arrow* increases the odds even further and strikes with deadlier effect. Each *sniper's arrow* confers a stacking +1 attack bonus and causes an extra 2d6 damage with critical hits.

Caster level: 8th; *Prerequisites:* Craft Magic Arms and Armor, *keen edge*, *magic missiles*; *Market Value:* *sniper's longbow* 18,375 gp, *sniper's arrows* 367 gp each.

ROD OF THUNDER

Adhemar dreaded laying sieges because they could take up months of valuable campaigning time and made him a sitting target for a relieving army. When he needed to capture the well-fortified cities of the Elrec League in order to bring his great political plans to fruition, he developed the *rod of shattering* in order to expedite the arduous process of breaching a city or castle's walls.

A *rod of shattering* uses arcane magic to set up, focus, and project a powerful sonic vibration that can crumble stonework. Those who have stood very close to its area of impact and lived described the sensation as standing in the middle of a peal of thunder, hence the item's name.

When activating a *rod of shattering*, the wielder chooses a point of impact no further than 400 feet away. The area of impact forms a 5-foot radius circle around that point. All stonework within the area of impact instantly shatters, to a depth of two feet. In addition, any non-ethereal creature located within 30 feet of the point of impact (in all directions) at the instant of impact must make a Fortitude saving throw (DC 20). If the save attempt fails, the blast stuns the creature for 1d6 rounds, suffers 1d6 damage, and becomes totally and permanently deaf. A successful saving throw results in half damage and total deafness for 1d12 hours.

Since a *rod of shattering* only penetrates to a depth of two feet, the wielder may require multiple blasts to actually breach the fortification, and someone must clear away the rubble (a laborious and potentially dangerous task in itself) before attacking troops can use the breach. A *rod of shattering* makes a good, lightweight alternative to the ponderous siege engines that are otherwise needed to assault a castle or a walled city.

Caster level: 13th; *Prerequisites:* Craft Rod, *earthquake*; *Market Value:* 43,000 gp, weight: 5 lbs.

CHAPTER FIVE:

DEATH OF NATIONS

“A man who has nothing for which he is willing to fight, nothing which is more important than his own personal safety, is a miserable creature and has no chance of being free unless made and kept so by the exertions of better men than himself.”

—John Stuart Mill

For both individual and nations, survival dictates certain goals achieved, with various ways to attain these goals: negotiation, intrigue, manipulation, threats, compromise, diplomacy... and warfare. Each may work to varying degrees with varying degrees of efficacy. In general, however, warfare is the only solution that is always available.

On the individual scale, the absolute annihilation of all opposition is a sure method of solving problems. On the national scale, destroying or conquering any potential threats is equally likely to succeed.

Contrary to the old adage, violence is always a solution. It is, however, inefficient. The costs of war, on any scale, far exceed those of any other tools in both the short and long terms. It is cheaper (though less reliable) to send even a legion of diplomats to attain a government's goals than it is to form, outfit, maintain, and use an army. Even bribery, assassination, theft, and other illicit activities are almost always less costly to a nation than outright warfare, provided the government allows such, even to their enemies. Essentially, full-scale violence is an answer under two circumstances: when no other options remain, or when the cost no longer matters.

When a side implements a military solution to their problem, they become the aggressor. While this term carries a negative connotation,

the aggressor is not necessarily the evil. In the American Revolution, for instance, the American colonists were the aggressors — they initiated a military conflict with the opposing side.

Note that war does not begin when the aggressor initiates violence; in fact, the aggressor never starts a war. The defender, in preventing the aggressor from attaining their goal, begins the war. To continue the example from the American Revolution, if the British had allowed the colonists to secede after Lexington and Concord, the “war” would have been a simple skirmish. Only when both sides use military force to achieve their goal(s), or to stop the other side from doing so, does a war begin.

TYPES OF WAR

LAND WARS

Many historical wars sought land as the goal. In agricultural societies (most fantasy settings), arable land represents the opportunity to expand the population, which translates into power for a nation. Such wars begin when two nations each attempt to colonize the same area. Usually, skirmishes arise between the sets of colonists, with armed reinforcements to secure the territory. The victors of land wars hold the lands in question, and once they secure their holdings, the war ends. Such wars, however, typically lead to prolonged conflicts between two or more sides, as expansion continues further into enemy territory. Often, such wars turn into wars of conquest.

WARS OF CONQUEST

Like land wars, wars of conquest are about land and extending a nation's power base. The significant difference is that, in a war of conquest, someone else has already claimed the prized area. Despite the greater threat of armed resistance, conquering already-settled land has several advantages. The natives have a pre-existing social structure, allowing the conquerors to reap the benefits without making the initial investments in colonists and time. Malevolent conquerors may view the natives themselves as a prize, and subjugate them for profit. Such wars lead to atrocities on all sides, however, as the natives of the conquered land often spend generations fighting the invaders, wearing them down over the course of decades or even centuries. Despite this, conquering nations usually consider the matter finished, until the all-but-inevitable rebellion.

REBELLIONS

Rebellions are almost the opposite of a war of conquest. In a rebellion, a people revolt against an existing power structure, whether foreign or domestic. Since the existing government almost always controls the military (unless the army itself rebels, as in a military coup), the populace typically engages in guerilla tactics. The government then either concedes points, or retaliates — usually brutally, in an attempt to dissuade further revolts. The casualties quickly mount in rebellions, as both sides have their share of heroes and villains.

CIVIL WAR

Civil war is perhaps the worst fate that can befall a nation; very few countries ever completely recover from a civil war, if any, and they damage a nation in a way that nothing else can. Civil wars are always political, as some incident causes a rift within the nation. Whether it is over allocation of resources, placement of power, or political ideology, a civil war places friends and neighbors on opposing sides of the battle lines. Equally problematic in a civil war is the question of victory. As the opponents are fellow

countrymen, the defeated remember the victor's cruelties, while the specter of another civil war may force unhappy compromises on both sides. Because of the deep rift necessary to cause a civil war, they always leave nations torn, and often at the mercy of their neighbors.

POLITICAL WARS

Not all political wars are internal. The difference between a political war and a land war is the goal involved. In a land war, the objective is simple: take a certain piece of ground, hold it, and prevent your enemy from doing the same. Political wars are about an ideal. A political war is when a nation establishes a policy that is unacceptable to another group, and is unwilling or unable to negotiate or change. Only rarely do such practices cause wars (most modern "political" wars are land wars which extend to attacking the opponent's allies), but freedom is an ideology, and genocide is a political agenda. National politics can and do have a very real effect upon the nations that implement them and the nations around them. Political wars sometimes lead to wars of conquest, due to greed as often as necessity.

BEHIND THE WAR

There is more to an army than the men and women in it. Leaders must make considerations for matters of supplies, troop recruitment, civilians, and ethics, even before the first conscript lifts his first spear.

One of the major factors of a war is keeping and maintaining supplies. More than one nation's agricultural infrastructure has fallen trying to support its military. If laborers receive no compensation for their work, the army could face a revolt in addition to its other problems. War is an expensive proposition — the army must train, outfit, house, feed, heal, and pay its soldiers. While governments fund the military in most cases, exceptions do arise. Even as wealthy as a single character might be, maintaining an army is rarely a

prospect for anything smaller than a city-state. Unless in a military dictatorship, a general rarely has sole or final authority on deploying his forces, with politicians truly leading the campaign.

Despite the countless variants that can be established in a fantasy setting, almost every troop falls into one of three categories: conscript, mercenary, or volunteer, with each type of recruitment raising its own dilemmas.

CONSCRIPTION

Conscription is the process of forcing an unwilling person (or people) to fight on your side, requiring no greater resources than a press gang. Most leaders balk at conscription, however, for several reasons. First, of course, are the ethical implications — bullying people into service as cannon fodder is hardly a charitable act. Conscripts also require constant, armed supervision lest they desert or revolt. Conscripts also need more training than regular soldiers, while simultaneously keeping them weak enough that they do not threaten their own army. They have terrible morale, and flee battle under all but the most competent leaders.

MERCENARIES

The major difference between a mercenary and a volunteer is motive. The volunteer believes in the rightness of his army's goal, whereas the mercenary wants money. Despite their higher price, mercenaries offer several advantages to their army. Mercenary bands provide their own training, and often begin the war with their own equipment, though they expect compensation for damages. Mercenaries rarely desert, having definite incentive to stay (though mercenaries have no tolerance for employers who lie by omission when discussing contracts). Finally, and perhaps most importantly, a general has no obligation to mercenaries under his command, outside of their contract. At the end of the war, the mercenary receives no pension, benefits, or any other service a loyal soldier could expect after his enlistment.

However, it should be noted on rare occasions mercenaries have been known to change sides, but this is rare and most mercenaries knew better than to betray an employer, lest they expect the same in return.



VOLUNTEERS

The rarest type of troop, volunteers are dedicated and noteworthy individuals who fight for a cause without any kind of compensation. This mindset lends itself to unwavering loyalty and *esprit-de-corps*, invaluable assets both on and off the battlefield. Most volunteer soldiers are idealists, however, with very little training or actual battlefield experience. Even should they work for free (a rarity — they must have food when they return home), they still require food and shelter from their leaders.

While training is generally a straightforward operation, the quality of instructors (typically veterans or mercenaries) and facilities directly influences the quality of troops. Furthermore, the leader must consider the time it takes to train his troops, and many generals believe battlefields have less to do with victory than do training camps.

War affects far more people beyond the military. War dips into food stores normally saved for winter, so many peasants may starve from the combined shortage and taxes. So, too, does a leader's concern for morale not end with his own troops. If his civilians believe the war justified and necessary, he could be a hero as his people unite behind the common goal, causing a great boost in morale, confidence, and general productivity. Should the people view the war as terrible or unnecessary, the leader may not receive support from home, nor be welcome there when the campaign is over.

One of the major difficulties of entering any battle is the question of acceptable wartime practice. Though assassins and saboteurs have no need to justify their utility, employing such tactics against an enemy is an invitation for similar response. Even more commonplace acts, such as “battlefield assassination” (the deliberate sniping of enemy officers) meets with strong derision among some nations. While such strategies have their use, and may even save lives, a general who engages in such reprehensible actions, and loses, may find himself a common criminal. Should the war drag on, however, even the most honorable of leaders may feel the temptation for a quick resolution...

WINNING THE WAR AND CLEANING UP

To many generals, a victory is a certainty before they deploy their first unit. To others, the only success is in the peaceful surrender of either side. To some, winning is an utter impossibility, as one side kneels to another, who must now struggle to keep in peace what they won in blood.

In a war of conquest, the war theoretically ends when the defender surrenders, but such rarely happens. Often, wars of conquest turn into rebellions after a time, and conquerors may even find themselves the conquered in time. Compared to the other forms of war, however, conflicts over land are relatively simple.

The other types of war have far more ambiguous endings. Political battles almost never truly end, as ideals rarely die. Revolutions cause similarly vague resolutions, as the rebels may themselves become the new tyrants. Even a failed revolution paves the way for the next revolt, as the surviving leaders turn the fallen into martyrs.

Even once the war ends, the work does not. Many nations take responsibility for their fallen foes, building strong ties and rebuilding their strength, thus making both parties stronger.

Even without such altruism however, war exacts a demanding price on the warriors of both sides, and both sides face uncertain futures — whether side by side or at each other's throats.

WAR AS A CAMPAIGN

A strong leader commands in both wars and games. Just as a general is the final authority in running an effective war, the DM is the final authority in an effective game. While the players take actions and alter the world, it is still the DM's world. Experienced DMs know the capacity players have for taking carefully planned events and turning them awry, but wars increase the possibilities tenfold.

The best way to avoid massive upheavals is to know and understand the war, the background, and the likely outcomes. To this extent, the DM may wish to consider the following when designing a war-based campaign.

Where is it?

What areas does this war encompass? Is it over one particular region, or does it reach all over the world? Is this a petty local affair, or does it threaten all who live? Terrain, political lines, and population centers are all too important to determine, especially if the PCs wish to take an active hand.

If this is a national war, what nations are involved, and what are they like? Their methodologies and ideals in peace affect how they war, as well.

How does it begin?

Most wars have two causes: long-term and immediate. A series of individual events, continual pressure, or some combination thereof can contribute to long-term causes. The immediate, in contrast, is usually minute or trivial, a simple excuse to begin the slaughter to come. The beginning of a war dictates the causes, and often the allies as well. If the immediate cause is dishonorable, or an atrocity, then all sides will have few qualms about disregarding etiquette and integrity. On the other hand, if the war begins with a formal declaration, based on sound reasoning and differences, then ethics bind most sides.

The beginning similarly affects the end. If a single man's actions begin a war, his capture or death often ends it. If the war begins as a personal slight, revenge may well be the only end that satisfies the insult.

Who is involved?

More than just the political personalities involved, a war affects every aspect of society.

Typically, the smaller standing army must initiate conscription or drafts to counter the power gap, and taxes surely follow. Though few outside the initial battles may feel the effects, eventually a war affects

everyone as prices surge or fall, skilled soldiers seek work, and the war itself restricts travel through hostile regions.

If the PCs involve themselves directly, their contributions change the world still further. On the front lines, they see a viewpoint rarely afforded mere civilians, including the exact dispositions of both sides. On special missions such as espionage or sabotage, they struggle with the moral complexities of their actions, and of what their missions imply about their masters. Though some find it distasteful, few wars provide no opportunities for adventurers.

How does the setting affect the war?

As do characters and nations, armies have their own personalities. Nations familiar with strife produce battle-hardened veterans and seasoned military minds. Peaceful nations, in contrast, must push forward green recruits and uncertain leaders. Without intervention, such wars are all but over already.

Similarly, magic distorts the battlefield, both figuratively and literally. A war fought with courage and steel has an altogether different tone from battles between rival wizards and priests, with inhuman troops taking the battlefield.

The nature of the parties in the war also changes the battlefield — a lawful evil society, steeped in tradition and treachery, typically prefers covert “battles” of espionage and propaganda, with actual skirmishes being a rarity.

How the war affects the game is a vitally important subject. Does it take place in the background, or is it the focal point for the entire game? How much can the PCs affect?

FIGHTING THE GOOD FIGHT

Should the PCs involve themselves, the campaign changes. Beyond which side they fight for, or what rank they might hold, character involvement raises questions of motivation, allegiance, and utility.

In a fantasy setting, the question of race vs. nation becomes very important. In most fantasy

settings, races congregate and form nations together, with nations of elves, dwarves, and humans more common than racially-diverse states. If race is not synonymous with nation, does this lead to conflict between the two? Does an elf feel greater loyalty to his fellow elves, or his countrymen?

Furthermore, what makes a PC want to fight this war? Is he a loyal follower of a leader, nation, or ideal? Is he in it for the glory? For money? For justice? Did the opposing side hurt him in some way? Why are the PCs involved? Did they start the war somehow, through their actions? Did outside actions force them into the war?

Where does a character's loyalty lie? Is he a follower of a particular deity? How does that deity and their supporters interact with other affiliations? Does the character place more emphasis on national ties, religious ones, professional, or personal? If these loyalties conflict, what side might the character take? War, by nature, divides people, and the PCs should be no different.

How do the PCs serve their cause? Are they military commanders or soldiers, fighting directly against the enemy, or do they work in a more peripheral fashion? Neither case is more or less helpful to the war effort, and both have the potential for great danger and great heroism. Do the PCs work in both areas, fighting on the lines

and doing special work between battles? While "daily routine" is a bit vague for a professional adventurer, what would a typical day for the character's military life be like?

STATS AND WAR

Though personalities are typically more ephemeral, a character sheet quantifies much of the character itself, and this may lead to their best function in a war.



NAME

While it is often an afterthought, a PC's name usually indicates two major aspects of his background: his nation or location of origin, and his family. Both of these traits can have a major bearing upon a character's status in the military.

In the PC's homeland, what is the attitude towards, or of, the military? Is there a national conscription, or is the army made up entirely of enlisted soldiers? Has the character done anything to make a name for himself, causing pressure to take on a public position, such as the military? Historically, the fastest route to success and accomplishment was by joining the military, and most public figures made their names in battle.

Does this character's family have any kind of military history? If the character is a noble, the answer is almost always yes. Though many settings promote divine right, almost all have at least one family who earned their position by arms. Furthermore, part of *noblesse oblige* (the code of conduct illustrating the responsibility of the nobility to the people) is the duty of the lord to protect his people. What kind of personnel does the noble have at his command, or that he can raise? Depending on his rank, both civilian and military, what kind of responsibilities does the character have to his own liege? Oftentimes, a noble personality does not want to join a war, but his superior calls on him regardless.

Furthermore, there is a strong tradition in historical warfare of buying commissions. While nobles view this as an easy route to rank and power, there are several distinct disadvantages to the system. Primarily, it places money and political power ahead of merit, and incompetence in battle leads to crushing losses. It can also lead to morale issues, as soldiers far prefer to fight for a commander who earned his position, rather than one who bought it. Another tradition, tied into this one, might present a good motivation for adventuring PCs. This is the tradition of an officer supplementing his troops' supplies, equipment, training, and pay out of his own pocket. Because

military position is a status symbol among the nobility, it becomes important for their image that the troops under a powerful noble's command look the part. Such trappings rarely come cheap, and can drive a commanding officer to desperate measures in order to pay for them.

Ironically, a common or middle-class character often has more freedom about who, or even whether, he serves in war. A character who is unhindered by ties of honor and loyalty can set a price for his services, whereas nobles must be above such things. Furthermore, a lower-born soldier, while having less power or authority, also has equally less responsibility. The consequences of a lower-class character leaving the military are far less severe than that of a noble, and thus desertion or bribing one's way out of service becomes far easier.

RACE

How does a character's race affect his outlook on war? In a fantasy world, there are pre-conceived notions of how different races view war. Elves are pacifistic until provoked, and dwarves are gruff and warlike, but not without cause. Gnomes and halflings are extreme pacifists, rarely forming an organized military or a formal war effort. How accurate are these stereotypes in the campaign world? Are the elves imperialists, ready to start a war at the first opportunity? Are halflings mercenary scouts, ready to sell any information they can to the highest bidder? Are there any races to which a stereotype applies, or is it only safe to judge on an individual basis?

Furthermore, how do race and national background interact? Are there kingdoms of elves, dwarves, etc., or do they intermix with other races regularly? National breakdown is a very important factor in war, because one is very often the cause of the other.

How does the character's race affect their methods in war? An elf's build and temperament suit scouting and espionage, and a dwarf's towards engineering and fortification, but again, these are

stereotypes. Are the stereotypes valid, and whether they are or not, do the character have to encounter similar such prejudice in their military career? Does a halfling engineer face odd looks, and have to work twice as hard to prove his worth? Even in direct combat, an elf's style is much different from a half-orc's.

Does race have any impact on ethics? Are elves, with their deep respect for life, loathe to kill in battle if they can avoid it, or do they become filled with bloodlust?

What follows is the typical outlook of each race on the subject of war:

Humans

More than any other race, humanity's perspective varies. Some human cultures make elves' ethics primitive, whereas others are so depraved and uncivilized they make goblins appear cultured by comparison. Humans, more than any other race, are likely to war upon each other, because humans have far less racial unity. Humans look to national, social, religious, sub-racial, or any other number of ties, instead of their joint humanity. In most campaign settings, humans are the cause of great social change and reform, for better or worse. This usually makes humankind the focal point for war.

Dwarves

While dwarves are quick to anger, they usually remain aloof enough from outsiders' wars. Most dwarven wars are the result of long-remembered feuds or injustices, and because dwarven memory is so long, and their stubbornness legendary, these wars can survive decades or centuries on their own inertia. Often, what other races might consider full-blown warfare, dwarves merely shrug at and see as a way of life. While dwarves rarely seek war, they are a far cry from pacifists, and a great enough slight can bring a mountain down upon an offender. Like everything else they do, dwarves make war slowly and forcefully.

Elves

Elven warfare is a rare and dangerous thing. While elves overlook slights that would drive other races to violence, the anger of an elf is a perilous thing. Only when the threat is to all their kind (whether racial or natural) do they return the war, and woe unto the people who drive them to such extremes. With their long view and patience, elves can plan a campaign that can take centuries to mature. Long after their enemies have forgotten a threat, an elven force retaliates, surprising an enemy with their swiftness and ferocity. The grim and silent death that is an elf warrior is a thing of disturbing beauty, unless you are his target. With their ability to take the long view, elves at war often utterly destroy the threat, an uncommon lack of mercy.

Gnomes, Halflings, and Half-breeds

For various reasons, these races rarely form organized warfare. Gnomes and halflings are usually far too lighthearted and easygoing to deliberately organize war, and half-breeds rarely form their own societies. These races join in other peoples' war efforts, however, and can earn a great deal of power fighting on their behalf. Generals value gnomes for their magical ability, used to deceive and trick enemy forces. Halflings make excellent scouts and saboteurs, with their espionage and sneaking skills. Half-elves, similar to humans but with elven grace and long life, tend to excel at any military profession they choose, with the benefit of a long life's experience. Half-orcs, of course, have the obvious advantage of brute strength, allowing them to serve as shock troops in any army they like.

CLASS

A character's profession, possibly more than any other aspect of his life, determines what role they play in a war, and a wise commanding officer makes the most use out of whatever he finds. Every class has its place in a military setting.

Barbarians

Barbarians occasionally comprise armies of their own, but these militaries are more hordes than structured armies, with a warlord leading an otherwise disorganized group of warriors. Usually, such hordes have vague goals, or none at all. While often barbarian hordes seek nothing greater than conquest and blood, such is not always the case. Barbarian warbands can be on holy missions, pilgrimages, or even a normal migration somehow interrupted.

Barbarians, while commonly grouped together in armies of their own, rarely join “civilized” militaries. A structured chain of command has little appeal to barbarians, who avoid organization and responsibility. This rule is not universal, however, and some barbarians find they enjoy a structured military lifestyle, especially since their abilities place them in high demand. The accompanying riches counter the dissatisfaction a barbarian might find in such a life, and barbarians are no less likely to respect a good leader than would any other class.

Barbarians usually serve as shock troops, with small units meeting specific goals. Oftentimes a barbarian is at the forefront of a fight, taking on entire units as the battle frenzy envelops him. Just as often, however, a barbarian serves as a scout, using his knowledge of survival and the lay of the land to his benefit. In any case, a barbarian’s canniness and battle prowess are an asset to any army.

Bards

Perhaps surprisingly, most armies make a point of hiring bards. They serve as negotiators, mediators, messengers, and sources of inspiration. Furthermore, much of a military’s communication comes from musical signals such as horn calls or drum beats, and a skilled bard creates and transmits these codes. On the front lines, a bard makes a valuable morale inspiration, urging soldiers to fight harder and better. Even their knowledge of history and heraldry is important, as bards are the first to identify the prominent fallen of a battle.

Just as often, however, a bard finds purpose behind the scenes. Information-gathering, sabotage, and political pressure all take a finer touch than found by a warrior’s hand, and the bard is perfect for such a role. Who better to learn valuable information from an enemy than his faithful entertainer?

Finally, one aspect of the bard should not be overlooked: their magic. Bards are far less obvious spellcasters than wizards or even sorcerers, and can get access to far more sensitive areas. While other spellcasters need books or attention-grabbing components, bards only need ordinary musical instruments.

Clerics

Clerics serve an extremely versatile role in warfare, depending upon their deity and code of conduct. While followers of war gods might fight with the front lines, they may also be master tacticians or strategists, plotting the course of the entire war. Healer clerics volunteer early, and tend to the wounded as possible.

Depending upon a cleric’s deity’s domain, his role in warfare can vary greatly. Usually, the clergy holds themselves above petty struggles for land or power, but such is not always the case. If the enemy happens to serve a rival deity, the war suddenly takes on a holy purpose.

Furthermore, clerics serve a valuable social role in the military. No class is closer to the general populace than the clergy, serving as a moral and social center for a civilization. Clerics, with their social importance, determine morality as no other can.

Clerics also become infinitely invaluable in one particular situation: dealing with undead. If the opposition has unholy support (or is even entirely composed of the infernal and unnatural), then clerics become the first and best line of defense. In war against the undead, a cleric is worth ten fighters.

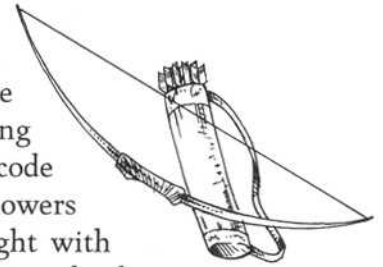

Druids

Druids, as a general rule, tend to avoid warfare. War harms the natural order and damages the land and creatures under the druid's protection. In some instances, however, to not get involved is to allow a dangerous situation to worsen. If a druid involves himself in a war, it is most likely with the intention of minimizing damage to their protectorate and bringing the conflict to a rapid end.

In such cases, the druid weighs the sides carefully before choosing one, or works against both sides carefully. If he does choose a side, it is only after cautious and careful consideration, and assistance should be given warily at best. While permanent alliances can form from such situations, druids most likely treat parties who intend to make war with caution.

The assistance a druid gives is most likely covert. He rarely sends packs of wolves and flights of eagles to throw away their lives attacking an enemy, as he values those lives far more than he does the war effort. Instead, the druid harasses supply lines, slows troop movements, and takes other forms of action to hassle opponents rather than confront them outright.

Fighters

Fighters, surprisingly, do not make up the bulk of an army, an honor usually reserved for the NPC warrior class, which represents the common soldier or armsman. Fighters, instead, serve as elite combatants and officers, directing battles and commanding units. While they are competent on the front lines, trained fighters are a valuable commodity too important to waste in such environs.

Fighters serve as the core of any war effort; organizing tactics and leading grunt warriors into the fray. A powerful fighter is a puissant force, and while his insight is valuable behind the lines, his effectiveness in combat is unquestionable. Ironically, fighters have some of the most opportunity when determining what work they will take in a war effort, because their abilities are

usable nearly everywhere. Snipers, unit leaders, knights, and most other elite troops are fighter-based. Whether a fighter is a valiant cavalry leader urging his horsemen to charge, or a canny archer trained to remove opposing officers from the battle, there is a place for him in the war.

Monks

Monks rarely engage in open warfare, preferring personal perfection and contemplation to the blatant worldliness that is war. A monk who involves himself in a war does so for his own purposes. However, war has a habit of involving even the most reclusive and a monastery or secluded temple makes an inviting garrison or fortress for an occupying army.

Monks that do become soldiers eschew arms and armor, making them cheap soldiers, and an "unarmed" monk makes the deadliest assassin.

Paladins

The only way to ensure a paladin's support in a war is to make the battle just — good against evil, right against wrong. No paladin lends his arms to a war he does not believe in, but once committed, only proof of deception or a fall from grace can deter his righteousness.

Paladins are the ultimate commanders of men. Their high charisma and leadership ability raise morale in the troops serving them, and their divine abilities allow them to keep those troops fighting long after death should claim them. The paladin's connection with his mount makes him a natural cavalryman, and every general wishes to have a cavalry led by (or composed of) paladins.

The paladin's code limits his effectiveness in subtle warfare, however. They view such practices as espionage, sabotage, and other questionable activities as beneath them, and while they may understand the necessity for these operations, they would never stoop to performing such acts themselves.

Rangers

Rangers are not as unlikely to involve themselves in war as some might first imagine. While they tend to disassociate themselves with most social occurrences such as war, rangers are still men and women with loyalties to nations, family, and friends. Should a loyalty call upon them, they do not hesitate to answer.

Rangers make natural scouts and snipers in an army, using their wilderness canniness to their advantage and wearing the enemy down through superior knowledge of the terrain. Their ability to live off the land enables them to venture far from their base of operations and engage in missions of indefinite length and area.

In general, rangers avoid direct confrontation in war, not due to cowardice, but rather because of their distaste for organized, repetitive patterns. They instead harass, spy, and use similar means to indirectly hinder the enemy forces.

Rangers, like druids, intervene on behalf of the land in a war. While other classes might use any means available to hinder the enemy, such as salting the earth or burning forests, rangers always staunchly oppose such tactics. If an allied general continues to practice such methods over a ranger's objection, the rangers — at best — abandon him. Many rangers are willing to cause both sides' downfall rather than risk the destruction of the land, regardless of the cost in human life.

Rogues

Rogues are quite possibly the most plentiful of the PC classes in a war, surprisingly enough. The possibilities for power, glory, and wealth in wartime are second to none, and it is a sad rogue indeed who does not find some way to take advantage of war. While each other class usually has a niche it might fill, rogues can find one in every aspect of a military setting. A rogue's options in an army are nearly endless, and none knows this better than rogues themselves.

Many nations use enlistment as an alternative to punishment for crimes, and many soldiers have shady backgrounds. Ironically, this can counter the

nation's best interests, as far as they revolve around the rogue himself. A closely-knit unit of scalawags may fight well in battle, but likely continue their association into peacetime as a gang of thieves. Such prospects, as well as pay and room and board, make the crafty rogue consider soldiery more seriously.

Rogues excel as scouts, spies, saboteurs, and infiltrators. However, more than any other class, rogues must find true loyalties in a war. The popular opinion marks them as selfish, a possibly lethal prejudice in the midst of bloodshed. People might need a thief, and they might hire one, but trust is not easily bartered. Soldiers expect betrayal from rogues and so sometimes deliver it first.

Sorcerers and Wizards

In most instances, sorcerers and wizards serve identical purposes on the battlefield. While their methods of spellcasting might be vastly different, their practical applications make the only true distinction one of convenience.

Battle magic is quite deadly, and an entire unit of wizards or sorcerers, or even just one well-placed individual, can rule the battlefield. Fireballs, clouds of acid, and other methods of mass destruction make for intimidating displays, and many soldiers' worst nightmares involve robed individuals pointing at them.

Even off the battlefield, spellcasters make themselves invaluable. Magical defenses, magical espionage, and intelligence-gathering come naturally to spellcasters.

Finally, wizards and sorcerers hold great affections for lore and history — information any warlord covets. The most obscure piece of information or lore could hold the key to a victory, and the resident wizard might very well have access to such a thing. Alternatively, a valuable spell or piece of lore could be the entire reason for the war in the first place.

ALIGNMENT

War may bring out the worst in men, but it also inspires them to great acts of heroism. As always, alignment serves as a person or people's general. As always, these descriptions are only guidelines; not all characters fit into these broad strokes, nor should they.

Lawful Good

A lawful good soldier is an ideal follower. He has probably joined with the army of his own volition and committed himself to the cause. He follows orders, risks himself for his comrades, and attempts to serve both leadership and fellows to the best of his ability. He also typically lacks initiative, rarely pursuing any course outside his orders.

In a battle, the lawful good soldier never forgets himself. He helps injured comrades, salutes his enemy before engaging them, and refuses to condone illicit practices such as battlefield assassination. An honorable foe, he prefers taking prisoners to battlefield slaughter.

Neutral Good

A neutral good soldier views the chain of command as restrictive and distasteful but necessary. He follows commands, but has no qualms about voicing concerns. The neutral good soldier knows when he must seize initiative, and a crafty commanding officer knows when to trust him. Like the lawful good soldier, the neutral good believes in the cause for which he is fighting, but might not necessarily believe that it is as cut-and-dry as his associate does.

On the battlefield, the neutral good soldier is more concerned with the business at hand than any niceties; he's in the battle and he believes in it, that should be the end of it. While he would not stab an enemy in the back in most circumstances, neither would he condemn a comrade for doing so. The neutral good soldier is willing to do what it takes to see the war end, and if that involves a few illicit activities, then so be it.

Chaotic Good

The chaotic good soldier rarely finds himself on the battlefield proper. As he is far more concerned with results than methods, the soldier's leader may view him as a liability or as a dangerous commodity — most chaotic good characters spend the war in protest, in enemy camps, in the front lines, or in jail. Furthermore, the chaotic good character rarely feels comfortable taking orders, and while he may join an army out of a sense of duty, he would do his best to avoid being part of the chain of command.

The chaotic good soldier has no time for niceties—he is in a war, and so he wars. If he meets a foe who deserves no mercy, he employs any manner of dirty tricks. If he finds himself in a sea of foes, he endeavors to slaughter them all. Of all the good soldiers, the chaotic good is the least likely to offer or accept surrender.

Lawful Neutral

The lawful neutral character enters a war on orders, or not at all. He follows his commands to the last, heedless of himself or others, and demands the same of subordinates. The lawful neutral armies are some of the most terrifying in battle for this very reason—they do not flee when an evil army would, nor do they aid their fallen fellows. Though lawful neutral nations only rarely enter conflicts, they seek to end them quickly, efficiently, and on their own terms.

On the battlefield, the lawful neutral soldier does exactly what it takes to get the job done. He rarely takes the initiative because he has no orders to. He respects the moral niceties of war, however, and follows them until they conflict with his orders. The lawful neutral soldier has no respect for those who let their personal goals interfere with the execution of their orders, and has no difficulty executing those who disagree.

Neutral

Most neutral characters join the military because of their loyalty to a nation or leader instead of an ideal, or if they have a personal stake in the war's outcome. Neutral characters are poor soldiers,

however, making few commitments and giving others little reason to trust them. If the war no longer suits the neutral character's purpose, he probably deserts at the first opportunity.

Of all alignment types, a neutral character's actions vary most in battle. The same man deserts comrades, shows mercy to fallen foes, leads charges, and wages mass slaughter. His goals are his own, and he may view the war or the battle as a means to his end. He does what is necessary, rarely any more, and never any less.

Chaotic Neutral

A chaotic neutral character joins the military for the same reason he does anything else: because he feels like it. Understanding a chaotic neutral character's motivation is always difficult, and here it is no different. The chaotic neutral character has no place in the military, chafing under the chain of command and indulging his whims.

The chaotic neutral soldier is unpredictable in battle, acting on impulse rather than strategy. He may have loyalty to his fellows, and fight fanatically for them, but he may also flee when a greater enemy arrives.

Lawful Evil

A lawful evil character enters the war to gain power. Once integrated into the chain of command, the lawful evil character advances himself at any price, either by ensuring promotion or by seizing the reigns of power for himself. He pays heed to rules and orders and demands that others do the same, but he exploits any code to his own benefit.

In battle, the lawful evil character relaxes greatly without rules. So long as it does not interrupt the greater goal of victory, he indulges his every ambition, and may murder his own. He does whatever he needs to do in order to win, provided



the benefits outweigh the consequences. Similarly, he happily assassinates the opposition's commander, provided he can take the credit for the kill without suffering the blame.

Neutral Evil

The neutral evil character usually avoids the military because of the long-term commitment involved. While a neutral evil character has no problem dealing with such a power structure, he does not care for the obligations demanded of him. The neutral evil character, like other evil characters, feels more loyalty to himself than an ideal or nation, involving himself in a war only for personal advancement.

The neutral evil character avoids the battlefield if he can help it. Once there, he fights as necessary, preferring to flee or seek what opportunities the battle offers him.

Chaotic Evil

The chaotic evil character prefers to work alone, but often finds a love for bloodshed only satisfied with battle. Despite this, the chaotic evil character has little need for orders or superiors. He goes where he will and kills who he will. He is a terrible soldier, but a fine storm trooper or saboteur. He follows orders only if they comply with what he would otherwise do, if he fears retribution, or if he has sufficient bribes.

BATTLE RULES

No battle fights itself, and even the greatest DM may find a war bogging down his campaign. The following rules may aid in the task of customizing the war to the campaign.



NEW SKILLS

STRATEGY (INT)

Strategy is the art and science of war off of the battlefield. It is the ability to run not just a battle but an entire war. It encompasses, but is not limited to, knowledge of supplies, logistics, terrain, espionage, and engineering. Strategy is all of the work involved in war before the battle — building an efficient and functional army, keeping them in good morale, and good fighting condition, and using them where they are the most effective.

Check: When using battlefield strategies (*see below*), the highest ranking person with this skill makes the rolls, unless a subordinate somehow takes charge (technically an act of treason). Characters may cooperate to this end, forming a command group. Characters may not take ten for strategy rolls.

Retry: No. While the commander or command group may attempt the same strategies multiple times in a battle or war, even if they failed previously, they must live with the consequences. Furthermore, each time the commander or command group repeats a strategy, any opposing strategist gets a cumulative competence bonus equal to their Intelligence modifier to detect this.

Special: Commanders with the Tactics skill, or the Leadership or Tyrant traits, get a +1 synergy bonus to their Strategy rolls. An untrained Strategy check is a simple Intelligence check, but the tactician gains no circumstance bonuses and has a -4 competence penalty.

TACTICS (INT)

Tactics represent the sum of the knowledge and techniques applied during the course of a battle. Knowing when to charge, when to regroup, when to flank, and when to surrender are all part of a sound tactical mind. During a battle, the general and unit commanders must be equally knowledgeable of tactics, as the army commander issues orders and the unit commanders struggle to make the most use out of their commands.

Check: When using battlefield strategies (*see below*), the leader of a unit makes the Tactics rolls, even if someone else in the unit has greater skill (the more skilled tactician may attempt to take control, but this, too, is a technical treason). While multiple tacticians may cooperate, they generally have little time to do so on the battlefield, and provoke attacks of opportunity when attempting to make such rolls. Characters may not take ten with Tactics rolls.

Retry: No. While the leader may attempt the same Tactics multiple times in a battle or war, even if they failed previously, he must live with the consequences. Furthermore, each time the commander repeats a tactic, any opposing tactician gets a cumulative competence bonus equal to their Intelligence modifier to detect this.

Special: Commanders with the Strategy skill, or the Leadership or Tyrant traits, get a +1 synergy bonus to their Tactics rolls. An untrained Tactics check is a simple Intelligence check, but the tactician gains no circumstance bonuses and has a -4 competence penalty.

Tactics Result Modifiers:

Each Enemy Engaged Beyond the First
Outnumber Enemy Unit

Surprise Attack

Bonus/Penalty

-5

+2 For Every 20% by which the Unit
Outnumbers the Opponent

Defender Unable to Use Strategy Bonus

UNIT-BASED COMBAT

SETTING THE STAGE

In many instances, the battle's outcome is clear before the first arrow flies. A good general knows as much as he can about the supply lines, terrain, and morale of both armies. Before a battle, have each general make a Strategy check. The winner of the check gains a competence bonus equal to half the rolls' difference for all of his army's tactics checks during the battle.

Example: Tiliean and Dareina lead opposing armies to battle at Drowned Ogre Pass. Tiliean has 8 ranks in Strategy, whereas Dareina has 14. Simulating preparations for battle, military intelligence efforts, and scouting efforts, they both roll. Tiliean rolls an 18, and Dareina rolls an 8. Adding their Strategy scores, Tiliean has 26, and Dareina has 22 (difference of 4). Tiliean managed to find and exploit a minor weakness in Dareina's battle plan, and now has a +2 bonus to all of his army's Tactics checks for this battle.

This roll represents an abstraction for forcing an enemy into an unfavorable position, acquiring intelligence about an enemy's movements, and other methods of setting the battlefield in one general's favor. It does not take into account the actions of individuals on either side, including the PCs or their counterparts in the opposing army. Should the PCs take a direct hand in information gathering, sabotage, or other areas of strategy, the DM may award circumstance bonuses to the general's roll (for valuable information or aid in setting the stage) or inflict penalties (for incompetence, or for enemy's sabotage). The DM adds or penalizes based upon how thoroughly this alters the coming battle — the discovery of a hidden ravine might grant a +1, while a successful sabotage of all the army's war machines and supplies might inflict a -20 penalty!



RANK AND FILE

While the DM may divide an army however he wishes, the typical method is between the leader (the presiding officer in the battle), the lieutenants (who coordinate units and carry out orders on the leader's behalf), and the captains (who lead individual units). While the ranks differ from army to army and nation to nation, for the purposes of these rules, the rank of officers in charge of a unit type is referred to as a lieutenant, and individual unit leaders as *captains*. While this rules set uses three levels of command, the DM may adapt it for more or fewer as he sees fit.

Each unit has a Morale score, which indicates its courage and willpower. The base Morale score is equal to the soldiers' average hit dice + their captain's Charisma modifier (minimum 0). Morale modifies, however, due to outside circumstance or extended trials; for the purposes of the following chart, the most common alignment in the unit is the unit's overall alignment. The following competence modifiers accumulate:

Positive (+2) modifiers: One common alignment with the unit's captain, success in previous battles, opponents obviously weaker, fighting in familiar terrain

Positive (+4) modifiers: Alignment matches with captain's alignment exactly, the unit has never lost a battle, the unit fights in their homeland, the war has gone well for the army

Negative (-2) modifiers: Untried or distrusted commander or captain, failure in previous battles, unworthy cause, etc.

Negative (-4) modifiers: The captain's alignment is in opposition with his unit's, the army has lost several battles, the units are conscripts, etc.

Before the battle begins, the DM should note the type of each unit in the battle, along with the unit captain's Tactics skill, the unit's Morale score, and any important characters or items in the unit. If the PCs are unit captains, army lieutenants, or generals, they should have access to information about the troops under their command, and any intelligence about the enemy they have discovered.

OPENING SHOTS

The first order of business in an engagement is to determine the Attacker and Defender. The criteria for this is very simple: whichever side arrives first (whether by minutes or by years) is the defender. The defender has several advantages, depending on how long they have held the battlefield — fortifications, knowledge of the area, and time to organize defenses. On the other hand, the attacker has one major advantage: they get to determine the timing and nature of the attack.

Each round covers several different levels of the battle itself. First the DM calculates the success of individual units (including the PCs, if any), and then determines the overall tide of battle. While the DM may abstract these to rolls, he may choose not to if the PCs involve themselves.

At the beginning of the battle, each Attacking unit must choose which Defending unit to engage. While several attacking units can engage one opposing defending, the reverse is not true — one unit cannot voluntarily engage multiple ones (although, should the battle turn against them, the unit will face such odds eventually), with any excess or hidden defending units choosing their targets afterward. Once units engage, the battle proceeds in rounds (roughly the same length of time as a normal combat round). During the first round of the battle, all Attacking units are “on the offensive” and all Defending units are “on the defensive.” This can (and usually does) change during the course of the battle.

THE WEAR OF BATTLE

Each round of battle is roughly the same, the attacker and defender exchange blows and then the DM determines whether either side's lines break. To determine which side is most effective in the exchange of blows, make a Tactics check for each unit's captain. Higher officers, such as subcommanders and the general, can choose one unit directly below them in the chain of command to focus their efforts upon, adding their strategy

ranks to that unit's result. Alternatively, they may add half their strategy ranks to any unit below them (not necessarily immediately below).

Example: Dareina leads her army with infantry lieutenant Irilan and cavalry lieutenant Olain. Irilan, because he ranks directly above the infantry captains, can choose to add his strategy bonus to one infantry unit, just as Olain can do with the cavalry. Dareina, however, must deal with the entire battlefield. As a result, while she can focus on any unit under her command, she cannot do so with the same intensity her subcommanders can, adding only half her strategy rank to their result.

The winner of each engagement for the round is the side that rolled the higher Tactics check. After establishing the winner and loser, the DM determines casualties. Roll 1d4 for each engaged unit, adding one for each enemy unit engaging the unit with casualties. The lower result, times 5%, is the winner's casualties. The higher result, times 10%, represents the loser's casualties. Ties represent similar casualty counts, with the winner earning a tactical advantage. In the case of multiple units in an engagement, rank the casualty counts in the same order as the tactics results. Casualties are percentages of original unit strength, rather than its present condition, but a unit suffers zero casualties if they double or more the opponent's Tactics roll, or 100% casualties if their opponents overwhelm them by at least three times the unit's hit dice, number, and Tactics rolls.

Example: Colien's infantry unit engages an enemy infantry unit. Colien, an effective unit captain, manages an 18 on his unit's tactics check. The enemy unit, roughly the same in number, scores a 14. The DM rolls 1d4 for each unit, coming up with 3 and 1. Colien's unit, as the winner, suffers 5% casualties, and the enemy 30%.

Later in the battle, Colien outflanks an enemy unit of goblins. The goblins wield rusty equipment and have no tactical leadership to speak of. Colien manages an otherwise unimpressive 14 on his unit's check, but the goblin commander's check is a mere 5. Colien routes the enemy unit, leaving the goblins either dead or fleeing.

After the bodies fall, check the unit's morale.

DEATH OF NATIONS

PC'S ARMY IS:

PCS ARE IN THIS PART OF THE FIGHTING:

Wining Even Losing	Reserves	Disengaged Reserves	Engaged Disengaged Reserves	Heavily Engaged Engaged Disengaged	Heavily Engaged Engaged	Heavily Engaged
1-4	2 at +4	3 at +6	4 at +8	4 at +10	5 at +10 Combat Opportunity	6 at +12
5-8	2 at +4	2 at +4	3 at +6	4 at +6 Combat Opportunity	4 at +8	5 at +10
9-12	1 at +2	2 at +4	2 at +4	3 at +6	4 at +6 Combat Opportunity	4 at +8 Combat Opportunity
13-16	1 at +2	2 at +2 Combat Opportunity	2 at +4 Combat Opportunity	3 at +4 Combat Opportunity	3 at +6 Combat Opportunity	4 at +6 Combat Opportunity
17-20	0 at +2 Combat Opportunity	1 at +2 Combat Opportunity	2 at +4	2 at +4 Combat Opportunity	3 at +4 Combat Opportunity	3 at +6 Combat Opportunity
21-24	0 at +2	1 at +2 Combat	1 at +4	2 at +2	2 at +4 Combat Opportunity	3 at +4 Combat Opportunity
25+	0 at +2 Combat Opportunity	0 at +2	1 at +2 Combat Opportunity	2 at +2	2 at +4 Combat Opportunity	2 at +4 Combat Opportunity

A unit with high morale can both attack the unit and hold its line; a unit with low morale surrenders or flees. Roll 1d20 and add the unit's Morale score (Average HD + leader's Cha modifier, plus situational modifiers). If this result is equal to or higher than 10 + enemy unit leader's Tactics skill, the lines hold and the unit does not break. If, however, the Morale check result is less than that number, the lines break, and the unit loses coherency and flees. In the case of multiple opponents, use the highest Tactics skill involved.

If the roll is negative and the unit has at least one alignment in common with their foes and none in opposition, they may switch sides (DM's decision).

If the loser of the round does not break, they instead suffer a cumulative -2 penalty to their Morale for the remainder of the battle. Then, each unit has determined all results, the round ends. Each unit that won the round goes on the offensive, and each unbroken losing unit goes on the defensive.

A unit that defeats its opponent (either by attrition or by a rout) goes on the offensive, and their leader chooses their next opponent.



It is possible that opposing units can be on the offensive at the same time. At the end of the round, one pushes the other back, forcing them to the defensive.

Example: Because Colien's unit won this round of the battle, their opponent must make a Morale check. Colien has 6 ranks in Tactics, and so his enemy's DC is 16 (10 + 6 ranks in Tactics). His enemy is moderately well-trained and well-led, with a Morale score of 7. The enemy unit rolls an 11, giving them a total of 18, meaning their lines have held. Because they lost the round, however, Colien's opponents suffer a -2 to their Morale for subsequent rounds. Colien's unit is now on the offensive.

Units on the offensive have more freedom of movement, adding +1 circumstance bonuses to their Tactics rolls. Defensive units suffer no penalties on rolls, but may only hold their ground or retreat until they return to the offensive.

WINNING THE BATTLE

As many criteria for winning a battle exist as there are battles. If the goal of a battle is to take a particular piece of ground, then the battle ends only when an army routs, surrenders, or dies. At any time during a battle, any general can give the order to flee or surrender, and very few battles continue until one side is completely decimated. To do so when other options exist is futility itself, sacrificing any chance of future retaliation.

While the above covers most battles, many battles end once certain criteria are met — the acquisition of a particular item or person, the death of a particular individual, or various other conditions. In such circumstances, the victorious army typically flees once they complete their objective.

UNIT TYPES

Each of these unit traits represents aspects of a combat unit that affect their function in a battle. They are cumulative (“elite heavy cavalry,” for instance). The DM determines the availability of units, and whether they work for a particular leader. DMs may, of course, create additional unit traits as appropriate for his campaign.

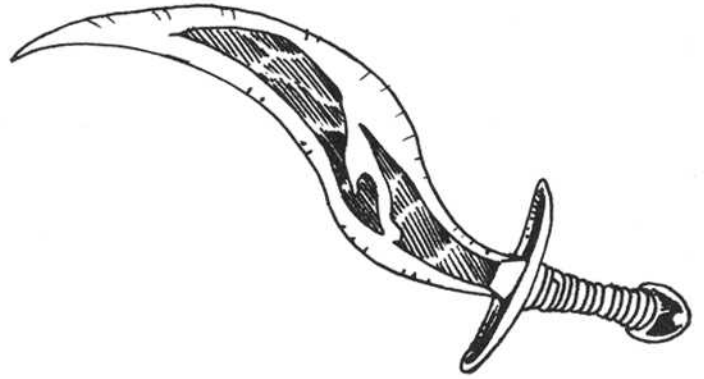

Infantry

The workhorse of any army, standard infantry are moderately armed and armored, capable of serving most basic purposes in an army. Normal infantry have no special modifiers or traits.

Cavalry

Swift and deadly on the offensive, cavalry is often the deciding factor in a battle, but their momentum and maneuverability have little use on the defensive. Cavalry primarily finish routed enemy units or support allied infantry.

Cavalry receive a +4 competence bonus on their Tactics checks while on the offensive, but a -2 while on the defensive.

Elites

After spending long years working, fighting, and living together, certain units of troops fight at a level above normal soldiery. Very simply, elite units are more efficient than their standard counterparts.

As a result, elite units receive a +2 competence bonus on ALL rolls. In addition, they tend to be more experienced warriors, and have more hit dice, making them less likely to rout.

Ranged

Whether ranks of men with bows or small groups of war wizards, ranged units function in essentially the same way — they rain death upon an enemy from afar. Until they engaged (a rarity; most ranged units receive protection second only to the general himself), ranged units attack the enemy from afar.

Unless they take return fire, or there are extenuating circumstances (concealing terrain, shield walls, other anti-ranged defenses), ranged units' Tactics checks are automatically successful (if they are not, the DM should create appropriate DCs). They are normally less devastating, however, inflicting 1d2% (instead of the normal 1d4) for casualties. When in close combat, ranged units suffer a -2 morale penalty.

Heavy

Sometimes, a unit has to sacrifice speed for strength, giving their soldiers more powerful weaponry and heavier armor. While this process is expensive, it can also devastate an enemy army. Equipped with heavy weapons and wearing heavy armor, these units inflict and take more punishment than standard units.

Heavy units add +1 to their roll for casualties caused, and subtract 1 from the amount they take. However, because of their lack of maneuverability, they suffer a -2 to all of their Tactics checks.

Conscripts

Some unlucky souls have no choice whether or not to fight for their country. While conscripts are usually quite plentiful, they lack the resolve and training of professional soldiers. Furthermore, both their training and their equipment are substandard.

Conscript units suffer -2 to *all* rolls they make. In addition, because they usually consist of those people who were unable to avoid the draft, conscript units nearly always have low hit dice, and thus, low morale. An elite unit loses its conscript status.

ABSTRACT BATTLE RULES

Far less detailed than previous rules, the following rules determine the overall course of a battle, rather than examining it unit by unit. This system renders the overall army structure unimportant, outside of numbers. If the DM already has a result in mind for the battle, he should use

this system. Also, if the PCs are soldiers with nobody under their command, this system still allows them to have an affect on the fight.

SET-UP

As above, the many battles have an obvious outcome. To represent this, the generals opposed Strategy checks. The winner can use half the difference as a positive modifier to all Tide of Battle Tactics rolls they make during the battle.

COMBAT

Each round, the PCs (or, more accurately, their commanding officers) involved have to choose how heavily they wish to engage the enemy. They can choose from Reserves, Disengaged, Engaged, or Heavily Engaged.

Once all PCs choose their Level of Engagement, determine which army wins the current round with an opposed Tactics check between the two generals, applying modifiers from successful Combat Opportunities during the previous round and remembering to add the strategy modifier, if any. This check determines the current Tide of Battle, with a tie resulting in an "Even" outcome.

PC subcommanders (anybody in charge of one or more units), can add half their Tactics ranks to the general's roll, but this causes a -2 penalty to their personal results roll later on, as they concentrate more on the overall battle than their own well-being.

TIDE OF BATTLE MODIFIERS

High Ground: +2

Difficult Ground: -2 (both sides, unless one is specifically prepared)

Ambush/Surprise Attack: Surprised side AUTOMATICALLY loses first Tide of Battle check.

Numerical Advantage: +2 per 10% difference between armies (*example: 5,000 vs. 4,000 = 20% difference = +4 bonus*).

PERSONAL RESULTS ROLL

Each PC makes a Tactics check. Consulting the Mass Combat table to find the result of his roll on the left column, then read across that row until you match the appropriate Tide of Battle and Level of Engagement. The result tells the PC two things:

ATTACKS THIS ROUND

In each round, PCs suffers attacks as a result of the massed melee. This entry states how many attacks, and at what bonus, the PC suffers. The intensity of the engagement determines how much damage each attack does, with a suggested 1d6 for an average battle, 2d6 for a pitched fight, and 3d6 for a frenzied melee. Example: 3 at +5, with 1d6 damage means that a PC suffers 3 attacks, each at a +5 bonus, doing 1d6 damage on a successful hit.

COMBAT OPPORTUNITIES

PCs have the chance to have a significant impact on the Tide of Battle. Each opportunity has a Challenge Rating, indicating the level of encounter, and the associated experience with success. Roll 1d10 on the chart below, or select an appropriate Opportunity.

1. Healer
2. Pick Up the Banner
3. Hold This Ground!
4. Break the Line
5. A Clear Shot
6. Draw the Line
7. Save a Wounded Comrade
8. Take the Enemy Banner
- 9-0. Officer



Healer

Next round, the PC has the opportunity to reach medical attention. He has no Personal Results roll for that round, nor can he use his Tactics skill to aid in the battle, but a healer offers him 1d3 points of healing.

CR: 0

Pick Up the Banner

The PC sees his army's standardbearer fall to the enemy. He has the opportunity to pick up the standard, earning great prestige. For as long as he carries the banner, the Challenge Rating of all Combat Opportunities is 1 greater for experience purposes. However, because of the target he presents, the PC suffers 1 extra attack each round of the battle.

CR: +1 (*see above*)

Hold This Ground!

The PC's leader tells him to hold the line. He must remain in his current Level of Engagement for the next two rounds. If he succeeds, his general gets a +2 bonus to his Tide of Battle check.

CR: Reserves 1, Disengaged 2, Engaged 3, Heavily Engaged 4

Break The Line

The PC's commander orders him to charge. Next round, subtract 2 from the PC's Personal Results check, but the general's Tide of Battle check is +1 (assuming the PC survives).

CR: 2

A Clear Shot

The front lines break, and the PC has a clear shot at an important commander of the opposing army with a missile attack.

CR: 0, but -3 from opposing Tide of Battle check if successful.



Draw the Line

The PC receives orders to draw the enemy's front line further away from their reserves. Next round he is Heavily Engaged, but adds +1 to the general's Tide of Battle check (if he survives).

CR: 3

Save a Wounded Comrade

The PC notices a companion has fallen in battle. He can save him, but enters Heavy Engaged status for the next two rounds if he does.

CR: 4

Take the Enemy Banner

The PC has the opportunity to take the enemy's banner. First, he must engage the standardbearer in a fight, then take the banner back to his own army's Reserves. He may only move one step closer to Reserves each round (Heavily Engaged to Engaged, Engaged to Unengaged, etc.), and the increased attention adds +4 to his Personal Results roll. On the round after he makes it back to the Reserves, add +5 to the general's Tide of Battle check.

CR: 5 + ensign's level.

Enemy Officer

The PC comes face-to-face with an enemy officer, and has the opportunity to fight him. Use the normal combat rules against the officer. If an officer (including the PC) dies in battle, his general suffers -3 to his Tide of Battle check for the remainder of the battle. The PC may also have to face the officer's men in this fight.

CR: Officer's level.

Note: In the cases of both Take the Enemy Banner and Enemy Officer, normal combat begins. The "rounds" within this system presented are significantly longer than a normal combat round, so unless the DM decides that the fight takes an inordinately long time, both events only take one round of the mass combat.

WINNING THE BATTLE

Once one side has won the Tide of Battle check three times in a row, they have won the battle. The other side retreats or surrenders and both sides are left to tend to their dead and wounded. Roll 1d20 to determine casualties.

1d20 Result	% of Winner Wounded	% of Winner Killed	% of Loser Wounded	% of Loser Killed
1-2	1%	2%	2%	5%
3-4	2%	5%	5%	10%
5-6	5%	10%	10%	20%
7-8	10%	20%	20%	25%
9-10	2%	10%	5%	20%
11-12	5%	20%	10%	25%
13-14	10%	25%	20%	40%
15-16	20%	40%	25%	50%
17-18	5%	25%	10%	40%
19-20	10%	40%	20%	50%

THE OPEN GAME LICENSE

The following text is the property of Wizards of the Coast, Inc. and is Copyright 2000 Wizards of the Coast, Inc ("Wizards"). All Rights Reserved.

- Definitions: (a) "Contributors" means the copyright and/or trademark owners who have contributed Open Game Content; (b) "Derivative Material" means copyrighted material including derivative works and translations (including into other computer languages), potation, modification, correction, addition, extension, upgrade, improvement, compilation, abridgment or other form in which an existing work may be recast, transformed or adapted; (c) "Distribute" means to reproduce, license, rent, lease, sell, broadcast, publicly display, transmit or otherwise distribute; (d) "Open Game Content" means the game mechanic and includes the methods, procedures, processes and routines to the extent such content does not embody the Product Identity and is an enhancement over the prior art and any additional content clearly identified as Open Game Content by the Contributor, and means any work covered by this License, including translations and derivative works under copyright law, but specifically excludes Product Identity. (e) "Product Identity" means product and product line names, logos and identifying marks including trade dress; artifacts; creatures characters; stories, storylines, plots, thematic elements, dialogue, incidents, language, artwork, symbols, designs, depictions, likenesses, formats, poses, concepts, themes and graphic, photographic and other visual or audio representations; names and descriptions of characters, spells, enchantments, personalities, teams, personas, likenesses and special abilities; places, locations, environments, creatures, equipment, magical or supernatural abilities or effects, logos, symbols, or graphic designs; and any other trademark or registered trademark clearly identified as Product identity by the owner of the Product Identity, and which specifically excludes the Open Game Content; (f) "Trademark" means the logos, names, mark, sign, motto, designs that are used by a Contributor to identify itself or its products or the associated products contributed to the Open Game License by the Contributor (g) "Use", "Used" or "Using" means to use, Distribute, copy, edit, format, modify, translate and otherwise create Derivative Material of Open Game Content. (h) "You" or "Your" means the licensee in terms of this agreement.
- The License: This License applies to any Open Game Content that contains a notice indicating that the Open Game Content may only be Used under and in terms of this License. You must affix such a notice to any Open Game Content that you Use. No terms may be added to or subtracted from this License except as described by the License itself. No other terms or conditions may be applied to any Open Game Content distributed using this License.
- Offer and Acceptance: By Using the Open Game Content You indicate Your acceptance of the terms of this License.
- Grant and Consideration: In consideration for agreeing to use this License, the Contributors grant You a perpetual, worldwide, royalty-free, non-exclusive license with the exact terms of this License to Use, the Open Game Content.
- Representation of Authority to Contribute: If You are contributing original material as Open Game Content, You represent that Your Contributions are Your original creation and/or You have sufficient rights to grant the rights conveyed by this License.
- Notice of License Copyright: You must update the COPYRIGHT NOTICE portion of this License to include the exact text of the COPYRIGHT NOTICE of any Open Game Content You are copying, modifying or distributing, and You must add the title, the copyright date, and the copyright holder's name to the COPYRIGHT NOTICE of any original Open Game Content you Distribute.
- Use of Product Identity: You agree not to Use any Product Identity, including as an indication as to compatibility, except as expressly licensed in another, independent Agreement with the owner of each element of that Product Identity. You agree not to indicate compatibility or co-adaptability with any Trademark in conjunction with a work containing Open Game Content except as expressly licensed in another, independent Agreement with the owner of such Trademark. The use of any Product Identity in Open Game Content does not constitute a challenge to the ownership of that Product Identity. The owner of any Product Identity used in Open Game Content shall retain all rights, title and interest in and to that Product Identity.
- Identification: If you distribute Open Game Content You must clearly indicate which portions of the work that you are distributing are Open Game Content.
- Updating the License: Wizards or its designated Agents may publish updated versions of this License. You may use any authorized version of this License to copy, modify and distribute any Open Game Content originally distributed under any version of this License.
- Copy of this License: You MUST include a copy of this License with every copy of the Open Game Content You Distribute.

- Use of Contributor Credits: You may not market or advertise the Open Game Content using the name of any Contributor unless You have written permission from the Contributor to do so.
- Inability to Comply: If it is impossible for You to comply with any of the terms of this License with respect to some or all of the Open Game Content due to statute, judicial order, or governmental regulation then You may not Use any Open Game Material so affected.
- Termination: This License will terminate automatically if You fail to comply with all terms herein and fail to cure such breach within 30 days of becoming aware of the breach. All sublicenses shall survive the termination of this License.
- Reformation: If any provision of this License is held to be unenforceable, such provision shall be reformed only to the extent necessary to make it enforceable.
- COPYRIGHT NOTICE: Open Game License v1.0 Copyright 2000, Wizards of the Coast, Inc.

PRODUCT IDENTITY

The following items are hereby designated as Product Identity in accordance with Section 1(e) of the Open Game License, version 1.0: Any and all Alderac Entertainment Group logos, identifying marks and trade dress, including all Alderac Entertainment Group Inc., Product and Product line names including but not limited to Dungeons, Evil, Dragons, Undead, War, Monster, and Gods; any elements of game setting, including but not limited to capitalized names, names of artifacts, spell names, characters, countries, creatures, geographic locations, gods, historic events, magic items, organizations, secret societies or legends; any and all stories, storylines, plots, thematic elements, and dialogue; any and all artwork, symbols, designs, depictions, illustrations, maps and cartography, likenesses, poses, logos, symbols or graphic designs, except such elements that already appear in the d20 System Reference Document (e.g. Melf or Mordenkainen) and are already OGC by virtue of appearing there. The above Product Identity is not Open Game Content.

THE OPEN GAME CONTENT

The following items are hereby designated as Open Game Content in accordance with Section 1(e) of the Open Game License, version 1.0. All other items are designated Product Identity and is © and ™ 2001 Alderac Entertainment Group, inc.

The information presented in gray boxes is considered Open Game Content.

In Section Two, all skills, feats, and prestige classes are considered Open Game Content, with the exception of name identity as established in the Product Identity section.

In Section Three, all siege engines and large scale weapons are considered Open Game Content, with the exception of name identity as established in the Product Identity section.

In Section Four, all domains, spells, magic items, and artifacts are considered Open Game Content, with the exception of name identity as established in the Product Identity section.

Use of Spells, Magic Items, and Artifacts as Open Game Content: It is the clear and expressed intent of Alderac Entertainment Group, inc. to add all game mechanics involving spell effects, magic item effects, and artifact effects contained in this volume to the cannon of Open Game Content for use pursuant to the Open Game License by future Open Game publishers. Some spell names, magic items and artifacts contain Product Identity, as designated above, and that designation remains.

Legal Stuff

Dungeons and Dragons® and Wizards of the Coast® are trademarks of Wizards of the Coast, and are used in accordance with the Open Game and d20 Licenses.

'd20' and the 'd20 System' logo are Trademarks owned by Wizards of the Coast and are used according to the terms of the d20 System License version 1.0. A copy of this License can be found at www.wizards.com.

AEG 8508



WAR™

GOD • KING • COUNTRY

For thousands of years we have fought. If not with the orcs and goblins and ogres and miscreants so foul it burns your eyes just to say their names, we have warred within. None know more the ways of warfare and combat than our people. We have suffered under the banner of oppression or fought under the flags of prosperity, but always we have fought to keep ourselves safe.

I have sworn an oath to die protecting my king and I pledge my sword to forever serve him. I pledge to rid this place of all beasts foul and contemptible. May the people of Westbrook never know fear again, so long as we ride in valor and nobility to challenge the unkempt creatures of the earth.

For the people!

— General Anyk'dar, High Commander of Westbrook
and Last Defender of the Wind

THIS IS THE TOME OF CHAMPIONS

This sourcebook contains everything a GM or player needs for campaigns in war-torn worlds. Regular and irregular troops, closed and open formations, cavalry, infantry, and artillery are all tools at a Field Commander's disposal. Lift your banner and join your men in a glorious battle against the forces that oppose your countrymen.

Up the rebels.

VICTORY IS AT HAND

- Rules for mass combat
- 15 prestige classes
- New gods of war
- Rules for siege engines
- New feats
- New spells and magic items
- Unit compositions and strategies
- War campaigns and more

ISBN 188795345-0



9 781887 953450



\$19.95 US MSRP

www.alderac.com