

DUNGEONS & DRAGONS[®]

GAZETTEER

OFFICIAL GAME ACCESSORY

Dawn of the Emperors Thyatis and Alphatia

by Aaron Allston

Compatible
with the AD&D[®]
and 2nd Edition
AD&D game
systems.
Adventures
included!

ISLE
OF
DAWN

OCHALEA

BELLISSARIAN
SEA

TSR
TSR, Inc.
PRODUCTS OF YOUR IMAGINATION[™]

DUNGEONS & DRAGONS, AD&D, PRODUCTS OF YOUR IMAGINATION, and the TSR logo are trademarks owned by TSR, Inc.

DUNGEONS & DRAGONS™

GAZETTEER



ISLE
OF
DAWN

BOOK ONE:

The Dungeon Master's Sourcebook

by Aaron Allston

GAZETTEER

An Official DUNGEONS & DRAGONS® Game Supplement

DAWN OF THE EMPERORS

by Aaron Allston

Table of Contents

BOOK ONE: THE DUNGEON MASTER'S GUIDE

Introduction	2	Other Territories	61
Thyatis	4	Campaigning	83
History of Thyatis	4	Adventures	93
Atlas of Thyatis	8	Appendices	108-117
Characters of Thyatis City	23	Costs	108
Monsters of Thyatis	32	Spells Normally Carried	109
Campaigning in Thyatis	33	AD&D Conversions	116
Alphatia	39	Record Sheets	118-127
History of Alphatia	39	Diagram of the Shark	128
Atlas of Alphatia	40		
Characters of Sundsvall	50		
Monsters of Alphatia	56		
Campaigning in Alphatia	59		

Credits:

Design: Aaron Allston
Additional Material: Mark Bennett
Editing: Karen S. Boomgarden
Product Manager: Bruce Heard
Cover Artist: Clyde Caldwell
Interior Artist: Stephen Fabian
Cartography: Dave Sutherland

©1989 TSR, Inc. All Rights Reserved. Printed in U.S.A.

DUNGEONS & DRAGONS, D&D, ADVANCED DUNGEONS & DRAGONS, AD&D, and WORLD OF GREYHAWK are registered trademarks owned by TSR, Inc.

PRODUCTS OF YOUR IMAGINATION, BATTLESYSTEM, FORGOTTEN REALMS, and the TSR logo are trademarks owned by TSR, Inc.

Distributed to the book trade in the United States by Random House, Inc., and in Canada by Random House of Canada, Ltd. Distributed to the toy and hobby trade by regional distributors. Distributed in the United Kingdom by TSR Ltd.

This module is protected under the copyright laws of the United States of America. Any reproduction or other unauthorized use of the written material or artwork herein is prohibited without the express written permission of TSR, Inc.
1037XXX1901

TSR, Inc.
POB 756
Lake Geneva,
WI 53147 USA



TSR Ltd.
120 Church End, Cherry Hinton
Cambridge CB1 3LB
England

Introduction

Dawn of the Emperors is a companion set to the *Gazetteer* series. As with previous *Gazetteers*, we're showcasing a particular area of the Known World . . . but, unlike previous efforts, we're not limiting ourselves to a single nation. Oh, no.

Dawn of the Emperors is about the two greatest empires in the Known World: Thyatis and Alphatia.

Thyatis

Thyatis, once nothing more than a spur on the western continent, began its rise from obscurity a thousand years ago to become the dominant power of the western world. It's an empire where a peasant can fight and connive his way onto the imperial throne . . . and find himself on the executioner's block when he makes his first mistake or shows the first signs of weakness. It's an empire where races blend freely, where organization and efficiency are the hallmarks of the national character, where trade and negotiations are taught to children on their mothers' knees.

And yet, more than all these traits, it is fighting ability which is most admired by Thyatians of all racial backgrounds and social classes. Only one man can hold the throne at a time; only those learned and lucky in trade can amass huge mercantile fortunes. But anyone, from any part of the empire, can become a warrior-knight, and that's the dream and ambition of the masses.

Alphatia

Alphatia, which began its rise from an ill-populated region to a great imperial power more than two millennia ago, is a land of mystery and alien custom. Magic is the life's blood of this land. While anyone can amass fame and fortune, the only way to rule, or even to receive the respect of the Empress and the empire's ruling council, is to know the art of magic. Newborn children, from the poorest peasant child to the most extravagantly indulged royal princess, are examined by magic-users to determine their magical potential. Those who show even the slightest hint of mystic ability are trained in the arts from the time of their earliest memories.

Yet, for all this obsession with one subject—the arcane—the Alphatians are notorious for the chaotic and illogical maintenance of their empire. This is an empire where the use of powerful magics can change the very nature of entire cities, where the whims of the Empress and her council become law—even if only for a day—and where domination of subordinate nations is maintained through fear and intimidation, or through eccentric blood-ties, or through sheer magical might, rather than by managerial efficiency and impartial law.

The Empires Together

It should be no surprise, then, that the two empires are diametrically opposed. The dislike of Thyatians for Alphatians, and vice versa, is legendary. The two empires have a history of strife and bitterness dating back more than a millennium, to the time before Thyatis was even a nation.

And yet the two empires can't continually make war on one another. Wars between the empires weaken all antagonists and ultimately destroy them both. So Thyatis and Alphatia trade with one another, send ambassadors to one another's courts, observe all the polite mannerisms . . . But, sly and tireless, they maneuver for political domination, clash with one another in far-distant lands over colonial and trade rights, embarrass one another, and crow over one another's mistakes.

War does break out from time to time, usually lasting until both sides are tired and need some time to recover. Treaties are negotiated and signed, and the two great powers sit back for another few years or decades of watchful waiting.

This is the campaign set of these two world powers. Each, individually, is an exciting place to visit and explore. Each offers myriad opportunities for adventure and gain. But in the areas where the two empires mix, where they secretly and unceasingly wrestle for control, heroes and villains can tip the scales and affect the future history of the entire world. This is

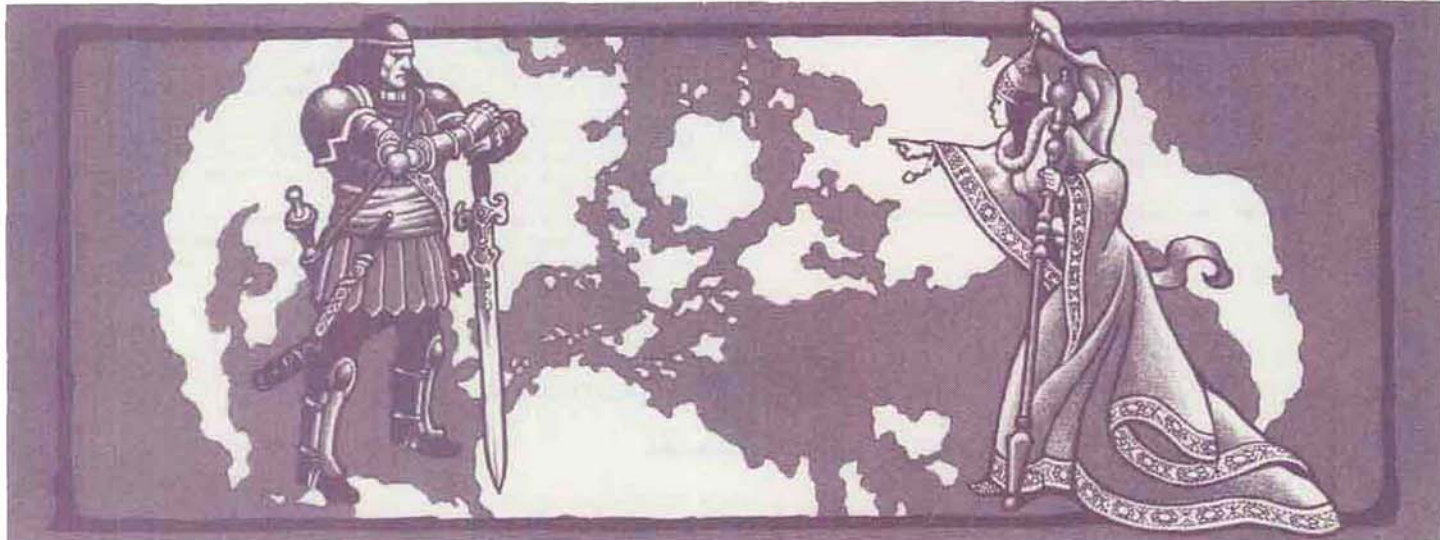

what *Dawn of the Emperors* is all about, and it is in this setting that your player-character heroes will face their greatest challenges.

A Note to Players

The rest of this book is for the eyes of the DM only. If you plan to play in a campaign set in Thyatis or Alphatia, but not to DM the campaign, read no further in this book. The other two books in this set, however, are for your use.

Recommended Reading

Useful in the writing of *Dawn of the Emperors*, and recommended to DMs and players, are the following:

The entire Gazetteer series: *The Grand Duchy of Karameikos*, *The Emirates of*

Ylaruam, *The Principalities of Glantri*, *The Kingdom of Ierendi*, *The Elves of Alfheim*, *The Dwarves of Rockhome*, *The Northern Reaches*, *The Five Shires*, *The Minrothad Guilds*, *The Orcs of Thar*, *The Republic of Darokin*, and *The Golden Khan of Ethengar*. The histories of most of these nations have been affected by Alphatia, Thyatis, or both; and these nations constitute many lands which Alphatian and Thyatian characters can explore.

X10: Red Arrow, Black Shield, by Michael S. Dobson, presents a useful overview of the relationships of continental nations 200 years after the time of the Gazetteers.

CM1: Test of the Warlords, by Douglas Niles, showcases the nation of Norwold, a frequent site of struggles between Alphatia and Thyatis.

M1: Into the Maelstrom, by Bruce and Beatrice Heard, springboards from Norwold into an interstellar odyssey exploring the origins of the Alphatians—and what they left behind when they came to the Known World.

M2: Vengeance of Alphaks, by Skip Williams, continues the story of much-abused Norwold and sees Alphatian and Thyatian intervention there.

M5: Talons of Night, by Paul Jaquays, explores a lost valley on the Isle of Dawn, the middle ground contested by the two empires.

All of these adventures are entertaining by themselves and useful adjuncts when used with the Gazetteer series.

Thyatis

Before you continue with this section, you need to read *Book II: Players' Guide to Thyatis*. This will give you a firm grasp on what the Thyatians are all about and how they see themselves.

Once you've done this, return here to learn the truth—behind the history of the Thyatians, the workings of their society, and what player-characters will find when they adventure in this empire.

History of Thyatis

You've read the "History of Thyatis" as it appears in *Book II: Players' Guide to Thyatis*. Here, let's talk a little about the history of Thyatis as the Immortals—and you, the DM—know it to be.

In the Time Before History

The history of the discovery and settlement of the northern continent is much as the Thyatians remember it to be, with one important difference—there were no kings named Thyatis, Kerendas, and Hattias. The tribes had borne those names for centuries or millennia already, having taken their names from far-southern mountains where they used to dwell. Tribal folklore invented the three brother-kings.

The Days of Reaving

It simply isn't true that the Alphatians had a desire to add the Thyatian peoples to their empire. They wanted to subjugate the Thyatians only to obtain some slave labor, to get access to Thyatian mineral wealth, and to stop the Thyatian pirate depredations on their shipping. It's typical Thyatian ego to believe otherwise.

The Coming of the Alphatians

It's true that the conquest of the Alphatians was a little difficult. The Alphatians' non-magical naval forces were no match for the Thyatian pirates. But once the Alphatians decided to pour enough magic on the problem, the Thyatians fell rather quickly.

Contrary to folklore, the Thyatians were mostly beaten in one year, in BC 192. The major cities were all conquered that year. It was BC 190 before every single Thyatian tribe could be said to be under Alphatian sway, and so the Thyatians remember it as a longer and more noble struggle than it was.

The Struggle for Freedom

It's true that Lucinius Trenzantebium (Alphatian-appointed governor of Kerendas) was a mighty wizard (36th level) and a very clever man. And he, with his friend and ally Zendrolion Tatriokanitas (general of the army in Kerendas) were indeed the primary motivators in the Thyatian rebellion.

They knew that Alphatia couldn't be thrown out of Thyatis by sheer brute force, and so, over a period of years, they concocted an elaborate plan for the rebellion and built up their own espionage network.

Their plan counted on a lot of factors: The situation in Alphatia was worse than it ever had been. Zzonga addiction was at an all-time high. True mastery was no longer required to be elected to the Grand Council; if a wizard were of less than 36th level, but had a mighty treasury, the electoral board of the Council was willing to be cooperative. Taxes among the subject states were on the rise: Emperor Kerothar IV wanted the celebration of the Millennium of the Second Alphatian Empire to be the biggest, costliest, most magnificent event in all human history . . . and consequently was begging his nation and its subject states to make this come about.

Early in the 998th year of the Alphatian Empire, Lucinius and Zendrolion arranged for the simultaneous assassination of the most powerful Alphatian wizards in the Protectorate of Thyatis. In view of the public in Kerendas, he informed surviving Alphatian wizards that the Protectorate of Thyatis was now the Kingdom of Thyatis—with him as its King. Then he duelled the most powerful of the remaining wizards to the death.

To be sure, it was no fair duel. Lucinius had made sure that his opponent was zzonga-doped and unable to concentrate on his spells. But the other Alphatians didn't know that; they saw one of the mightiest of their number torn up and eliminated by a Thyatian upstart. Released by Lucinius, they raced back to their Emperor.

Lucinius and Zendrolion sent out as many of their messenger-ships and diplomatic envoys as they could . . . to all of Alphatia's other subject states. They didn't try to persuade them to join with Thyatis; they just sent out skilled diplomats and bards to entertain with news, rumors and songs about the wonderful revolt in Thyatis. Rulers of other states, also being bled dry by the mighty empire, watched these events with keen interest.

The inevitable Alphatian reprisals came. The navies brought the armies. Lucinius retaliated with crack naval forces from Thyatis City, the mighty Kerendan cavalry, elves of the western forest, the ferocious footmen of Hattias, mercenary dwarves from Rockhome, and special units made up of high-level clerics. Naturally, Thyatian units of the Alphatian navy forswore their imperial allegiances and fell on the invading Alphatian navy from the rear. This first reprisal wave was smashed.

Alphatia sent more ships, troops, and—this time—wizards. Lucinius and Zendrolion fought a holding action, maneuvering their forces to baffle the wizards, using Lucinius' knowledge of their ways to pick them off one by one with assassins, keeping the locations of their mobile headquarters and those of their subordinates a mystery to the Alphatian magic-users.

Eventually, as they knew would happen, other Alphatian subject states rose in revolt—counting on the confusion in Thyatis to give them enough time to consolidate their power. Suddenly, the Alphatians found themselves fighting wars at every facing.

In the midst of all this confusion, the bizarre rumor arose that Lucinius had a powerful poison with which he could as-

sassinate any Alphatian noble—but that zsonga juice was a sure antidote. The rumor, of course, was false, created and spread by Lucinius—but so many panicking Alphatian wizards and military leaders kept themselves drugged on zsonga that many of the Alphatians' military plans were hampered and utterly botched.

The combination of factors—the revolt of the subject states, and consequently of many of the best units of Alphatia's army and navy; the economic decline already set in motion by the Alphatian emperor's tax abuses; and the precipitation of Alphatia's mightiest wizards and some of its best military leaders into drugged disinterest—were devastating to Alphatia. Suddenly the empire had few good troops, little money, few leaders, few wizards, and a Grand Council that was not as powerful as everyone thought it was. Alphatia abruptly found itself fighting a losing battle. Kerothar IV was deposed and Alphas VI took the Alphatian imperial throne.

Alphas made hard choices in order to save his empire from further damage. He concluded a peace treaty with King Lucinius and was then able to utilize his military forces to regain control of the rest of his empire. But this decision lost Thyatis to Alphatia, essentially forever.

The Struggle— The Other Story

As the players' history notes, General Zendrolion killed Lucinius and his collaborators, the kings of the Pearl Islands and Ochalea, claiming he'd discovered that Lucinius had been driven mad by his Alphatian magics.

Such, of course, was not the truth. Zendrolion wanted the throne of Thyatis from the first. Once Alphatia was diverted and Lucinius was no longer necessary to Thyatian independence, Zendrolion assassinated him—and the kings visiting him—and claimed rulership of all three nations. Thus did he become Emperor Zendrolion I.

As for whether Thyatian treachery is a result of Immortal indignation or just his-

tory repeating itself—no one knows. It's true that Thyatian politicians are the most treacherous and self-serving of any in the world; but this may just be tradition at work.

The Empire's Early Days —

Empress Valentia really was as clever and far-sighted as she appears in the history. A scholarly PC doing research would discover that she was Lucinius' (unrecognized) half-sister and there are indications that she was also a mage; that's the truth. What is also true is that after her supposed "death," she undertook the Path of the Dynast and eventually achieved Immortality. She is now known as the Immortal Tarastia, Patroness of Justice and Revenge, though it is not known that Tarastia was once Empress Valentia.

The Bright Age

It isn't known to the mortals, but the Hattians were inspired to their revolution—and have, over the millennia, been inspired to their doctrines of separation and hatred—by the Immortal Thanatos. This isn't some grand master plan on Thanatos' part; it's just how he has fun. Over the centuries, he has taken many mortal identities and become many different hatemongers among the Hattians. He does the same sort of thing all over the world . . . just to cause trouble.

Years of Reverses/ The Tenth Century

What was happening in these years was that the rest of the western world was catching up with Thyatis in terms of military and magical sophistication . . . and Thyatis was caught unprepared. The Empire had been coasting complacently along, secure in its superiority, so long that it had forgotten how to compete. Once the subject areas began revolting, Thyatis found itself unable to reclaim those lost territories.

As you can see, its response was to go after even weaker areas—particularly Traladara and unsettled territories to the far

north. But the situation was bad enough that Alphatia was able to invade and, briefly, conquer Thyatis City.

Ironically, it was that invasion that helped turn the empire's invisible decline around. The empire's outrage at the Alphatian assault, spurred on by the energetic leadership of the new emperor Thincol, helped bring the Thyatian Empire back into prominence.

The story of Thincol's "rescue" of Thyatis and his assumption of the imperial throne is more or less true. His motives were hardly noble, but his deeds are indisputable.

DM's Historical Synopsis —

This timeline serves as a historical synopsis for both Thyatis and Alphatia, to save us the difficulty of duplicating the material and to save you from having to flip back and forth between timelines. When you get to the "History of Alphatia" section, you'll be referred here for the timeline.

BC: Before Crowning

AC: After Crowning

AY: Alphatian Year (counted from the Alphatian Landfall on this world)

On the timeline below, the earliest dates—those with the roundest numbers—are only approximations. Exceptions are the Alphatian Landfall and Crowning of the First Thyatian Emperor; these occurred on precisely the years indicated.

BC 5000/AY -4000: On the Known World, the first elf civilization flourishes on the Southern Continent, in areas now under the southern icecap. Far across the galaxy, on another world, a race of pale-skinned humans called the Alphatians begin to rise to preeminence and to study mighty magics.

BC 4000/AY -3000: On the Known World, the human Blackmoor civilization begins a meteoric rise due to its great success with powerful sciences and technologies. On the Alphatians' world, the Alphatians defeat the Cy-

Thyatis

pris civilization . . . and begin to be assimilated by it.

BC 3500/AY -2500: On the Known World, the Blackmoor civilization is at its peak, trading and exchanging culture with the Elves of the South. On the Alphatians' world, the Alphatian/Cypris civilization uses its magical knowledge to begin colonization and conquest of nearby planets and exploration of the elemental planes.

BC 3000/AY -2000: On the Known World, the Blackmoor civilization comes to a violent end as mighty Blackmoor devices explode, shifting the planet's axis. Blackmoor becomes the north pole; the seat of Elvish civilization becomes the south pole; civilization disappears. The rest of the world as it is known today slowly becomes habitable as ice recedes to the new poles. On the Alphatians' world, Alphatian aggression has gradually been supplanted by Cypric self-absorption; otherplanetary conquests and colonies are left to fend for themselves as Alphatian study of magic turns inward.

BC 2000/AY -1000: On the Known World, civilization arises with Bronze Age technology, and Iron Age in some places. One culture begins to form along the River Nithia.

BC 1500/AY -500: On the Known World, the Nithian culture begins its rise in the lands today known as Ylaruam. On the Alphatians' world, the civilization has achieved total mastery of its environment; the great universities are at the peak of their powers and just beginning to indulge in serious scholastic competitions and squabbles.

BC 1100/AY -100: Nithian colonial expansion reaches its eastward limit with the establishment of the colony of Thothia on the Isle of Dawn.

BC 1090/AY -90: On the Alphatians' world, the Followers of Flame begin their serious rivalry with the Followers of Air.

BC 1027/AY -27: On the Alphatians' world, sporadic violence breaks out between the Followers of Flame and Followers of Air.

BC 1010/AY -10: On the Alphatians' world, a temporary peace results from one academian's proposal of the Flame vs. Air essay debate.

BC 1009/AY -9: On the Alphatians' world, Emperor Alphaks I arbitrarily declares the Flames to have won the debate. Outrage, protest, rebellion and revolt result; the Followers of Flame war with the Followers of Air.

BC 1000/AY 0: On the Alphatians' world, the war between the Followers of Air and Followers of Flame reaches its zenith. The Followers of Flame are defeated. Alphaks is banished. Old Alphatia is destroyed; the Followers of Air come to the Known World to settle (**Alphatian Landfall**). On the Known World, the Nithian culture reaches its zenith; it is the first post-Blackmoor empire in the world. Nonhuman tribal movements in the western continent destroy the Golden Age of ancient Traldar (now Karameikos), endanger the dwarven civilization of Rockhome, and limit Nithia's expansion into the southern part of the continent.

BC 600/AY 400: Southern warriors of three tribes (Thyatians, Kerendans, Hattians) migrate from the southern continents to the north.

BC 500/AY 500: The Nithian culture is destroyed by the Immortals and most knowledge of it is erased from the minds and records of mortal man. The Alphatians, who had extended contacts with the Nithians through the colony of Thothia, no longer remember them; the Thothians are left with the vague legend/memory that they were once a mighty people, here on the Isle of Dawn, and that the Immortals abandoned them; most Thothian clerical worship switches from the Immortals to a new brand of mysticism.

BC 192/AY 808: The Alphatians decide to bring Thyatis into the Empire.

BC 190/AY 810: The Alphatians finally finish subduing the Thyatians.

BC 2/AY 998: Governor Lucinius Trentantenbium of Kerendas assassinates Alphatian wizards, declares himself King of Thyatis. The first Great War between Thyatis and Alphatia begins.

AC 0/AY 1000: Thyatian/Alphatian War is at a standstill. Economies of both nations wrecked. King Lucinius and Emperor Alphas VI conclude a peace treaty in the neutral city of Edairo on the Isle of Dawn. Lucinius returns to Thyatis with the kings of Ochalea and the Pearl Islands to conduct treaties with them; his chief general, Zendrolion, assassinates all three and, with the military's support, crowns himself Emperor Zendrolion I Tatriokanitas (**Crowning of the First Thyatian Emperor**); his first activity is the conquest of the Pearl Islands and Ochalea.

AC 12/AY 1012: The Thyatians build a trading station called Cape Alpha in neutral territory on the Great Bay; this violates the Treaty of Edairo.

AC 15/AY 1015: Raiders from the Northern Reaches, paid by Alphatia, destroy the trading station at Cape Alpha; it is not rebuilt.

AC 20/AY 1020: Emperor Zendrolion dies; his wife, Valentia the Justiciar, makes her Citizens' Proclamation.

AC 150/AY 1150: Thyatians begin colonizing into the southeastern region of Ylaruam, enslaving, absorbing, and scattering the native populations.

AC 250/AY 1250: Alphatians begin colonizing into the northern and central coastal plain of Ylaruam, scattering and enslaving the native populations.

AC 313/AY 1313: The Hattians rebel and declare themselves an independent kingdom. Emperor Alexian II defeats them and reestablishes Thyatian preeminence over the northern part of the country.

AC 395/AY 1395: The surviving Followers of the Flame, now calling themselves Flaems, arrive from their long journeys and settle in the land that will one day be called Glantri.

AC 400/AY 1400: Ostland at the peak of aggressive raiding into Thyatian and Alphatian waters. Flaemish explorers investigating their new world realize that the Followers of the Air have built themselves a mighty empire in the East.

AC 500/AY 1500: Thyatian and Alphatian colonies in Alasiyan coastal areas

begin to clash; these colonial wars will go on for three centuries.

AC 571/AY 1571: Thyatis establishes prisons on five Ierendi islands settled by halflings.

AC 586/AY 1586: Thyatis, at war with Alphatia and needing ships and ship-building harbors urgently, seizes Ierendi islands from the halflings—and all the ships in the harbor at the time. Halflings begin retaliatory piracy against Thyatian shipping; this continues to the present.

AC 600/AY 1600: Prison revolt in Ierendi islands drives out Thyatian presence.

AC 614/AY 1614: Vestland pursues trade with Thyatis and Alphatia.

AC 644/AY 1644: Thyatian reprisal invasions of Ierendi are driven off.

AC 700/AY 1700: Frictions between Alphatian and Thyatian colonies in Alasiya become more pronounced; raiding and skirmish warfare become common.

AC 713/AY 1713: Thyatian privateer probe into Ierendi waters destroyed; Thyatian interest in Ierendi as a colony wanes.

AC 728/AY 1728: Alphatian colonies in Alasiya get the upper hand and destroy several Thyatian colonies entirely. Rumors of good lands in the western Flaemish lands lure the disgruntled Thyatian survivors, many of whom decide to pioneer there.

AC 730/AY 1730: Thyatian settlers reach Flaemish lands and frictions quickly develop with the Flaemish. In Alphatia, the philosophies of the wizardess Mylertendal begin catching the popular imagination.

AC 784/AY 1784: A Thyatian settler kills a Flaemish lord.

AC 785/AY 1785: In Glantri, Thyatian settlers and elvish allies are beaten by the Flaemish at the Battle of Braejr.

AC 786/AY 1786: An Alphatian lord named Halzunthram arrives in Flaemish lands, sides with the Thyatian/Elvish coalition, and defeats the Flaems, effectively assuming control of the area.

AC 788/AY 1788: Halzunthram takes control of region's ruling council and

declares the area a protectorate of Alphatia. The elves claim independence; the Flaems and Thyatians unite against Halzunthram.

AC 827/AY 1827: Forces of Suleiman Al-Kalim drive the Alphatians out of Alasiya.

AC 828/AY 1828: Lord Alexander Glantri, of Thyatian descent, captures Halzunthram, confirms the region's independence, and disperses Alphatian presence there. Braejr is renamed Glantri City in his honor.

AC 830/AY 1830: The last Thyatian colony of Alasiya, Tameronikas, is conquered by the forces of Suleiman Al-Kalim; the Thyatians, as a power, are driven out of Alasiya.

AC 900/AY 1900: Thyatis's new emperor, Gabrionus IV, begins a new expansionist policy. Thyatians conquer Traladara's chief city, Marilenev, renaming the city Specularum, and claiming all Traladara as a Thyatian protectorate. The Thyatians conquer and settle more of the Isle of Dawn, put pressure on the Northern Reaches, and build and settle the city of Oceansend in Norwold.

AC 938/AY 1938: A peasant boy, Thrainkell Torson, is born to a Thyatian mother and a Vestland father in Oceansend.

AC 950/AY 1950: Ostland, faced with a united front of belligerent Northern Reaches nations, makes formal alliance with Thyatis.

AC 956/AY 1956: Peasant warrior Thrainkell Torson becomes a gladiator in Thyatis City; is called Thincol Torion (the best Thyatian-language equivalent of his name) and later Thincol the Brave.

AC 959/AY 1959: The Alphatian Emperor, angered by another Thyatian broken treaty, commits his military to a sudden assault on Thyatis. Thyatian positions on the Isle of Dawn are overrun; the Alphatian forces spend the winter on the Isle of Dawn preparing to assault the Thyatian homeland.

AC 960/AY 1960: The Alphatian Spike assault reaches the Thyatian mainland; Alphatian forces enter Thyatis

City and kill Emperor Gabrionus V. Gladiator Thincol the Brave, with gladiatorial and military forces, rescue Gabrionus' daughter Gabriela and drive the Alphatians out. Thincol marries Gabriela and assassinates generals until the military is of his mind, and has himself crowned Thincol I Torion. Oceansend, in Norwold, takes this opportunity to throw off Thyatian control and declare itself independent. It takes Thyatis two full years to reclaim lost territories on the Isle of Dawn. All known knights of the Order of the White Drake are captured and executed. Any survivors from the underground are later taken into the Retebius Air Fleet and the Knights of the Air, and are fervently anti-Thyatian.

AC 962/AY 1962: Princess Eriadna of Alphatia politely suggests that her father, Emperor Tylion IV, retire from the crown. He does so, and she is crowned Empress Eriadna the Wise of Alphatia.

AC 970/AY 1970: Duke Stefan Karameikos III of Duchy Machetos in Thyatis assumes control of Traladara, making it independent of Thyatis, renaming it Karameikos.

AC 985/AY 1985: Empress Eriadna decides to colonize in the west, and has a new fortress city built atop the ruins of the station at Cape Alpha destroyed nine and a half centuries before.

AC 992/AY 1992: Empress Eriadna of Alphatia accedes to her son Ericall's demands for a kingdom of his own. She gives him the city of Alpha in Norwold, the empty title of king of that nation, and a great degree of autonomy.

AC 995/AY 1995: King Ericall of Norwold grants the governorship of Landfall to his half-brother Lernal the Swill.

AC 1000/AY 2000: Today. All D&D® Known World Gazetteers are set in this period.

Atlas of Thyatis

In this description of the Thyatian Empire, we'll give you abbreviated descriptions of many of the interesting sites of the Empire. Feel free to flesh out these places and also the sites not presented in detail, and encourage players whose characters come from those areas to detail them still further.

On the fold-up sheet is the map of mainland Thyatis; refer to it when reading this section.

Barony of Biazzan

Population: 30,000 (including communities).

Description: This is a low, rich valley surrounded by steep hills; due north are the Altan Tepes mountains. A lot of trade passes through Biazzan, from Ylaruam to Thyatis and back again, but for the most part this is a sheltered, quiet region.

Customs: Many of Alasiyan descent live here, so many NPCs will bear Alasiyan names, clothes and manners.

Historical Notes: The area was settled by Alasiyans centuries ago, was later captured by Thyatis (the region's name, Biazzan, is corrupted from the name of the region's first Alasiyan settler, Selim ben Hassan).

Sites: See separate listings for *Biazzan* and *Fort Nicos*, below.

Personalities: *Baron Babrak Biazzan* (F14, L). The baron is a 14th-level fighter with a Thyatian upbringing and a love of Alasiyan trappings and furnishings. He has a *scimitar* (normal sword) +2 and a *flying carpet*.

Biazzan

Population: 12,500. This is 90% human, 5% elf, 3% dwarves, 2% halflings.

Description: This is a small, quiet city which has come to be dominated by its large market and the famous University of Biazzan, a center for learning in mainland Thyatis. Half the city's population consists of students, one-fifth of university instructors and employees, and the remainder work in mercantile trade or for the city. The city is unwallled; it depends on the protection of Fort Nicos to the north.

Regulations: No armor, and no weapons larger than daggers, may be worn within the city (except by on-duty military personnel and city guards). City guards are very diligent about arresting public nuisances.

Sites: The *Grand Market* is a large open concourse in the center of the city; trade caravans usually stop here for a day to rest their beasts and do a little trading before continuing south to Kerendas or north to the Emirates. The *University of Biazzan* takes up several city blocks on the south end of town, and is made up of numerous large, low buildings containing large libraries and lecture halls.

Fort Nicos

Population: 300 (all military).

Description: Situated on a mountain-side overlooking the crucial pass into the Altan Tepes, this fort protects Thyatis from Ylari intrusion. Though the fort is within the Barony of Biazzan, the fort commander does not answer to the baron—only to the army of Thyatis. The fort controls several rockfall traps designed by Rockhome dwarves; the full range of traps, if sprung, would release enough rock to block the pass for a minimum of several weeks (the time required for the Fort Nicos garrison to clear it). One such trap, when released, would crush several dozen enemy soldiers and take at least three days of work to clear.

Barony of Buhrohur

Population: 15,000 (including towns). This is nearly 100% dwarves.

Description: This is rocky, mountainous territory settled mostly by dwarf colonists from Rockhome.

Regulations: Non-dwarves, except for imperial representatives and non-dwarf inhabitants of the barony (mostly miners), must be accompanied by Buhrohur dwarves when traveling through this territory.

Customs: The dwarves are much like the dwarves of Rockhome: Inventive, loving gold and fighting, taciturn around non-dwarves.

Historical Notes: This land was ceded to the dwarves who helped King Lucinius win Thyatian independence and who later built Emperor Zendrolion's mighty palace, which still stands in Thyatis City.

Sites: The town of *Makrast*.

Makrast (Broken Mountain)

Population: 3,000.

Description: Makrast is the name of a huge mountain with a sheared-off western face—it looks like it must have been hit by the most gigantic of all lightning bolts in some primordial time. At the mountain's foot lies the town of Makrast, built by dwarf settlers long ago. About 20% of the town is above-ground; the rest is underground, in natural caverns and in tunnels hewn out by the dwarves over the last thousand years.

Regulations: Non-dwarves, except imperial representatives, must be accompanied by Makrast dwarves. Except for imperial representatives and invitees of the Baroness, no non-dwarf may stay within the city between nightfall and dawn.

Personalities: *Baroness Gilla Blyskarats* (Clan Farkres, ruling clan of Buhrohur) (D-C12, L, of Kagyar). The baroness, new-come to her rule and still unmarried, was well-trained for her role by her father, the old baron. She intends to keep the gold-mining moving, the city safe, the baronial borders secure, and perhaps to do a little adventuring under an assumed name . . . when time allows. Appearance: 4', 140 lbs; long red hair, brown eyes; dresses in informal clothes in russet-browns and rust-reds; age 50 (dwarven young adulthood).

County of Actius

Population: 10,000 (including town of Actius).

Description: This is a small and agriculturally unproductive island due east of the southern end of the Island of Hattias. It consists of the unusually well-provisioned and -maintained seaport town of Actius, where most of the island population lives, and surrounding farms and fishing villages.

Historical Notes: Long ago, Sir Actius, a warrior-knight of Emperor Alexian II, won this island as his dominion for services to his emperor. It was a cheap and poor island, but Actius was a clever man. He invested all his adventuring treasures into building a large seaport town here, and filling its warehouse with provisions. Actius became a major provisioning stop for merchant vessels. However, eventually (over a period of a couple of centuries) that trade dried up; Minrothad, Ierendi and Thyatian traders began using the route through Vanya's Girdle more and more, and these southern seas received only occasional trading vessels. The Actians, blessed by a broad, deep bay surrounded by wide beaches, turned to shipbuilding and even today are a chief supplier of vessels to the Thyatian Navy.

Actius

Population: 8,000 (90% human, 10% sea-elf).

Description: This large town, as described above, is a major shipbuilding concern. It is also still a provisioning center for the little sea-trade that comes around the Cape of Hattias.

Customs: Gambling, especially dicing, is the chief recreational craze on this island, and there are many gambling-halls and gambling-taverns where one can participate.

Personalities: *Count Geraldan Actavius* (F20, N) is ruler here. He's an aging warrior who was a fighter in the Thyatian Navy for over 20 years, and resigned his commission a decade ago to rule Actius when his father was lost at sea. Appearance: 5'10", 200 lbs (should be 160); greying black hair and beard, brown eyes; broad, merry face with scars on both cheeks from an early duel; dresses in simple clothes but wears much heavy, rich jewelry; age 50.

County of Halathius

Population: 20,000 (including Goldleaf).

Description: This county comprises the easternmost region of hills in mainland

Thyatis. This is rolling, rocky territory famed only for the productivity of its gold mines. Other minerals and metals are mined here in abundance, as well, and parts of Halathius supply mainland Thyatis with the majority of its iron ore. There are many mining villages clustered in these hills, and many bands of brigands waiting to take the mined gold away from caravans transporting it.

Regulations: Theft of gold in amounts as little as 10 gp is punishable by death in this county.

Customs: Many youthful citizens of Halathius take up hill-climbing and cliff-climbing for recreation.

Goldleaf

Population: 4,000.

Description: This is the chief town of Halathius, seat of its government, center of its gold-crafts trade. Many hundreds of citizens living here are goldsmiths, weaponsmiths, armorers, and—of course—traders and merchants in these goods.

Regulations: City gates close at dusk and don't reopen until dawn. "Brigand-Hunting Licenses" can be had very cheaply in Goldleaf; they permit adventurers to attack and capture or slay persons in Halathius who are living in permanent or semi-permanent, illegal camps and villages—such persons are automatically presumed to be brigands or unlicensed miners and are fair game.

Customs: Goldleaf, unlike most human communities in Thyatis, has no coliseum and most of its citizens are not entertained by arena duelling.

County of Hattias

Population: 350,000 (including the city of Hattias).

Description: The largest dominion—in terms of size—in Thyatis is the County of Hattias, which comprises the entire Island of Hattias. However, the Island is mostly barely-habitable hill country; there are only a few productive low-lying areas, and there are hundreds and hundreds of miles of indefensible coastline, so Hattias, as a dominion, is hardly a prize. On the north

end, you find green rolling hills and many, many vineyards, plus a lot of sheep-pasturage. In the hills, the population centers mostly around goat-herding, production of leather goods and goat cheese. The south end consists mostly of fishing villages and a few pirate dens which try to prey on Minrothad shipping from the island of Alfeisle.

Regulations: There are no formal regulations different from mainland Thyatis, but there are a lot of "unwritten laws" here. Members of the Storm Soldiers can demand shelter, food and services of any commoners living on the island. Demi-humans are not tolerated here. Non-Thyatian humans tend to be harassed by the Hattians, who don't care for their skin colors or foreign ways. In short, it's not a nice place to visit if you're not of Thyatian stock.

Historical Notes: You know from the "History of Thyatis" in *Book II* about the Hattian rebellion of several hundred years ago; this still rankles in the minds of many Hattian citizens.

Hattias

Population: 30,000.

Description: This is a sprawling city in the center of the northern end of the island. Despite its size and lack of natural fortifications, it has no city walls—they were cast down in the Hattian uprising of several centuries ago, and may not, by Imperial law, be raised again.

Personalities: The most powerful man in Hattias is *Count Heinrich Oesterhaus* (Special—see below), ruler of the dominion . . . and official leader of the Storm Soldiers hate society. But the real Heinrich Oesterhaus is long-dead, slain while adventuring by the Immortal Thanatos. Thanatos took his guise and identity, and rules Hattias in his place, raising Oesterhaus' son in his philosophy of hatred and spurring the Storm Soldiers on to greater and greater atrocities . . . because he likes to. Appearance: 6'3", 165 lbs. (slender); Hattian ancestry (apparently); black hair and saturnine beard; cold, mocking features; dresses in reds and golds; apparent age 45.

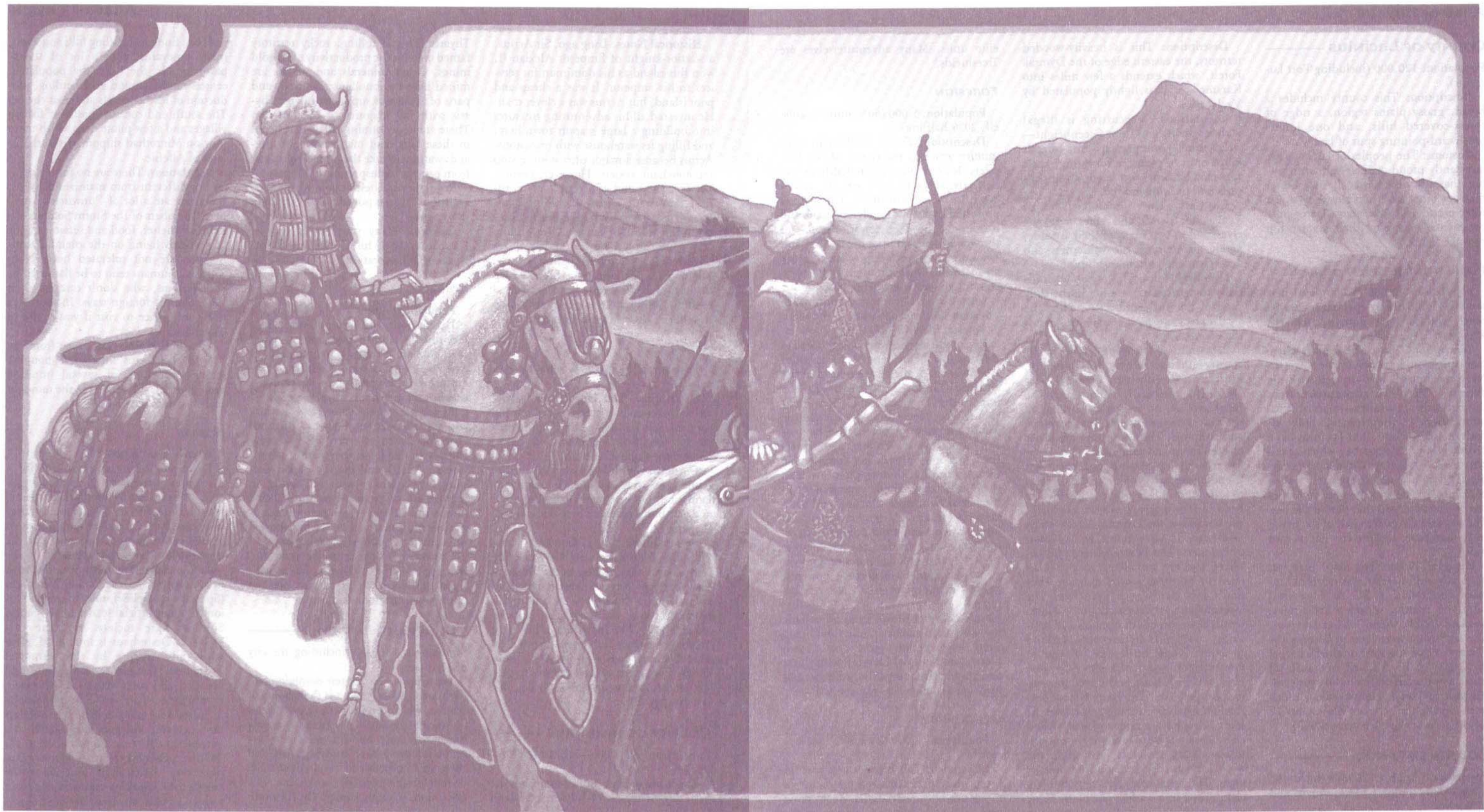

Atlas of Thyatis

County of Lucinius

Population: 120,000 (including Port Lucinius).

Description: This county includes a broad, grassy plains region, a ridge of forest-covered hills, and one lonely southward-pointing spur of land.

Customs: The peoples of Lucinius are incessantly proud of their seamanship—not that it's necessarily all that better than any other large port city, they're just more proud of it than many. Derogatory comments concerning their seamanship provoke fights.

Port Lucinius, Shield of the East

Population: 40,000 (5,000 naval personnel, 15,000 naval dependants, 20,000 other civilians; 85% human, 10% elf, 4% dwarf, 1% halfling).

Description: This is the seaport where new officers and seamen of the Thyatian Navy are trained. It is charged with the defense of Thyatis City from attacks from the east, a charge it failed—to its citizens' humiliation—in the Alphatian Spike assault of 40 years ago. Port Lucinius has a broad, glassy sheltered bay which opens out into the widening part of Vanya's Girdle. The naval base, a separately walled enclosure, lies next to the western half of the bay, and controls that part of the bay. The city uses the eastern half of the bay as its civilian port, and the city has its own wall.

Historical Notes: The naval base was originally built here on the orders of Emperor Zendrolion in AC 10. Hypocritically, he named it after his "poor, doomed, noble friend," King Lucinius. The lands that were later to become the County of Lucinius were originally part of the Duchy of Thyatis, and were split off into a new dominion (including the civilian part of Port Lucinius) much, much later, during the reign of Gabrionus IV (at the turn of the 10th century AC).

County of Vyalia

Population: Approx. 20,000 (including towns). This is about 75% humans and 25% elves.

Description: This is heavily-wooded territory, the eastern edge of the Dymrak Forest, which extends a few miles into Karameikos. It is lightly populated by Vyalia elves.

Regulations: Treecutting is illegal without permission from Greenheight—which usually isn't granted. Any animals killed must be prepared for eating; while furs may be kept, this is not a trapper's preferred hunting ground.

Customs: The human citizens of Vyalia are friends and allies with the elves, and so bear many of their attitudes about maintaining the wilderness and not "civilizing" virgin territory.

Historical Notes: This region was officially recognized as a county in the early years of the 3rd century AC, when the Vyalia elves agreed to teach and sponsor the Foresters.

Personalities: The clans of elves in the county include Blueleaf, Diamarak, Etheredyl, Greenheight, Hierydyl, and Treeshield, plus many minor clans. The **Blueleaves** are an artistic clan, many of their elves becoming jewellers, painters, and sculptors. The **Diamaraks** are lovers of deep forest and wilderness. They act as forest-wardens, slaying poachers, befriending animals, and using their magics to grow new foliage where it has died or been cut down and to extend, gradually, the borders of the Dymrak Forest. Many **Diamaraks** are adventurers, and sponsors of Foresters. The **Etheredyls** are philosophers, and are considered by the other clans to be dreamy-eyed mystics. They don't mix much with non-elves. The **Greenheights** are very outgoing and boisterous elves, friends of humans and halflings, not too disagreeable around dwarves. They built the village of Greenheight, and it was they who were first contacted about, and agreed to sponsor, the Foresters. The **Hierydyls** concentrate on scholarly concerns, especially the lore of all the elven races and analysis and classification of beasts and magic. For this reason, many travel far abroad in the world, and are counted as adventurers or sages. The **Treeshields** are a very military clan, raised in a warlike tradition. Many are members of Thyatis' army, usually in

elite units. Many adventurer-elves are Treeshields.

Foreston

Population: 5,000 (60% human, 20% elf, 20% halfling).

Description: This is the human community which is the center of the Foresters. It's one place where halflings feel perfectly at home and are not talked down to by the Thyatians. The town is protected by a stout wooden palisade and surrounded by deep forest. Because of the woodsmen's abilities of the elves and Foresters, it's next to impossible to sneak an attacking force through to Foreston without an early alert being raised.

Customs: The treachery so common to Thyatian culture is not a part of the elvish or Forester life-style.

Personalities: *Dame Larandia Ly-mianoporus* (Forester-10, L) is chief townswoman of the city and head of the Foresters' Guild. Thirty years ago, she joined the Foresters and then spent twenty years adventuring throughout the world and earning herself the rank of Knight of Thyatis. Ten years ago, she retired to Foreston with her considerable fortune, and has risen to prominence in the Guild since then. She is a good teacher of fighting and magic, and has a keen eye for weeding treacherous and disloyal students out from Foresters' training. Consequently, she has a few enemies from the ranks of failed Forester trainees, some of whom have become powerful fighters in the years since they were expelled. Appearance: 5'7", 130 lbs; blonde hair and brown eyes; aristocratic features; wears surcoats, tunics and hosen dyed with green, gold and brown blotches to help her blend in with forest foliage, plus chainmail, brown boots and belt; apparent age 30 (real age 50).

Greenheight

Population: 1,000 (80% elf, 20% human).

Description: This is the largest town of Vyalia elves in Thyatis, and the center for the elf side of Forester studies. At any given time, 160 or so humans—trainees to the



class of Forester, but currently 0-level—are living here, being taught by and becoming known by the elf families willing to adopt them as honorary Vyalia elves. This is also a trading-post for humans wishing to trade with the elves for their crafts and furs, and for scholars who wish to study the ways and history of the elves.

Customs: When a Forester trainee is ready to become a Forester formally (i.e., the clan sponsoring him is convinced that he is worthy, honorable, and of Lawful alignment), the Forester is taken to the Tree of Life of the sponsoring clan (this tree is hidden deep in the forest, far off the recognizable forest trails). There, in a special ceremony, he is formally adopted by the clan and visited by a ghostly presence, called an Arm of Ilsundal, which fills him with energies which allow him to learn magic as the Elves do. Ilsundal will not so visit a character who is not Lawful or who has bad intentions toward the elves or Foresters; and can take those energies back—and the Forester's magic powers with them—if the Forester ever betrays his clan.

Personalities: *Count Yldysyl Greenheight* (E10, L) is the ruler of the County and of Greenheight. He is the son of Yntherin Greenheight, who first agreed to sponsor the Foresters some eight hundred years ago. He is fond of human cultures and a scholar of Thyatian human ceremonies and entertainments, and, though a responsible ruler, is very fond of drink and merriment. **Appearance:** 5'7", 130 lbs; pale skin, black hair and eyes; wears green tunics, hosen, cap, cloak, belt, and boots with black piping and symbols embroidered thereon; age 500 years (mature elf).

Duchy of Kantrium

Population: 100,000 (including towns).

Description: Kantrium borders the County of Halathius to the west and the Duchy of Tel Akbir to the east. It's one of the smallest duchies of Thyatis in terms of population, but is also one of the oldest, and was the border to Ylaruam in the centuries before Tel Akbir was wrested away from the Alasiyans. Kantrium is a

thinly-occupied dominion (by mainland Thyatian standards) consisting of a green and fertile strip of farmland around the Gulf of Kantrium, graduating to more arid countryside in the north, toward the hills and Ylaruam. The coastal strip holds 90% of the duchy population; it is a good area for fishing and raising grain crops.

Historical Notes: A General Kantrius threw his lot in with Emperor Zendrolion I immediately after the latter's assassination of King Lucinius. Kantrius was awarded this area and the generalship of the troops guarding the border between Thyatis and Ylaruam. Centuries later, after Tel Akbir and its peninsula were annexed, the troops were moved there and Kantrium's prominence declined.

Kantridae

Population: 10,000.

Description: This largish town is the capital of Kantrium. It was once a city of 30,000 and site of the military garrison guarding Thyatis from Ylari intrusion; the city name, in fact, means "sons of

Atlas of Thyatis

Kantrius" in an ancient Thyatian dialect, because that's how old General Kantrius was said to look upon his men. Today, it is a declining town of fishermen and gentlemen farmers.

Duchy of Kerendas

Population: 600,000 (including towns and cities).

Description: One of the most prominent dominions is Kerendas, center for cavalry training and the source of the best horses in mainland Thyatis.

Regulations: Horse-theft is a capital offense in this duchy.

Customs: The Kerendans are horse-crazy, and so horse-races, jousts, ducal fairs and stock shows, and such events are wildly popular here. Every healthy Kerendan, regardless of race or class, tries to become a good horseman, and so every Kerendan character should have the Riding general skill—or a very good reason why not. Another custom: The current duke always takes the name of the duchy as his family name, and his immediate family usually follows suit.

Historical Notes: The Tribe of Kerendas was one of the three related tribes that migrated to this land and formed the Thyatian nation.

Sites and Personalities: *Duke Maldinius Kerendas* (F30, C). Maldinius rules from Castle Kerendas, which is just a couple of miles from the walls of the city of Kerendas—and so is not separately noted on the map. Maldinius has the reputation of being a great adventurer and warrior, which he is—if victory is the only thing that qualifies you for those roles. His elder brothers all died mysterious deaths, until Maldinius was the sole ducal heir. On his adventures, many of his companions have died heroically—usually in sinking ships or burning buildings, shortly after the enemy was beaten and the treasure recovered. He's a backstabber, gossiper, and villain with a voice and manner as smooth and silk—and, surprisingly, he's no coward (it's next to impossible to become a 30th-level fighter when you're a coward). Appearance: 6'2", 190 lbs; blond hair and beard, blue eyes; handsome features;

dresses in rich reds, oranges, and yellows; his armor is polished to shine; age 35 (real and apparent).

Kerendas

Population: 100,000 (95% human, 4% elf, 1% dwarf and halfling).

Description: Kerendas is the second-largest city in mainland Thyatis. It boasts a good seaport and West Reach, the famous school for officers of the Thyatian Cavalry. The city is surrounded by broad expanses of flat grassland, and by local law no crops may be grown and no land may be privately owned within two miles of the city walls—this ensures the cavalry and horsemen plenty of room for training and recreational riding.

Personalities: *Commandant Thyarius Palykratidius* (C36, N, of Vanya) is the head of the officers' training school. A native Kerendan, he is still more Hattian than the Hattians themselves—being stern, short-spoken, intolerant of mistakes, enraged by back-talk. He runs West Reach with an iron glove and, though a cleric of Vanya, is similarly devoted to Efficiency with all its benefits and ills. His piercing eyes rake over new officers' recruits—and everyone else, for that matter—with all the sympathy and innate humanity of a dragon's. For all that, he is loyal to Thyatis, well-beloved of his men (nothing succeeds like success), and the preserver of grand traditions in Kerendas. Appearance: 6'4", 160 lbs (lean); dark brown hair and thin mustache (no beard), brown eyes; always wears the white dress uniform of the Kerendan Cavalry, regardless of his surroundings or circumstances; age 50.

Duchy of Machetos

Population: Approx. 30,000 (including towns).

Description: Machetos is a pretty but poor western duchy on the border with Karameikos. It has a thriving income from grain, lumber, and trade routes to Karameikos, but only recently has this begun recovering from the losses of 30 years ago (see below).

Regulations: Poaching of deer is punishable by death. Unlicensed tree-cutting (other than on one's own dwelling) is punishable as a Lesser Charge (each tree constitutes its own charge).

Customs: There are a lot of Foresters in this area, who often take the law in their own hands when they see people wantonly killing wildlife or ruining the beauty of the wilderness. Some kill the offenders; some merely destroy their base camps and erase their trail-blazons so they become lost in the deep woods.

Historical Notes: Until 30 years ago, this was a very wealthy duchy belonging to the Karameikos family. But then-ruler Duke Stefan Karameikos III fell in love with the comparatively unspoiled beauties of Traladara, to the immediate west. He traded his lands, minus his treasury, to the Crown for clear title to Traladara (now called Karameikos). Thincol I stripped Machetos of its wealth and livestock, sold its slaves in the market, sold its year's crops for a quick below-cost price, and effectively ruined the duchy's economy and depopulated it. It was then given as dominion to the new Duke, Callastian Jowdynites.

Sites: The town of *Machetos* (population 2,500) is a picturesque small town, seat of the Duchy. Nearby is *Castle Jowdynites*, formerly *Castle Karameikos*, which (though stripped of all its former treasures and decorations) is still an example of powerful fortress-building and menacing architecture. To the far west is the fort of *Blackpoint Citadel* (population 1,000 soldiers, 250 civilians), which sits opposite from Karameikos' Rugalov Keep.

Personalities: Ruler of the duchy is *Duke Callastian Jowdynites* (F12, L). He thought he was being rewarded for his brilliant military services when Thincol granted him this dominion 30 years ago. Now nearing 70, he has built Machetos up again into a self-sufficient dominion. He's a tired, angry man without heirs, who doesn't care for visitors, dislikes the Emperor, and is interested only in his subjects going about their business and leaving him alone.

Duchy of Mositius

Population: 15,000 (including town).

Description: Mositius is a long, narrow island due east of the Island of Hattias, between Carytion and Actius. Dotted the island from tip to tip are hostels, inns, and taverns of varying quality, many quite good.

Regulations: No weapons larger than daggers may be carried on the island except by Mositius Island Guards. No armor may be worn except by the Guard.

Historical Notes: Mositius was little more than a grassy lump of stone poking out of the water—with an ominous-looking volcano poking out of it—until about thirty years ago. Until that time, it was an island with a bad reputation; the volcano, it was said, was active and strange, evil mists floated down out of it and prompted ordinary men and women to slay one another.

But a famous adventuress named Triella Tien-Tang (an Alphatian/Ochalean cross from the Isle of Dawn) investigated Mount Mositius and discovered the truth: The volcano was long-dead, and the “strange mists” were emitted by a bizarre and forgotten artifact hidden here by some long-vanished wizard.

The artifact, known as the *censer of the mists*, is an indestructible golden globe 6" in diameter—a globe with intricate geometric patterns of holes all over its surface. At various times, never more than once a week nor less than once a year, the *censer* emits a huge cloud of colorful mist which acts similarly to a *potion of human control* with two important exceptions.

First, it controls a *lot* more people than such a *potion*. The mist, when it floats out from the volcano's mouth, will blanket up to six square miles of island territory (though it won't float out beyond the island). Characters get an ordinary saving throw vs. spells to resist the mist's effects. The mist lasts 36 turns (six hours).

Second, it doesn't permit anyone to control or persuade the persons affected. Instead, it inspires them with a single, specific emotion, randomly chosen by the

DM. The mists tend toward non-violent or positive emotions (blind optimism, love, drunken giddiness, laziness, giggling hilarity); it only occasionally (once a year or so) results in negative emotions (paranoia, irritability, phobias); once a century, the mist is one of raw hatred.

When the mists hit the island's dwellers, the whole island seems to go mad with the emotion brought on by the mist.

Triella built herself a hideaway in the volcano's mouth, and enclosed the artifact in a giant glass bubble built with release valves. Some of the valves open up into airtight cages; others allow the mist to flow up and out of the volcano mouth.

She then visited young Emperor Thincol and persuaded him that she could make a good business of Mositius, were it given her as her dominion . . . and explained her ideas concerning the island's future. Her ideas were sound, and she met all the criteria for rule of a dominion in Thyatis, so he provisionally granted her the title of Baroness. Later, as her tax revenues—promptly-paid and never inaccurate—enriched the imperial coffers and the island's reputation spread, Mositius was upgraded first to County status, and more recently to Duchy status.

Triella's idea was to reshape Mositius into a resort community for the young—a place for idle, wealthy youths to come to spend their too-great fortunes, for young folk to come to celebrate achievement of Freedom Day, for young men to send their bachelor friends for one last fling before wedding bells sound.

By gearing the island's entertainments toward the young, establishing some very peculiar laws (such as the one requiring businesses to stay open every hour of the day and night), by using her contacts and friends to spread the word about her island, by making it a status symbol to have visited Mositius (and an even greater one to go back regularly!), Triella made her island into one of the most thriving concerns in Thyatis.

And her control of the mists didn't hurt. When the *censer* begins emitting mists, Triella puts some of her volcano household slaves into the airtight cages and releases the mists into them. If the ef-

fects on the slaves are not ill ones, she releases the mists to flow over the island. These events are eagerly hoped-for by visitors to the island, who like to use the mists' effects as excuses to run amok on Mositius.

Sites:

Mount Mositius is the home of Duchess Triella. In the cavernous cone is her great palace, from which the Mists of Mositius are vented. Visitors are not welcome, except by invitation, and the volcano crawls with the sort of monstrous defenders used as guards by every high-level mage who desires privacy.

Argevin Town, built at the foot of the mountain, is the central community of the island. It features scores of great and small taverns, theatres, dancing-halls, gambling establishments, and other entertainment businesses.

Personalities: *Duchess Triella Tien-Tang* (M36, N). The Duchess spent a hard life in West Portage on the Isle of Dawn, and came to the study of magic comparatively late in life (at age 28) when a traveling Thyatian wizard discovered that she had the knack for it. Over the years, she became an accomplished mage and courageous adventurer, weathering many dangerous expeditions and aiding the gladiator Thincol to regain the Thyatian imperial palace when it was stormed by the Alphatians in the Alphatian Spike attack. She “retired” shortly thereafter, intending to devote the rest of her time living peaceably on the island of Sclaras, spending her sizeable treasure and traveling occasionally; and it was on one of those travels that she discovered the secret of Mositius. She worked and fought very hard to achieve her current position, and would fight with savagery and great, cunning intelligence anyone who tried to take it from her; but she has sympathy for other self-made adventurers and well remembers her poverty-stricken upbringing in West Portage. Appearance: 5'9", 135 lbs; common Alphatian coloration; red hair, green eyes; prefers ornate green gowns of Alphatian spider-silk; apparent age 20 (real age 70).

Atlas of Thyatis

Duchy of Retebius

Population: 200,000 (including cities and towns).

Description: Retebius, a land of fine pastureage, built its economy on beef and (to a lesser extent than Kerendas) horseflesh. It's a land of broad, well-watered grasslands stretching from the sea to the northern hills; and, though the duchy is smaller than most of Thyatis' dominions, it is also more important to the security of the Empire than the rest of them. Retebius is the home of the two great orders of Thyatian airborne knights: the Retebius Air Fleet, a branch of the Thyatian military, and the Knights of the Air, an independent "guild" of flying-beast enthusiasts and adventurers. Both were described in more detail in the "Knights of Thyatis" chapter of *Book II*.

Historical Notes: One of King Lucinius' and General Zendrolion's allies in the first Thyatian/Alphatian war was named Retebius; he was an Alphatian cleric from the Isle of Dawn. In his mis-spent youth, he'd captured a young

white dragon and trained it to carry him aloft and fight for him. In the early days of the war, Retebius was a surprise weapon against the Alphatian air-boats, bringing many to ruin before the dragon was killed. Retebius survived, though, and after the war offered to create an entire flying army for Emperor Zendrolion—if he could have imperial funding. Zendrolion, having become painfully aware of the importance of air superiority during the war, agreed readily, and the Retebius Aerial Corps was created. Gradually, as it expanded, it became the Retebius Air Fleet, a military force of importance at least equal to the army, navy, and cavalry; and inevitably, private citizens interested in training and flying their own private beasts gravitated to Retebius. Thus was the Knights of the Air organization born.

Retebius

Population: 15,000.

Description: This is a broad, sprawling city, much larger than it has to be to

house its populace. Over half the city—a half personally owned by the ducal family—is devoted to the great landing-fields and beast-quarters of the Retebius Air Fleet and Knights of the Air. This is the northwest half of the city; the southeast, fronting the river and the Gulf of Kantrium, is an ordinary city of ordinary citizens.

Regulations: Flying monsters of the types which man can train are protected by law—to injure one, except in self-defense, is a capital offense.

Personalities: The current rulers here are Duke Callastian Retebius and Duchess Mitasula Retebius.

Duke Callastian Retebius (T20 (Rake), L) is an experienced adventurer who just recently came to the ducal throne, on the retirement (abdication) of his mother. He posed as a common-born acrobat and made his living as an entertainer for many years of traveling and adventuring, meeting his future wife Mitasula on his journeys—it startled her greatly when he admitted that he had to go home and be the duke. Callastian is a humorous man,

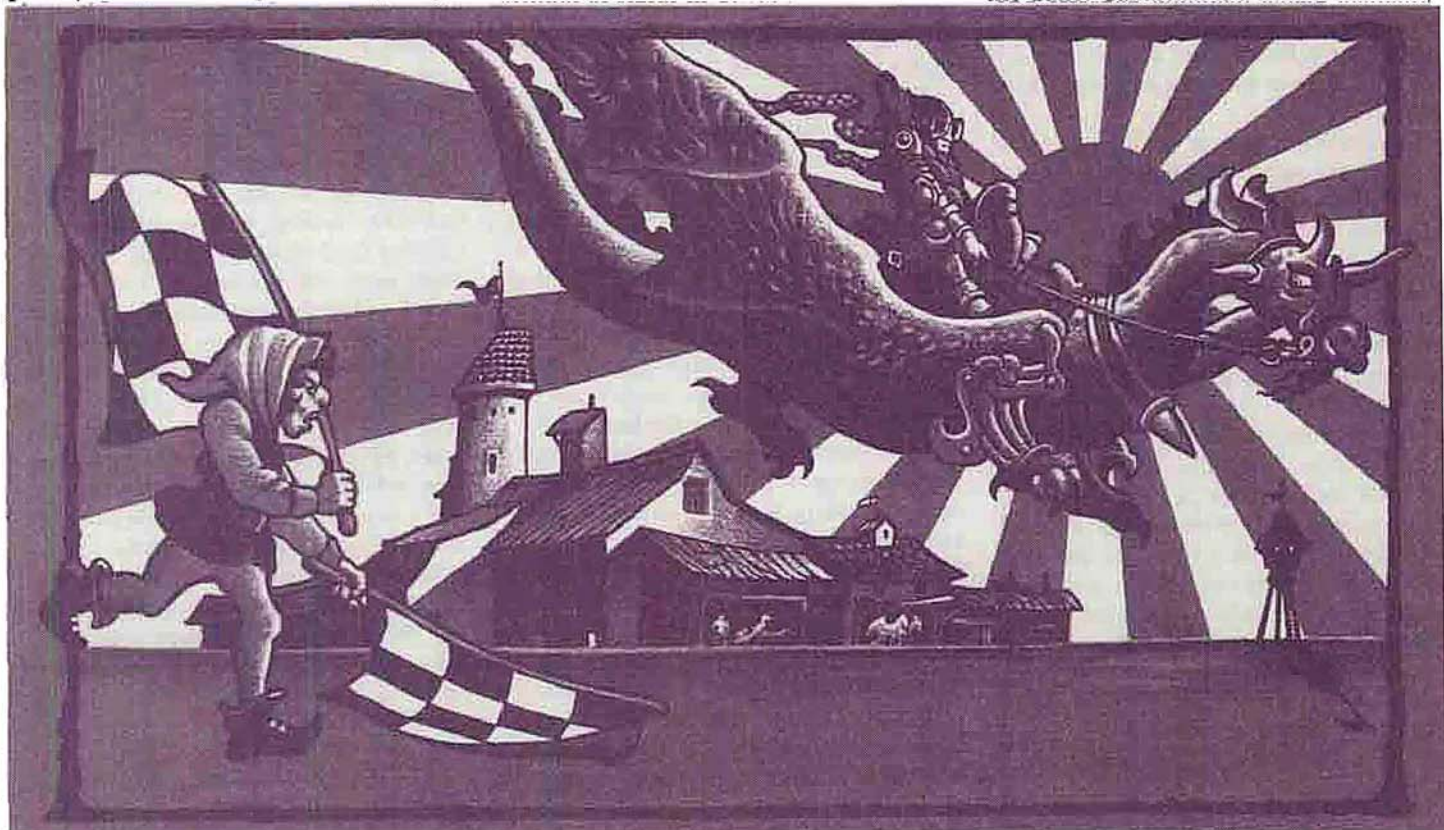

fond of story-tellers and actors, and has grown fond of flying about pegasus-back. In defiance of ancient family tradition, he's not in the Retebius Air Fleet, but is one of the Knights of the Air. Appearance: 6'1", 155 lbs.; Thyatian ancestry; brown hair and beard, brown eyes; customarily dresses in theatrical black trousers, belt, boots, and cloak, and a flowing black silk tunic; age 30.

Duchess Mitasula Retebius (MU18, L) was born Mitasula Nuar. Her father, a seaman-warrior of the Thyatian Navy, taught her to go forth and earn her own way, becoming the best she could be, and she took to this common Nuari philosophy with a vengeance, apprenticing herself to a naval wizard and adventuring widely. She met and wed Callastian on her adventures, and has taken to Thyatian life and membership in the Knights of the Air (she, too, is a Pegasus-Knight) with her usual flair. Appearance: 5'4", 120 lbs; Nuari ancestry; black hair, light brown eyes; customarily dresses in knee-length, long-sleeved white silk tunics and white belt and boots; age 27.

Duchy of Tel Akbir

Population: 150,000.

Description: The Duchy—also known as the Peninsula of Tel Akbir—is grassy in its southern stretch, turning arid to the north. Its population is of Alasiyan and Thyatian descent, tending toward the former. Alasiyan is commonly spoken here, but Thyatian is still considered the Common Tongue, and all officials and rulers must speak it.

Customs: The Alasiyans' attitudes toward women adventurers and other things were given in the "Thyatian Society and Politics" section of *Book II*.

Sites: *Tel Akbir* is the principal community of this duchy; north of the city, on the border with Ylaruam, is mighty *Fort Zendrol* (population 3,000 soldiers and cavalry).

Tel Akbir

Population: 20,000.

Description: This graceful, beautiful city is an easy blend of sea-port, fishing and farming community, and military base—the latter being the support depot for Fort Zendrol to the north.

Personalities: *Duke (Sheik) Tarik ben Nadir* (F12, N) is ruler here. He is a great trader and keeps a knowledgeable eye and hand on the merchant guilds of this city. He is a subtle man, very polite and civilized, but capable of great and treacherous revenge when he believes he has been crossed. He is also the full brother of General Leila, military commander of Raven Scarp in the Hinterlands, and has not exchanged a friendly word with his sister in forty years. Tarik's youngest daughter *Jamila* (T1, C) seems inclined to follow in her aunt's footsteps, which Tarik wishes to stop at just about any cost. He might hire adventurers to escort the unwilling girl to the distant home of the husband-to-be he's chosen for her; or she might plead for help in escaping Tel Akbir, bringing the long-term enmity of the city's rulers on the heads of the PCs. Appearance (of Tarik): 6'0", 190 lbs (should be 160); Alasiyan ancestry; brown hair and eyes; wears traditional Alasiyan dress; age 65.

Duchy of Thyatis

Population: 1,500,000 (including cities and towns).

Description: Thyatis is the most populous and wealthiest duchy in the Empire. It has been a thriving center for trade and warfare for 1,000 years, and could well be for 1,000 more. But its principal feature, the one which the players will be most interested in, is Thyatis City—described below.

Julinius

Population: 10,000 (2,000 military, 8,000 civilian).

Description: This is a large town including a small, well-armed and -provisioned naval base charged with the protection of Thyatis City from naval attacks from the

west. To date, no such attack has ever gotten past Julinius; the natives ignore the fact that this is because no such attack has ever been launched. The waters of the northern shore of Vanya's Girdle are treacherous, and Julinius features a much-needed and famous lighthouse (called "Julin's Torch") as a navigation aid and beacon.

Thyatis (City)

Population: 600,000.

Description: Thyatis is the wealthiest and most populous city in the Empire—possibly on the entire continent.

Thyatis lies where the Mesonion River empties into Vanya's Girdle. The city is built around the Emperor's Hill, the tall central hill where the imperial palace and the wealthiest estates are built.

Thyatis features the Empire's largest seaport as the seat of its navy and trading fleet. It has broad streets of concrete, huge public works and buildings, lavish palaces and villas and mansions; it features vast tracts of three- and four-story tenement buildings. Its streets throng with people every hour of the day and most of the night; it is a city that does not sleep.

Thyatis is an enormous city and the worthy capital of a powerful empire. It inspires pride in its citizens, awe in foreigners from smaller or poorer nations, contempt from foreigners from cleaner or more mannerly citizens. It is a microcosm of the empire, representative of the empire's might and power, mixed population, treachery, efficiency and wealth.

Customs: The one thing that natives of Thyatis City must know, and that citizens of other of the empire's lands, and foreigners, should not, is this: The locals *do not* refer to this metropolis as "Thyatis City." To them, it *is* the empire, and the rest of the empire is merely an extension of it—its fingers. To refer to it as "Thyatis City" is to reveal yourself to be a hick and earn the condescending contempt of local NPCs for some time to come.

Personalities: Many of the most important NPCs of Thyatis are detailed in the next section, "Characters of Thyatis City."

THE CITY OF THYACIS

Population: 600,000

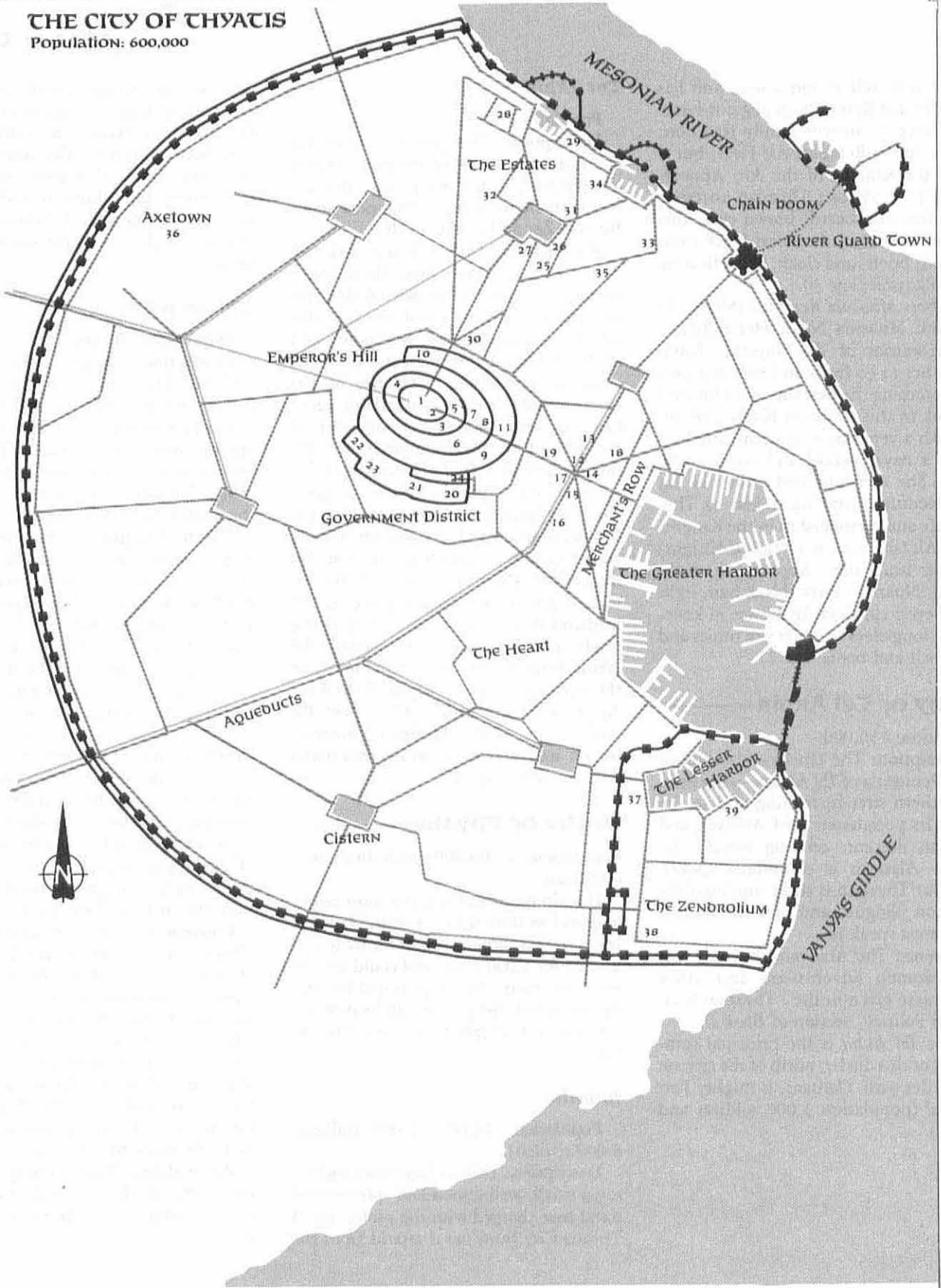

Map Key of Thyatis City —

The map of Thyatis City appears on page 18.

The great city is divided into ten large districts: The Emperor's Hill, the Heart, the Government District, the Blocks, Merchants' Row, the Estates, Axetown, the Zendrolium, and the Greater and Lesser Harbors.

Alone of the larger cities of the Empire, Thyatis brings a lot of water in by aqueduct. The aqueduct runs for many miles to the northern hills, and assures the city fresh, clear water in the worst of dry seasons. The Mesonion River, which runs next to Thyatis City, is too muddy at this point in its journey to provide good drinking water, and is too polluted by waste, likewise.

The city has a good sewer system for most of its needs. The far-too-dense population of the Blocks and Axetown strain it past its capacities, and those districts tend to be dirtier and nastier than the rest of the city (Axetown especially).

But, again except for Axetown, the city is served by broad concrete streets laid in through the centuries, especially from a vast rebuilding program initiated two centuries ago. Most of these streets are wide enough for two four-horse teams to pass abreast; some, such as the great Processional Way that leads to the palace, are wide enough to accommodate eight such teams abreast! The streets feature central gutters to move rainwater, and raised concrete walkways to the sides.

Following is a district-by-district map-key description of the great city.

Emperor's Hill

The Hill is where the elite of Thyatis prefer to live—starting with the Emperor and his family, at the very top. Prices for building on the Hill are astronomical—generally twice construction costs anywhere else, so what would be a 250,000 gp estate elsewhere costs half a million gp here. Naturally, the closer one lives to the Palace, the wealthier one has to be.

(1) **The Emperor's Palace.** This vast, five-story building complex was erected

within the lifetime of Zendrolion I, a thousand years ago, and is still standing. Engineered and built by dwarves, it has withstood assaults and earthquakes; repaired and maintained by dwarves, it is likely to last many centuries more. It accommodates one thousand residents—the imperial family and all their many servants, soldiers, military officers and their own families, sages and specialists, workers and ambassadors, aides and courtiers, concubines and collaborators. Its roof is thickly clustered with anti-airship batteries of ballistae, other seige engines, and even magical weapons—such as banks of *fire ball* and *lightning bolt* wands manned by spell-casting soldiers.

(2) **Palace Complex Walls.** Heavily manned and fortified, also featuring anti-air attack batteries.

(3) **Hightop District.** This is where the wealthiest of the city's estates are built. No estate here cost less than 2,000,000 gp to construct. Though small, these estates are magnificently and lavishly constructed, and ownership of one is a great symbol of status in Thyatis.

(4) **Anaxibius' Estate.** The most popular and wealthy gladiator in all Thyatis has his estate here, in the shadow of the palace walls.

(5) **Hightop District Walls.**

(6) **Streets of Gold District.** The merely extremely-rich dwellers in this district aspire to be wealthy and lucky enough to move to Hightop. Estates in this district tend to be worth around 1,000,000 gp.

(7) **Canolocarius Estate.** Angelarian Canolocarius, a famous senator of Thyatis, keeps his estate here.

(8) **Streets of Gold District Walls.**

(9) **Silverlight District.** This is the district for the merely very-very-rich. Estates here at the base of the Emperor's Hill tend to run around 500,000 gp each.

(10) **Valinor's Estate.** This is the home of the adventurer Valinor. What city authorities don't realize is that Valinor's full name is Valinor Acindelyrovius . . . and that he is the head of the Shadow-Hand, the Thieves' Guild . . . and that he could afford a much more costly estate farther up on the hill, but the one he has now, right next to the district walls, has al-

lowed him to have a tunnel constructed to the outside, a tunnel which his subordinates can use to report to him secretly.

(11) **Silverlight District Walls.** The gates of these walls are scrupulously guarded to keep people who have no pertinent business off the Emperor's Hill.

The Heart

This district is the center of "civilization" in the City. Here are concentrated the majority of greater public works and general public entertainments. In Thyatis City, therefore, the common phrase for going out for a night on the town is "Taking it to Heart."

(12) **The Coliseum.** This massive stone construction seats over 50,000 spectators, and on its sands desperate gladiators battle one another and monsters for the entertainment and adulation of the crowds. Below the Coliseum is a vast dungeon-like network where monsters and slave-gladiators are penned.

(13) **Great Guildhall of the Order of the Sands.** This is a small amphitheatre and attached guildhall where gladiator-members of the Guild may train, find shelter, socialize with one another away from the common man, etc. It is largely supported by guild fees and by contributions from gladiators who have made it to prominence—such as Emperor Thincol and Anaxibius.

(14) **The Baths.** These aren't public baths; this is an expensive private club featuring baths of all varieties in a wide array of special rooms. At the baths one can also receive massages, and excellent medical and clerical care. Membership costs 100 gp/month, making it costly enough to be somewhat exclusive but not so high that well-off middle class Citizens can't buy membership.

(15) **The Great Imperial Library.** This is one of the largest libraries in the world; this great building stands three stories high and has a permanent staff of magic-users and clerics on hand to deal with the dangers of fire. It is not, however, a magically-oriented library, so magic-users researching spells will have to look elsewhere. The library has an uncounted

Atlas of Thyatis

number of books—and, in these days of hand-written book-copying, that is quite an amazing collection.

(16) **The Collegium Arcanum.** This is Thyatis' own school of magic. By Alphatian standards, it is laughably small, but is a good place for beginning Thyatian magic-users to receive their initial instruction.

(17) **The Gabrionus Theatre.** This theatre was built by Gabrionus IV, grandfather of the current Empress. Here, great plays and low vaudevilles are performed. It seats 10,000.

(18) **Club Row.** This district is a tightly-packed region of private clubs, inns, bistros, taverns, small theatres, and other entertainments catering to every sort of taste—from the most innocent to the most debauched.

(19) **The Imperial Bakeries.** It is here that the great quantities of free bread are baked and handed out to Citizens every day of every year.

The Government District (aka *The Machine*)

It is here that the imperial government does its work—here and on the desk-top of the Emperor, up in his palace. But the Emperor only decides and signs; in this district, the brute-force planning, writing, rewriting, pontificating, meeting in committee and in secret, and other hard work of governing take place.

The Thyatian government is also so corrupt and therefore so predictably manipulable that this district is affectionately known as "The Machine."

This district is one of the best-policed in all Thyatis City; guards are everywhere, in great numbers. It's easy to bribe a government official here, but not to kill him and get away with it.

(20) **The Senate Building.** This great building has a central debate-hall which seats 300 Senators and guests near the floor, and 1,200 spectators (when such are allowed) in the balconies. The building also houses great numbers of small offices—one three-room office for every Senator in the Empire.

(21) **Ministerial Buildings.** Each of these buildings is devoted to the doings of one of the imperium's governing bodies: the Judiciary and the Ministries—Foreign Office, Home Office, Imperial Guard (though this ministry has additional offices in the Palace), Trade, War, Title and Estate, Treasury, etc.

(22) **Ambassadors' Way.** This is a series of dwellings for ambassadors to the Empire, provided free of charge. Of course, in Thyatis, you get what you pay for—so ambassadors with any decent amount of money tend to leave these clean, well-maintained but *cramped* quarters to rent or buy estates of their own.

(23) **Government District Walls.**

(24) **Government Market (Leechtown).** Outside the walls of the Government District is a narrow area which caters to the empire's bureaucrats. It's a small market district where every sort of food or other need or service is provided for inflated prices—but it's within walking distance convenient to all the bureaucrats.

The Blocks

These are the city's tenement areas. Most of the city's residents live in the Blocks, which are great, long neighborhoods of multi-story apartment quarters.

They aren't slums by Thyatian standards (even if they would qualify as such by modern standards). Every class of Citizen, from semi-independent slaves to the nearly rich, lives in the Blocks—which tends to be a good thing: The neighborhoods, though packed with too many people, tend to be friendly and egalitarian, unlike the snobbish districts of the Emperor's Hill.

The great tenement buildings are made of wood, brick, and concrete. There are sewers beneath, but these are inadequate for the districts' needs. The sidewalks tend to be littered with trash.

The buildings occasionally do come down, when old foundations crack or walls give way . . . and the occasional fire can rage unchecked for hours, consuming block after block of residences, despite the best efforts of fire-fighting cleric teams and assisting magic-users. Life here

is not necessarily safe, and certainly isn't comfortable . . . but it's the best that most citizens, including low-level player-characters, can afford.

Merchants' Row

This is the great mercantile district of Thyatis. It encloses the Heart like the rim of a wheel, brushing most of the other districts in the city.

If the characters have an ordinary purchase need, they can find it here—from weapons and armor to livestock to slaves to rare ingredients to food to just about anything—magical goods and rare monsters being two important exceptions.

The Estates

After the neighborhoods on Emperor's Hill, this is the best area in Thyatis to live. Here, you have good residential estates and many guildhalls, high-cost and high-class businesses, and temples and churches.

(25) **High Temple of Vanya.** This is the greatest temple in all Thyatis, with a tower-spire stretching ten amazing stories into the sky, and a huge hall which can seat 10,000. (Of course, there are many smaller temples to Vanya in the city.)

(26) **Brotherhood of the Grey Lady Guildhall.** Situated near the High Temple of Vanya is the guildhall for the warriors' guild dedicated to her principles.

(27) **Wings of Vanya Estate.** Similarly close to the Temple is the monastic estate of the Wings of Vanya clerical order.

(28) **Knights of the Air Enclave.** This is the capital city's own Knights of the Air facility, featuring a largish landing-ground and beast-kennels for many smaller and a couple of larger beasts.

(29) **Alphaks' Pit/Free Poetic Recital Hall.** This building is officially the Free Poetic Recital Hall, which is supposed to be some wealthy philanthropist's contribution to the arts—the story goes that he built the hall so that all poets would have a free forum for their art. Many do come to recite, and attendance can be quite good. But this is a front; beneath the building is a secret temple to the evil Immortal Alphaks. Here, his worshippers

plot mayhem and destruction. So far, the existence of Alphaks' Pit is not known to the authorities. When they discover, raid, and destroy it, not much good will come of it; the Alphaks-worshippers already have another site chosen and built, waiting to be activated.

(30) **Storm Soldiers Enclave.** This is the capital city's center for the native Hattian hate-society. This enclave is operated by *Hansel Oesterhaus* (F15, C), son of the Storm Soldiers' leader Heinrich. (Of course, Heinrich is actually the Immortal Thanatos bearing Heinrich's face, but the true Heinrich fathered Hansel before he died, and Thanatos has raised the boy to be a good son to him.) From the front balcony of the Enclave building, Hansel gives stirring speeches about Thyatian and Hattian pride and about vague threats from impure enemies.

(31) **Temple of Asterius (and Free Market).**

(32) **Temple of Valerias.**

(33) **The Park (Foresters' Enclave).** With a little help from magic, this estate ground has been overgrown with vegetation. No building is allowed to stand within its walls, and any Forester or Vyalia elf may sleep within for free.

(34) **Church of Tarastia.**

(35) **Hall of the Sisterhood of the Sword.**

Axetown

This is the worst slum region in the city, overbuilt with decrepit tenements, packed full of refugees and the most pathetic poor, caked with filth and darkened by misery and poverty. It was supposed to have been razed two hundred years ago during a period of city renovation. But the city government didn't reckon with the Shadow-Hand (the Thieves' Guild), which liked this foreboding district the way it was—and used murder, blackmail, and bribery to keep it that way.

It's here that the Shadow-Hand has its nasty underground headquarters and recruits its most desperate minions.

(36) **Shadow-Land.** Beneath this block of slums—no less decrepit, but better-

reinforced than those surrounding it—is a virtual dungeon which serves as the base of the Shadow-Hand. Its location is known to the authorities, but they choose not to touch it: Whenever they destroyed a Thieves' Guild base in the past, the Shadow-Hand has made terrible reprisals, usually assassinations and burnings of areas of the Blocks.

The Zendrolium

This is the military headquarters of Thyatis City. It's a walled compound where most of the empire's military forces are represented. Included here are:

(37) **Fort Zendrolium.** This is the combined army/cavalry base; 3,000 troopers are stationed here.

(38) **Retebius Air Fleet Enclave.** The Air Fleet maintains a small force here, including 100 pegasus riders, 20 griffon riders, and 5 dragon riders.

(39) **Blackrock Prison.** This isn't just a military prison—it's the throw-them-away-and-leave-them hole for all of Thyatis City's worst convicts.

The Greater Harbor

This is the civilian harbor area, with its piers and quays, its great warehouses, and its own market districts.

The Lesser Harbor

This is the naval adjunct to the Zendrolium; it is here that the navy keeps a sizable war-force, and here too are several shipbuilding facilities.

Grand Duchy of Terentias

Population: 25,000 (including towns; 60% human, 40% elvish).

Description: This island is one of the greatest bones of contention between Thyatis and the Minrothad Guilds. Both have claimed the island in centuries past; Thyatis has owned it more or less consistently for the last two hundred years, but bad feelings take a long time to die (especially among long-lived Minrothad elves).

Customs: The citizens of Terentias are either traders, sailors, pirates, or admirers of traders, sailors, and pirates. A character visiting inns and taverns in the town of Crossbones had better know his way around a ship; and if he can tell rousing stories of his own naval exploits, he probably won't have to buy his own meals or drinks for a while.

Sites: The town of *Crossbones* (population 5,000) is the island's capital and home of the fortress of Archduke Derentarius. A lot of trade comes through the city, and a lot of pirate vessels thinly disguised as traders make Crossbones their permanent port. It's a pirate city, full of thieves, rumors, and adventure.

Protectorate of Borydos

Population: 5,000 (500 soldiers, 4,500 prisoners).

Description: Borydos is as described in the "Overview of Thyatis" section in *Book II*.

Regulations: Just about everything having to do with insolence to a military man is a whipping offense; anything more severe, such as assault on a soldier, is a capital crime.

Sites: *Fort Borydos* is where the military garrison works, trains, and maintains the only boats on the island. It's very hard for the ill-fed and ill-equipped prisoners to break in to steal a ship and escape . . . and it's impossible for them to escape any other way, without powerful outside help.

Protectorate of Carytion

Population: 5,000 (including villages).

Description: This island is as described in the "Overview of Thyatis" section of *Book II*.

Atlas of Thyatis

Protectorate of Sclaras

Population: 5,000 (250 estate-masters, 1,250 apprentices and family members, 3,000 slaves and servants).

Description: In just about every powerful land, there's one retreat where powerful magic-users can escape the mundane world. In Thyatis, it is the island of Sclaras. Sclaras is an inaccessible island—it is a rolling, deeply forested land sitting atop cliffs, cliffs which face the sea at every point.

Sclaras is officially the property of the throne; but unofficially, for the past three hundred years, emperors and empresses haven't dared touch it. By ancient tradition, Sclaras is gridded off into approximately half-mile by half-mile estates, around 250 of them. Each is owned by a wizard who has achieved ultimate mastery (36th-level) and can be owned by no lesser wizard. When one wizard dies or decides to abandon his property, all his goods are sent off to his relatives and the next wizard on the "waiting list" may claim an estate.

Regulations: There are no laws on Sclaras, except one: It is unlawful to enter the estate of another wizard without his permission. If a wizard can prove that another has done so, the offender has for-

feited his estate—and may even be killed, if the offended party can manage it. Flying at an altitude of 1,000' or more above an estate does not constitute entering the estate.

Customs: The wizards on Sclaras tend to avoid one another, but are usually professionally cooperative when they encounter one another—it's bad luck for anyone to offend a great wizard, even for another great wizard.

Historical Notes: It's not known how long Sclaras has been maintained in this fashion, but ancient rumor has it that Empress Valentia was the first estateholder on Sclaras.

Personalities: Many famous Thyatian wizards have estates here, including Triella (Duchess of Mositius) and Demettrion (Magist to the Emperor). Player-characters can acquire estates on the island by the means described above; when they reach 36th-level as magic-users, you can assume that there are openings enough for them to have estates. These estates do not constitute dominions.

ON the Sea-Routes OF TRADE

GAZ 9, *The Minrothad Guilds*, contains some excellent and helpful information

about the use of sea-trade in your Known World campaign. But if you center your campaign around Thyatis or Alphatia, you'll want to change some of the information contained on GAZ 9's map of the "Major Known Trading Routes."

First, the island of Terentias is on the Vorloi-to-Kerendas stretch; most ships hug the northern coast, while many jump down from Rugalov to Terentias and then up to Kerendas. Also, the Minrothad-to-Gapton route continues on to Terentias and then to Kerendas.

Second, Kerendas does not import grain—it exports grain.

Third, there is a trade-route option from Tel Akbir to West Portage. Ships dock at West Portage and offload their cargo, which is carried across to East Portage and loaded onto vessels of the same line. From East Portage, they may be taken down the Ekto-Trikelios-Edairo route, or up to Dunadale and east to mighty Aasla.

Fourth, it may seem strange to you that Aasla imports silk when Alphatia is an exporter of their home-grown spider-silk—but this is actually correct. Aasla imports the more normal silks in abundance because Alphatia's sumptuary laws forbid commoners to wear spider-silk . . . but commoners *may* wear normal silk.

Characters of Thyatis City

Your characters may spend a lot of time in the great city of Thyatis—between adventures, during city adventures, and so forth.

Here, we'll describe several of the NPCs they might meet while here. Naturally, they're not likely to meet the Imperial Family when first-level heroes; you'll want to introduce them to these NPCs at times and under circumstances appropriate to their relative stations.

The magic-users presented here are not given a list of Spells Known and Spells Carried. To save space, three different types of Spells Carried lists are given at the back of this book, under "Appendices." If you want to know what sort of spell an NPC mage is carrying, check his level, decide what sort of situation he's in, and compare that to the charts in the back of the book.

THINCOL I TORION

Emperor of Thyatis (Thincol the Brave, Thrainkell Torson)

History: Thincol was born in AC 938. His actual name at birth was Thrainkell Torson; he was the son of Tor, a well-regarded shipwright of Oceansend. But he grew up impatient and ambitious, contemptuous of his family's slow and gradual climb to comfortable wealth. He wanted fame and fortune fast, and so, in AC 956, he traveled to Thyatis City—Oceansend still being a Thyatian colony at the time. In Thyatis, his fighting ability and dramatic sense of style soon made him the city's current favorite in the gladiatorial arena. The Thyatians called him "Thincol," a pronunciation of his name more pleasing to their ears, and he was known as Thincol the Brave.

Four years later, though, the Alphatian Spike Assault smashed into the city and nearly led to Thyatis' conquest. Thincol organized a force of gladiators, scattered military personnel, and adventurers, and led a crushing counterattack which drove the Alphatians out of the Palace and out of the city. Once in command of the Palace, he persuaded the young Princess Gabriela, whose father the Emperor had just perished by Alphatian magics, to marry

him so that he could lead the Empire back to strength. She agreed, and so by virtue of a foreign invasion and catastrophe a northern gladiator became Emperor of Thyatis.

In the years since, he has done exactly as he promised, using every tactic known to him to strengthen the Thyatian military might, subjugate and dominate surrounding territories, harry the Alphatians—without actually quite going to war—and rearing a family in his traditions, children strong enough to take his place when his time comes.

Personality: Thincol is a hard, ruthless, uncompromising man. His greatest rewards came in the gladiatorial arena, and he sees every competition as a gladiatorial duel: Anyone who opposes him forfeits his own life, subject to Thincol's mercy (and sometimes affected by the sentiments of the "audience"—his court and the rest of the world). His friendships are all expedient: If a friend becomes of no further use to him, or angers him, this friend is abandoned or betrayed at the earliest opportunity. He evinces true love only for his children—and doesn't let his court see even *that*, for fear that someone might use his children against him.

Appearance: Thincol is 6'3" and 180 lbs., built like a championship athlete. His features are hard and hawklike, his eyes sharp and raking. His chest and limbs bear numerous scars, and one particularly livid scar starts at the center of his forehead and straggles down to end just over his left eye. His hair is dark brown and beginning to bald; he goes clean-shaven; his eyes are black. He dresses in royal purples lined with gold, and when fighting in the field wears a purple-and-gold surcoat over his armor. His apparent age is early 40s, carefully maintained by *potions of longevity*; his real age is 62.

DMing Notes: Thincol is the wily and treacherous Emperor of Thyatis. Player-characters could earn great rewards in his service, but must be clever enough themselves always to be useful to him—otherwise they'll end up betrayed and spitted at their first mistake. He is quite happy to appeal to adventurers' patriot-

ism and send them off to suicide missions which will benefit himself or the Empire.

Combat Notes: 36th-level fighter; AC 7 (unarmored, Dexterity bonus) or -4 (*suit armor* +2, Dexterity bonus); hp 130; MV 120' (40') unarmored, or 30' (10') in *suit armor*; #AT 4; D 1-10+5 (Strength bonus and *two-handed sword* +2; Save F36; ML 10; AL N; S18 I15 W13 D17 Co18 Ch16; Languages: Thyatian, Alignment (Neutral), Alphatian; General Skills: Profession of Gladiator (I); Profession of Shipbuilder (I); Intimidation (S), Muscle (S), Wrestling +1 (S+1), Military Tactics (I), Danger Sense (W), Detect Deception (W), Alertness (D), Riding Horses (D), Leadership (Ch), Persuasion (Ch).

Magical Items in Possession: *suit armor* +2, *two-handed sword* +2, *rod of partying* (carried as his seal of office).

GABRIELA TORION

Empress of Thyatis

History: Gabriela was the youngest daughter of Emperor Gabrionus V—pampered daughter of a doting father. When the Alphatian Spike attack threatened to reach Thyatis, Gabrionus ordered her and her favorite ladies' maid to switch clothing. Garbed as her maid, Gabriela had to watch as her parents and five siblings were cut down by the jubilant Alphatian wizards leading the attack.

She was "rescued," in the sense that her family's murderers were chased off, when Thincol the Brave led a counter-attack to the very palace. The court-knowledgeable Thincol recognized her in spite of her disguise and, in a brilliantly persuasive display, declared his love for her and for the empire she now was forced to rebuild alone. Young and impressionable—and as besotted with the hero-gladiator Thincol as every other woman in Thyatis City—she unhesitatingly agreed when he said she must marry him so that he might lead the Empire back to glory.

So in only a short time, she went from pampered princess, to terrified captive, to love-struck empress . . . to discarded puppet. Thincol wooed her, married her,

Characters of Thyatis City

fathered children upon her, but never really cared for her. He kept her for the sake of legitimacy and his children, but took mistresses as it pleased him and ignored her most of the time.

Personality: Over the years, she has grown depressed and old both in body and spirit. She will not take the *potions of longevity* her husband acquires for her. She haunts the back corridors of the palace like a grey ghost, speaking to few but her children, waiting for herself or her husband to die but unwilling to speed either process along.

Appearance: Gabriela is 5'2" and 135 lbs. Her hair is greying black, her eyes a faded brown. Her features are careworn and she usually seems distracted. She dresses well, for her ladies-in-waiting choose her garments, but she no longer cares about her appearance. She is 56.

DMing Notes: Gabriela exists as an embarrassment and problem for the Emperor. He doesn't love her, never has, but he would wish her to be happy and healthy for the sake of his children—and

appearances. Were a group of PCs ever to accomplish some miracle of persuasion in an adventure—changing the mind of a famous and stubborn NPC over some long-standing feud or point of honor—Thincol would hear of it and hire them to try to bring Gabriela around. If they succeeded in persuading her to “return to life,” begin taking the potions he acquires for her *of her own free will*, and so forth, the heroes would be well-rewarded. On the other hand, if they failed, he might just try to have them killed—it wouldn't do to have normal adventurers knowing so much about the Empress' fragile state of mind.

Combat Notes: Normal Woman; AC 9; hp 4; MV 120' (40'); #AT 1; D 1 point (unarmed); Save F1-1; ML 12; AL L; S9 I11 W14 D15 Co11 Ch15; Languages: Thyatian; Alignment (Lawful). General Skills: Knowledge of Emperor's Palace +3 (1+3).

Eusebius TORION

Prince of Thyatis, Count of Lucinius

History: Eusebius, oldest child and only son of Thincol and Gabriela, was born in AC 261. Nominally raised at home—by valets and soldier-companions—Eusebius entered the West Reach cavalry officers' academy at age 18 and spent a dozen years as a good cavalry officer, rising to the rank of Captain. At age 30, he resigned his commission at his father's request and came home to “learn the business”—the business of ruling the Empire. He married at 32, seven years ago, and now has two children of his own—grandchildren for the Emperor.

Personality: Eusebius is very much his father's son, only not so rash and impatient—he has a cold, chilling calmness about him. Like his father, he loves little but his family and the life of the ruler, and is bright and canny enough to rule strongly when he takes the throne—some day. Secretly, Eusebius has his own timetable for this; he reasons that in an-



Characters of Thyatis City

other ten years or so, he will be ready to "retire" his father and assume the throne himself. He hasn't yet decided how far he will go to retire his sire; at the moment, he is only willing to kidnap the man and incarcerate him somewhere far away. But, with admirable forethought, he is secretly building himself an organization of supporters—getting loyal fighters appointed to the imperial guard and key military positions, making friends with specific children of specific foreign rulers and with famous adventurers, etc.

Appearance: 6'1", 170 lbs.; brown hair and eyes, goes bearded; has craggy but impassive features and flat, cold eyes; wears white dress uniform with no unit insignia; age 39.

DMing Notes: At a point in the PCs' careers when they are becoming famous and powerful—around Name level, or later, as it occurs in your campaign—Eusebius will become their friend, fixing problems for them, helping them in their quest to acquire dominions, etc. He is trying to win their loyalty to him instead of his father, and any clever PC should eventually be allowed to figure this out with an Intelligence check—or perhaps the player will figure it out without a die-roll. In any case, being the "friend" of Eusebius is the same as being that of Thincol: If a character remains useful to the prince, and is both difficult and costly to betray, he will remain in Eusebius' good graces and continue to profit from the relationship. Otherwise, look out.

Combat Notes: 18th-level fighter; AC 9 (unarmored) or 0 (*plate mail* +2, shield); hp 55; MV 120' (40') unarmored, or 90' (30') armored; #AT 2; D 1-8+4 (Strength bonus and *normal sword* +2); Save F18; ML 10; AL N; S17 I16 W10 D12 Co13 Ch12. Languages: Thyatian, Alignment (Neutral), Elvish (Vyalia dialect), Alphatian. General Skills: Intimidation (S), Knowledge of Horses (I), Mapping (I), Military Tactics (I), Tracking (I), Animal Trainer (Horses) (W), Riding (Horses) (D), Deceive (Ch), Leadership (Ch), Persuasion (Ch).

Magical Items in Possession: *plate mail* +2, *normal sword* +2, *ring of human control*, *amulet vs. crystal balls & ESP*.

Stefania Torion

Princess of Thyatis

History: Stefania is the second child, oldest daughter, of Thincol and Gabriela. She was named after Thincol's friend Stefan Karameikos, back when he was Thincol's friend (before he abandoned Thyatian ways and ran off to rule his own nation). Born in AC 970, she was instructed from youth in her role as something for Thincol to marry off to forge powerful political alliances—and she rebelled at that role. Nevertheless, at 14 she was betrothed to a princeling of Ostland, and at 17 she was forcibly wed to him. On her wedding night, she stabbed her husband to death.

The result was a substantial weakening of Thyatis' relationship with Ostland and a tantrum from Thincol that has gone down in palace legend. Thincol protected his daughter from any legal ramifications or foreign reprisals . . . but he ignored her, did not speak to her or acknowledge her presence for six months, all but abandoned her. Her brother sided with Thincol; her mother was sympathetic but too distant to offer much support; her sister was too young.

She turned for support to Demetria, the Emperor's magist, and that canny fellow told her to simply leave—to run away from home, as the common folk did—that only by making something worthwhile and achieving her own power could she earn her father's respect.

That she did, and became an adventurer, swordswoman and heroine of Duchy Machetos—with her hair dyed black and with her new name of Demetria. Years later, in AC 995, when she was fighting a well-publicized duel with a similarly notorious fighter, and handily winning, the Emperor recognized her . . . and relented. Confronting her, he requested her to return to the palace, on her own terms.

She has retired the Demetria identity without letting it be known that Demetria and Stefania Torion are one and the same; from time to time, when the mood strikes her, she takes up her own calling

and goes adventuring. In the time she has been back in Thyatis, however, she has been successfully wooed by Anaxibius, the city's current favorite in the gladiatorial arena, and the two are conducting a passionate affair—in spite of (or because of) the Emperor's obvious disapproval.

Personality: Stefania has learned to live on her own terms and will stop at nothing to keep that right. To those who do not threaten her freedom, or who do not condescend to her because she's a pampered princess, or who do not prejudge her because of her slaying of her husband, she can be a good friend.

Appearance: Stefania is 5'10" and 140 lbs, in excellent fighting shape. She has flaming red hair and blue eyes naturally, or black hair and blue eyes in her Demetria identity. She dresses in high-quality clothing cut like a military uniform as Stefania, and wears green adventuring garb (with black leather accoutrements) as Demetria. Age 30.

DMing Notes: "Demetria" is another way for the PCs to slip into the circle of the Imperial family without actually knowing it. Demetria adventures occasionally and could ally herself with a player-character party when doing so. Stefania slips out of the palace quite often to visit Anaxibius, and could be set upon by kidnappers when doing so; while this is likely to bring more grief to the kidnappers than anyone else, there could be enough of them that a player-character rescue is in order.

Combat Notes: 15th-level thief; AC 1 (Dexterity bonus, and *leather armor* +3); hp 45; MV 120' (40'); #AT 1; D 1-8+2 (*sword* +1, see below and Strength bonus); Save F15; ML 6; AL C; S14 I13 W15 D18 Co13 Ch16. Languages: Thyatian, Alignment (Chaotic), Elvish (Vyalia). General Skills: Lip Reading (I), Signalling (Thief-Signals) (I), Detect Deception (W), Gambling (W), Riding (D), Acting (Ch), Music (Stringed Instruments) (Ch), Singing (Ch).

Magical Items in Possession: *leather armor* +3; *sword* +1, flames on command, *Int* 7, *chaotic*, sees *invisible*, named Thrainkell.

Characters of Thyatis City

TREDORIAN

Prince of Alphatia (Youngest Son of Eriadna the Wise)

History: Tredorian was born 17 years ago, son of Eriadna the Wise (Empress of Alphatia) and General Torenal of Sundsvall. Like all of Torenal's children, Tredorian has absolutely no ability with magic. He was visiting his brother, King Ericall of Norwold, a year ago—he was hoping to earn a dominion in Norwold someday, a dominion where he would not be looked down upon because of his lack of magical ability. While he was in Alphas, he got very drunk on a pub-crawling spree . . . and woke up in the hands of Thyatian agents sailing off with him as a prisoner of Thincol.

Pity the poor agents. Thincol didn't want them to cause any scenes, just to gather information. This was certainly a scene. Thincol killed them, of course, and for a while it was against the law to remove their heads from the pikes at the city gates.

Inevitably came Eriadna's demand for the return of Tredorian. But the wily Thincol, seeing that Tredorian might flourish in Thyatis (where non-magic-users face no discrimination) and might switch allegiance to Thincol, and knowing that his own children were far more loyal than Eriadna's were, had a counter-proposal to make.

Thincol sent his own youngest daughter Asteriela to be a counter-hostage, smoothly commenting that both empires might profit from this cultural exchange. Eriadna, for once, agreed with the Thyatian. So the two great powers traded children.

Personality: Tredorian is a hesitant and slow-speaking young man, perhaps because of all the years he grew up powerless in the Alphatian imperial palace. He has taken well to life in Thyatis, and is learning to fight and depend on himself. As Thincol predicted, he is looking to the Emperor as a second father, and his loyalties will probably end up with Thincol. (But Thincol was too arrogant to guess that the same process would take place between Princess Asteriela and Empress Eriadna . . .)

Appearance: 5'9", 150 lbs; brown hair and eyes; clean-shaven; common Alphatian coloration; wears trousers, tunic and accoutrements in royal blue, with a patch of Alphatia's flag on his shoulders; age 17.

DMing Notes: When Tredorian and Asteriela are traded back again, each will be a weak link to the ruling parent, because his/her loyalty will lie elsewhere. For now, Tredorian is learning to fight—and the Emperor often hires trustworthy adventurers with distinctive swordplay styles to train him. He is also training to be a Knight of the Air, which could put him in contact with the PCs. These are good opportunities for the PCs to meet someone who may one day command some political power in Norwold or other Alphatian lands . . . and will always have Empress Eriadna's ear.

Combat Notes: 4th-level fighter; AC 2 (plate and shield); hp 25; MV 120' (40') unarmored, or 90' (30') armored; #AT 1; D 1-8+2 (from Strength bonus); Save F4; ML 4; AL L; S17 I15 W18 D12 Co11 Ch13. Languages: Alphatian, Alignment (Lawful), Thyatian. General Skills: Knowledge of Alphatia (I), Profession of Sailor (I), Alertness (D), Riding +1 (Horse) (D+1), Riding (Pegasus) (D).

DEMETRION KARAGENTEROPOLUS

Magist to the Emperor

History: Demetrium was born 105 years ago, son of a military officer in Julinius. He ran away from home at 15 and wandered the world, eventually becoming apprentice to an adventuring magician and then becoming such a magician himself. He retired at the age of 60, to live on the island of Sclaras . . . but then, in AC 959, the Alphatians began their famous Spike assault. He returned to Julinius to protect his surviving family, and followed the invading Alphatian force into Thyatis City, where he had a great deal to do with the success of Thincol's counter-attack.

After Thyatis was secure once again, Thincol employed Demetrium for a massive fee. Demetrium is Magist to the Emperor, and a consultant to the Retebius

Air Force on matters of defense against the magical Alphatian forces.

Personality: Though he's aged, Demetrium is not a retiring personality. He's as powerful as a wizard can be and so does exactly as he pleases without fear of reprisal from Thincol. He counseled Stefania to run away from home and later admitted the fact to Thincol. He has criticized the Emperor to his face for the man's treacherous dealings and neglect of Gabriela. In a land known for its treachery, he promotes honor and trustworthiness, and will sometimes fund adventuring expeditions organized by Lawful (or at least honorable) adventurers. He makes the *potions of longevity* used by Thincol, and crafts magical weapons for some members of the royal family—but doesn't make any items with bonuses above +2 (too much work, in his opinion). He's also fond of practical jokes, often involving *monster summoning* spells. And he's a member of the Knights of the Air—a Dragon-Knight, riding golden dragon Hytiliaph.

Appearance: Demetrium let himself age naturally to age 65 or so, until the Alphatian Spike assault, but later decided that he needed to be physically younger and more vital if he was to be Magist to the Emperor. So he has taken *potions of longevity* to return his physical age to about 35 . . . while using *disguise* spells (from the "Character Creation" section in *Book III, Players' Guide to Alphatia*) to maintain his 65-year-old appearance. He wears his aged appearance for his ordinary duties, taking on his younger appearance when he needs to travel anonymously. When doing so, in a sort of tribute to Princess Stefania's use of the feminine form of his name, he calls himself Stefanius. He is 5'10" and 150 lbs., Thyatian ancestry, real age 105, in either form. As Demetrium: white hair and beard, brown eyes; wears white robes with red trim and accoutrements; apparent age 65. As Stefanius: black hair and beard, green eyes; wears nondescript trousers, tunic, boots and belt; apparent age 35.

DMing Notes: Demetrium is a behind-the-scenes doer of deeds in the Empire's



best interests—or so he believes. He correctly and honestly advises the Emperor on matters magical. But when the Emperor or the empire does something with which he disapproves, he'll sometimes leak information on the misdeed to interested parties, using his Stefanius identity. For example: "There's a ship, by name the *Black Moon*, leaving Julinius five days from now. It looks like a normal merchant-man, but it's actually carrying gold to hire mercenaries to harrass the Oceansenders. I don't think Oceansend needs any more trouble . . . and I don't think the crew on that ship is behaving very properly, or ever has in the past . . . and I think a nice party of adventurers like yourselves could make much better use of all that gold. Don't you?"

Combat Notes: 36th-level mage; AC 9; hp 70; MV 120' (40'); #AT 1; D 1-4 + 2 (*dagger* + 2); Save MU36; ML 8; AL L; S12 I18 W14 D11 Co17 Ch15. Languages: Thyatian; Alignment (Lawful); Alphatian; Alasiyan; Elvish (Vyalia). General Skills: Doctor (I), Knowledge of Herbal Medicines (I), Knowledge of Alphatian Magical Military Tactics (I), Profession of Teaching (I), Alchemy (I), Alternate Magics (I), Magical Engineering (I), Planar Geography (I), Guidance/Counsel + 2 (W + 2), Riding (Horses) (D), Riding + 2 (Dragons) (D + 2), Persuasion (Ch).

Magical Items in Possession: *bumberchute* (from the "Knights of Thyatis"

chapter of *Book II, Players' Guide to Thyatis*), *ring of djinn summoning*, *ring of regeneration*, *crystal ball with clairaudience*.

Anaxibius

Gladiator

History: Anaxibius grew up in poverty and left at a youthful age for the adventuring life. He amassed a huge fortune and came to Thyatis City five years ago to buy properties and bring his family here . . . but was cheated out of his fortune by a clever Thyatian banker, who skipped town with the entire amount. Having hit rock-bottom, Anaxibius entered the gladiatorial arena to earn himself a few coins for food. But he won his first match, and his theatrical fighting-style endeared him to the crowd. He continued fighting in the arena to get enough money for passage home . . . and kept winning. He stayed around long enough to go back home in style . . . and, a year later, he brought his family from Machelos and settled them in a large manor in The Estates. Three years after that, he bought himself an estate in the wealthiest district on Emperor's Hill. During the course of all these events, he has become the most popular figure in Thyatis City, including the Emperor, and has begun an *affaire d'amour* with the Emperor's daughter Stefania.

Personality: Anaxibius' life seems, in part, to mirror the Emperor's early years . . . and it's true that the man has ambition. But he's not Thincol, and isn't wooing Stefania to have a chance at the imperial throne. His passion for her is genuine—and probably star-crossed, unless one of them goes through a change of alignment. His goal is simple: He wants to amass enough gold to buy Duchy Machelos for his father—and subsequently for himself, when his father decides to rule no longer. This would take an enormous series of bribes to various senators and to the current Duke of Machelos, and a lot of time and trouble to arrange . . . but he's arranging it.

Anaxibius is popular in the arena because he almost always wins his bouts, conducts himself with a chivalric code far loftier than that of his opponents or even most Thyatian knights, and has tremendous personal magnetism. He's not the greatest fighter in the world—is not as good as Thincol, for instance—but he is arguably the most popular.

Appearance: 6'4", 200 lbs; black hair and eyes; dresses in bright red gladiator kilts, red-enamelled leather armors, red boots and bracers (in public); age 30.

DMing Notes: Anaxibius could hire PCs as negotiators to the Duke of Machelos, to begin the process of (illegally) buying that dominion; he can hire thief-PCs to help him sneak into the Palace (a daunting proposition!) for an important rendezvous with Stefania; and he's always

Characters of Thyatis City



on hand when they visit the arena. Emperor Thincol could hire or persuade the PCs to spy on Anaxibius, especially when he is with Stefania, to try to determine the man's real political ambitions.

Combat Notes: 30th-level fighter; AC 2 (*leather armor* +2 and *Dexterity* bonus) in public appearances, AC -1 (*chainmail* +2-equivalent gladiatorial armor, shield, and *Dexterity* bonus in the arena; hp 90; MV 120' (40') in public, 90' (30') in the arena; #AT 3; D 1-6+6 (*short sword* +3 and *Strength* bonus); Save F30; ML 10; AL L; S18 I11 W13 D18 Co12 Ch18. Languages: Thyatian, Alignment (L). General Skills: Intimidate (S), Wrestling (S), Profession of Gladiator (I), Knowledge of Corrupt Senators (I), Survival (Forest) (I), Danger Sense (W), Alertness (D), Riding (Horse) (D), Acting (Ch), Bargaining (Ch), Persuasion (Ch).

Magical Items in Possession: *leather armor* +2, *chainmail* +2, *short sword* +3.

Helena Daphnotarthius —

Cleric of Valerias

History: Helena was born daughter of a garrison officer at Seagirt in the Pearl Islands, and so grew up where cultures clashed—where the stern, organized Thyatian navy rubbed shoulders with the cheerfully chaotic Nuari peoples. Helena grew up heavily influenced by the two divergent elements, discipline and duty vs. individualism and self-will.

Her personal quest for a sense of identity led her to the Temple of Valerias, a fiery Immortal of love and war, and she became a cleric of that temple. Since that time, she has wandered the Empire, promoting the virtues of her clerical order, adventuring, seeing the world.

Personality: Helena is best described as fiery—fiery in anger, in romance, in the pursuit of the things she wants. Her great desires in life are to see the world, to live life to its fullest (seeking adventure and romance wherever she goes), to support her church and its doing wherever she goes, and to promote the questionable virtues of reckless abandon and thoughtless enjoyment to the mainland Thyatians, whom she views as being cold-blooded and far too efficient.

Appearance: Helena is 5'6", 130 lbs; red hair and blue eyes; dresses in heavy armor with a red surcoat decorated with yellow flames (the same design is painted on her shield); she is in her late teens or early 20s.

DMing Notes: Helena is an interesting encounter or perhaps a recurring NPC for your players to meet. She works well in a variety of roles:

She can be the overambitious adventurer who bites off more than she can chew and must be rescued from some villain's dungeon. To give the PCs some reason (other than doing good) to rescue her, you could make her an integral part of one of their investigations; only she has

the next clue in the chain of clues they're following to some end, and to get her clue they must break her out of prison.

She can be the great romance in the life of one of the male PCs. She could run into the PCs in any between-adventures stopover in a town or city and fall in love with one of the PCs there. After a madly passionate but brief romance, she disappears, but the PCs encounter her again and again over the years as she shows up in the least likely places—sometimes on their side, sometimes as an enemy.

Combat Notes: 4th-level cleric; AC 2; hp 21; MV 90' (30'); #AT 1; D 1-6+2 (war hammer plus *Strength* bonus); Save C4; ML 10; AL N; S17 I11 W15 D12 Co15 Ch17. Languages: Thyatian, Alignment (Neutral). General Skills: Riding (D), Honor Valerias (W), Intimidate (S), Knowledge of Pearl Islands (I).

Magical Items in Possession: None.

Tanarobi Nuar —

Pearl Island Consul

History: When Tanarobi was 30, a respected warrior, husband, father of four children, his youngest brother decided to leave the Islands to see the wide world. That brother, Bolotobi, was 17 and as green as the sea—that was a Nuari expression meaning that he was ignorant as it's possible to be and yet breathe.

Characters of Thyatis City

Dylan Son of Penn

Gladiator/Adventurer

History: Dylan's tribe, a branch of the extended Raven tribe of the Hinterlanders people, was the clan which resided in Raven Scarp, the original meeting place of all the Raven tribes. Dylan's father Penn was son of the chief in those days. Twelve years ago, when the Thyatians came to the Hinterlands, they overran Raven Scarp and captured it. Penn's father died in that invasion, and Penn, heir-apparent to the chieftainship, surrendered to the invaders. Penn's son Dylan was less than ten years old at the time, but has grown up keenly feeling the tribe's contempt for his father Penn.

When he reached his Freedom Year, age 21, Dylan left his home and his father, determined to travel the Empire which had conquered his people. He had a second motive, one he doesn't discuss with casual friends and associates: His uncle, his father's brother Brian, is a leader of "the resistance" back in the Hinterlands; uncle Brian is a guerilla leader who leads raids and secret attacks on the Thyatian occupation forces. Brian has asked Dylan to learn as much as he can of the ways of the Thyatians, and so Dylan is doing double-duty as a spy for his uncle.

Dylan came to Thyatis City and ended up as a novice fighter in the gladiatorial arena. He has developed into a sturdy and reliable gladiator; he is still new and young enough that he hasn't developed much of a personal style or fan following, but the chief gladiator Anaxibius feels he has a lot of potential as an arena fighter.

Personality: Dylan is a dour, close-lipped man, brooding over the injustices his people have suffered at the hands of the Thyatians, over-zealous in his role as a spy for his uncle, not experienced enough to know how to do much good for himself or his people. He's not stupid, but he's not learned in the ways of espionage or the analysis of enemy forces or abilities. In short, he's unprepared for his role as an observer in the lands of his enemies. He's made several friends in Thyatis City, and likes many Thyatians individually, which makes his secret opposition to them even

Bolotobi booked passage on a ship bound for Thyatis City, and that is the last any of his kin ever saw of him. Months later, they received a dry, impartial letter from the city guard of Thyatis City, clinically stating that the young man had been killed by city guards while he was committing a crime. It had taken a long time to uncover the young man's identity, hence the delay of several months between his death and the sending of this letter.

Tanarobi followed his brother's path to Thyatis City to find out all the details of his brother's death, and they turned out to be grim indeed. Soon after Bolotobi reached Thyatis City, the young man had been duped by a local criminal gang. The gang convinced him that they were endeavoring to win a bet—they'd win a wonderful party and night on the town if one of their members could climb a certain tower during a certain hour of night, enter the tower through a specific window, and let down a rope for his cronies. Bolotobi was only too happy to help, but unfortunately this wasn't a challenge task—it was a robbery. A city guardsman saw it during its commission and shot Bolotobi with a crossbow; the young Pearl Islander fell to his death.

Tanarobi was appalled at the ease with which his brother had been tricked to his death; looking into the situation further, he discovered that most Pearl Islanders coming to Thyatis City were just as ignorant of the ways of these "civilized men" as his brother had been, and thus just as easy to dupe. The Pearl Islands had a consulate in Thyatis City, a place like an embassy where Nuari could come for help and advice; but this fact was not widely known and the consulate was not an important or particularly vigorous office.

So Tanarobi decided to change that situation. He applied for a position within the consulate, and brought his family up to Thyatis City. Through determination and diligent, hard work, he became chief consul within a few years. He made sure that all Pearl Islanders sailing from the port at Seagirt and arriving at Thyatis City knew that the consulate was there to advise them. In short, he so changed the

role of his consulate that he always had work to do, but today, some 20 years after he arrived in Thyatis City, among the Pearl Islanders his name is widely known; he is honored among his people for his efforts on their behalf.

Personality: Tanarobi is best described in terms of his sense of duty. He's not haunted by the tragedy of his brother; that was a sad, sad incident, but is buried two decades in the past. However, the thought that sheer guileless innocence could kill more of his island peoples disturbs him as intensely now as it did when his brother died, and he works just as hard now as he did then. He's full of advice and recommendation for young travelers and visitors, not just those of Nuari ancestry; but he knows the difference between a ranting old man and an entertaining storyteller, and tries to tell his advice in small, interesting bits instead of long, boring discourses.

Appearance: Tanarobi Nuari is a middle-aged Pearl Islander, still fit though he hasn't wielded a spear in actual combat in some 20 years. He is 5'11", 160 lbs; greying black hair and eyes; clean-shaven. He dresses as a Thyatian, and speaks the language like a native—there is no giveaway Nuari accent coloring his speech.

DMing Notes: In a campaign, Tanarobi is a helpful advisor to players. He's especially easy to bring into a campaign if one of the PCs is from the Pearl Islands; every Islander in Thyatis City knows that he can get advice and sometimes help from Tanarobi Nuari. But the consulate is not his whole life, and he can bump into PCs in the streets, at government functions, and at good taverns.

Combat Notes: 6th-level Rake (Non-Thief/Thief); AC 5 (leather armor and Dexterity bonus); hp 17; MV 120' (40'); #AT 1; D 1-6+1 (short sword and Strength bonus); Save T6; ML 8; AL L; S13 I13 W15 D17 Co12 Ch14. Languages: Nuari, Thyatian, Alignment (Lawful). General Skills: Sailing (D), Riding (D), Knowledge of Thyatis City (I), Knowledge of the Thyatian Empire (I), Knowledge of the Pearl Islands (I), Singing (Ch).

Magical Items in Possession: None.

Characters of Thyatis City



harder for him to maintain. All in all, he's a very confused young fighting-man.

Appearance: 6', 180 lbs.; flaming red hair, mustache, beard, blue eyes; dresses in color-clashing Hinterlands fashions normally, but prefers black-enamelled armor in the gladiatorial arena; age 21.

DMing Notes: Dylan is an agitator for adventurers in the Hinterlands. In the campaign, he'll gradually become a more and more popular gladiator, and will use the money he earns to buy arms and ships and smuggle them to his uncle Brian's forces in Raven-Land in the Hinterlands. This can lead to several varieties of adventures for the PCs. They can be the crewmen hired to transport these goods to the Hinterlands (in which case the adventure consists of them running Imperial blockades and outwitting Imperial Navy forces to deliver the goods). Alternately, they can be hired by the Empire to investigate Dylan, get in good with him, and then thwart his smuggling plans. Of course, during these investigations they must face the ethical question: *Should* they interfere with his revolutionary activities? That's up to them and their own codes of ethics, but it should be a tough and interesting choice for them.

Combat Notes: 3rd-level fighter; AC 3 (chainmail, shield, and Dexterity bonus); hp 26; MV 90' (30'); #AT 1; D 1-8+2 (normal sword and Strength bonus); Save F3; ML 10; AL N; S16 I13 W10 D13 Co17 Ch12. Languages: Hinterlander, Thy-

atian, Alignment (Neutral). General Skills: Riding (D), Tracking (I), Wrestling (S+1), Acting (Ch).

Magical Items in Possession: None.

ANGELARIAN CANOLOCARIUS

Senator of Thyatis City

History: Angelarian grew up in the lap of luxury, scion of the immensely wealthy and powerful Canolocarius family. This clan had built its way up to fortune and influence through one of the oldest ways known to man: By having no scruples concerning their methods, by doing anything to anyone, by taking lots of money to do these things, and by paying the right amounts of money to the right people to make sure no official trouble resulted.

And Angelarian grew up a fit son for this family. He was accepted to his first governmental post, a minor ministerial position, at the age of 21. By the age of 25, he had amassed quite a fortune from the acceptance of bribes and kickbacks. At 30, he was elected as one of Thyatis City's two representatives in the Senate, and for 20 years has been a Senator.

He is widely-known and popular in Thyatis City, and is mistakenly thought to be no more corrupt than any other Senator. He is a good speech-maker, always available to address classes at the city's universities or to be present at the dedication of a new statue or building.

On the side, of course, he accepts large bribes to support special interests in Senate voting. He proposes laws to benefit special categories of the population—for instance, the shipping guilds, the Shadow-Hand thieves' society, whomever is paying well that year. He arranges arm-breakings, the terrorizing of specific merchants or opponents to his legislation, and the occasional murder.

Personality: He is the most well-spoken and witty Senator to be found in public service. He loves feasts and dinners, adores the theatre, loves expensive foods and entertainments. There's nothing in his attitude to suggest that he also has no qualms at murder or intimidation; he seems to be a pleasant, wealthy man who is happy to serve the people.

Appearance: 5'6", 210 lbs; black hair (balding and clean-shaven), black eyes; dresses in ostentatious Thyatian dress, likes to ornament himself heavily with jewelry.

DMing Notes: The Senator can serve several roles in a campaign. He can be the man who's threatened the health of an honest but poor Senator, one who runs to the player-characters for help; he can also be the man who hires the down-and-out PCs for a few thumb-breaking incidents, putting them in the uncomfortable position of listening to their consciences and leaving his service, thus earning his disfavor, or continuing to work for him and bartering away their own ethics.

Characters of Thyatis City

Combat Notes: Normal Man; AC 9; hp 4; MV 120' (40'); #AT 1; D 1-4 (dagger, may be poisoned); Save F1-1; ML 4; ALN; S10 I13 W12 D11 Co9 Ch16. Languages: Thyatian, Alphatian, Alignment (Neutral). General Skills: Codes of Law and Justice (W), Profession of Senator (I), Acting (Ch), Leadership (Ch), Danger Sense (W).

Magical Items in Possession: None.

Theodosius KANTINOMEIROS

Con Man and Nuisance Monster

History: Theodosius was abandoned at birth and was reared in an orphanage operated by the Order of the Grey Lady. He didn't learn any of the Order's principles of honesty, honor and courage, however, preferring to make his way in the world through sneakiness and cleverness. Rather than follow the Order's ways and take clerical training, he ran away from the Order at age 15 and has been on the road ever since, making his living by persuading foolish people to give him money for one grand scheme or another.

Personality: Theodosius is the classic confidence man. He tries to become the friend or business partner of any gullible person with money. He concocts plausible-sounding but totally false schemes for building fortunes. He has no

conscience or ethics; he seduces and abandons young women as casually as he takes money from gullible patrons. He is, however, a very charming man and a persuasive talker, and leaves his especially foolish victims under the impression that things have gone badly for everybody and he's been as much a victim as they have. He's left a string of broken hearts, and smashed fortunes behind him in the course of his fifteen years of traveling.

Appearance: 6'2", 180 lbs; brown hair and mustache, brown eyes, dashing appearance and manner; prefers to wear a military-styled uniform in dark browns or dark blues, not wearing any military unit designations (unless it suits his purpose).

DMing Notes: Theodosius is handy when you want to cause a lot of trouble for your player-characters, especially when they've come into a lot of money which you don't want them to continue to have. Somehow—and you ought to come up with a good explanation for it—he figures out the PCs' current plans for the use of their fortune. (His information-gathering technique usually involves the use of his *medallion of ESP*.)

He moves one step ahead of them in order to pry them from their fortune. For example, if they're planning to buy a ship, he moves a step ahead of them and cons some ship-owner out of the use of a good ship. Then, he sells this ship to the

PCs at a good price—leaving him with a lot of money he's gotten for nothing, leaving the PCs in possession of stolen goods, leaving the ship-owner trying to retrieve his rightful property from an angry band of adventurers.

When the PCs do catch up to Theodosius, he's manufactured evidence that he had been *charmed* by some wicked mage, one who has a dungeon-full of valuable political prisoners and a treasury full of gold; if only the PCs will help him, they can free all those grateful prisoners and walk out of there with more gold than they can carry . . . and so on.

In short, he's a trouble-maker of the highest order, and a lucky man to boot; he could be one of their chief antagonists for several game-years, if you wish.

Combat Notes: 8th-level Thief; AC 1 (*leather armor +3* and Dexterity bonus); hp 22; MV 120' (40'); #AT 1; D 1-8+2 (from *sword +2*); Save T8; ML 4; AL C; S12 I18 W16 D18 Co9 Ch16. Languages: Thyatian, Elvish (Vyalia), Alasiyan, Alphatian, Alignment (Chaotic). General Skills: Lip Reading (I), Signalling (Thief-Signals) (I), Detect Deception (W), Cheating/Gambling (W), Riding (D), Acting (Ch), Deceive (Ch), Persuasion (Ch).

Magical Items in Possession: *medallion of ESP, sword +2, leather armor +3*, all swindled from adventurers.

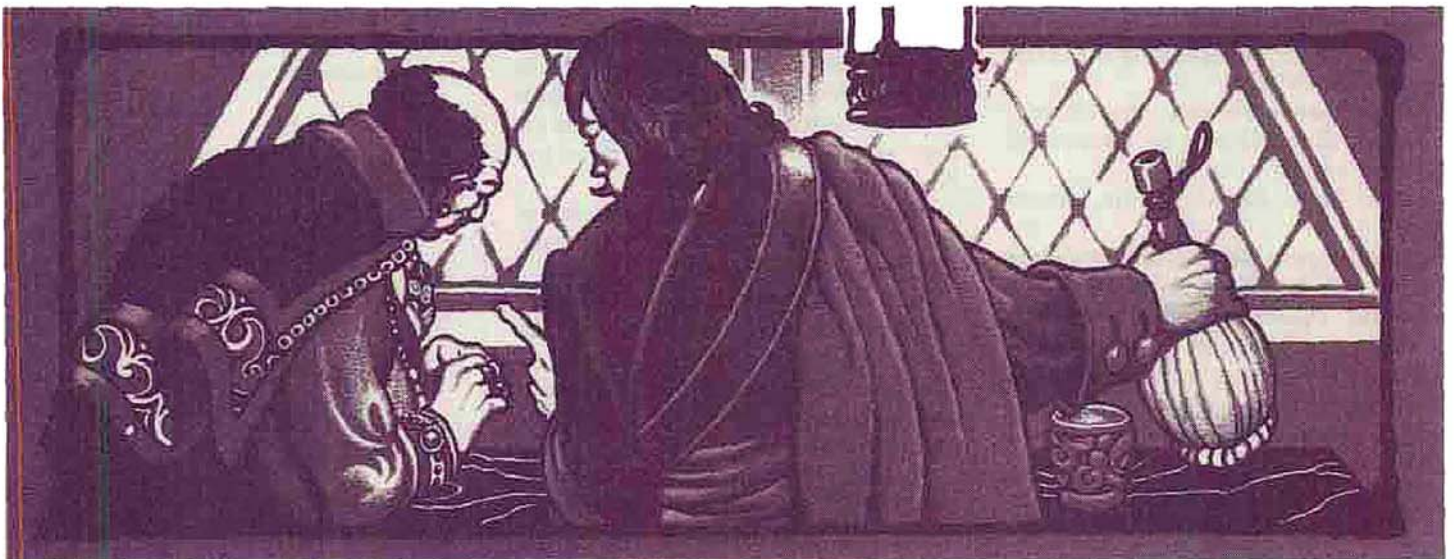

MONSTERS OF Thyatis

Here, we'll describe the monsters that appear in the lands controlled by the Thyatian Empire. If a monster from a D&D® publication mentioned below isn't listed, assume that it doesn't appear in Thyatian territories (unless, of course, you really want it to).

DUNGEON MASTER'S RULEBOOK

(Basic Set)

Bandit: Especially common in the northern hills of mainland Thyatis.

Bear: Common in the western forest regions of mainland Thyatis; and in the Shadow Coast forests of the Isle of Dawn.

Boar: Found in the tropical rain forest of the Hinterlands and in the western forest regions of mainland Thyatis.

Cat, Great: Mountain lions in the northern hills of mainland Thyatis; lions found in grassland areas of the Hinterlands; tigers and panthers found in Ochalea.

Dragons: Though not common, red, gold and white dragons are found in the Altan Tepes mountains; green dragons are known to the Hinterlands; blues are rarely seen in Kerendas. All neutral-alignment dragon types are represented in Retebius, in the Air Fleet and Knights of the Air enclaves.

Gargoyles: Found in any area within a 200-mile radius of the island of Sclaras. Several chaotic MUs create gargoyles there to use as servants.

Ghoul: Fairly widespread in mainland Thyatis and Ochalea.

Living Statues: See *gargoyles*, above.

Lizard, Giant: Dracos are common in the Pearl Islands.

Lizard Man: Known in the Hinterlands.

Lycanthropes: Werewolves sometimes cross over from eastern Karamaikos into mainland Thyatis. Ochalea has a few weretigers, well-hidden. A city as cosmopolitan as Thyatis City has representatives of all lycanthrope types, usually very good at keeping their condition hidden from friends.

Mule: Common through the Empire.

Ogre: Northern hills of the mainland.

Pixie: Western forest of the mainland.

Rat (Normal): Widespread through the Empire.

Skeleton: Common on Sclaras.

Snake: Giant racers not unknown in the northern hills and Ochalea. Rock pythons common in the Hinterlands.

Sprites: Known in Ochalea and the Pearl Islands (appreciated in the latter place, disliked in the former).

Wolf: On the mainland, northern hills and western forest.

Expert Rulebook

Animal Herd: Horses in Kerendan Plains; cattle in Retebius.

Centaur: Infrequently sighted in western forest on the mainland.

Crab, Giant: Teem in the waters off the island of Borydos.

Crocodile (Normal): Found in slow-moving Hinterlands rivers.

Dryad: Occasionally seen in the western forest on the mainland. Some long-forgotten wizard on Sclaras was a friend of dryads and so there are many on that island.

Fish, Giant: There are many Giant Rockfish in the waters off Borydos Island.

Giant: There are hill giants in the northern mainland hills, but no stone giants.

Golem: Found in the company of powerful spell-casters, especially on the island of Sclaras.

Griffon: They live in distant places in the hills north of the Kerendan Plains and sometimes swoop down on the plains to attack horses there. Many griffons are kept at Retebius, at the Air Fleet and Knights of the Air enclaves.

Horse: All over the mainland, Isle of Dawn, Ochalea, and the Hinterlands. Not found on the Pearl Islands.

Men: Brigands hide out in the hills north of Biazzan and west of the passage to Ylaruam, and fall on caravans there. Buccaneers and pirates are common in Thyatian waters, especially in Terentias and the southern coast of the Isle of Dawn.

Merman: Common in the waters off the Pearl Islands, and cooperate with the Islanders from time to time.

Pegasus: They fly free in the Altan Tepes mountains and in the northern mainland hills. There are also many in Retebius, serving the Air Fleet and Knights of the Air.

Purple Worm: There are some beneath Ochalea.

Treant: There are many such in the rain forest of the Hinterlands.

Unicorn: These are rarely sighted in the northern hills of the mainland, and there are said to be some on Sclaras.

Vampire: There is at least one clutch of vampires in Thyatis City, and it is said that this group sometimes cooperates with the Shadow-Hand. There are also a few in Duchy Machelos, because of that dominion's proximity to Karamaikos.

DUNGEON MASTER'S COMPANION

Dolphin: Common in the Sea of Dread, around the Pearl Islands, Ochalea, the southern parts of the Isle of Dawn, and the Hinterlands.

Drolem: One is known to exist on Sclaras. The prospect of a drolem-rider in the Knights of the Air is a disturbing one.

Gargantua: Known to exist on Sclaras.

Ghost/Haunt: Very rare, but known to the mainland, the Isle of Dawn, and Ochalea.

Golems (Mud, Obsidian): Known on Sclaras and in the company of powerful MUs.

Manta Rays (Giant): Common to the waters around Borydos.

Campaigning in Thyatis

There are a few aspects to role-playing in the Thyatian civilization which should be discussed here, in the DM's Book, away from the prying eyes of your players.

The Career Path

First, we'll talk about the "career path" of Thyatian characters—the way they can progress from first-level adventurers to high-level movers and shakers in the Thyatian Empire.

Basic Adventures

In their earliest adventures, the PCs should be learning about their world and figuring out what sort of role they're to have in it. Give them adventures that take them all over the Empire. Let them learn the ground rules they'll have to know in order to prosper in this setting. A little later in this chapter, we'll be talking about the renowned Thyatian treachery, and how much of it you'll want to have them encounter—that's one of many such important considerations.

The most important consideration, of course, is that you and the players have fun within the setting. If, after several basic adventures, you're not having a lot of fun, you need to decide what it is about the setting that is limiting your entertainment—and change it to suit your campaign.

These Basic adventures are also the time you'll want to introduce the campaign's cast of recurring NPCs (such as family members, friends, allies, and enemies of your heroes).

Expert Adventures

In the Expert adventures, the heroes should have a good grasp of the doings of the Empire. It is now that you should expose them to influences *outside* their Empire. They've had lots of adventures predicated on the ideas that the Thyatian Empire is the best possible place to be and that all other nations, especially the Alphatian Empire, are second-rate; it's now time to send your heroes out to those places so that they can form their own opinions.

Naturally, since all the PCs have ever heard have been the thoughts of other Thyatians, they may be in for a rude awakening when they really reach other cultures. The fact that the rest of the world doesn't stand in collective admiration of the Thyatians may come as a shock to them. Such cultural elements as the alien sophistication of the Glantrians and the raw power and chaotic happiness of the Alphatians are going to jolt the characters into an awareness that the Thyatian Empire truly is not the center of the universe.

It is also now, during the Expert adventures, that many of the PCs will be thinking about acquiring dominions for themselves. Give them those opportunities—both inside the Empire, and outside. The characters who have achieved the most fame or earned the most favors within Thyatis, of course, will have the opportunities to win dominions inside Thyatis. But other heroes may find similar opportunities elsewhere—with the Alphatians, in Norwold, in Karamaikos, in the demihuman lands of Alfheim and Rockhome and the Five Shires, in hero-loving Ierendi, etc.

By the end of their Expert-level adventures, the heroes may all be in charge of dominions—but those dominions may be scattered all over the Known World. The only thing now binding the PC heroes together is their old association and friendship—because now, politically, they have divided loyalties.

Companion Adventures

Now, the heroes are familiar with their world, and you might have sent them off into alternate worlds once or twice. There are now two types of adventures which you want to bring them into: Political Arena Adventures and Multiverse Arena Adventures.

In Political Arena Adventures, you introduce adventure situations by using the heroes' own political interests and ties. When a dominion ruler who borders one of your PCs begins making life uncomfortable for that PC, and is working within the rules of the Empire, you have a political adventure taking place. Perhaps this

miscreant is competing with your PC's dominion by competing in trade and undercutting his prices; perhaps he is advising Emperor Thincol that the PC is not trustworthy, and the Emperor is cancelling his plans of civic development and road-building through the PC's dominion; perhaps the PC learns that the NPC has been infiltrating his dominion with far more spies than necessary; what then?

Then, you recommend to your player that he reassemble his old friends and that they counter political sneakiness with sneakiness. They'll have to do their own spying and bribing and sending of agents until they find out what the NPC is up to and why. It could be the fellow is simply greedy; it could be that one of the players' adventures of years ago resulted in some great tragedy in the NPC ruler's life. In any case, what you have here is a Political Arena Adventure taking place, and you can inject as many or as few action and adventure elements (assassination attempts, bad feelings at tournaments resulting in free-for-alls, enemy wizards summoning demons to ruin the PCs' plans, etc.) as you and your players like.

Multiverse Arena Adventures are more of the types of adventures where you launch your heroes into alternate dimensions. However, now that your heroes are scattered all over the Known World Map, you have to work harder to bring them together for these things.

Here, again, one good technique to use involves the Loose Thread. After all, your PC heroes have been adventuring together for years and years. Not every adventure they've accomplished has been completely, 100% resolved. In every one, they've left some loose threads dangling. In one adventure, a minor villain got away. In another, the heroes shut the door on the dimension ruled by a megademon—but didn't destroy the demon itself. In still a third, a sorceress might have had a mad affair with one of the PCs and was then never seen again.

Today, years later, you can use these Loose Threads to bring your heroes together again and to send them into all sorts of mad adventures. For example, that minor villain who got away may have

Campaigning in Thyatis

used these intervening years to become a master-villain with lots of powerful magical items and armies of nonhuman minions. Now, today, he launches his armies simultaneously at the dominions of his hated enemies. Those enemies have to get together and face him in his own lair while all their armies are battering one another to pieces in the outer world . . .

For example, that imprisoned demon could have escaped into the Known World, and the world's best-known mystic says that only the specific heroes who imprisoned him before can find and catch him now . . .

For example, that sorceress might have birthed a son who has himself become a great adventurer, but was lost in a cross-dimensional adventure, and now she has come to the child's father to ask him to reassemble his old friends and find their child . . .

All these Loose Thread techniques, and many more, can be used to bring your scattered PCs together and then send them off in any direction. Your only limit here is the extent of your own ability to draw interesting facts out the player-characters' histories and then extrapolate possible consequences in their current-day lives.

Masters Adventures

Eventually, the heroes will become interested in pursuing paths leading to immortality. At that point, the type of paths they decide to pursue determine whether you should still continue to play with these PCs as the campaign's "main" adventures, or whether you should generate new characters to be the primary focus of the campaign—while the old characters remain as patrons and background movers as shakers pursuing their own destinies.

What you, as DM, will have to do is look at the choices they have made of their paths to immortality and see if those paths can be played with the normal PCs. Often, the answer to that question will be No—at that time, you need to build yourself a new campaign and pursue the old characters' goals outside the scope of the normal campaign.

Campaigning in Alphatia

In the next chapter, "Alphatia," is a section entitled "Campaigning in Alphatia." It has its own description of the player-characters' "Career Path," looked at from an Alphetian viewpoint . . . but each of the descriptions of the different campaign stages (Basic, Expert, etc.) deals with different topics from those you've read here. So don't skip over that section when you come to it; it has its own points to make.

Treachery

The Thyatian Empire is legendary for its treachery. Betrayal and backstabbing are national pastimes—particularly in politics and business. If you're to utilize this element into your own Thyatian adventures, you have to decide how you're going to introduce it and how much of it you're going to have.

Setting the Amount

There are three basic levels of treachery at which you can run your campaign. They are, from worst to least:

Utterly Treacherous. In this sort of campaign, everyone is out for himself—NPC and PC alike. The player-characters adventure together out of enlightened self-interest, but will abandon one another—even old friends—to the fates when the going gets rough. Every official and trader will do his best to cheat the PCs; the characters will be able to accomplish nothing until they learn how to bribe in the most effective manner possible; an employer will only pay his PC hirelings when it's in his best interest to do so (and most are clever enough not to get in physical-confrontation situations—the PCs have to learn to apply other pressure, such as the threat of exposure of misdeeds). This is the sort of level you want to run if your characters are from a nation or subject area beholden to (or enemies with) Thyatis—such as the Alphetian Empire, Norwold, Ylaruam, etc.

Very Treacherous. In this sort of campaign, the PCs encounter and themselves participate in a good deal of treachery.

Here, the only bond between PCs is friendship—one PC will not abandon a true friend, but will probably have very few of those. NPC allies and hirelings tend to abandon the PCs when things get bad; at least half the officials and traders encountered by the PCs can be worked with only through bribery; employers will stiff PC adventurers for their fees whenever it's convenient, but will not do so if it puts them in danger. This is the level of treachery you want to choose for foreign-based campaigns with adventures taking place in Thyatis (for example, if your characters start out in Karameikos or Ylaruam or Darokin and then conduct a series of adventures in Thyatis).

Uncommonly Treacherous. In this sort of campaign, the PCs run into a lot of treacherous NPCs, and may be of somewhat shady morals themselves. Hirelings tend to abandon their employers when things get bad; one official or trader in three is a bad egg, requiring bribery to work with; employers occasionally (more frequently than in other nations) stiff their PC hirelings for their fees. In short, it's not so treacherous that PCs can't stand to live here, but treacherous enough that they always have to be on their toes—which makes this the treachery level most appropriate to campaigns based out of Thyatis.

Introducing It to Characters

Now, you have to determine how to introduce your level of treachery to the player-characters. Before you begin your Thyatian adventures, sit down with (or write a note to) each player and explain the situation to him.

PCs who are Thyatian in origin should get an accurate explanation of exactly how treacherous life in Thyatis really is—based on the level you've chosen.

PCs from enemy or subject nations should get a horror-story of how treacherous life in Thyatis is—describe Thyatis as if it's run at the Utterly Treacherous level, even if it is not.

PCs from a neutral nation should get the impression that life in Thyatis keeps you on your toes—but should be mostly unac-

Campaigning in Thyatis

quainted with the kind of treachery that takes place here, so that the first time they encounter it they will be caught unaware.

As the PCs begin and continue playing in the campaign, you should reflect the level of treachery you've chosen in the actions of the NPCs your heroes encounter. If your campaign is Utterly Treacherous, practically everyone will try to cheat, rob, backstab, or bleed dry your PCs. If your campaign is Very Treacherous, about half of the NPCs will treat your heroes in this shabby fashion. If your campaign is only Uncommonly Treacherous, a third or a quarter of the NPCs will behave in this manner.

Player-Character Treachery

With all this in mind, you may want to help get your Thyatian player-characters into the "treacherous mind-set"—or you may want to let them discover it for themselves. Also, with treachery such a common, day-to-day affair, you want to let your PCs know that the solution to the problem is almost *never* hauling out a

sword and killing the cheat—life in Thyatis is more subtle than that.

Example: One of your PCs hands a horse-trader a bag of gold for a champion steed. The horse-trader, a thief, surreptitiously switches the bag for a similar one containing copper coins. Then he opens the second bag and angrily accuses the PCs of cheating him. The natural PC reaction will be to kill the wretch immediately. You must remind your players: "Wait a minute. As far as the witnesses are concerned, you gave him a bag, he opened it and accused you, and you start killing him. Are you going to kill every innocent witness? If you do, you'll never get away with it. And if you don't, and still kill the trader, you'll end up being executed by the Empire for murder. Even if you just knock him down and find your real pouch on him, he's got you on assault and theft. Use your brains; figure something else out." Encourage them to plot their own scam to turn on the trader, or to come up with some other elaborate revenge plot—one that's appropriate to the theft of a few gold pieces. Murder, obviously, is inappropriate, and if

the characters insist on that route, you can always have them caught in the act by imperial officials.

You also want to take charge and teach your PCs how to be treacherous within the context of the campaign.

Example: The heroes are allied with a party of NPC adventurers. All plan to divide into two groups to assault an encampment of enemies on a pre-arranged signal. As the PCs sit in the dark waiting for the signal, mention to their leader the advantages of not attacking at the signal. The NPCs attack the camp alone, and get creamed; more gold for everybody on the PC team. Once that first battle is done, the PCs can attack whomever is still standing; still more gold for all the PCs.

But you need to vary the amount of treachery you initiate by the treachery level you've chosen, and by the alignments of the player-characters. If you've chosen the Uncommonly Treacherous level, you don't want to push your PCs into treachery all the time—only very occasionally, even less commonly than NPCs treat the heroes treacherously.



Campaigning in Thyatis

Also, and *very importantly*, you don't want to recommend treacherous deeds to Lawful characters. Do so only occasionally with Neutral characters; do so as much as you want with Chaotic characters.

Finally, you have to make sure that use of treachery doesn't make your campaign unplayable. The PCs need to be able to trust *somebody*—usually each other and some NPCs known to them. Introduce NPCs who have impeccably honorable reputations, and have them live up to those reputations, so that the PCs will have someone to trust. In all but the most treacherous of campaigns, discourage PCs from backstabbing other PCs—tell them the truth, which is that they'll never be trusted again and will not be able to adventure with PC allies. If your PCs have no one to trust, you lose a lot of what you can do within your campaign—give them some anchors they can depend upon.

Buying Titles and Appointments

Because Thyatis is politically corrupt, it's possible to buy, illegally, such things as political appointments and lower hereditary titles. The money the character spends pays for the title or appointment and other benefits depending on the type of title or appointment being bought:

Ambassador: Ambassadorial appointment to some nation with which Thyatis has relations. Purchased appointments are always to poor and seedy or troublesome but unimportant nations.

General: Military commission and appointment to the head of the military unit with the worst record and personnel in the Empire.

Lord: A bogus coat of arms (if he is not already from a noble family), a fake (but hard to disprove) genealogical chart showing the character's "noble ancestry" and how he comes to be the true heir to this dominion, and the cheapest, poorest dominion plot of land (one 24-mile hex as per the normal rules) that one can find anywhere in the Empire.

Baron: Exactly as per the Lord, except the title is that of Baron.

However, when one buys an appointment, those who earned or inherited theirs legitimately know about it or can figure it out and usually treat the character with scorn and contempt—until he's proven himself, and usually long after. The Emperor himself can figure it out, and this usually makes it very hard for the character ever to achieve a greater title.

Just because it's possible to buy an appointment or title doesn't mean that PCs should be able to do so before they're of an experience level which would ordinarily allow them to take dominions. If a character has earned enough money before he reaches Name level, and wants to purchase a title then, you allow him to track down the bribeable officials and give them the money . . . but the ponderously slow mechanisms of the Thyatian government will keep the title from being bestowed before the character has reached Name experience level. Alternatively, a low-level character who tries to buy a title could find that the corrupt official just takes his money and skips town, forcing the PC to start all over again.

This option is not intended as an opportunity for characters to get dominions easily or conveniently. It's a way for them to get dominions if circumstances would otherwise prevent them—for instance, if the Emperor has, in the campaign, taken a dislike to them, or if you, the DM, *wants* them to do it this way for some story reason or another. It's a very dramatic storyline to maneuver your PC into buying a dominion, then facing the scorn of the peers and having to build his dominion up into an economic power—and built his reputation back up into something that others will respect.

This option also explains how certain NPC nobles and officials whom the player-characters loathe managed to get their *own* titles and appointments.

See the Appendices section in the back of this book for costs for various titles and appointments.

Bizarre Customs

In the "Thyatian Society and Politics" chapter of *Book II*, we mention the bizarre customs of some of the Empire's citizens. But we didn't get into detail on those customs, because they are something which you, as a DM, ought to spring on unsuspecting player-characters.

Each race in the Empire—excepting the basic Thyatians and Kerendans—has one or two customs which prove startling to representatives of other races—inside or *outside* the Empire. Introduce these into your campaign to provide comedy touches or to distract your PCs from other events.

Note that characters from the most cosmopolitan areas in Thyatis—particularly the big cities—will have seen most of these customs before. You want to spring them on characters with rural or more foreign origins.

Alphatians of the Isle of Dawn: Alphatians of the Isle of Dawn, as distinct from those from mainland Alphatia and Bellisaria, tend to react to things they find unpleasant (such as bad manners) by "not seeing them." Such a character, asked a rude question, will "not hear it" once or twice before replying. When he does reply, there is no sign that he deliberately ignored the questioner; he will seem honestly not to have heard the question. But it will happen again and again . . .

Hattians: The Hattians are raised in a grand old military tradition—very disciplined, very correct, very loud. When given orders in a military context (or in the home of a military parent), Hattians spring erect, click their heels together, and bellow out their response: "Yes Sir!" "No Sir!" "At Once, Sir!"—and so forth.

But in the field, when things get tense, they sometimes forget they're not supposed to do this. So, whenever the heroes are in a tense situation and the leader issues orders to a Hattian, the Hattian may automatically do that—even if the party is supposed to be silent.

The first time such a situation comes up in an adventure, give the Hattian player-character an Intelligence or Wisdom check

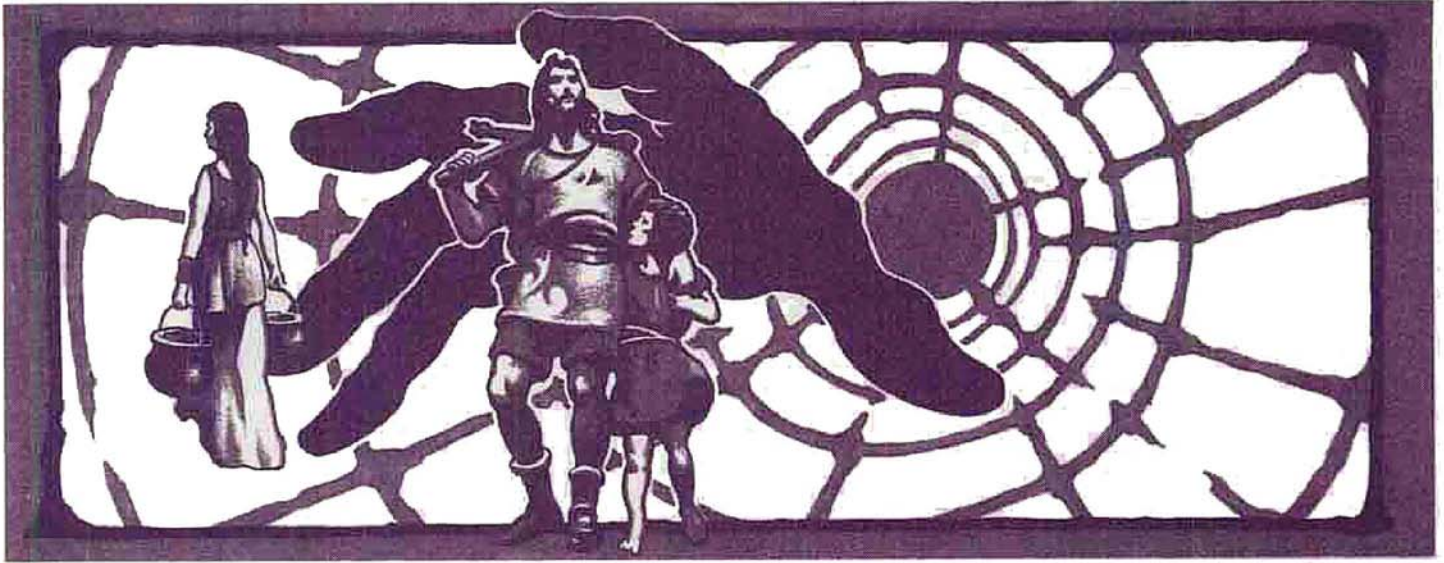

(whichever is higher) to remember not to perform the heel-clicking routine. If he fails, he springs up and bellows before realizing what he's done. If the Hattian is an NPC, don't even give him the luxury of an ability check if the situation will mainly result in comedy and aggravation for the characters. (If it's likely to result in death, give PC and NPC alike an ability check at a +3 to the ability.)

This shouldn't happen more than once or twice in an adventure—unless you're confident that you can successfully DM it as a "running gag" (i.e., a recurring joke that stays funny within the adventure).

Ochaleans: Ochaleans, men and women alike, tend to greet one another and strangers by kissing—a mouth-on-kiss, regardless of the genders of the two parties involved. This has no romantic or sexual connotation in their culture—it's their handshake. But it proves very startling to outsiders to whom kissing is a sign of affection or desire.

Pearl Islanders: The Pearl Islanders have two customs which startle non-Islanders:

First, Islanders tend to carry around small bags with colorful carved beads or seals, pretty shells or stones, and the like. When meeting someone for the first time, they present him with the gift of one of these—it's called a "Meeting Gift." It's customary for that person to respond with a similar gift before the day is

done (it usually takes place at the same meeting), and if it doesn't happen the Islander's feelings are hurt. (Note that an Islander who has been exposed to mainland Thyatian culture will realize that it's not a Thyatian culture and not be offended—but Islanders fresh off the boat will not, and PCs can trip over this custom when visiting the Pearl Islands.)

Second, the Islanders think nothing of social nudity, particularly for outdoors labor, sleeping while camping, and so on. It often takes years in Thyatian culture before they finally, reluctantly, become accustomed to being clothed all the time when among others.

Slaves in Thyatis

Much of the wealth of the Thyatian Empire is built on slave labor. But, while that labor is important to the empire's economy, it's important for you, the DM, *not to glamorize slave presence in the campaign*. This isn't a setting where slaves, preposterously, enjoy their situation; instead, almost all are overworked and undernourished to premature death.

Every one who can, a small proportion of the total slave population, saves money until he can buy his freedom—even those kept comparatively comfortable by their owners.

It's possible for a player to want his character to start out at slave-class, partic-

ularly those who want to rise out of the gladiatorial pits. It's not encouraged, but you shouldn't refuse to allow this; just let them know that it's not a fun life.

Gladiator-slaves will be able to save up money faster than others . . . but, once or twice, you should have a gladiator-slave PC cheated or robbed by his owner or (more commonly) by another ambitious slave. This should take place when it acts as a major setback to the character's plans . . . just to remind him of the unpleasant side of the slaves' existence.

The Thieves' Guild in Thyatis

We didn't discuss the Thyatian Thieves' Guild(s) in the *Players' Guide to Thyatis* because it's a subject which only Thief player-characters should know anything about. If you have any Thief PCs, as you probably will, you should take the players aside and discuss the Guild situation with them . . . when the other players won't hear you.

The Shadow-Hand

The major Thieves' Guild in Thyatis is called the Shadow-Hand. It's huge and well-organized, ruled by the mysterious Shadow King in Thyatis City.

The Shadow-Hand is only the latest in a long succession of powerful Guilds in the Empire. It is about two hundred years

Campaigning in Thyatis

old, and was created as a pirate organization operating out of the island of Terentias. The pirates of the good ship Shadow-Hand cooperated with the old Thieves' Guild of Thyatis City to get their goods fenced, then began muscling in on the Guild's territories. The resulting crime war went on for a dozen years . . . and eventually the Shadow-Hand crew was triumphant.

Its ruler, the old pirate captain Zentic Acindelyrovius, settled in Thyatis City, married, and founded a dynasty of thieves to rule the Shadow-Hand organization. The Guild is still in the hands of the Acindelyrovius family two hundred years later.

Details on the Guild

Interests: The Shadow-Hand exists as a "Thieves' Union." It tries to make life a little easier for thieves in the Empire. However, it insists that all thieves belong to the Guild, whether or not they want or need to. The Shadow-Hand also works to crush rival Thieves' Guilds. Many individual thief gangs and crime families belong to the Shadow-Hand; they don't constitute separate Thieves' Guilds.

Requirements: All members of the Guild must be of the Thief class. Women are welcome. The Guild does have "Honorary Members" who are of other character classes; they must have general skills

which are of great utility to the Guild (such as magic use, Acrobatics skill, knowledge of potential theft sites and the forces protecting them, influence with the Senate, etc.). Regardless of class, all members and honorary members pay the annual fee. The Guild also hires a lot of Fighters, mostly 1st-level, as bruisers and thugs to assist in thefts.

Annual Fee: 30% of all thieflly revenues.

Benefits: Thieves don't usually pay taxes on their thieflly revenues, so the 30% Guild fee is not in addition to the Thyatian income tax. (However, Thyatian officials, if they can prove that a thief has not paid income taxes on his revenues, will convict him.) The Guild will provide a player-character with additional thieves (of a level lower than his) for jobs; the split required by the Guild for such jobs is 1 share per level of the thief, 3 shares per level of the thief planning the job. *Example: A 5th-level thief plans a job and gets three 3rd-level thieves as assistants. The swag is split into 24 shares; the planning thief gets 15 (level 5 x 3), while each assistant thief gets 3 (level 3 x 1). Each thief then pays 30% of his revenues to the Guild.*

Problems: The Shadow-Hand takes terrible vengeance on member Thieves who betray the guild—withhold income, snitch to the authorities, etc. The Guild has enemies—smaller rival guilds. And a

thief PC will have to conceal his income from the authorities: If he buys a 100,000-gp house, he'll have to indicate where he got the money and prove that he paid taxes on it. Most successful thieves record and pay taxes only on their "adventuring income" (i.e., non-thief income) and then use their thieflly income for other things: Maintaining a high life-style, secretly investing in distant businesses, setting themselves up with alternate identities, etc. Finally, of course, the Thyatian authorities are the implacable enemies of the Shadow-Hand, and so a thief character must be very careful or fall into the grasp of the Law.

Rival Thieves' Guilds

Naturally, the Shadow-Hand is not the only Thieves' Guild in the Empire. There are many smaller ones, all of which have requirements and benefits similar to the Shadow-Hand. If a PC wants to belong to a rival organization, he may . . . but it's not a good idea to have thieves from rival gangs in the same band of PCs.

These rival bands tend to conduct occasional gang-wars, trying to wipe one another out. These are deadly, brutal, secret fights which can sometimes drag player-characters into their events.



Before you continue reading this section, you need to read *Book III: Players' Guide to Alphatia*. This will give you a good overview of the Alphasians—at least, what they think of themselves.

When you return here, you'll learn the *truth*—not just what the Alphasians think, but what the actual facts are behind their beliefs . . . and what player-characters can do for adventure and their livelihoods in this empire.

History of Alphatia —

Unlike the Thyatian history, the "History of Alphatia" as it appeared in *Book III*, is substantially the truth. Although it's

told from the Alphasians' viewpoint, including their distaste for the "barbarian" Thyatians, the events it describes are accurate.

This is because the Alphasians started out a lot more civilized and longer-lived than the Thyatians, and with a much higher proportion of scholars than the Thyatians; they were literate millennia ago and have memories from much earlier times more or less accurately preserved in their records.

Though scholars can wage spiteful wars in their press, and blur facts as easily as anyone else, the volume of historical material published in Alphatia since before Landfall is sufficiently great that later and

more impartial scholars can reconstruct the actual events with considerable accuracy. It is for that reason that the Alphasians' history, as it is taught to their children, is not wrapped up in myth and deception like the Thyatians'.

DM's Historical Synopsis —

Instead of repeating all the information from the DM's Historical Synopsis in the "History of Thyatis" section of this book, we're simply putting all the historical facts, Thyatian and Alphasian, in one timeline; see the end of the "History of Thyatis" section in this book for the combined synopsis.

Atlas of Alphatia

In this description of mainland Alphatia, we'll give you abbreviated descriptions of many of the more intriguing kindoms of the mainland. First familiarize yourself with the "Overview of Alphatia" chapter from *Book III*, then return here to get the additional, DMs'-eyes-only details.

As with the Atlas of Thyatis, you're encouraged to flesh out these places and also those places shown on the map but not described in this text. On the fold-up sheet is the map of mainland Alphatia; refer to it when reading this section.

As you'll see, Alphatia is very densely populated. It can afford to be—as described in the "History of Alphatia" in *Book III*, the Alphatians can grow much more food per-capita than other nations because of their magic. So do not be surprised by population figures that look higher than other regions of the world—they really are.

"KINGDOM" OF Alphaks' Volcano

Population: 5,000 (including town of Revenge).

Description: About 300 miles off the northwest coast of mainland Alphatia lies a volcanic island perpetually wreathed in fog—the island of Alphaks' Volcano, as described in *Book III, Players' Guide to Alphatia*, in the "Overview of Alphatia" chapter. Under the fog is what looks like dark and sinister but uninhabited volcanic island. The volcano's smoking crater, however, is actually a portal to the Sphere of Entropy, and the fumes which emerge from it are deadly; the Immortal Alphaks cannot direct them (they follow the winds, usually to Norwold) but can choose when they are released. In great, ugly caverns hollowed beneath the volcano—caverns decorated with ever-burning flames and tortured heroes—is the evil city of Revenge, where some 5,000 followers of Alphaks live. They serve his will and travel the world, accom-

plishing destruction and inflicting pain wherever they go. Some are well-known wizards and "heroes," keeping their association with Alphaks a dark secret. Others are men and women who have abandoned their normal identities to serve Alphaks full-time.

Regulations: Death or torture to non-worshippers of Alphaks who reach the island, to citizens of Revenge who abandon their allegiance to Alphaks, to anyone who angers Alphaks, or to anyone who angers the Black King (below).

Customs: Agents of Alphaks are recruited from the outside world and brought here for an initiation ceremony. In the ceremony, the agent promises faithfully to serve Alphaks to the end of his days. Just to make sure, the Black King uses a variant *geas* (actually a *wish*) on the subject, whereby if the agent ever breaks his oath he must immediately, secretly return to Alphaks' Island and declare his defiance to the Black King. Naturally, at that point the Black King and his court kill the wretch.



Sites: *Revenge*, the hellish underground city, as described above.

Personalities: Rulers of this land are *The Black King* and *The Black Queen*. Both were chaotic adventurers who devoted themselves to Alphaks' service. For their faithfulness, Alphaks "reconstructed" them—though still mostly human, they both appear as night-black silhouettes without facial features visible to the eye. Both are AC 0, HP 65, MV 120' (40').

The Black King (MU 36, C) is in charge of planning acts of hatred and vengeance against the Alphatians. He is 6'6", 250 lbs.; wears pure-white kilt, boots, vambraces.

The Black Queen (C 36, C, of Alphaks) is in charge of communicating regularly with Alphaks and getting his permission and recommendations on various deeds. She is 6'2", 175 lbs.; wears pure-white knee-length gown, boots, has pure-white hair to mid-back.

KINGDOM OF AMBUR

Population: 200,000 (including towns and cities).

Description: As described in *Book III, Players' Guide to Alphatia*, in the "Overview of Alphatia" chapter. Ambur itself is an ordinary Alphatian kingdom, with the exception of the peculiar occupations of the residents of the city of Starpoint.

Sites: The city of *Starpoint* is the kingdom's leading attraction.

Personalities: *Queen Elshethara* (MU 24, N) was a popular stage actress until ten years ago, when her parents decided to step down from the throne and she assumed it. Appearance: 5'7", 120 lbs. (willow-thin); common Alphatian coloration; dark brown hair and gold-brown eyes; fashionably neurotic mannerisms; wears striking, flowing garments all in black (she acted mostly in tragedies); age 40. She is currently conducting an affair of the heart with Lodun (see below).

Starpoint

Population: 40,000 (plus up to 10,000 visiting for the theatre).

Description: As described in *Book III, Players' Guide to Alphatia*, in the "Over-

view of Alphatia" chapter. Starpoint is dotted thickly with theatres and with astronomical observatories.

Customs: Starpoint is theatre-crazy, and everyone, including commoners who can afford it, goes to see a stage production as often as possible. Because stage stars are the national heroes, it is fashionable in Starpoint to affect artificial, neurotic mannerisms at social gatherings and when visiting the theatre.

Sites: The *Elshethara Theatre*, built by the Queen in her own honor five years ago, is a site to behold. There is no floor seating—the theatre consists of the stage, empty floor before it, and the opposite wall where 1,000 boxes (containing 4,000 boxed seats) are arrayed. The theatre, with its glorious decorations and its enormous staff of servants (one for every four boxes) cost a million gold pieces to build and tickets run in the 500 gp range for an evening's performance.

Personalities: *Lodun the Doomed* (MU 12, C) is the current favorite in the theatrical circuit. He is a handsome, self-absorbed, tragic personality who takes the term "neurotic" to new heights. He's conducting affairs of the heart with half-a-dozen great ladies, including the Queen (expect his obituary soon). He's also a great actor in historical tragedies (Acting skill on a 19). Appearance: 6', 170 lbs; "pure" Alphatian coloration (pale skin, dark hair); black hair (clean-shaven) and eyes; wears robes in solemn, sad pastel violet hues; age 35.

KINGDOM OF AQUAS

Population: 70,000 (60,000 in Seashield, 10,000 divided among outlying stations).

Description: The kingdom actually consists of little more than the domed city of Seashield and several smaller, outlying domes—colonies and scientific posts, mostly. A comparatively new kingdom, it began construction only 50 years ago with the blessing of Emperor Tylon IV, and the kingdom's founder is still king here.

Seashield consists of a gigantic crystal dome (built with hundreds of applications of the *stonewall* spell from the "Character Creation" chapter in *Book*

III) which was built on the surface and then slowly and carefully sunk, trapping atmosphere within it. The dome was then sealed to a carefully-prepared section of ocean floor with more *stonewall* spells and enchanted with *create air* spells so as to provide fresh air continuously.

The site chosen for the city is a stable shelf of bedrock where earthquakes are unknown. With judicious use of *disintegrate* and other spells, Seashield's wizards dug lower city levels straight out of the bedrock; all accesses to the lower city can be sealed with mighty watertight doors in case something happens to the dome.

A small, beautiful city was built under the dome, mostly consisting of high, high tower dwellings; the king has always encouraged colorful tower construction with much use of crystalline building materials.

Regulations: Injudicious use of *fire balls* or any other magic which might damage the city's protective dome and seals is grounds for (at least) exile; actual damage to the dome or seals results in stiff fines, perhaps confiscation penalties, and exile.

Customs: Seashield was intended to be, and is, a center for the development of new sea-monsters and study of existing ones; a place where mermen and other sea-sentients could mingle with the wizards of Alphatia; and as a center for the study of commercial applications of sea-life. So these subjects take up most of the attention of most of the kingdom's citizens. Regular tours of the surrounding ocean floor, in *undersea boats* (from the *Companion Set*) and other conveyances are conducted from Seashield.

Sites: The *King's Tower*, in the very center of the domed city, stretches from floor straight up to the dome. The roof of the Tower is the *Observatory*, and all citizens can gain access to it (without entering the tower) by riding up a *levitation* plate which serves as an elevator. In the Observatory, visitors can see dolphins, schools of fish and other sea-life as they pass by.

Personalities: *King Zyndryl* (MU 36, N) is the founder and king of Aquas. An adventurer and creative wizard, he persuaded old Emperor Tylon IV to let him



Atlas of Alphatia

have a stretch of underwater sea-shelf as his dominion—and, starting 50 years ago, turned it into the fascinating domed city it is today. On a visit to Sundsvall soon after Tylion's abdication, he caught the eye of the Empress—and she caught his. Their romance lasted a few years, ending amicably because their interests pulled them in different directions, and produced the children Eldrethila and Zandor. Zyndryl dotes on Eldrethila, can't stand Zandor. Zyndryl is handsome, unusually strong for an Alphantian wizard (Strength 16), keeps himself in excellent shape, and is somewhat vain about it—wearing tight-cut adventurers' style clothing (the tunics in spider-silk) to show off his physique. Appearance: 6', 180 lbs.; common Alphantian coloration; gold-blond hair and green eyes; prefers dark clothing (blues and purples); apparent age 30 (real age 80). He is not now romantically attached.

KINGDOM OF AROGANS —

Population: 150,000 (native, up to 50,000 visitors at peak of tourist season); includes city of Bluenose (population 50,000, up to 75,000 in tourist season).

Description: As described in *Book III, Players' Guide to Alphatia*, in the "Overview of Alphatia" chapter. It is a nation which thrives on tourism and caters to especially snobbish aristocrat visitors.

Regulations: Slaves and commoners may not even address aristocrats unless first recognized by them, under a penalty of twenty lashes; in Arogansa, non-spell-casters are supposed to be seen but not heard. (It's not a nice place for PCs who aren't spell-casters to visit—it requires a lot more discretion than a high-level fighter is usually able to maintain.)

Customs: Laziness is the national pastime among the tourists, so it is fashionable to pretend boredom and disinterest in any topic of conversation—no matter how interesting one might find it. It can be very frustrating for adventurers to try to talk to tourists in Arogansa, because they take so long to reply and seem to take so little interest in the characters' important doings.

Sites: *Bluenose Beach* is the fairest, cleanest beach in all Alphatia—and should be, considering all the work lavished on it. At dusk, when the tourists go home, hordes of worker-slaves are released to clean the place up, all night long, until the first glimmerings of dawn—with every new day, it's spotless.

Personalities: *Matteredy, The Arbiter of Taste* (MU 12, L) is a popular personality here. He's a self-appointed critic and wit who sets style, comes up with the most scandalous gossip, and essentially lives off the parties and soirees thrown by the adoring tourists. He's quite a snob, but is careful not to insult other magic-users—just commoners. Appearance: 5'9", 140 lbs; common Alphantian coloring; black hair and beard, brown eyes; sharp features usually twisted into an expression of mocking disdain; dresses in exotic and preposterously clashing robes of his own design; age 35.

KINGDOM OF Blackheart —

Population: 50,000 (including Shraek) (1% wizards, 40% townsmen, 59% slaves, servants, and victims of mad experiments).

Description: As described in *Book III*, this is an ominous, twisted, and unnatural forest kingdom founded by anti-social wizards—and for other such wizards—who just want to conduct their experiments, especially the more grisly and socially unacceptable ones, in peace. This kingdom is dotted with castles, towers, and underground lairs of wizards with their laboratories. The forests are filled with monsters who have escaped or been released from the labs. Since there are few laws here, it is a popular place for especially chaotic non-spell-casters to live—the local wizards can always find a use for a capable adventurer in this kingdom.

Regulations: The only crimes on the books include assault on the King or his family (death penalty), damage to the King's property (requires immediate recompensation, can result in death penalty if the King is angry enough). Nothing else is illegal in Blackheart—

you have as many civil rights as you can keep for yourself by magic or might of arms.

Customs: In spite of the kingdom's black reputation, carefully-cultivated politeness is the custom here—even between wizards who hate one another. When the veil of politeness drops, it's time for a fight—and, unlike other kingdoms in Alphatia, duels don't have to be fought under the protective aegis of a *duel-shield* spell in this country.

Shraek

Population: 20,000.

Description: This is a dark, gloomy city surrounded by a single curtain wall of blackest obsidian. By order of the King, the city's streets were laid out in twisting, winding patterns, constantly crossing and re-crossing, and buildings whenever possible are built with disturbing fashions of architecture. The population of Shraek consists mostly of the operators of its businesses, and of Chaotic mercenaries and adventurers employed by—or hoping to be employed by—the kingdom's wizards. The town is full of dark libraries (which charge substantial fees for visits), taverns and inns, meeting-halls, alchemists' and poisoners' shops, zongadens by the dozens, a very busy crematorium for disposal of the bodies of the recently deceased, sages' consultation offices, and other services useful to the kingdom's wizards.

Personalities: *King Hugorth the Misanthrope* (MU 36, C) is ruler here; he has a small villa in the city and a castle out in the wilderness somewhere (it's best not to ask where, as the city guards take a dim view of people inquiring after the King's doings). His nickname is quite accurate; he doesn't like humans. He hopes someday to create a sentient race which he *does* like (no magical super-power, he "creates" races by magically combining existing sentient races; he usually ends up with freaks and monstrosities and destroys the examples of his mistakes). Appearance: 5'5", 190 lbs (a tad hefty); common Alphantian coloration; brown hair and eyes; dresses in featureless, rum-

pled robes of any color, usually spotted with dribbles from the last few days' worth of meals; age 50.

KINGDOM OF FLOATING AR —

Population: 150,000 (including Skyreach).

Description: From border to border, Floating Ar is filled with floating islands—from as little as a hundred yards across to as much as several miles. Though the floating islands never crash, no human communities are ever built beneath them. Most communities are built atop the floating islands, and so the non-spell-casting human serfs are that much more dependent on their spell-casting rulers. The Kingdom was founded not long after Landfall by a mighty wizard named Ar, who spent his long life doing nothing more than enchanting these islands to float (each consists of hundreds or thousands of *stonewall* spells, from *Book III*, enchanted with *levitate* spells). The magical technique that went into their construction isn't that amazing—what astounds the other wizards of Alphatia is the amount of continuous work that Ar and his apprentices must have gone to to create this kingdom. (It is to be noted that part of Ar's motivation was one of the requirements for the path to Immortality of the Paragon—it's obvious that Ar *did* transform his entire land, giving it a unique appearance!)

Regulations: Pushing or shoving someone counts as Assault in these lands—because the Crown wants to discourage any shoving taking place at the edges of the great floating chunks of land.

Customs: Air-Ship regattas (boating competitions) are a popular pastime in Floating Ar.

Skyreach

Population: 25,000.

Description: Built atop a two-mile-diameter floating island (one of the largest in the land), Skyreach is a city for any air-related study. A branch of the Followers of the Air studies and teaches magic here. Shipyards for the creation of

Air-Ships and other flying vessels operate here. One or two former Thyatian Knights of the Air, lured by too much money, instruct the Alphatian military on the finer points of Thyatian air-cavalry tactics here. The city is surrounded by grasslands where pegasi graze, and pegataurs (see the "Monsters of Alphatia" section) often visit here.

KINGDOM OF GREENSPUR —

Population: 600,000 (including Eagret, population 100,000).

Description: As described in *Book III, Players' Guide to Alphatia*, in the "Overview of Alphatia" chapter. The largest military naval base in Alphatia is here, and dominates the city of Eagret and the rest of the nation.

Regulations: Greenspur is very paperwork-happy. Every sentient creature belonging to or visiting the nation is supposed to carry papers of identification indicating his name, origin, current employment, and (if an outsider) how long his visit may last. Kingdom and city guards may demand to see anyone's papers at any time to ascertain their business . . . but, typically, only do so when there is cause to believe something unusual is happening.

Customs: Greenspur does not accord more rights to non-spell-casters than other nations in Alphatia, but is more scrupulous about making sure that laws are enforced and trials of commoners are conducted fairly.

Personalities: *King Sildreth II* (C 24, I, of Alphatia) is the ruler here. He's an officious, no-nonsense, short-tempered perfectionist who has no time for mistakes, visitors with nothing to say, or entertainment (waste of time!)—but who does have a strong streak of justice and fair play in his psychological makeup. Appearance: 6', 150 lbs; olive skin tone (mother was of Thyatian descent from the Isle of Dawn); brown hair and blue eyes; dresses in blue and gold garments cut in military-uniform fashion; age 40.

KINGDOM OF HAVEN —

Population: 1,200,000 (including Aasla).

Description: As described in *Book III, Players' Guide to Alphatia*, in the "Overview of Alphatia" chapter.

Regulations: Willful destruction of art constitutes Assault on an Aristocrat in art-conscious Haven.

Customs: Mylertendal's philosophy of beautification began here and has never quite ended, so art of every sort is abundant in Haven. There are no large, flat surfaces (such as building or city walls) totally bare of some sort of art; the whole kingdom, especially the capital city of Aasla, reeks with color.

Sites: The *Queen's Castle* is some 50 miles north of Aasla itself; the queen has no interest in living in the teeming mass of humanity that is Aasla.

Personalities: *Queen Kryndylya* (C 36, N, of Kagyar) is ruler here. She is an artisan and collector of statuary, and has long been a friend of Mylertendal (see "Personalities" under "Aasla," below). Appearance: 5'5", 130 lbs; Pearl Island coloration, black skin, hair, and eyes (artificial—she uses a *disguise* spell to change her hue and retain her ordinary features, which would normally bear common Alphatian coloration); prefers golden robes decorated with much white lace; apparent age 35 (real age 65).

The Immortal *Alphatia* lived her human life under the name of Aasla—founder of this nation and city—and so she has special interest in the doings of Aasla and Haven.

Aasla

Population: 400,000.

Description: Aasla is the capital city of Haven, and is the greatest sea-port in all Alphatia. The city has a Foreign Quarter where traders from all sea-faring nations in the world can be found. And, to even a greater extent than the rest of Haven, Aasla is decked out in painting, sculpture, *phantasmal force* decorations, and other forms of art—so much so that you can hardly throw a rock without hitting a piece of art (or an artist).

Atlas of Alphatia

Customs: Among the aristocracy, as you might have guessed, art and the philosophies of Mylertendal are the national craze. Among the commoners, it's trade and travel.

Sites: The *Tower of Mylertendal* is the city's most famous site. It stands 60' in diameter and ten stories tall—not amazing by Alphatian standards, but still respectable—and its entire surface consists of small (10" tall, 5" wide, 5" deep) niches into which statuettes are placed. There are some 36,000 niches on the tower's exterior. When Mylertendal makes or receives a statuette worthy of display, she puts it in a niche, sealing it in place with a variant *wizard lock* spell she developed herself. Currently, about 15,000 niches are filled. She has constructed flying disks four feet in diameter that have stable floors and rails, and won't leave her estate grounds, but otherwise act as *flying carpets*; visitors are permitted to walk right onto her grounds and fly around looking at her thousands of beautiful statuettes, free of charge. Many of the statuettes here were crafted by Mylertendal, and many by the Queen; every sort of situation or character is represented, and Mylertendal may insist that interesting-looking PCs pose for her.

Personalities: *Mylertendal* (MU 36, L) is, as you've guessed, the most famous resident in Aasla. An artisan by nature, devoted to nothing but the beautification of her world, she was responsible for a philosophy of beautification which shook Alphatian culture some three hundred years ago and has never quite died out. A hundred years ago, she secretly began on the Path of the Paragon, with her artistic efforts constituting the Path's requirement for changing the lands around one's home; she is in no hurry, and will probably succeed in her quest. Appearance: 5'2", 110 lbs; common Alphatian coloring; hair white, eyes brown; wears brilliantly-embroidered gowns depicting all sorts of scenes and landscapes; apparent age 60 (real age 315).

KINGDOM OF LIMN

Population: 250,000 (including Trollhattan, population 40,000).

Description: Limn is a pocket of habitable land surrounded by high, jagged mountains in northwestern Alphatia. Limn is only about 150 miles from Alphaks' Volcano, and Alphaks' minions make Trollhattan their first stop when traveling into Alphatia—they blend in here better than anywhere else in the Empire. As described in *Book III*, Limn is a land where sentient non-humans of practically every variety walk among the nation's humans and demi-humans. One's neighbor may be a troll-baker or a dryad-wicca as commonly as anything else. The dwellings range from sophisticated Alphatian architecture to crude hole-dwellings dug out of the sides of hills.

Regulations: In Limn, any sentient species can be a citizen—though only spell-casters may be Aristocrats. Attacking a monster just because it's a "monster" may result in a conviction for assault (or murder) for the attacker.

Customs: The Show of Force is the most notable custom here. Citizens do not go out in the streets unprepared to defend themselves. People who *look* defenseless—even mighty magic-users—find it advisable to have bodyguards along, as it keeps others from thinking they are defenseless and provoking a fight. And because everybody is prepared for a fight, and no one looks like he's easy meat in a fight, combats are actually pretty rare.

Sites: The *Living Bestiary* is a vast zoo (covering some 200 acres) full of magical monsters living in large cages which simulate their natural environments. The most powerful are caged in areas with thick steel walls and *anti-magic* characteristics. There are some 800 different monster species represented here, and, for all the zookeepers' preparations, accidents and escapes are not uncommon—it's dreadfully hard to keep the cleverest and most powerful monsters caged, and the zookeepers are constantly hiring adventurers to go and acquire replacement

beasts, and to find and capture samples of newly-discovered monsters.

Personalities: *King Drushiye* (E10, Attack Class K, 3 attacks/round, N) and *Queen Mellora* (Dryad-Druid 10, N). Drushiye, about a hundred years ago, managed to convince the Emperor that rulership of his kingdom *should* be divided among two rulers—one for humans and demi-humans, the races accepted by the rest of Alphatia, and one for the other sentient races who are citizens only in Limn. When the Emperor accepted, he took as his mate and co-ruler Mellora, a powerful dryad druidess of the nation.

Appearance (Drushiye): 5'7", 135 lbs; black hair and eyes, slight golden tint to skin; prefers spider-silk garments in black and green; age 330 (apparent age: adult elf male).

Appearance (Mellora): 4'11", 90 lbs; green hair and eyes, pale white skin; prefers short-skirted spider-silk robes in green and white; age 200 (apparent age: adult dryad).

KINGDOM OF STONEWALL

Population: 1,600,000 (including Draco, population 550,000).

Description: As described in *Book III, Players' Guide to Alphatia*, in the "Overview of Alphatia" chapter.

Regulations: Though officially non-spell-casters are still Commoners and spell-casters are still Aristocrats, criminal law is identical for both classes of society here; all crimes are tried as if committed by Aristocrats on Aristocrats. Insolence is not a crime in this kingdom.

Customs: The atmosphere of Stonewall is comparatively friendly to non-spell-casters of every sort. Discrimination due to lack of magical ability exists here primarily among foreigners.

KINGDOM OF STOUTFELLOW

Population: 60,000 (50% dwarf, 25% halfling, 25% gnome) (including Denwarf-Hurgon).

Description: As described in *Book III, Players' Guide to Alphatia*, in the "Overview of Alphatia" chapter. This is a

rough, mountainous land settled by dwarves, halflings and gnomes, mostly families with one or more craftsmen in them.

Regulations: Laws and the government system are similar to those of Rockhome (see GAZ 6, *The Dwarves of Rockhome*). In particular: There are no written codes for crimes, though the sorts of activities regarded as crimes by the humans are regarded as crimes here. No distinction is made between spell-casters and non-spell-casters; the same laws apply to everyone equally. Punishments include such dwarven concerns as enforced idleness, exile, disinheritance, or convict labor.

Customs: Dwarves being the dominant species here, dwarven customs are the most common. Dwarves tend to be suspicious and close-mouthed around strangers they don't know—and they tend to take years and years to get to know you (but make exceptions for heroes with a reputation for being dwarf-friends).

DENWARF-HURGON

Population: 30,000 (90% dwarf, 5% halfling, 5% gnome).

Description: The dwarvish-language name of this place means Rockborn (Dwarf) Caverns, and it's in the great caverns under these mountains that most of the city (25,000) lives. Above the caverns is the open-air city where the rest of the citizens live. So, in the upper city, we have about 1,500 halflings, 750 gnomes, and 2,750 dwarves. In the lower, cavern, city we have about 750 gnomes and 24,250 dwarves.

KINGDOM OF THERANDEROL

Population: 200,000 (including Errolyn, population 30,000).

Description: This is a small, pretty kingdom featuring light forests and numerous lakes; it is the ancestral kingdom of the family of Emperor Tylon IV and Empress Eriadna. It is currently ruled by Eriadna's eldest child, Eldrethila.

Personalities: *Queen Eldrethila* (MU 30, L) is the daughter of Eriadna and

King Zyndryl of Aquas, and full sister of Prince Zandor. She grew up sweet but strong-willed—candy over a core of iron. She also grew up Lawful and organized, disliking chaos and court politics. When she was adult, she told Eriadna and Zandor that she would officially remove herself from contention from the throne of Alphatia (giving Zandor the best shot at it) if she could rule Theranderol, their family's ancestral kingdom. It was obvious to Eriadna that Eldrethila had no interest in the rule of so widespread and chaotic a land as Alphatia, and Zandor was all in favor of it, so Eldrethila became queen of her quiet nation. Appearance: 5'9", 135 lbs; common Alphatian coloration; red hair, green eyes; plain features but a striking and memorable manner; prefers modest garments in brown and gold; apparent age 27 (real age 37).

KINGDOM OF VERTILOCH

Population: 2,000,000 (including Sundsvall).

Description: As described in *Book III, Players' Guide to Alphatia*, in the "Overview of Alphatia" chapter. Vertiloch is a green and southern land with many small lakes upon it, colorful capital nation of the Empire.

Customs: Vertiloch is not handed down in a single family like rulership of most kingdoms. The kingdom is automatically ruled by the current Emperor or Empress of Alphatia. (This is because of an ages-old ruling that the Emperor must be a King or Queen; in a time when the best candidate had no dominion, the Grand Council of Wizards established that Vertiloch would be the kingdom of the current imperial ruler, so that that requirement would be met.)

Sites: Greatest site in Vertiloch is the city of *Sundsvall*, the imperial capital, described below.

Sundsvall

Population: 500,000.

Description: The City Built by Magic is a vast, sprawling metropolis radiating outward from Eriadna's Imperial Palace.

The city is made up of about 2,000 individual estates, each owned by an aristocrat or a wealthy commoner. Average population for each estate is about 250 residents; many have very few residents (50 to 100) while some are tenements densely packed (up to 1,000 residents). A map key and further description of Sundsvall follows below.

Regulations: Property in Sundsvall must be bought in complete blocks. Sale or purchase of a piece of property smaller than a city block is not permitted. A block may be built up as a collection or rental properties, of course—many merchants help make themselves rich by building tenements for commoners and gouging prices. Such people tend to be hated, but wealthy. Many blocks are un-walled and leased in pieces to various merchants for the operation of small businesses. Many blocks are themselves large businesses.

Personalities: Personalities of Sundsvall appear in the "Characters of Sundsvall" chapter.

Map Key of Sundsvall

The map on page 49 shows the city of Sundsvall. As you can see, it resembles a giant spiderweb radiating out from the Imperial Palace Complex.

The city is lit by *continual light* globes which line every major street—the globes, sitting atop tall poles, are shielded during the daytime and opened at night by commoner street workers.

In wealthier areas, the streets are kept meticulously clean by slave workers. In the lower-income areas, the city takes on a decidedly more shabby appearance.

The interesting sites of Sundsvall include:

(1) **The Imperial Palace Complex:** This is a huge walled enclosure, the size of nine normal city blocks. It includes the main Palace building, in the center; numerous outlying residential structures for the hundreds and thousands of Palace residents, servants, and slaves; a large landing field for Air-Ships, and stables for the horses and other beasts owned by nobles of the palace; government office

Atlas of Alphatia

buildings, where the business of ruling takes place; and the 60'-high curtain walls surrounding the whole thing.

(2) **The Aerodrome:** This is the large aerial port of Sundsvall, also a huge multi-block complex. It is surrounded by hangars for the Air-Ships, construction facilities for new Air-Ships, central landing fields, and debarkation areas for passengers.

(3) **The University of Sundsvall:** This entire block consists of one mammoth 20-story building which houses the entire University, where magic is taught to the budding magic-users. Housing is not on-campus (i.e., in the building).

(4) **University City:** These blocks, surrounding the University, are businesses including housing areas, taverns, outdoor cafes, and other services of interest to university students.

(5) **Artisans' Square:** This block, bought by a philanthropist and kept empty by him, is a place for artists of every variety to set up booths and tables and display and sell their goods. Commoners and Aristocrats alike set up shop to show their talent. Every table and display area must be taken down at full dark, and the owner's slaves clean the block up at night.

(6) **Chime Tower:** In this tall, narrow tower, home of an eccentric wizard de-

voted to the *sphere of time*, is the world's largest *chime of time* (*Dungeon Master's Companion*, page 53). It is 100 times the size of the ordinary 3' variety, being 25' long, and being audible in a diameter of 6,000' (over a mile). It is always kept on the first command, so that it chimes the hour, on the hour.

(7) **Fire-Slayers:** This is a government-paid enclave of clerics and magic-users whose job is to put out fires which spring up in the city. They use *teleports* and fast-moving aerial transport to the site, then use spells such as *create water*, *ice storm/wall*, and so forth to put put the fires out.

(8) **The Jangles:** These many blocks house commoners' businesses: Offices, taverns, shops, small markets, businesses for any sort of commoners' concern. At night, it becomes a place for pub-crawling and other entertainments, and a place where aristocrats often go "slumming."

(9) **Fire City:** This is the nickname for several score blocks of the most densely-occupied tenement areas in the city. Because they are built up so high (10 to 20 stories) and in such an uncaring fashion, because they are so thickly occupied, fires are common and very dangerous—in spite of the magical efforts of the city's fire-fighters.

(10) **The Pits:** This is the worst area in Sundsvall—blocks where the owners, by

collaboration and cooperation, maintain the most seedy of businesses—including the zzonga-pits which gave the area its name. It is a place where aristocrats will only go when they are looking for someone . . . or when they themselves are zzonga addicts.

(11) **Hard-Ball Arena:** This large arena seats 50,000, and features hard-ball practice sessions and tryouts through most of the week and two real matches every Flajhur (Nytdain) night.

It would be impossible to describe all the other sites of the city. Most of the northern half of the city consists of estates of the wealthy (generally wizards, clerics, and some elves, but occasionally wealthy Gentry as well). Each such estate has its own walls, several buildings within, and a population which can be as low as 50 or as high as 1,000—though the latter is very uncommon, 250 being the average.

Much of the southern half of the city consists of dwellings and businesses of the middle class and poor—that includes middle-class and poor Aristocrats, too. Most of the city's business takes place in the city's southern half, and wealthy aristocrats are often seen in southern streets, shopping for rare ingredients, arranging loans with the banks of the Gentry, and so forth.

THE CITY OF SINDSVALL

Population: 100,000
Established: 1000 AD

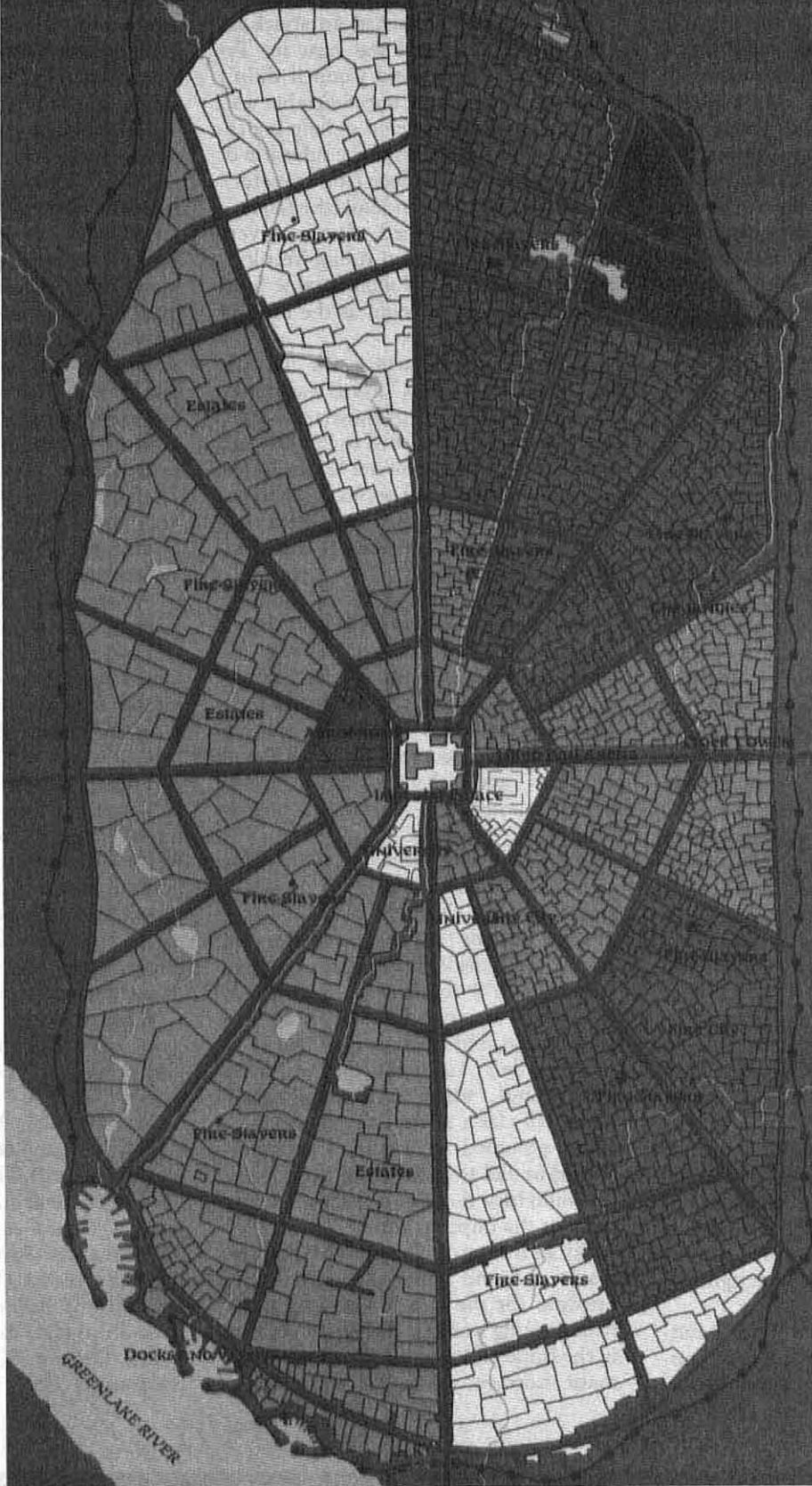

Characters of Sundsvall

Following are the some of the best-known personalities of Sundsvall—the Imperial Family of Empress Eriadna—and others from the imperial palace whom the PCs might someday encounter. As with the “Characters of Thyatis City” section, no spells are listed for the mage characters—see the Appendix section at the back of this book to determine the spells that these characters are likely to be carrying at any given time.

Eriadna the Wise

Empress of Alphatia

History: Born about 80 years ago in Sundsvall, Eriadna is the only child of Tylion IV, the previous emperor. Unlike her father, she was reared from birth in the duties and rights of a ruler-to-be. She was not precisely spoiled as a child: By Tylion’s decree, anything she wanted was hers . . . but the consequences of any of her requests were always impressed on her. When a commoner accidentally insulted her by omitting her title when addressing her, she complained, and the man was punished . . . but she was forced to watch the trial and punishment. When she wanted a grand birthday celebration for herself to be a holiday through all Sundsvall, Tylion complied . . . then taught her how to calculate the cost of the event to the imperial treasury, and showed her what those funds might otherwise have gone to. In this way, she learned of the far-reaching consequences any of her actions might have, and learned to think through all her decisions and desires before pronouncing them.

This is why her alignment is given as Neutral. In spirit, she’s as Chaotic as most Alphatian magic-users. Her personality, her veering style of conversation (which skips from interest to interest, event to event), and her mercurial moods are all very typically Chaotic. But her strict upbringing in her responsibilities has made her very duty-conscious—a Lawful trait. Chaotic by nature, Lawful by design, she “reads” as Neutral.

Through her youth and early adulthood, she saw her father grow increasingly frustrated with the throne—and

especially with the Empire of Thyatis. When Tylion IV launched an attack on that Empire, the end was near for Tylion’s reign—the Grand Council didn’t want an Emperor so unpredictable and dangerous. So she offered to help her father by taking the reins of the rulership of the kingdoms of Vertiloch (the Emperor’s dominion) and Theranderol (the family’s dominion). He agreed. She was very showy and public when ruling Vertiloch and Theranderol, and soon became fixed in the population’s mind as the ruler of those countries.

When Tylion’s attack on Thyatis failed, and later when Thyatis was able to reclaim all its lost Isle of Dawn territories, the Grand Council turned to Eriadna and avowed their support of her for the imperial throne if she could persuade Tylion to step down. If he didn’t—well, there were some Council wizards ready to duel him just to get rid of him.

She persuaded her father to abdicate. The man was tired and broken; it wasn’t difficult. And so Eriadna, called the Wise, became empress of the greatest empire in the world. In the nearly forty years since, she has ruled well. She has learned to spot people with the ability to organize—and with a loyal spirit—and so her government is a relatively smoothly-functioning machine.

She has had relationships with many great and charismatic men of Alphatia, and borne five children: Eldrethila (age 37) and Zandor (35) to King Zyndryl of Aquas, and Ericall (30), Mariella (20) and Tredorian (17) to General Torenal. By agreement between Eriadna, Eldrethila and Zandor, Eldrethila is now Queen of the family’s ancestral dominion of Theranderol, while Zandor has abandoned all claim to that kingdom and is being groomed as Eriadna’s successor; should he fail to meet up to her criteria, he would have no claim either on Theranderol or the imperial throne.

Ericall is king of Norwold; Mariella remains at home under the stern eye of Eriadna, for she is a foolish and headstrong young woman; and Tredorian lives in the Imperial Palace of Thyatis, a diplomatic hostage, while his counterpart,

Princess Asteriela of Thyatis, lives in the imperial palace at Sundsvall.

Personality: Eriadna would prefer to be able to spend all her time in magical, personal, and romantic pursuits. Unfortunately, the demands of ruling the Empire tend to get in the way of that. So she executes her duties in the shortest and most efficient ways possible and then goes back to pleasing herself. Eriadna likes theatre and music, air-ship races and demonstrations of newly-created monster species. And she has a well-known weakness for capable, attractive men, even commoners. It’s one of the great disappointments of her life that General Torenal is without any strain of magical ability, and all of the children he fathers are likewise crippled. She is capable of great cunning in diplomatic dealings, but would prefer not to be put to that sort of effort: Anyone who forces her to exert herself like that is sure to incur her dislike, and eventual retaliation.

Appearance: Eriadna is a beautiful woman of common Alphatian ancestry: 5’, 105 lbs; mahogany-brown hair and green eyes; delicate, expressive features; dresses in costly spider-silk gowns, chiefly gold and trimmed with ruffles; apparent age 30 (real age 80).

DMing Notes: Eriadna is ruler of all Alphatia and Emperor Thincol’s opposite number in practically every respect. She is witty, gay, and would prefer to keep diplomatic treachery at a distance whenever possible. She is not ordinarily accessible to PCs at lower levels, but Name-level mage, cleric, and elf adventurers might easily become regulars at her court.

Combat Notes: 36th-level Mage; AC 5 (*ring of protection* +4); hp 50; MV 120’ (40’); #AT 1; D 2-12 (2d6) (*staff of wizardry*); Save F36 +4 (from *ring of protection* +4); ML 6; AL N; S9 I18 W15 D12 Co9 Ch16. Languages: Alphatian, Alignment (Neutral), Thyatian, Elvish (Shiye), Thothian. General Skills: Alternate Magics (I), Planar Geography (I), Knowledge of Alphatian Government (I), Codes of Law and Justice (W), Detect Deception +3 (W+3), Riding (Horse) (D), Piloting (Air-Ship) (D), Acting (Ch), Bargaining (Ch), Deceive (Ch), Leadership (Ch), Persuasion (Ch).



Magical Items in Possession: *ring of protection +4, ring of spell turning, staff of wizardry.*

ZANDOR

Prince of Alphatia

History: Zandor is son of Empress Eriadna and King Zyndryl of Aquas. He grew up burning with the knowledge that someday he would rule all Alphatia, and nothing would stand before him. He has dedicated himself to becoming a great wizard and politician—and, to his mother's dismay, he has studied the tactics and writings of Thincol of Thyatis with great interest, finding much there to emulate.

Personality: Zandor is chaos in motion. He's constantly moving and hates to sleep—consequently, he always looks a little thin and tired, and was never a powerful physical specimen to begin with. He's contemptuous of non-spell-casters, except those who (like Thincol) are great thinkers in spite of their handicap. He has an active distaste of his half-brothers Ericall and Tredorian, and looks on his half-sister Ma-

riella as nothing but trade goods. He's a Follower of Air and is fascinated by all sorts of aerial magics; he owns an estate in Floating Ar, has a griffin to ride and a huge, mighty air-ship for long-distance transportation. He even borrowed enough funds from his mother's personal treasury—with her slightly-belated permission—to construct for himself a great flying castle, and stocked it with all sorts of monstrous minions (see *M2, Vengeance of Alphaks*, for details on this). He's so sure that he will one day rule Alphatia that it is as a holy crusade to him—and woe to anyone who expresses a different opinion. Zandor has duelled several wizards to death (no Grand Masters, so far) for failing to show him the respect he deserves—in his mind, all that takes is expressing an opinion that someone else might be a better emperor than he.

Appearance: 6', 140 lbs; common Alphatian ancestry; brown hair and eyes; thin, sharp features, always in motion, nervous mannerisms; wears knee-length Alphatian robe, trousers in sky-blue, belt, gloves, boots and cloak in white; age 35.

DMing Notes: Zandor is a genuine crazy, but it will be some time before the Alphatian Grand Council of Wizards realizes this (all it will take is Zandor killing one of their number in a duel). He wants to rule the Empire more than anything, and he wants to fly all the time just less than that. He will be fascinated by any spell-casting player-character who has some new flying toy or technique for aerial movement, or knowledge of the Elemental Plane of Air, or anything of the sort, and will try to ingratiate himself to that PC—to learn his techniques, and to gain himself another supporter for his eventual rise to the throne.

Combat Notes: 30th-level mage; AC 4 (Dexterity bonus and *ring of protection +3*); hp 35; MV 120' (40'); #AT 1; D 2-12 (*staff of power*); Save M30 +3 (from *ring of protection +3*); ML 3; AL C (*very*); S10 I17 W6 D17 Co8 Ch12. Languages: Alphatian, Alignment (Chaotic), Elvish (Shiye), Thyatian. General Skills: Alchemy (I), Alternate Magics (I), Engineer (I), Knowledge of the Plane of Air (I), Magical Engineering (I), Planar

Characters of Sundsvall

Geography (I), Piloting (Air-Ship) (D), Piloting (Flying Castle) (D), Riding (Horse) (D), Riding (Griffon) (D), Persuasion +2 (Ch +2).

Magical Items in Possession: *ring of protection +3, boots of levitation, staff of power, stone of air elementals.*

Mariella

*Princess of Alphatia
(alias Hyldeborg)*

History: Mariella was born 20 years ago, second child of Eriadna and Torenal. Like her brothers Ericall and Tredorian, she has no magical ability at all and grew up treated much as a child handicapped from birth. She came to expect continual special treatment, and grew up haughty, spoiled, and childish.

Personality: Mariella gets what she wants, and she wants a lot. She wants attention, clothes, attention, jewelry, attention, servants, and her own way. She is also distinctly jealous of her mother's beauty and political and magical power and rebels at her mother's orders and guidance at every opportunity.

When "Baron" (King) Norlan of Qeodhar visited the imperial court at Sundsvall to woo her, she was so delighted with Eriadna's dislike of the man that she immediately "fell in love with him." Since his reluctant return to Qeodhar she has conceived of a plan to run away from home and be with him, and is in the process of creating an alternate identity—that of a Northern Reaches woman named Hyldeborg—in whose guise she can travel secretly to Qeodhar.

If there is anything Mariella cannot stand, it is being treated as an inferior—at anything. Even if she is learning to play a game for the first time and is beaten, the other player cheated.

Appearance: Unfortunately for the world at large, Mariella is very attractive and compelling. A lot of her attraction is learned behavior—it helps her get whatever she wants, after all. From Torenal's blood, she has the "pure" Alphatian coloration of pale skin and dark hair. She is 5'4" and 125 lbs.; black hair and violet

eyes; sultry looks; dresses in violets and reds; age 20. As Hyldeborg: Hair long, blonde, and plaited (wig). She carries a medallion which bears her true name and ancestry, and has some other interesting functions (see below).

DMing Notes: Mariella is pure trouble in a very attractive package. She's likely to run away from home one fine day, straight into the arms of the player-characters, and give them a lot of gold to conduct her secretly to Qeodhar—more gold than such a trip is worth. Alternately, she might try to run away and be captured by agents of some foreign power (*not* Thyatian—they've done that once already, never again), prompting the Empress to send special agents (including the PCs) after her. As yet another nasty option, she could run away to begin her trip to Qeodhar, bump into the PCs, and immediately fall in love with one of *them*—with a mage if you only want to make one character's life a living hell, or with a non-MU if you want Empress Eriadna angry at everyone.

Combat Notes: Normal Woman; AC 5; hp 3; MV 120' (40'); #AT 1; D 1-4 (dagger); Save F1-1 +4 (from her *medallion*); ML 3; AL C; S10 I9 W6 D12 Co8 Ch18. Languages: Alphatian, Chaotic (Alignment). General Skills: Acting (Ch), Deceive +1 (Ch +1), Persuasion (Ch).

Magical Items in Possession: *Mariella's Medallion* has the powers of: a *ring of spell turning*, a *ring of protection +4*, a *ring of life protection*, and a *scarab of protection*. Empress Eriadna had her father craft this and give it to Mariella (who wouldn't have taken it from her mother) in order to protect her from herself—the medallion may just save Mariella from some wizard's certain anger long enough for the girl to identify herself. It is engraved with Mariella's name (and "If found, return to the Imperial Palace of Alphatia, Sundsvall, Vertiloch"), and the engraving cannot be marred by someone who steals the medallion for his own use.

Tylion IV

Former Emperor of Alphatia

History: Born 120 years ago to Tylari III, the last Empress, Tylion seemed to have all the right personality traits to be a good Emperor—he was intelligent, as properly chaotic as any good mage, and as appropriately dutiful as a ruler needed to be. He took the throne in AY 1919 (AC 919), when Tylari disappeared on her quest for Immortality, and ruled well for many, many years.

But, like many a leader before him, Tylion was worn down by his responsibilities. The never-ending strain of rule made his temper short and decision-making abilities uncertain. He became more and more reactionary in his political dealings. He made a lot of bad decisions and a lot of enemies.

When, in AY 1959 (AC 959), the Thyatian emperor Gabrionus V broke a long-standing trade agreement, it was the last straw for Tylion. He ordered an all-out attack on Thyatis. Unfortunately for him, all the people he'd offended over the last few years failed to respond to his order. The attack on Thyatis was, after early success, beaten back, and the Alphatians lost every bit of territory they'd gained . . . all for nothing.

The Grand Council of Wizards backed Tylion's daughter Eriadna when she recommended that he step down from the throne. This he bitterly did.

But his forced retirement was a blessing in disguise. He eventually became philosophical about the whole thing. He had time for his hobbies, including the creation of small familiar-creatures and the adopting of new identities.

Over the years, using *impersonate* spells, Tylion has built up quite a number of alternate identities—over sixty at last count. In his alternate personae, he travels, makes new friends, and sees new sites, all without the relationship baggage he picked up while he was Emperor Tylion IV. Several people know some of his identities; only he knows all of them.

One of his personae is that of Master Terari, a teacher of magic in the Imperial

CHARACTERS OF SUNDSVALL

Palace at Sundsvall. Terari has been around so long—thirty-odd years now—that no one remembers that his origin is a mystery. Terari teaches the basics of magic to special visitors to the Palace, work which Tylion finds particularly rewarding. Not even Eriadna knows her father is also Terari.

Within the last few years, Tylion was invited into the Grand Council of Wizards—he'd been eligible for 80 years, but current emperors may not sit on the council, and after his abdication he was so disliked that the invitation was long in coming. He accepted, and is now a member of the government body which regulates the powers of his own daughter.

Personality: These days, Tylion is a very settled and relaxed individual, a stark contrast to the raw-edged and violent-tempered Emperor he was forty years ago. He enjoys teaching, making friends of people who do not know that he is Tylion, and traveling to interesting places—though he does not adventure. He likes creating small monster-types and showing them off. He has grown thoughtful and introspective enough that he perceives flaws in the Alphatian way of life, and is no longer disparaging of non-magic-users. He loves his daughter, but doesn't care for most of *her* children—excepting Tredorian, whom he thinks has some potential as a human being. He does like the Empress' new ward Princess Asteriela, and the Princess' lady-in-

waiting Galatia. He has recently decided to undertake the Path of the Epic Hero—one path to Immortality which would not separate him from his mortal family for too long during its accomplishment.

Appearance:

As Tylion—5'8", 140 lbs; common Alphatian coloration; brown hair and expansive beard, golden-brown eyes; solemn, intelligent features; wears spider-silk robes in royal purple and gold; apparent age 40 (real age about 120).

As Terari—6'2", 160 lbs; common Alphatian coloration; solid grey hair and beard, dark brown eyes; sharp, inquisitive features; wears plain brown cotton robes; apparent age 60 (real age about 120).

DMing Notes: Tylion, in one of his numerous alternate IDs, could become a patron and even friend of the player-characters . . . although he would not accompany them on adventures. It would not be possible for them to learn his true identity until they reached high level—at least 18th. As Master Terari, he could be the mentor of one of the PC magic-users.

Combat Notes: 36th-level Mage; AC 6; hp 60; MV 120' (40'); #AT 1; D 1-6 +6 (from Strength bonus and *staff* +5); Save F36; ML 7; AL N; S13 I18 W11 D10 Co14 Ch15. Languages: Alphatian, Alignment (Neutral), Elvish (Shiye), Nixie, Pixie. General Skills: Knowledge of Bestiary +2 (I+2), Animal/Monster Biology (I), Veterinarian (I), Alchemy (I),

Alternate Magics (I), Artisan (Small Humanoid Sculpture/Design) +2 (I+2), Teaching (Magic Instruction) (I), Animal Trainer (W), Riding (Horses) (D), Acting (Ch), Persuasion (Ch).

Magical Items in Possession: *ring of spell storing* with six *impersonate* spells (made by Tylion), *ring of protection* +3, *flying carpet*, *staff* +5.

TORENAL

General of Eriadna's Guard

History: Torenal was the son of an Imperial Palace slave; he was born in AY 1945 (AC 945). He was himself a slave, but was freed in AY 1963 by Tylion, who saw that the youth had great potential and didn't need to be kept in chains for the rest of his life.

Torenal immediately entered the Imperial Guard and made quite a career of it. He learned everything the old guardsmen had to teach him, which wasn't enough, and then hired hard-bitten foreign mercenaries, street acrobats and tumblers, even thieves and assassins to teach him as many forms of combat as he could learn. He became a remarkable combatant and rose rapidly through the guard's ranks.

And he attracted the eye of the Empress. He was, after all, strong, graceful, handsome, and devoted to her continued well-being. If only he had some ounce of magical potential . . . but he didn't, and

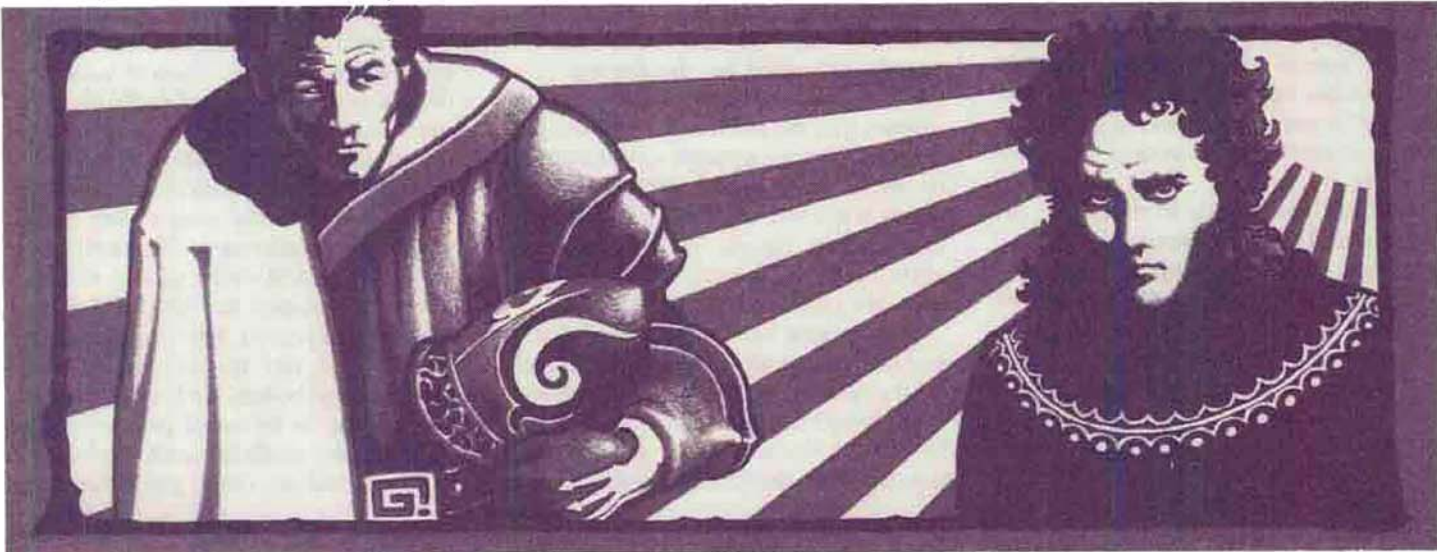

Characters of Sundsvall

that failed to keep the passionate Empress from having a relationship with the man which has continued, erratically, for over 30 years.

Torenal has become general of Eriadna's Guard. Eriadna has borne three children by him (Ericall, Mariella, Tredorian), all hopelessly non-magical, and he has sired children on other women (one such child is the grotesque Lernal, governor of Landfall in Norwold).

Personality: Protecting Eriadna's person, avenging slights to her, and keeping her affections (as much as he may) are his greatest motivations. He has heard many things about the brilliant fighting ability of Emperor Thincol of Thyatis, and, believing that someday the Alphatian/Thyatian quarrel must come down to a confrontation between Thincol and Eriadna, he has trained himself to be able to beat Thincol. Whether he can or not is anyone's guess . . . but he has as good a chance as any great fighter.

Appearance: "Pure" Alphatian appearance (pale skin, dark hair); 6'4", 220 lbs.; black hair (clean-shaven) worn to mid-back, and black eyes; broad, handsome, theatrical features; wears the colorful red, yellow, and black uniform of the Imperial Guard; apparent age 35 (real age 55).

DMing Notes: In a campaign, Torenal is the menacing figure always to the side of the Empress, ready to lay down his life for her—and even more ready to lay down someone *else's* life for her. While characters are well-liked by the Empress, they're Torenal's best buddies. But characters who oppose the Empress are Torenal's enemies, and they'd best never attack or insult her in person—for he'll be there.

Combat Notes: 36th-level Fighter; AC -4 (from Dexterity Bonus, *plate mail* +2, and *shield* +2); hp 120; MV 90' (30'); #AT 4; D 2d6+8 (Grand Master with the normal sword), with an additional +6 (for Strength Bonus and *normal sword* +3; Save F36; ML 12; AL N; S18 I13 W10 D17 Co16 Ch18; Languages: Alphatian, Alignment (Neutral), Thyatian. General Skills: Intimidate (S), Muscle (S), Wrestling (S),

Military Tactics (I), Acrobatics +3 (D+3), Alertness (D), Hard-Ball (D), Piloting (Air-Ship) (D), Riding (Horse) (D), Leadership (Ch).

Magical Items in Possession: *plate mail* +2, *shield* +2, *normal sword* +3, *ring of spell turning* (the last a present from Eriadna).

Asteriela TORION

Princess of Thyatis

History: Asteriela was born 21 years ago, third and last child of Emperor Thincol and Empress Gabriela of Thyatis. She, like her sister Stefania, was groomed to be a handy parcel to be married off for a good imperial alliance . . . and she, too, made noises of rebellion when it came to be time for her to be betrothed. The older and slightly wiser Thincol, after his experiences with his oldest daughter, held off on the betrothal, waiting until Asteriela came around to accepting his more informed decisions of her own free will.

In the meantime, some foolish agents of Thincol's were able to kidnap Eriadna's youngest son, Tredorian, from the city of Alpha in Norwold. Thincol didn't want this, but couldn't just send the boy home when Eriadna demanded it—that would be a considerable loss of prestige for him. So, instead, he sent his own daughter Asteriela to Alphatia, to be a counter-hostage; Asteriela liked the idea, and it certainly helped save face for Thincol.

So she came to Sundsvall, and was warmly welcomed by the Empress . . . and the Empress' father Tylion soon discovered that the girl had the potential for magic. Given the opportunity of learning to wield magic, and thereby having power in her own right when it came time to return to Thyatis, or not, and once again being her father's chattel upon return, she chose to learn.

She has now been in Sundsvall a year, and she has quickly grown to love the colorful city and the undemanding and less-than-sinister Empress. Though she loves her father, she fears him, and her relationship with the Empress is much more

comfortable and supportive . . . so her loyalties are shifting toward Eriadna.

Personality: Asteriela is bright and energetic, a sponge for Alphatian culture. Because she is beautiful, uncritical of the Alphatians, and charming, she is becoming quite popular at Eriadna's court—a revelation for the courtiers who'd always thought of Thyatians as coarse barbarians, and so a beneficial side-effect for Thincol.

Appearance: 5'5", 125 lbs; gold-blond hair, dark brown eyes; fair complexion (from her father's side of the family); prefers Thyatian clothing styles, and is introducing many to the Alphatian court; age 21.

Combat Notes: 4th-level Mage; AC 9; hp 12; MV 120' (40'); #AT 1; D 1-4+1 (*dagger* +1); Save F4; ML 8; ALL; S8 I17 W15 D12 Co10 Ch15. Languages: Thyatian, Alignment (Lawful), Alphatian, two others not yet learned. General Skills: Detect Deception (W), Riding (Horse) (D), four others not yet chosen.

Magical Items in Possession: *dagger* +1.

Galatia Allatريان

Lady-in-Waiting

History: Galatia is from the Isle of Dawn and is of Alphatian descent. Her cousin, Countess Julia Kendasius, the ruler of Kendach on the Isle of Dawn, brought her to Thyatis City during a normal state visit and presented her (introduced her) to Emperor Thincol. Though she was very young, Thincol could see that Lady Galatia would probably blossom into a very lovely woman, so he contrived to have Galatia made a lady-in-waiting to his daughter Asteriela.

Asteriela initially wasn't very happy about this arrangement. She well knew her father's mind on the subject of beautiful young women and was tired of having the Emperor's pet projects being shoved into her service. But Galatia turned out to be fun, no brainless beauty just waiting to be called into service by Thincol. She made her own clothes and designed striking exotic gowns for Aste-



riela, just at a time when Empress Gabriela had been trying to subdue Asteriela's outgoing nature and love of spectacle. Galatia had been all over the Isle of Dawn and had many interesting stories to tell about that fascinating island, where two great islands rub up against one another; she encouraged Asteriela on all sorts of escapades, such as dressing up as peasants and traipsing through Thyatis City unguarded. In short, she got the two of them in a lot of trouble, which infuriated Thincol and delighted Asteriela.

When Asteriela was bartered off to be a hostage in Sundsvall, Galatia was only too happy to go with her. She wasn't quite as Alphatian as she thought, however, and had some trouble adjusting to the ways of the Alphatian Empire . . . but Eriadna asked old Master Terari to find out if she had magical potential, and, if she had, to develop it. She did, and Galatia was saved from the pathetic life of a magic-less servant in the great palace in Sundsvall.

Personality: Galatia is a clever and energetic girl who is so used to being clever that she's not aware that she's inexperienced and gullible. She's used to making

basic assumptions about the way the world works, assumptions which are being challenged and broken the longer she lives in Sundsvall. The idea that someone would lie to her for any reason is just alien to her, so she is prey to tricks and confidence schemes. On the other hand, she is very talented, and never makes the same mistake twice—and is never fooled by the same trick twice—so she promises to become a knowledgeable mage and capable stateswoman some day. She is fond of hijinks and mad escapades and is always getting into some trouble or another in the eyes of Empress Eriadna, but brings welcome brightness into the imperial court and is seldom punished.

Appearance: 5'3", 100 lbs; red hair and brown eyes; coppery common Alphatian coloration; designs and wears very stylish, elegant robes and gowns; age 21.

Design (I + 1), **Artisan** (Color Sketch Artist) (I), **Knowledge of the Isle of Dawn** (I), **Mapping** (I), **Knowledge of Sundsvall** (I), **Knowledge of Thyatis City** (I).

Magical Items in Possession: None.

N; S9 I18 W11 D12 Co10 Ch15. **Languages:** Thyatian, Alphatian, Thothian, Elvish (Shiye-Lawr dialect), **Alignment** (Neutral). **General Skills:** Artisan (Clothes

DMing Notes: Galatia is a contact between low-level player-characters and the world of the imperial court at Sundsvall. She's always going out into the city in disguise, sometimes with Princess Asteriela. Should Asteriela need something from the "outer world" (i.e., the world outside the palace complex), she'd send Galatia for it. For example, the princess might need a spy hireling (such as a player-character Thief or Rake). She might want a specific magic item or book which Master Terari doesn't want her to have (meaning that PCs would be hired to acquire such a thing). More dangerously, the princess might fall in love with someone not in favor with the imperial court, meaning that she hires the PCs to smuggle that exile into the palace complex for their trysts. In all these cases, Galatia would be the trusted go-between hiring the services of the PCs. A romance between a player-character and Galatia would bring the PCs into constant contact with the world of the court, perhaps bring them under the eye of Eriadna, who is always in need of capable but *discreet* adventurers of all character classes.

Combat Notes: 2nd-level Mage; AC 9; hp 7; MV 120' (40'); #AT 1; D 1-4 (dagger) or by spell type; Save MU2; ML 6; AL

MONSTERS of Alphatia

In a land as rife with magic-users as the Alphantian Empire is, it would be pointless to try to describe which monsters from the D&D® rulebooks are present and which are not.

Because there are so many magical zookeepers and creature-creators about, as a rule of thumb, consider that every Prime Material Plane creature shown in the D&D rulebooks is represented somewhere in the empire—and some from the other planes, as well.

This doesn't mean they're around in abundance. There's probably not a place in the world, for instance, where you'll find beholders in abundance. But if a creature exist, it probably has been *gated* in, *summoned* in and then replicated by Alphantian magic, or even created in the first place by some mad wizard.

As a second rule of thumb, figure that the stranger and more horrible creatures appear only in very small numbers and in very few places. You'll find them in the estates and dungeons of powerful MUs, and often in the deep forests of Blackheart. In common areas inhabited by

many humans, you won't find many monsters—when you do, they're the exception, not the rule.

Here, then, we'll talk about monsters common to Alphatia but very rare elsewhere.

Pegataur

(From M2, *Vengeance of Alphaks*)

Armor Class: 5 (or better)

Hit Dice: 5*-15***

Move: 180' (60')

Flying: 360' (120')

Attacks: 2 hooves, 1 weapon or 1 spell

Damage: 1-6/1-6/by weapon or spell

No. Appearing: 2-20

Save As: Elf of level = to HD (maximum 10), or Monster at HD, whichever is better

Morale: 8

Treasure Type: E

Alignment: Neutral

XP Value (by HD): 5* - 300; 6* - 500; 7* - 850; 8* - 1,200; 9** - 2,300; 10** - 2,500; 11** - 2,700;

12** - 3,000; 13*** - 4,200;
14*** - 4,500.

Pegataurs were created by some mad wizard in the city of Shraek. The identity of the race's creator is not known—he's not admitting to his deed. Pegataurs were created from the unholy bonding of pegasi and Shiye elves; the result looks like a centaur with pegasus wings and elven features. Once created, the pegataurs were released to form their own communities; perhaps their creator is keeping an eye on them to see what happens to them.

Pegataurs are rare, mostly confined to the forests of Blackheart and Shiye-Lawr and some inaccessible floating lands in Floating Ar. They have an affinity for pegasi and are able to converse with them. Any group of fewer than five pegataurs may be accompanied by at least twice that number of pegasi 40% of the time.

Pegataurs speak these languages: Elvish (Shiye dialect), Alignment (Neutral), Alphantian, Pegasus, Horse, and Griffon.



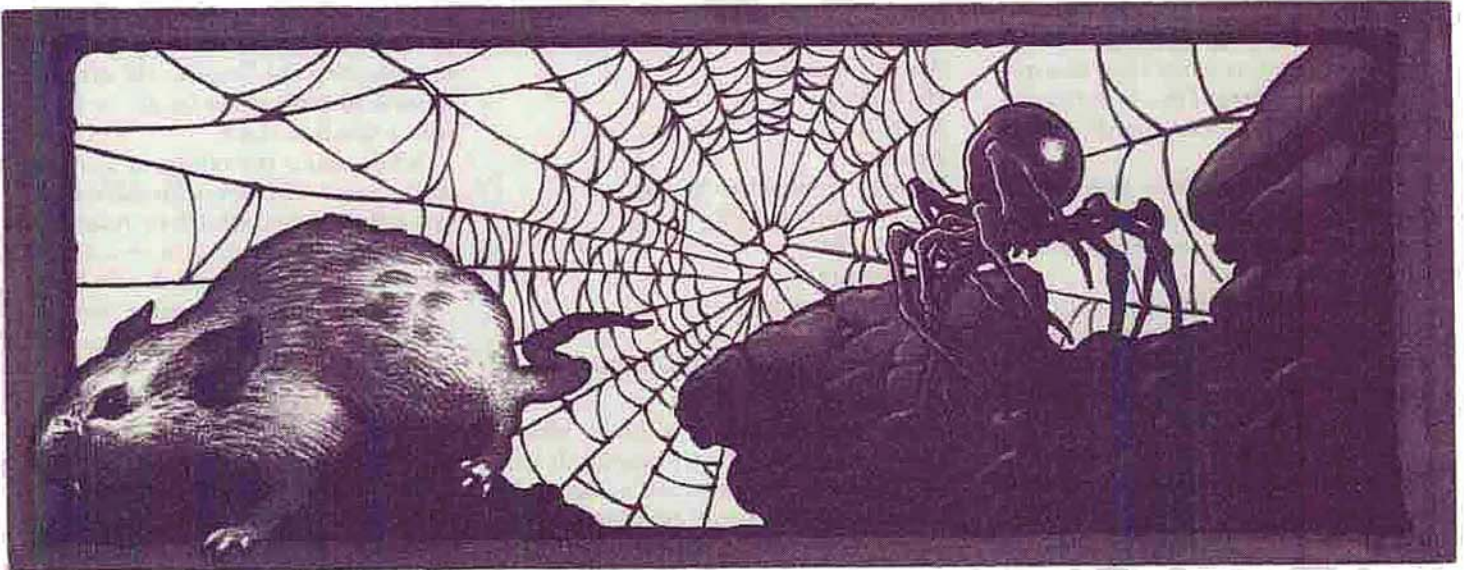

Although pegataurs are generally aloof, especially toward non-flyers, their neutral alignment makes them approachable. If treated with respect and paid well, they can be hired by anyone as troops for garrisons or armies, or to perform special services. Individual pegataurs do not join adventuring parties.

Most pegataurs should be treated as first-level elves. Thirty percent of the race, however, are of a higher level, up to the elvish maximum of 10th level. (Thus, a 5 HD pegataur has the spell-casting abilities of a 1st-level elf, while a 14 HD pegataur has the spell-casting abilities of a 10th-level elf: Elf level plus 4 equals the pegataur's HD.) When attacking in melee or making saving throws, a pegataur is treated as either a monster of its total Hit Dice or as its level as an elf, whichever is better for the situation.

Twenty percent of 10th level pegataurs have earned enough experience to gain Attack Ranks and some or all of the special elf attacks and defenses (page 30 of the *Players Companion* rulebook).

All adult pegataurs have basic weapon mastery in longbow, lance, two-handed sword, and mace. There is a 20% chance

that a randomly encountered first-level pegataur will have one additional 20% chance of gaining another level of mastery at every other level attained. For instance, a third level pegataur rolls twice and may have up to two extra levels of mastery. A ninth level pegataur rolls five times.

If a pegataur is 10th level, treat each increase in attack rank as a level. For example, a pegataur with 1.1 million experience points may have as many as seven additional levels of mastery. All pegataurs work on mastery in only one weapon at a time, until the pegataur becomes a Grand Master. Additional levels are applied to a different weapon.

An unarmored pegataur has an armor class of 5. The table shows armor classes of armored pegataurs:

Armor	Chance*	AC
Joust	0%	-1
Field	0%	0
Plate	10%	1
Banded	10%	2
Chain	50%	3
Scale	15%	4
Leather	15%	5
Unarmored	0%	7

* Refers to the frequency of randomly-encountered pegataurs wearing this type of armor. Non-randomly encountered pegataurs can have better armor. Their base AC is shown here.

A shield gives a -1 adjustment to armor class to the creature's humanoid forepart. No randomly encountered pegataurs carry shields.

Silk-Spider

Armor Class: 7
 Hit Dice: 2**
 Move: 30' (10')
 Attacks: 1 area effect
 Damage: Special (see below)
 No. Appearing: 1 swarm
 Save As: Normal Man
 Morale: 11
 Treasure Type: Raw Spider-Silk
 Alignment: Neutral
 XP Value: 30

An individual silk spider is a small, unthreatening creature about 1" in diameter (including legs). The creature's chitinous covering is a glossy brown and hairless; unlike Known World spiders,

MONSTERS of Alphatia

they have ten legs.

The statistics given above are silk spiders as they appear when they *swarm*—they're just a variety of the *insect swarm*. However, they have two special abilities instead of just one.

First, they can swarm over parties of adventurers, biting and stinging for 2 points of damage per character per round—no saving throw.

Second, they can spin a gigantic *web* over intruders—and this acts just exactly like the *web* spell. Swarming silk-spiders will sting 60% of the time (1-60) and *web* 40% of the time (61-00).

Silk-spiders nest in dry caves and pits. They are not native to this world, and will die outside the special environments created for them by Alphatian wizards, so there is little chance of encountering them in the wild outside Alphatian-controlled territory . . . On the other hand, there's no telling where an Alphatian wizard will set up shop.

Silk-spiders are prized because the *webs* they weave can be collected and processed into very light, very tough material—lighter and tougher than silk. This is the prized clothing material in Alphatia, and commoners may not wear it.

Each 10' by 10' by 10' area *webbed* by silk-spiders can be turned into a piece of cloth suitable for one ordinary large gown, or several short tunics or lesser garments. To collect the *web* material, a spider-keeper must use his *hold monster* spell, which affects a whole swarm of silk-spiders as though they were a single 2 HD monster.

ZZONGA-BUSH

Armor Class: 9
Hit Dice: 1
Move: 0'
Attacks: 1
Damage: Special (see below)
No. Appearing: 1-10
Save As: F4
Morale: n/a
Treasure Type: none
Alignment: neutral
XP Value: 0 (it doesn't fight back!)

The zsonga-bush is a plant which grows to be about 4' in diameter. It has short, spiky green leaves and a large fruit which looks like a pale pink strawberry. The fruits give off a strong, sweet, distinctive odor.

It's impossible to disguise the odor of the zsonga-fruit: One can't introduce it into someone's food without that person's knowledge, for instance.

The fruits can be eaten raw, made into preserves and jellies, or fermented and distilled into wines and liquors. In any form, they are delicious.

They also have a potent and detrimental effect. One dose of zsonga-fruit (a dose constitutes the equivalent of one fruit or the equivalent amount in jellies or preserves; one glass of wine; or one shot of whisky) will drug the consumer if he does not make a saving throw vs. poisons at -6. The effects will last 1-4 days.

During that time, the drugged party is pleasant and happy, but utterly and com-

pletely unambitious: He has no interest in furthering his career, earning a living, or protecting the Empire. He can rouse himself to protect his family or friends with a Wisdom check.

While under the effects of zsonga, a spell-caster casts magic with difficulty. To cast any spell successfully, he must make an Intelligence check at a -6. (Clerics must make a Wisdom check at -4.)

A second dose in the same day automatically ensures that the zsonga effect will last a full 4 days, instead of the unreliable 1d4 days. More doses in the same day have no further effect—except that the drugged party likes them a lot.

One dose on each subsequent day will extend the duration of the drugged condition by one day. Subsequent doses on days when the zsonga has already been consumed have no effect—except, again, to please the partaker.

In the Alphatian Empire, there are many zsonga-addicts. They waste all their money acquiring the stuff; under its effects, they cannot work. Even mighty magic-users among them cannot reliably defend themselves with their magic.

Fortunately for the rest of the world, the stuff can only grow in special environments (mostly underground greenhouses with phosphorescent domes) set up in mainland Alphatia; it is not native to this world and cannot survive here without special care.

Campaigning in Alphatia

Alphatia is a setting for powerful magic events to take place, bizarre new creatures to run amok, and great kingdoms to crash against one another because of the petty differences of their ruling kings and queens. It's a land of chaos and great opportunity—for spell-casters (magic-users, clerics, and elves). Non-spell-casters can make good lives here, too, but usually must be friends with aristocrats who will protect them.

Here, we'll talk about the "career path" of Alphatian characters: How they begin their careers, progress through higher experience levels and greater importance in the Empire, and what they do as they reach Masters' levels.

Basic Adventures

In Basic adventures, the low-level characters begin the process of making their fortunes in the world. Assume that beginning magic-users and elves have higher-level teachers in their home cities. You can, if you wish, work these characters up as full NPCs; perhaps they'll be able to point the heroes toward good missions or treasures with rumors they uncover. When the characters are in their home cities and between adventures, they're studying magic.

Likewise, beginning clerics belong to one clerical order or another. Between adventures, they're learning everything a cleric needs to know from their superiors.

Magic-users, elves, and clerics above 1st level are Aristocrats in Alphatian society. This doesn't mean that people are showering gold upon them, or that their path to success is greased—just that they bear a noble title, have the opportunity to achieve the greater social classes, and have more legal rights (and often more lenient judges) in the society.

Fighters, thieves, dwarves and half-lings are Commoners in Alphatian society, and that can be a difficult thing to handle. In general, they are not being continually and cruelly discriminated against—they just can't achieve most higher social classes, and have to be careful of their manners around NPC aristocrats they don't know well.

In their early adventures, player-character parties should have the opportunity to find dangerous but rewarding missions that will allow them to build their fortunes and meet a few important people . . . people who will remember them in the future, when the characters' careers are further along.

Expert Adventures

In their Expert-level adventures, the characters should be undertaking more hazardous missions, meeting (and helping or hindering) more important NPCs, perhaps even coming to the attention of the Imperial Court and Grand Council of Wizards.

It's at this time that characters will begin to want to establish their own dominions. Not every PC will necessarily wish to rule a dominion; some will be content to stay with their friends who do rule, while others will feel the need to rule.

You now have to make an important choice: Do you separate these characters geographically as they begin establishing dominions, or do you wish to try to keep them together? If the former situation is the case, then you have a wider variety of areas in which to allow them to establish their dominions. Non-spell-casters will be able to establish dominions in the fringes of the Empire—Norwold, Esterhold, parts of the Isle of Dawn, even in the Yannivey Chain if they dare. Spell-casters, on the other hand, can rule in the lands closer to home: They can inherit dominions in mainland Alphatia, Bellisaria, and the Isle of Dawn. But if you separate these characters in this fashion, it will be more work for you in each extended story to get them together. (On the other hand, in the Alphatian Empire, with its Air-Ships and powerful magicians, this is less of a concern than it would be elsewhere.)

If you'd prefer to keep them together, you'll have to have some NPC ruler offer them dominions near one another. The best place in the Empire for this is Norwold, which is largely unsettled, and where non-spell-casters can be equal in rank to spell-casters.

It would be good at this time (if you didn't do it in the Basic adventures) to introduce one or more personal enemies for some of the PCs—without getting these enemies killed off. Establish a bitter rivalry or hatred between these enemies and your PCs, either personal hatreds or group hatreds . . . but make sure some of these enemies escape to recover and gain in strength and experience.

Companion Adventures

Having settled their dominions and established themselves, the PCs should now:

Begin using their resources to defend their Empire;

Begin receiving the attentions of foreign powers who might wish them to switch allegiance; and

Begin turning their eyes to the workings of the Universe and the other planes of existence.

In other words, you can put them in adventures centering around their own lofty positions as rulers. They can't ignore threats to a specific empire if that empire is theirs; they *must* respond. Their ruler, be it King Ericall, Empress Eriadna, or some other, will often demand services of them (especially in wars)—and in these adventures you can put the PCs in all sorts of wonderful moral quandaries, as their rulers demand actions of them which they cannot justify or accept. And foreign powers, especially Emperor Thincol of Thyatis, will begin making sly probes to see if their loyalty is secure . . . and if he perceives that the character has a weakness (gold, women, embarrassment, whatever) he will gradually and inevitably use those perceived weaknesses against the character to turn his allegiance to Thyatis.

Also, the characters are becoming sufficiently powerful that they will be able to explore other planes of existence with some regularity. First, they must find NPC regents (subordinate rulers) who can be trusted to rule faithfully in their places, and hold their thrones for them while they are gone. If they fail to do so, they could return home from an ex-

Campaigning in Alphatia

tended trip to find their dominions in the hands of others—and that's yet another adventure, when they try to recover their dominions.

Second, once they have found regents they trust, they can embark on the wildest cross-dimensional adventures you wish to dream up—and this can continue well into their Masters adventures.

During these adventures, you'll also want to establish what happened to the player-characters' enemies. Most should be achieving fame and fortune at the same rates as the player-characters. Perhaps one or two PCs will have final confrontations with their enemies—bitter duels to the death. Other enemies, of course, should survive.

Masters Adventures ———

At some point in the characters' careers—probably now—you may decide that you want to settle some issues of the relationships between Alphatia, Thyatis, and their colonies.

Perhaps you think it would be a neat series if you had Norwold declare independence from Alphatia. If the characters are Norwold rulers, then they'll have to figure out how to defend their land

from the Alphetian reprisals. If the characters rule elsewhere, they'll be called in to help with the assault on Norwold. If the characters are split half-and-half, you have a most interesting gaming situation on your hands . . .

Perhaps you think it's time for Alphatia and Thyatis to settle their differences once and for all. This could take the form of an all-out, pitched war which leaves the two empires exhausted, drained, and open to conquest from more distant lands. It could take the form of a meeting of and sudden infatuation of Empress Eriadna with Emperor Thincol, with peace and happiness scattered like butterflies. It's more likely that the final answer lies somewhere between these two extremes, with your player-characters playing a bit part in that resolution.

Alternatively, you might wish that one empire or the other win utterly. Perhaps Eriadna has finally put together an enormous enough force of high-level magic-users who are interested, not distracted, and zzonga-free, and created her own elite air force to combat the Retebius Air Fleet and Knights of the Air. Thyatis might not then stand a chance . . . and this gives you years of adventuring oppor-

tunities as the characters help in the conquest of Thyatis, the further conquest of Thyatis' subject lands, and the maintenance of the new additions to the Alphetian Empire.

In the Masters adventures, you'll want to resolve the fates of the surviving enemies of the player-characters. They should all now be achieving great fame and fortune, too—it's time for ultimate conflicts with the PCs. These can be resolved in bitter and epic quests where the heroes and the enemies struggle to the bitter end—and not all the PCs will necessarily come out victorious, naturally. Perhaps one enemy and his PC foe will come to an understanding and be allies thereafter. Perhaps one enemy and the PCs will have to come to a temporary truce to battle a mutual enemy.

Finally, as the PCs careers' near their end, they will wish to embark on the roads toward Immortality. Not all should succeed, naturally. Some will. Some will fail, and be doomed to ordinary mortality. Some will die in their efforts. And, perhaps, the greatest of the PCs' enemies will also achieve his road to Immortality and be waiting for them when they embark on their next level of adventures.

Other Territories

In this chapter, we'll present additional information on many of the subject territories of Thyatis and Alphatia. You already have a working knowledge of these areas from *Book II* and *Book III*—particularly the “Overview,” “Society and Politics,” and “Character Creation” chapters.

The Alatians

The Alatians appear on the map on page 62.

History

These islands were settled by non-magical Alphatians who wanted to make their lives away from the tyranny of Alphatian nobles—and they did. The land was not especially rich, the farms never particularly prosperous, and the Empire and its wizards paid no attention to these islands. But in the 1730's by Alphatian reckoning (AC 730's by the Thyatian calendar), the wizardess Mylertendal's philosophies of beautification became very popular and the current Emperor decided that it would be his project to “beautify” large areas. He chose the poor, defenseless Alatians, moved the entire population elsewhere, and began re-arranging things.

Two of his projects were failures. He turned the island of Aegos into a large zoo for magically-created, fantastic beasts; but this project was sabotaged by wizards from Trollhattan, and all the beasts killed one another or died mysteriously. Artesia Island was resettled as an artisan's paradise, but was too out-of-the-way for most Alphatians to care about and perished economically. Aegos reverted to agriculture; Artesia was resettled by thieves and scoundrels and was renamed Ne'er-do-well.

The two other islands, however, were successes. Aeria became one of two centers for the study of air magics, rival to Floating Ar in the far north. And Gaity became a grand amusement park, a vacation spot for wealthy wizards and their families.

Culture

The culture of Aegos, Aeria, and Gaity is primarily Alphatian, with no surprises. Aegos is rural and agricultural, so there is very little in the way of sophisticated entertainment for noble Alphatian visitors. Aeria is very scholastic, a fine place to learn; but its long-term inhabitants affect scholarly mannerisms and can be quite insufferable. Gaity, as its name indicates, is a delight to visit, a center for entertainments from the most innocently childlike to the most sophisticated; everyone goes to Gaity to have a good time and so it is a very cheery island.

Ne'er-do-well is very cosmopolitan and shady. Under local laws, magic-users have no more protection than non-magic-users—that is, none. It's a very dangerous, profitable, catch-as-catch-can sort of island, a good place to visit to get things done, employ talented hirelings, or acquire rare and illegal things—but not a safe place to visit.

Geography

These four large islands, as shown on the map on page 62, lie more or less at the four cardinal points of the compass—Aegos west, Aeria north, Gaity east, and Ne'er-do-well south.

All are hilly islands with poor soil and tough, durable tracts of pine forest. They are pretty, but not agriculturally productive, and have to import the majority of their food (except Aegos, which farms enough to support itself). The islands tend to have pretty beaches and picturesque sea-views.

Populations:

Aegos: 5,000.

Aeria: 15,000. (This includes 5,000 permanent residents not associated with the university or its surrounding community; 5,000 city-dwellers, university staffers, and permanent students; and 5,000 normal students. In the winter, when the university is not in session, the island population drops to about 11,000.)

Gaity: 5,000. (This includes about 1,000 Rainbow Park operators and 4,000 in families belonging to those operators.)

Tourism adds 5,000 on an average summer day, 2,000 on an average spring and autumn day, and 1,000 on an average winter day.

Ne'er-do-well: 20,000.

Characters

On Aegos: *King Heldeberan No-Man's-Fool* (MU36, N). Heldeberan, as his nickname might indicate, has 18s in both Intelligence and Wisdom; though he has been invited repeatedly to join the Grand Council, he always politely declines, preferring to keep his nose in his laboratory. He hates interruptions of any sort, delegating his royal authority to subordinates. He is also, by his own admission, an utter coward, and hires brave adventurers to handle any fighting-problems that emerge on his island. He is charming, slightly daffy, always ready with a *teleport* spell, even-handed, and (unusual for an Alphatian wizard) utterly without prejudice as far as race or character class goes; adventurers and mercenaries like to be employed by him. Appearance: 6'3", skinny; common Alphatian coloration; red-headed and -bearded; likes preposterously decorated spider-silk robes in yellow; apparent age 35 (real age 75).

On Aeria: *Master Aiklin (the Addled)* (MU36, L). The character PCs are most likely to meet on this island is not its king, but the master of the University of Aeria. Aiklin theoretically runs the school, but actually delegates the work to subordinates. He is called the Addled because of his stream-of-consciousness conversational babbling, but there's no better lecturer or developer of aerial magics—and for all his babbling, he has eyes like a hawk and a shrewd intelligence. He is originally from Aasla. Appearance: 5'7", ponderously overweight; black-haired (clean-shaven), blue eyes; “pure” Alphatian (pale skin); prefers white robes and wears no jewels; age 60 (real and apparent).

On Gaity: *Tristilia the Elfin* (MU12, C). The most popular tour-guide of Rainbow Park, she is a descendent of the park's founder and stands to inherit the

ISLE OF DAWN



AERIA

Feather Fall



ALACIAN ISLANDS

GAICY



Rainbow Park

AEGOS

Aegopolis



NE'ER-DO-WELL

CROSSROADS

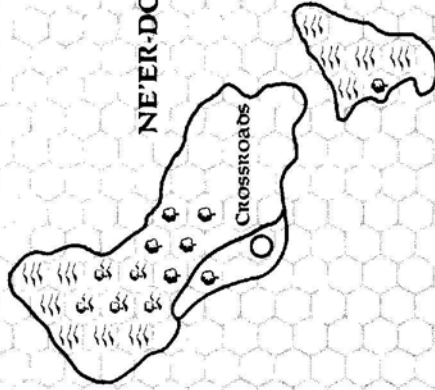

LESSER NE'ER-DO-WELL



Scale: one hex equals 24 miles

Other Territories

throne of Gaity on her grandfather's death. She is still very young by wizardly standards, and appears even younger due to a *potion of longevity*. She has an Intelligence and Charisma of 17, and numerous social general skills (Acting, Conversation, Persuasion, Speechmaking, etc.). Appearance: 5'6", slender; common Alphatian coloration; hip-length blonde hair; prefers red robes decorated in white, golden earrings; apparent age 18 (real age 28).

On Ne'er-do-well: *King Koryn the Harpist (aka the Big Dipper)* (T36, N). Koryn, son of the mercantile wizard who renamed and restructured the island, started out as what the locals call a "dipper"—a pickpocket. He was, and is, a good one, and is head of the local Thieves' Guild (also known as the Island Government). He's also a harpist of great ability (Intelligence of 16, Dexterity of 18, Harpist musical skill on a 20). Koryn looks on theft as an intellectual exercise and actually lives quite modestly, spending all his personal cash reserves on civic improvements and other programs to

make Ne'er-do-well a thief's paradise. He'll rob a man blind, but there's nothing personal about it, and he gives money lavishly to people who've lost all their wealth on the island. He's honorable as thieves go and won't betray a promise or a minion. Appearance: 6', trimly built; Alphatian/Thothian cross (coppery skin, black hair and eyes); prefers tunic, trousers, belt and boots all in black with golden piping; has extremely long fingers; age 40 (real and apparent).

Campaign Use

These areas are best used as interesting sites for PCs to visit from time to time.

On Aegos, bizarre monsters left over from its brief bestiary period occasionally still emerge from the woods—and King Heldeberan needs adventurers to hunt down and capture or slay the beasts.

On Aeria, the characters can track down long-lost facts of history, myth, or magic. You can establish that one or more PCs are alumni of the University of Aeria, and relate these characters to the NPCs of

the school. Aerial wizards are always experimenting with air-oriented magic and are accident-prone—so they can accidentally create air-monsters or portals to the Plane of Air which need to be corrected.

On Gaity, the characters can be part of the entertainment crew, manning the attractions and rides or acting as guards on the notorious "Airship of Love"—a gargantuan flying boat which makes cruises of the Empire, beginning and ending on Gaity, and encouraging romance and free spending. Later in their careers, they may visit for their own recreation—either in an uneventful, fun trip, or on an occasion when an attraction goes awry and needs adventurers to put it right.

On Ne'er-do-well, the characters can track down famous criminals (to turn them over to the law or to use them for their own purposes); can find rumors to lead them to the long-lost places they need to find; can be hired to help with heists, pirate forays, smuggling, and other criminal activities; or can even try to set up their own rival Thieves' Guild and take over the island, gangland-style.

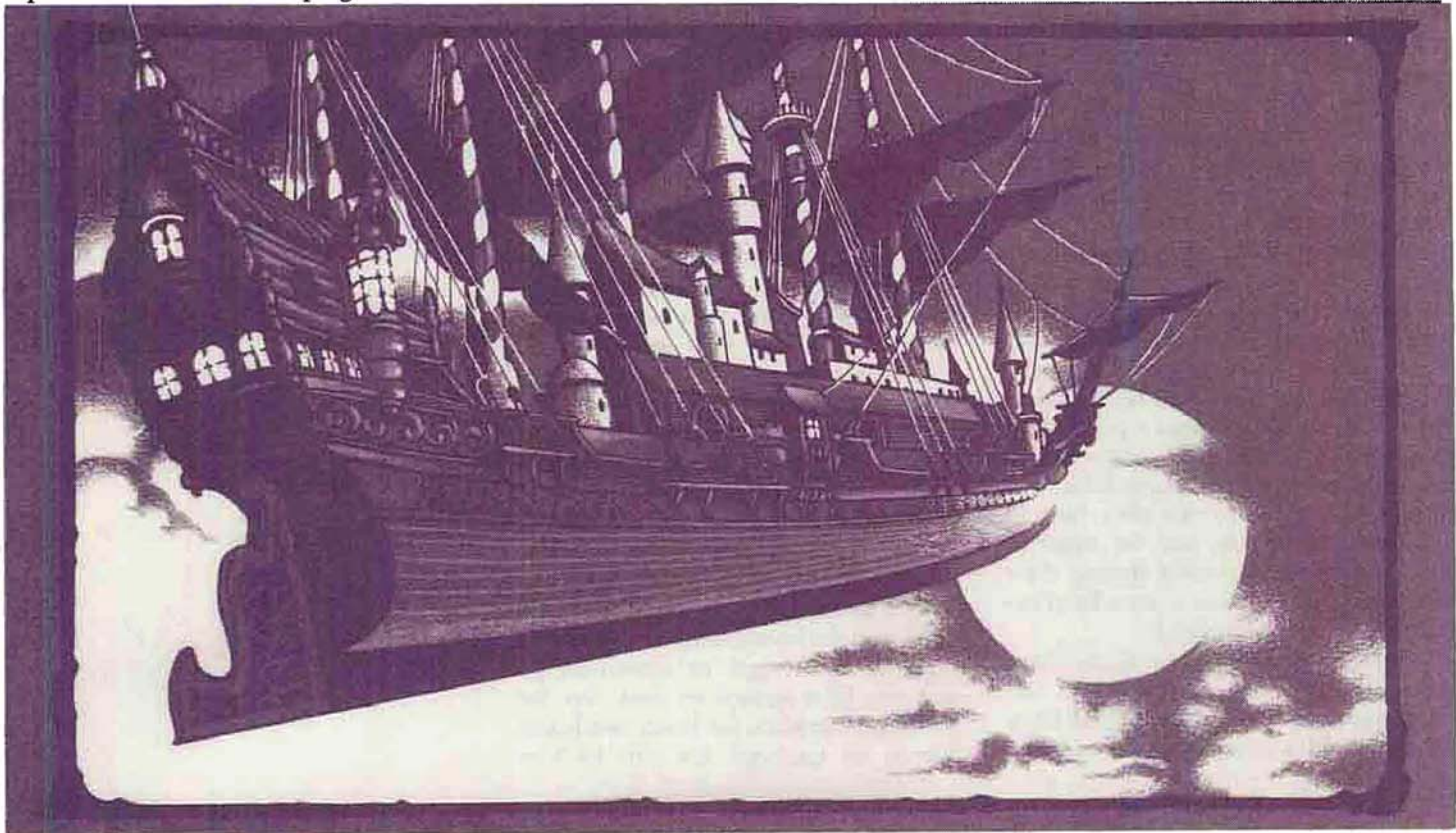

Other Territories

Bellissaria

Bellissaria appears on the map on page 66.

History

Alphatian wizards began settling Bellissaria soon after Landfall in Alphatia itself. The huge island had rich soil, low-lying but pretty mountains, and vast plains—ideal territory to forge new kingdoms at a distance from the capital at Sundsvall.

The island's history is quite uneventful—which is the way the island's various kings like it. They learn their magic, pay their taxes, keep the commoners growing crops, provide support to the Empire in times of war and keep to themselves otherwise. The island's history follows that of mainland Alphatia, except that periods of decay and decadence are never so bad here—and periods of prosperity are never so good.

Culture

The denizens of Bellissaria—aristocrat and commoner alike—tend to be very close-mouthed. They don't like strangers, don't like adventurers, don't like noise, don't like trouble. Inns are few; where they are present, their operators don't like noise or problem guests. Taverns are common . . . but when strangers wander in the door, everyone clams up.

Laws in Bellissaria are very strictly oriented to pacify or get rid of troublemakers. Exile is a common punishment for crimes of both low and high justice. And exile is almost always a permanent sentence; local rulers and judges hardly ever reconsider. A good origin for one or more of your PCs is to have them born in a Bellissarian nation, and for them to have caused some trouble during their misspent youths—so as to have been exiled from their native lands.

An exception to this rule is the kingdom of *Surshield*, mentioned in the "Overview of Alphatia" chapter in *Book III*. *Surshield* is an anarchy—outside the

military outposts in the east part of the nation, there is no law in *Surshield*.

Geography

About 90% of Bellissaria is flatland: plains and patchy forests. Central Bellissaria, which is not well-watered, is pretty arid, but doesn't quite constitute desert—it's just scrub country. The rest of the island is well-irrigated.

The whole southern coast of Bellissaria is dominated by the *Surkarian Mountain range*, whose foothills descend to within a few miles of the sea along most of the coast. The easternmost point of the south coast, the peninsula where the city/fortress of *Spearpoint* lies, is free of mountains.

Population: By mutual covenant—a desire to keep things peaceful and quiet—few communities in Bellissaria are allowed to grow to populations over 500. When they do, the rulers force some of the population to settle new villages in the same dominion. Exceptions: *Alchemos*, a center for study, has a population of 10,000, and *Spearpoint*, a major military community, has a population of 30,000.

Campaign Use

Bellissaria is a land of close-minded nobles and superstitious peasants. The streets are clear at dusk, and families make their own entertainments. By the standards of adventurers and mainlander Alphatians, as the old joke has it, Bellissaria is a great place to be thrown out of.

However, just because its peoples are so taciturn and superstitious, Bellissaria is a grand place to run monster adventures. In such adventures, one PC hero might have returned to visit his old homestead—with his adventurer friends in tow, of course—when some hellish monster is ravaging the countryside. The natives don't talk about it with outsiders (and even the homegrown hero is an outsider now—after all, he moved away), and the local authorities cover up the problem. But when the hero's family and friends are menaced, it's time for him

and his party to track the beast down and destroy it . . . and then, because of all the ruckus they've raised, they'll probably be shown the shortest path to the nearest border.

Also, an enterprising PC might get the idea that he should make Bellissaria a more interesting place to live—by forging his dominion there, or taking over an existing nation, and making it as sophisticated and loud as places on mainland Alphatia. This will be a struggle for him, of course, as the rulers of surrounding nations berate him—and work against him—for upsetting things, corrupting their children, and so forth. A PC might especially be inclined toward this course of action if you suggest it to him. . . .

Esterhold

Esterhold appears on the map on page 66.

This region is substantially as it is described in the "Overview of Alphatia" chapter of *Book III*.

History

This region was once thinly populated by tribes of Jennites. Jennites are very primitive peoples who lived at New Stone Age technology before the coming of the Alphatians; all their spearpoints and arrowpoints were stone, and the only metals they worked were copper and silver for decoration.

Alphatians began settling in the region in the eighth century after Landfall (AY 800, or BC 200); they used their magic and more sophisticated military forces to drive the ruling Jennites back several hundred miles . . . and enslaved the rest. Since that time, the eastern Jennites have made sporadic war on the Alphatian invaders.

Culture

Esterhold is a very backward place by Alphatian mainland standards. Well-armed overseers crack the whip over the Jennite slave forces which farm the land and mine the hills. The communities are dirty and poorly-maintained, and are not improved by the occasional raids and military sorties performed by free Jennite war-tribes in the east.

Aristocrats and commanding military rulers keep mostly to themselves; unbelievable atrocities are committed upon the Jennite population, and the penalties inflicted on escaping Jennite slaves are particularly horrible.

In short, the so-called "culture" in Esterhold could appeal only to the most greedy and cruel of PCs or NPCs. Most Alphatians who visit this blighted land don't return.

Geography

Esterhold, a broad western-pointing peninsula on the great eastern continent, is a rolling land filled with sparse forest,

scrub brush, and tough grasses. It's bare and unproductive land, requiring a lot of work to produce adequate crops. Grassfires are not uncommon and can be terrible in this land.

Skyfyr: Population 10,000 (50-50 free/slave).

Faraway: Population 25,000 (20-80 free/slave).

Campaign Use

This area is best used as a test of conscience for characters—especially Alphatian characters. More so than any other place in the empires of Thyatis and Alphatia, slaves here are ground down to nothing and then discarded; they live terrible, miserable lives. Any visitor to Esterhold will have this fact shoved in his face from the first day of his arrival, and it's your job, as DM, to do the shoving.

Player-characters will be confronted with malnourished, deferential slaves who cringe at the slightest sudden motion on the PCs' part—they're used to blows. The few slaves who rebel, escape, or even express uncomplimentary opinions to their owners or other freemen are put to death. And their owners affect civilized manners and cultured attitudes when entertaining their Alphatian guests, wining and dining them, getting the latest society news from the mainland.

If you want to run an adventure or mini-campaign of Jennite rebellion, it's quite easy to bring about. For whatever campaign-related reason you care to use, get the PCs to Esterhold—either the city of Skyfyr or the post of Faraway—as employees or guests of one of the ruling households.

Then, get them involved with a Jennite NPC or group of NPCs. Perhaps a player-character—probably a fighter or thief—will fall in love with a Jennite servant. Perhaps a young and still-energetic Jennite lad will save one of the player-characters from accidental injury or death. The important thing is that the PC get involved with the NPC; the NPC will inevitably invite the PC to visit his or her family, and the PC can see close-hand the wretched lives the Jennites lead.

Then, the Esterhold military scores a coup and captures one of the most important princes of the free Jennite tribes. The prince is led to the city in chains and publicly executed. The Alphatians of the city have a day of celebration of the event.

The Jennite slave population grows angrier and angrier. Some perform petty acts of rebellion. They are executed. More rebel. They are executed. Sporadic fighting breaks out between the Alphatian overlords and their numerous but easily-slaughtered rebellious slaves. The city is a powderkeg of violence.

Then, the player-characters' Jennite friend is arrested on some charge or another—perhaps true, perhaps trumped-up—and sentenced to execution for later that day or dawn of the next. Do the player-character heroes rescue him or her (which is sure, they know, to set off a violent revolt against the Alphatians) or let the NPC die (which may itself set off the revolt!)? The local Alphatians won't accept a bribe to let the NPC go—he or she has to be made a lesson of. And it's no good threatening Alphatian wizards with force, as the player-characters should know.

This whole storyline could end up with the player-characters leading a massive Jennite invasion of Esterhold and throwing the Alphatians out entirely, and forging their own dominion here—or reluctantly siding with their own kind against the native population. Either way, it's a crucial moral dilemma for them to solve.

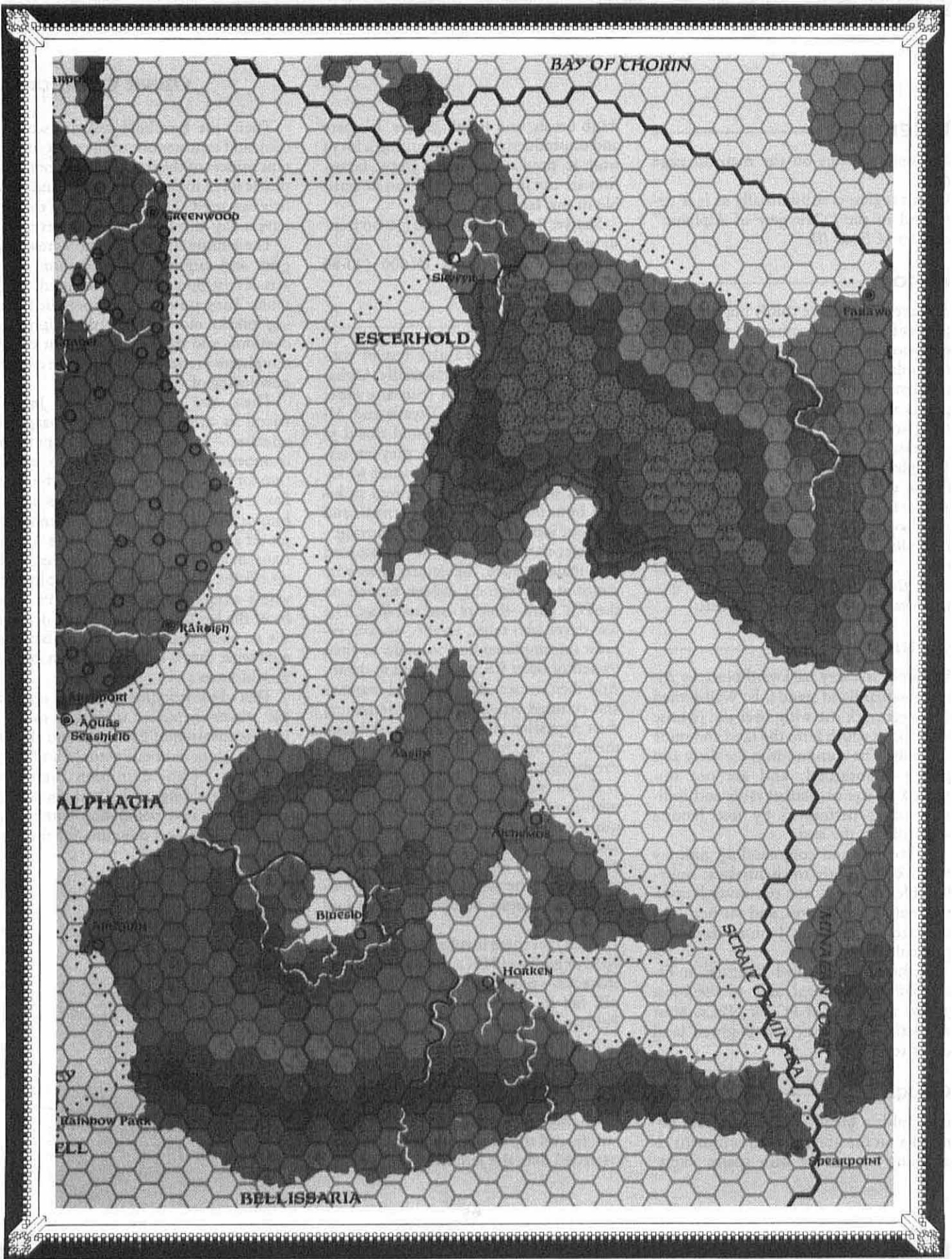

BAY OF CHORIN

GREENWOOD

ESTERHOLD

Rakosh

AQUAS Beachie

ALPHACIA

Biosis

Horken

Rainbow Park

SCAPE OF VINYRA

BELLISSARIA

Spearpoint

The Hinterlands

The Hinterlands appear on the map on page 69.

History

In ancient times, this region was occupied by the three great Thyatian tribes before their migration to the land now known as Thyatis. Other races had lived here and migrated to the northern continent, following the icecap as it retreated northward, settling the new northern lands.

Not all those of Thyatian descent migrated north in those ancient times. Some tribes remained, and were absorbed by the next wave of migrants, who loosely refer to themselves as the Men of the Four Kingdoms in their own tongue.

The Four Kingdoms are actually four populous but wide-scattered tribes, each named after its tribal totem: Wolf Tribe (farthest west), Horse Tribe (middle west), Raven Tribe (middle east), and Lion Tribe (farthest east). Each kingdom/tribe is broken down into hundreds of small, independent villages.

Starting about a dozen years ago, Thincol began ordering Thyatian troops into the Four Kingdoms territory. Thyatis had been trading occasionally with these peoples, but now the empire was moving in to conquer. In this last decade or so, the Thyatians have moved progressively deeper into Horse Tribe and Raven Tribe territories, conquering village after village, and easily weathering the disorganized counter-assaults by the warriors of the Four Kingdoms.

In this time, the region has come to be called the Hinterlands by the Thyatians conquerors. The natives refer to the various areas as Horse-Land, Raven-Land, etc.

Culture

The Hinterlanders are a warrior culture, doing honor only to fighters of merit. Their men and women both fight; discrimination in their culture is aimed at physical weaklings. Even then, as is the case with many magic-users, a physical

weakling with great powers is accorded honor.

Hinterlander culture stresses individuality and freedom; most Hinterlanders tend toward Chaotic alignment. They don't fight in formation and, while they are individually great warriors, they tend to be baffled by the mighty formation armies of the Thyatians.

Hinterlanders honor Immortals devoted to warfare and individuality, such as their patroness Diulanna.

Geography

The Hinterlands are rolling, hilly coastal areas characterized by very green vegetation and deep, somber forests. They do not cut down their forests—just patches large enough to build villages within.

Across the Hinterlands are hundreds of thousands of small villages, each named for the clan which inhabits it. A village in Raven-Land occupied by the Falchion clan would be called Raven-Falchion.

There are five larger communities in the Hinterlands—the four kingdom "capitals" and the military post of the Thyatian conquerors. Capital cities aren't actually occupied by kings ruling these broad "kingdoms"—they're huge camps where representatives of all the clans meet annually for a week-long gathering of games and decision-making councils. In the last few years, the topics of these councils have always centered around getting rid of the Thyatian Threat.

Wolf-Meet is the gathering place for the Wolf Clans. It ordinarily has a population of 5,000; this swells to 25,000 during the clan gathering.

Horse-Meet is the gathering place for the Horse Clans. It ordinarily has a population of 3,000; this swells to 15,000 during the clan gathering.

Raven-Meet is the gathering place for the Raven Clans. It ordinarily has a population of 10,000. The population wasn't always so high . . . but then, this isn't the original Raven-Meet. As the Raven Clans were pushed deeper into their territory, they were forced to move Raven-Meet to a more distant site . . . and many displaced Raven Clan refugees live here perma-

nently. The community population swells to 20,000 during the clan gathering.

Lion-Meet is the gathering place for the Lion Clans. It ordinarily has a population of 4,000; this swells to 12,000 during the clan gathering.

Raven Scarp is the staging community for the Thyatian invaders. Site of the original Raven-Meet community, it now contains the Thyatian military fortress called **Fire-Height**, the Thyatian naval port, and a large community of civilians—Thyatinized Hinterlanders for the most part; the rest are Thyatian minor officials, adventurers, and mercenaries. Population 20,000 (including 4,000 military forces, 14,000 Thyatinized Hinterlanders, and 2,000 others).

Characters

Characters whom player-characters are likely to meet include:

Penn son of Bran (F6, L). Penn, son of the former chieftain of the old Raven-Meet, was captured twelve years ago in the same battle that Raven-Meet and his father the chief both fell to the Thyatians. To save his people from complete slaughter, he surrendered in the name of the chief. Since then, Raven clan peoples outside Thyatian-controlled territory—and many within—have regarded him as a traitor to the Raven-Land. In the intervening years, Penn has solemnly kept to his word and cooperated with the Thyatians, helping keep peace and quelling revolution in Raven Scarp, though he has no official status in the city. His younger brother Brian now rules the remnants of his clan and fiercely hates him; Penn's son Dylan has lost all respect for his father and left the Hinterlands. In the years since the fall of Raven-Meet, Penn has lost a lot of his fighting edge and self-respect . . . but he still bears a chieftain's concern for the fate of his people and throws around what political weight he has in keeping safe the citizens of Raven Scarp. Appearance: 6'2", 280 lbs. (should be around 200); red hair and beard, blue eyes; slow and ponderous mannerisms; dresses in featureless brown tunic, trousers, belt and boots; age 40.

Other Territories

General Leilah (C30, L, of the Immortal Tarastia). Leilah, military governor of Raven Scarp, is the daughter of a wealthy family of Tel Akbir. Forbidden to take up an adventuring profession, she ran away from home and joined the Order of Tarastia and, later, the Army of Thyatis. She was a lowly squadron sergeant during the Alphatian Spike assault of forty years ago, but distinguished herself in sight of Thincol the Brave and rapidly rose to a position of importance after those events. She has been twice married, and survived both adventurer-husbands. She is a capable, though not particularly inventive, garrison commander, and does not per-

mit any wartime atrocities on the part of her command to go unavenged; and she has a good eye for bright new officers and tacticians, who give her more military success than she might otherwise be able to command. Appearance: 5'4", 120 lbs; Alasiyan coloration (dark-skinned, black hair and eyes); striking features and arresting eyes (Charisma 16); wears standard Thyatian military uniform in Raven Scarp garrison gray with the symbol for Tarastia on her left shoulder; apparent age 30 (real age 60).

Campaign Use

The Hinterlands are a distant setting for player-character wilderness adventures. The Hinterland tribes are clustered around the coast, and areas deeper into the continent are unexplored—known to be inhabited by barbarian tribes, but little else is known. The ongoing struggle between the defending Hinterlanders and the conquering Thyatians is a good backdrop for wartime adventures; the player-characters could side with one force or the other, or could make good money smuggling weapons and magic to the Hinterlanders.

Other Territories

The Isle of Dawn

The Isle of Dawn appears on the map on page 71. The island is situated in a critical area, directly between the mainland seats of the empires of Thyatis and Alphatia, and has been a battleground of those nations for just over a millennium.

History

As you saw in the "History of Thyatis" section in this book—in the timeline—there was once a mighty nation called the Nithian Empire in what is now Ylaruam. The Nithian Empire grew beside the mighty River Nithia, and it was a land of surrounding deserts, fertile riverside farmlands, pharaohs and pyramids. Unfortunately, its leaders allied themselves with the Entropic Immortal named Thanatos, and many other Immortals collaborated to destroy the empire—to destroy it, and to make all the world forget that it had ever existed.

But the Nithians' easternmost colony, that of Thothia, had been established on the Isle of Dawn and had never worshipped Thanatos. The Immortals spared it when they destroyed Nithia proper—around AY 500 (BC 500 in the Thyatian calendar).

The Thothians lost not only their contact and trade benefits with their mother nation, but also all memory of it—which beggared the nation and confused and dismayed its inhabitants. The Alphas moved in and conquered . . . easily as much out of a sense of pity for the panicking Thothians as from greed, for the Thothians had very little to offer them.

The Alphas continued to rule the Isle of Dawn and settle its northern, southern, and western reaches. Then they had their first great war with the Thyatians, in AY 998 (BC 2), and the upstart Thyatians conquered the whole western half of the great island. They moved in to rule existing Alphas communities, and built up their own.

Over the next thousand years, the Thyatian/Alphas borders crawled all over the island, but in general the two empires have controlled fairly equal terri-

ories. Some of the island's communities have learned to cooperate and trade with one another while the mighty empires which rule them squabble fitfully with one another.

Culture

Inhabitants on the Isle of Dawn tend to belong to one of three cultures: Thyatian, Alphas, and Thothian.

Thyatians on the Isle of Dawn are much like Thyatians elsewhere. They're just as pushy, devious, and treacherous as on the mainland.

Alphas on the Isle of Dawn tend to be much like mainland Alphas. However, while they believe magic-users to be superior to non-magic-users, they come to this belief from the simple observation that spell-casters are more powerful. They don't have the mainland Alphas' attitude that non-spell-casters are commoners and unworthy—just that they're limited. Also, Alphas of the Isle of Dawn, unlike their mainland counterparts, tend to use family names as Thyatians do; Isle of Dawn Alphas identify themselves by both personal and family name.

Thothians belong to a very austere, ancient, civilized culture. They believe that the Alphas are the only other civilized nation in the world, and are glad that the Alphas deign to deal with all the barbarians for them. Most of the Thothians are mystics, having developed for themselves a complex series of beliefs about man's relationship with forces of nature and other planes of existence; few worship Immortals. They have other peculiar beliefs as well: That their pharaohs are automatically Immortal, achieving that elevated state when they appear to die; and that the Thyatians come from the same faraway place as the Alphas.

Geography

You already have a working knowledge of the cities and dominions of the Isle of Dawn, from the "Overview" chapters of *Book II* and *Book III*.

In general, the Isle of Dawn is hilly, with many bogs in the northeast, far north, and

west-central areas; deep forest west of Deirdren and all along the southwestern Shadow Coast; and one great escarpment (hilly and forested) and three smaller escarpments in the southern island region. The great escarpment is claimed by both Alphas and Thyatis, and occupied by neither; two of the smaller ones are similarly unoccupied, while the last, due south of the Fortress of Kendach, is settled and claimed by Thyatis.

Populations and other information on the various cities are as follows:

Dunadale: 18,000. Alphas-controlled. Dunadale is the capital of the Confederation of Dunadale, the boggiest land on the island. The Confederation controls lands north nearly as far as Helskir to 150 miles south of Deirdren, and west as far as the hill cliffs that mark the unofficial border to Thyatian-controlled territory. Alphas is the Common Tongue here, though Thyatian is widely spoken.

Deirdren: 3,000. Alphas-controlled. Alphas is the common tongue here; the town is small and has very few Thyatian-speaking residents.

East Portage: 1,000. Alphas-controlled. East Portage has a good port for such a small town. Trade goods and even whole ships are carefully dragged from here to West Portage or back by merchants and seamen wishing to avoid the long sail around the Isle of Dawn. Alphas is the Common Tongue here.

City-State of Ekto: 15,000. Alphas-controlled. There is a notable College of the Metals here, where scholars may study the science of metallurgy. Alphas is the Common Tongue here, though some Thyatian and Thothian are spoken as well.

City-State of Trikelios: 20,000. Alphas-controlled. Good port with many shipyards. Alphas is the Common Tongue here, though some Thyatian and Thothian are spoken as well.

Edairo: 30,000. Alphas-controlled. Surrounding land has a population of 10,000 more. This is a very dry and arid region notable for its many uninhabited ruins from a bygone era. Thothian is the Common Tongue here, though most no-

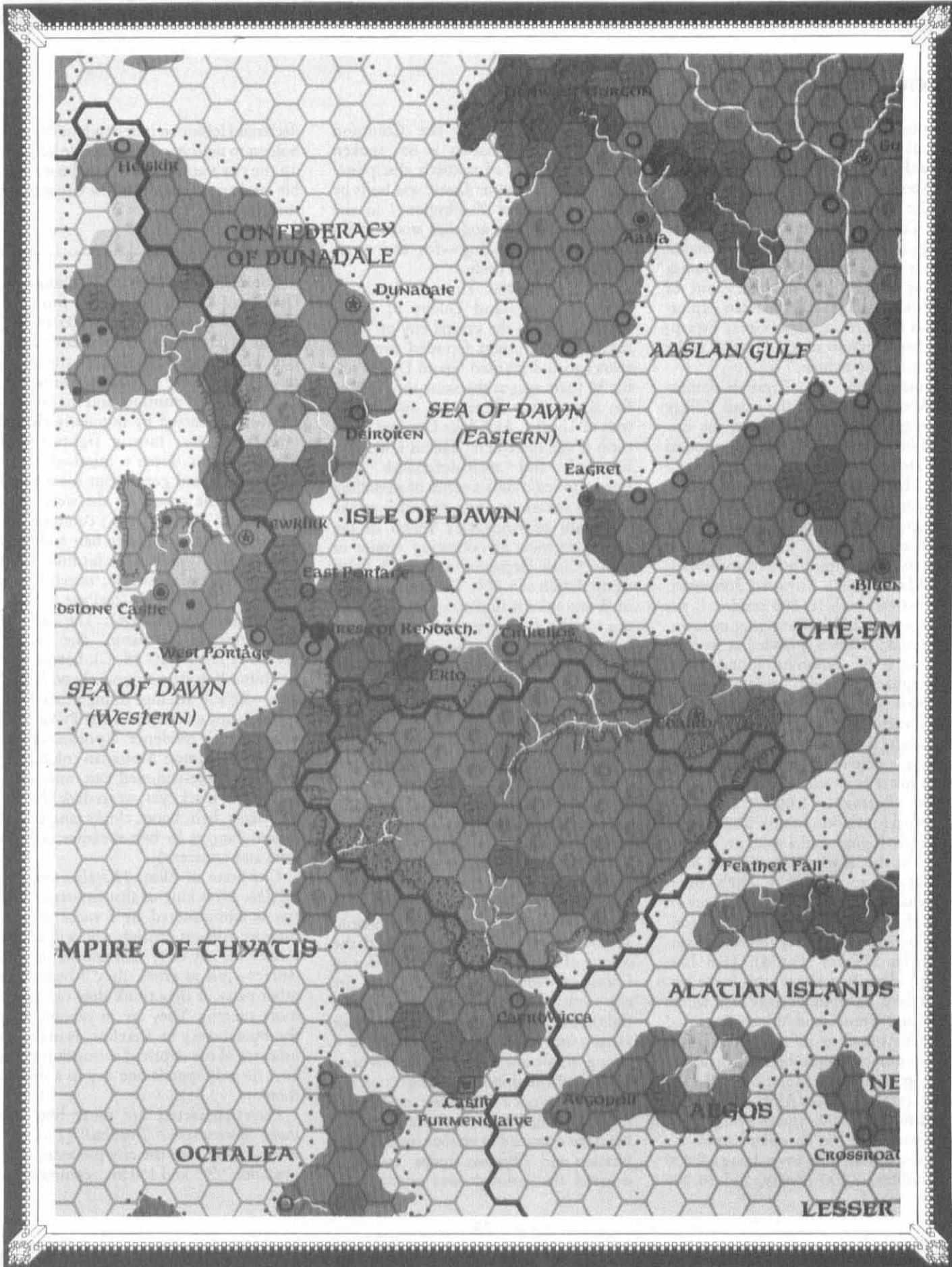

Other Territories

bles speak perfect Alphatian. Thyatian is not spoken here.

Caerdwicca: 1,000. Thyatian dominion. About 750 live in Caerdwick Village, and the remaining 250 live in McRhomaag Castle—a crude fortification consisting of a hill with a ditch and a wooden palisade all around. The McRhomaag Clan sponsors a lot of piracy out of Caerdwick Village; Caerdwiccan explorers also venture into the Great Escarpment from time to time. Thyatian is the Common Tongue here.

Furmenglaive: 750. Thyatian dominion. About 600 live in the small Village Furmenglaive clustered around the castle, while the castle population is around 150. Thyatian is the Common Tongue here. The original Castle Furmenglaive was built 500 years ago, a gloomy, black, cliff-top citadel overlooking the sea. The hilly area is a haven for dark, sinister monsters like vampires and lycanthropes.

Kendach: 5,000. Thyatian dominion. The Fortress, with its 200 residents, sits astride a large hill in the center of town, with Kendach Town sprawled at its feet. Thyatian is the Common Tongue here, but Alphatian is also widely spoken. Southeast of the town is the large Kendach Escarpment, which Countess Julia Kendasius claims for her city; she is building a secondary fortress and observation tower at its summit.

West Portage: 2,000. Thyatian-controlled (not a dominion). This is a city of thieves: If you need a thief on the Isle of Dawn, this is where you'll find him. The city is spotless—the city's ruler, Guildmaster Kubek, likes it that way (it keeps the thieving high-class and conceals the fact that the city rulers also constitute its Thieves' Guild). Like East Portage, described above, this is the terminus for a 100-mile portage trail where goods and even some ships are carted across the island at its narrowest point. The Common Tongue here is Thyatian, but most of the city population, and all of its government, speaks Alphatian as well.

Redstone: 20,000. This is a large military town run by the Thyatian Army—it's not a dominion. The town boasts 8,000 foot-soldiers, 2,000 cavalry, and 10,000

civilians. Thyatian is the Common Tongue, and Alphatian is not spoken here as a matter of soldierly discipline. The base of Redstone Castle was built by order of Emperor Zendrolion I in the years AC 2-AC 5, and has stood—with occasional rebuilding—for the near-1,000 years since then.

Newkirk: 25,000. Thyatian dominion (part of the Grand Duchy of Westrourke). This is the capital city of Westrourke, a dominion founded over 500 years ago and granted Grand Duchy status 30 years ago, at the same time as Stefan Karameikos forged his own nation west of Thyatis. Archduke Donegal Firestorm is the ruler here. This is a heavily-fortified and well-defended city; Firestorm maintains a series of signalling stations stretching from Newkirk to the mountain of Finnegan's Watch in the north, to warn of oncoming armies or fleets. Castle Firestorm in Newkirk holds a population of 1,000. The Grand Duchy of Westrourke is broken up into numerous smaller dominions (mostly baronies) held by adventurers; when your Thyatian player-characters begin thinking about settling dominions, this is a good place to recommend to them. Thyatian is the Common Tongue here, though Alphatian is also widespread.

Helskir: 13,000. Busy mercantile port with a lot of fishing trade. City unfortified; ruler's mansion, chief guild halls, and one tall stone lighthouse are built on a steep hill and protected by a wooden palisade. Alphatian is the Common Tongue, but Thyatian is also widely spoken. Helskir has for centuries been a contested city usually owned by Alphatia. When Empress Eriadna established the colony of Norwold, she ceded Helskir to Ericall of Norwold. This angered the city's ruler, Lord Eruul Zaar, a powerful fighter and brilliant organizer who built Helskir up from a fishing village to a strong, stable town; Zaar felt he had been denied official dominion recognition because he was not a magic-user, and he was right. During the last few years, Helskir has been occupied at various times by Alphatian and Thyatian troops, and Zaar decided that enough was enough—he

declared Helskir an independent city, beholden to neither empire. While he gears up the city's armed forces for the inevitable retaliation, citizens of the city wait for the axe to fall.

Characters

Confederacy of Dunadale (Dunadale, Deirdren): The titular ruler of this Confederacy is *Tastagarth Lunn* (MU 18, N), an Isle of Dawn-reared common Alphatian. He is treated as a King by the imperial bureaucracy . . . but in Dunadale, his is an elected position, and the government is conducted by popularly-elected representatives, mostly fighters and thieves. Lunn doesn't mind—he just signs papers and goes about his magical studies, while others do the work. Appearance: 5'11", 145 lbs.; common Alphatian coloration; brown hair and eyes; nervous disposition and birdlike head movements; wears subtle, tasteful blue robes; apparent age 40 (real age 60).

Hillvale (East Portage): The ruler of this dominion is "*Baron*" (i.e., King) *Lornc N'Jozee* (MU 18, C). Lornc fancies himself quite a scoundrel and ladies' man—he will attempt to ingratiate himself with any attractive female PC or NPC who visits his residence. Appearance: 6', 160 lbs.; common Alphatian coloration, but black close-trimmed hair, mustache, and beard; black eyes; wears dark blue tunic, pants, belt, boots, cloaks, and affects ornate daggers in belt-sheathes; age 35 (real and apparent).

City-State of Ekto: *Hastalan the Fair* (MU36, N) is king of this city-state. The city is administered by a cadre of oily, smarmy, corrupt officials who will accept money for any dirty task and sometimes deliver—just as often, they'll betray the other party, if they think they can profit more thereby. They are in cahoots with the bureaucracy in Trikelios. *Hastalan* is unaware of the depth of corruption in his city; he only spends one day in a month there.

Player-characters are more likely to meet *Townsmaster Trumbull* (T10, C), who actually runs the city processes. Appearance: 5'9" and 150 lbs.; common Al-

phatian coloration; brown hair and eyes; quick mannerisms but a smooth, oily demeanor; dresses in distinctive full-length long-sleeved robes and lets visitors believe he is a mighty wizard (though he never claims to be); age 45 (real and apparent).

City-State of Trikelios: *Queen Sillian* (MU24, L) is the official ruler of this city-state. She has recently come to the throne here and is spending all her time trying (mostly unsuccessfully) to unravel the web of corruption that has ruled this city for so long. She welcomes adventurers—especially experienced thieves—who can help her with this process, and is willing to trust outsiders (even Thyatians!) because they're not likely to be part of her city's corrupt bureaucracy. Appearance: 5'5" and 130 lbs.; "pure" Alphatian coloration (near-white skin, black hair and eyes); very beautiful and proud of her looks, wearing her hair near floor-length when unbound, and preferring dark gowns which accentuate her pale skin; apparent age 30 (real age 50).

Thothia (Edairo): *Ramenhotep XXIII* (C15, C, of the Night Spider) and *Queen Aketheti* (Monster, C—special, see below) rule here. *Ramenhotep* is a cleric of the Night Spider, an Immortal demonic creature known only to him, *Aketheti*, and a few privileged others. *Aketheti* is a daughter of the Night Spider, and possesses all the powers of a vampire, a planar spider, and a 15th-level magic-user; she constitutes a 16-HD creature; her natural form is that of a giant spider but she can change between it and her beautiful human form at will. Appearance of *Ramenhotep*: 5'10", 150 lbs.; native Thothian stock (dark-skinned, black hair and eyes); aristocratic features; often has dreamy expression, when meditating; wears kilt, linen tunic, golden crown of Thothia; age 50. Appearance of *Aketheti*: 5'2", 110 lbs; apparently native Thothian stock; beautiful and compelling features; speaks for her husband; wears Thothian-style robes, golden crown of Thothia; apparent age 20 (actually several hundred years old).

Caerdwicca: This dominion is ruled by *Thane (Baron) Uthgaard McRhomaag*

(F20, C). *Uthgaard* is a free-willed fighter and pirate; he enjoys nothing so much as sailing the seas, sacking some ships and demanding tolls of others (depending on his mood, which is quite variable). Appearance: 5'8", 180 lbs (stocky); red hair and great shaggy beard; blue eyes; massively freckled; wears great tartan kilts; age 40 (real and apparent).

Furmenglaive (Castle Furmenglaive): This night-haunted spot is ruled by *Count Phileus Furmenglaive* (F36, L) and *Countess Lyra Furmenglaive* (C36, L, of Protius). They've ruled here for over 40 years and don't mix much with the commoners. There's a reason for this: They're both noble ex-adventurers who were afflicted with the bite of the werewolf. Sad and weary of their curse, which forces them to chain themselves up on the nights of the full moon, and yet unwilling to sacrifice themselves to break the curse, they keep a minimal staff in their castle and go abroad only when their duties require it of them. It would be easy to work up an adventure around the quest to free them from their curse. Appearance of *Phileus*: 6'2", 170 lbs.; black hair and blue eyes; elaborate mustache; wears military-style clothing in gray and black, with armor enamelled in black; apparent age 30 (real age 60). Appearance of *Lyra*: 5'9", 140 lbs; brown hair and eyes; wears robes bearing the symbol of the Immortal Protius, with ordinary plate armor; apparent age 30 (real age 60). Unlike most of the characters listed in these pages, they don't maintain youthfulness through use of *potions of longevity*; they are kept young by their lycanthropic curse.

Kendach (Fortress Kendach): *Countess Julia Kendasius* (C24, N, of Halav) rules this dominion. She's an ambitious woman who wants Kendach to become the most powerful region in the Isle of Dawn; she has, since she took control of Kendach ten years ago, instituted a plan of military growth and fortress-building which alarms her neighbors. Appearance: 5'10", 140 lbs; blond hair, brown eyes; wears white uniforms with blue surcoats bearing the symbol of the Immortal Halav; age 40 (real and apparent).

West Portage: The ruler here is *Guildmaster Lareth Kubek* (T20, N). He's not a dominion-ruler, just chief townsman of the town. He's also Guildmaster of the Minrothad silk trade through West Portage. He's also a 20th-level thief, and effectively uses his Guild cover to plan and execute robberies of goods-caravans passing through; many thieves and bandits operating along the portage trail between East and West Portage answer to him as well. Appearance: 6', 170 lbs; common Alphatian, copper skin; golden-brown hair, green eyes; extraordinarily handsome; wears subtle brown garments with his guild badge and badge of office on the shoulders; has a quiet, unassuming, friendly manner; age 30 (real and apparent).

Redstone (Redstone Castle): The garrison commander here is *General (Lord) Harantius Lycrandonion* (F36, L), hand-picked by Emperor Thincol for this post. He is a strong-willed, gruff, fast-thinking commander who knows how to train men and hold a besieged position—which he's had to do a couple of times in the ten years he's commanded this fort. Appearance: 6'3", 230 lbs; Nuari ancestry, skin black; hair and eyes black; he wears the standard Thyatian military uniform in the bright red hue of the Redstone garrison; apparent age 40 (real age 60).

Grand Duchy of Westrouke (Newkirk): *Archduke Donegal Firestorm* (F30, N) is the nephew of Thincol, and like the Emperor was born and reared in Oceansend. No follower, he sets his own rules for Westrouke and plans for it to be an independent nation like *Karameikos*. He rules from his powerful castle in Newkirk. Appearance: 5'10", 190 lbs; red-blond hair and blue eyes; affects clothes like the black-with-gold-trim uniform of the Hattian foot-soldiers; apparent age 30 (real age 50).

Helskir: *Eruul Zaar* (F27, C) is the ruler here. He is more than a little impetuous, prone to speak his mind, and rebelliously resists Empress Eriadna's efforts to keep him "in his place"—i.e., as a powerless warrior serving the Alphatian magic-using elite. He might give his loyalty to Alphatia if he were granted full kingly title . . . but even then it's doubtful. Ap-

Other Territories

pearance: 6'4", 220 lbs; common Alphatian stock, dark brown hair and amber eyes; wears long tunic, trousers, belt, boots, cloak in bright blues and golds, armor enamelled in the same colors; age 45 (real and apparent).

Campaign Use

The Isle of Dawn is very useful as a place for you to showcase the ongoing squabbles between Thyatis and Alphatia. Short border wars often break out between Westrouke and Dunadale, or East and West Portage; on the few occasions of all-out war on the island, every Thyatian city will fight every Alphatian city. Player-characters can find employment here as fighters, spies, merchants, and diplomats between the two empires. The mysteries of the great southern escarpment require exploration that your PCs can provide—and a good place for them to establish dominions, dominions which might change imperial hands with the blink of an eye.

For an elaborate adventure involving the Isle of Dawn and your player-characters, pick up *M5, Talons of Night*, which goes into much greater detail on Thothia, her inhabitants, and the opportunities for cataclysmic political adventures on the island.

NORWOLD

See page 75 for a map of Norwold.

History

Norwold has long been an area of contention between the two empires . . . but it has generally been a minor one, and Alphatia has usually won the contests concerning this land. Not long after the first Thyatian/Alphatian War, Thyatis built a trading post (probably more a disguised military post) in this region. Alphatia immediately hired mercenaries to attack it and burn it down, and that was that.

In the intervening centuries, a scattering of settlers—especially halflings, and humans from the nearby Heldann Freeholds—established villages in this region.

A century ago, Thyatis built a good-sized city (Oceansend) here, and Alphatian interference didn't burn this one down. Oceansend remained a Thyatian colony until the Alphatian attack on Thyatis of some 40 years ago—at that time, Oceansend declared her independence, an independence which she precariously maintains even today.

In the years since then, pirates and thieves established the thriving criminal city of Landfall. More recently, Ericall, second son of Empress Eriadna, reached adulthood and began feeling the call of his royal blood . . . and agitating for a dominion of his own. He'd always been an embarrassment to Eriadna; Ericall, like all the sons of General Torenal, had absolutely no magical potential at all, and had dedicated himself to becoming the best fighter he could—small consolation.

Eventually, his mother, anxious for him to cease annoying her, granted him the city of Alpha in the region of Norwold, plus the kingship of all Norwold (if he could control the country), control of Helskir on the Isle of Dawn, and a great degree of autonomy (if he kept Norwold out of Thyatian hands, paid his tributes, and didn't cause her trouble).

He has now ruled Norwold for eight years—with mixed results. He has appointed Lernal the Swill, his half-brother (another son of Torenal, not of Eriadna), as governor of Landfall . . . but the real power in Landfall still belongs to its powerful Thieves' Guild. Ericall has failed to bring King Yarrvik of nearby Oceansend under his sway. When his younger half-brother Farian was visiting Norwold, a Thyatian raiding expedition captured and carried off the young man—and Farian remains in Thyatis still, much to Ericall's embarrassment. Ericall believes this string of events to be the result of bad luck, and doesn't realize that he's just not a very good king.

Culture

Norwold is an odd mix of cultures, more a melting-pot of races than any other site in the Alphatian Empire. The basic stock of the people is that of the Heldann Freehold—fair-haired farmers and fighters, lovers of good land, good drink, and good stories. Add to it the Thyatians, who founded Oceansend and have spread out from that city—Thyatians with their cosmopolitan ways and sly manners. Then mix in the now-dominant Alphatians with their chaotic and free ways, and you have the primary ingredients of Norwold culture. All in all, it's a good mix; the population has respect both for magic and fighting ability, a love of the sea and the land, and a marked tolerance for the halfling and elf communities found in this land.

Heldann is still the Common Tongue among the common people, but Alphatian is the principal language spoken among the nobility—except in Oceansend, where Thyatian is the Common Tongue.

Geography

Norwold is a northern land with a temperate-to-chilly climate. The land includes hundreds and hundreds of miles of virgin wilderness characterized by evergreen-covered hills and mountains, still clear lakes, and occasional bogs. The land turns to tundra in the far north.

Various cities and other sites of Norwold include:

Alpha: Population 30,000 (city of Alpha) plus 60,000 (surrounding countryside). This is a prosperous city surrounded by very rich farmlands and possessing a very good port. Alpha features an enormous royal fortification that can temporarily house 10,000 refugees. Alpha, of course, is the royal capital of Norwold, the seat of King Ericall's power, and the largest city of the kingdom—in spite of the fact that settlement only began here 15 years ago, building of the royal fort started only ten years ago, and Ericall took the throne only eight years ago.

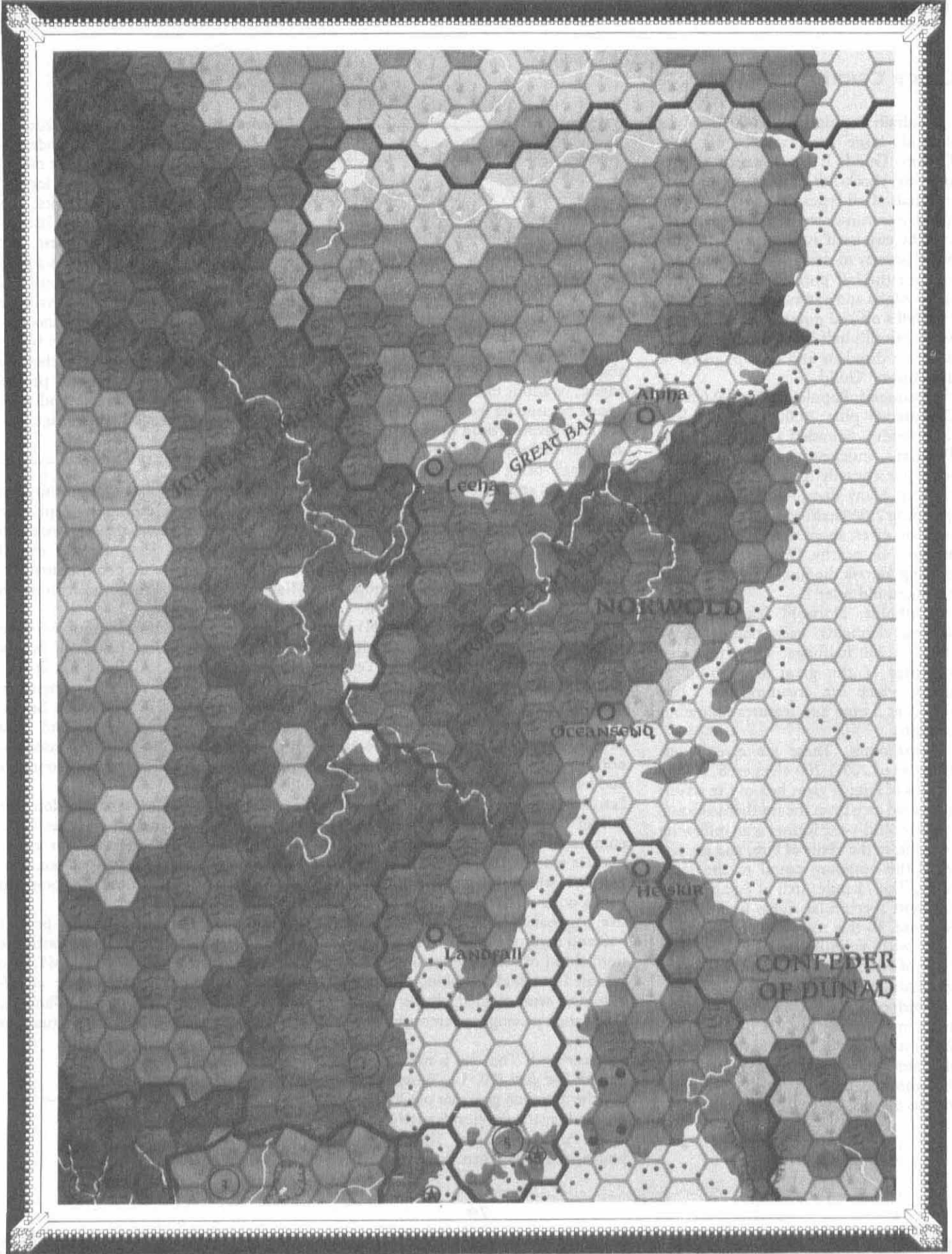

Other Territories

Landfall: Population 10,000. This is a squalid, large town run by its local Thieves' Guild. It is a town of poverty and dirt, chock-full of robbers and petty criminals of all types. Its governor's residence is a run-down wooden mansion, and the city itself is unfortified, relying on its poverty to deter raiders. Nevertheless, it's the last port on the northward sail to Alpha and so sees a lot of sea-trade. Landfall's official governor is Lernal the Swill, Ericall's half-brother, but Lernal is merely a drunken and corrupt pawn of the Thieves' Guild.

Oceansend: Population 20,000 (city of Oceansend) plus 20,000 (surrounding countryside). Founded a century ago by Thyatians, independent for the last 40 years, it is a heavily-fortified and prosperous city. Many demi-humans live here, including 2,000 halflings, 3,000 dwarves, and 500 elves; more demi-human communities lie nearby. Oceansend is ruled by King Yarrvik the Just, a canny and experienced old ruler.

Clanholds: Norwold features many halfling clanholds, each populated by 700 to 1,200 halflings. They have clan meetings at the great stronghold of **Leeha**, which can accommodate 2,000 visitors at a time and features numerous fine inns.

Foresthomes: These are elven communities of 200-1,200 elves each.

Arch of Fire: A great belt of fire travels in a broad arch from the northern volcano to the second—the former is an inflowing portal from the Plane of Fire, and the latter is the outgoing portal to the same plane. The 75-mile Arch of Fire is one of the most spectacular sights found in all Norwold. In this region, there are many caves with wormholes leading to the Plane of Fire and elsewhere—and Fire Elementals guarding them.

Whirlpool: A great whirlpool some 20 miles in diameter lies off the Norwold shore; it is a vortex opening to the Plane of Water. Many water elementals lie in the whirlpool and try to drag seagoers into its depths.

Characters

Important NPCs and likely encounters in Norwold include:

Alpha: *Ericall, King of Norwold* (F28, L). The second son of Eriadna the Wise, Empress of Alphatia, Ericall is eager, honorable, good-natured, and likeable. His ambition is to be a great king. But he's naive, even after nearly a decade of kingly rule; he doesn't like paperwork and managerial duties and so delegates them to subordinates of varying levels of ability; he doesn't listen to criticism or advice, or admit to mistakes; and he still smarts because he feels he was his mother's least favorite child (he may be right) and was the object of ridicule by Eriadna's magic-using children. He tries to be too perfect, and is doubly harsh on himself whenever he fails. Appearance: 6', 175 lbs; pure Alphatian strain, pale of complexion, black hair and eyes; striking features; prefers rich clothes in royal purple, trimmed in gold, but wears properly battered armor into combat; age 30.

Landfall: *Lernal the Swill* (F6, N) is a younger son of General Torenal of Alphatia, but not of Eriadna the Wise. Lernal shares his father's and brother's utter lack of magical potential. Ericall foolishly gave in to Lernal's pleas for a dominion because he knew what it felt like to be a non-magical noble's son in Alphatia . . . and has regretted the decision ever since. Lernal has grown up a drunken wastrel, devoid of scruples, a compulsive liar, a criminally weak and incompetent governor. He is a tool of the Thieves' Guild of Landfall, which keeps him well-supplied with booze and the trappings of his office. Appearance: 5'8", 200 lbs; brown hair and eyes; common Alphatian coloration; florid of complexion, broken veins in nose from heavy drinking; wears slovenly and wine-stained clothes of good fabric and tailoring; apparent age 35 (real age 24).

Oceansend: This city is ruled by *King Yarrvik the Just* (F9, L). Yarrvik's father was the Thyatian governor of Oceansend; his mother, the governor's northern wife. When Alphatia attacked Thyatis some 40 years ago, Yarrvik, then 25, got his father's

support and assumed the title of King of Oceansend, declaring the city independent of Thyatis. Thyatis has never moved to reconquer the city, but has had increasing numbers of spies, diplomats, and blackmailers in Oceansend in the last several years. Gruff, painfully honest, and stubbornly independent, Yarrvik is a good king for Oceansend. He likes Ericall and may ally with him, but only if Yarrvik can retain the title of King. Appearance: 6', 180 lbs, in good shape despite age; brown hair and blue eyes, broad mustache; fair Northern Reaches coloration; prefers good-quality but comfortable and non-showy garments in subtle colors; age 65.

Campaign Use

Norwold is a Land of Opportunity for player-characters, especially Alphatian PCs. It's a land where they can establish cominions under King Ericall's overall rule; he's desperate for good, honest, reliable heroes to rule dominions in Norwold.

It's also a bone of contention between Alphatia and Thyatis, both of whom claim the nation. Alphatia has it currently; Thyatis will doubtless scheme to gain possession of it. PCs could be dominion rulers defending the land from the Thyatians, or Thyatians promised dominions if they will help in the country's conquest.

Norwold, being mostly unexplored, is also a Land of Opportunity in that sense. There's no telling what ancient cities, long-lost races, bizarre regional monsters, and other surprises could be found in those deep, cold woods.

Several adventures have been printed about Norwold and its relations with the two great empires; they include M1, *Into the Maelstrom*; M2, *Vengeance of Alphaks*; and CM1, *Test of the Warlords*. All elaborate on the NPCs and situations presented here.

Ochalea

Ochalea appears on the map on page 78.

History

Settled in the centuries after Alphatian Landfall by common Alphatians with no magical potential, Ochalea grew to be an independent-minded dominion of hard-working people. Clerical concerns occupied the population in lieu of magical interests, and the Ochaleans became very reserved, very scholarly people devoted to honoring the Immortals.

Ochalea provided a lot of grain and livestock to the Alphatian Empire in the five centuries before the first Thyatian/Alphatian War. During that war, though, the Ochalean king saw the opportunity to establish complete independence for his nation and threw his lot in with King Lucinius. It was a good decision, and Ochalean clerical magic helped Lucinius achieve Thyatian independence. But that king was murdered by General Zendrolion when Lucinius was—and practically before the Ochaleans realized that they'd won their war, they were occupied by Thyatian imperial troops and ruled by a Thyatian-appointed king.

In the centuries since, Ochalea has remained a Thyatian region; it is counted as a Grand Duchy in the Empire.

Culture

Ochaleans are quiet, reserved people who place great importance on manners and proper behavior. They do not approve of women adventuring—but cannot legally interfere when an adult Ochalean woman wants to take up a military or adventuring life.

Magic-users are tolerated, but not liked or trusted, in Ochalea. Known thieves are similarly distrusted, as are demi-humans. Only human fighters and clerics receive the trust of Ochaleans.

Geography

As you can see on the map, Ochalea is a long, curved island separated from the Isle of Dawn by a strait barely 50 miles wide. It's a very rocky, hilly island, not pretty but agriculturally productive.

It has many hundreds of villages and small towns, but only one true city:

Beitung: Population 50,000 (City of Beitung) plus 75,000 (surrounding territory). This was the old capital city of the Ochalean king, and is now capital of the Ochalean Archduke. It features elegant sloped-roof architecture and intricately-designed buildings and Immortals' temples. Also here is a Thyatian naval fortress.

Characters

Archduke Teng Lin-Dieu (C36, L, of the Immortal Koryis) is the titular ruler of Ochalea. He is a reserved but friendly scholar who rules his island duchy well, and considers himself as much Thyatian as Ochalean. His life's quest involves understanding the true desires of Koryis and teaching the Ochaleans to direct themselves to those goals. Appearance: 5'10", 160 lbs; Ochalean ancestry (coppery skin, almond-shaped eyes, like common Alphatians), brown hair and eyes; very creased features and a nearsighted squint; wears the standard featureless Ochalean outfit but in royal jade-green; age 40.

Campaign Use

Ochalea is an exotic land for player-characters to visit—a land with an oriental feel and concerns. It's a place where you, the DM, can put them off-balance by having their ordinary actions and mannerisms be thought rude by the politeness-minded Ochaleans, and where their best efforts to correct matters only get them in more trouble.

It's also a land where they can befriend people who are constrained by rigid Ochalean customs—for example, young women who wish to become adventurers but are hesitant to defy tradition to do so.



THE PEARL ISLANDS



ISLE OF DAWN

AEGOS

Aegopoli

ALACIAN ISLANDS

BEILING

OCHALEA

Seagirt

DWAIR

PUIR

TUAR

KUIR

NUAR

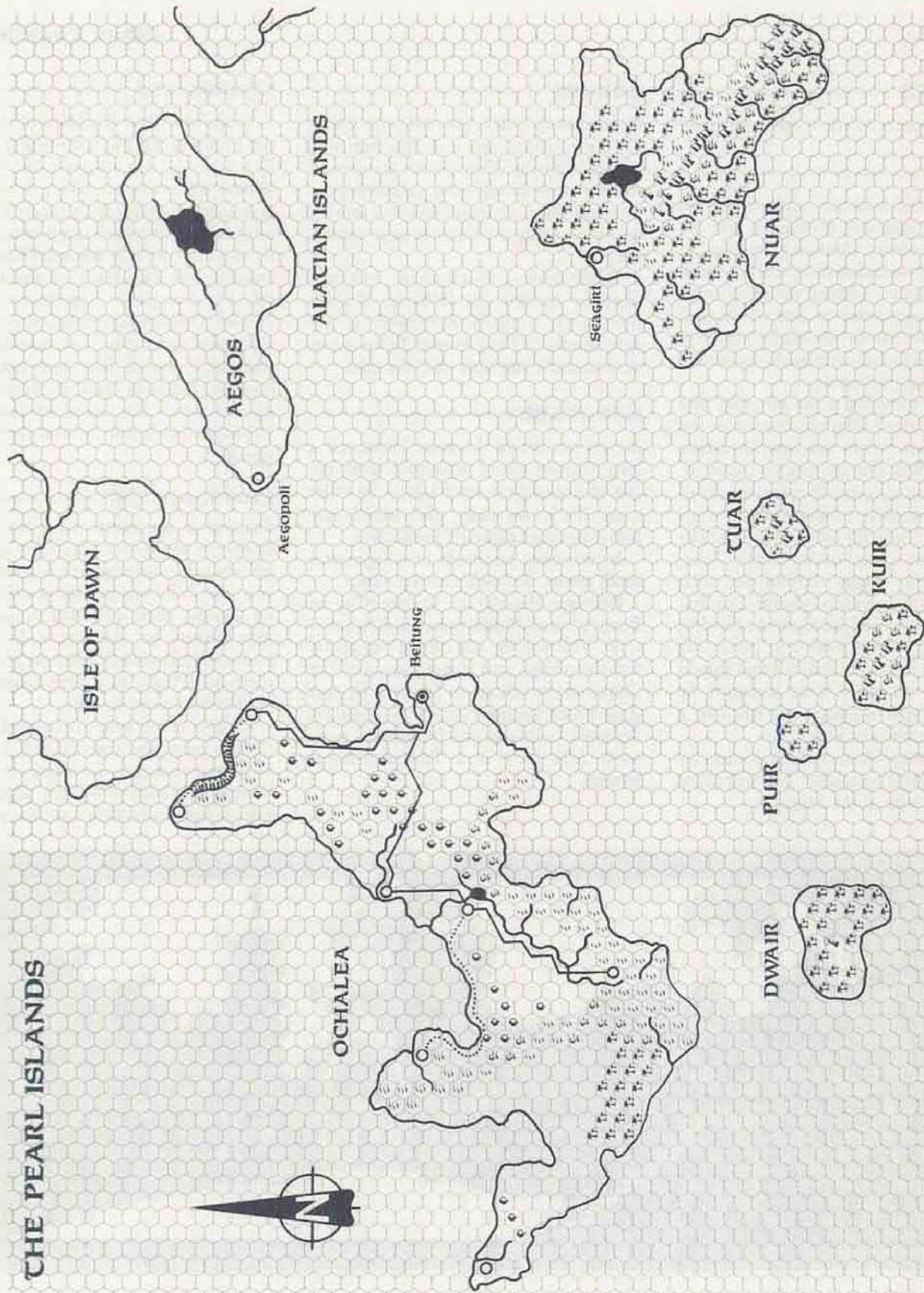



Pearl Islands

The Pearl Islands appear on the map on page 78.

History

Long ago, perhaps as long ago as Alphantian Landfall (BC 1000), black explorers from far, far to the east discovered and settled these islands. The origin of these explorers isn't known; it might be far-away Tangor (see the map in the *Master DM's Book*) or even farther east, off the map of the Known World.

These people named the largest island of the chain Nuar (from an ancient word in their language, Nu-ar, meaning "Western Home") and eventually called themselves the Nuari.

Eventually, the Alphantians discovered these admirable people and, as is their fashion, decided to add the Nuari to their Empire. Though they were great warriors, the Nuari couldn't withstand the Alphantians' magic and so succumbed.

However, when the Thyatian revolution of BC 2 offered them hope for freedom, the Nuari cast their lot with the Thyatians. But like the Ochaleans, the Nuari were betrayed by General Zendrolion when he killed King Lucinius and the Nuari and Ochalean kings . . . and sent occupation forces to Nuar.

About twenty years later, when Zendrolion I died, it seemed as though the Nuari would be able to achieve independence again. But Empress Valentia the Justiciar, a canny politician, had learned much about the psychology of the Nuari and so played a hunch. She made her Citizens' proclamation and then, in secret council with the son of the former Nuari king, formally invited the Nuari into the Empire—of their own free will, and as full Citizens, no coercion.

Had the Nuari nobleman refused, it's likely that she simply would have re-occupied Nuar—that sort of deceit is the Thyatian way, after all. But he didn't; after due deliberation, he accepted, and ever since the Nuari have been Citizens of Thyatis.

Culture

The description of the Nuari culture in the "Overview of Thyatis" in *Book II* is substantially correct. These people are devoted to building themselves up into the greatest men and women they can be. They are a race of over-achievers, scholarly warriors, and widely-read peasants, and they have a national contempt of laziness and lies.

There are some indications in Nuari records and folklore that the Nuari used to be a matriarchal society, but adopted the Alphantians' principles of sexual equality

when they were in Alphantian hands.

Geography

You can see on the map that the Pearl Islands consist of five fairly large islands (Nuar, the largest, is also the farthest east). There are many more tiny islands in the chain—these are too small to be shown on the average map, and you're encouraged to add as many as you wish for your own campaign.

The Pearl Islands are a volcanic chain, but most of the volcanoes are dead—with the exception of Mount Morimoru at the center of the great island of Nuar, which throws up some lava, ash and poison gases every fifty years or so. Almost every island in the chain consists of a semitropical jungle surrounding a lonely, craggy volcanic peak.

The Islanders live in small villages spread evenly across the island chain. There is one large community:

Seagirt: Population 5,000. This is the Thyatian Navy's port, from which naval vessels ply the seas to keep them safe from pirates, to keep shipping-lanes open, and to keep an eye on Alphantian sea-traffic coming down from the Alantians. This is also the major trading post for the pearl-trade of the Pearl Islands; traders from Thyatis, Alphantia, and the Minrothad Guilds all dock here to dicker for the lustrous pearls.

Other Territories

Characters

The ruler of the Pearl Islands is:

Archduke Nurokidu Nuar (T36 (Rake), L). Nurokidu (he allows no one to refer to him by his title) is the latest ruler in a long line of Nuari leaders. He's one of the "non-thief thieves" (rakes) described in the "Character Creation" section of *Book II*. He enjoys adventuring, sailing, exploring all the little islands of the chain, and teaching children to achieve greatness. His wife is long dead, and he was never able to father children; these are the sole dark spots on his otherwise happy life. Appearance: 6', 155 lbs; native islander stock (skin black); hair and eyes black; wears unadorned white Pearl Islander kilt and numerous strings of colorful shells; age 50.

Campaign Use

In a campaign, the Pearl Islands are a staging area for characters to have adventures in the far east. Perhaps they'll be hired to explore far-distant lands to find out where the Nuari people originally came from. The Pearl Islands would also be a logical first target for conquest from invading navies of far-eastern island territories (presumably such as Oceania and Cestia; see the map on the inside covers of the *Master DM's Book*).

If you wish, you can use the live volcano on Nuar as a portal to the Plane of Fire.

Qeodhar

Qeodhar appears on the map on page 69.

History

Qeodhar is a far-north island kingdom settled ages ago by the same Yannivey human race that had once inhabited all of Alphatia. Cold and mountainous, it was ignored like the Yannivey island chain by the Alphatians through the centuries of Alphatian imperial expansion. Five hundred years ago, the Qeodhar king swore allegiance to the Empire in the hopes that it would improve his trade with the Empire (which it did) and would encourage

powerful Alphatian magic-users to immigrate and make the island more habitable (which it didn't).

Since then, Qeodhar has had a singularly undistinguished history as an Alphatian-controlled dominion. It conducts brisk trade in seal-skins with the Alphatians; its whalers are the equal of any in these waters. It has sent naval forces to aid in Alphatia's wars. It has weathered the attacks of some reckless sea-voyaging frost giants from Frosthaven. And that's all.

The new king, "Baron" Norlan, grew up in this disinteresting atmosphere and, when he took the throne, vowed to make Qeodhar a power to be reckoned with in the Empire. He planned to wed a daughter of Empress Eriadna, impress the courts of Alphatia with his dashing manner and noble bearing, and help Qeodhar achieve the reputation for brilliant seamanship that it deserved.

Unfortunately for his plan, the Alphatians have no respect for non-spellcasters, Eriadna didn't want him to have anything to do with her daughter, his efforts to develop a "dashing manner" have been regarded as insolence and arrogance, and the chilly waters around Qeodhar just don't swarm with sea-monsters or pirates—leaving him with very little for his navy to do domestically.

Culture

Culture, if it can be called that in Qeodhar, is of the "fisherman survivalist" variety. Most of the people on Qeodhar are fishermen, whalers, and seal-trappers; they work, live in their villages, and go about their business in a singularly disinteresting manner. Few in Qeodhar are literate; many are excellent craftsmen of seal-skin and whale-bone items.

Geography

The island is dominated by high, cold central mountains. Those mountains keep the town of Farend from suffering the full brunt of the north winds, but also limit the amount of arable land on the island.

Qeodhar has many small coastal villages on the southern coast. The great seal grounds are all on the northwestern coast, and there you find many trappers' villages as well.

And the island has one community of decent size:

Farend: Population 3,000. This is Qeodhar's principal port and trade station. In addition to fishermen and whalers, you find many merchants and traders, professional sailors and soldiers here. Norlan's mansion is in this fortified town, which is otherwise characterized by stout stone dwellings, a broad bay, and chilly blasts of wind from the north practically year-round.

The sea west of Qeodhar is called the Norzee by the natives, and the king of Qeodhar traditionally bears the warlike title of Scourge (*kjavik*, in their tongue) of Norzee.

Characters

The ruler of Qeodhar is *Baron Norlan* (F18, C). Like many Alphatian dominion rulers who like to appear swashbuckling and roguish, he uses the title of "Baron" although he is counted as a king by the Alphatians. He's an ambitious, humorless man who is quick to avenge an insult or betray someone whom he no longer needs. He is in love with—or at least has matrimonial ambitions upon—Empress Eriadna's daughter Mariella, and is insulted by Eriadna's continued refusal to let him wed her. He still has a limited grasp of the Alphatians' dislike of the state of marriage, and has a firm grasp on the idea that, because he's no magic-user, Eriadna doesn't want him associating with her daughter. He has been sending secret negotiations to Thincol in Thyatis, hoping to switch allegiance to that empire—for greater personal importance in that Empire.

Campaign Use

Qeodhar is a spawning-ground for trouble in the Alphatian Empire. No one in the empire believes that Norlan could or would cause any real trouble—but the man has won the affections of Princess Mariella of Alphatia, who is at least infatuated with him, and who supports him and his aims. She could run off to join him—prompting the Empress to send close-mouthed player-character adventurers after her, to retrieve her with no fuss, no noise.

Mariella, blindly devoted to Norlan, might even be persuaded by him to deliver Eriadna into his hands—of course, his promise that she would come to no harm could be utterly false. Qeodhar might sell Eriadna to Thincol of Thyatis, or ransom her for greater power within the Alphatian Empire—prompting her family to send PC heroes to rescue her quietly, before the Empire became aware that anything was awry.

The Yannivey Chain

The Yannivey Chain appears on the map on page 69.

History

Before the Alphatians made Landfall on the Known World, the island now called Alphatia was the home of humans called *Yanifey*. These were light-skinned, pale-

haired, primitive tribesmen who fashioned their war-implements out of stone and warred on one another all the time.

When the Alphatians came, most Yanifey tribes were subjugated, their warriors turned into slaves of the Empire. Some escaped in their outrigger canoes to the cold, barren islands to the north— islands which eventually became known as the Yannivey Chain.

The most western of the Yanniveys, Qeodhar, was also the richest, making a brisk trade with the Alphatians. But the other islands were mere rocks where the surviving Yanifey tribesmen could eke out meager existences by fishing.

Eventually, the Yanniveys became known as a refuge for outlaws. Fugitives from the Empire ran to safety in these cold, uncharted islands and waters. Gradually, the population became a breed mixed from the fair-skinned and -haired Yanniveys and the copper-skinned and brown-haired Alphatians; today, the Yanniveys have an olive skin-tone and sandy hair which grays early in life.

Today, the Yanniveys are still best-known as a haven for fugitives. Alphatian criminals flee there, hide out for a few months or years, eat enough fish to drive them mad, change their names and their appearances, and return to the civilized world.

Culture

Life is harsh in the Yanniveys. The human

communities, consisting almost exclusively of fighters and thieves, are small and always dominated by some hard-bitten, amoral criminal. Newcomers to these islands had better demonstrate some real talent with fishing or a criminal activity or they will be killed, stripped of goods, and dumped into the cold sea.

Each village has a ruling class of men and women who live by the sword, and who often have some medium-sized ship for piratical endeavors. Each village is mostly supported by hard-working fishermen who pay too-great percentages of their catches to the rulers for "protection."

No one stays in the Yanniveys longer than he has to—other than descendents of the original Yanifey tribesmen—and so a village may go through from two to six new rulers and ruling councils in a single year.

Geography

These islands are cold, barren rocks separated by deep channels of treacherous waters. There are no communities of any size in all the Yannivey Chain.

Characters

A typical Yannivey NPC encounter is:

Toriath the Black (F12, C). Toriath, an Alphatian brigand, was sentenced to slavery for crimes against the merchants



Other Territories

of Aasla but escaped from the galley where he was serving his sentence. He escaped to the Yanniveys and took over a village of 75 souls from the criminal who ruled it at the time. He renamed the village Toriath, as the previous ruler had given it *his* own name. Toriath is always on the lookout for experienced pirates and thieves to add to his diminutive gang; if he develops a sizeable enough force, he'll be able to turn once again to full-time piracy and leave his island behind. He's prone to terrific rages and tantrums, suffers no order to be disobeyed,

and aspires to start himself a harem—beginning with the first attractive female player-character to encounter him. Appearance: 5'9", 170 lbs.; "pure" Alphetian coloration (white skin); black hair (severely balding), mustache, beard, black eyes; dresses in a threadbare naval uniform taken from the last man he killed; age 45.

Campaign Use

The Yannivey Chain is a place to send the PCs to perform some unpleasant duty—out of necessity, or for which they'll be well paid. Such duties include: Fleeing the authorities because of criminal charges (either false or real); finding the child of an important Alphetian, the child and his/her boat having disappeared in Yannivey waters; capturing a notorious criminal who has escaped to the Yannivey Chain; finding a famous hermit who settled here years ago expressly to get away from adventurers; and so on.

Campaigning

In this chapter, we'll be discussing some rules and guidelines which should make it easier to DM campaigns in the empires of Thyatis and Alpathia.

Aerial Movement and Combat

The Thyatians have the Retebius Air Fleet and the Knights of the Air. The Alpathians have gigantic flying ships and apparatus. It's no wonder that there have been numerous aerial clashes between the two empires . . . or that your player-characters of either empire will end up doing some sort of aerial combat, if only with a flying mage blasting ground-borne troops.

If you wish for your players to be well-versed in the rules of aerial movement and combat, you can let them read this section. Otherwise, they can rely on the information given to them in the "Knights of Thyatis" section, while only you know the whole truth.

Aerial Movement and Scale

When conducting aerial combats, we use ordinary 21mm or 25mm blank hex-sheets to represent the aerial battlefield and the ground beneath it. Each hex represents 10' of distance. For larger-scale combats, use 5mm hexes and simply draw the combatants' flight-paths on the paper; miniatures are too bulky in that scale.

Aerial battles are conducted in the normal combat sequence and time scale.

Use the miniature representing the piloting character to represent both character and mount. If the flying object is a larger construction, such as a vessel or flying building, cut out a piece of construction paper or cardboard in the correct scale—the size of one hex equalling 10' (center-to-center).

Turning

For these rules, we rate every flying monster or vessel according to how fast it flies (this is just the "Move" score from the monster writeup, here called Air-Speed)

and how nimble it is in the air (called the Maneuvering Factor). These two characteristics determine the flying abilities of the mount or vessel.

The Maneuvering Factor

The Maneuvering Factor is the number of times in a round the monster or vessel can maneuver. A maneuver constitutes changing direction by 30 or 60 degrees, or initiating a climb or a dive.

Example: The gargoyle is a notorious flying monster. On the chart further on in this chapter, it has an Air-Speed of 50'/round and a Maneuvering Factor of 3. Therefore, in a normal combat round, the gargoyle can move 50' and, during that 50' move, can perform three maneuvers. The gargoyle might fly 10' straight ahead, maneuver to turn 60 degrees to the left, maneuver to begin a climb, fly 20' more, and maneuver to level off to horizontal flight, and fly 20' more in that fashion. Total: 50' flown, three maneuvers performed.

All flying monsters and vessels must move in multiples of 10' between maneuvers. All distance spent climbing must be calculated in multiples of 20'. It's too much trouble to keep track of distances otherwise.

Continuing an old maneuver doesn't constitute starting a new maneuver. Let's say a flying monster begins to climb. That counts as a maneuver. But on its next round, it continues to climb. That's not a new maneuver—it's a continuation of the old one. However, if the beast levels off to horizontal flight, *that's* a new maneuver.

Skill Use

The first maneuver performed in any round of combat is ordinarily "free"—if the rider or pilot is conscious and the monster or vessel is responsive, the maneuver is automatically successful.

But if:

(a) this is the second or subsequent maneuver by that monster or vessel in the same round; or

(b) the rider or pilot took one tenth of his hit point total in damage in the last round; or

(c) the rider or pilot has taken one half (round up) of his total hit points in total damage; or

(d) the rider and beast are taking off or landing in any really difficult situation (fierce cross-winds, for example); or

(e) there is any other circumstance present which the DM thinks would make maneuvering difficult (heavy rains, riding-beast spooked, etc.); then:

The rider or pilot must make a skill check against the appropriate skill—the pertinent Riding skill when riding a monster, or Piloting when controlling a flying vessel.

Example: Sir Tristosius is riding his pegasus. The pegasus has an air-speed of 160'/round and a Maneuvering Factor of 3. Tristosius wants it to move this way during this round: Fly 30' straight ahead, begin a normal climb for 40' more, then make two sudden 60-degree rightward turns and continue on for the remaining 90'. Tristosius and his mount are both unhurt and unfrightened.

The DM lets the pegasus fly the 30' straightaway with no problem—this doesn't constitute a maneuver. He lets the pegasus perform the climb with no problem; that's his first maneuver. Then, for each of the 60-degree turns, he has Tristosius check his Pegasus Riding skill.

Failure of the Riding check can mean any number of things; a chart of sample fates is given a little later in this section.

Example: Tristosius has to make two Riding checks. He succeeds with no problem on the first one—but rolls a natural 20 on the second, a catastrophic failure! The DM looks on the Loss of Control chart, printed further in this section, and discovers that Tristosius has been thrown free. Tristosius has to rely on magical gadgets—if he has any—to get him down to the ground safely.

Climbing Rates

When a pilot/rider decides that his mount or vessel will *climb*, he's actually decided to trade in some of the flying object's forward air-speed for altitude. That's why climbing objects climb in increments of 20', as described above.



Climbs come in three varieties: The One-Maneuver Climb, the Two-Maneuver Climb, and the Three-Maneuver Climb.

One-Maneuver Climb

The One-Maneuver Climb is a smooth, gradual climb. During this maneuver, half of an object's 20' movement increment goes to forward movement, and half goes to climbing—and half of *that* amount is the actual distance climbed. So when you allot 20' to a One-Maneuver Climb, you move 10' ahead and gain 5' altitude.

If you put an odd amount of air-speed into a One-Maneuver Climb, the extra distance is lost. For instance, if you allot 50' movement to a One-Maneuver Climb, which is rated in 20' increments, you're actually allotting two 20' increments and losing that last 10' distance. If you change maneuvers to one where you can utilize that 10' movement, you don't lose it.

Two-Maneuver Climb

The Two-Maneuver Climb is a steeper, 45-degree angle climb. As the name implies, it requires *two* Climb maneuvers to commence. With this climb, you allot your flying movement in 30' increments. Each 30' increment allows the flier to fly forward 10' and gain 10' altitude.

As with the One-Maneuver Climb, if you put a non-standard movement rate into your Two-Maneuver Climb, you lose the extra movement. For example, allotting 70' causes you to lose the last 10' of movement, because a Two-Maneuver Climb is rated in 30' increments.

Three-Maneuver Climb

The Three-Maneuver Climb is a very steep, difficult climbing maneuver. As the name implies, it requires *three* Climb maneuvers to commence. With this climb, you allot your flying movement in 50' increments. Each 50' increment allows the flier to fly forward 10' and gain 20' altitude.

As with the One-Maneuver Climb, if you put a non-standard movement rate into your Three-Maneuver Climb, you lose the extra movement. For instance, if you allot 120' movement to a Three-Maneuver Climb, which is rated in 50' increments, you lose that last 20' of movement.

The DM is within his right to disallow specific monster types from attempting a Three-Maneuver Climb; for any winged monster, it's a terrific strain.

Example of Climbing

Tristosius is back on his pegasus—his feet are a bit flatter but he's richer in experience. His pegasus still flies at 160' and has a Maneuvering Factor of 3.

Tristosius decides to spend one whole turn in a One-Maneuver Climb. He orders his pegasus to perform that maneuver. Each 20' of movement becomes 10' moved forward and 5' gained in altitude; since the pegasus has 160' to "spend," this results in 80' forward movement and 40' altitude gained.

He decides to make the climb steeper on his next round—he adds one Climb maneuver to his One-Maneuver Climb, making it a Two-Maneuver Climb. Since this is his first Climb maneuver in this new round, it doesn't require a Riding check. With this type of climb, he trades 30' to move ahead 10' and gain 10' in altitude. He spends all of the pegasus' 160' air-speed this way; and so this round the pegasus moves 50' forward and gains 50' in altitude. The extra 10' movement is lost, since it is short of the standard 30' increment.

Tristosius decides to make the climb even steeper on his next round, and adds one more Climb maneuver—the pegasus is now performing a Three-Maneuver Climb. Since this is the first Climb maneuver in this new round, it doesn't require a Riding check. With this type of climb, he trades 50' to move ahead 10' and gain 20' in altitude. He spends all of the pegasus' airspeed on this climb. The pegasus moves 30' forward and gains 60' in altitude. This is a very steep climb, and the DM may be deciding that the pegasus is having to struggle madly to accomplish it. Again, 10' of the pegasus' normal 160' air-speed is wasted this round.

On his next round, Tristosius decides to level off. He is currently performing a Three-Climb Maneuver, and so it takes three maneuvers to regain level flight. He has to make a Riding check for the second and third maneuvers this round, and succeeds in both.

On his next round, Tristosius decides, crazily, to resume that Three-Maneuver Climb—in one round. He performs three Climb maneuvers at the start of the round and puts all of the pegasus' air-speed toward that steep climb. He has to make a Riding check for the second and third maneuvers this round—and he fails his first roll. The DM checks the Loss of Control chart and determines that, due to the circumstances of this flight, the pegasus has “stalled” and begun dropping like a rock—perhaps it's not built for such steep climbing.

We'll talk about losing and regaining control in a moment—after we talk about Diving.

Diving Rates

As with Climbing, there are three types of diving rates.

ONE-MANEUVER DIVE

In the One-Maneuver Dive, the beast moves 10' forward for each 10' allotted—but *also* loses 10' of altitude. This 10'/round figure is called the *Dive Rate*, and the player must keep track of it (the DM must keep track of it for NPCs).

TWO-MANEUVER DIVE

In the Two-Maneuver Dive, the beast moves 10' forward for each 10' allotted—but *also* loses 20' of altitude. This 20'/round figure is this maneuver's Dive Rate.

THREE-MANEUVER DIVE

In the Three-Maneuver Dive (also called the Crash-Dive), the beast plummets straight down—losing 2' of altitude for every 1' of its allotted Air-Speed, *and* losing 1,140' for every full round this dive is maintained.

In other words, the beast is falling—a controlled plummet. If the plummet is uncontrolled (for example, if the beast is unconscious or dead), you allot none of its Air-Speed to the dive, and merely fall 1,140' per full round.

Options for Dive Rates

If a flying beast has already used some of its air-speed this round, and then decides to begin a dive, it can naturally only use the Air-Speed it has *remaining to it* for the dive. Thus, if a pegasus has already used 80' of its 160' air-speed for the round, and suddenly decides to crash-dive, it will dive only 160' (2x the remaining 80')—plus the 1,140' of a full round of diving.

If the DM wishes, he can also divide that 1,140' figure by the amount of time remaining in the round. Let's say a pegasus moves 80' forward and then decides to Crash-Dive. That 80' is half its normal round's movement, so the DM decides that half the round has already gone by.

The pegasus spends its 80' move on a crash dive, and so dives 160' (80'x2). Since a diving creature loses an additional 1,140' per round when crash-diving, the pegasus loses an additional 570' (1,140' x 1/2) for the half-round remaining. At the end of the round, it has dived 730'.

Since that last option is a bit complicated, it's recommended only to DMs who like fiddling around with math.

LOSING AND REGAINING CONTROL

We've already established that it's possible to lose control when you fail a Riding or Piloting skill check. What happens then?

First, find out by how much the pilot or rider missed his skill check. For instance, if he has a skill roll of 14 but rolled a 16, he's missed by 2. Compare that number to the chart below:

Loss of Control Chart

Missed Mount/ Roll by Monster	Vehicle/ Construction
1-2 Ignores last maneuver	Ignores last maneuver (control error)
3-4 Accidental maneuver (DM choice)	Accidental maneuver (DM choice)
5-6 Uncontrollable for 1-3 rounds	Stalls into a Two-Maneuver until control regained
7-8 Stalls into Crash-Dive then uncontrollable for 2-12 rounds	Stalls into Crash-Dive until control regained
9+* Rider hurled free**	Pilot hurled free**

* Or a natural 20

** If he cannot be hurled free, he has been knocked unconscious for 1-6 turns

If the character is not tied down to his saddle or strapped into some sort of control chair, add 3 to the number by which

Campaigning

the roll was missed to determine what happened. The fact that the character was "loose" has contributed to the aerial disaster.

Here's what those brief crashing notations mean:

Missed Roll by 1-2: If the character is riding a mount, the beast just misses the last order—either balks and ignores it, or didn't understand it. If the character is piloting a vessel, he experienced a brief problem with the controls and the vessel didn't respond. In both cases, the mount or vessel just keeps on with the last maneuver given to it. Next round, it has the normal chance of responding to new orders.

Missed Roll by 3-4: If the character is riding a mount, it failed to perform the maneuver correctly and instead performs some other maneuver—chosen by the DM. It could be an unwanted turn, climb or dive of any sort up to the amount of movement the beast has remaining this round. If the character is piloting a vessel, the same thing takes place—but the pilot has to make a skill check to regain con-

trol. Otherwise the controls are stuck or some other calamity is keeping the vessel going in the same direction.

Missed Roll by 5-6: If the character is riding a mount, the mount has gotten very balky and absolutely will not respond to orders for 1-3 (1d3) rounds. If the character is piloting a vessel, his attempted maneuver appears to be successful—but the vessel immediately stalls into a Two-Maneuver Dive until the pilot regains control.

Missed Roll by 7-8: Things are getting serious. If the character is riding a mount, his maneuver badly confused or upset the beast. The beast stalls into a Crash-Dive. It gets one attempt to pull out at the end of this round, and (in each subsequent round) a number of tries equal to its Maneuvering Factor. The rider cannot help it with this—unless he has enough magic to carry the beast aloft himself! Also, once the beast does regain control, it is absolutely unmanageable for 2-12 (2d6) rounds—it does exactly as it wishes (DM's control) during that time. If the rider is particularly brutal with it during this

time, it may try to buck him free! If the character is piloting a vessel, the vessel stalls into a Crash-Dive and remains in that dive until control is regained.

Missed Roll by 9 or More (or Rolled a Natural 20): The pilot or rider is hurled free, if it is remotely possible. Even if he is tied to his saddle or piloting from within a cockpit, his restraints could break in the violent maneuvering and hurl him free. If the DM determines that he can't be hurled free, then the rider or pilot cracks his head on some protrusion and is knocked out for 1-6 (1d6) full turns.

How to Regain Control

Once a monster has lost control of its flight, it must regain control itself—the rider is just extra baggage until the beast is flying under its own power again. Flying creatures tend to fly very well. Each has the equivalent of a Flying skill roll of 15—plus its Maneuvering Factor (MFs of less than 1 are treated as 0). Thus, a beast with a Maneuvering Factor of less than 1

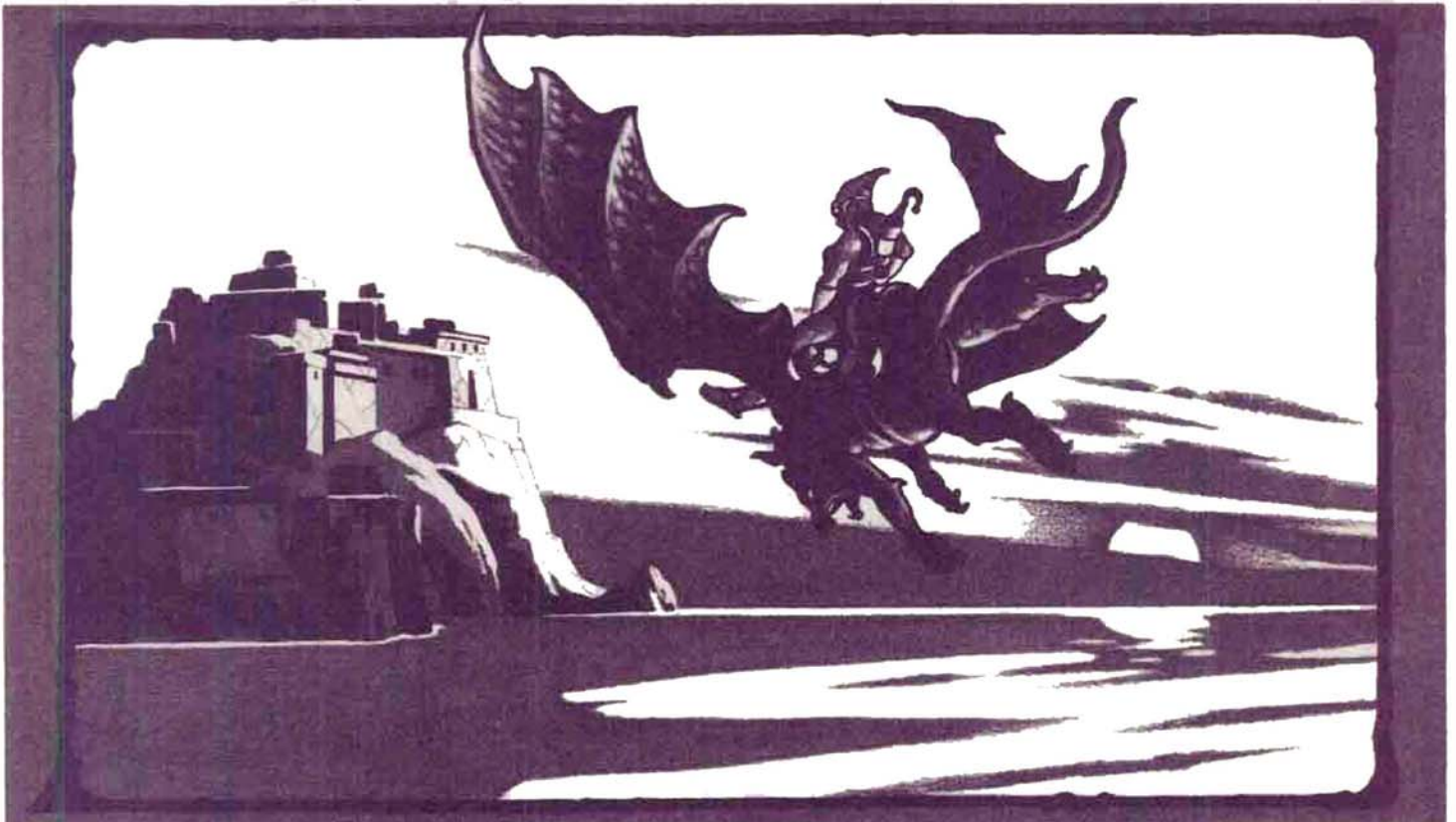

has a skill roll of 15; one with an MF of 1 has a skill roll of 16; one with an MF of 3 has a roll of 18; and so on.

At the end of the round during which it lost control, the beast rolls its Flying skill once. If it makes the check, it regains control. If it misses, it continues dropping. On subsequent rounds, it may try again a number of times per round equal to its Maneuvering Factor—or once per round if its MF is less than 1. It will either regain control—or crash into the ground, with the damage shown below.

Once a pilot has lost control of a vessel, he must make a Piloting check to regain control. He makes one check at the very end of the round when he lost control; thereafter, he may make a number of checks per round equal to the vessel's Maneuvering Factor (or once per round if its MF is less than 1). But the catch is this: He must make his Piloting check at a *minus equal to the number by which he missed it in the first place*. In other words, if he had a skill roll of 15 but rolled a 19, he missed by 4—and he can't regain control until he makes that skill check by 4! Again, if he doesn't regain control in time, he may crash into the ground.

Regaining control "in time" is determined by how high he was and how long it takes him to regain control. And that's what we'll talk about next.

FALLING AND CRASHING Damage

The standard rule of thumb is that one takes 1-6 (1d6) points of damage for each 10' fallen. That's all right at shorter distances, but for greater distances fallen, use the following chart.

Falling Damage Chart

Distance Fallen	Time Taken	Damage Taken
10'	Less than 1 second	1d6
20'	Less than 1 second	2d6
30'	1 second	3d6
40'	Less than 2 seconds	4d6
50'	Less than 2 seconds	4d6
60'	Less than 2 seconds	5d6
70'	Less than 2 seconds	5d6
80'	Less than 2 seconds	6d6
90'	2 seconds	6d6
100'-190'	3 seconds	9d6
200'-320'	4 seconds	13d6
330'-480'	5 seconds	16d6
490'-670'	6 seconds	19d6
680'+		20d6

This chart shows the damage from an all-out, unchecked plummet—or a Crash-Dive straight into the ground. It's easy enough to use. If you fall from an altitude of 80', it takes you less than two seconds to hit the ground, and when you do you take 6d6 damage—easily enough to kill low-level characters and hurt mid-level heroes.

Above 680', falling characters and monsters reach what is called *terminal velocity*—meaning that air pressure has stopped their groundward acceleration; they can't fall any faster. Therefore, it's impossible to take more than 20d6 from falling damage, regardless of how high you are. (Atmospheric reentry is another matter—but if your players' characters start to fall to a planet's surface from airless space, you had best have some scientific texts on hand to help you explain to them what's about to happen.)

As noted, the damage for the chart above is for unchecked plummets (like Crash-Dives).

One-Maneuver Dives reaching the ground do no damage; Two-Maneuver Dives reaching the ground do 3d6 damage to the mount or vessel and 2d6 damage to every rider or passenger within.

If you're curious about how far you fall and how fast, here's another handy chart:

Falling Distance Chart

Time Fallen	Distance Fallen This Second	Total Distance
1 sec	32'	32'
2 sec	64'	96'
3 sec	96'	192'
4 sec	128'	320'
5 sec	160'	480'
6 sec	192'	672'
7 sec	192'	864'
8 sec	192'	1,056'
9 sec	192'	1,248'
10 sec	192'	1,440'

Per Additional Second: + 192'
Per Additional Round: + 1,440'

This chart is also straightforward. If you want to know, for instance, how far you fall on the D&D® Known World in 9 seconds, you discover that it's 1,248' total. You've reached the Known World's *terminal velocity* of 192'/second by that time.

Flying vessels and cross-country aerial travelers tend to fly at an altitude of 1,500' or higher. For every 1,440' of altitude you have, you have a full round of preparation time in case something goes wrong.

Important Note: Above 20,000 feet altitude, or just shy of 14 rounds' falling time, it becomes very difficult to breathe—the air is too thin. At that altitude, it becomes necessary to use magic items based on the *create air* spell introduced in the "Character Creation" chapter of *Book III*.

KEEPING TRACK OF AERIAL MOVEMENT

When you're planning to run an aerial encounter of some sort, you'll find that you need to keep track of the positions—in three dimensions—of numerous beasts and vessels. This can be trying, but it's not impossible. Run your aerial combats on hex-paper. It will allow you to keep track of the relative two-dimensional positions of all the participants in the battle.

Campaigning

Then, you and each player should have a scratch sheet of paper with three columns on it, columns labelled "Starting Altitude," "Movement Spent," and "Dive/Climb Rate." The players need such a listing for their own airborne characters; you need one for each NPC you want to keep track of.

Example of Use: Tristosius, whose mount pulled out of that wicked dive, is now at 3,000', flying toward an airborne Alphatian ship beset by gargoyles. It's only about 80' higher than he, some 300' away.

This round, he makes a 30-degree course correction (one maneuver) to turn toward the stricken airship, then puts his whole movement in a One-Maneuver Climb. He has to make a skill check for that second maneuver, and succeeds. On the next round, he continues the One-Maneuver Climb. He does not need to make a skill check—this was not a new maneuver, and there were no extraneous factors to make him have to roll.

On the third round, he spends half his movement on the same One-Maneuver Climb, then levels off (one maneuver) for the rest of his movement—he wants to be a little above the keel of the ship and not quite to the vessel. He also wants some maneuvering distance for when the gargoyles come sailing out at him—which they will.

Meanwhile, his player is keeping track of his movements on the scratch sheet, as mentioned. At the end of three rounds, his scratch-sheet looks like this:

Starting Altitude	Movement Spent	Dive/Climb Rate
3,000'	160'	1-Maneuver Climb
3,040'	160'	1-Maneuver Climb
3,080'	80'	1-Maneuver Climb
3,100'	80'	- Level -

He doesn't have to keep track of his lateral movement and horizontal maneuvers on this scratch-sheet—he and the DM do that on the hex-sheet. But at the end of round 3, when the DM asks what his situation is, he can say "I'm at 3,100 feet, at level flight. I should be about 20' higher than the keel of the airship, and about

20' away from it." All the information he needs should be either on the hex-sheet or on his scratch-sheet; and the DM has the same advantages with his NPC fliers and vessels.

Damage to Flying Monsters

Of course, fliers don't just fly around—especially in combat situations. They and their riders and pilots also damage one another. You already should have seen what happens to vessels and flying constructions when they take damage—that was given in *Book III* in the "magic-users of Alphatia" section. Here, we'll show you what happens to flying monsters as they take damage.

The simplest way to handle damage to flying monsters is to have them lose flying ability as they take damage. When a flying monster has lost 25% of its hit points (it has 75% remaining, round up), it cannot perform any Two-Maneuver or Three-Maneuver Climbs. When a flying monster has lost 50% of its hit points (it has 50% remaining, round up), it cannot perform any Climb maneuver. Exception: If it starts out on the ground, it may use a climb to get up to a maximum altitude of 10'—but can climb no higher.

When a flying monster has lost 75% of its hit points (it has 25% remaining, round up), it cannot even keep to level flight. It must lose altitude in at least a One-Maneuver Dive—of course, it can dive faster. If it lands, it cannot take off again—it must rely on its ground speed.

When a flying monster has lost 90% of its hit points (it has 10% remaining, round up), it cannot even make a safe landing. It must lose altitude in at least a Two-Maneuver Dive, and will take 3d6 damage when it hits—with its riders taking 2d6 damage themselves.

When a flying monster has lost 100% of its hit points, it drops like a rock (*not* like a roc). It must lose altitude in a Three-Maneuver Dive—a plummet. Its riders take damage according to the distance they fall.

These conditions last until the beast is healed to a higher "bracket" of health.

These rules don't apply to air elementals, djinn, or persons or monsters utilizing *fly* spells. They are meant to apply to winged beasts, and the DM can disqualify any monster from these effects if he wishes to.

Monsters from the D&D® Books

On the next page is a list of most flying monsters presented in the *Basic* through *Masters'* sets of rules. It doesn't give all the characteristics you saw for monsters in the "Knights of Thyatis" chapter of *Book II*, but it does include the critical stats for more monsters.

Maneuvering Factor scores of $\frac{1}{2}$ and $\frac{1}{3}$ mean that the beast can maneuver less than once per round. If the MF is $\frac{1}{2}$, it can make one maneuver every two rounds—the player announces the maneuver one round, and the beast can perform it the next round. If the MF is $\frac{1}{3}$, it can make one maneuver every three rounds—the player announces the maneuver one round, and the beast can perform it two rounds later.

If a low-maneuverability beast loses control and begins to plummet, it still gets a skill check to regain control at the end of that round and another every round thereafter—but once it has regained control, it can only fly in a one-maneuver dive until two rounds later (for an MF of $\frac{1}{2}$), three rounds later (for an MF of $\frac{1}{3}$), etc.

For flying vessels and other constructions, use the following chart to determine Maneuvering Factor. Take the vessel's longest measurement and compare it to the chart below. If the vessel is roughly aerodynamic in design, use the middle column to get the Maneuvering Factor. If it isn't, use the right-hand column. It's a DM decision as to whether something is aerodynamic or not. Vessels built in the shape of sailing ships, aircraft, flying monsters, etc. are considered aerodynamic; those built in the shape of mountains, castles, houses, and large statues are not. Flying carpets are not aerodynamic; human beings and flying brooms are.

FLYING MONSTER CHART

Creature	Air-Speed (Feet per Round)	Maneuvering Factor (MF) & Takeoff	Hit Dice	Carry (Cn Wt)
Aerial Servant	360	3 (a)	16	16,000
Archon	120	3 (b)	20	20,000
Banshee	20	3 (a)	13	13,000
Bee, Giant	50	5 (b)	1d4	500
Beholder	10	1 (a)	11	11,000
" Undead	20	1 (a)	20	20,000
Blackball	10	1/2 (a)	—	0
Blast Spore	10	1/2 (a)	1 hp	100
Chimera	60	1 (b)	9	9,000
Cockatrice	60	5 (b)	5	5,000
Djinn				
" Lesser	80	5 (a)	7+1	7,100
" Greater	120	3 (a)	15	15,000
Dragon				
" Baby	60	5 (b)	3 to 8	*
" Small	80	3 (b)	6 to 11	*
" Large	100	1 (b)	9 to 16+3	*
" Huge	120	1 (b)	12 to 22	*
" Ruler	140	3 (b)	24 to 30	*
" Great	160	5 (b)	40	40,000
Drolem	80	1/2 (b)	20	20,000
Efreet				
" Lesser	80	3 (a)	10	10,000
" Greater	120	3 (a)	20	20,000
Elemental/ Air	120	5 (a)	8 to 16	*
Faerie	80	3 (a)	1+1	1,100
Gargoyle	50	3 (a)	4	4,000
" Gargantua	100	1 (a)	32	32,000

Creature	Air-Speed (Feet per Round)	Maneuvering Factor (MF) & Takeoff	Hit Dice	Carry (Cn Wt)
Ghost	30	3 (a)	14	14,000
Griffon	120	1 (b)	7	7,000
Harpy	50	3 (b)	3	3,000
Helion	80	1 (a)	9	9,000
Hippogriff	120	1 (b)	3+1	3,100
Hsiao	70	3 (b)	4 to 15	*
Insect Swarm	20	1 (a)	2 to 4	**
Manticore	60	1 (b)	6+1	6,100
Nightwalker	10	1 (a)	21-26	*
Nightwing	80	1/2 (a)	17-20	*
Pegasus	160	3 (b)	2+2	3,300
Phoenix				
" Lesser	120	3 (b)	9	9,000
" Greater	150	1 (b)	18	18,000
Poltergeist	20	1 (a)	12	12,000
Pteranodon	120	1 (c)	5	5,000
Pterodactyl	60	3 (c)	1	1,000
Pixie	60	5 (a)	1	1,000
Robber Fly	60	3 (b)	2	2,000
Roc				
" Small	160	1 (b)	6	6,000
" Large	160	1/2 (b)	12	12,000
" Giant	160	1/3 (b)	36	36,000
Spectre	100	3 (a)	6	6,000
Sphinx	120	1 (b)	12	12,000
Vampire	60	3 (b)	7 to 9	*
Werebat	60	3 (c)	3+3	3,300

* To calculate the carrying capacity of a specific example of this monster, multiply its Hit Dice by 1,000 cn-weight. Each plus to a hit die is worth an additional 100 cn-weight. Therefore, a creature with 3+3 HD can carry 3,300 coins in weight.

** The Insect Swarm can't pick up great weights. If the DM wishes it to do so, however, he can have it lift (HDx1,000 cn), just as with other monsters.

- (a) Monster magically floats straight into flight, no difficulty in takeoff; can hover without difficulty.
- (b) Monster flaps wings to take off; can be hampered by tight quarters, stopped if wings bound or injured; can hover with difficulty (skill check at -3), prefers to circle.
- (c) Monster must drop off sheer surface to begin flight; cannot hover, must circle.
- (d) As pegasi are better formed to carry weight, they can carry their HD x 1,500 cn.

Campaigning

Maneuvering Factors for Vessels

Object Size	Maneuvering Factor If:	
	Aerodynamic	Non-Aerodynamic
To 2'	5	3
To 10'	3	1
To 50'	1	1/2
To 250'	1/2	1/3
To 1250'	1/3	1/5
1251'+	1/5	1/10

You'll also want to know how to determine the Maneuvering Factors of monsters not listed on the monster chart above.

This, too, is simple. Take the length of the beast and compare it to the "Maneuvering Factors for Vessels" chart. A monster described as being man-sized, for instance, would be calculated on the To 10' line.

Most monsters are considered aerodynamic. Those that aren't—for instance, beholders—would be calculated in the *Non-Aerodynamic* column.

Another good clue that a monster belongs in the non-aerodynamic column is if it is described as "floating" instead of "flying," or if it has a maximum combat flying speed of 30'/round or less.

If a monster is related strongly to the elemental plane of Air, treat it as belonging one line up on the chart. For instance, the Air Elemental is large enough to belong on the To 10' line or larger, but we treat it as belonging to the To 2' line—because it's from the plane of Air, it's very maneuverable.

Likewise, monsters with a reputation for nimbleness in the air should be treated as belonging to a line higher than their sizes indicate. Dragons are a good example—though huge, they're good flyers and so have a better Maneuvering Factor than their sizes indicate.

Cross-Country Flying

A final note on flight speed—these combat-oriented rules deal only with the monsters' combat flight speed. When beasts or vessels are flying cross-country, they still use the figure *before* the one in parentheses to calculate long-distance

movement. Thus, an efreet still flies at 240'/turn when not in combat; a cross-country pegasus flies at 480'; and so on. Only when the monster enters combat do you need to use the Maneuvering Factor score or the flying speed in the parentheses.

Naval Combat

A lot of sea-trade goes on between and around the empires . . . and so a lot of naval combat goes on as well. If you decide you want to conduct naval combats in your campaign, there are three different sources for naval combat rules in the D&D® game available to you:

The *Expert Rulebook*, pages 42-44, gives you good basic information on *Waterborne Adventures*—characteristics of several types of ships, modifications for ships, effects of weather, and rules for combat and encounters at sea.

GAZ 4, *The Kingdom of Ierendi*, pages 29-30 and 35-36, gives a sound set of rules for quick-resolution ship-to-ship combats.

In several adventures the *Sea Machine* modifications to the *War Machine* rules have appeared. These rules are handy for resolving combats between larger fleets. It's possible that you don't have the adventures in which the *Sea Machine* rules appeared, so we're reproducing them immediately below.

The Sea Machine

If you conduct large-scale naval battles, you can run them according to the *War Machine* rules from the *Companion* set—with the following modifications.

A fleet is composed of ships, sailors, rowers, and marine troops. The role of the ships, aside from troop-transports, is to carry artillery or devices able to sink other ships. Sailors do not normally fight, except to defend their vessel against boarding; rowers almost never fight. Marines board and seize enemy ships, or disembark to attack land objectives.

Different battle ratings should be developed to evaluate the full power of ships and their troops. The following steps are suggested to get an acceptable result.

Step 1: Determine the marines' Battle Rating (BR) in each force.

Step 2: Determine the sailors' Basic Force Rating (BFR), ignoring Equipment and Special Troop Factors. Ignore rowers, unless they are not needed to control the ship and are able to fight. Determine the total Hull Points (HP) of each type of ship in the fleets.

Step 3: Determine the ships' BR, starting from the sailors' BFR (see Step 2). Use the modifiers below. Each time a condition applies, add one tenth of the original BFR as a bonus.

Galleys:

- if 20% of fleet's total Hull Points are galleys
- if 50% of fleet's total HP are galleys
- if 80% of fleet's total HP are galleys

Artillery:

- if 20% of vessels have artillery
- if 50% of vessels have artillery

Ramming Device:

- if 20% of vessels have a ramming or crushing device
- if 50% of vessels have a ramming or crushing device

Magical:

- if 1% of fleet's total Hull Points are magically enchanted
- if 20% of fleet's total HP are magically enchanted
- if 100% of fleet's total HP are magically enchanted

Flying:

- if 1% of fleet's total HP can maneuver in a 3-dimensional space*
- if 20% of fleet's total HP can maneuver in a 3-dimensional space*
- if 100% of fleet's total HP can maneuver in a 3-dimensional space*

(*) Applies to fleets able to fly, move underwater, or maneuver in another plane.

Speed:

- if the fleet has an average speed of 150 ft/round
- if the fleet has an average speed of 300 ft/round
- rowers are seamen (not slaves, or condemned prisoners)

Penalty (Reduce BFR instead if):

q. rowers* are less than 1/2 their original numbers

r. sailors* are less than 1/2 their original numbers

(*) Cannot use rowers if reduced to less than 1/4 their original numbers. A ship cannot use its sails if sailors are reduced to less than 1/4 of their numbers.

Step 4: Make an average of both BRs (by adding both and dividing by two). The total indicates the final *Fleet BR*. Then determine separate combat modifiers for the fighting troops and the fleet.

For troops: Base the ratio on the marines' total HD or levels rather than the number of creatures.

For the ships/sailors, determine the ratio from the total number of HP involved in each force (the sailors/rowers are then considered as part of the ship).

Make an average of both combat modifiers (as above) and add it to the fleet/troop BR. Resolve the combat with normal *War Machine* rules, using instead the table below.

Naval Combat Result Table

Difference	Ship	Extra	Fatigue
	Damage W:L	Casualties W:L	
1-8	0:5%	—	N:N
9-15	1:10%	—	N:N
16-24	5%:15%	0:10%	N:M

25-30	5%:20%	0:20%	N:M
31-38	5%:25%	1/2x:20%	M:S
39-50	10%:30%	1/2x:30%	M:S
51-63	10%:35%	x:40%	N:NF
64-80	15%:40%	0:30%	N:NF
81-90	15%:50%	x:50%	N:MF
91-100	20%:60%	x:60%	M:MF
101-120	20%:70%	1/2x:50%	M:SF
121-150	25%:80%	0:30%	N:SF
151+	25%:90%	1/2x:70%	N:SU

W: Winner, L: Loser

% = The percent casualties, in HP for ships, in HD or levels for creatures.

x, 1/2x = The winner suffers the same amount or 1/2 the loser's casualties (in HD or levels)

N = The force is not fatigued

M = The force is moderately fatigued

S = The force is seriously fatigued

F = The force flees to its original port

U = Remaining ships surrender to winner

How to Use the Chart

Step 5: Determine the damage the ships receive (Ship Damage). Force A chooses what types of ships are affected in fleet B, up to the total of damaged HP. Ship Damage may be equally divided among different types of ships. Fleet B chooses which specific ships within the given types are affected in its own force. Repeat procedure if fleet A has Ship Damage as well. Unallocated Hull Points of damage are ignored. For purposes of

combat, damaged ships are considered lost with their passengers.

Step 6: The winner captures up to one quarter of the opponent's lost ships; their passengers take 50% casualties and surrender. To keep a seized ship, the winner must dispatch a minimum of 12 sailors and/or marines to maintain order on board. Otherwise, the winner must either free or destroy the captured ship.

Step 7: Determine Extra Casualties for the troops (marines, sailors, rowers) on undamaged ships. Extra Casualties are evenly applied to each type of troop, round down.

Step 8: Determine Fatigue effects on marines, sailors, and rowers. Two consecutive "M" results are equivalent to a "Seriouly Fatigued" status. An "S" result for a fleet halves the galleys' oar speed.

The losing force always withdraws. No winner should ever suffer more than twice the loser's destroyed HP. Seized ships are not considered damaged. Ignore excess HP of damage.

Likewise, the loser should never suffer more than 10 times the winner's HP of damage. This is to limit the effects of a suicidal attack from a small Elite force.

Recovering Losses

The winning force (or one remaining in the area after battle) may recover up to one-third its damaged HP or troop casualties (wounded, unconscious, or disor-

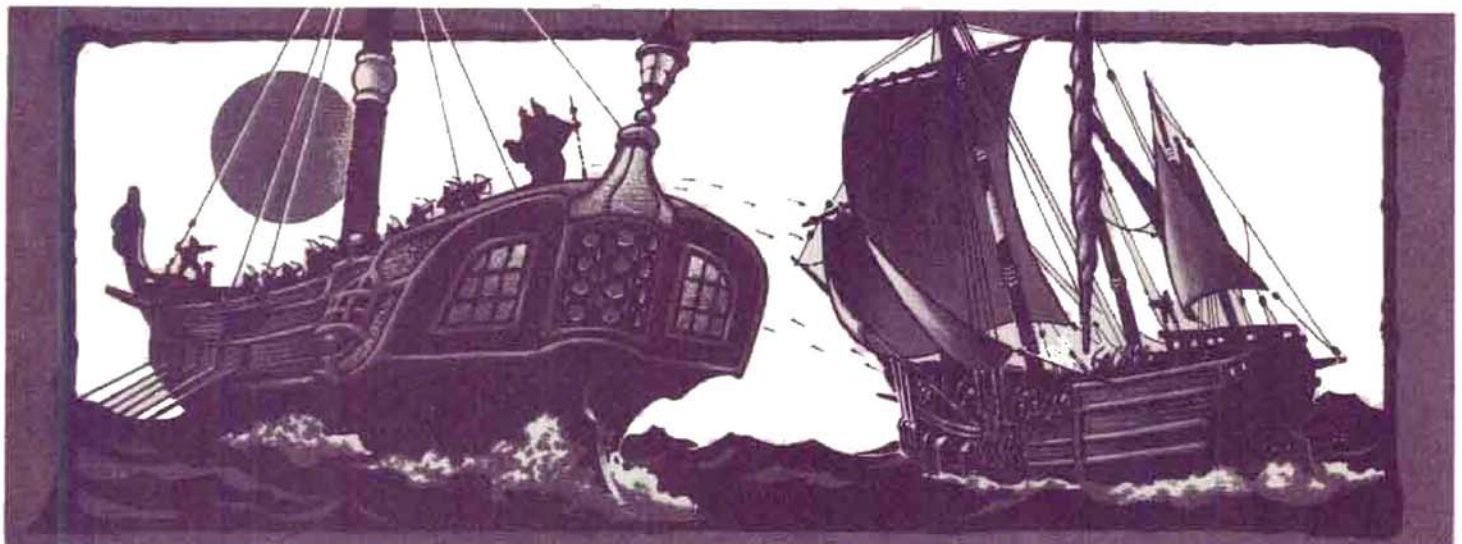

Campaigning

ganized troops, men at sea). Recovery of ships is determined in HP rather than in number of ships.

Recovered ships are treated as 10 Hull-Point wrecks (out-of-combat) until repaired in port. Those ships must be the type of vessels sunk during battle. If the amount of recoverable HP is insufficient to allow one ship to be salvaged (at full HP strength), then the ship cannot be recovered.

The characters have a chance to hire some prisoners into their own fleet. For each group of 50 prisoners of Chaotic or Neutral alignment (other than elite troops or monster types), roll 1d20, and apply the proposing character's Charisma bonus/penalty. With a modified score of 18 or higher, the group of prisoners joins the party's ranks. Otherwise, the party may freely use them as slave rowers in their galleys.

Ex-prisoners have a 60% chance of deserting in any port. However, after three months aboard, treat the ex-prisoners as regular sailors/troops. It is normally not advised to have ships manned solely by recent ex-prisoners.

Any sail ship can contain twice as many prisoners as a normal shipload of marines. If desired, any ship may contain 5-

10 extra prisoners in their bilge. Allow the player characters to hire mercenary troops and sailors in friendly ports to make up for their troop casualties.

A New Look at Death —

Here's something to think about: If you want your Thyatis campaign to behave more like the fantasy stories you read or see in the movies, you might think about getting rid of spells and magical items which bring people back to life. This includes spells such as *raise dead*, *raise dead fully*, *reincarnation*, and *clone*, not to mention artifacts with those powers.

Yes, this makes things a lot scarier in the campaign. When a character is dead, he's dead. You and allies would have to be a bit choosier about the fights you pick, and shouldn't fight every fight to the death—you may have to run away from the occasional fight.

On the other hand, this option makes death more than a nuisance. It becomes a sad and momentous event when a character dies—not just a delay in the proceedings. It sharpens the characters' perceptions of danger. In short, it's more dangerous for the characters, but better for role-playing. So give it some thought.

However, if you decide to get rid of the resurrection spells, you can also adopt an optional rule or two to make it a little harder for characters to die.

For instance, when a character is reduced to 0 hp or below in combat (or from death-spells), he's not dead. He's unconscious and mortally wounded; if left untended, he will die. He must make a Saving Throw vs. Death Ray every 10-minute turn. He makes the first roll on the round he drops to 0 hp; he makes another every round he takes additional damage, and every 10 minutes (one turn) in addition. If he ever fails a roll, he's dead.

But if he keeps making his rolls in the time it takes a healing Cleric, someone with Doctor skill, or someone with a healing potion to get to him, he can be saved. If the healers can heal him up to 1 hp or more, or the Doctor can make his Doctor skill roll at a penalty of -5 (regardless of whether it heals him up to positive hp or not), then the character is alive. He's critically wounded—but he'll survive.

In this section, you'll find one full-length adventure and a series of short adventure ideas. Though each adventure is listed for one specific range of character experience levels, each can be adapted to higher- or lower-level play simply by tinkering with the numbers and abilities of the enemy characters and monsters.

Thyatian Adventures —

These are adventures for a party of characters of predominantly Thyatian birth or attitudes. Naturally, *all* the characters in the party don't have to be Thyatians.

The Thyatian Millennium —

For Character Levels 1-3

Basic Plot

A thousand years ago, Emperor Zendrolion I was crowned. Today, in AC (After Crowning) 1000, it's time for his remote successor, Thincol I, to celebrate that event.

There will be parades and fairs, music and dancing in the streets, magical fireworks, aerial displays by the Retebius Air Fleet, and other attractions all day and night. The day's Games at the Coliseum promise to be the most wondrous in years, and the Emperor will be in attendance there.

All this would be very nice—except for the unwanted presence of some Alphatian agents in the city. These independent agents have decided that, since the Thyatians spoiled the Alphatian millennium celebration of a thousand years ago, the Thyatians must now have their own event spoiled.

These agents have toiled for years to create a one-of-a-kind variant of the *potion of monster control*. Included in the potion's ingredients is a minute quantity of sweat from one of Thincol's discarded garments, acquired at great expense and effort by these Alphatians. The potion, when drunk by monsters, and then activated by a spoken command word, will enrage them—and sensitize them to the scent of Thincol. If they smell him, they will go after him.

The agents plan to introduce the potion into the water and food given to the monsters in the pits beneath the Coliseum. When the greatest number of monsters is on the sands, the chief agent will speak the command word—sending the monsters into a killing rage directed at the Emperor. Such a spectacular slaughter of the Thyatian ruler would surely embarrass and discourage the Thyatians—which is why they're following this more complex plan instead of a simpler assassination in secret.

The Alphatian agents want to have a loud distraction, one which will attract the attention of most everyone at the Coliseum and help their men get the potion to the monsters. They've hired a band of Thyatian mercenaries to make an assassination attempt on the Emperor—from someplace in the Coliseum seating, with a high-powered arbalest (heavy crossbow) and its poisoned quarrel. The Alphatians don't believe the mercenaries can pull this off; it's probable that the Emperor's native survival abilities and the presence of his magist Demetrium would prevent such a thing. If it actually succeeds, all the better! But it is only intended as a distraction.

Having hired these mercenaries and set them into motion, the Alphatian agents, posing as concerned Thyatian citizens, also hire the PCs to patrol the Coliseum and keep on the lookout for these rumored assassins. The Alphatians are banking on the probability that the attempted assassination, the thwarting of same by the PCs, and the subsequent ruckus and rumor will provide them all the distraction they need to get the potion to the monsters. They're also banking on Thincol's renowned stubbornness and overconfidence to keep him in the Coliseum after one assassination attempt . . . that fits his usual attitude.

How Characters Get Involved

The day before the Millennium celebration begins, the characters are contacted by a messenger and asked to meet with one Tathenodosius of West Portage at a certain address in The Estates (in Thyatis City). The messenger says that Tatheno-

dosius wants to employ the PCs, but won't say more—the messenger doesn't know any details. But the messenger does leave them a bonus—a bag of money, 30 gp for every PC in the party—just for listening to the messenger's proposal. Who knows how much more they might get from listening to the man himself?

Story Progress

The appointed time is two hours after dark. When the characters reach Tathenodosius' home (a nice, though not lavish, walled manor house set behind high walls), they are shown quickly into the man's presence. He's of Alphatian descent from West Portage on the Isle of Dawn, but his home's decorations and attitudes are decidedly military—and his speech has a distinctive Kerendan twang. It's obvious to the PCs that he's ex-cavalry (which is true).

Tathenodosius will set forward his story with military precision and forthrightness.

He says he's a former cavalry officer who has retired and gone into business operating a messenger and courier service (all true—this is a great cover for his Alphatian spy network). Through some rather shady contacts he has, which he can't afford to discuss, he's learned that a band of assassins plans to kill the Emperor tomorrow at the Coliseum. They plan to shoot a poisoned crossbow quarrel at him from somewhere in the seating. He's notified the Imperial Guard captain, but the man doesn't seem to take the threat seriously—either he's an idiot or he's being paid off by the Alphatians.

At any rate, Tathenodosius wants to hire the PCs to wander through the Coliseum and see if they can spot the assassins. They're to wander around together, instead of spreading apart, because there could be numerous assassins in the murder party. If they spot the assassins, they're to attack them, naturally.

The PCs are to get 100 gp apiece just for wandering in the Coliseum tomorrow (half will be delivered now, half tomorrow night), plus 100 gp apiece if they actually do confront the assassins (all this would be paid tomorrow night).

Adventures

He gives them the only clues he's "learned" about the assassins: They're all Hattian radicals and members of the Storm Soldiers, so they'll probably be wearing the twin lightning-bolt decorations of the Storm Soldiers.

Assuming they accept (sweeten the deal if the money offered isn't in accord with good payments in your own campaign), Tathenodosius will thank them profusely, commend their loyalty to the Emperor, give them their advance payment of 50 gp each, and personally show them to the door.

As they're leaving the area of his manor, they'll see a shadowy figure slither to Tathenodosius' front door. It's a man in a concealing hooded cloak, and as a gust of wind catches his cloak they'll notice that he has lost his left arm at the elbow.

Investigations?

If the PCs decide to investigate any of Tathenodosius' claims in the hours between now and the commencement of the Games tomorrow, they may.

Investigating Tathenodosius, they'll discover that he is what he says he is: Ex-cavalry captain and now owner of a thriving courier business. He's a member of the Knights of the Air, a Pegasus-Knight, and is said to have a keen interest in all aspects of animal and monster behavior. (This information could come from other Kerendan cavalry officers, Knights of the Air, or courier business competitors.)

If they check into his claim that he's spoken to the captain of the Imperial Guard about the assassination attempt, you'll want to role-play out this line of investigation. How do they get to Guard-Captain Acrision? If they claim to have information regarding a possible assassination of the Emperor, they'll certainly get to see an officer of the Guard, but not its captain.

The truth is, of course, that Tathenodosius never saw the man, and the captain is neither stupid nor taking bribes from Al-phiatians. If the PCs are clever and forceful enough to get in to see him, it alters the remainder of the adventure—this isn't a bad thing, but is a trifle inconvenient.

If this is the case, Captain Acrision, with a certain amount of amusement, denies that Tathenodosius was ever in his presence and suggests that a unit of the Imperial Guard, accompanied by the PCs, visits the man's home.

Once there, Acrision and the Guard will barge their way in past the servants and search the house. They'll find that Tathenodosius is no longer there—he might have been alerted to the presence of the Guard or might have left earlier for some other reason. Either way, he'll figure out soon enough that the Guard is on to him.

Another thing the Guard and the PCs discover is that the basement is a large and well-equipped alchemical laboratory. Indications are that Tathenodosius was working with some sort of magic-user. Acrision will summon a magician from the Palace to analyze this, and then will "recommend" that the PCs perform the duties for which Tathenodosius hired them—patrolling the Coliseum tomorrow to try to find out what the man was up to. Of course, they're to report to Acrision instead.



This will put much of the rest of the adventure back on track, though you'll have to do some more fiddling with it further on.

At the Coliseum

The next day, as the heroes go traipsing off to the Coliseum, remind them of the festive nature of the day. They have to squeeze their way through impromptu parades; they have wines and ales forced upon them (and poured upon them) by happy celebrants; they must get free of the enthusiastic embraces of drunks. Eventually they'll make their way to the Coliseum.

(It's no use for them to try to cover all the entrances into the Coliseum—there are more entrances than PCs, and Tathenodosius told them to stick together anyway.)

Once they're inside, as the gladiatorial games are getting underway (minor fights between lesser gladiators, for the moment), it's time for the heroes to go searching around—traveling all over the Coliseum, looking for the assassins.

They'll spot several clusters of Storm Soldiers, but not one group they see could possibly be concealing a crossbow of any sort.

As their search progresses, Emperor Thincol I arrives to tumultuous applause, waving to the crowd and settling in his viewing box, his magist Demetrium standing beside him. Action on the sands progresses through a huge free-for-all of gladiators, a bloody scrap between a white ape and a black bear, a band of young gladiators vs. a pack of lizard men, etc. Time is passing and the PCs don't seem to be getting anywhere.

Then, one of the day's featured matches comes up—a rematch between two of the Empire's best gladiators, Anaxibius and Alexandrius. They step out onto the sands and the resulting applause shakes the Coliseum. It'll be a long, sophisticated, nasty, spectacular fight between these two.

Now it's time for the PCs to spot their quarry. Perhaps they're still searching for their prey during the fight; perhaps they spot their quarry out of the corners of their eyes as they watch this fight. Regardless, to-

ward the end of the Anaxibius/Alexandrius fight, Anaxibius is once again getting the better of his rival—and one of the PCs sees something strange.

There's a party of cloaked Storm Soldiers sitting near the PCs. One of the Storm Soldiers, a big man, is sitting very stiffly, while another, seated directly behind him, has pulled the big man's cloak up so that it covers him, too. The effect is similar to that of an old-style photographer sighting from beneath the black drape-cloth that early cameras used—except that, instead of a camera, we have a big soldier.

On the other hand, once the PC begins to look at it more closely, he'll see that the "big man" is no such thing—it's a dummy. The limbs hang all wrong and the legs don't bend like human legs. It's a mannequin of some sort.

As soon as he figures that out, he'll realize that the dummy is being moved subtly by the man in back of it. And the dummy is not facing the Anaxibius/Alexandrius fight—it's faced directly toward the Emperor's box. The Emperor is about at the maximum range of an arbalest . . .

The characters should then be able to figure out that the dummy is just an ingenious framework for a sniper's crossbow. (If the characters don't figure this out, have the assassin get his shot off.)

The Assassins

The assassin and his dummy are surrounded by several Storm Soldiers, one for every member in the PCs' party. The assassins are:

Storm Soldier Assassins:

1st-level fighters; AC 6 (leather armor and Dexterity bonus); HP 8; MV 120' (40'); #AT 1; D 1-6 (short sword) (sniper's quarrel does 1-6 plus Poison: Saving Throw at -6 or die; but he has only the one shot, at Thincol); Save F1; ML 8; AL C.

If the PCs get such a good ambush on the Storm Soldiers that the villains won't be able to put up a good fight, have some of the normally-dressed onlookers around also be Storm Soldiers—just enough that

the PCs get a good fight out of the situation.

If the sniper is able to make his shot at the Emperor, his quarrel sails out, straight and sure, at the Emperor—and stops dead mere inches from him, dropping harmlessly to the ground. Thincol is protected by a *protection from normal missiles* spell (among other spells) cast on him every twelve turns by his magist, Demetrium. The assassination attempt was futile.

But, meanwhile, the heroes must defeat the assassins—it'll be several rounds before the onrushing Imperial Guards can get to them. And they'll notice, possibly with some surprise, that one of the assassins is a man whose left arm ends at the elbow—the same man they saw at Tathenodosius' house late last night.

The oncoming Imperial Guard (who are, the PCs should know, too tough to mess with while the PCs are at Basic levels) arrive and take everyone into custody—though they keep the PCs and the assassins in separate groups. Everyone, the living as well as dead, will be taken into the pits beneath the Coliseum for interrogation (as will many of the surrounding witnesses). Role-play the initial interrogations as much as you wish—the Guard is smoothly professional and very good at getting to the real facts in this situation.

Eventually, the PCs' story will be corroborated. By order of the Emperor, who hasn't come down to survey this situation, all PCs will be healed and any dead PCs will be fully *raised* by imperial clerics.

(If any of the PCs is curious, Anaxibius did win his match. The audience and Emperor turned thumbs-down on the arrogant Alexandrius, who was beheaded.)

Investigation I

If the PCs *didn't* contact Captain Acrision the night before, he'll question them now. As before, it turns out that Tathenodosius never did warn him about these events. This, plus the fact that one of the assassins is a man the PCs saw at Tathenodosius' house last night, should alert them that Tathenodosius has played them for chumps. But why? For what reason? The PCs should be confused; Acrision certainly is.

Adventures

Acrision will dispatch a body of Guards to go to Tathenodosius' home and drag the villain forth. Meanwhile, he turns to interrogating the surviving assassins (if none survived, two will be *raised*—the sniper and the one-armed man). He invites the PCs to stay for the interrogation, in case they think of anything helpful to ask, based on what they've already seen. (His invitation is not one to be refused.)

The sniper is Wulf; the one-armed man is Alois. They'll talk so freely that they tend to babble.

Tathenodosius hired them to kill the Emperor. He promised that his magic-user friend, whom they never saw, would spirit them out of the Coliseum just as soon as the arrow flew.

Tathenodosius provided them with the dummy; the arbalest is built into its torso in such a manner that the bow stretches from shoulder to shoulder and the stock, normally rotated down, takes the position of the dummy's "spine." To use the sniper-dummy, the user sits down behind it, drapes its cloak over him, swings the stock up and locks it into its horizontal position, readies the quarrel, and takes as long as he needs to sight in on his target. They smuggled the dummy in by pretending it was a drunken friend; nobody noticed.

Guardsmen returning from Tathenodosius' house say that it has been abandoned; they found the alchemical laboratory. So Acrision asks the obvious question—what is Tathenodosius up to that he would hire assassins to slay the Emperor and then hire adventurers to stop them?

If the players don't realize that this is some sort of diversion, let any PC with "Military Tactics" skill make a skill check to figure it out. If no PC does, Acrision will finally do so. Naturally suspicious, he orders his men to search all over the Coliseum for anything out of the ordinary. He also drafts a quick letter and gives it to the PCs; it allows them admittance to any area of the Coliseum today. He only has time to draft one, so he tells them to stay together. If they don't want to continue this investigation, Acrision promises to pay them the rest of the money that

Tathenodosius had offered. Since there are more Guards above-ground than below ground, he recommends that the PCs first scour the Pits and then go back up to the coliseum to look around there.

Investigation II

If the PCs *did* contact Captain Acrision the night before, then naturally they won't be taken into custody after the fight with the assassins—but they'll still be brought before Acrision.

The assassins' story is the same as described above, and Acrision's reaction is the same.

Conclusion

At this point, regardless of the earlier divergent story paths, the characters should now be working with Acrision, should be aware that Tathenodosius tricked them, and should be prowling around the underside of the Coliseum.

In the course of their subterranean investigations, they'll see the large common cells for the low-level gladiator slaves; the holding cells, which open onto the tunnels leading onto the sands, where gladiators wait to be taken up to the day's fight; the large below-ground training arena, where some edgy gladiators are getting in a bit of last-minute training; and the battery of individual monster cells, where beasts of all types are held until it's time for them to be taken up for their fights. (This last area has a lot of trainers, naturally).

As the heroes look and ask around, numerous monsters, one by one, are being taken upstairs for one of the day's featured attractions: Duel of the Beasts, where about a dozen different monsters will fight one another to the death. Perhaps this will make the PCs suspicious; perhaps not.

In any case, the only unusual thing that the trainers and gladiators down here have noticed is that one of the chief animal-trainers has wandered off and not yet returned. This was sometime during that ruckus that took place up in the stands. No, he wasn't one of the ones who ran up to see what was happening; he stayed behind to take care of the ani-

mals. When the others got back from seeing what was going on—did you know that someone took an arrow-shot at the Emperor?—that trainer, Elosius, was gone.

Those trainers and guards have walked around calling for Elosius, but they haven't really *looked* for him. In the course of the PCs' investigations in this area of the Pits, they'll find Elosius' body, concealed in a big burlap bag which previously held feed for a minotaur. Elosius was stabbed to death and his blood will finally have soaked through the bag and allowed the PCs to find him. When found, Elosius is clutching an empty bottle from which unusual, spicy odors emerge.

So now the heroes have a body in a feed-bag. Now what? The PCs have two avenues for investigation: Elosius and the bottle he holds even in death. They can either take Elosius to one of the imperial clerics, or take the bottle to an alchemist or wizard, or both. If they can't figure out to do either, Captain Acrision can have heard of their discovery, come to them, and order both courses of action.

As these investigations are taking place, the last of the monsters for the Duel of the Beasts is being taken up to the sands.

The bottle turns out to have contained something very like a *potion of monster control*, but the wizard who sniffs at it says that it's a little unusual—some varied ingredients. He'll subject it to further analysis.

If Elosius is raised, his story is a brief and alarming one. During that commotion up in the stands, when word came down that someone had tried to kill the Emperor, almost everyone ran up to look. He continued looking after the monsters.

Wandering his rounds, he saw someone at the feeding-trough of the young green dragon which is slated to fight in the Duel of the Beasts. Two men—one matches Tathenodosius' description, the other was a grey-bearded gentleman, slight of build—were there. The grey-beard said "That's the last of them," then turned to the dragon and mockingly said, "Eat well."

Elosius charged up to them, snatched the bottle out of the one's hand, and demanded to know what the two of them were doing there. He doesn't remember much after that—just a sharp pain in his back . . .

The heroes should now be able to figure out that Tathenodosius and his wizard have done something nasty to the monsters in the cages down here. Trouble is, most of those monsters are now up on the sands, waiting for the Duel of the Beasts to begin.

By the time they get up to the surface, the monsters for the Duel of the Beasts are arranged evenly around the perimeter of the arena sands. They are skittish and angry in one another's presence. Many are still muzzled; some have been released, and the others are now being released. All the trainers are standing by tunnels leading into the Pits, so if a monster gets aggressive toward a trainer the trainer can quickly escape.

And, naturally, Thincol is still in his box.

Climax I: The Heroes Spoil the Plan

The obvious thing for the heroes to do is to start shouting for the trainers to hold onto the monsters, that something is wrong.

If they do, the trainers will comply for the moment, and only a few of the monsters, those already released, will be freed. At this point, Tathenodosius, realizing that his plan has been figured out, prematurely calls out the word of command, which sends the monsters into a berserk rage against Thincol.

The monsters going after the Emperor include: One cave bear, one sabretooth tiger, and one young green dragon with 5 HD and its wings tied down. The rest of the monsters are still in restraints and can't go after Thincol.

What happens now is a massive free-for-all as the monsters attack the Emperor's box. Demetrium rises to defend his Emperor, but is momentarily trapped within a *force field* cast by Thathenodosius' wizardly ally, leaving only the player-characters, a few men of the Imperial Guard, and the gladiator Anax-

ibius between the monsters and the Emperor.

Anaxibius goes after the young green dragon; the sabretooth plows into the Imperial Guardsmen; Demetrium *disintegrates* his way out of the *force field* and begins a wizard's duel against Tathenodosius' magic-user; and the player-characters must face off with the cave bear. They should be in good shape, having been healed back to normal earlier in the adventure; still, a cave bear is a fearsome opponent.

Let them fight the cave bear normally. While this is going on, Thincol is dropping out of sight, elbow-crawling over to where Tathenodosius' wizard is, and slaughtering that wizard where he stands; Anaxibius takes a bad case of dragonbreath but still slays his monster; and the Guardsmen, though two die, manage to kill the sabretooth tiger. If the heroes are still fighting at this point, and are in bad shape, Thincol will dispatch his guardsmen to aid them, and the day will be saved.

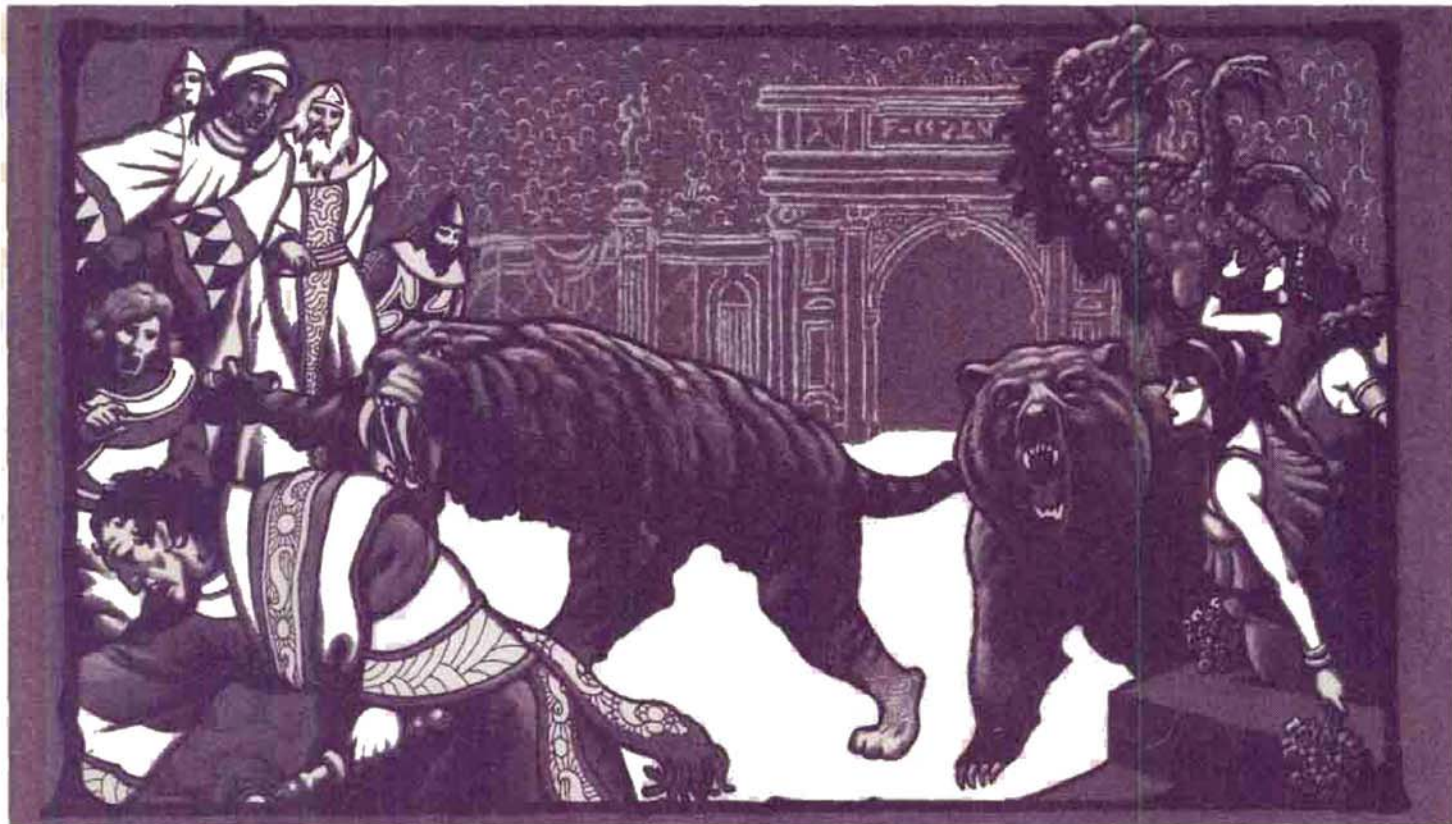

ADVENTURES

Climax II: The Heroes Don't Spoil the Plan

If the heroes don't alert the trainers, or if they didn't even figure out that they should come up topside in order to forestall Tathenodosius' plan, then all the monsters are freed, and Tathenodosius calls out the command word at that point.

The monsters attack and are attacked in this fashion: Tathenodosius' wizard still imprisons the magist Demetrium; Anaxibius confronts the green dragon; the sabretooth tiger and two owl bears attack the imperial guardsmen; the three ogres climb all the way to Thincol and attack him; and the PCs are attacked by the cave bear and two minotaurs, who can't climb up into the stands and so decide to kill whatever's on the sands.

This is a much uglier fight than the one described above. Tathenodosius' wizard takes the round or two available to him to blast Thincol with a *lightning bolt*, weakening him greatly; then Demetrium *disintegrates* his way out of the *force field*, and the two begin a wizard's duel. Anaxibius

will eventually dispatch his dragon and turn on the minotaurs, but several of the PCs may have been killed by this point. Thincol is seriously injured by the ogres but is able to kill the last of them. The sabretooth and owl bears are critically injured but kill their guardsmen, including Captain Acrision; fresh guardsmen do arrive and keep them from the Emperor. Demetrium defeats his opponent but is terribly injured. Eventually all the monsters are put down, but casualties are high: Thincol, Demetrium and Anaxibius seriously wounded, Captain Acrision killed, several of the PCs killed and wounded.

CONSEQUENCES

If the heroes were able to alert the trainers in time, resulting in only three monsters being freed and the "Climax I" events taking place, everyone is happy with the PCs. The injured will be healed, the dead *raised*. The PCs have the respect of Captain Acrision and will receive personal commendation—and some extra gold, in

appropriate amounts decided by the DM—from Thincol himself. Anaxibius will now know of the PCs and have admiration for their fighting spirits, even though they're just beginning fighters compared to him (this means they have an important contact with the gladiators of Thyatis). Tathenodosius was caught on his way out of the Coliseum, and his wizard, of course, was stabbed to death by the Emperor. All's well with the world.

If the heroes weren't able to alert the trainers in time, having failed to figure out any of the clues or having waited while all the monsters were being freed, resulting in the "Climax II" events taking place, everyone is indifferent to the PCs. The surviving PCs can leave. They get no free healing or resurrection. They don't get any gold that Acrision might have promised them—Acrision is not alive to tell anyone about that. Tathenodosius' wizard died but Tathenodosius himself got away to plot more mischief. No one has any respect for the PCs' brains.

Basic Adventure

Escape from Borydos

For Character Levels 1-3

Basic Plot: The characters must try to escape from Borydos, the Devil's Island of Thyatis.

How Characters Get Involved: In the course of any ordinary adventure (or a between-adventures expedition of carousing), the characters somehow annoy a great but chaotic Thyatian wizard. Perhaps, in an inn, they spill a drink on him, or bump into him and knock him down; furious, he informs them that they must learn to be polite to their betters, and he begins to depart. From across the room, though, he formulates a *wish*—and the PCs abruptly find themselves standing on an unfamiliar island hilltop.

Story Progress: The characters shouldn't initially know that they're on the prison-island Borydos. When they start running into convict farmers armed only with stone knives, they will be able to figure it out pretty quickly; it will be equally obvious when they head down to the shore and find that giant maneating crabs lurk off-shore (which occurs only on Borydos in all the Thyatian Empire).

The PCs know that it will do no good to present themselves to the authorities; the military personnel on the island will just take their weapons, armor and equipment from them, presuming that they're convicts who have somehow acquired these goods.

The PCs have to figure out how to escape back to civilization on their own. They have an advantage over the convicts in that they still have all their equipment; being well-armed and not weakened by years of malnutrition, they should be able to use their brains, brawn and magic to plot their way through the garrison's defenses and to a boat. Let them do the plotting themselves; the actual escape can be complicated by convicts who manage to steal gear crucial to their plan, or who promise to alert the garrison if the PCs don't take them along.

Consequences: Once the PCs have escaped, there are no further consequences

if the PCs don't want to pursue any. The magic-user who sent them to Borydos won't follow up and exact further revenge . . . unless the PCs decide they want to go after *him*. It's to be remembered, though, that he's at least a 33rd-level wizard . . . no easy prey for a bunch of Basic-level heroes.

Expert Adventure

Kerendan Days of the Hoof

For Character Levels 4-8

Basic Plot: It's time for the annual Kerendan Days of the Hoof competitions—see the listings for Kerendas in the "Atlas of Thyatis" in this book and the "Overview of Thyatis" in *Book II*. Fighters, clerics, and other horsemen among the player-characters are welcome to attend. But, also in attendance is a family of clever *doppelgangers* who intend to profit greatly from the events of the competition . . .

How Characters Get Involved: The Days of the Hoof are open to any entrants. It's simplest to tell the characters, at the end of one episode or start of the next, that the event will be taking place soon, and do they plan to attend? If not, go on to some other adventure.

Story Progress: For the jousting sequences in this adventure, use the Tournament rules from the *Dungeon Masters Companion*, page 6-7. If you wish, you can use the "Non-Lethal Combat" optional rules from "The Knights of Thyatis" chapter in *Book II* of this supplement—these rules would only be used in practice rounds and some challenges, while actual jousts and most challenges would use normal damage rules.

At the Kerendan Days of the Hoof, there are field lists, archery tournaments, and wrestling competitions, but the big events are Jousts and Challenges.

The big Jousting competition is a huge tournament with about 250 entrants. This provides for a single-elimination tournament of eight rounds—and, because there are so many bouts in the early rounds, the Joust tends to continue across two days of competition.

Losers in the Joust are helped off the field and to nearby tents where healer clerics await them . . . and it's there that the adventure's trouble starts.

In the early rounds of the joust, a band of doppelgangers lurks in the vicinity of the clerics' tents. When they see a wounded warrior being carried within, one doppelganger is dispatched to bash the cleric over the head, then take the appearance of and kill the wounded fighter.

The player-characters, of course, won't be aware of this initially. They'll just see fellow jousters get beaten, taken into the clerics' tents, and emerge as they should. But these jousters will be behaving a bit strangely, not necessarily recognizing those who wave to them or speak to them.

The PCs will get involved in these events sooner or later. The tourney officials are noting with some surprise that various of their healing clerics have gone missing (the doppelgangers aren't imitating *them*, as they can't imitate clerical magic). They'll tap other clerics to help with the healing—including PC clerics.

So, on one occasion when a PC fighter is beaten in the list, or when a PC cleric is asked to help with the healing, or both, a doppelganger will make his usual attack, sneaking into the healing tent, trying to bang the cleric atop his head, take the fighter's identity, and kill the fighter.

These being player-characters, the doppelganger will probably have a hard time of it. It's most likely that the doppelganger will be killed or chased off.

Anything can happen at this point. The PCs can raise a big, loud alarm and alert the whole camp that something is wrong. Or, they can take their suspicions privately to the tourney organizers.

In the first case, chaos will ensue as competitors go running all over the place, vengefully looking for the doppelgangers. The doppelgangers, realizing the jig is up, will try to make their escape—but it could alert the heroes to their identities if the doppelgangers' horses were suddenly afraid and wary of them (just because the doppelgangers look like their usual riders doesn't mean they smell like them!).

ADVENTURES

In the second case, the organizers will alert the Kerendan duke, who will want to keep the situation quiet—while finding out if any other doppelgangers are loose in the camp. He'll ask the PCs to help by hiding and watching activity around the doppelganger tents, stopping any further doppelganger attacks, and finding out which clerics have already gone missing and which fighters they were attending at the time—those fighters are probably doppelgangers now.

This is all a fine opportunity for desperate death-duels between the heroes and the doppelgangers, who are dressed as, armored as, and using the weapons of well-known Imperial fighters and knights.

Consequences: Assuming the PCs survive, this adventure has no dramatic consequences for them. If they kept their heads and didn't go shouting to the whole camp that doppelgangers were among them, they will impress the Kerendan duke with their wits . . . which could lead to him supporting them when they petition the Emperor for dominions later on.

Against the Storm Soldiers

For Character Levels 4-14

Basic Plot: The PCs are hired or requested to infiltrate and betray the Storm Soldiers, the hate society of Hattias.

How Characters Get Involved: One or more of the PCs should either be of Hattian descent or have some sort of useful but unusual General Skill. The PCs will be contacted by Prince Eusebius, who claims to be (and is) acting on behalf of his father the Emperor. The Storm Soldiers are getting a bit out of hand with their racist activities—particularly their terrorizing and beating important Citizens not of Thyatian descent. But because the individual Storm Soldiers involved claim to have decided to perform these actions on their own—and since *ESP* seems to corroborate these claims—it's very difficult to take action against the overall organization. The PCs' mission, should they decide to take it, is to infiltrate the Storm Soldiers, rise

in their ranks, and find out if and how the Storm Soldiers' leaders are commanding their subordinates to undertake these actions . . . without the subordinates' realizing that the idea comes from those officers.

Story Progress: This would be a several-part story of treachery and intrigue. In the first episode, Prince Eusebius contacts the PCs with the information shown above . . . and the PCs must then go to the Thyatis City Storm Soldiers Enclave and try to gain admittance. That's where Hattian ancestry or unusual skills on the part of at least one PC becomes important—the Storm Soldiers wouldn't admit them otherwise. The PCs, once accepted, would undergo the program of arms training and indoctrination in their philosophy of race hatred.

Early on, the Storm Soldiers will test the PCs' loyalty in a variety of ways. First, the PCs, along with the rest of the city Enclave, will be required to dress up in full uniform and march in parade during some minor Thyatian holiday. Then, an NPC member of the Storm Soldiers—not an officer or leader—will try to persuade them to go out with him on a "raid," an assault on and beating of a well-respected merchant of Alasiyan descent. The true Storm Soldier will try to kill the merchant, though the mission was only to beat him. (This situation puts them in a really nasty moral quandary. If they stop him, they'll be under suspicion. If they don't, they've contributed to the death of an innocent man. If they blow the whistle now, they've only caught an organization nobody. But if they wait to learn more, they may be forced to participate in more activities like this one.)

If the PCs tough it out and try to learn more and more about the Storm Soldiers, they'll be put through more trials . . . but if they do enough investigating, sneaking around the Storm Soldiers enclave at night, they'll discover that a Storm Soldiers officer, a wizard who is second-in-command to young Hansel Oesterhaus, is responsible for the throne's inability to prosecute the organization. This wizard is using *charm* spells on Storm Soldiers as they sleep

. . . Hansel speaks to the enchanted soldiers as they sleep, programming them subliminally to perform the more serious crimes.

Having discovered this about the Storm Soldiers' leaders, the PCs must get out of the Enclave and to the Palace without the Storm Soldiers catching on. But that's never as easy as it sounds—something always goes wrong, leading to a mad chase as vengeful Storm Soldiers pursue the heroes all over town, trying to keep them from getting that information to the right parties . . .

Consequences: If the PCs do their job well, they'll please Prince Eusebius, earning his commendation and a decent gold payment. They'll also become eternal enemies of the Storm Soldiers . . .

COMPANION ADVENTURES — *Knights of the Air*

For Character Levels 15-25

Basic Plot: The Emperor has decided that Thyatis' eventual conquest of far-northern Norwold will be easier if he knows as much or more about the nation than its Alphatian nobles. He already has spies in the settled areas of the nation, but he needs a detailed map of the deep interior regions of Norwold. It's his opinion that the Knights of the Air or Retebius Air Fleet would be the best people for this mission.

How Characters Get Involved: The only thing the PCs need do is have some members in either the Knights of the Air or Retebius Air Fleet. If they have a reputation as good and trusty adventurers, the Emperor will summon them for an audience, ask them if they are willing to undertake a mission for their Emperor, and—if they agree beforehand—will explain the plan described above.

Story Progress: The heroes and their mounts will receive transportation to Finnegan's Watch on the Isle of Dawn; that's their beginning staging area. From then on, they're airborne. The PCs who don't have flying mounts will have to be carried on the backs of the others' beasts if they're to go along.



Their mission is to overfly the western reaches of Norwold and make an accurate map, noting terrain types, hitherto-unknown communities, monster groupings, climate, etc. If possible, it would be nice if the PCs could peaceably contact the frost giants of Frosthaven to see if the giants can be lured into alliance with Thyatis against the Alphatians at Alpha.

In the course of several days of flying about and mapping, the PCs should have numerous unusual encounters: With wild dragons, a damaged Alphatian Air-Ship which has drifted off-course, and perhaps exotic monsters (imagine a hidden valley of yeti who have human-level intelligence and travel by means of enchanted white hang-gliders!).

Eventually, they may make their way to Frosthaven, and will naturally find that the frost giants have no interest in an alliance but are keenly interested in killing and perhaps eating the PCs.

Consequences: Every favor the PCs do for the Emperor, of course, makes it easier for them when they deal with the imperial government on matters of dominions, taxes, etc. Their mission over Norwold will eventually have been noticed by some Norwold citizen, angering King Ericall and the Alphatians; this could strain inter-imperial cooperation for several game-months after these events.

Mists of Mositius

For Character Levels 15-25

Basic Plot: The characters are on the island of Mositius when the "volcano" begins emitting some of its famous mists. However, these are some of the "bad mists," and things go badly awry.

How Characters Get Involved: Eventually, your group of PCs will have to visit Mositius. They could be visiting for a restful vacation, or going at the invitation of one of the island's inhabitants. It would be best if some NPC follower or family member of at least one PC accompanied the party there.

Story Progress: Late at night, the *censer of the mists* begins emitting a sweet-smelling, reddish mist. Duchess Triella is in Thyatis City tonight, but her apprentice goes through the ordinary checks and tests to make sure that the mist is safe—it seems only to make its victims dreamy-eyed and cheery, so the apprentice lets it pour out over the island.

The mist creeps out over the island, and everyone it strikes—those who don't make their saving throws—become silly and dreamy. The PCs should have a good time observing the happy antics of those on the island; perhaps some of the PCs will fail saving throws and succumb to the mists' effects.

But an hour later, all those who were affected by the mist (i.e., missed their saving throws) go through a mood swing. Starting now and for the next five hours,

the mist enhances everyone's psychological problems and attitudes, meanwhile removing restraints on their behavior. In short, anyone who has any sort of psychological problem, from the very minor to the very great, has it magnified ten-fold and additionally feels no moral or ethical qualms about doing whatever he wants.

For the PCs who missed their rolls, the DM will have to decide what their "personality problems" are if they haven't been made clear in the campaign already. One might be insufferably arrogant. One might be pining for a lost love (and thus be depressed). One might be ambitious and frustrated at his lack of gain. One might have buried an old grudge against one of his friends—only to have it re-emerge because of the mists.

Make sure the affected PCs role-play out all this extreme behavior—and that the unaffected PCs know that it's the result of the mists, that the affected characters are not responsible for their actions. Good role-players will probably be enthusiastic about chewing up the scenery with their altered characters. Poor role-players should earn little or no experience for this adventure if they refuse to play out these temporary psychological changes.

Regardless, many of the PCs will probably be unaffected (because they're of advanced levels), while some will be affected. They're all on an island populated by maniacs who mostly are affected

Adventures

and are running amok doing whatever they wish—some happy, some destructive, some happy and destructive. And the NPC follower of the heroes is missing, having been affected by the mists and having wandered off into the gloom; considering the mental state of the island's population, it's in the best interest of the PCs to find their follower before something goes drastically wrong.

Consequences: This adventure has few or no long-term consequences unless PCs die or end up killing an NPC who is the child of some wealthy and powerful noble. In either case, Triella keeps clerics to raise victims of the extreme instances of mist effects . . . when the bodies can be found, that is. If someone dies permanently, the imperial throne does not hold Triella at fault; all who come to the island know that there's a faint possibility of something going wrong. But if some character in his right mind kills a crazed NPC without first exploring every possible option to capture him, the character will probably have himself new enemies—the family and friends of the dead NPC.

Alphatian Adventures

These are adventures for a party of characters of predominantly Alphatian birth or attitudes. Naturally, *all* the characters in the party don't have to be Alphatians.

Basic Adventures

The Thyatian Millennium

For Character Levels 1-3

Basic Plot: This is the "reversed" version of the adventure listed under Thyatian Adventures. Here, the Alphatian spies are the heroes and the poor Thyatian saps hunting for them are the villains.

How Characters Get Involved: Adventurous Alphatian PCs will be hired in Alphatian territory by agents of Tathenodosius, who is described in the earlier adventure.

Story Progress: The heroes are smuggled into Thyatis City; their cover is that they are from Thyatian-occupied areas of the Isle of Dawn. You can, if you wish, make the entry into Thyatis City a nervous and dangerous one, as they debark in the port area and have their papers carefully scrutinized by fearsome-looking guards and officials who appear as though they can memorize every detail of every face they see.

Once through that nervous phase of the mission, they're installed in Tathenodosius' manor, where he'll explain the mission to them. He explains how he's hired Thyatian morons to "assassinate" the Emperor and more Thyatian morons to catch the assassins in the act.

While this is going on, the PCs are supposed to break into the Pits areas beneath the Coliseum and introduce several spe-

cial potions into the food of the beasts caged there. Then, they're to sneak back into the Coliseum seating and remain handy as backup to Tathenodosius in case anything goes wrong.

The next day, run them through the process of sneaking into the Pits. They'll have to overpower a guard at some lesser door into the below-ground regions, then sneak down into the Pits' lowest levels, avoiding groups of guards and gladiators, and hiding for a while. When news of the fight in the stands and attempted assassination of the Emperor leaks down, they're to introduce the potions into monsters' food; for those monsters who aren't being fed, they're to pour the potions out in their cells so that the monsters will still drink the potions. Then, of course, they must escape back up into the stands.

Here, as in the previous adventure, you can complicate their lives with a monster-handler who remained behind; or you can use guards who are too observant, monsters who get very loud when the PCs are near, escape routes blocked by groups of gladiators readying themselves, and by a band of Thyatian adventurers who are hunting for something awry in the Pits.

Assuming that they get back up to the seating area, the PCs then have to wait around the hour or two until the Duel of the Beasts is to take place. You can play out the attack on the Emperor through either of the story-paths shown with the



previous adventure: Either three or all of the monsters are free to attack the Emperor; either the mission does the Emperor no harm or it hurts him seriously.

Either way, the PCs' mission, once Tathenodosius calls out the command word, is to help him get out of the Coliseum. This entails battling their way up a long flight of steps between seating, all the way up to the exit from the Coliseum, and then run with Tathenodosius until they get to a safe house in the city. From there, they have to smuggle themselves and Tathenodosius back out of the city and to the Isle of Dawn, where at long last they will be able to breathe easier.

Consequences: If the PCs are captured, consequences are dire: They'll be tried and executed (unless Tathenodosius' wizard is able to help them escape). Those who manage to get away and back to Alphatian territory will gain themselves a certain reputation as crazy, daring adventurers, and the story of this will eventually reach the Empress herself . . . which is useful, when she herself is looking for crazy, daring adventurers.

The Air-Ship of Love

For Character Levels 1-3

Basic Plot: This is a maddening comedy adventure—low on danger of the physical/monster sort, high on danger of the social mistake/relationship sort.

How Characters Get Involved: Pick a time which is particularly lean for PC employment, and when your characters are in need of quick money, then allow them to see a Rainbow Park advertisement for "employees of all professions: good wages, travel, festive atmosphere. No air-sick persons need apply."

Story Progress: As you will recall, the Air-Ship of Love is an air-ship which makes Alatian cruises from Rainbow Park on the island of Gaity. Passengers board expecting not only to see the sights, but to meet the mates of their dreams, rekindle sputtering romances, etc. The player-characters are hired as messengers, barkeeps, activities directors, entertainers, etc. (Have each PC hired to the position for which he's least suited for a

particularly chaotic adventure.) But every crewman is expected to promote the ship's aura of amor, PCs included.

On the PCs' first cruise, the NPCs aboard include:

Pofinior the Great (MU20, C) and his lady *Aderianne the Gold* (MU20, N). They've come aboard to put some spark back into their relationship. Pofinior is madly jealous and not quite sane. Aderianne will spend about fifteen seconds aboard before falling in love with one of the PCs. The PC's goal: Keep Pofinior from learning about her new infatuation long enough to learn about and solve the problems that Pofinior and Aderianne are having.

Egthelbreth of the Wyrn (mostly just called the Worm) (MU 10, N), a Charisma 3 specimen who's looking for love. (He actually has a Charisma score of 10, but is so socially maladjusted that it is effectively a 3). If they're to keep him from offending every woman on board with his advances, the PCs must teach him how to bathe, to dress, to talk to women, and not to keep falling down stairs or spilling drinks on ladies he's trying to impress.

Dulcita (MU3, N) and *Peligrita* (MU3, C), identical twin sisters who've come aboard for very different reasons. Both are beautiful, intelligent, and adventuresome. But Dulcita has come aboard looking for romance (a PC is a good choice for her object of desire), while Peligruta, having recently gone through a disastrous affair, wishes to hire some doughty PC to kill her (as she hasn't the nerve to kill herself) . . . and wants to prevent Dulcita from making the same mistakes she made earlier. Naturally, both young women dress as one another, pretend to be one another in order to throw one another's plans into disarray, which makes things horribly confused for the player-characters. If the situation is handled right, Dulcita will end up with the PC she prefers while Peligruta can fall for the new, improved Egthelbreth of the Wyrn.

Consequences: None special. If the PCs do well—survive, and solve at least one of the problems with which they're confronted—they'll always have employment opportunities here in the future.

Expert Adventure

Shraek in the Night

For Character Levels 4-8

Basic Plot: The PCs have to go on a truly dangerous mission into the nation of Blackheart—and into its fearsome capital city, Shraek.

How Characters Get Involved: Agents of the imperial throne hire the player-characters for this mission (after all, they don't want for any of their valuable agents to die). The mission, should they decide to accept it, or even not, is to travel to the city of Shraek in Blackheart, find a rogue wizard named Malebrute, capture him *alive* (tying and gagging him so that he cannot utter spells and totally destroy the party), and carry him back to civilization. For this reason, a party heavy on fighters and thieves is recommended, though at least one MU and one cleric should be along.

Story Progress: The PCs will be floated into Blackheart, to within ten miles of Shraek, on a small, fast air-ship combat vessel (often called a tornado boat). The captain has been instructed to bring it no closer to Shraek, in case wizards' familiars such as birds should spot it . . . and wizards should wish to investigate. The captain will not be accompanying the heroes into Shraek.

The heroes must make the ten-mile hike into Shraek. Give them one or two monster encounters with really bizarre, incomprehensible monsters—for example, a beholder-like creature with no eye-beam powers, but whose eyes are themselves floating ball-creatures who separate themselves from the main body and attack with biting teeth once the main body has sustained 50% damage.

Once the heroes are in Shraek, impress on them the ugliness and danger of the city. Before the criminal class that occupies Shraek, the heroes will have to act surly and tough, and back it up on one or two occasions (give them a street encounter with robbers, or a bar-brawl, or both) as they investigate Malebrute's location.

The locals know where Malebrute will be after nightfall. He only comes into



Shraek after sunset, in the presence of his lady, Ultrisa the Dark. Not much is known of her. The heroes can find out where Malebrute's dwelling is within the town with relative ease.

How they plan to capture Malebrute is up to them, naturally. It's most likely that they will wish to ambush him within or before his home.

His home will come as a surprise to them. There are no servants there. (Really thorough questioning of the locals could already have told them that Malebrute dismissed all his servants at about the time he became involved with Ultrisa.) All the tower's ground-level doors and windows are boarded over or nailed shut, but the interior is obviously inhabited. Really sharp-eyed heroes might note that there are no mirrors within the tower (give each hero an Intelligence check at a -8 to discover this; if someone says he's looking for precisely that, he'll notice with no roll necessary). On the second floor of the tower, the heroes will discover Malebrute's sleeping chamber and a sumptuously-appointed lady's boudoir—and in that second room is a plush coffin with a plaque on it reading "Ultrisa."

After nightfall, Malebrute (MU 15, C) will come home. Outside the tower, he will call a fond farewell to Ultrisa and add that he expects her in an hour or two. Then he will fly up to a second-story entrance into his tower.

It will not be difficult for the PCs to capture and tie him before he can get any spells off. He's not anticipating trouble. Have each hero describe what he intends to do when the group jumps Malebrute, and describe the action in harrowing detail—will he get one fatal spell off before they gag him and tie his hands? But the outcome is never in doubt, and you don't need to die-roll the combat.

Now, it's time for the heroes to get out of town. They must carry his body through Shraek; this won't alarm anyone in the crime-infested, night-doomed town even if they fail to disguise Malebrute. If they're clever, they'll try to acquire some anti-vampire paraphernalia; their cleric will have a holy symbol, but they need stakes and hammers, garlic, whatever else they can find.

During their long walk back to their tornado boat, Ultrisa will return home, divine what has happened (if the heroes bothered to clean up after themselves, she can doubtless find a wizard with the spells to inform her of their deed) and set out after the PCs. She will acquire a few bloodhounds in the city and take off in pursuit.

The heroes will get about halfway back to the tornado boat when they hear the distant baying of hounds. Make their race back to the boat a fast and desperate one—though dark monster-infested forest in the dead of night. As they run and occasionally trip or crash into trees,

there's always the possibility that Malebrute's gag will slip—after one such tumble, the heroes may hear him starting to speak a spell, and have to grope around in the dark to replace his gag before the spell is completely uttered.

Just a few hundred yards from the boat, the dogs attack the heroes with vampire-induced ferocity, and the heroes must deal with them. The PCs also hear distant hoofbeats, rapidly getting closer.

When the heroes finish the dogs and make it to the boat, they find the captain dead—killed by some lycanthrope. They must fly the ship themselves, and so will probably have to waste some time figuring out how to take off. . . unless one of the characters has Air-Ship Piloting as a skill.

Eventually, Ultrisa will reach the site and fly up to the ship in bat form, resuming vampire form once on board. She will attack the heroes, intending to kill them all, and it's time for a deadly battle. (Ultrisa is a normal 7HD Vampire from the *Expert* rules.) The heroes must kill Ultrisa or drive her off (she'll run if she takes 50% of her hp in damage); if she beats them or is able to free Malebrute, they're all going to die. This should be a long and desperate battle, but the heroes will probably ultimately prevail, sending Ultrisa off into the darkness or to her just reward.

Consequences: If the heroes do get Malebrute back to Sundsvall alive, they'll be amply rewarded—restored to peak condi-

tion as much as magic may do so, and given a generous gold reward. Malebrute will be executed for unspecified crimes against the throne.

If Malebrute dies in the adventure but the heroes get his body back to Sundsvall, they'll receive half the promised reward and no magical healing. The throne won't think badly of them, but the PCs won't be high on the list of choices for future imperial-supported adventures.

If Ultrisa survives, she's now a deadly enemy of the heroes and should appear in later adventures in that role.

COMPANION ADVENTURE

Journey to Alphaks' Volcano

For Character Levels 15-25

Basic Plot: Empress Eriadna has decided that enough is enough. Too much evil is coming from Alphaks' Volcano. It's time to launch a punitive assault.

How Characters Get Involved: The Empress calls for a mobilization of the nation's greatest heroes and finest magical minds—they're to collect in the city of Eagret. No other orders or descriptions of the upcoming event are provided; most people, including the PCs, should believe it is a new assault on Thyatis, so interest runs very high. (Meanwhile, in Thyatis, the spies are reporting that the Alphatians are gathering for an attack, so the Thyatian military is put on full alert . . . and nothing happens.)

Story Progress: While a collection of Grand Council wizards begins a large, complicated, and ultimately fake ritual which is theoretically supposed to bind and destroy Alphaks (but which is actually just supposed to divert his attention for a few days), Prince Zandor leads the high-power troops in a flotilla of troop-carrying air-ships from Eagret to Alphaks' Volcano. The heroes are briefed en route as to what this expedition is all about. Most of the traveling takes place under cover of darkness.

This is nothing but a large search-and-destroy mission, and is made up of the most powerful Alphatian heroes that the throne could assemble. The heroes are supposed to invade the island, find out if

it does have any inhabitants, and destroy them. The invading army is arranged into small units of heroes, preferably units which have fought together before—effectively, it's organized into adventuring bands. Heroes are advised to keep away from the volcano's crater, for the mists there are poisonous.

At dawn, while Alphaks' attention is theoretically most intensely devoted to the fake rituals being performed a continent away, the flotilla descends upon the island of Alphaks and disgorges hundreds of kill-happy high-level heroes. NPC wizards immediately use *wishes* to keep the prayers of any Alphaks clerics from reaching their master. The invading horde spreads all over the island, looking for signs of human occupation—which the Alphatian military leaders are certain are there.

The PCs, or NPCs near them, will be the first to discover the hidden cave leading down into the caverns of the city of Revenge.

From then on, it's a military push down the treacherous, trapped tunnels and caves to Revenge, fighting hordes of grisly monsters and bands of powerful villains devoted to Alphaks. This adventure is an opportunity for unfettered combat against an evil foe, and should be played as a high-speed, high-action series of combats, traps and menaces from beginning to end.

Eventually, the PCs will be able to make their way to the throne chamber of the Black King and Black Queen and their personal guards, and duel with them. It's likely that the Black King and Black Queen will be able to use their magic to get away . . . but at least the PCs will have seen them and their abilities, and the throne will know of them.

Consequences: Alphaks, of course, will have to install the Black King and Black Queen in some other hideaway, and will have to go to the trouble of setting up an entirely new staging area for his nefarious plans. As a retaliatory measure, he will send a horde of sea-monsters out from the water and into Aasla, to kill and maim as many as possible; if the heroes are there or can get there in time, this is another adventure for them.

CROSS-IMPERIAL ADVENTURES

These are adventures which involve both empires—with neither automatically being assumed to be the "hero" empire. These adventures are best played when some of the PCs are Alphatian and some are Thyatian.

War-Hawks Over Helskir

For Character Levels 14+

Basic Plot: Helskir has declared its independence. Thyatis wants it back. Alphatia wants it back. Both have owned it in the past and wish to own it again, and so both are assembling fleets to take it. But neither empire wants war with the other at this time . . .

How Characters Get Involved: Empress Eriadna sends an ambassador, and a diplomatic party including the Alphatian PCs, to Thyatis. Her offer to Thincol: Let the empires cooperate for once and send a unified party to crush Helskir. When the dust settles, Alphatia will occupy the eastern half of the city, Thyatis the western half. To the PCs' surprise, Thincol agrees, and sends some of his top military minds and greatest adventurers, including the PCs, back to Sundsvall to coordinate the attack with the Alphatian forces.

Story Progress: Helskir ordinarily wouldn't have a chance. But Alphaks is still smarting from the insult offered him when his volcano community was destroyed. So he plans to bolster the Helskir resistance forces and to get the two empires fighting one another anyway. Alphaks, pretending to be a hitherto-unknown immortal named Helskir (kindly patron of the city), appears before Lord Eruul Zaar and offers his aid to the city, which Zaar eagerly and foolishly accepts.

So when the combined Thyatian and Alphatian forces arrive, the previously unfortified and mostly-human city of Helskir has gone through some changes. Hundreds and hundreds of the citizens have been *polymorphed* into monsters of all sorts—especially the sorts that drive fear

ADVENTURES

into the hearts of common troops, monsters such as dragons and gargoyles and werewolves and giants, manticores and manscorpions and trolls and wyverns, etc. In addition, Alphaks has sent chimeras and giant crabs and the teeming legions of the undead to the city to occupy and "protect" it from the invaders; when not fighting, teams of zombies are erecting earthwork defenses around the city (which they do fast, as they can work 24 hours a day without rest or break).

So the heroes' fleet is confronted by unexpectedly strong and horrible resistance. The initial fights with the hordes of monsters should be long and tiring.

Meanwhile, Alphaks is confusing things among the invading forces. He'll take on the form of a specific general and issue crazy and suicidal orders—or orders which violate the terms of the cooperative treaty between the two empires. Yet when angry heroes confront the (real) generals with these deeds, the officers naturally deny them.

Eventually, the heroes will get the idea that some greater power is interceding on Helskir's behalf. At that point, it's contingent on the heroes to set things straight before the rapidly-growing antagonism between the imperial armies sets them against one another. If clerics *commune* with their Immortal patrons on these matters, immortals of other spheres will promise to help—if the heroes can find and designate the intruder

in his disguised form, the immortals will reveal his perfidy to all those present.

Then, it's up to the heroes to figure out how to trick the villain into appearing in one of his disguised forms. One method is to have one of their generals make a big show of retiring, alone, for the night so that it's very convenient for Alphaks to assume his form.

Once that's done, and the "general" reappears for some more duties, the heroes can make their prayers to the Immortals—who will strip the disguise away from the "general," trapping him in his true form as Alphaks for a time. Alphaks appears as a Roaring Demon (an Emyreal of Entropy—*DM's Guide to Immortals*, page 29) and will certainly do some roaring when he realizes that his disguise and plan are penetrated. He'll suffer the attacks of the massed, outraged invaders for a round or two and then disappear to move on to his next plan.

Afterwards, it's not hard for the invading forces to crush the Helskir defenders and divide the city between them.

Consequences: If the heroes don't realize that an outside force is thwarting them, the consequences for this adventure will be very bad—for the two empires will clash at Helskir and perhaps go to war. However, if the adventure goes much as described above, the two empires will have cooperated gallantly in the face of considerable occupation . . . which could be a good sign for future co-

operative efforts. Either way, consequences for the city of Helskir are severe; it will be occupied or destroyed, its Lord stripped of title and power.

JOURNEY TO SPILLWORLD —

For Character Levels 20 +

Basic Plot: Far across the galaxy, millennia ago, a dimensional rift opened up for a brief time. The rift led to a spot partway between the elemental planes of Earth and Air, and a vast cloud of air filled with tumbling planet-sized boulders was released into this galaxy. Though the rift has closed, this cloud is still there, and has attracted many alien races, while still supporting races from the two elemental planes. Recently, astronomers from the nation of Ambur in Alphatia have spotted this cloud; using their magics, they have learned a little about it and forwarded their findings to their Empress.

How Characters Get Involved: Empress Eriadna has planned to send an expedition of air-ships to this new place. But General Torenal has pointed out that the temporary accord between Alphatia and Thyatis, hard-won at Helskir, could conveniently be preserved here if the Thyatians are allowed to send units of their elite aerial forces along with the expedition. So Eriadna and Thincol correspond, with the result that a fleet from both the empires—made up of one huge Alphatian air-ship (a carrier), and small Alpha-

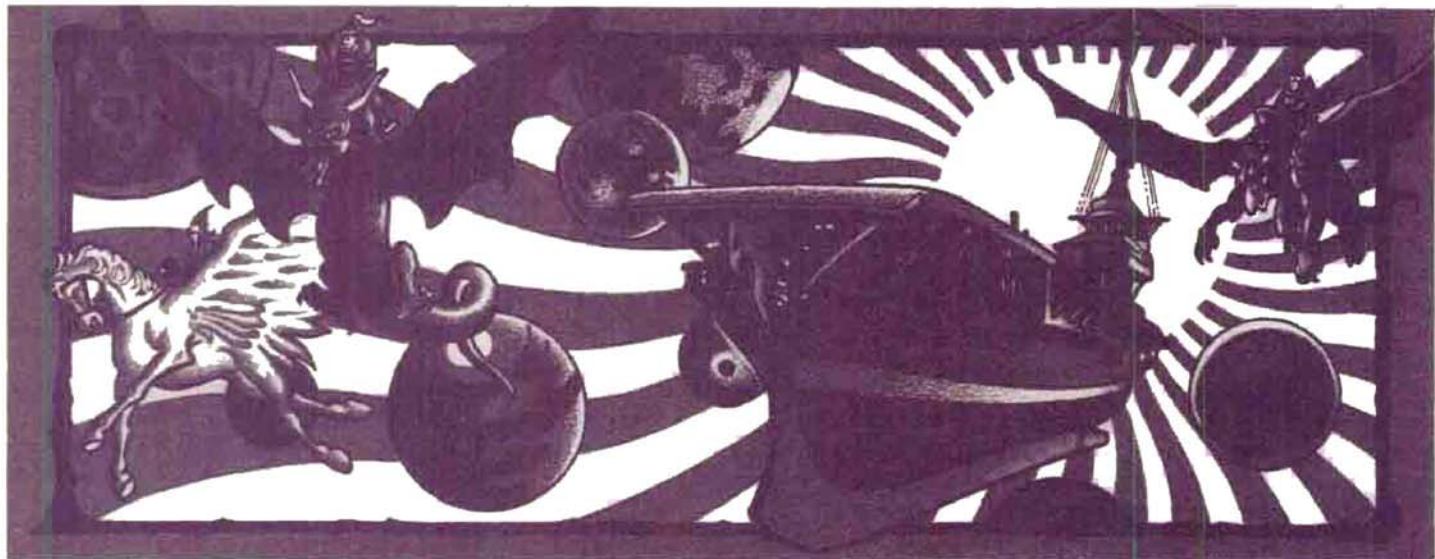

tian fighter-ships and units from the Re-tebius Air Fleet and Knights of the Air (fighter-pilots)—assembles in neutral territory, in the broad strip of land between East Portage and West Portage on the Isle of Dawn.

Story Progress: When the Expeditionary Force is assembled, cooperating Al-phetian and Thyatian wizards will use a combination of *gate* and *wish* spells to create a vortex large enough to accommodate the carrier air-ship. The vortex leads to a worm-hole which leads to this far-away stellar cloud; the spell *gate* allows access to it because it is still charged with the energies of the planes of earth and air.

This adventure would be run as a series of exploratory encounters. The great carrier takes the explorers deep into the

swirling cloud, called SpillWorld by the astronomer who discovered it. SpillWorld contains many hundreds of worlds, all impossibly close to one another, so that it is convenient for the carrier to sail from one to another. Some are occupied by denizens of the plane of air (djinni, aerial servants, air elementals, invisible stalkers, air plasms, salamanders, etc.), some by denizens of the plane of earth (basilisks, cockatrices, earth elementals, gorgons, hordes, kryst, medusae, earth plasms, etc.); many others are occupied by truly alien races and creatures (left to the DM to create) or even descendants of long-lost human races.

In each adventure, the carrier and its fighter-pilot heroes could map a new quadrant of SpillWorld, discover a new

race or two, suffer an enemy attack, etc. Perhaps there is one great evil race which is achieving domination over all the other races of the area, and only the presence of the heroes' ship can unite the other races against this evil.

Pay special attention to the descriptions of interplanar adventures from the *Dungeon Master's Companion* before playing out an adventure such as this.

Consequences: Once SpillWorld has received its initial exploration, a greater fleet of smaller ships and smaller flying contingents can be sent in for better exploration of smaller areas. The ongoing war with the evil race can occupy PC interest, as can investigation of the innumerable sites and small worlds not reached by the first expedition.

APPENDICES

Here you'll find some convenient reference materials which will help you DM Thyatian and Alpathian campaigns.

Costs

This is a consolidated list and index of many of the goods and services one can buy in the two empires. Most of these goods and services apply to both empires; some are designated as applying only to one or the other.

Animals, Flying

If you're using the Retebius Air Fleet or the Knights of the Air and want to know costs of animals not on the chart, calculate those costs the following way:

Cost of a flying-beast egg or cub: Equals the XP value of a fully adult example of the same monster, including bonuses for special abilities (if any), in gp. Even though you pay for the value of special abilities, such monsters when taken young never develop magical powers (such as dragons' spell-casting ability). They only learn such things among their own kind. If the gold piece amount generated by this formula seems low (as it will with low-XP monsters like pegasi), adjust it up to suit yourself.

Monthly upkeep of a flying beast: 10x its current HD in gold pieces. Round up to the next-highest 10 gp.

Calculation for the Cost and Weight Multiplier for Gear and Armor: If the beast's HD value is up to 3d6, the Multiplier is x2; if it's above 3d6 to 6d6, x5; if it's above 6d6 to 12d6, x10; if it's above 12d6, x20.

ARMOR

See:
Players Manual, pages 22, 29
Expert Rulebook, page 19
Players Companion, page 3
Master Players' Book, page 15
Master DM's Book, page 4

CONSTRUCTIONS AND FORTIFICATIONS

See:
Expert Rulebook, page 23
Master Players' Book, page 28

DOMINION EXPENSES AND INCOME

See:
Dungeon Master's Companion, pages 5-6

Education

The cost of educating your children is much the same from Thyatis to Alpathia. It varies from profession (or type of knowledge) to profession. The ones of most interest to PCs include:

Clerical Training: Free if the child is to enter the order. A clerical education without intent to join the order costs 50 gp/month for a modest monastery to 500 gp/month for education in prestigious clerical schools, and does not impart clerical abilities.

Magic-user Teaching: 100 gp/month, which will enable the child to reach 1st level as a magic-user; the student must adventure in the world to achieve higher experience levels. Cost of boarding, if the child is not living with his parents, is an additional 50 gp/month (for modest accommodations) to 500 gp/month (for high-prestige accommodations); it takes about a year for a child to reach 1st level.

EMPLOYEES (Prices in gp/month)

Advocate	1000
Chaplain (Cleric)	100/level
Magic-user (wartime tasks)	1000xlevel
Magic-user (peacetime tasks)	500xlevel
Magist	250xlevel

See also:
Expert Rulebook, pages 24 (Mercenaries) and 26 (Specialists)
Players Companion, pages 8-9 (Staff)

HOSTING VISITORS (Prices in gp/day)

Member of Noble's Retinue	5
High-Placed Government Official (Thyatis or Alpathia)	50
Grand Council Wizard (Alpathia)	500

See also:
Dungeon Master's Companion, page 6

LAND TRANSPORT

See:
Expert Rulebook, page 19

Magic Item Creation

See:
Expert Rulebook, page 25
GAZ 3, *The Principalities of Glantri*, pages 64-67
GAZ 6, *The Dwarves of Rockhome*, pages 33-36
The Book of Wondrous Inventions, pages 93-96
Dawn of the Emperors, Book III, pages 27-32

Magic Item Purchase

See:
Master DM's Book, page 4
Dawn of the Emperors, Book III, page 28 (Costs for Buying Magic Items)

NORMAL EQUIPMENT

See:
Players Manual, pages 22, 29
Expert Rulebook, page 19

Services

Meal, One Person—	
Modest	4 sp
Average	1 gp
Superior	10 gp
Extravagant	50 gp
Day's Lodging (Inn)—	
Modest	1 gp
Average	5 gp
Superior	50 gp
Extravagant	500 gp
Day's Stabling (Inn)—	
Modest	1 gp
Average	2 gp
Superior	10 gp
Extravagant	25 gp
Month's Rent, Quarters or House—	
Modest	50 gp
Average	100 gp
Superior	500 gp
Extravagant	5000 gp

Month's Rent, Office—	
Modest	100 gp
Average	200 gp
Superior	500 gp
Extravagant	5000 gp

Slaves

0-level, unexceptional	1
0-level, one ability score above 12	2
0-level, two scores above 12	4
0-level, one score above 15	8
0-level, two scores above 15	16
1st-level, unexceptional	4
1st-level, one score above 12	8
1st-level, two scores above 12	16
1st-level, one score above 15	32
1st-level, two scores above 15	64
2nd-level, unexceptional	32
2nd-level, 1+ scores above 12	64
2nd-level, 1+ scores above 15	128
Above 2nd level:	
Unexceptional	50/level
1+ abilities above 12	100/level
1+ abilities above 15	200/level

If a slave has a combination of the above attributes (say, one ability at 16 and two at 13), use just the higher of the two prices.

If your DM is using the General Skills rules, a slave with no exceptional ability but with skills at rolls of 13 or better can be counted as having an "ability above 12."

Slaves above 1st-level are usually gladiator fighters. Magic-users and clerics cannot be kept as slaves—it's illegal in Alphatia and effectively impossible everywhere due to their magical powers.

Siege Equipment

See: *Master Players' Book*, page 28

Titles & Appointments (Thyatis Only)

Ambassador	100,000
Audience with the Emperor	100,000
General	250,000
Lord	250,000
Baron	500,000

See the description in the "Campaigning in Thyatis" section (of the "Thyatis" chapter) for more on how this works.

Trade Goods (Bulk)

See:
GAZ 9, *The Minrothad Guilds DM's Booklet*, page 32
GAZ 11, *The Republic of Darokin DM's Booklet*, page 26

Water Transport

See:
Expert Rulebook, page 19
GAZ 4, *The Kingdom of Ierendi*, page 35
GAZ 9, *The Minrothad Guilds*, page 25

Weapons

See:
Players Manual, pages 22, 29
Expert Rulebook, page 19
Players Companion, pages 3, 20-21, 28 (Siege Weapons)
Master DM's Book, page 4
Dawn of the Emperors, Book II, page 12

Weapons Training (Mastery)

See:
Master Players' Book, page 16

Spells Normally Carried

(Magic-users, Elves, Foresters)

Here, for your convenience, are lists of spells typically carried by NPC magic-users in the Known World. This list is provided so that when you suddenly need to whip out a 24th-level wizard NPC, you won't have to go through a lot of work deciding which spells he happens to be carrying around. The NPC magic-users in the earlier sections of this book can be used with these listings.

Spells are provided for wizards of 1st-10th, 12th, 15th, 18th, 24th, 30th, and 36th level in three types of situations: Everyday settings, Adventure settings, and Combat settings.

Everyday settings are those situations when the magic-user does not anticipate going into combat; he thinks he'll just be

puttering around his tower, visiting friends, and so forth. These spells deal with a variety of everyday situations; the few combat spells included are mostly non-lethal ones. Higher-level magic-users typically carry magic items which increase their combat effectiveness, so their personal spells are oriented toward gentler concerns.

Adventure settings are those situations when the magic-user is doing a lot of traveling and a certain amount of combat. These spells allow him quick travel, and some combat and analytical ability.

Combat settings are those situations when the magic-user anticipates that he's going to have to do a lot of fighting.

This listing only uses spells from the four DUNGEONS & DRAGONS® game sets; later spell-list additions are not represented here.

This listing isn't intended as a guideline for player-character magic-users and the spells they carry; obviously, they can

and should choose their own spells-carried list based on the precise situations they think they'll be facing and the spells available to them.

Spells for Everyday Situations

M-U Level	Spell Level	Spells Carried
1	1	<i>Read Magic</i>
2	1	<i>Read Magic</i> <i>Sleep</i>
3	1	<i>Read Magic</i> <i>Sleep</i>
	2	<i>Invisibility</i>
4	1	<i>Read Magic</i> <i>Sleep</i>
	2	<i>ESP</i> <i>Invisibility</i>
5	1	<i>Read Magic</i> <i>Sleep</i>
	2	<i>ESP</i>

APPENDICES

M-U Level	Spell Level	Spells Carried
	3	<i>Invisibility</i> <i>Dispel Magic</i>
6	1	<i>Read Magic</i> <i>Sleep</i>
	2	<i>ESP</i> <i>Invisibility</i>
	3	<i>Clairvoyance</i> <i>Dispel Magic</i>
8	1	<i>Detect Magic</i> <i>Read Magic</i> <i>Sleep</i>
	2	<i>Continual Light</i> <i>ESP</i> <i>Invisibility</i>
	3	<i>Clairvoyance</i> <i>Dispel Magic</i>
	4	<i>Polymorph Self</i> <i>Polymorph Self</i>
10	1	<i>Detect Magic</i> <i>Read Magic</i> <i>Sleep</i>
	2	<i>Continual Light</i> <i>ESP</i> <i>Invisibility</i>
	3	<i>Clairvoyance</i> <i>Dispel Magic</i> <i>Fly</i>
	4	<i>Polymorph Others</i> <i>Polymorph Self</i> <i>Polymorph Self</i>
	5	<i>Pass-Wall</i> <i>Teleport</i>
12	1	<i>Detect Magic</i> <i>Read Languages</i> <i>Read Magic</i> <i>Sleep</i>
	2	<i>Continual Light</i> <i>ESP</i> <i>Invisibility</i> <i>Locate Object</i>
	3	<i>Clairvoyance</i> <i>Dispel Magic</i> <i>Fly</i> <i>Hold Person</i>
	4	<i>Polymorph Others</i> <i>Polymorph Self</i> <i>Polymorph Self</i>
	5	<i>Pass-Wall</i> <i>Teleport</i>
	6	<i>Anti-Magic Shell</i>

M-U Level	Spell Level	Spells Carried
15	1	<i>Detect Magic</i> <i>Hold Portal</i> <i>Read Languages</i> <i>Read Magic</i> <i>Sleep</i>
	2	<i>Continual Light</i> <i>ESP</i> <i>Invisibility</i> <i>Locate Object</i>
	3	<i>Clairvoyance</i> <i>Dispel Magic</i> <i>Fly</i> <i>Hold Person</i>
	4	<i>Polymorph Others</i> <i>Polymorph Self</i> <i>Remove Curse</i> <i>Polymorph Self</i>
	5	<i>Pass-Wall</i> <i>Telekinesis</i> <i>Teleport</i>
	6	<i>Anti-Magic Shell</i> <i>Reincarnation</i>
	7	<i>Lore</i>
18	1	<i>Charm Person</i> <i>Detect Magic</i> <i>Hold Portal</i> <i>Read Languages</i> <i>Read Magic</i> <i>Sleep</i>
	2	<i>Continual Light</i> <i>Detect Invisible</i> <i>ESP</i> <i>Invisibility</i> <i>Locate Object</i>
	3	<i>Clairvoyance</i> <i>Dispel Magic</i> <i>Fly</i> <i>Hold Person</i> <i>Protection/Normal Missiles</i>
	4	<i>Polymorph Others</i> <i>Polymorph Self</i> <i>Remove Curse</i> <i>Polymorph Self</i>
	5	<i>Contact Outer Plane</i> <i>Pass-Wall</i> <i>Telekinesis</i> <i>Teleport</i>
	6	<i>Anti-Magic Shell</i> <i>Reincarnation</i>

M-U Level	Spell Level	Spells Carried
	7	<i>Weather Control</i> <i>Lore</i> <i>Summon Object</i>
	8	<i>Travel</i>
24	1	<i>Charm Person</i> <i>Detect Magic</i> <i>Hold Portal</i> <i>Magic Missile</i> <i>Read Languages</i> <i>Read Magic</i> <i>Sleep</i>
	2	<i>Continual Light</i> <i>Detect Evil</i> <i>Detect Invisible</i> <i>ESP</i> <i>Invisibility</i> <i>Locate Object</i> <i>Phantasmal Force</i>
	3	<i>Clairvoyance</i> <i>Dispel Magic</i> <i>Fly</i> <i>Hold Person</i> <i>Infravision</i> <i>Protection/Normal Missiles</i>
	4	<i>Charm Monster</i> <i>Dimension Door</i> <i>Polymorph Others</i> <i>Polymorph Self</i> <i>Remove Curse</i> <i>Polymorph Self</i>
	5	<i>Contact Outer Plane</i> <i>Hold Monster</i> <i>Pass-Wall</i> <i>Telekinesis</i> <i>Teleport</i>
	6	<i>Anti-Magic Shell</i> <i>Projected Image</i> <i>Reincarnation</i> <i>Stone to Flesh</i> <i>Weather Control</i>
	7	<i>Create Normal Monsters</i> <i>Lore</i> <i>Power Word Stun</i> <i>Summon Object</i>
	8	<i>Clone</i> <i>Permanence</i> <i>Travel</i>
	9	<i>Heal</i> <i>Shapechange</i>

M-U Level	Spell Level	Spells Carried
30	1	<i>Charm Person</i> <i>Detect Magic</i> <i>Hold Portal</i> <i>Magic Missile</i> <i>Protection/Evil 10' radius</i> <i>Read Languages</i> <i>Read Magic</i> <i>Sleep</i>
	2	<i>Continual Light</i> <i>Detect Evil</i> <i>Detect Invisible</i> <i>ESP</i> <i>Invisibility</i> <i>Locate Object</i> <i>Phantasmal Force</i> <i>Wizard Lock</i>
3	3	<i>Clairvoyance</i> <i>Dispel Magic</i> <i>Fly</i> <i>Hold Person</i> <i>Infravision</i> <i>Invisibility 10' radius</i> <i>Protection/Evil 10' radius</i> <i>Protection/Normal Missiles</i>
	4	<i>Charm Monster</i> <i>Confusion</i> <i>Dimension Door</i> <i>Polymorph Others</i> <i>Polymorph Self</i> <i>Remove Curse</i> <i>Polymorph Self</i>
	5	<i>Conjure Elemental</i> <i>Contact Outer Plane</i> <i>Hold Monster</i> <i>Pass-Wall</i> <i>Telekinesis</i> <i>Teleport</i> <i>Wall of Stone</i>
6	6	<i>Anti-Magic Shell</i> <i>Geas</i> <i>Move Earth</i> <i>Projected Image</i> <i>Reincarnation</i> <i>Stone to Flesh</i> <i>Weather Control</i>
	7	<i>Create Normal Monsters</i> <i>Lore</i> <i>Magic Door</i> <i>Power Word Stun</i> <i>Summon Object</i> <i>Teleport any Object</i>
8	8	<i>Clone</i> <i>Force Field</i>

M-U Level	Spell Level	Spells Carried
36	9	<i>Permanence</i> <i>Polymorph any Object</i> <i>Symbol</i> <i>Travel</i> <i>Gate</i> <i>Heal</i> <i>Immunity</i> <i>Prismatic Wall</i> <i>Shapechange</i>
	1	<i>Charm Person</i> <i>Detect Magic</i> <i>Floating Disk</i> <i>Hold Portal</i> <i>Magic Missile</i> <i>Protection/Evil 10' radius</i> <i>Read Languages</i> <i>Read Magic</i> <i>Sleep</i>
2	2	<i>Continual Light</i> <i>Detect Evil</i> <i>Detect Invisible</i> <i>ESP</i> <i>Invisibility</i> <i>Knock</i> <i>Locate Object</i> <i>Phantasmal Force</i> <i>Wizard Lock</i>
	3	<i>Clairvoyance</i> <i>Dispel Magic</i> <i>Fly</i> <i>Hold Person</i> <i>Infravision</i> <i>Invisibility 10' radius</i> <i>Lightning Bolt</i> <i>Protection/Evil 10' radius</i> <i>Protection/Normal Missiles</i>
4	4	<i>Charm Monster</i> <i>Confusion</i> <i>Dimension Door</i> <i>Ice Storm/Wall</i> <i>Polymorph Others</i> <i>Polymorph Self</i> <i>Remove Curse</i> <i>Wall of Fire</i> <i>Polymorph Self</i>
	5	<i>Conjure Elemental</i> <i>Contact Outer Plane</i> <i>Feeblemind</i> <i>Hold Monster</i> <i>Magic Jar</i> <i>Pass-Wall</i> <i>Telekinesis</i> <i>Teleport</i>

M-U Level	Spell Level	Spells Carried
6	6	<i>Wall of Stone</i> <i>Anti-Magic Shell</i> <i>Geas</i> <i>Invisible Stalker</i> <i>Move Earth</i> <i>Projected Image</i> <i>Reincarnation</i> <i>Stone to Flesh</i> <i>Wall of Iron</i> <i>Weather Control</i>
	7	<i>Create Normal Monsters</i> <i>Delayed Blast Fire Ball</i> <i>Lore</i> <i>Magic Door</i> <i>Power Word Stun</i> <i>Reverse Gravity</i> <i>Summon Object</i> <i>Sword</i> <i>Teleport any Object</i>
8	8	<i>Clone</i> <i>Force Field</i> <i>Mass Charm</i> <i>Mind Barrier</i> <i>Permanence</i> <i>Polymorph any Object</i> <i>Power Word Blind</i> <i>Symbol</i> <i>Travel</i>
	9	<i>Create Any Monster</i> <i>Gate</i> <i>Heal</i> <i>Immunity</i> <i>Maze</i> <i>Power Word Kill</i> <i>Prismatic Wall</i> <i>Shapechange</i> <i>Wish</i>

Spells for Adventuring Situations

M-U Level	Spell Level	Spells Carried
1	1	<i>Sleep</i>
2	1	<i>Read Magic</i> <i>Sleep</i>
	1	<i>Read Magic</i> <i>Sleep</i>
3	1	<i>Read Magic</i> <i>Sleep</i>
	2	<i>Locate Object</i>
4	1	<i>Read Magic</i> <i>Sleep</i>

APPENDICES

M-U Level	Spell Level	Spells Carried
	2	Locate Object Web
5	1	Read Magic Sleep
	2	Locate Object Web
	3	Fly
6	1	Read Magic Sleep
	2	Locate Object Web
	3	Fly Lightning Bolt
8	1	Protection/Evil 10' radius Read Magic Sleep
	2	Detect Evil Locate Object Web
	3	Fly Lightning Bolt
	4	Charm Monster Polymorph Self
10	1	Protection/Evil 10' radius Read Magic Sleep
	2	Detect Evil Locate Object Web
	3	Dispel Magic Fly Lightning Bolt
	4	Charm Monster Ice Storm/Wall Polymorph Self
	5	Conjure Elemental Pass-Wall
12	1	Detect Magic Protection/Evil 10' radius Read Magic Sleep
	2	Continual Light Detect Evil Locate Object Web
	3	Dispel Magic Fly Lightning Bolt

M-U Level	Spell Level	Spells Carried
		Protection/Normal Mis- siles
	4	Charm Monster Ice Storm/Wall Polymorph Self
	5	Conjure Elemental Pass-Wall
	6	Disintegrate
15	1	Charm Person Detect Magic Protection/Evil 10' radius Read Magic Sleep
	2	Continual Light Detect Evil
	3	Locate Object Web Dispel Magic Fly Lightning Bolt
	4	Protection/Normal Mis- siles Charm Monster Dimension Door Ice Storm/Wall Polymorph Self
	5	Conjure Elemental Pass-Wall Teleport
	6	Anti-Magic Shell Disintegrate
	7	Magic Door
18	1	Charm Person Detect Magic Magic Missile Protection/Evil 10' radius Read Magic Sleep
	2	Continual Light Detect Evil Invisibility Locate Object Web
	3	Dispel Magic Fire Ball Fly Lightning Bolt
		Protection/Normal Mis- siles

M-U Level	Spell Level	Spells Carried
	4	Charm Monster Dimension Door Ice Storm/Wall Polymorph Self
	5	Conjure Elemental Pass-Wall Teleport Wall of Stone
	6	Anti-Magic Shell Disintegrate Reincarnation
	7	Create Normal Monsters Magic Door
	8	Force Field
24	1	Charm Person Detect Magic Magic Missile Protection/Evil 10' radius Read Languages Read Magic Sleep
	2	Continual Light Detect Evil Invisibility Knock Locate Object Web Wizard Lock
	3	Clairvoyance Dispel Magic Fire Ball Fly Lightning Bolt
	4	Protection/Normal Mis- siles Charm Monster Confusion Dimension Door Ice Storm/Wall Polymorph Others Polymorph Self
	5	Conjure Elemental Pass-Wall Telekinesis Teleport Wall of Stone
	6	Anti-Magic Shell Disintegrate Invisible Stalker Reincarnation

M-U Level	Spell Level	Spells Carried
	7	Wall of Iron Create Normal Monsters Delayed Blast Fire Ball Lore
	8	Magic Door Create Magical Monsters Force Field
	9	Polymorph any Object Immunity Shapechange
30	1	Charm Person Detect Magic Magic Missile Protection/Evil 10' radius Read Languages Read Magic Shield Sleep
	2	Continual Light Detect Evil ESP Invisibility Knock Locate Object Web Wizard Lock
	3	Clairvoyance Dispel Magic Fire Ball Fly Hold Person Infravision Lightning Bolt Protect/Missiles
	4	Charm Monster Confusion Dimension Door Ice Storm/Wall Polymorph Others Polymorph Self Polymorph Self
	5	Conjure Elemental Dissolve Feeblemind Pass-Wall Telekinesis Teleport Wall of Stone
	6	Anti-Magic Shell Death Spell Disintegrate Invisible Stalker Projected Image

M-U Level	Spell Level	Spells Carried
	7	Reincarnation Wall of Iron Create Normal Monsters Delayed Blast Fire Ball Lore Magic Door Power Word Stun Sword
	8	Clone Create Magical Monsters Force Field Mass Charm Polymorph any Object Power Word Blind
	9	Heal Immunity Meteor Swarm Shapechange Wish
36	1	Charm Person Detect Magic Hold Portal Magic Missile Protection/Evil 10' radius Read Languages Read Magic Shield Sleep
	2	Continual Light Detect Evil Detect Invisible ESP Invisibility Knock Locate Object Web Wizard Lock
	3	Clairvoyance Dispel Magic Fire Ball Fly Hold Person Infravision Lightning Bolt Protection/Evil 10' radius Protection/Normal Missiles
	4	Charm Monster Confusion Dimension Door Hallucinatory Terrain Ice Storm/Wall Polymorph Others Polymorph Self

M-U Level	Spell Level	Spells Carried
	5	Wall of Fire Polymorph Self Cloudkill Conjure Elemental Dissolve Feeblemind Hold Monster Pass-Wall Telekinesis Teleport Wall of Stone
	6	Anti-Magic Shell Death Spell Disintegrate Invisible Stalker Projected Image Reincarnation Stone to Flesh Wall of Iron Weather Control
	7	Charm Plant Create Normal Monsters Delayed Blast Fire Ball Lore Magic Door Mass Invisibility Power Word Stun Sword Teleport any Object
	8	Clone Create Magical Monsters Explosive Cloud Force Field Mass Charm Mind Barrier Polymorph any Object Power Word Blind Travel
	9	Create Any Monster Heal Heal Immunity Maze Meteor Swarm Power Word Kill Shapechange Wish

Appendices

Spells for Combat Situations

M-U Level	Spell Level	Spells Carried
1	1	Sleep
2	1	Magic Missile Sleep
3	1	Magic Missile Sleep
	2	Web
4	1	Magic Missile Sleep
	2	Web Wizard Lock
5	1	Magic Missile Sleep
	2	Web Wizard Lock
	3	Lightning Bolt
6	1	Magic Missile Sleep
	2	Web Wizard Lock
	3	Fire Ball Lightning Bolt
8	1	Magic Missile Shield Sleep
	2	Detect Invisible Web Wizard Lock
	3	Fire Ball Lightning Bolt
	4	Ice Storm/Wall Wall of Fire
10	1	Magic Missile Shield Sleep
	2	Detect Invisible Web Wizard Lock
	3	Fire Ball Lightning Bolt Protection/Normal Missiles
	4	Ice Storm/Wall Polymorph Others Wall of Fire
	5	Conjure Elemental Hold Monster
12	1	Charm Person Magic Missile Shield

M-U Level	Spell Level	Spells Carried
	2	Sleep Detect Invisible Phantasmal Force Web
	3	Wizard Lock Fire Ball Lightning Bolt Protection/Evil 10' radius Protection/Normal Missiles
	4	Ice Storm/Wall Polymorph Others Wall of Fire
	5	Conjure Elemental Hold Monster
	6	Death Spell
15	1	Charm Person Hold Portal Magic Missile Shield Sleep
	2	Detect Invisible Phantasmal Force Web Wizard Lock
	3	Fire Ball Lightning Bolt Protection/Evil 10' radius Protect/Normal Missiles
	4	Charm Monster Ice Storm/Wall Polymorph Others Wall of Fire
	5	Cloudkill Conjure Elemental Hold Monster
	6	Death Spell Disintegrate
	7	Delayed Blast Fire Ball
18	1	Charm Person Hold Portal Magic Missile Protection/Evil 10' radius Shield Sleep
	2	Detect Invisible Invisibility Phantasmal Force Web Wizard Lock
	3	Dispel Magic Fire Ball Lightning Bolt

M-U Level	Spell Level	Spells Carried
	4	Protection/Evil 10' radius Protection/Normal Missiles Charm Monster Ice Storm/Wall Polymorph Others Wall of Fire
	5	Cloudkill Conjure Elemental Feeblemind Hold Monster
	6	Death Spell Disintegrate Stone to Flesh
	7	Delayed Blast Fire Ball Sword
	8	Power Word Blind
24	1	Charm Person Hold Portal Magic Missile Magic Missile Protection/Evil 10' radius Shield Sleep
	2	Detect Invisible ESP Invisibility Mirror Image Phantasmal Force Web Wizard Lock
	3	Dispel Magic Fire Ball Fly Lightning Bolt Protection/Evil 10' radius Protection/Normal Missiles
	4	Charm Monster Confusion Hallucinatory Terrain Ice Storm/Wall Polymorph Others Wall of Fire
	5	Cloudkill Conjure Elemental Dissolve Feeblemind Hold Monster
	6	Anti-Magic Shell Death Spell Disintegrate Projected Image Stone to Flesh

M-U Level	Spell Level	Spells Carried
	7	Create Normal Monsters Delayed Blast Fire Ball Power Word Stun Sword
	8	Create Magical Monsters Explosive Cloud Power Word Blind
	9	Immunity Meteor Swarm
30	1	Charm Person Hold Portal Magic Missile Magic Missile Protection/Evil 10' radius Shield Sleep Sleep
	2	Detect Invisible ESP Invisibility Knock Mirror Image Phantasmal Force Web Wizard Lock
	3	Dispel Magic Fire Ball Fly Hold Person Lightning Bolt Lightning Bolt Protection/Evil 10' radius Protection/Normal Missiles
	4	Charm Monster Confusion Dimension Door Hallucinatory Terrain Ice Storm/Wall Polymorph Others Wall of Fire
	5	Animate Dead Cloudkill Conjure Elemental Dissolve Feeblemind Hold Monster Wall of Stone
	6	Anti-Magic Shell Death Spell Disintegrate Invisible Stalker Projected Image Stone to Flesh

M-U Level	Spell Level	Spells Carried
	7	Wall of Iron Create Normal Monsters Delayed Blast Fire Ball Power Word Stun Summon Object Sword Teleport any Object
	8	Create Magical Monsters Explosive Cloud Force Field Mass Charm Power Word Blind Symbol
	9	Create Any Monster Immunity Meteor Swarm Power Word Kill Wish
36	1	Charm Person Hold Portal Magic Missile Magic Missile Protection/Evil 10' radius Shield Shield Sleep Sleep
	2	Detect Evil Detect Invisible ESP Invisibility Knock Mirror Image Phantasmal Force Web Wizard Lock
	3	Dispel Magic Dispel Magic Fire Ball Fly Hold Person Lightning Bolt Lightning Bolt Protection/Evil 10' radius Protection/Normal Missiles
	4	Charm Monster Confusion Dimension Door Hallucinatory Terrain Ice Storm/Wall Ice Storm/Wall Polymorph Others Remove Curse

M-U Level	Spell Level	Spells Carried
	5	Wall of Fire Animate Dead Cloudkill Conjure Elemental Dissolve Feeblemind Feeblemind Hold Monster Telekinesis Wall of Stone
	6	Anti-Magic Shell Death Spell Death Spell Disintegrate Disintegrate Invisible Stalker Projected Image Stone to Flesh Wall of Iron
	7	Create Normal Monsters Delayed Blast Fire Ball Delayed Blast Fire Ball Magic Door Power Word Stun Reverse Gravity Summon Object Sword Teleport any Object
	8	Create Magical Monsters Dance Explosive Cloud Force Field Mass Charm Mind Barrier Polymorph any Object Power Word Blind Symbol
	9	Create Any Monster Heal Immunity Maze Meteor Swarm Power Word Kill Prismatic Wall Shapechange Wish

Appendices

Adapting Gazetteers to the AD&D® 2ND Edition Game

Many of you may soon be switching to the ADVANCED DUNGEONS & DRAGONS® 2nd Edition Game. For your convenience, we included this section to help you use this Gazetteer in your AD&D® game campaign. Changes in the AD&D game have been taken into account here.

The differences between the D&D® and the AD&D games are small enough that the adaptation should not be much of a problem. However, for those of you who are not familiar at all with the D&D game, there are a few details that need to be clarified. For more simplicity, topics appear in alphabetical order.

Keep in mind when adapting your D&D game adventures, that AD&D game characters are slightly tougher at low level, but D&D game characters can deliver much more damage at mid to high level.

The D&D game is designed to handle very high levels of play, up to a maximum of level 36. It is suggested that you keep the same levels of experience in the two games, up to level 14. Beyond, assume that each five D&D game levels equal one character level in the AD&D 2nd Edition game, rounded up. Using this, a level 36 fighter becomes level 20 in the AD&D game. Watch for discrepancies in spell-casting abilities.

Gazetteer nations can be set up in other game worlds, such as those described in the FORGOTTEN REALMS™ Campaign Set, or the WORLD OF GREYHAWK® Fantasy Game Setting. This offers interesting alternative developments to regions not yet charted, allowing you to continue your campaign without having to switch to the other game.

Some of the more powerful shamans of Ethengar are capable of entering the ethereal plane and reaching other worlds. Most often, shamans are attuned to places like the Plain of Horses in Forgotten Realms region of Kara Tur, or the Tiger Nomads in the WORLD OF GREYHAWK® Fantasy Game Setting. Visitors accompanying or sent by a shaman usually seem to *phase* out of an animal when entering the other world.

Alignments: D&D game characters have only three alignments—Lawful, Neutral, or Chaotic. In the AD&D game, assign Good, Evil, or Neutral alignments, depending on the context.

Classes: In the D&D game, elves, dwarves, and halflings actually are character classes. D&D game elves correspond to AD&D game elven *fighter/magic-users*. D&D game dwarves and halflings are *fighters*. At high levels, D&D game demihumans use *Attack Ranks*, which are abilities to fight better. Ignore these in the AD&D game. Human fighters, clerics, magic-users, and thieves are unchanged.

Coins (cn): The *cn* abbreviation stands for *coin* and is a measure of weight. 50 *cn* are equal to 1 lb in the AD&D game.

Dominions: They are lands under a character's rule, like AD&D game baronies. Rulers receive taxes from inhabitants as well as income from natural resources and services. D&D game dominion populations grow an average 15%–5d10 people per month. At 50 inhabitants per square mile, the growth tops out at 1d5%–5d10 people. Use AD&D game taxation.

Equipment: The terminology in the D&D game is very similar to the AD&D game. Equipment cost, encumbrance, damage in combat, or AC protection are slightly different, but not enough to be worth mentioning. Use the AD&D game statistics.

Encumbrance: See *cn* or *Coins*.

Experience: Total accumulated experience for characters is also different between the two games, but again, not enough to have a substantial effect on play. Everybody understands the difference between a level 1 magic-user and a level 15 wizard . . . hopefully!

Immortals: They are equivalent to the AD&D game deities. Immortals often are NPCs who reached level 36, and completed a heroic quest of some sort. Immortals belong to various "spheres", such as:

Matter: usually related to lawful beings, fighter types, or the earth element. Opposed to the Sphere of Time.

Energy: usually related to chaos, magic-users, or the element of fire. Opposed to the Sphere of Thought.

Time: usually related to neutral beings, cleric types, or the element of water. Opposed to the Sphere of Matter.

Thought: usually related to any align-

ments, thief types, or the element or air. Opposes the Sphere of Energy.

Entropy: not related to anything except destruction, it opposes all other spheres. It corresponds to the AD&D game lower planes. Lords of Entropy are demons.

Morale: Whenever NPCs or monsters run into difficulties, especially during combat, there is a possibility they would surrender or flee. Use the AD&D 2nd Edition game morale system instead.

Monsters: Some monsters mentioned in this supplement do not exist in the AD&D game. Simply replace them with another appropriate creature. Keep an eye on play balance; differences in HD and special abilities may occur at times, calling for adjustments.

Movement (MV): Movement rates in the D&D game are given in *feet/turn*, and then in parenthesis, in *feet/round*. In the D&D game, 100'/turn equals 10 factors for the AD&D 2nd Edition game, or 10"/round for the older version of the AD&D game.

Ranges: All distances are expressed in *feet*, rather than inches. Assume 10 feet are equivalent to 1" in the older AD&D game. The AD&D 2nd Edition game uses feet rather than inches.

Rounds: Rounds and turns are used the same way in both games. A D&D game round equals ten seconds; a D&D game turn equals 60 rounds — for more simplicity use the AD&D game equivalents, without converting.

Spells: Some D&D game spells have slightly different names than their AD&D game counterpart. Simply use what comes closest. Modify the number of memorized spells listed for spell-casters, to match the AD&D game rules.

War Machine: It is a mass combat system developed in the D&D game, that has no equivalent in the AD&D game. *BR* stands for *Battle Rating* and is only used for the War Machine. We suggest the BATTLESYSTEM™ Fantasy Combat Supplement which works for both games.

Weapon Mastery: Ignore details for D&D game weapon mastery and replace with the AD&D game weapon specialization.

Wiccans: Spell-casting monsters. The AD&D 2nd Edition game handles each type of spell-casting monster separately in the Monstrous Compendiums.

Flying Monster Rules

To convert the Flying Monster rules from this book's "Campaigning" section and the "Fighters of Thyatis" section from *Book II*, do the following things.

Flying Monster Air-Speed

Instead of using the movement rates given here, use the flying speed rates given in the *Monster Manual* and other sources of AD&D® game monsters.

For example, a griffon, instead of having the Air-Speed given on the charts in this supplement, will have a flight speed of 30" per round.

Flying Monster Maneuverability

In these rules, you were given Maneuver Factors for various types of monsters. Convert those to the AD&D game Aerial Combat maneuverability rules (from the Aerial Combat section of the *Dungeon Master's Guide*) this way:

- MF 5 = Class A
- MF 3 = Class B
- MF 1 = Class C
- MF 1/2 = Class D
- MF 1/3 = Class E

Where these rules and the *Dungeon Master's Guide* disagree on the maneuverability of various monster types, use the *DM Guide* figure instead.

Flying Monster Takeoff

Use the takeoff characteristics from the charts in this supplement.

Flying Monster Hit Dice

Use the hit dice figures given in the *Monster Manual* and other AD&D game monster sources.

Flying Monster Cost for Young

To determine how much a flying monster cub or egg costs, use the formula given in the Prices section of this Appendices chapter. The cost of a cub or egg equals, in gp, the experience value of a fully-grown example of the same monster. Thus, the cost of an egg from an AD&D game roc would be 5,000 gp plus 25 gp per hit point of the adult roc—an average

of 63 hp, or 1,575 more gp, for a total of 6,575 gp.

You can only purchase eggs or cubs for the monster types listed in the "Fighters of Thyatis" chapter, except with special DM permission—which should seldom be granted.

Flying Monster Upkeep

As given earlier in the Prices section of this Appendices chapter, the monthly cost for keeping a flying beast is 10 gp x the number of hit dice the beast possesses.

Flying Monster Equipment Costs

Use the same Cost and Weight Multipliers for Gear and Armor from the chart in the "Fighters of Thyatis" chapter, but use the costs for barding, tack and harness, and other equipment from the equipment lists of the AD&D game *Player's Handbook*.

Flying Monster Carry Capacity

To determine how much weight an AD&D game monster can carry, take its hit dice and multiply that number by 1,000 gp weight. The result is the amount of weight the monster can carry aloft.

For example, an AD&D game griffon is a 7 HD monster. Therefore, it can carry 7,000 gp weight when flying. When the AD&D game doesn't give a gp weight value for something, simply take the D&D® game equivalent and convert it, 1 cn = 1 gp.

Other Factors

For other flying monster factors, such as training times and growth rates, use the rules from this supplement.

Where rules do appear in the AD&D game, such as that game's rules for aerial combat and engagement, use the AD&D game rules instead.

Optional Armor Rules

To convert the optional armor rules from the "Fighters of Thyatis" chapter for use with the AD&D game, do the following:

Armor Value Ratings

All AD&D game armor keeps its listed cost and encumbrance value.

However, the armor is given an Armor Value rating (as per the "Fighters of Thyatis" chapter) in the following manner:

Type of Armor	Armor Value
None	0
Leather Armor	2
Padded Armor	2
Studded Leather	3
Ring Mail	3
Scale Mail	4
Chain Mail	5
Splint Mail	6
Banded Mail	6
Plate Mail	7

As in the "Fighters of Thyatis" chapter, armor no longer provides an AC bonus to its wearer—unless it's magical armor, where the magical plus is the bonus to the AC.

Shields

Use the shields given in the "Fighters of Thyatis" chapter; in the AD&D game, they get the AC value given for them in that chapter. Convert the cn encumbrance value to gp weight value.

Rules

For the combat effect of armor in these optional rules, use the rules given in the "Fighters of Thyatis" chapter.

Barding

For animal barding, use the "Fighters of Thyatis" rules for Armor Value, gp cost, and encumbrance value—substitute gp weight for cn encumbrance value.

Other Optional Rules

You can use any and all of the rest of the armor and damage rules from the "Fighters of Thyatis" section, especially the ones involving Crushing Blows, Magical Armor and Shields, Fighting Armored Monsters, and the effects of Magic Items and Magic Spells on this optional combat system.

Don't use the rules following the "Optional Fighting Rules" headline from the "Fighters of Thyatis" section. The AD&D game has its own equivalents for several of these.

DUNGEONS & DRAGONS® Character Record Sheet

CHARACTER INFORMATION:

Full Name: _____

Additional Names and Titles:

Race: _____ Age: _____

Height: _____ Weight: _____

Hair: _____ Eyes: _____

ADDITIONAL EQUIPMENT:

Item	Enc. (cn)	Where Kept
_____	_____	_____
_____	_____	_____
_____	_____	_____
_____	_____	_____
_____	_____	_____
_____	_____	_____
_____	_____	_____
_____	_____	_____
_____	_____	_____
_____	_____	_____
_____	_____	_____
_____	_____	_____
_____	_____	_____

TREASURE:

Carried:	At Home:	Other:
pp: _____	pp: _____	pp: _____
gp: _____	gp: _____	gp: _____
ep: _____	ep: _____	ep: _____
sp: _____	sp: _____	sp: _____
cp: _____	cp: _____	cp: _____
gems: _____	gems: _____	gems: _____
_____	_____	_____
_____	_____	_____

CHARACTERS KNOWN:

Character	Relationship/Notes
_____	_____
_____	_____
_____	_____
_____	_____
_____	_____
_____	_____
_____	_____
_____	_____
_____	_____
_____	_____
_____	_____
_____	_____
_____	_____
_____	_____
_____	_____
_____	_____
_____	_____
_____	_____
_____	_____
_____	_____
_____	_____
_____	_____
_____	_____
_____	_____
_____	_____
_____	_____
_____	_____
_____	_____
_____	_____
_____	_____

CHARACTER SKETCH, SYMBOL, OR COAT OF ARMS

(This form may be reproduced for personal use in playing DUNGEONS & DRAGONS® games.)

DUNGEONS & DRAGONS® Character Record Sheet

Character's Name: TRENTION LYNDSTORION Class: FORESTER
 Player's Name: (SAMPLE CHARACTER) Alignment: LAWFUL
 Dungeon Master: — Level: 9TH

ABILITIES:

17 Strength
16 Intelligence
12 Wisdom
14 Dexterity
9 Constitution
12 Charisma

Adjustments:

+2 Hit & Damage, Opening Doors
+2 Language(s)
+0 Saving Throws vs. Magic
+1 Missile Fire Hit rolls, -1 AC
+0 Hit Points/Level
+0 Reactions

EXPERIENCE:

Prime Requisite: S/I
 Adjustment to EXP: +10%

Experience Total:

400,000+

SAVING THROWS:

- Poison or Death Ray
- Magic Wand
- Turn to Stone or Paralysis
- Dragon Breath
- Spells or Magic Staff

COMBAT NOTES:

Armor Class: 0
 Hit Points: 32
 Movement Rate: 90'(30')
 Damage Taken:

Armor Value
(if used):

X

EQUIPMENT CARRIED:

Item	Enc. (cn)
<u>NORMAL SWORD +2(1-8+2)</u>	<u>60</u>
<u>DAGGE(NORMAL)(1-4)</u>	<u>10</u>
<u>LONGBOW</u>	<u>30</u>
<u>QUIVER + 20 ARROWS</u>	<u>—</u>
<u>BACKPACK</u>	<u>20</u>
<u>CHAINMAIL +2</u>	<u>400</u>
<u>SHIELD +1</u>	<u>100</u>
<u>LANKER (IN PACK)</u>	<u>30</u>
<u>ROPE, 50' (IN PACK)</u>	<u>50</u>
<u>TINDER BOX (IN PACK)</u>	<u>5</u>
Total Encumbrance (cn):	<u>705 CN</u>

LANGUAGES:

Common: THYAHAN
 Alignment: LAWFUL
ELF (VYALIN)
ALPHAHAN
ORCISH

SPECIAL SKILLS:

(Thief skills, Clerical turning, racial skills, etc.)
ELVISH DETECHOS ABILITY

GENERAL SKILLS:

Number of Skill Choices: 8

Skill	Ability	Roll
<u>ALERTNESS</u>	<u>D</u>	<u>14</u>
<u>TRACKING</u>	<u>I</u>	<u>16</u>
<u>SIGNALLING (ELF/FORESTER)</u>	<u>I</u>	<u>16</u>
<u>SURVIVAL (FOREST)</u>	<u>I</u>	<u>16</u>
<u>RIDING (HORSE)</u>	<u>D</u>	<u>14</u>
<u>RIDING (PEGASUS)</u>	<u>D</u>	<u>14</u>
<u>ANIMAL TRAINING (PEGASUS)</u>	<u>W</u>	<u>12</u>
<u>ANIMAL TRAINING (HORSE)</u>	<u>W</u>	<u>12</u>

HIT ROLLS: (DOES NOT INCLUDE BONUSES FROM S, D, WEAPONS)

Target AC:	9	8	7	6	5	4	3	2	1	0	-1	-2	-3	-4	-5
Hit Roll Needed:	6	7	8	9	10	11	12	13	14	15	16	17	18	19	20

DUNGEONS & DRAGONS® Character Record Sheet

Character's Name: _____ Class: _____
 Player's Name: _____ Alignment: _____
 Dungeon Master: _____ Level: _____

ABILITIES:

- ____ Strength
- ____ Intelligence
- ____ Wisdom
- ____ Dexterity
- ____ Constitution
- ____ Charisma

Adjustments:

- ____ Hit & Damage, Opening Doors
- ____ Language(s)
- ____ Saving Throws vs. Magic
- ____ Missile Fire Hit rolls, ____ AC
- ____ Hit Points/Level
- ____ Reactions

EXPERIENCE:

Prime Requisite: ____
 Adjustment to EXP: ____

Experience Total:

SAVING THROWS:

- Poison or Death Ray
- Magic Wand
- Turn to Stone or Paralysis
- Dragon Breath
- Spells or Magic Staff

COMBAT NOTES:

Armor Class: _____	<div style="border: 1px solid black; width: 40px; height: 40px; margin: 0 auto;"></div>	Armor Value (if used): _____
Hit Points: _____		
Movement Rate: _____		
Damage Taken: _____		

EQUIPMENT CARRIED:

Item	Enc. (cn)
_____	_____
_____	_____
_____	_____
_____	_____
_____	_____
_____	_____
_____	_____
_____	_____
_____	_____
_____	_____
_____	_____
_____	_____
_____	_____
_____	_____
Total Encumbrance (cn):	_____

LANGUAGES:

Common: _____
 Alignment: _____

SPECIAL SKILLS:

(Thief skills, Clerical turning, racial skills, etc.)

GENERAL SKILLS:

Number of Skill Choices: _____

Skill	Ability	Roll
_____	_____	_____
_____	_____	_____
_____	_____	_____
_____	_____	_____
_____	_____	_____
_____	_____	_____
_____	_____	_____
_____	_____	_____
_____	_____	_____
_____	_____	_____
_____	_____	_____
_____	_____	_____
_____	_____	_____
_____	_____	_____
_____	_____	_____
_____	_____	_____
_____	_____	_____

HIT ROLLS:

Target AC:	9	8	7	6	5	4	3	2	1	0	-1	-2	-3	-4	-5
Hit Roll Needed:															

DUNGEONS & DRAGONS® Character Record Sheet

CHARACTER INFORMATION:

Full Name: TRENTION LYCOSTORION

Additional Names and Titles:
ELF-FRIEND, MEMBER OF KNIGHTS OF THE AIR

Race: HUMAN/KERENDAN Age: 30

Height: 5'11" Weight: 165 lbs.

Hair: BROWN Eyes: BLUE

ADDITIONAL EQUIPMENT:

Item	Enc. (cn)	Where Kept
<u>SADDLE + BRIDLE</u>	<u>300</u>	<u>PEGASUS</u>
<u>SADDLEBAGS</u>	<u>100</u>	<u>PEGASUS</u>
<u>CHAIN BARDING</u>	<u>600</u>	<u>PEGASUS</u>
<u>TREN RAHETS X 2</u>	<u>140</u>	<u>PEGASUS</u>
<u>WATERSKIN X 6</u>	<u>30</u>	<u>PEGASUS</u>

CHARACTERS KNOWN:

Character	Relationship/Notes
<u>THEODORIUS KANHNO/MEIROS</u>	<u>HATE GAIN</u>
<u>ANAXIBIUS</u>	<u>CHILDHOOD FRIEND OTHER</u>

TREASURE:

Carried:	At Home:	Other:
PP: _____	PP: _____	PP: _____
gp: <u>100</u>	gp: <u>12,500</u>	gp: _____
ep: _____	ep: _____	ep: _____
sp: <u>100</u>	sp: <u>20,000</u>	sp: _____
cp: _____	cp: <u>5,250</u>	cp: _____
gems: _____	gems: _____	gems: _____

CHARACTER SKETCH, SYMBOL, OR COAT OF ARMS

DUNGEONS & DRAGONS® Spell Book Sheet

Character: _____

Player: _____

Spell Book for Spells Level: _____

Spell Name	Description In Brief:	Source of Spell:
------------	-----------------------	------------------

_____	_____	_____
_____	_____	_____
_____	_____	_____
_____	_____	_____
_____	_____	_____
_____	_____	_____
_____	_____	_____
_____	_____	_____
_____	_____	_____
_____	_____	_____
_____	_____	_____
_____	_____	_____
_____	_____	_____
_____	_____	_____
_____	_____	_____
_____	_____	_____
_____	_____	_____
_____	_____	_____
_____	_____	_____
_____	_____	_____
_____	_____	_____
_____	_____	_____

Spell Book for Spells Level: _____

Spell Name	Description In Brief:	Source of Spell:
------------	-----------------------	------------------

_____	_____	_____
_____	_____	_____
_____	_____	_____
_____	_____	_____
_____	_____	_____
_____	_____	_____
_____	_____	_____
_____	_____	_____
_____	_____	_____
_____	_____	_____
_____	_____	_____
_____	_____	_____
_____	_____	_____
_____	_____	_____
_____	_____	_____
_____	_____	_____
_____	_____	_____
_____	_____	_____
_____	_____	_____
_____	_____	_____
_____	_____	_____

(This form may be reproduced for personal use in playing DUNGEONS & DRAGONS® games.)

DUNGEONS & DRAGONS® Spell Book Sheet

Character: TRENTION LYCOSTORION

Player: _____

Spell Book for Spells Level: 4

Spell Book for Spells Level: 5

Spell Name	Description In Brief:	Source of Spell:
CHARM MONSTER	RANGE 120'; 3-19 & 3 HD	
DIMENSION DOOR	OR LEVS, OTHERWISE 1 MONSTER FORESTERS RANGE 10'; TARGET TRANSPORTED UP TO 360'; MAY SAVE SCROLL FROM DUNGEON	
GROWTH/PLANT	RANGE 120'; EFFECT 3000 SQ. FT., REVERSE OR SHRINK FORESTERS	
WALL OF FIRE	RANGE 60'; MAKES 1200 SQ. FT. STOPS 4 HD, OTHERS TAKE 1 DB FORESTERS	

Spell Name	Description In Brief:	Source of Spell:
HOLD MONSTER	RANGE 120'; LASTS 6 TURNS + LEVEL, 1-4 CREATURE FORESTERS	
WALL OF STONE	RANGE 60'; 1000 CUBIC FEET, 2 FT. THICK DEMETRIUS	

(This form may be reproduced for personal use in playing DUNGEONS & DRAGONS® games.)

DUNGEONS & DRAGONS[®] Magic Item Creation Sheet

Enchanter: _____ Level: _____ Int: _____

Chance for Success (when appropriate):
(Int _____ + Lvl _____) × 2 - (3 × Spell Levels _____) = _____ %

Miscellaneous Magic, Weapons, Armor

MISCELLANEOUS MAGIC ITEM
(OR ENCHANTMENTS ON WEAPONS, ARMOR)

Spell	Level	Notes
_____	_____	_____
_____	_____	_____
_____	_____	_____
_____	_____	_____

Initial Enchantment Cost: _____ gp

Cost of Charges/Permanency: _____ gp

Total Cost: _____ gp

Description/Notes: _____

WEAPON OR ARMOR

Initial Enchantment Cost: _____ gp

Weapon/Armor +/ -: _____

Total Cost: _____ gp

Description/Notes: _____

Large Constructions

Spells & Fittings	#	Spell Level	Total Levels	If Frame: × 3,000 gp	Cost in gp
_____	×	_____	= _____	_____	_____
_____	×	_____	= _____	_____	_____
_____	×	_____	= _____	_____	_____
_____	×	_____	= _____	_____	_____
_____	×	_____	= _____	_____	_____
_____	×	_____	= _____	_____	_____
_____	×	_____	= _____	_____	_____
_____	×	_____	= _____	_____	_____
_____	×	_____	= _____	_____	_____
_____	×	_____	= _____	_____	_____

Total Cost: _____

COSTS AND PROCEDURES IN BRIEF MISCELLANEOUS MAGIC ITEMS

Initial Enchantment Cost: Total Spell Level × 1,000 gp

Cost of Charges: (10% of Initial Enchantment Cost) × number of charges

Cost of Permanency: 5 × Initial Enchantment Cost

Total Cost: (Initial Enchantment Cost + Cost of Charges) or (Initial Enchantment Cost + Cost of Permanency)

Item with Charges is Non-Rechargeable: Reduce Total Cost by 20%

Items Usable Only a Certain Number of Times in one Time Period (affects Initial Enchantment Cost):

- Usable # times per hour: -20%
- Usable # times per day: -25%
- Usable # times per week: -30%
- Usable # times per month: -35%

Calculate as per 30 charges + # of charges usable per time period

WEAPONS AND ARMOR

Armor Initial Enchantment Cost: [Item Price (gp) × Encumbrance (cn)]/3

Weapon Initial Enchantment Cost: [Item Price (gp) × Encumbrance (cn)] × 5

Total Cost: Initial Enchantment Cost + Attack or Armor Bonus Cost (see below)

Minimum Possible Initial Enchantment Cost: 100 gp for weapons, 3,000 gp for armor

Plusses Against Special Foes: Each limited + 1 costs as + .5 toward Total Cost

ADDING OTHER MAGICAL EFFECTS

Calculate Cost as for creating new miscellaneous magical items; follow earlier rules for multiple spells

If weapon is vs. specific foe: -10% to spell effect cost if vs. monster class; additional -10% to cost if vs. specific species; additional -10% to cost if vs. specific named monster

Dagger counts as short sword for calculating Initial Enchantment Cost

CONSTRUCTIONS

Frame Enchantment: Total # of Spell Levels × 3,000 gp

Extra Item Enchantment Cost: Same as for creating Miscellaneous Magic items

DUNGEONS & DRAGONS[®] Magic Item Creation Sheet

Enchanter: TRENTION Level: 9 Int: 16

Chance for Success (when appropriate):
 (Int 16 + Lvl 9) × 2 - (3 × Spell Levels 2) = 44 %

Miscellaneous Magic, Weapons, Armor

MISCELLANEOUS MAGIC ITEM
 (OR ENCHANTMENTS ON WEAPONS, ARMOR)

Spell	Level	Notes
<u>DETECTS EVIL</u>	<u>2</u>	<u>SWORD DETECTS EVIL TO 20'</u>

Initial Enchantment Cost: 2,000 gp
 Cost of Charges/Permanency: 10,000 gp
 Total Cost: 12,000 gp
 Description/Notes: DETECT EVIL ABILITY FOR SWORD (BELOW)

WEAPON OR ARMOR

Initial Enchantment Cost: 3000 gp COST 10gp × 600m × 5
 Weapon/Armor + / - : +2 (x2)
 Total Cost: 6,000 gp
 Description/Notes: FIND ITEM CASH A TOTAL OF 18,000 GP; IT IS A NORMAL SWORD + 2, DETECTS EVIL

Large Constructions

Spells & Fittings	#	Spell Level	Total Levels	If Frame: × 3,000 gp	Cost in gp
	×		=		
	×		=		
	×		=		
	×		=		
	×		=		
	×		=		
	×		=		
	×		=		
	×		=		
	×		=		
	×		=		
	×		=		
	×		=		
Total Cost:					

COSTS AND PROCEDURES IN BRIEF MISCELLANEOUS MAGIC ITEMS

Initial Enchantment Cost: Total Spell Level × 1,000 gp
 Cost of Charges: (10% of Initial Enchantment Cost) × number of charges
 Cost of Permanency: 5 × Initial Enchantment Cost
 Total Cost: (Initial Enchantment Cost + Cost of Charges) or (Initial Enchantment Cost + Cost of Permanency)

Item with Charges is Non-Rechargeable: Reduce Total Cost by 20%

Items Usable Only a Certain Number of Times in one Time Period (affects Initial Enchantment Cost):
 Usable # times per hour: -20%
 Usable # times per day: -25%
 Usable # times per week: -30%
 Usable # times per month: -35%
 Calculate as per 30 charges + # of charges usable per time period

WEAPONS AND ARMOR

Armor Initial Enchantment Cost: [Item Price (gp) × Encumbrance (cn)]/3
 Weapon Initial Enchantment Cost: [Item Price (gp) × Encumbrance (cn)] × 5
 Total Cost: Initial Enchantment Cost + Attack or Armor Bonus Cost (see below)
 Minimum Possible Initial Enchantment Cost: 100 gp for weapons, 3,000 gp for armor

Plusses Against Special Foes: Each limited + 1 costs as + .5 toward Total Cost

ADDING OTHER MAGICAL EFFECTS

Calculate Cost as for creating new miscellaneous magical items; follow earlier rules for multiple spells
 If weapon is vs. specific foe: -10% to spell effect cost if vs. monster class; additional -10% to cost if vs. specific species; additional -10% to cost if vs. specific named monster

Dagger counts as short sword for calculating Initial Enchantment Cost

CONSTRUCTIONS

Frame Enchantment: Total # of Spell Levels × 3,000 gp
 Extra Item Enchantment Cost: Same as for creating Miscellaneous Magic items

FLYING MONSTER RECORD SHEET

Monster Name: _____
 Monster Species: _____

Rider Name: _____
 Riding Roll: _____

STANDARD MONSTER INFORMATION:

Armor Class: _____
 Hit Dice: _____
 Move: _____' (_____)'
 Flying: _____' (_____)'
 Attacks: _____
 Damage: _____
 Morale: _____
 Alignment: _____

FLYING MONSTER CHART INFORMATION:

Air-Speed (ft/round): _____ (_____)'
 Maneuvering Factor (MF): _____
 Takeoff (a, b, c): _____
 Cost (Young, in gp): _____
 Cost (Upkeep/Month): _____
 Cost/Encumbrance Multiplier
 (Gear and Armor): × _____
 Carry (cn encumbrance): _____

COMBAT INFORMATION:

Monster Age: _____
 Current HD: _____
 Monster hp: _____
 Monster AC —
 unmodified: _____
 w/Barding: _____

EFFECTS FROM DAMAGE:

Unhurt: No effect
 Lost 25% hp: No 2-/3-maneuver climbs
 Lost 50% hp: No climbs
 Lost 75% hp: Must 1-maneuver dive at least
 Lost 90% hp: Must 2-maneuver dive at least
 Lost All hp: Dead — plummets

EQUIPMENT

Rider and Personal Equipment

ENCUMBRANCE

2,000 cn

	_____ cn
	_____ cn
	_____ cn
	_____ cn
	_____ cn
	_____ cn
	_____ cn
	_____ cn
	_____ cn
	_____ cn
	_____ cn
	_____ cn

AERIAL MOVEMENT RECORD SHEET

Starting Altitude

Movement Spent

Dive/Climb Rate

FLYING MONSTER RECORD SHEET

Monster Name: HIGH-DIVER
 Monster Species: PEGASUS

Rider Name: TRENTION LYCOSTORION
 Riding Roll: 14

STANDARD MONSTER INFORMATION:

Armor Class: 6
 Hit Dice: 2+2
 Move: 240' (80')
 Flying: 480' (160')
 Attacks: 2 HOoves
 Damage: 1-6/1-6
 Morale: 8
 Alignment: LAWFUL

FLYING MONSTER CHART INFORMATION:

Air-Speed (ft/round): (160')
 Maneuvering Factor (MF): 3
 Takeoff (a, b, c): 6
 Cost (Young, in gp): 125
 Cost (Upkeep/Month): 20
 Cost/Encumbrance Multiplier (Gear and Armor): x 1
 Carry (cn encumbrance): 3,300

COMBAT INFORMATION:

Monster Age: 3 YRS.
 Current HD: 2+2
 Monster hp: 10
 Monster AC —
 unmodified: 6
 w/Barding: 4

EFFECTS FROM DAMAGE:

Unhurt: No effect
 Lost 25% hp: No 2-/3-manuever climbs
 Lost 50% hp: No climbs
 Lost 75% hp: Must 1-manuever dive at least
 Lost 90% hp: Must 2-manuever dive at least
 Lost All hp: Dead — plummets

EQUIPMENT

Rider and Personal Equipment

SADDLE + BRIDLE
SADDLEBAGS
CHAIN BARDING
IRON RAHES x2 (SADDLEBAGS)
WATERSKIN x6 (SADDLEBAGS)

ENCUMBRANCE

	2,000 cn
<u>300</u>	<u>300</u> cn
<u>100</u>	<u>100</u> cn
<u>600</u>	<u>600</u> cn
<u>140</u>	<u>140</u> cn
<u>30</u>	<u>30</u> cn
<u>TOTAL</u>	<u>3,170</u> cn

AERIAL MOVEMENT RECORD SHEET

Starting Altitude

Movement Spent

Dive/Climb Rate

THE SHARK

TOP VIEW

SIDE VIEW (PORTSIDE)

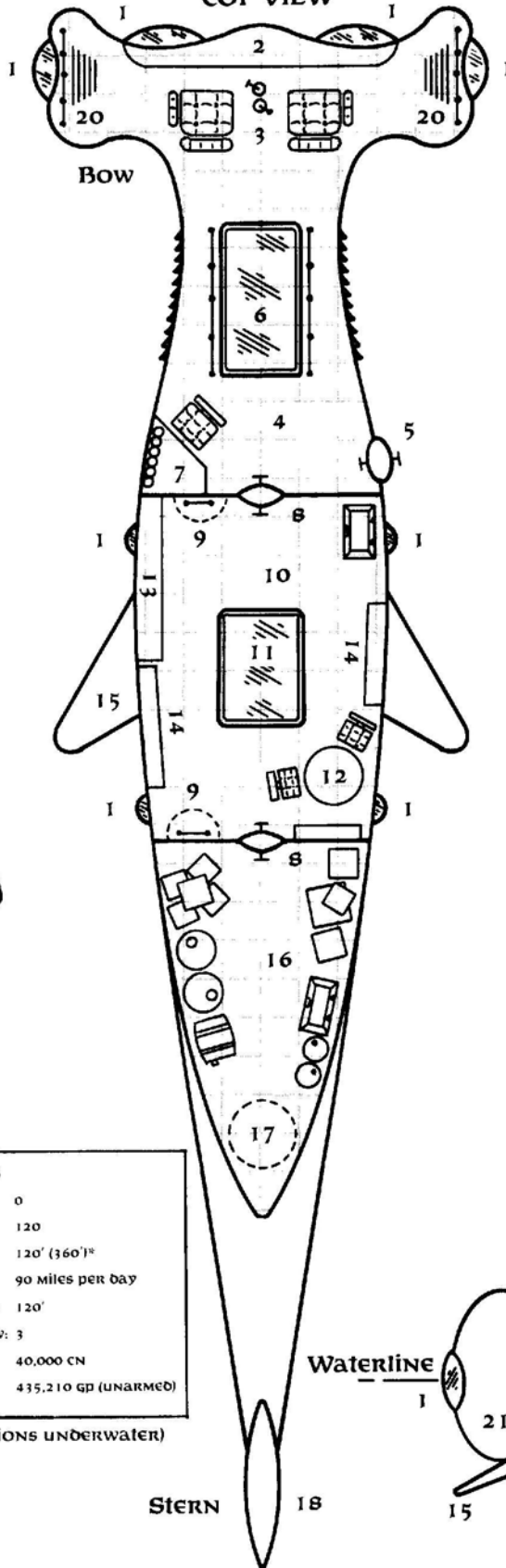

1. Portholes (shutters in the front)
2. CONTROL panel
3. COMMANDER and pilot seats
4. OBSERVATION deck
5. EXTERIOR hatch (usable ONLY when fully surfaced)
6. BOTTOM window and hand railing
7. MAP table and SCROLL casings
8. WOODEN hatches
9. TOPSIDE ladders (usable when partially surfaced)
10. LABORATORY and living quarters
11. TOPSIDE window
12. TABLE and chairs
13. WORKBENCH
14. COLLAPSIBLE bunks
15. STABILIZING fin
16. CARGO hold
17. REAR observer cupola
18. TAIL fin
19. DORSAL fin
20. STEPS up and hand railing
21. MAGIC Missile port (optional)

Scale: ONE square equals 2 feet

Statistics

ARMOR Class: 0
 Hull Points: 120
 Battle Speed: 120' (360')*
 Cruise Speed: 90 miles per day
 TURNING Rad.: 120'
 MINIMUM CREW: 3
 Cargo Hold: 40,000 CN
 Cost: 435,210 gp (UNARMED)

(* all directions UNDERWATER)

Waterline

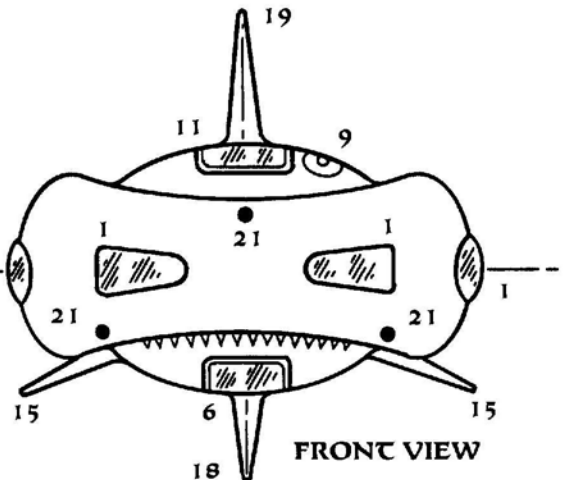

FRONT VIEW

DUNGEONS & DRAGONS®
GAZETTEER

BOOK ONE:
The Dungeon Master's Sourcebook
by Aaron Allston

Within these 128 pages is the definitive information you, as DUNGEON MASTER, need to run a campaign in the great empires of Thyatis and Alphatia.

In addition to complete geographical, social, historical, and economic background material on both lands, you will also find several forms tailored for a Thyatian/Alphatian campaign: a character record sheet (double-sided!), a spell book sheet, a magic item creation sheet, and a flying mount record sheet. These are meant to be photocopied for your own use.

Plus, you will find complete rules on using flying monsters as mounts—rules for everything from gold dragons to pegasi to flying carpets. Yes, flying carpets. Why? Read the rules.

And, there are also complete rules for building magical structures: flying castles, air ships, submersibles.

This book, in combination with the two Player's Guides, give you as the DM all the background you need to create a living campaign in the oldest civilizations in the Known World.



TSR, Inc.
PRODUCTS OF YOUR IMAGINATION™

DUNGEONS & DRAGONS®

GAZETTEER



BOOK TWO:
Player's Guide to Thyatis
by AARON ALLSTON

GAZETTEER

An Official DUNGEONS & DRAGONS® Game Supplement

DAWN OF THE EMPERORS

by Aaron Allston

Table of Contents

BOOK TWO: THE PLAYERS' GUIDE TO THYATIS

Introduction	2	Entertainments	13
History of Thyatis	3	Government	14
In the Time Before History	3	Classes of Society	15
The Days of Reaving	3	Economy	16
The Coming of the Alphasians	3	Law and Punishment	16
The Struggle for Freedom	3	The Calendar	17
The Struggle—The Other Story	3	Character Creation	18
The Empire's Early Days	4	Races and Character Classes	18
The Bright Age	4	The Forester Class	18
Years of Reverses	4	The Rake	19
The Tenth Century	4	Female Characters	19
Overview of Thyatis	6	Races	19
Mainland Thyatis	6	Family	20
Conquered Territories	7	Social Standing	20
Thyatian Society and Politics	9	Names	20
National Character	9	Languages	20
Age	10	General Skills	21
Running Away from Home	11	Skills and the DM	24
Marriage Customs	11	The Fighters of Thyatis	25
Dress	11	The Fighting Orders	25
Weapons and Armor	12	The Flying Orders	26
Thyatians and the Immortals	12	Optional Armor and Damage Rules	29
Food and Drink	13	Optional Fighting Rules	31

Credits:

Design: Aaron Allston
Additional Material: Mark Bennett
Editing: Karen S. Boomgarden
Product Manager: Bruce Heard
Cover Artist: Clyde Caldwell
Interior Artist: Stephen Fabian
Cartography: Dave Sutherland

©1989 TSR, Inc. All Rights Reserved. Printed in U.S.A.

DUNGEONS & DRAGONS, D&D, ADVANCED DUNGEONS & DRAGONS, AD&D, and WORLD OF GREYHAWK are registered trademarks owned by TSR, Inc.
PRODUCTS OF YOUR IMAGINATION, BATTLESYSTEM, FORGOTTEN REALMS, and the TSR logo are trademarks owned by TSR, Inc.

Distributed to the book trade in the United States by Random House, Inc., and in Canada by Random House of Canada, Ltd. Distributed to the toy and hobby trade by regional distributors. Distributed in the United Kingdom by TSR Ltd.

This module is protected under the copyright laws of the United States of America. Any reproduction or other unauthorized use of the written material or artwork herein is prohibited without the express written permission of TSR, Inc.
1037XXX1902

TSR, Inc.
POB 756
Lake Geneva,
WI 53147 USA



TSR Ltd.
120 Church End, Cherry Hinton
Cambridge CB1 3LB
England

Introduction

The young man with the unruly mop-top of red hair stood at the ship's rail. Land had been sighted, a few minutes ago, the hilly southern tip of mainland Thyatis; but the deepening twilight was making the promontory increasingly difficult to see. Landfall tomorrow, they promised. Thyatis City within two days. The redhead grimaced.

Another man stepped to the rail—a black man, a Pearl Islander. He wore Thyatian dress, his thigh-length tunic and trousers sky-blue embroidered in white, his belt and boots shining black, his cloak black without and royal blue within. His hair was greying, and age had a firm hold on him, but he carried himself well; he walked gracefully, spoke clearly. "I see you're a Hinterlander," the islander said, conversationally.

The redhead grunted. With his screaming red hair, his broad and elaborately-maintained mustachios, tunic and trousers mismatched in color, and buskin footwear, he could hardly be anything else. "Name's Dylan," he said disinterestedly, still watching distant Thyatis fade into the darkness.

"Tanarobi Nuar, at your service," the islander replied. "I am with the Pearl Island consulate in Thyatis City." He followed Dylan's gaze ahead, tried to read what lay in the younger man's face. "Is this your first time in Thyatis, citizen?"

Dylan nodded. "First time anywhere, but the Hinterlands."

"Would you care for me to tell you of Thyatis? I know the land well. I've traveled to all the reaches of the Empire, and beyond to foreign capitals as well."

Dylan gave the islander a close look. Had the man guessed at Dylan's state of nervousness, at the trepidation he felt at leaving his homeland to seek fame and fortune in the heart of the Empire? Tanarobi's face didn't reveal any such prescience . . .

"Yes, citizen, I would appreciate that," Dylan said heavily. "What will I find here? Are the Thyatians here so different from those who rule my land? Where is there money and honor to be earned?"

What Everyone Knows About Thyatis

Observations of a Pearl Islander

"Slow your pace, young Dylan. I'll answer what I can . . . at a more comfortable rate."

"I do not know how the Thyatian military men governing your land act. Since the Hinterlands were conquered only recently, and

the Thyatian soldiers there must be spending much of their time putting down rebellions—don't bridle so—I can guess that they're harsh and demanding in your own land.

"You'll find them a bit different on the mainland. You'll be a novelty, and they'll press you for songs and stories of your native land. You might earn a good living as a bard—you don't sing, do you? No? Pity. You may find that your style of dress sets new fashions here, as unfortunate as that might be . . . the Thyatians love new styles of clothing and jewelry. I can only imagine that your vast mustache will be eagerly imitated very soon.

"Oh, but make no mistake; the Thyatians are warlike here, on their native shores, as anywhere. They love to fight, and to watch fights. Have you thought about trying the gladiatorial life? You'll make a lot of money, but only for a short time . . . unless you're a very, very good fighter. But, come to think of it, that's a reputation you Hinterlanders have, isn't it?"

"They have three great cities. Thyatis City is the most magnificent of them, the very axis of the Empire, into which the riches of foreign lands flow in a steady stream. Westward is Kerendas, where the greatest horsemen are trained, and eastward is Tel Akbir, a city which still has the colors and flavors of the Alasiyans who built it centuries ago. Lesser cities it has too, such as once-proud Hattias, Port Lucinius where the navy has its heart, Julinius on the river, Foreston where the elves visit, and sheltered Biazzan.

"What? Yes, I said elves. There are many elves in Thyatis. I told you the Thyatians liked exotic peoples. You'll find elves there, native-born and foreign, and dwarven mercenaries and craftsmen, and halfling sailors from the far west, and more besides. Don't be surprised.

"And don't be offended, either, by peoples' actions and customs which you find repellent or grotesque. First, you must gauge what the person intends with his actions . . . and if his intent is friendly, or at least neutral, try to take no offense. You may find yourself performing one of your own peoples' customs and realize that you've come within a hair's breadth of offending some important person—and only this fashion of accepting foreign customs until their intent is learned will have saved you from death, or worse than death.

"What? Employment? I take it you're a warrior? You might try the military; if you're smart and efficient—they love efficiency—you could go far. There's the arena, as I mentioned before; a certain few gladiators become great and rich and retire young. And there are

always mad ventures to find: Treasure-hunting, monster-seeking, exploring new lands . . . I'm no warrior, and I've seen plenty of scrapes just doing ordinary diplomatic service with the damned Alphatians.

"It's full dark, now, and time for this old man to retire for the night. And don't fret about the Thyatians. Ever since your land fell to them . . . you have been a Thyatian. I'll tell you more on the morrow. Good night, citizen."

Observations of a Dawn Islander

Scarce had Tanarobi left before another stepped to Dylan's side, a dark-skinned, copper-haired woman in a gown of forest green. With her fan, she gestured after the departing Pearl Islander. "Forgive my boldness, Hinterlander, but I am offended by that man's cheerful acceptance of the conquest of your land . . . and his, and mine.

"I am Lyarette from Helskir, on the Isle of Dawn. It's the most northerly city on the island, and has been hotly contested for by both Thyatis and Alphatia for a thousand years. We of Helskir have seen the Thyatians and Alphatians at their best and worst . . . and I can tell you, I prefer Alphatians at their worst to Thyatians at their best.

"Why? Read between the lines of what that Pearl Islander told you! The Thyatians are—" her voice lowered so that it would not carry to the ship's Thyatian crew—"all liars and cheats who delight in murder and humiliation.

"The Islander said that the Thyatians have great cities. It's true, if you count greatness by the press of numbers. They keep most of their population in vast tenements, filthy in the extreme. If you don't have enough money to purchase a great villa, you live in the tenements with sewage in the streets and a great wall of noise pressing upon you all the day long.

"The Islander said nothing to you about the treachery of the Thyatians. These are the most treacherous peoples in all the world! Let me give you a rule to live by: A Thyatian's honor depends on advantage. As long as it's still to his advantage to keep his word, he will do so. As soon as it is no longer to his benefit, his word, his contract, his oath become meaningless. What you must do is keep your eyes open and, when you see that circumstances have changed and it's no longer to the Thyatians' best interest to keep their word, prepare yourself for betrayal."

She fanned herself and gave Dylan a mocking smile. "Welcome to Thyatis," said she, and moved on.

History of Thyatis



The following day, as the ship cruised north along the west coast of the Island of Hattias, Tanarobi again told Dylan of the Thyatians.

"The strange customs of these peoples are not so odd when you know how they came to be. I will tell you of their past, as their scholars teach it to their young. It is a tale long in the telling . . ."

"In their earliest days, the Thyatians lived far to the south . . ."

In the Time Before History

Long before the Thyatians learned to write, they lived on the southern continent. They weren't called Thyatians then; each tribe had its own name. They were so fierce and warlike that it is said that they did not laugh at Death, they laughed *with* him.

In those times, the three greatest tribes were led by three brother-kings named Thyatis, Kerendas, and Hattias. Sailors of their day had discovered that a beautiful land lay to the north and north-east, and so the kings decided to forge themselves new kingdoms there. They built ships and sailed across the unfriendly body of water which separated the two lands. The crossing was long and dangerous, and great storms killed many tribesmen, so the waters were named the "Sea of Dread" by those who survived.

The three tribes settled these lands and built cities named after their kings: Thyatis, Kerendas, and Hattias.

The Days of Reaving

The tribes sailed everywhere, sacking cities and terrorizing men of all nations, except one. These unafraid men were the Alphatians, cunning folk who lived beyond the Isle of Dawn, in cities built by magic. They saw how powerful the Thyatians were and declared that they must add these fighters to their empire, so that they could subjugate the world.

The Coming of the Alphatians

In the year of BC 192, the Alphatians came to conquer. They sent pitiful navies and armies, but these were slaughtered to a man. They sent hordes of monsters; these were slaughtered to the last cub. Then they sent a legion of magicians, wielding powers the Thyatians couldn't withstand, and the Thyatians were at last humbled.

The conquerors tried to turn the Thyatians into Alphatians. They taught the tribesmen letters, arts, music, and even magic. The Thyatians learned all this, then discarded it and invented their own. The Thyatians learned everything the Alphatians had to teach, and improved on it, seething within their restraints.

The Struggle for Freedom

A little more than a thousand years ago, in BC 2, the Thyatians decided that the time was ripe for rebellion.

One Thyatian had become a mighty wizard in the Alphatian fashion; he was Lucinius Trentzenbium. His strongest ally was Thyatian general Zendrolion Tatriokanitas. Between them, they made a plan for Thyatian freedom. Lucinius attacked and defeated each Alphatian wizard Thyatis, killing all, and proclaimed himself King Lucinius I of Thyatis. In the war that followed, Lucinius and General Zendrolion beat every wave of Alphatian attackers, and stirred the other nations ruled by the Alphatians into revolt. Eventually, the Alphatians, drained of resources, could no longer fight on all fronts and gave up the attack. The Alphatian emperor, Alphas VI, sued for peace, and on the Isle of Dawn, a treaty was signed between Lucinius, Alphas, and the kings of the Pearl Islands and Ochalea.

But Zendrolion discovered that Lucinius had been driven mad by the magics he had learned. Lucinius now planned to rule Thyatis as cruelly as the Alphatians had, helped by the kings of the Pearl Islands and Ochalea. Back in Thyatis City, Zendrolion challenged his friend to a duel and killed Lucinius and those allied kings. Zendrolion took the heavy crown of King of Thyatis and Emperor of the Empire, ruling also the Pearl Islands and Ochalea. He raised monuments to his friend Lucinius and named cities for the first king.

The Struggle— The Other Story

That is the tale as it is taught in Thyatis. Scholars, and historians of the Pearl Islanders, Ochaleans, and others tell it a bit differently. According to their records, Lucinius and Zendrolion assassinated all the Alphatian wizards

History of Thyatis

in Thyatis, and Lucinius duelled only one fairly, in a public display of Thyatian superiority.

Thyatis did war with Alphatia, and the other nations did rebel and fought the Alphatians on all sides. The war continued until all nations were exhausted, and peace was arranged. Thyatis and Alphatia did sign a treaty, and then the kings of the Pearl Islands and Ochalea returned to Thyatis for more treaty-writing. But ambitious Zendrolion murdered all three and made up the story of Lucinius' madness.

The Empire's Early Days

Regardless, in what is now Year 0 of the Thyatian calendar, Zendrolion was crowned Zendrolion I Tatriokanitas, Emperor of Thyatis. He quickly moved his military in to conquer the Pearl Islands and Ochalea; those nations, exhausted by the war with Alphatia, surrendered.

But the Thyatians discovered that, in the eyes of their new subjects, they had merely replaced the Alphatians in the role of hated oppressors. Thyatian conquests everywhere began fierce struggles for independence. Zendrolion's empire looked as if it would soon be gone; and upon his death (by natural causes) in AC 20, it seemed that the Empire of Thyatis would soon be no more.

But Zendrolion's widow Valentia was more forceful and clever than anyone had thought. She seized control and undertook emergency measures. She brought the children of the noble houses of all the subject lands to Thyatis, ostensibly to teach them Thyatian ways, but also as a hostage-taking tactic which stalled her enemies.

Then, asking the advice of her wisest counselors and noble hostages, she wrote the Citizens' Proclamation, the cornerstone of Thyatian law, which set out the three classes of Thyatian society (Noble, Citizen, Slave), and established that all free Thyatians, even those of conquered lands, were Thyatian Citizens equal in rank and rights to Citizens of Thyatis City herself.

She established a representative body of government, the Senate, with speakers from all over the Empire. The Senate started with little power, but conveyed the illusion that each part of the Empire had a voice in its own rule.

She restructured the Empire's judicial system, mandating a sentence of death for any-

one who bribed a judge or senator, and for any judge or senator who took a bribe, leaving the citizens with the impression that what was fair for one was fair for all in the Empire.

These tactics slowed the movements of rebellion and allowed the Empress to hold the Empire together. When at the end of a long and fruitful life she died, she was much respected, and is now remembered as Valentia the Justiciar.

The Bright Age

In the centuries after Valentia, the Empire expanded and worked to make reality of Valentia's promises. The Senate, through pressure and sometimes blackmail and murder, gained the right to be the sole body which wrote laws for the Empire. Thyatian forces entered Ylaruam and took several Alasiyan cities, securing Thyatis' borders to the north. Arts and learning flourished; cultures mixed in Thyatis City; the Empire remained secure.

Far-sighted Emperors made pacts of peace with the Vyalia elves of the western Dymrak Forest; the elves began teaching their forest spells to selected men and women called Foresters, who learned both to fight and wield magic in the fashion of the elves.

It was obvious that Thyatis would never be able to match the Alphatians in numbers of magic-users . . . but, unlike the Alphatians, the Thyatian emperors supported clerical orders, that Thyatis might be strong in clerical magic.

Hattians, the most grim of the Thyatian peoples, did not like the direction the Empire was taking. To their way of thinking, conquered peoples were for enslaving, and races were not for mixing. The Empire was doomed unless it was made to follow Hattian ideals; the Hattians decided to strike.

In AC 313, the Hattians rebelled, launching an army toward Thyatis. But Emperor Alexian II withstood their siege, then scattered them with his late-arriving Kerendan cavalymen. Hattias was occupied and its walls torn down as a sign that it might never again pretend independence of Thyatis.

As Thyatis continued its move into Ylari lands, the northward-moving Thyatians on the Alasiyan coastline ran into the southward-moving colonies of Alphatians; this began centuries of colonial warfare in the Alasiyan lands.

Years of Reverses

With northern expansion stalled by the Alphatians, in the sixth century AC the Thyatians began moving west. They bypassed the Minrothad islands and gloomy Traladara to take the pretty Ierendi islands. Initially, they established only prison colonies on these islands, which were already inhabited by half-lings. But later, as the Alasiyan conflicts with Alphatia heated up, they seized all these islands and the half-lings' lucrative shipbuilding industry there.

This didn't last. In AC 600, the prison colonies rebelled and drove out the Thyatians. Over the next 40 years, the Thyatians tried occasionally to recapture the islands, but resistance was stiff . . . and the Alphatians were the more pressing matter.

In the eighth century, the Alasiyan war became fiercer. Whole colonies were depopulated by the war; resources were strained. The Thyatians made one last attempt at grabbing the Ierendi chain, but the reconnoitering fleet was ambushed and massacred by the wily Ierendians, so that plan was abandoned.

The Alphatians in Ylaruam began pushing the Thyatians out. Whole colonies were destroyed. Some Thyatians struck out for the Flaemish territories to the far northwest; others came, disheartened, to mainland Thyatis.

In the early ninth century, an Alasiyan chieftain, Sulciman Al-Kalim, united the tribes against both empires and drove them out with religious fervor. Thyatis held onto Tel Akbir and its small peninsula . . . but Ylaruam was lost to Thyatis. Ironically, by throwing the Thyatians back south and the Alphatians back east, the forces of Al-Kalim also ended that 300-year-long war with Alphatia.

The Tenth Century

Around the Year 900, Emperor Gabrionus IV began a new and glorious period of Thyatian expansion. He sent troops to Traladara, conquered that dark land, and built a new capital, Specularum, on the site of its chief trading village. He expanded Thyatian territories on the Isle of Dawn, then built Oceansend in Norwold.

His son, Gabrionus V, who took the throne in AC 913, was a more scholarly sort who promoted the arts and goodwill between men but let the military slip into decline. The cunning Alphatians, of course, took much notice of this.

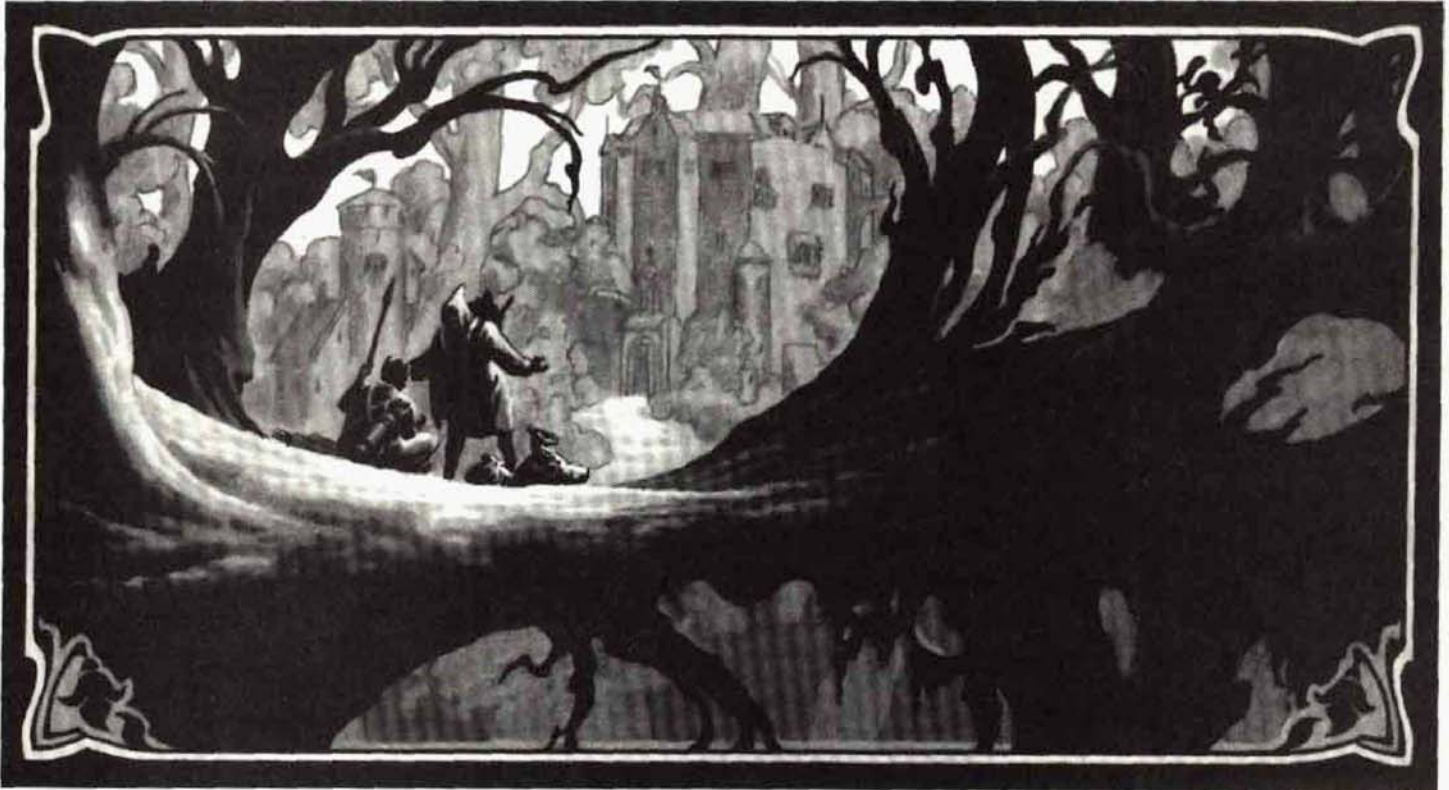

In 959, when the Thyatian navy was seriously understrength and Gabrionus V was an old man, the Alphatians, under Emperor Tyllion IV, attacked. They overran Newkirk and West Portage on the Isle of Dawn and prepared to assault the Thyatian mainland. That assault came the next spring, and the Thyatians were not able to stop it.

The siege of Thyatis City was short and cruel. The Alphatians, with their magics, battered down the great city gates and drove like a spike to the palace, where they slew Gabrionus V and proclaimed their victory.

At the time, the most beloved man in Thyatis City was a gladiator, an Oceansend-born Citizen called Thincol the Brave. As the Alphatians began their looting and destruction of Thyatis City, Thincol organized the city's surviving gladiators, mercenaries, knightly orders and army into a massive counterattack. It was a wild, chaotic assault, so unlike the Thyatians' usual orderly plans that the Alphatian forces couldn't deal with it. The Alphatian forces were smashed and pushed back out of the city.

Thincol, ambitious and clever, had rescued Gabrionus' daughter Gabriela during the palace assault. He convinced her that the Empire now needed a strong, harsh man

(such as himself) to build Thyatis back to glory. Convinced by the combination of his popularity, looks, ambition, ability, and rescue of her, she consented to marry him, securing his claim on the throne. He became Thincol I Torion, Emperor of Thyatis.

While this was occurring, Oceansend declared itself independent of Thyatis; already the Alphatian assault on Thyatis was causing more harm to the Empire. It took two years for Thincol to reclaim the lost Isle of Dawn cities. Eight years later, Stefan Karamaikos III of Machetos offered the Emperor his rich duchy in exchange for clear title to Traladara to the west; Thincol agreed, and used those ducal lands and funds to finish the rebuilding of his military.

Ten years ago, AC 990, Thincol turned his eyes on the Hinterlands, on the southern continent. Hinterlanders, burly brutes with flaming red and yellow hair, occupied those lands in numberless tribes. Thincol admired these peoples and their lands, and decided to take them. For the ten years, his legions have taken territory after territory, tribe after tribe, and the process will not stop until all the Hinterland barbarians are Thyatian citizens . . . or manage to throw the Thyatians out.

In these years, too, the Thyatians have had squabbles with the Alphatians in Norwold, on the Isle of Dawn, and in the eastern searoutes. But there has been no major war with Alphatia for nearly forty years . . . and many believe that it's about time for a new one.

"That is," Tanarobi continued, "the tale of the Thyatian Empire, in its brief form. Scholars can tell you much more of it . . . but I think you know enough to see why the Thyatians are as they are. Now, let's turn to the land itself, and its peoples . . ."

Overview of Thyatis

"Tomorrow we dock at Thyatis City," Tanarobi mused. "There you will learn quickly of the Empire and her peoples. Perhaps you would like to know more of the Empire herself, her great cities and diverse inhabitants?"

Mainland Thyatis

On the fold-up sheet is a map of mainland Thyatis. Refer to it as you read the description of this area.

The nation of Thyatis is made up of the southeast corner of the western continent and several nearby islands. North are the Altan Tepes mountains, which protect Thyatis from desert winds and raids by the Ylari warriors. West is the thick Dymrak Forest, haven of elves and goblins. South and east is the sea—a shield from foreign ground-troops but a road for Thyatian vessels.

Thyatis is bordered to the north by the Emirates of Ylaruam, which conducts trade with Thyatis, and permits Thyatian trade caravans to pass through to the Northern Reaches, Darokin, Rockhome, and the Ethengar Khanates. Ylaruam and Thyatis exist in an uneasy peace.

West of Thyatis is the Grand Duchy of Karameikos, an independent nation. The ruling class there is largely Thyatian, and its Grand Duke, Stefan Karameikos, is an old friend of Thincol I, so relations between the two nations are cordial. Stefan Karameikos knows that the more wealthy he makes his lands, the more the Thyatians will covet it, so much of the Karameikos' increasing wealth goes into his military.

West of the Island of Hattias, the sea belongs to the Minrothad Guilds.

Mainland Thyatis is very temperate; temperatures in Thyatis City range from 40 to 50 (Fahrenheit) in winter, 45 to 55 in spring, 60 to 70 in summer, and 50 to 60 in autumn.

Kerendan Plains

The western region of mainland Thyatis is called the Kerendan Plains. This is the flattest, richest land in Thyatis. Here are the best farmlands and pasturage, well-watered by runoff from the Altan Tepes mountains. Many caravans pass through, bound for Thyatis City and beyond.

This is the best horse breeding country in Thyatis. Kerendan horses are prized all over the continent, and Thyatian and Ylari horsebreeders keep up a fierce competition as they try to breed the world's most wondrous steeds. These plains are also the seat of Thy-

atis' cavalry. The city of Kerendas is home to the great Thyatian cavalry officers' training school.

This area has three communities of note:

Kerendas is the area's largest city, a thriving seaport and trade city with a long and distinguished military tradition. It is thought to be less decadent than the imperial capital, and Kerendans pride themselves on being stronger, faster, and less dissipated than citizens of Thyatis City.

Foreston is a medium-sized town built at the verge of the Dymrak Forest. This town, a human community with a large number of elves and halflings, is the seat of the Foresters, the order of magic-using human fighters.

Greenheight, built within the Dymrak Forest, is a town of Vyalia Elves and the sister town of Foreston. It is one of two predominantly demihuman towns to be found in mainland Thyatis.

Central Thyatis

Central Thyatis is also a rich farmland. It is not quite as rich as the Kerendas area, nor as flat, but it is more admirably situated to rule this empire. This area is also notable for its chief waterways, the Mesonion River and the saltwater Vanya's Girdle. This region has many towns and villages, and one great metropolis.

Thyatis City is the center of the Empire, its greatest city, most powerful port and trade center, seat of its navy and trading fleet. The city has been constructed with soaring stone walls, broad streets of concrete, huge public works and buildings, lavish villas and mansions. There are also huge tenement areas, with city block after block of three- and four-story tenement dwellings. Thyatians don't use the name "Thyatis City"—the city, to them, is Thyatis, and the nation is Thyatis because it is an extension of the city.

Port Lucinius is east of Thyatis City, at a broad point of Vanya's Girdle. It is a military port where the navy is trained. It is also charged with the defense of Thyatis City from naval invaders from the east; the seafarers here take that very seriously, and call themselves the "Shield of the East." There is a civilian town by the base; it features many entertainments for off-duty naval men and women.

Julinius is west of Thyatis City, on the western terminus of Vanya's Girdle. It is much like Port Lucinius, with a protective naval station and surrounding community, but is smaller than the other defensive port.

Island of Hattias

The Island of Hattias is separated from the mainland by Vanya's Girdle. The north end of the Island is green and hilly, good grazing land for sheep and goats. There are many vineyards on the Island; the Island supplies much of the mainland's wines. Farther south, the Island graduates to rocky hills with patches of deep forest. The hillsmen are chiefly sheepherders.

The Island has many villages, chiefly on the sea-coast, and one city.

Hattias, once equal with Thyatis and Kerendas, rebelled against Thyatis centuries ago and the city was crushed; ever since, the Hattians have resented other Thyatians.

Hattians speak a distinct dialect of the language and have different attitudes on many subjects. They are reluctant to mix with other races, and seem cold and arrogant to those outside their communities. They make the best footmen in the Thyatian armies.

Peninsula of Tel Akbir

This region was originally settled by Alasiyans of Ylaruam. The region has adequate farming lands, good grazing for sheep, and excellent fishing waters. In the early days of the Empire, the Thyatians captured Tel Akbir and began colonizing up the coast. Centuries later, though driven out of Ylaruam, they held onto the peninsula of Tel Akbir, and it remains Thyatian today.

The peninsula has one large city.

Tel Akbir, built by Alasiyans and expanded by Thyatians, is a blending of the two cultures. The architecture is a mix of delicate Alasiyan onion-shaped tower-tops beside the columned temples of the Thyatians. The Alasiyans here mostly do not follow the teachings of philosopher Suleiman Al-Kalim; most study the cosmopolitan faiths of the Thyatians, while maintaining their Alasiyan customs in language and dress.

Northlands

This part of the nation consists of steep hills graduating into the Altan Tepes mountains. There are rich metal deposits in those mountains, and there are many mines (worked by humans and dwarves) and many towns supporting them.

This region has three important towns.

Goldleaf is a mostly-human community; it is a trade center where miners trade gold for supplies, and a craft center for metalsmiths. Innovative techniques are developed here.

Makrast (Broken Mountain) is a dwarven mining and crafting community settled in the dawning days of the Empire by the Rockhome dwarves who built the palace of Zendrolion I. These dwarves make regular trade trips to nearby Biazzan or to Kerendas, but don't allow humans (other than representatives of the Empire) within their city.

Biazzan was built by Alasiyan settlers, then conquered by Thyatis. Built in a green valley sheltered by hills and mountains, it has a tradition of education and trade. Here, a university has grown, with great minds from Ylaruam and Thyatis and the Vyalia elves; it is a haven for scholarship, collection and distribution of world history and knowledge. Since a major trade route runs through Biazzan, the city sees much regular business.

SURROUNDING ISLANDS

There are many small islands within Thyatian waters, and four large ones.

Terentias is 50 miles southwest of Kerendas. It's a continuation of the Minrothad chain, and the Minrothad Guilds and Thyatis have had squabbles over ownership of the island. The island is Thyatis' staging area to the west. Much trade, the national pastime, is conducted here. Pirates make a lucrative living disguised as traders.

Mositius is a long island east of the Island of Hattias. It is great vine-growing territory, and its wines are famous. Toward the center of the island is a volcano; though it is thought to be dead, strange mists sometimes emerge from its crater and float across the town, with unpredictable results on the townfolk.

Carytion, due south of Tel Akbir, is a haven for the wealthy. Great villas are built here, on the slopes of the prettiest hills of all Thyatis, overlooking the most gorgeous seascapes in the Empire. The only villages here are wholly owned by wealthy families. Here also is a naval base, which helps keep pirates from the island's shores.

Borydos, south of Carytion, is a rocky, hilly island serving as a prison colony. Once it was occupied by herdsman and fishermen, but after the Thyatians were driven out of Ierendi, the Emperor of that time relocated all the population, then deforested the island to make it harder for prisoners to hide. Sea-monsters have been reared in the waters around the island, which discourages swimming escapes. Prisoners are left on the island to survive as best they can through the durations of their sentences.

CONQUERED TERRITORIES

Take a look at the map of the Thyatian Empire on page 8. It shows, in reduced detail, the mainland and the other imperial territories.

The southern and western shores of the **Isle of Dawn** have belonged to Thyatis since its first Great War with Alphatia. The **Pearl Islands** and **Ochalea** have been Thyatian conquests since the early days of the Empire. The newest conquests, the **Hinterlands**, have been taken only in the last decade, and the process of conquest continues there now.

The Empire has owned many other lands in the course of its history—southern Ylaruam, the Grand Duchy of Karameikos, Ierendi, parts of Norwold, and elsewhere—but these regions now rule themselves.

HINTERLANDS

The most recent Thyatian conquests, still going on, are taking place on the north coast of the southern continent. Blonde and red-headed barbarians, strong in war, live there. They take well to literacy, to the Thyatian schools of warfare, and to Thyatian customs . . . however, they stubbornly resist conquest, and conquest of one clan means nothing to the clan living a mere mile away. So Thyatian progress in this land, while steady, is slow.

ISLE OF DAWN

The Isle of Dawn was settled by Alphatians before Thyatian history began. When Thyatis rebelled against Alphatia, it took its war as far as the Isle of Dawn and seized about a third of the island, on the south and western shores. Now the island is split with Alphatians on one side, Thyatians on the other, and a large unoccupied plateau in the center of the island's south end.

Thyatian-controlled areas include: **Helskir**, the Grand Duchy of Westrouke and Newkirk, **Redstone Castle**, **Fortress of Kendach**, **West Portage**, the dark and nightmarish **Shadow Coast**, and **Castle Furmenglaive** and **Caerdwicca**. In most of these areas, you find a mix of Thyatian and Alphatian races.

Ochalea

Ochalea is the large island southwest of the Isle of Dawn. An unfriendly, volcanic land, it was settled by Alphatians too poor in magic to make good lives for themselves in Alphatia. Consequently, the Ochaleans have never been

fond of the Alphatians. The Ochaleans, to make up for their lack of pure magic potential, have largely turned to clerical studies.

When the Thyatians of a millennium ago rebelled against Alphatia, Ochalea soon followed suit, and arranged formal alliance with King Lucinius. Ochalea was nearly crushed in the war, so when Zendrolion I killed their king and occupied the island, they had no strength for rebellion. However, the Ochalean hostages taken by Valentia contributed much to her reforms.

Since then, the Ochaleans have built their economy on fishing. They have come to think of themselves as Thyatian citizens, and as the advance guard in the study of clerical matters.

PEARL ISLANDS

These islands, south and southeast of Ochalea, were settled by black seafarers of far-eastern Tangor in the centuries after the Thyatians settled in the north. Calling themselves Nuari, after the great island of Nuar, these people are fighters and philosophers. The Nuari philosophy calls for individual excellence in all things, so the Nuari make of themselves all they can, studying warfare and the arts, music and magic, theology and games. But their spirit of individuality and their scattered-village lifestyle meant they had no military formations or walled cities with which to withstand sieges.

The Alphatians conquered them to control the trade of the pearls that Nuari divers brought up from the sea floor; the Alphatians called this region the Pearl Islands. Mere decades later, the Thyatian rebellion of BC 2 helped the Nuari throw off their Alphatian overlords. But soon after, Zendrolion I conquered them again; fortunately, his widow Valentia's reforms, especially the idea of imperial citizenship, appealed to the Nuari philosophies. Since those days, the Nuari have been prosperous Citizens of the Empire.

There are no large Nuari towns, only villages. The Thyatian naval base and trading port of **Seagirt** is the largest community on these islands.

That, in short form, is the Empire. To find out more about these lands, ask your DM for further details.

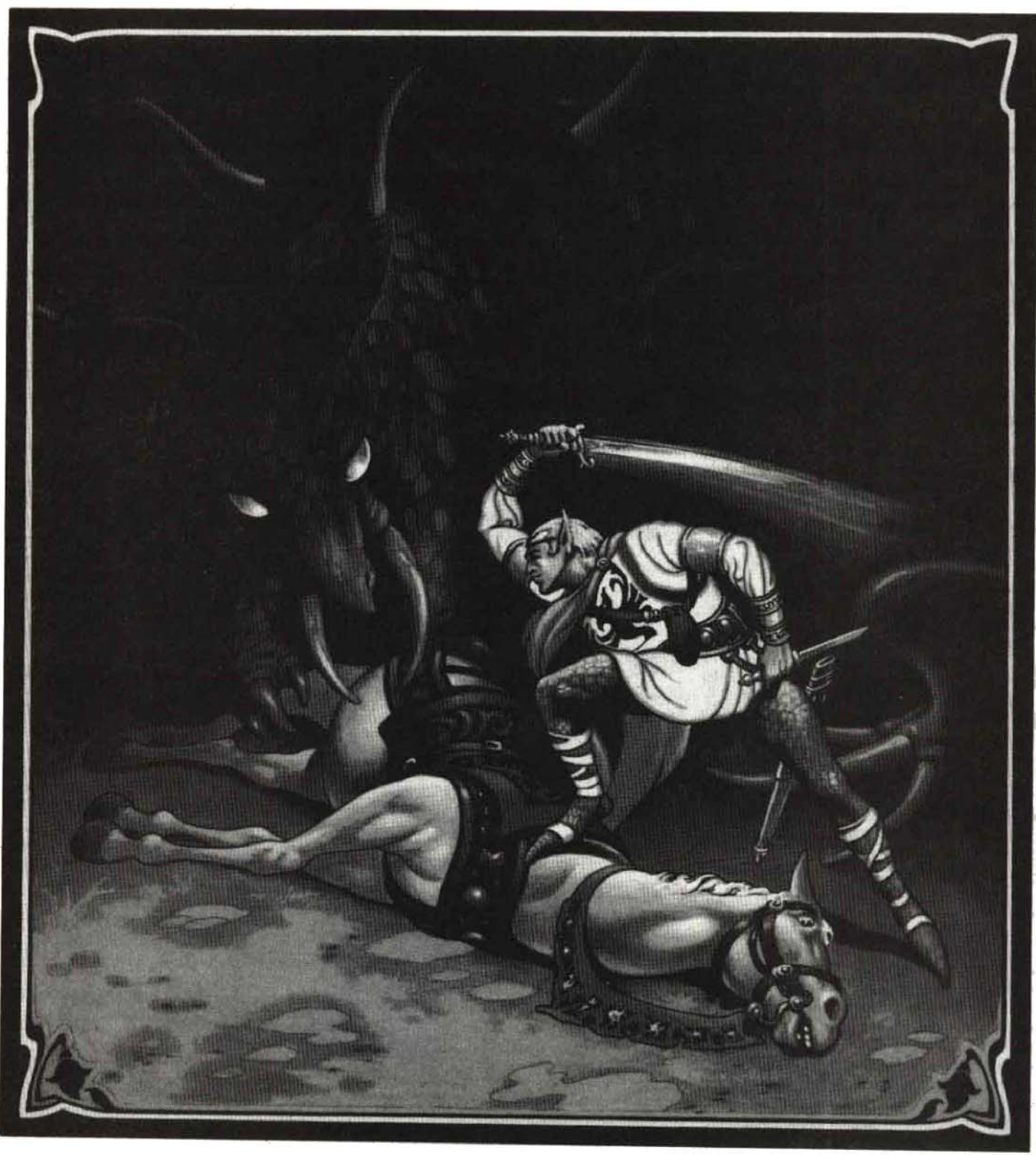

Thyatian Society and Politics



As if shocked by a bolt of lightning, Dylan stood dumbstruck in one of the dozens of huge market plazas he'd seen since debarking in Thyatis City.

All around was confusion and riotous celebration. Wildly-dressed crowds moved through the streets, drinking wine, singing songs, dancing in the manner of a dozen different peoples, shouting wishes for the Emperor's health on the occasion of his birthday.

Dylan, bewildered, stood flat against a shop wall and just watched the crowds flow by. His peoples, the Hinterlanders, treated birthdays with the solemnity they deserved—the day of birth was a milestone to one's death and was not a day of celebration. But these Thyatians danced in the streets.

That's not all they did. Mere minutes after he'd said his goodbyes to Tanarobi and debarked, he'd run into his first crowd of drunken celebrants; there, a tall, merry copper-skinned man had tried to kiss him—and no Thyatian peck on the cheek, either! Dylan's first, startled reaction was to smash the fellow, but he remembered Tanarobi's advice about gauging the motives of the other fellow, and stayed his hand. So the crowd of merry, drunken, dancing, kissing strangers paraded on unmolested.

Traveling toward the center of the city, he'd seen what he thought were men dressed as women, and women dressed as men, and units of precision Thyatian soldiers performing spectacular weapons drills in an open plaza: there were parades, fairs, and demonstrations.

Yet the on-duty city guards were coolly unmoved by the entertainment. When tempers flared in the crowds, no fists flew—duels were

arranged. For all their semblance of wild enjoyment this celebration day, the Thyatians were creatures of discipline and habit . . . Dylan wondered if he would ever understand their contradictions.

National Character

You know where the Thyatians came from and how they came to be as they are. Now, it's time to see what sort of people they are—how they act and react, what they love and hate.

Fighting Ability

More than anything else, Citizens of the Empire admire *fighting ability*. This doesn't mean that they're constantly fighting among themselves, knifing one another over the family meal, starting riots at the drop of a helmet. But it does mean that their heroes are all fighters of one kind or another—even magicians and holy men must be powerful in war to be admired.

Warfare dominates their arts and entertainments—the best-loved sculpture, stage plays, and poems deal with martial themes.

However, though there is usually some conflict taking place somewhere in the Empire, there is not always a true war. Such wars drain wealth and vitality from the Empire. So, while a border war with Ylaruam or a far-distant tribal kingdom keeps the homeland in good spirits and fills the streets with news, an all-out war will eventually result in poverty, exhaustion, and gloom settling over Thyatis. The Thyatians know this . . . and so pick their fights carefully.

Discipline

Thyatians pride themselves on their discipline. Their soldiers, schools, industries, government, clerical orders, even artisans' guilds and criminal gangs are organized and professional. However, such a widespread dedication to order has its problems. An assembly-line is efficient but does not lend itself to creativity.

Because of this, the Thyatians' greatest heroes are those who defy discipline and achieve greatness alone, unbefriended. The general who leads the army in conquest of a new territory gets cheers in the streets . . . but the unconquered gladiator who fights treacherously and then kicks the corpse of his fallen foe, who makes vulgar gestures at the senators or the Emperor himself while taking the accolade of the crowds, is the one who captures the heart of the Thyatians.

Thyatians adore the individualists who preserve the Thyatian state but also do not give in to that state when choosing how to live their own lives.

Efficiency

It has been said that the Thyatians worship an Immortal called Efficiency—and that they birthed him. And it's true that the Empire loves to do things in the most efficient manner possible. Wars of revenge are discouraged; wars of conquest and raids for booty are encouraged. Trade is encouraged, for the middle-man always gets a slice of the profits; speculation in new industry and colonization in unsettled lands are not, because the chances of failure and loss are so high. Marriages of convenience and of alliance, at least

Thyatian Society and Politics

among the upper classes, far outnumber marriages of love.

When playing a Thyatian, keep in mind that he'll analyze any situation in terms of efficiency. If what's going on is not efficient, he'll probably offer a cold, heartless, efficient alternative. Naturally, he won't press the point if it will alienate his friends.

Races

One Thyatian trait may come as a surprise. The Thyatians, among all the civilizations of this part of the world, are the fastest to embrace new cultures and races, mingling them with their own with delight and interest. The Thyatians love exotic cultures, races, fashions and customs. When contact with a new culture results in the sudden appearance of new cults and sects, clerics and scholars eagerly rush to learn about them, to contrast and perhaps combine with their own.

When conquering or meeting new peoples, Thyatians are quick to write down the history, legends and folklore of these peoples, to intermarry with them, to absorb their arts and culture. Sometimes the Thyatian conquerors end up, after a generation or two, being indistinguishable from the natives.

So the Thyatians cannot now be said to be a "race." The races which blend in the Empire include the hardy olive-skinned members of the original Thyatis, Kerendas and Hattias tribes, dusky Alasiyans, fair reavers from the Northern Reaches, dark-skinned Nuari from the Pearl Islands, red-haired barbarians from the Hinterlands of the southern continent, copper-skinned common Alphatians from the Isle of Dawn, and even elves of Thyatis' western forests. Each of them enriches the Empire's culture, arts, entertainments, and history. Dwarves and halflings are welcome in the Empire as well, and add to its culture and learning, but cannot intermarry with humans or elves.

The Role of Magic-Users

One might think, because the Thyatians dislike the Alphatians, that they would also dislike magic. It's not so. Magic is colorful and exotic. Magic can be used in warfare. And, most of all, magic is *efficient*.

So the Thyatians learn and promote the teachings of magic. They have one magical university, the College of Lucinius, in Thyatis City; the human community of Foreston is the home of the Foresters, magic-using fighting-

men who originated in Thyatis, taught by the elves of Greenheight; and there are many wizards throughout the Empire who teach small schools or individual apprentices.

This is not to say that the magical teaching in Thyatis rivals that of Alphatia or Glantri—far from it. But the opportunity to learn is there.

However, clerics are spell-users too . . . and there are many powerful clerical orders in the Empire. Clerics are well-respected in Thyatis. Clerical magic has helped Thyatis cope with the overwhelming magical might of the Alphatian Empire. And clerics fight—they're some of the best fighters in the Empire.

The Role of Women

In ancient times, before the tribes came to this continent, Thyatian women fought beside their men. According to legend, the Immortal Vanya was a woman of the Thyatians who achieved immortality. But after the resettling of the tribes on this continent, the tradition of the she-warrior went into decline. It had never been practiced among the Hattians in any case. By the time of the Alphatian conquest, female warriors were a rarity among the Thyatians.

But they never disappeared. Today, though it's difficult for a young woman to get formal instruction in combat, it's not impossible; such women must either find another woman warrior to train them, or convince male warriors that they have the potential to be good fighters. There are a few female fighting orders, and a few more which admit both males and females. Additionally, many clerical orders and the Foresters freely accept women.

Once a woman has trained to a recognizable level of fighting ability—4th experience level—this cultural discrimination takes a quick about-face. Suddenly, the she-warrior is admired and respected, for attaining proficiency in warfare and defying long odds to do so.

Opinions on female fighters vary among the Thyatian Empire. The Ochaleans don't like for women to fight; the Ochalean women who wish to become fighters must learn to fight elsewhere in the Empire. They're not accepted as Ochaleans when they return to their homeland . . . but, as full Citizens of the Empire, they can't just be sent away.

Women of Alasiyan descent, especially in Tel Akbir, suffer the same problems as the Ochaleans, but (being on the mainland) find it easier to leave home and pursue their own destinies.

Women of the Pearl Islands are encouraged to become great fighters and sailors, and are much prized in the Thyatian Navy.

Women of Alphatian descent, from the Isle of Dawn, accept no limits to their learning. They prefer to become Foresters, but many take on other professions. Some with no magical potential become dedicated warriors; they enjoy the fact that they can earn status they would lack in communities with strong Alphatian origins.

Women of the Hinterlands have fought beside their men from as far back as their earliest legends reach.

Empire in Decline

To an ever-increasing degree, decadence and irresponsibility are infecting the nobility and the wealthy of the Empire. The rich are spending ever-greater amounts on feasts and festivals, shows and tournaments. Ministers and Senators supplement their incomes with bribes. The proportion of slaves to Citizens is rising in Thyatis. Greater amounts of wines, liquors and foreign stimulants are being consumed.

The Emperor, of foreign birth, is steadfast against these excesses and still sets an example for the common man. But, increasingly, the court and the wealthy indulge in excess and debauchery . . . and eventually this will bring great harm to the Empire.

Age

Children begin their education (or are apprenticed or begin work, depending on social status and wealth) at age 7. At age 14, many noble youths become squires, good apprentices become journeymen, some lads become cabin-boys, and young women are betrothed (among nobility). Seventeen is considered the ideal year for young women to be married, 21 for young men. At age 18, Thyatians are recognized as Citizens of the Empire, but are still bound to their families' wishes. Noblemen are supposed to be betrothed at this age; many men also enter the military.

Age 21 is called Freedom Year. Citizens turning 21 are recognized as free from their families. This doesn't mean that they are kicked out of their families; it means that they are no longer obliged to follow their parents' decisions.

Running Away from Home

An old and honorable custom among Thyatians is Running Away from Home. Many Thyatian youths run away from home to thwart their families' plans for them. A lad who doesn't want to become a tanner (he longs to be a great warrior), a lass who doesn't want to wed stupid Dorcius from down the lane, or any youth who thinks himself oppressed might decide to run away from home.

So the Empire crawls with runaways between about the ages of 14 to 21. (At 21, the Year of Freedom, these youths are no longer runaways; their families have no legal power over them at that point).

Runaways depart home secretly, with their few belongings, take a new name, and flee somewhere they think their parents will not find them—such as the military services, merchant sailors, etc. Traditionally, they claim to be orphans so that they won't have to answer questions about their families. This has become such a tradition that, today, a runaway might take his or her possessions, go to a favorite uncle or the father of a friend, give his new name, and say, "I am an orphan in need of employment; do you have a place for me on your vessel?" And this adult, with an amused and knowing smile, will employ the runaway. Until the runaway reaches his Freedom Year, he will be called by his false name, and there will be no formal recognition of his true identity until then.

The law prescribes no punishment for runaways who are brought back to their families; the family heads decide how to punish runaways. Some choose not to punish them; some force the runaways back into the grinds or situations which inspired them to flee in the first place, and accompany this decision with the beatings and disciplines which are thought to make obedient children out of ungrateful brats. Naturally, these children often run away again.

Of the adventuring sort of Thyatian citizen, easily 35% spent time as a runaway, living under an assumed name.

Marriage in Thyatis

Marriage is a custom among Thyatians. It is performed in churches or temples by clerics of 3rd level or higher. Citizens under age 21 require their parents' consent to marry; slaves require their owners' consent to marry.

Cross-Class Marriages

It's not common for Thyatians to marry outside their classes . . . but it does happen, especially among adventurers, who often wed for love. A Citizen marrying a Noble becomes Noble; a Slave marrying a Citizen becomes a Citizen; a Slave marrying a Noble becomes Noble. Should these two ever divorce, or should the spouse who was born to the upper class die, the other spouse retains his or her elevated status.

Divorce

Divorce is simple in Thyatis. The two parties draw up a contract of divorce, which they sign in the presence of a cleric (3rd level or higher) and witnesses. When that is done, the divorce is final. But if one refuses the request, there can be no divorce. By Thyatian law, divorce must be agreed upon by both parties. So, if the two parties dispute over separation of goods and cannot come to terms, or if one refuses to divorce the other, there is no divorce.

Slaves may divorce only with the permission of their owners. An under-age bride or groom may not sign a contract of divorce; he or she must have the signature of a parent.

The Empire looks with tolerance on two divorces, but assigns a penalty equal to half the offender's taxes for the last year for subsequent ones; if only one party is on his third or later divorce, only he pays the fee. The Empire prefers its families stable.

Dress

The basic Thyatian outfit for men consists of a thigh-length short-sleeved tunic, belted at the waist; trousers, hose, or bare legs; soft shoes or boots; and a cloak suited to the weather (none in summer, hip-length in autumn and spring, long and hooded in winter). The basic Thyatian outfit for women is an ankle-length sleeveless gown with pins or brooches at the shoulders, belted or roped at the waist; sandals, soft shoes, or soft boots; and a cloak suited to the weather.

However, the Thyatians vary these basic arrangements depending on their mood, wealth, and situation. A man's tunic may be long-sleeved, and may reach down as high as his upper thighs or as low as his knees. Often it is square-cut at his neck but it may be V-necked with laces. Hard knee-high boots are often worn with trousers. Women's gowns may be long-sleeved, in which case they are

sewn rather than pinned at the shoulders and are laced up the back. Sleeves may be tight or flaring. Gowns may be knee-length, especially for girls and adventuring women, and are sometimes worn with hose or trousers, low or high boots. Women adventurers often opt for men's pullover tunics for convenience and comfort.

The Thyatians love bright colors on their garments—embroidered scenes and designs, bright dyes, fringes, shiny buckles and buttons and brooches, and so on. Wealthy Thyatians are extravagant (but prefer for their colors to be coordinated pleasingly); middle-class Thyatians are less ostentatious.

The poor, and slaves whose owners don't spend money on their garb, tend to have one or two garments in dirty white or tan; rope serves for belts, sandals or bare feet for better footwear.

Thyatian men cut their hair short. Some wear short beards and mustaches, but more go clean-shaven. Thyatian women wear their hair as long as situations permit (obviously, rich women can afford longer hair than poor); when they work, it is usually worn in a ponytail or single braid. Special events call for ornate hairstyles, often involving braiding or dressing the hair with chains of beads or precious gems.

The Thyatians don't like headgear, and don't wear it except when weather demands; then, they don hoods or hooded cloaks. Military folk wear hats.

The Thyatians like jewelry. They wear finger-rings, earrings, decorative pins and brooches, buckles, bracelets, necklaces, chains and buttons; women wear fine hair-nets or chains to braid into their hair; nobles may wear tiaras and coronets up to half an inch wide.

Thyatian Military Uniform

Thyatian military men wear a thigh-length long-sleeved tunic, women a knee-length long-sleeved tunic; both wear trousers, belt, sword-baldric (a sword-belt hung over the shoulder), and knee-high boots. Accessories include gloves, a billed cap, and a long hooded cloak. Rank insignia is worn as a patch on the left breast; the lower part of the patch indicates battle-honors.

Officers' tunics, male and female, have a double set of buttons on the breast, and additional rank insignia on the shoulders. Officers wear broad-brimmed hats instead of caps.

Thyatian Society and Politics

Different military units have different-colored uniforms. The navy in Thyatis City wears royal blue; the Kerendan cavalry wears tan; the Hattian footmen wear black with gold piping; Forester and elf units wear green; dwarf units wear red tunics with their other garments the color of rust.

Dress uniforms for all services are white; colors for accoutrements (belts, boots, insignia) vary from unit to unit.

Metal-armored troops wear a garment over their armor. It may be a surcoat, a huge long-sleeved tunic which fits over the armor and hangs to the knees; or it may be a tabard, a broad strip of cloth with a hole in the center through which the warrior's head fits, so that the cloth drapes down the warrior's chest and back, tied by strings at the sides. This garment is in the colors of the warrior's normal uniform, and bears his unit designation and rank. Thyatians never wear metal armor bare; this garment is required by law.

Clothes of Tel Akbir

Men wear trousers and a short tunic under a long open-front robe which reaches the feet. A broad sash acts as a belt; the Alasiyan may be barefoot, wear sandals or soft boots. A wrap called the *keffiah* is worn on the head.

Women wear soft floor-length long-sleeved gowns, belted with a sash; light shawls worn as hoods, often held to the head by a coronet or headband; often veils across the lower faces; and sandals or slippers. While ancient Alasiyan tradition mandates that women not bare their faces in public or before strangers, the women of Tel Akbir do not follow this custom; their veils, if worn, are sheer and non-concealing.

A type of indoors outfit worn by women, particularly dancers, includes a short vest, loose pantaloons tied tight at the waist and ankles, and much jewelry, particularly finger-rings, cymbals, chains of bells, and necklaces.

Clothes of the Isle of Dawn

Men and women of Alpathian descent prefer the Alpathian robe. In its basic form, it is a floor-length robe with long, wide sleeves, colorfully dyed or embroidered, and belted at the waist. But it has many variations. Men and women both often wear it at knee-length, with trousers and boots; the belt may be a broad leather belt, sash, or rope wound around three times; the sleeves may be pulled up and tied off above the elbow; the robe may

or may not have an attached hood. Color and fabric quality vary with the wealth of the wearer.

Those of Alpathian descent tend to wear very simple jewelry—one or two finger-rings, a modest necklace, a pair of elegant earrings. Alpathian men wear earrings as their women do.

Alpathians, men and women, tend to wear their hair long—either loose or in a single braid or tail; however, many of Alpathian descent wear their hair in the current Thyatian fashion.

Clothes of the Pearl Islands

The warm Pearl Islands call for light dress, so the national costume of its inhabitants is a simple kilt of any bright color, perhaps embroidered with shell or sea-life patterns. Men and women alike wear the kilt.

The Thyatians like the Pearl Island kilt, wearing it in warm summer months and in their own homes. Thyatian women, unlike the women of the Pearl Islands, typically wear matching breast-bands or vests with the kilt. In Thyatis, the Pearl Island kilt is regarded as informal wear, for labor or nightwear; it is not appropriate for official functions of any sort.

Pearl Islanders wear necklaces, bracelets, and anklets of strung shells, precious or semi-precious stones, or links of precious metals.

Pearl Islanders wear their hair short; in colder Thyatian climes, often they let it grow to the current fashion.

Clothes of Ochalea

The Ochaleans' principal garment is a straight, collared, long-sleeved, thigh-length tunic which is buttoned in front; it is not belted. When the wearer stands with arms down, the tunic's torso and sleeves form featureless cylinders. This is worn with trousers; footwear is optional. Men and women alike wear this fashion; individuality is discouraged.

Men and women wear their hair long and straight, often in a single long braid; curly hair is not considered uniform or attractive in Ochalea.

Weapons are carried on baldrics.

Clothes of the Hinterlands

The Hinterlander man wears a short-sleeved tunic which hangs to mid-thigh, usually decorated in the geometric patterns of his clan;

trousers, usually of a color which clashes with his tunic; buskins (soft, loose, knee-high leather boots which are bound to the leg with leather laces wrapped all around); and thick belts, often with too-large buckles. Hinterland men often stride around bare-chested.

The Hinterland woman wears a short-or long-sleeved tunic which hangs to the knees, decorated with clan markings; trousers, which may clash with the tunic but typically do not; calf-height buskins; and narrow belts.

Hinterlanders decorate the hems of clothing with a sort of interwoven pattern called knotwork.

Men typically wear their hair long and loose, sometimes with beards, almost always with enormous, spiky mustaches. Women wear their hair in two braids.

Adventuring Dress

So, what does the adventurer wear? The answer, of course, is *anything he or she wants to*. Adventurers borrow fashions from whatever nation or race they choose, wearing what suits their taste or their missions at hand.

It is common for each member of an adventuring party to dress distinctly from his friends. This may consist merely of dressing in one distinct color, or one foreign style, or wearing a specific insignia on all garments.

Weapons and Armor

Weapons and armor used by the military differ between services. The Navy wears light leather armor, carry large shields, and use normal swords and daggers. Elite units also carry longbows.

The warriors of the Kerendan Cavalry wear chain or scale mail, carry shields, and use lances, sabres (normal swords), and daggers. Many carry longbows or crossbows as well.

Thyatian foot-soldiers, especially the Footmen of Hattias, wear chainmail, carry shields, and use spears and normal swords.

Thyatians and the Immortals

Most Thyatians (excepting clerics) do not follow the teachings of any one Immortal; they learn about many of them. Most communities have temples dedicated to many different Immortals.

Some of the Immortals studied and worshipped in the Empire include:

Alphaks. This Patron of Pure Evil causes death, destruction, and misery; his sect is ille-

gal within the Empire. But it is still populous; it appeals to chaotics who hate Alphatia, because it is part of the dogma of Alphaks that Alphatia Must Be Destroyed. Sphere of Death; Chaotic.

Asterius. He is the Patron of Trade and Commerce, and merchants pray to him. He is also the patron of thievery, and so many of the devotions left in his temples are contributed by thieves. Sphere of Thought; Neutral.

Diulanna. Patroness of Will. This Hinterlands Immortal, whom the Thyatians are now eagerly studying, represents the belief that with enough willpower and determination, one can achieve anything. It is she who grants victory (or at least honor) to the hero who throws himself against impossible odds. Sphere of Thought; Neutral.

Halav. Patron of Warfare and Weapon-Making. He was a hero to the native Karamaikans of the ancient past; their king, he taught his people to forge bronze, then led them against invading beast-men. To the Thyatians, he exemplifies the teacher who is also a warrior. Sphere of Thought; Lawful.

Isundal. Patron of Elvenkind. His ways are followed by the elves in Thyatis, and by their friends the Foresters, and by a few humans who have an affinity for the ways of the forest and nature. Sphere of Energy; Neutral. He is guarded and aided by **Mealiden**, a later elf-king who is said to have achieved Immortality.

Kagyar. Patron of Artisans, Patron of Dwarf-kind. His ways are followed by the dwarves in Thyatis, and by many races who have artistic leanings and abilities. Sphere of Matter; Lawful.

Korotiku the Spider. This Immortal of the Pearl Islands represents the clever Fighter and Rake; he is often called the Trickster. Sphere of Thought; Chaotic.

Koryis. The Patron of Peace and Prosperity, introduced into the Empire by citizens of Alphatian descent. Popular here primarily with merchants; real warriors sneer at him. Most Ochalean clerics are followers of Koryis. Sphere of Thought; Lawful.

Odin. This Northern Realms Immortal is followed by many Thyatians of Oceansend descent and by others who admire the wedding of warfare with wisdom. Sphere of Matter; Lawful.

Protius, the Old Man of the Sea. This Immortal represents the sea in all its aspects—treacherous, beautiful, bountiful, terrifying. Many ship-captains are clerics of Protius. He is well-liked in Ylaruam as the patron of Al-Kalim. Sphere of Time; Neutral.

Tarastia. She is the Patroness of Justice and Revenge. Sphere of Energy; Lawful.

Thanatos. This Death-loving Immortal hates all life. His followers are underground sects of clerics who would betray their race for personal power. Sphere of Death; Chaotic.

Thor. Like Odin, this is an Immortal worshipped by Thyatians with Northern Realms ancestry. Thor is less interested in wisdom and more in the warrior's code than Odin; hence, he is more popular in Thyatis. Sphere of Matter; Neutral.

Valerias. Patroness of Love; Girder-On of Weapons. She promotes love and romance—especially fiery, passionate romance. But she is also known for bringing weapons to those in need and is a capable fighter. Sphere of Matter; Chaotic.

Vanya. Most popular Immortal to the Thyatians, Vanya was supposed to have been a Thyatian warrior-woman in the distant past. She is now the Patroness of War and Conquerors. Sphere of Time; Neutral.

FOOD AND DRINK

Wealthy Thyatians import unique foods and drinks from all over the world, the more exotic, the better. But the middle-and lower-class families rely on the basic foods the Thyatians have known for millennia.

Typical Thyatian foods include: (*Meat*) Fish, beef, mutton, pork, ham, fowl; (*Fruits*) Apples, figs, grapes, melons; (*Vegetables, Grains*) Peas, cabbage, asparagus, celery, barley, wheat; (*Other Foods*) Cheese, olives, biscuits, eggs, butter, honey.

In all large cities of the Empire, bakeries produce bread which is given free to the population; this is paid for by taxes and keeps many Citizens alive.

ENTERTAINMENTS

The Thyatians love entertainments. Among their favorite sorts are these:

The Coliseum

When the Alphatians conquered Thyatis 1,200 years ago, they sought to turn the Thyatians' minds away from the murder of Alphatians. One governor suggested that criminals sentenced to execution be dropped into animal-pits and given a sword and shield; should the criminal slay the beast, he would be freed. The fights were desperate and bloody, and the Thyatians loved them.

In time, special arenas were built for this sort of combat. In time, men were pitted against other men, singly or in groups, as well as against monsters. And, in time, freemen entered the arena, fighting for promised rewards.

Today, more than a thousand years later, the coliseum is still the center of Thyatian entertainment. No fee is charged for entry; rich patrons sponsor events, gladiators, and teams of gladiators. Executions no longer take place here. Some gladiators are free men, earning pay for victories; others are slave, and must fight. Animals and monsters are still brought in to fight.

Flashy gladiators can become very popular figures in Thyatis, being invited to feasts and events, earning huge sums to endorse weapons, armor or other products of specific makers.

THEATER

The Thyatians like tragic melodramas (especially those with a martial theme); pointed satires (which often feature an Alphatian villain who is not so clever as he thinks he is and is eventually outwitted by some stolid, slow-thinking Thyatian hero); and circus-like juggling, acrobatics, etc.

FEASTS

Wealthy Thyatians conduct feasts, to which they invite great nobles, popular gladiators and actors and soldiers; they have musicians and acrobats and jugglers as entertainment, and offer exotic foods and drinks. Some of these events are simple feasts, some are debauched events; all are arranged so that the patron can show everyone else just how wealthy and sophisticated he is. Such events can be incredibly costly; only the richest nobles or merchants regularly throw such feasts.

CHALLENGES AND DUELS

When one Thyatian is offended by another, he typically challenges the other to a duel. The challenged party may dictate the terms of the duel—how many parties, which weapons, where and when, whether it's to first blood or the death—and then the challenger may reaffirm his challenge or withdraw it.

Naturally, duels between popular or well-known people attract crowds, unless they are fought in absolute secrecy. Duels are fought between hated rivals, people who just want to find out who is the better fighter, military officers who disagree on some matter, people

Thyatian Society and Politics

who bump into one another on the street and choose not to apologize, people with long-standing grudges, etc. Most are to first blood; quite a few are to the death, or result in death even if they are not supposed to.

GAMBLING

Gambling—especially betting on the arena—is a favorite pastime.

GOVERNMENT

Thyatian government is arranged in five bodies: The Throne, Senate, Judiciary, Ministry, and Military.

The Throne

Thyatis is ruled by an Emperor; sometimes, if the Emperor has died and the Empress is strong enough, the Empress will rule in her own name. The throne is hereditary; the Emperor names his successor before he dies. The successor does not have to be a relative of the Emperor, but revolution often occurs when it is not. Should there be no heir named before the Emperor's death, it traditionally falls to the oldest son; if there is no son, it falls to the husband of the oldest daughter; if she is unwed, to the husband of a younger daughter. If no daughter is wed, the Senate will choose the next Emperor—unless the daughter is of sufficiently strong character and has enough personal power that she can claim the throne as her own. If there are no children, the Senate chooses the next Emperor.

The Emperor chooses all chief judges, ministers, and generals. He may order the military to action within the Empire. Through his judges, he influences interpretation of Thyatian law; through his ministers, he budgets the Empire. His power is great, but not limitless.

The Emperor also endows some titles and distributes confiscated lands. Thus, he makes new dominions and grants nobility to their rulers. We'll discuss ranks of nobility a little later.

The Senate

Each city (pop. 15,000 or more) elects two Senators; each duke or count ruling a dominion chooses one Senator; each alliance of ten or more towns (pop. 1,000 or more) not belonging to a dominion elects one Senator. Typically, there are around two hundred Senators at any given time; this number grows and shrinks as the Empire does, as dominions change, as cities change in population.

The Senate writes the laws of the Empire; no other body can introduce laws. One or more Senators will introduce a bill and then argue on its behalf; arguments and rebuttals can go on for up to a week, the legal limit on debate time. Then the vote of the Senate is taken; with a two-thirds majority (of all Senators, not just those attending), the bill will be signed into law.

The Emperor may veto any law that the Senate approves. However, the Emperor may not introduce laws. The Senate needs the Emperor for approval of laws; the Emperor needs the Senate for creation of laws.

The Senate also has to approve any acts of aggression against foreign powers. The throne may use the military in any fashion within the boundaries of the Empire—but to attack another nation requires consent of the Senate.

Since the Emperor endows titles, and many noblemen choose the Senators who represent them, the Emperor exerts much influence on specific Senators.

The Judiciary

The Judiciary presides over all trials in the Empire . . . and no Citizen may be punished without trial. The Judiciary interprets laws, and so exerts influence over Thyatian society. In trials, the Judiciary may impose sentences up to execution, seizure of lands, and stripping of hereditary or personal titles . . . but this office is bound to observe precedent and to assign sentences appropriate to the crime.

The Ministries

The Emperor exerts the greatest amount of his control through the Ministries. Each Ministry is an office which carries out the Emperor's wishes in a specific field of government. The Emperor chooses the chief Minister, who in turn chooses his subordinates and carries out his duties.

More important offices include:

The Foreign Office. This is the diplomatic office of the Empire. The Foreign Office assigns ambassadors to all the foreign powers who warrant it, conducts espionage outside the Empire's borders, deals with foreign ambassadors to Thyatis, and keeps records of all foreign treaties.

The Home Office. This office deals with official disputes and problems within the Empire; it resolves border problems, spies on Thyatian citizens, and cooperates with the Foreign Office on cases of espionage reaching to and from Thyatis.

The Imperial Guard. This is an investigative and enforcement force which answers directly to the Emperor—in other words, it's the secret police. Ruthless and powerful, it protects the Emperor, eliminates traitors, conducts inquiries of interest to the throne.

Ministry of Trade. This office sets tariffs, makes recommendations about the relationship of the Empire to other lands, and monitors trade through the Empire.

Ministry of War. This office researches warfare and recommends new developments and spending in the military, interprets the spy reports of the Foreign Office, researches and develops new ships and engines of war, supports the study and creation of new war-spells, experiments with battle formations, acquires old and new documents on warfare for its library, and strives to keep the military competitive with that of other lands.

Office of Title and Estate. This is the records office. Here you will find records for every endowment of title or land in the Empire. When a character receives a title and/or land, he will receive one document of confirmation; this office gets other copies, storing them in several different recording offices.

The Treasury. This office dispenses imperial funds, and determines how much money is to be spent on the military, on public works, on salaries of imperial employees, etc. This office also collects taxes and has its own police force, the Treasury Guard.

There are many other ministries, of lesser importance than these.

The Military

The Thyatian military has two major branches, the army and the navy. Every Thyatian nobleman is expected to maintain a force of footmen or cavalymen commensurate to his rank, to protect his dominions. In times of war, the Emperor may call on these forces. So Thyatis' standing army is very small, but can swell impressively in times of war. It has two fairly large standing contingents—the Kerendan Cavalry and the Footmen of Hattias.

Thyatis' standing navy is quite large. Its ships patrol Thyatian waters, carry naval marines to areas of engagement, assist in the relief efforts after natural disasters, etc.

These military forces may be brought to bear on places within the Empire at the whim of the Emperor—and so are mostly used to defend imperial lands and to crush rebellion. The Emperor may not send them against other lands without approval of the Senate.



In Thyatis, there are also many fighting guilds and orders not belonging to the army or navy—which we discuss in “The Fighters of Thyatis.”

Classes of Society

By ancient decree, the laws imposed by the near-legendary Valentia the Justiciar, every person in Thyatis falls into one of three social categories: Slave, Citizen, or Noble.

Slave

Thyatis has a huge slave-class. Its economy is largely built on slave labor; in cities, 30% of the population may be slave. In the Thyatian Empire, all but the poorest families will own a slave (prices run from 1 gp to 200+, depending on personality and skills).

Slavery is endless work with barely enough food and few rights. But slaves do have some rights, including:

(1) Slaves may be punished, but not maimed, permanently marred or killed by their owners, either for punishment or as a mark of ownership. (This is because enough slaves have earned their freedom and become important enough to enact laws making such branding illegal; if the owner wishes to mark the slave's status, the slave wears a sturdy steel collar or shackle inscribed with his owner's name.) An owner may prosecute a slave for some notable misdeed if he wishes extreme punishments.

(2) Slaves must receive at least minimal food and shelter. If a slave is found to be malnourished, he is confiscated by the Crown and resold. Many a slave of a brutal owner has starved himself until confiscated.

(3) Slaves may not be pressed into gladiatorial service without their consent. However, since it's easy to bring pressure on a slave, many serve as gladiators when they don't wish to.

(4) Slaves may own some property. If someone gives a slave a present, the slave may keep it, and it may not be confiscated by his owner. The slave may own no more than he can carry all at once (when healthy—the determination may not be made when he is injured or sick); if his possessions exceed his carrying capacity, he declares which items he is forfeiting, and they become property of his owner.

(5) If a slave acquires enough money, he may purchase his freedom. The owner determines the slave-price, but it may not be more than three times his original buying price, or more than 100 gp in any case. Slaves who receive presents for whatever reason can quickly save up enough to buy their freedom.

Citizen

Most persons in the Empire are Citizens. Any freeman from any land owned by the Empire is a Citizen, with rights equal to any other Citizen. This equality of status throughout the Empire is a factor which unites the Thyatians. Citizens may own property, vote in elections (usually when selecting a city's Senators), bear weapons, marry whom they choose (assuming they have reached the age of 21), and, if 21 or over, may not be punished until tried.

Noble

The Emperor may grant titles of nobility to Citizens of the Empire—both hereditary and non-hereditary titles. The Senate and certain

nobles may grant some non-hereditary titles. These titles include (from least important to most important):

Lord. Non-hereditary title. Though a father may be granted the title of Lord, his son will not bear that title unless he earns it independently. The title of Lord gives one recognition and preferred treatment in many places, because it is obvious that someone powerful holds this person in favor, but does not confer any specific rights. The throne, the Senate, and nobles of baronial rank or higher may grant the title of Lord on those they choose.

Knight. This, too, is a non-hereditary title; it is awarded to those who have shown martial prowess, dedication and loyalty in service to the Empire. The Knight has the right to bear weapons and arms of any type, anywhere in the Empire, in violation of local weapons codes (this is called the Right of Arms), though he still may have to surrender weapons when entering the grounds of the Emperor. Only the throne, the Senate, and Lord Knights may grant this title. A Count, for instance, who is not also a Lord Knight may not grant knighthood. In Thyatis, Knighthood may be granted to clerics, thieves, rakes, dwarves, and elves as well as fighters.

Baron. This is a hereditary title, and it is endowed with a dominion (a batony). The throne or Senate may grant this title. A barony is a small dominion, and a worthy baron will probably be advanced to the rank of Count or Duke later. A baron has the Right of Arms, and may bestow the title of Lord on others. The spouse of a baron(ess) also receives baronial rank.

Lord Knight. This is a hereditary title. It is initially granted by the throne or the Senate to

Thyatian Society and Politics

Knights who are notable for promoting the teaching of martial ability and knightly ideals. Included with the title is a dominion (called a barony). If a successor to the first Lord Knight in a line does not live up to those ideals, the throne or Senate may "demote" him to Baronial status. Lord Knights have the Right of Arms, and can bestow the titles of Lord and Knight. The spouse of a Lord (or Lady) Knight receives baronial rank.

Count. This is a hereditary title. It is granted to Citizens, Barons or Lord Knights who have proven themselves loyal to the throne and that they are fit to rule. Only the throne may grant this title. Included with the title is a dominion (a county). Counties tend to be larger and richer than baronies, and sometimes contain large and powerful cities. It is no disgrace for a family to have the status of County for generations; Counts do not necessarily ascend to the rank of Duke. Counts have the Right of Arms, and can bestow the title of Lord. The spouse of a Count(ess) receives the same rank.

Duke. This is a hereditary title. It is granted to Citizens, Barons, Lord Knights or Counts who have the especial favor of the throne. Only the throne may grant this title. Included with the title is a dominion (a duchy). Duchies tend to be larger and richer than counties, and are semi-autonomous of rule; a duke may enact special laws within his duchy (so long as they do not counter basic laws and rights of the Empire), and may sub-divide his land and create baronies within his duchy (and so can grant Baronial status as well as basic Lord status). Dukes have the Right of Arms. The spouse of a Duke (or Duchess) receives the same rank. A duchy which is formed in new imperial territories is usually called a Grand Duchy, and its ruler is usually left to rule as he pleases—so long as he pays his taxes and does not contradict the basic laws of the Empire.

Foreign Visitors

Foreigners are treated as the rank closest to that they bear in their own countries. An ordinary man of Karamaikos will be counted a Citizen. A northern jarl will be treated as a Count.

Changing Social Class

There are four basic ways to change one's social rank in the Thyatian Empire.

(1) **Marrying Up.** This was discussed earlier. If you marry someone of higher rank, you achieve his social rank.

(2) **The Courts.** Judges in the empire can free slaves on a whim—anyone's slave except the throne's. A Citizen who is convicted of a Greater Charge may be stripped of citizenship and made a slave—either an ordinary slave, who may some day purchase his freedom, or a Convict-Slave, who remains the property of the imperial throne for life. A judge may not strip a nobleman of Citizenship, but if a nobleman is convicted of a Greater Charge, the throne may issue a decree stripping him of title and Citizenship.

(3) **The Senate.** This body can free a slave at its discretion, and can grant ranks up to Lord Knight. It typically does so only to people who have done great service to the Empire and are considered heroes by the populace.

(4) **The Throne.** The Emperor can free a slave at his discretion, and can grant ranks up to Duke. He typically does so only to people who have done him or the Empire a great service.

ECONOMY

The Empire's economy is built on trade, slave labor, and conquest. But the day-to-day factors of economy don't affect PCs that much. Here, let's just talk about the parts of the economy that do affect PCs.

ADVENTURING INCOME

Characters are expected to keep track of the income they receive when adventuring, and to give the imperial treasury one-fourth of everything they so earn. This includes moneys earned in the Empire and outside it—a character could conceivably be taxed twice for the same money, once in the nation it was earned and once back in the Empire.

But there are some additional things to keep in mind. First, expensive and magical equipment constitutes earnings. Characters are supposed to have such earnings appraised by agents of the treasury and pay taxes on them. Some treasury agents are honest and appraise fairly. Some appraise very high and pocket the difference—but this is risky and they are often caught. The clever ones threaten to appraise high but will appraise fairly if the character throws him a little extra—say, 10% of the magical item's worth.

Second, treasury agents—both the honest and the crooked ones—are very efficient and have a large organization to draw on. Once an adventurer starts to be well-known (around fourth or fifth level) the treasury starts paying him a lot of secret attention. It's hard for a

character to get away with not reporting income for any length of time . . . and when the character is caught, he's tried on the Greater Charge of tax evasion.

COINAGE

All Thyatian coins bear a picture on the obverse (front) over the written name of the coin ("One Lucin," "One Asterius," etc.); on the reverse (back), they bear another picture over the words "Imperium Thyatium."

The standard of exchange in the Empire is the **Lucin**, the gold piece. The obverse of this coin bears a portrait of King Lucinius; on the reverse is the silhouette of an armored knight on horseback.

The silver piece is the **Asterius**, named after the Immortal patron of commerce. On the obverse is a set of balancing scales; on the reverse is the silhouette of a sailing ship.

The copper piece is the **Denarius**. On the obverse, currently, is the face of Anaxibius (the most popular gladiator now fighting in Thyatis); on the reverse is the silhouette of the royal palace. The Denarius is changed at the Emperor's whim, sometimes as often as two or three times a year; it always bears the portrait of some person who has done a notable thing, such as a Senator who has introduced brilliant legislation, a soldier who has accomplished a great feat, a popular personality, etc. This is the Emperor's way of honoring the notable persons of his Empire.

The treasury issues a platinum piece called the Emperor, worth 5 gp, in limited quantities. It bears the face of the current ruler on the obverse and crossed swords on the reverse.

Electrum is not minted in Thyatis.

LAW AND PUNISHMENT

The legal system in Thyatis brings swift justice. It's so swift, in fact, that it can be quite unfair. From the time that the judiciary decides it can prosecute and the arrest is made, the trial can begin within the week. A very good advocate can persuade the judge to delay the trial up to two weeks more, if he can present a good argument that persons and evidence crucial to his case are not yet at hand but are coming.

Criminal charges in the Empire break down into two categories: Lesser Charges and Greater Charges.

Punishments

In trial, the judge tries to determine the *intent* of the criminal. The nastier the intent, the nastier the punishment will be. The standard levels of intent include:

- (1) Accident/Unknowing
- (2) Good Intentions
- (3) Error in Judgement
- (4) Temporary Madness
- (5) Self-Interest/Unsociability
- (6) Chronic Self-Interest/Unsoc.
- (7) Inhumanity

For instance, let us say that someone is charged with Assault; he shoved someone else off a bridge into the river below. In the trial, the judge first has to determine whether the defendant is innocent or guilty, based on the evidence and arguments presented to him. Assuming that the verdict is Guilty, he must also determine the defendant's Intent. If evidence was that the defendant saw someone levelling a crossbow at the injured party and wanted to save him, that was Good Intentions. If evidence was that the defendant had been mumbling about green and red spiders crawling all over his body, then Temporary Insanity is probably the decision. If the defendant has done this sort of thing before, from time to time, then Chronic Self-Interest/Unsociability is the ruling.

Lesser Charges

Lesser Charges include Assault (Fist or Cudgel); Disturbing the Public Peace; Flight from Owner (a charge brought against fleeing slaves); Flight to Avoid Arrest; Lying to an Official; Petty Theft (up to 100 gp value); Vagrancy; Weapon-Carrying Violations; and other lesser crimes.

Punishments for such crimes vary. Sample punishments include:

Accident/Unknowing: No punishment; or Fine of 1-6 gp.

Good Intentions: No punishment; or Fine of 1-6 gp; or 5 lashes with a whip.

Error in Judgement: Fine of 2-12 gp; or 5-10 (1d6+4) lashes with a whip.

Temporary Madness: Probation of 1d6 months under supervision of a court cleric; and either Fine of 3-18 gp, or 5-20 (5d4) lashes with a whip.

Self-Interest/Unsociability: One week in jail; and either Fine of 3-18 gp, or 5-20 (5d4) lashes with a whip.

Chronic Self-Interest / Unsociability: One month in hard labor, Fine of 3-18 gp, and 5-20 (5d4) lashes with a whip.

Inhumanity: A year on Borydos Island.

Whippings are performed in public.

Where property was lost or damaged, the defendant must also repay the loss.

When a defendant cannot pay a fine, he must take either the corporal punishment or incarceration sentences.

Greater Charges

Greater Charges include Grand Theft (more than 100 gp value); Murder; Mutiny; Perjury; Rape; Tax Evasion; Treason; and other greater crimes.

Duelling to the death is not a crime, if the duel is carried out in proper fashion. If it is not, it is called Murder.

Accident/Unknowing: No punishment; or Fine of 10-100 gp (10x1d10); or Jail for one week.

Good Intentions: Fine of 10-100 gp (10x1d10) or Jail for one week.

Error in Judgement: Fine of 50-500 gp (50x1d10) and Hard Labor for one month. If noble, title and dominion may be stripped at judge's (DM's) discretion.

Temporary Madness: Fine of 50-500 gp (50x1d10) and Incarceration until court clerics are sure madness will not be recurrent.

Self-Interest/Unsociability: Borydos Island for five to ten years (1d6+4), or death, depending on crime's severity.

Chronic Self-Interest / Unsociability: Life sentence on Borydos Island; or stripped to Slave status; or death; properties impounded by the Empire in all cases.

Inhumanity: Stripped to Slave status, properties impounded by the empire, and Death.

The Calendar

On the calendar, the following dates are of particular importance to the Thyatians:

1 Nuwmont: *Day of the New Year, Start of the Winter Festivals.* This begins a week of festivals, parades, theatrical productions, nonstop games in the Coliseum, and so on in celebration of the New Year. This day also commemorates the Crowning of Emperor Zendrolion I, though the actual crowning of the first emperor took place much later in the year.

Late Vattermont (Varies): Though particularly daring sailors will have continued sailing through the winter, on one particular day in late Vattermont the port authorities of Thyatis City, in association with the Temple of Protius, announce that the Shipping Season has Begun. Merchants in great profusion set sail for distant

ports. Traditionally, this is a day to celebrate by making toasts of luck to the sailors.

1 Thaumont: Officially, the first day of Spring. Around this date, earlier or later as weather permits, spring planting begins.

22 Flaurmont: Birthday of Emperor Thincol I. The Emperor sponsors a day of Coliseum games, which are usually very flashy and memorable; there are parades in the streets; members of the Emperor's family throw gold pieces to the poorest of the peasants; very little work gets done.

1 Klarmont: Officially, the first day of Summer.

15-21 Klarmont: *Kerendan Days of the Hoof.* Now, toward the beginning of summer, Kerendas hosts its great horseman's event, which includes races, obstacle courses, jousts, demonstrations, breeders' shows, etc.

15 Felmont: *Day of Valerias.* This is a day celebrating high romance and passion, dedicated to the Immortal Valerias. On this day, more marriages take place, more betrothals are announced, more unhappy lovers kill themselves, more duels are fought by rivals for a lady's affection, more lovers keep daring trysts, than in any other week in the Empire. This is, appropriately, a day of the full moon.

1 Ambyrmt: Officially, the first day of Autumn.

8 Sviftmont: *Vanya's Day.* This is a day of gift-giving and celebration of the year's prosperity—or hope for the next year's prosperity, if this one has been poor. This is a day of good cheer and heavy feasting; it is also the day upon which the most serious duels take place. By ancient tradition, only duels to the death are conducted on Vanya's Day; other duels must be delayed.

22 Eirmont: By now, nasty weather brings about the end of the official shipping season (though many seamen keep at their trade longer into the cold months than this). This date is a day for quiet observances and feasts through the empire, and is called Protius' Day for the Immortal of the Seas.

1 Kaldmont: Officially, the first day of Winter. True winter weather doesn't usually begin for a few weeks.

15-21 Kaldmont: *Footman's Games.* Footmen's tournaments take place, in the company of fairs and bazaars and other entertainments. Weaponmakers show off their wares and many challenges and duels take place. This event is set off six months from the Kerendan Days of the Hoof and is the footman's equivalent of it, but these Games are more widespread, taking place all over the Empire.

Character Creation



Races and Character Classes

The standard character options of cleric, fighter, magic-user, thief, dwarf, elf, and halfling are all available to PCs in Thyatian campaigns.

There are dwarves all through mainland Thyatis, and quite a few on the Isle of Dawn. There are not many in Ochalea, the Pearl Islands, or the Hinterlands. Most are from Makrast.

Most elves in Thyatis come from the Vyalia forests. Across the Empire, you will find a few elves from the Isle of Dawn (descendants of both Thyatian and Alphantian elves), from the Pearl Islands (immigrants from Thyatis and Minrothad waters), and from the Hinterlands (from southern elf-clans).

There are not many halflings in Thyatis. Most belong to families which trade between the Five Shires and Thyatis City. The Ochaleans do not like demihumans and do not accept halfling settlers; there are no halfling communities in the Hinterlands. But halflings are welcome on the Pearl Islands and the Isle of Dawn.

The Forester Class

There is one profession available only in Thyatis: The forester. As you saw in the "History of Thyatis" section, emperors of Thyatis made a pact with the Vyalia elves whereby those elves would teach their magics to humans who could learn them.

Some humans just learned magic and became magic-users. Some, however, who had

an affinity for the elvish way of life, were adopted into Greenheight clans in a ceremony invoking the elvish Immortal Ilsundal. When a human is adopted this way, he can learn both fighting and magic as the elves can.

So, for 500 years, there has been a class of foresters in the Vyalia woods. Foresters are few in number; there are only a few hundred of them. But because they combine magic-use and fighting in ways that no other humans can, yet do not appear different from other humans, they are effective as adventurers and spies.

Details of the Forester Class

Prime Requisite: Like elves, foresters have two prime requisites: Strength and Intelligence. If a forester has a score of 13 or more in both Abilities, he gains a 5% bonus to Experience Points. If Intelligence is 16 or more and Strength is 13 or more, the XP bonus is 10%.

Minimum Scores: Unlike the elf, a forester must have both a Strength and Intelligence of 12 or better when first played.

Hit Dice: A six-sided die (1d6) is used to determine a forester's hit points (plus Con bonuses, if any).

Armor: A forester may wear any kind of armor, and may use a shield.

Weapons: A forester may use any weapon.

Vision: Foresters do *not* have infravision.

Languages: Foresters speak Common (Thyatian), their Alignment tongue, and Elf (Vyalia dialect). They may speak other languages as Intelligence bonuses dictate.

Detection: Foresters do have the elvish detection ability.

Immunity to Ghoul Paralysis: Foresters do *not* have the elvish immunity to the paralyzing attacks of ghouls.

Saving Throws: Foresters have the same saving throws as elves.

Experience Point Advancement: Foresters earn experience *exactly as elves do*. There is no difference. They are limited to 10th level in experience, just as elves are.

Foresters in the Campaign

Though foresters are not very different from elves in abilities, they are very different in a campaign. They can pretend to be mere fighters or mere magic-users until crucial points in the campaign. It's very useful and dramatic for a forester to pretend to be an ordinary fighter until the point in the adventure when his magical abilities will help save the day for his allies. Additionally, foresters provide a link between human and elf characters.

Important Note: It is the influence of the Immortal Ilsundal that allows foresters to learn both magic and fighting. Only through adoption into an elf-clan requiring a ritual honoring Ilsundal, and becoming a member of the forester class, can a PC learn magic-use and fighting. Ordinary fighters can't learn magic; ordinary mages can't wear armor and use most weapons. Period.

The Rake (The Non-Thief Thief) —

Another character option for Thyatian characters is that of the rake—the non-thief thief.

The people of the Pearl Islands admire the trickery, agility, and cleverness of the thief. But they *don't* like stealing—it offends their philosophy of personal growth and individual excellence. So in the Pearl Islands there developed a class of thieves, called rakes, who don't steal. They have thief-like abilities—except that they have no Pick Pockets or Backstabbing skills. Across the centuries, the idea of the rake has spread across the Empire, so you can find rakes in any part of the Empire (and, with DM permission, outside the Empire).

To have a rake character, you simply create a thief, call him a rake instead, and take no Pick Pockets or Backstabbing skill. The rake gets nothing to replace the lost skills—except that his comrades may trust him more than they do normal thieves.

Rakes earn experience, gain levels, wear armor and carry arms, and so on exactly like thieves. However, they do not belong to Thieves' Guilds (thieves do not consider them to be in their profession). Many are Lawful.

A thief may not later become a rake, nor may a rake become a thief. When that choice is made, it's for life.

The rake profession is a good choice for players who want their heroes to be lightly-armed swashbuckling types.

Female Characters —

In the "Thyatian Society and Politics" section, we mentioned that some of the Empire's societies don't approve of women adventurers. This is a reflection of certain cultural attitudes—it's *not* meant to discourage you from playing women PCs. If you want to play a female character, go right ahead! If you choose a background from an area where women are discouraged from adventuring, all you have to do is decide *why your character is an adventurer anyway*.

Female characters from areas where women aren't supposed to be adventurers may face prejudice in their homelands. But this attitude should come only from antagonistic NPCs. Other PCs and friendly NPCs should not be spouting such attitudes to the female PC; they're supposed to be her friends.

Races —

You should decide what race your character is. Human Citizens come from many different places. A human of Thyatis may bear the coloration of one of the Empire's races, may have been raised in a different part of the Empire and may now be living in yet another part.

So, choose your human character's backgrounds and attitudes to be whatever you like. The races to which Thyatians belong are described below in general terms; choose those elements which appeal to you for your character.

Thyatians and Kerendans —

Racial Characteristics: Light olive skin tone; hair ranging from light to dark brown; eyes usually brown, blue not uncommon; tend to average height and solid build; wide brow and prominent nose are common.

Cultural Attitudes: We are not conquering the world but civilizing it; fighting ability and efficiency are the foundations of the empire, and expediency props them up when they wobble; we enrich ourselves by absorbing all the traits of all the races of the Empire; the Alphatian Empire must fall.

Hattians —

Racial Characteristics: Light olive skin tone; hair ranging from light to dark brown, frequently black; eyes usually blue or grey, brown not uncommon; tend to average height and solid build; wide brow and heavy facial bone structure are common.

Cultural Attitudes: We are the greatest race ever to be; a promise made to one of a lesser race is not truly a promise; Hattian blood must stay pure if the race is to stay strong; the Thyatian Empire will one day be the Hattian Empire.

Alasiyans (Tel Akbir) —

Racial Characteristics: Dusky skin tone; hair usually black, ranging to dark brown; eyes usually dark brown, sometimes black or lighter brown; range from average height to slightly taller, more lean than Thyatians; sharp features are common.

Cultural Attitudes: The Alasiyans of Tel Akbir have the best of both worlds, Alasiyan and Thyatian; women should not make war or adventure; mastery of the language of diplomacy is the greatest weapon one can possess, but a good scimitar in your hand helps; the Ylari and the Thyatians take themselves too seriously.

Alphatians (Isle of Dawn) —

Racial Characteristics: Coppery skin tone; hair ranging from golden brown to dark brown to red; eyes brown, gold, green, hazel, or amber; built tall and lean; delicate bones and facial features are common.

Cultural Attitudes: Life is to be enjoyed; hard work is what you must endure so that the rest of your time may be spent in artistic and personal pursuits; the greater you are the more servants you may employ to do your work; the Alphatian Empire is foolish about clerics and fighters, for clerical magic and fighting allow all to achieve greatness; the law is a fence to those who can't go over it; community exists to serve the individual.

Ochaleans —

Racial Characteristics: Coppery skin tone; hair ranging from golden brown to dark brown, seldom curly; eyes brown, amber, or gold; average height to tall, and built lean; fine facial features are common.

Cultural Attitudes: One should take pride only in the work he does for family and city; only the fighter and cleric merit respect; women should not fight or adventure; the law ensures fairness for all; the individual exists to serve the community.

Pearl Islanders (Nuari) —

Racial Characteristics: Black or deep brown skin tone; hair brown or black; eyes brown or black; built tall and lean; high cheekbones and fine bone structures are common.

Cultural Attitudes: The greatest honor comes from developing abilities and knowledge to the greatest possible heights; to steal is to diminish yourself.

Hinterlanders —

Racial Characteristics: Fair skin tone; hair light brown, blonde, or red; eyes blue, sometimes brown; average height to slightly under, men often very stocky and muscular; square features, strong cheekbones, strong bone structures most common.

Cultural Attitudes: To fight alone is to be a hero; to fight in formation is to be an ant; to fight from behind a wall is to be a turtle; the Immortals help those who help themselves; helping one's self to the goods of a fallen foe (or the pouch of an unwitting one) is to capture a memento of your greatness or cleverness; live no part of your life in moderation.

Character Creation

Who Hates Whom

Here's a chart which will show you how various sorts of people are regarded by other various sorts of people.

If You Are A:	These People Don't Like You
Magic-User	Ochalean
Thief	Pearl, Ochalean
Hattian	Just About Everybody
Alasiyan	Hattian
Alphatian (IoDawn)	Hattian
Ochalean	Hattian
Pearl Islander	Hattian
Hinterlander	Hattian
Woman Adventurer	Alasiyan, Ochalean

Family

You should invent details about your character's family background and then give them to your DM so that he can elaborate on them, modify them, and insert them into the campaign world. You can have your PC's family be of any social class, from any sort of background. This won't give you any advantage in the game—you get no extra gold for saying that you're the son of a rich man (perhaps you're an unrecognized child, or an exile, or your parents want you to make your own way in the world). Starting gold is 3d6x10 gp.

Decide on a family background to give your character color—not to give him some sort of monetary or social edge when created. The DM should take away any such edge to keep things balanced.

Social Standing

All PCs from the Empire are Citizens. They may be from noble families, but they'll have to earn their own titles of nobility to be nobles.

Names

For names in the Thyatian fashion, here are some guidelines. Thyatians have two names—a given name and a family name. Once you've seen a lot of Thyatian names in this guidebook, you should have a good ear for what sounds Thyatian.

Hattian Names

The Hattians, though related to the Thyatians, have a different fashion of naming. Their names have a harsh but familiar ring—

Men's names like Adolf, Friedrich, Gunther, Gustav, Heinrich; women's names such as Anna, Frieda, Helga, Hilda; family names like Huegele, Schonberg, Schmidt, von Hendriks.

Alasiyan Names

The Citizens of Tel Akbir name their children in the fashion of their forefathers. Their names should suggest desert nomads and cities of tents—male names such as Abdalla, Farid, Hassan, Mustafa, Yasser; female names such as Farah, Fatima, Jamila, Myriam, Yasmina.

Alphatian Names

Alphatians have only one name, and identify themselves further by citing rank, birthplace, parents' names, etc. Alphatians choose children's names for beauty and singularity. Few name their children after others. An Alphatian name will have two or more syllables, and is chosen in the hopes that the child will grow into it. Strong, hearty names full of consonants are given to children whom (it is hoped) will grow into strong leaders; twining, sibilant names are given to those who should grow up cunning and thoughtful; beautiful, elegant names are given to those who should be artists, dreamers, or courtesans.

For Alphatian characters, choose a name which sounds like the personality you have imagined for him or her.

Ochalean Names

The Ochaleans have family and personal names, and give family name first, personal name second. Family names tend to be tonal and two-syllable, often hyphenated: Den-Huang, Dao-Ling. Personal names tend to be one syllable, usually beginning and ending with a consonant, sounding like a note from a chime: Chen, Tuong, Ping, etc.

Pearl Island Names

Pearl Islanders, like Alphatians, have only one name. It is composed of short sounds composed of one consonant and one syllable—ka, ti, lo, ru, etc. Each Pearl Island name is four syllables long. Male names end with the suffixes -ro, -bi, -du, and -ku; female names end with -ko, -mi, -la, -su. Pearl Islanders give their island name (or the name of the island on which their family originated) as their family name. Since more Pearl Islanders come from Nuar than any other island of the chain, many bear the family name Nuar.

Hinterlander Names

The Hinterlanders call themselves by a single name plus that of a parent. Men mention fathers; women, mothers. Thus, you hear "Brian son of Penn" and "Maeve daughter of Branwen." Their names are distinctive and lyrical—male names like Amren, Bran, Brian, Conn, Dylan, Fergus, Finn, Glew, Gweir, Kyledyr, Owain, and Penn; and female names like Ana, Branwen, Brigit, Creiddylad, Ellylw, Eurolwyn, Goewin, Gwennion, Maeve, Medb, Olwen, Rhiannon, and Tangwen.

The Hinterlanders also like epithets—descriptive phrases attached to their names, such as "Brian of the fleet foot" or "Brigit Silver Bow."

Adventurers' Names

Many Thyatians end up with foreign and exotic names. The Emperor himself bears an unusual name—Thincol, a slightly Thyatinized version of his Northern Realms name of Thrainkell. With this in mind, it's perfectly appropriate to give your Thyatian character just about any name. If the name is not typically Thyatian, then the character's parents gave him a foreign name for its exotic sound.

Languages

In the Empire of Thyatis, Thyatian is the Common Tongue. Every Citizen is expected to speak Thyatian. Most Citizens do so with the dialect of Thyatis City; this is the dialect of most of the conquered areas. Citizens born in western Thyatis usually speak with a drawling Kerendan dialect; those of the Island of Hattias usually speak with the abrupt Hattian dialect.

If a character doesn't have extra languages from high Intelligence, he may not be able to know both Thyatian and his mother tongue. In that case, you may wish to use the optional Languages rule from the General Skills section, which follows this one.

Alignment Language

The Alignment Languages in the Thyatian Empire are not actually languages. They are a combination of hand-signs, speech patterns, and other recognition signs which one uses with any language he speaks. When a person lets a few Alignment Language signs or phrases slip into his speech, other people of the same alignment—regardless of whether or not they speak his language—can recognize him as one of "theirs." Persons of other align-

ments won't recognize that such signs and phrases are being used.

If persons of the same alignment, speaking the same language, utilize their Alignment Language while speaking, they can communicate basic statements to one another without persons of other alignments realizing this is taking place. Such statements are limited to how they feel about other characters and other topics of their apparently innocuous conversation: "This mission is doomed;" "Don't hurt Julia—she is one of us."

If persons of the same alignment who do not otherwise speak the same language try to communicate, they can use their Alignment Language to communicate basic thoughts the same way . . . but it will be obvious that they are communicating in that way, and they cannot communicate sophisticated thoughts to one another.

Other Languages of the Empire

Alasiyan: Language of the Alasiyans of Tel Akbir. It is the same as that of Alasiyans of Ylaruam, but is a slightly different dialect.

Alphatian: Language of the Alphatians of the Isle of Dawn. It is the same language as the Alphatians of Alphatia speak, but is a slightly different dialect. It is a very flowing, lyrical language.

Ochalean: Language of the Ochaleans. It is descended from Alphatian, but is no longer the same language. It is very tonal, with each syllable often spoken at a distinctive musical pitch.

Nuari: Language of the Pearl Islands; it is full of short, clipped syllables spoken very fast. It is related to the languages of the black empires of the far east.

Hintelander: Language of the tribes of the Hinterlands. It is not related to the other tongues; full of consonant sounds, it is difficult for Thyatians and Nuari to pronounce.

Elvish: This is the same language as the elves of Alfheim, Glantri, and elsewhere, but the dialect is called Vyalia and is distinctive.

Dwarvish: This is the same language as spoken in Rockhome, with no significant variations.

Halflings in Thyatis speak Thyatian.

General Skills

Here's an optional set of rules for General Skills: abilities which can help the character in the course of the campaign, and help the player understand and run the character better.

Beginning General Skills

A 1st-level character knows four general skills. Some may be chosen for him, based on his race or nationality; some he may choose himself. He may know more than those four skills if he has an Intelligence over 12. If he has an Intelligence of 13-15, he gets +1 skill; if his Int is 16-17, he gets +2 skills; if his INT is 18, he gets +3 skills.

How Skills Are Used

Each general skill is based on one of the character's Abilities (Strength, Intelligence, Wisdom, Dexterity, Constitution, and Charisma). Whenever the DM feels the character's skill is appropriate, he asks the player to roll d20 against his current score in that Ability. If the roll on the 1d20 is equal to or less than the Ability, the skill use succeeds. A roll of 20 always fails, no matter how high the chance for success.

Use of the skill provides the character with success in the task he is attempting. If a character is using his Riding skill to stay atop his horse, and he successfully makes his skill roll, then he stays atop his horse.

Sample Skills

Following are skills which are appropriate to a fantasy campaign. Players and the DM may add skills to this list as the DM sees fit. The DM determines which Ability new skills pertain to.

When choosing skills, think about what the character would know based on his background. If the character is the son of a sea-captain, then the character will probably have Profession of Seaman, at least. Additionally, some skills will be pre-chosen for demihuman characters.

Strength Skills

Intimidate: The ability to bully others into doing what you want them to do. Success means that NPCs are intimidated into doing what the you want. This skill cannot be used against PCs. It doesn't make friends of those you intimidate.

This works best against civilians and non-fighters. The DM may have NPC adventurers and tough characters ignore the use of Intimidate.

Muscle: Experience with heavy lifting and hard labor. The character can direct groups of laborers to make their efforts most effective. He understands the use of simple machinery

like wedges, pulleys, and levers. With a successful roll, the character receives a +2 bonus on Strength rolls for tasks like Opening Doors.

Wrestling: In wrestling combat, a successful roll will give the character a +1 to his Wrestling Rating as per the *D&D® Companion Rules*. Higher skill scores give higher bonuses, so a character with Wrestling +1 would receive a +2 bonus, and so on.

Intelligence Skills

Craftsman: One type of craft; examples include armoring, bow-making, engraving, gemcrafting, goldsmithing, silversmithing, smithing, weaponmaking, etc. Character can make his living at this profession and, with a successful roll, make expert opinions on subjects pertaining to his skill.

Doctor: This is the ability to treat wounds and diagnose illness. A successful skill roll allows a character to restore 1d3 hit points to a wounded character. (A related skill, Veterinarian, would allow similar treatment of monsters.)

This skill may not be used on a wounded character more than once for the same set of wounds. If the character receives new wounds, Doctor skill may be applied against the new wounds. The skill is rolled against a set of wounds, not individually against each injury.

If a 20 is rolled when using this skill, the doctor accidentally inflicts 1d3 points of damage to the patient, and may not treat him again for that set of wounds.

Successful skill rolls also allow the doctor to diagnose illness; a roll made by 5 will allow him to determine whether an illness is natural or magically-induced.

Knowledge: One field of study; examples include the culture or geography of one area, history, legends, theology, etc. Character can usually make his living by teaching or trading in his skill; with a successful roll, he can make expert commentary on information relating to his skill.

Labor: One type of laborer profession; examples include bricklayer, farmer, maid, miner, stonemason, etc. Character can make his living with the skill; on occasions where it will be useful, with a successful roll, he can interpret information in light of his occupation.

Lip Reading: To use this skill, the character must be able to see the lips of the target person or creature and understand the language being spoken. A successful check allows a conversation to be "overheard." The distance to the target and the available light should be

Character Creation

taken into account—the DM will apply modifiers for difficult situations.

Mapping (Cartography): A character may not be able to read but still can understand and make maps. Comprehension of simple maps is automatic; skill rolls should be made when interpreting or drafting complicated layouts, or when mapping an area by memory.

Military Tactics: This skill allows a character to interpret the movement of enemy forces and to move his own forces better. When using this skill, the player first decides what he thinks is right—what the enemy is doing or how he should set up his units. Then the DM, not the player, rolls the character's Military Tactics skill. On a successful roll, the DM will truthfully tell him whether or not he has done right; on a failure, the DM will lie and tell him he has done right whether or not he has.

This is also a good skill to have when the *War Machine* rules are being used—unit commanders can use the skill on one another.

When rolling to determine the Combat Result, one commander per side rolls his Military Tactics skill. If a commander makes it, take the number by which he made it, multiply it by 10, and add it to his Combat Roll. If he fails it, take the number by which he failed it, multiply it by 10, and subtract it from his Combat Roll. If he makes it only exactly, he receives no modifier to the Combat Roll from his skill. This skill once per battle.

Mimicry: The ability to mimic animal noises and accents.

Profession: One type of non-labor profession; examples include advocate, architect, companion, cook, engineer, groom, scribe (must be Literate), seaman, valet, etc. The character can make his living with his skill, and (with a successful roll) make expert commentary on subjects pertaining to his skill.

Navigation: By taking directions from the position of the sun and stars, the character can always know roughly where he is. Successful skill rolls, with positive or negative modifiers for the character's distance from his home territory and familiarity with his surroundings, will tell the character where he is.

Science: One branch of scientific study; examples include astronomy, geology, metallurgy, etc. Characters with this skill can make their living with it, usually as freelance specialists in large cities.

Signalling: Successful use allows the character to leave messages that can only be understood by another Signalling specialist. For instance, unobtrusive scratches on a tree-trunk may be an elf-sign that there is danger ahead. When a character takes Signalling, he

must specify the type of signals that it pertains to, and must have had opportunity to learn such signals; types of signalling found in the Empire include Elf/Forester-Signals, Dwarf-Signals, Thief-Signals, and Trumpeter-Signals (used in the army).

Survival: This skill allows the character to find food, shelter, and water in any one type of terrain (of the player's choice): Desert, forest, mountain, open sea, plains, etc. Desert Survival doesn't give the character the ability to survive in the forest; he must also take Forest Survival for that.

Tracking: The character can follow tracks. The DM is free to increase or penalize the chances of success depending on the circumstances (age of the tracks, type of terrain, number of tracks being followed, etc.).

Wisdom Skills

Animal Trainer: The character knows how to raise, train, and care for one type of animal. The animal can be taught some simple tricks or simple orders. A character who wants to train two or more different animal types must choose this skill more than once—Horse Trainer is one skill; Dog Trainer is another. Characters must have this before joining the Retebius Air Fleet or Knights of the Air (next chapter).

Caving: This is the ability of not getting lost while exploring underground caves, cavern complexes, rivers, etc. Many dwarves have it.

Codes of Law and Justice: This is the knowledge of the laws and judicial system of Thyatis; characters who wish to be a Judge or Advocate must have it. Each empire or nation has its own Codes, so characters who wish to be conversant in different nations' codes should buy this skill multiple times.

Danger Sense: A successful skill roll means that the character may detect an imminent danger. The character will not know the nature or source of the danger. The DM, not the character, makes the skill roll, informing the character of the result (if any).

Detect Deception: This is the ability to recognize deceptive behavior in an NPC. This does not reveal the truth or falsehood of specific statements, nor the motivations of the speaker, nor the exact nature of the deception. Unlike the *detect lies* spell, the skill only warns the character to distrust the deceptive NPC. The DM makes the skill roll for the character, informing him of the result.

Gambling: The ability to win money in gambling games of skill (competitive card games, for instance). This involves honest

games (Cheating is covered elsewhere), and is treated like any other profession skill for the amounts of money earned in the long run.

Guidance/Counsel: This is the advisory skill of the kindly old cleric and other people whose advice is sought by those in trouble. The player interprets the situation, formulates his recommendation, and then makes his roll; if it is successful, the DM will tell him how accurate or helpful his idea is.

Honor (Specific Immortal): This skill honors an Immortal to gain his favor and aid. This includes knowing the code of behavior and the rituals pleasing to the Immortal. This skill enables clerics to obtain the use of their spells. Use of this skill for this purpose is automatically successful in routine situations. But if the cleric has performed actions displeasing to his Immortal, he may be required to make his skill roll. Failure may mean that the cleric does not receive one or more of his spells, or that he suffers some other penalty, such as a warning curse.

Dexterity Skills

Acrobatics: The character with this skill may perform impressive acrobatic feats, may balance on taut ropes and wires, etc. A successful skill roll is required to perform any acrobatic feat; failure may result in the character falling. A successful roll allows a character to reduce the effective height of a fall by 10 feet. A DM may give an Acrobatic character a +2 to save vs. mechanical traps where agility would help—such as tilting floors and pit traps. Many entertainers, thieves and rakes have this skill.

Alertness: Successful use of this skill allows the character to draw a weapon without losing any time, to avoid the effects of Surprise, or to wake up at the slightest noise.

Cheating/Gambling: This is the skill of winning at gambling games by cheating—by dealing cards from the bottom of the deck, etc.

Mountaineering: This does not replace the thief's Climb Walls; it is the skill of mountain-climbing with the use of ropes, pitons, and other climbing gear.

Riding: This includes the basic care and feeding of a riding animal, and the ability to control it under difficult circumstances. Riding rolls are also required if a character is trying to use a weapon from the back of a riding animal; failure means that the mount is moving too much for the character to use the weapon.

Each Riding skill allows the character to ride one type of animal; if a character wishes to know how to ride two different types of beasts, he must buy two different Riding skills.

When a character uses his Riding skill on the wrong animal, say when a horse rider tries to ride a camel, he suffers a -4 to his Riding rolls.

Charisma Skills

Acting: This is the ability to make one's living as a stage actor, but it also imparts the ability to pretend to be someone else or to show false emotions. Successful use of this skill allows a character to tell convincing lies over a period of time.

Bargaining: A successful skill roll allows a character to get the best deal available for goods, services, or information. It's not usually possible to bargain someone into giving you a great deal for nothing.

Deceive (Fast-Talk): This is the ability to persuade a listener of the truth and sincerity of what is said, despite the fact that the skill user is lying through his teeth. Successful use of this skill causes an NPC to believe an untrue statement, or to accept a misleading statement as honest and sincere. Failure indicates that the character sounds unconvincing.

Leadership: Successful use of this skill adds +1 to the morale of any NPCs under the character's control. It may also be used to convince other NPCs to follow the character's commands.

Music: This skill allows a character to play one group of related instruments in a skilled manner; the player chooses the group of instruments which his player knows. Groups include stringed instruments, brass, percussion, woodwinds, etc. This skill is often taken in conjunction with Singing skill.

Persuasion: This is the ability to persuade NPCs of your honesty and sincerity. The speaker must believe the truth of what he says. Successful use of the skill means the listener believes what the speaker tells him; it does not mean that the listener will agree to actions proposed by the speaker. The DM may assign modifiers of from -1 to -8 to the skill use if the audience is hostile.

Singing: This is the ability to sing in a skilled manner; a character can make his living with this skill and (if he is good enough) can become a famous entertainer or bard.

Optional Rule for Languages

With DM permission, characters can take additional languages as Int skills. Characters still get all the free languages they're entitled to from their Intelligence and racial abilities. Characters have trouble speaking these additional "skill" languages. A character speaking a "skill" language will automatically understand someone speaking slowly and simply. If the character is listening to someone who is excited or using technical speech, he must make his skill roll to understand the language. Failure means he didn't understand what was said.

The character speaking a "skill" language communicates in the same way; when he's struggling to explain something quickly, or something complicated or technical, or when he's flustered or excited, he must make a skill roll to get the idea across.

Improving Skills

To increase a character's skill to a higher score than the Ability on which it is based, you "trade in" one or more other skill choices in order to improve this skill roll, and get a +1 to the roll per skill choice traded.

Example: Theodosius has only a Dexterity of 11, yet wishes to be a good Rider. Instead of putting one skill choice on Riding, he puts three on that skill. The first choice gives him his Dexterity score, 11, for his Riding roll. His +2 choices give him a +2 to the roll. His Riding roll will be a 13 instead of an 11.

What Different Rolls Mean

For a standard of comparison, here's what different levels of skill rolls mean to a character.

If Skill	Check Is: Effect on Character:
3-5	Very basic skill ability Can do undemanding tasks (ones not requiring Checks) Often fails difficult tasks (those requiring Checks)
6-8	Fair grounding in skill Can do competent work Often fails difficult tasks
9-12	Solid grounding in skill Does good work Can train apprentices Often succeeds in hard tasks
13-15	Excellent command of skill Can train journeymen (especially skilled apprentices)

16-17	Almost always finds work Usually succeeds at hard tasks Marvelous command of skill Can train masters Almost always finds work Can act as efficiency expert Usually succeeds at hard tasks
18+	Genius command of skill Can train masters Always finds work Can act as efficiency expert Uses skill with amazing results (masterpieces and classics in his field)

Learning More Skills

As time goes by, your character may choose to purchase more skills or improve existing ones. All characters get a new skill choice every four experience levels. Thus, humans get four choices (plus bonuses for high Intelligence) at level 1, then an extra at level 5, another at level 9, another at level 13, and so on.

Above 12th level, the ceiling for dwarf characters, dwarves get another skill choice at 1,200,000 experience points, and another choice for every 800,000 experience points earned after that.

Above 10th level, the ceiling for elf characters, elves get another choice at 1,350,000 experience points, and another for every 1,000,000 experience points earned after that.

Above 8th level, the ceiling for halfling characters, halflings get another choice at 300,000 experience points, and another for every 1,200,000 experience points earned after that.

Each new skill choice may be used to buy a new skill or to improve one old skill in the manner described above.

Appropriate Skill Choice

Players are mostly free to choose their characters' skills, but the DM is within his rights to insist that some of the character's beginning skills be appropriate to his origin. Some characters are required to take certain skills when first created.

Cleric characters must take the skill Honor (Specific Immortal). The player must specify the Immortal whom the Cleric serves. Recommended but not required: Codes/Law and Justice, Detect Deception, Guidance/Counsel, Riding.

Fighter characters are not required to take any skills. Recommended: Military Tactics, Riding.

Character Creation

Magic-User characters are not required to take any skills. Recommended: Knowledges (history, magic, planar geography, etc.), Riding, Sciences, Scribe.

Thief and **Rake** characters are not required to take any skills. Recommended: Acrobatics, Alertness, Danger Sense, Signalling (Thief).

Dwarf characters must take Mining (Profession) and Engineering (Profession). Recommended but not required: Caving, Mountaineering, Riding, Signalling (Dwarf). (If you are using GAZ 6, *The Dwarves of Rockhome*, and have Dwarf-Cleric characters, they must take the skills required of both Dwarves and Clerics.)

Elf characters must take Alertness and Survival (Forest). Recommended but not required: Danger Sense, Signalling (Elf/Forester), Riding, and Tracking. (Alfheim elves have different Required Skills: Tracking, and Treewalking, a Dexterity-based skill.)

Halfling characters are not required to take any skills. Recommended: Alertness, Riding.

Forester characters must take these skills: Alertness and Tracking. Recommended but not required: Danger Sense, Riding, Signalling (Elf/Forester), and Survival (Forest).

Skills and the Character Sheet

On the character sheet in *Book 1*, you'll find a box labelled **General Skills**. Ask your DM for photocopies of this character sheet. In the blank beside the line "Number of Skill Choices:" place the number of skill choices the character has (four, plus Intelligence bonuses). He will get more as he gains in experience, as described earlier.

On the lines below that, record the skills you choose. For each one, record its name, the Ability on which it is based (and any permanent modifiers purchased by using extra skill choices), and its current skill roll.

Skills and the DM

It's the responsibility of the DM to see to it that the players don't abuse these skills, achieving results totally inappropriate to their use in the campaign. It's also the responsibility of the DM to reward characters who use their skills cleverly and in the context of the adventure. The DM decides when a character may try his skill roll, and the DM also decides what sort of effect the skill can have in this situation.

Example: A character confronts the Master of the city's Merchants' Guild and tries to use his Bargaining skill to persuade the man to sell

the party adventuring gear at one one-hundredth of actual worth. This is a blatantly ridiculous usage. The DM can have the merchant-lord chase the character and his friends out of town, or (at best) utterly ignore this idiotic request.

The DM shouldn't make the characters roll over and over again for the same task—only at critical points in play.

Example: After a night's sleep, the adventurers saddle up and mount their horses to ride onward toward glory. Don't make them roll their Riding now. Nor is there any reason to have the characters make their Riding rolls as they head up the road, mile after mile. But when bandits with trumpets and firecrackers come leaping out of the trees, then it's time to roll—these activities are likely to spook the horses.

Positive and Negative Modifiers

When the character is using a skill, the DM may wish to assign him positive or negative modifiers to make his roll easier or harder. These modifiers are based on current circumstances.

Circumstances which make a job slightly more difficult warrant a -1 or -2 modifier. Those which make the job substantially more difficult warrant a -3 or -4 modifier. Those which make the job very hard—such as blinding rainfalls, earthquakes, meteor showers, lack of materials, mass ignorance, or whatever—can warrant modifiers of -5 on to -10 or -15.

Conversely, circumstances which make the job easier—such as having all the materials needed, having lots of time or help, mass ignorance, or whatever—warrant positive modifiers at the same approximate scale.

The character always has a chance of success, however bad the odds, as long as the DM says it's remotely possible to succeed. A natural roll of 1 on 1d20 is an automatic success.

Time Use

When it's important to know, the DM decides how much time each use of a skill represents. The time it takes to look over a plot of ground and make a tracking roll might be about 30 seconds; the time it takes to make a superior crossbow will be several days to a few weeks; the time it takes to use a Geology science to recognize a type of stone may only be a second or two.

Using Skills Together

Often, when the character making his skill roll has failed, all the other characters with the same skill will chime in, "How about me? Let me make my skill roll!"

This isn't usually a good thing to do. If the DM lets everyone make a skill roll for the same task, someone will eventually succeed. The DM has to decide when several people can try a task or not, and then stick by his decision. However, sometimes it's reasonable for two or more characters to use their skills together to solve a task. For example, when two scholars are trying to translate an inscription, two heads may be better than one. The characters choose which of them is the chief problem-solver for this situation (usually the character with the highest skill roll), and that character and others with the same skill make their skill rolls. The DM uses the roll of the chief problem-solver and then gives him a +1 modifier for every one of his friends who made the roll, and a -1 modifier for every one who failed it.

Using Skills Against Each Other

Sometimes situations will come up where two skills are in conflict. A character with Deceive may try to fast-talk a character with Detect Deception, or two Bargaining characters may haggle. When the DM sees this situation occur, he will have both parties roll their appropriate skills. The character who makes his roll by the most wins the contest. When a tie-roll occurs, the DM has to analyze the situation; he may have them re-roll for a clear decision, or decide that the tie-roll means the situation is unchanged.

Other Uses for Skills

The DM must also allow or deny other uses for skills as he sees fit. For instance, a character with Bowyer skill should not be allowed to make free bows for everyone. The DM should rule that he can make them for as little as half the price they'd pay elsewhere, but the DM must insist that the character miss some adventures that his friends are performing (otherwise the weapons would never be made!).

The DM can also use these skills as "hooks" to get characters involved in adventures, especially if a character has a peculiar or outstanding skill. Nobles often hire master craftsmen to evaluate or restore their treasures, or to build grand new cities or citadels, all of which can lead the heroes into new and exciting adventures.

The Fighters of Thyatis



Thyatians love fighters—not just fighter-class characters, but anyone who's skilled in combat. They have many orders which fighters may join in order to further their careers, receive training, and hear about adventure opportunities. In this section, we'll talk about these fighting orders and optional fighting rules for Thyatian characters.

The Fighting Orders —

Brotherhood of the Grey Lady

Interests: The Brotherhood is the largest fighting order in the Empire. The Grey Lady is the Immortal Vanya, and the Brotherhood is devoted to increasing fighting ability and honor in Thyatis. It provides cheap lodging to members, trains warriors, and provides information about job opportunities.

Requirements: Characters joining the Brotherhood must be clerics, fighters, thieves, foresters, rakes, elves, dwarves, or halflings. Pure magic-users need not apply. Characters can be of any level. Women are accepted.

Annual Fee: 50 gp.

Benefits: *Cheap Lodging* in towns where there is a Hall of the Brotherhood (any town of 2,000+ in mainland Thyatis, any town of 5,000+ elsewhere in the Empire); rates are 2 sp/meal (it's a good, hearty meal), 3 sp/night's lodging for one person, 5 sp/night's stabling and oats for one horse. Credit for meals and lodging is extended to dependable members of the Order. Lodging is in a common barracks hall, male and female alike. *Fighter Training:* Every Gromdain and Nytdain evening, members gather at the local hall

for Fighter Training, an evening of instruction and socializing. At Fighter Training, new adventurers and new Order members can meet experienced ones, hear stories of old exploits and rumors of possible adventures and treasures, and so on.

Problems: The Brotherhood's benefits are very useful to low-level heroes, but are less so to wealthy and experienced ones.

Storm Soldiers

Interests: The Storm Soldiers are Hattian warriors and knights who fight for Hattian supremacy, racial purity, and suppression of women. They are a hate-society, especially powerful on the Island of Hattias.

Requirements: Members must be fighters (any alignment) or Neutral or Chaotic clerics of Vanya. Members are male humans. All members (except those in covert or spy roles) must wear black uniforms with the gold Storm Soldiers lightning-bolt insignias all the time.

Annual Fee: 100 gp.

Benefits: On the Island of Hattias, all members receive free lodging (just barge in on a peasant family and demand it) for themselves and their friends. In Thyatis City, members receive inexpensive lodging at the Storm Soldiers enclave (same costs as for Brotherhood of the Grey Lady). Across the Empire, members receive free legal aid (free advocates) for any crimes they may be charged with. All members receive a +4 to reactions from Hattians—they're lauded as heroes.

Problems: The Temple of Vanya doesn't allow its clerics to be Storm Soldiers, so clerics of Vanya who join this order do so secretly. Known Storm Soldiers receive a -2 reaction from Citizens of

the Empire who are not of Thyatian, Kerendan, or Hattian descent. Storm Soldiers who adventure sometimes receive orders to betray, steal from, or spy on their allies.

The Foresters

Interests: This order teaches trainees to wield both weapons and magic. Members of the order are all humans; women are accepted. To become a Forester is to join the order for life; if ever you resign, you also resign from your adopting elf-clan and your magical powers desert you (this leaves you a Fighter of the same experience level you possessed as a Forester). The Foresters are elf-friends and protectors of nature; they protect elf communities from harm and keep other species from destroying forests.

Requirements: All members of the Order must meet the basic requirements for becoming a Forester. Members must spend a minimum of three years (before their gaming careers start) training in Foreston and Greenheight. Members may be of any alignment, but a history of evil deeds will result in expulsion from the order (and loss of magical powers).

Annual Fee: None. Many Foresters voluntarily tithe 10% of their incomes to the city of Foreston.

Benefits: All members of the order have been adopted by one of the elf-clans of the Vyalia elves. The elves shelter their own from human authorities. Membership in the elf-clan allows the Forester to live among and as the elves; it often gives him access to elvish records and legends which most humans never get to see.

The Fighters of Thyatis

Problems: Not all dwarves dislike or distrust elves, but those who do also react badly to known Foresters—2 to reactions. Foresters are often pressured by outsiders to reveal secrets of the elves (magics, traditions, etc.); most reveal very little.

Sisterhood of the Sword

Interests: The Sisterhood of the Sword is a small order (with halls only in Thyatis City, Kerendas, Port Lucinius, Tel Akbir, the island of Mositius, Newkirk on the Isle of Dawn, and Seagirt on the Pearl Islands) dedicated to teaching the arts of war to women, especially those who have a tough time finding training.

Requirements: Members must be female fighters, thieves, or rakes, either human or halfling.

Annual Fee: 100 gp for normal membership; 500 gp for boarding membership.

Benefits: Membership gives the member free access to the daily fighter-training that goes on at order halls, which includes access to good instructors, and one daily meal. (Training won't allow a character to gain levels without adventuring; however, it's rational for a character reaching 1st level.) The order provides inexpensive lodging (2 gp/day for humans, including meals, 1 gp/day for stabling per horse) for members. Boarding Membership means that the member may board in any of the order's halls, moving from hall to hall as she chooses, at no cost, year-round or for any part of the year; this doesn't include the cost of stabling a horse.

Problems: Women of the order are not liked by Hattians or Ochaleans, who react to them at -3 and may harass them. The Storm Soldiers of Hattias have been known to promote secret attacks on Sisterhood parties.

Other Orders

There are many more orders in the Empire. If you can think of a new one suited to your character, work it up and submit it to your DM. You can determine the order's interests, requirements, and benefits; the DM is within his rights to modify these factors to suit the campaign, choose the order's problems, and determine the annual fees.

The Flying Orders

There are also two very specialized fighting orders in Thyatis, both based out of the Duchy of Retebius. They are the Retebius Air Fleet, an elite branch of the imperial army, and the Knights of the Air, an unaffiliated fighting order. These orders are notable because every member of each order trains and flies at least one airborne creature—pegasi, griffons, and so forth.

Retebius Air Fleet

The Duchy of Retebius is named for an Alphatian cleric who helped Thyatis in its struggle for independence a thousand years ago. He inflicted terrible damage on the Alphatians by flying on the back of a white dragon, using its breath weapons and his own magics against the fiendish flying boats the Alphatians used (and still use today). After the war was won, Retebius, with imperial funding (and the ducal title given to him by the emperor) founded the Retebius Aerial Corps, an elite squadron of fliers; the Aerial Corps eventually grew to several hundred warriors and changed its name to the Retebius Air Fleet.

Interests: The Air Fleet is dedicated to the airborne protection of Thyatis, augmentation of the Empire's military, and advancement of the study of aerial scientific knowledge. It provides a counter-threat to the Alphatians' flying boats, and is used for military reconnaissance.

Requirements: Members must be Thyatian Citizens of 5th experience level or greater. Members must join the Thyatian army (minimum six-year hitch) and go through a six-month officers' training course and flight training course. (Your DM may wish to compress this time in the campaign so that it takes very little game-time, or may wish to game out the grueling course and flight training.) Members must have or take two skills: Riding and Animal Trainer (for the beast which they are assigned). (If the character does not have the skills, then he will learn them during the six months' training . . . but this does use up his next two skill choices.)

Annual Fee: None. Once officers' training is through, characters will be lieutenants in the Thyatian army and will be paid by them, 100 gp/month.

Benefits: As officers of the army, characters receive room and board (for themselves, immediate family, and flying mounts) in addition to pay. Characters may buy their mounts when they leave the army, at the price of an

adult flying beast (given below). If a character's mount is killed, the Air Fleet assigns him a new one.

Problems: Characters belong to the army for at least six years and are bound to follow army orders and regulations. Treasure seized by Air Fleet characters belongs to the army. Characters get no choice in the kind of beast they are assigned; if a hero wants a roc and is instead given a pegasus, it's the pegasus he learns to ride. The Air Fleet deals harshly with officers suspected of abusing their mounts.

Knights of the Air

Eventually, former members of the Air Fleet, adventurers who already had flying mounts, and nobles just interested in the "sport" of training and flying monsters formed their own society, the Knights of the Air. There are some people working to opening the Knights up to the flyers of inanimate objects—brooms, flying carpets, etc., so information on those objects is presented in the chart below.

Interests: The Knights of the Air is a hobbyist society whose members enjoy the company of flying beasts and the sport of airborne travel, combat training, etc. It is also a militant order which rises to the defense of Thyatis in times of war.

Requirements: To be a member of the Knights of the Air, a hero must: (1) Own a flying beast; (2) Have the Riding and Animal Training skills appropriate to that type of beast; (3) Be of Lord status, or be at 9th experience level; and (4) Have sufficient funds to pay the annual fee and care for the flying beast.

Annual Fee: 500 gp.

Benefits: The primary benefits include membership in a high-prestige society, exposure to many nobles with similar interests, many adventure opportunities (people often come to the Knights of the Air to hire mercenary members for specific missions); some of the annual fees go to prizes to be awarded in flying competition (Most Agile, Fastest, non-lethal combat tournaments, etc.).

Problems: The expense of stabling, feeding and caring for these unusual monsters is the primary drawback of belonging to the Knights—or to owning a flying monster in any case.

Flyers: Costs and Characteristics

On the chart on the next page, you'll see the flying and upkeep characteristics of numerous flying beasts and items of magic.

FLYING MOUNTS CHART

Creature or Magic Item	Air-Speed (Feet per Round)	Maneuvering Factor and Takeoff	Hit Dice Young (gp)	Cost: (month)	Cost: Upkeep	Cost and Weight Multiplier for Gear and Armor	Carry (Cn Wt)
Dragon, blue				6,600			
" Baby	60	MF 5 (b)	6		60	x5	6,000
" Small	80	MF 3 (b)	9		90	x10	9,000
" Large	100	MF 1 (b)	13 + 3		130	x10	13,300
" Huge	120	MF 1 (b)	18		180	x20	18,000
Dragon, gold				11,750			
" Baby	60	MF 5 (b)	8		80	x10	8,000
" Small	80	MF 3 (b)	11		110	x10	11,000
" Large	100	MF 1 (b)	16 + 3		160	x20	16,300
" Huge	120	MF 1 (b)	22		220	x20	22,000
Dragon, white				4,300			
" Baby	60	MF 5 (b)	3		30	x2	3,000
" Small	80	MF 3 (b)	6		60	x5	6,000
" Large	100	MF 1 (b)	9		90	x10	9,000
" Huge	120	MF 1 (b)	12		120	x20	12,000
Drolem	80	MF 1/2 (b)	20	**	0	x20***	20,000
Flying							
" Broom	80	MF 3 (a)	n/a	**	0	x2***	4,000
" Carpet	100*	MF 1 (a)	n/a	**	0	x5***	6,000
" Spell	120	MF 3 (a)	n/a	**	0	n/a	2,000
Griffon	120	MF 1 (b)	7	450	70	x5	7,000
Hippogriff	120	MF 1 (b)	3 + 1	250	30	x2	3,100
Pegasus	160	MF 3 (b)	2 + 2	125	20	x1	3,300
Roc				6,250			
" Small	160	MF 1 (b)	6		60	x5	6,000
" Large	160	MF 1/2 (b)	12		120	x10	12,000
" Giant	160	MF 1/3 (b)	3466		360	x20	36,000
Sphinx	120	MF 1 (b)	12	5,625	120	x10	12,000

* These rates are figured for one human-sized flyer and gear (approximately 2,000 cn weight). For rates at higher weights, consult the Treasures section of your *Expert Rulebook*.

** These items have no "young form;" you must acquire them through adventuring or through the normal means in your campaign. You must make drolems as described in the *Dungeon Masters Companion*.

*** These items cannot wear armor, but can have saddle-blankets, saddlebags, bridles, etc.

(a) Mount magically floats straight into flight, no difficulty in takeoff; can hover without difficulty.

(b) Mount flaps wings to take off; can be hampered by tight quarters, stopped if wings bound or injured; can hover with difficulty (skill check at -3), prefers to circle.

Column Heading Notes

The *Air-Speed* line shows the mount's normal air-speed in feet per round. To get the mount's speed per turn, multiply by 3.

Maneuvering Factor determines how maneuverable the mount is while in the air. The higher the number, the more maneuverable the mount is. The GM has the aerial movement rules and will tell you all about the MF when you begin flying.

Takeoff determines how easy it is for the mount to launch into the air, as the footnotes at the bottom of the chart indicate.

Hit Dice is the mount's normal HD score. It is included here so that all the dragons' hit dice figures, which are normally scattered through several books, will be in one place.

Cost: Young (GP) tells how much money it costs to buy one of these mounts when it is in its infant

state—a griffon cub, a dragon egg. To train one of these beasts to ride, you must own it from its youth and train it yourself. Such beasts, trained by man, cannot learn spells; a gold dragon or a sphinx trained to be a riding-monster will never have the normal spells of its kind.

Cost: Upkeep (Month) is how much money it costs to keep the mount alive and healthy; the cost is paid monthly, and goes to feed and shelter the beast.

Cost and Weight Multiplier for Gear and Armor determines how much gear such as barding, saddle-blankets, saddle-bags, etc. cost. Buy barding from the *Master Players' Book* page 15, and normal equipment from the *Expert Rulebook* page 19, but subject their costs and encumbrance values to the multiplier given here.

Example: You wish to buy leather barding for your Large Roc. You see in the *Master Players' Book* that leather barding normally costs 40 gp and weighs 250 cn. The Large Roc has a multiplier of x10. Therefore, leather barding for a Large Roc costs 400 gp and weighs 2,500 cn. It weighs more because there's more bird to cover than horse; and costs more because it's custom-designed to protect as much of the bird as possible (head, breast, etc.) without interfering with its flight.

Carry (Cn Wt) shows how much weight the beast can carry on its back. A human being, plus equipment, is figured as 2,000 cn. Don't bother saying "My elf only weighs 100 pounds and carries very little gear." We're taking an average figure. If a beast can carry 2,000 cn weight, it can carry one character and a reasonable amount of personal equipment into the air.

The Fighters of Thyatis

Joining the Retebius Air Fleet

If characters wish to join the Retebius Air Fleet, they need only meet the specifications given earlier and sign on. Each new member rolls d100 against the following chart to see what sort of beast he will be assigned:

d100 Roll	Assigned Beast
01-50	Pegasus
51-75	Hippogriff
76-85	Griffon
86-95	Sphinx
96-97	White Dragon
98	Blue Dragon
99	Roc
00	Gold Dragon

In the Air Fleet, pegasi and hippogriffs are the standard cavalry. Griffons and sphinxes act as elite cavalry—the rangers of the air. The dragons are bringers of terror, long-distance fliers, and terrible fighters both in the air and on the ground. The rocs are the bomber command—loaded up with stones or kegs of flammable liquids which may be dropped on targets.

Joining the Knights of the Air

Joining the Knights of the Air is much easier; it merely involves meeting the membership requirements and paying the annual fees.

Raising Flying Beasts

To be able to fly such a beast as your own mount, you must raise it from youth. You must have an Animal Trainer skill. No one may train the animal for you, and the DM should not let a single character raise more than four animals at the same time.

A young animal starts out with one-third the hit dice of a mature one—minimum of 1 HD. Animals grow at the rate of 2 HD per year. (Thus, a beast that is normally 3 HD will be effectively full-grown after a year.) The roc is an exception; as a chick, it starts with one-sixth the HD of an adult roc.

During the animal's first year of growth, it may not be ridden—the trainer will be teaching it to fly (on a tether-rope) but the beast is too young to be mounted. When it is a full year old, it may begin carrying rider and passengers.

(To determine how much weight a flying beast can carry, multiply its hit dice by 1,000 cn—don't count any HD plusses.)

In the Retebius Air Fleet, the character doesn't have to pay for the beast's upkeep. In the Knights of the Air, the character owns his own beast and must pay for it, paying the monthly cost from the "Cost: Upkeep" line of the chart. If he fails to pay the amount, the animal is starving or unsheltered and could die or revert to the wild and fly away forever.

The animal is considered full-trained for flying duties at the age of two years, and it is at that point that campaigns which deal just with flying-corps adventures usually start.

The Record Sheet

Ask your DM for photocopies of the Flying Monster Record Sheet. When your character has had a flying beast assigned to him, you can write down all the beast's pertinent statistics and abilities on the sheet. Some of that information comes from the chart above; some comes from the normal "Monsters" sections of the D&D® rulebooks.

Also on the sheet is a maneuvering chart used when the beasts are being flown in combat. The rules for using that chart appear in the DM's book of this supplement.

The Rules of Flying

The full rules for riding flying animals in war and peace appear in *Book I*. For your information, we're presenting a short reprise of them here; ask your DM for further details. He may wish you to read the full rules from *Book I*.

(1) Flying beasts' movement rates per round were given in the chart under the label Air-Speed. A flying beast may fly each round at a speed up to (or less than) its full Air-Speed.

(2) Flying beasts may maneuver a number of times per round equal to their Maneuvering Factor (MF) score. A baby dragon can maneuver five times per round; a giant roc can maneuver one-third time per round (i.e., once per three rounds).

(3) Each maneuver may be a 30-degree or 60-degree sideways turn (bank), or a climb or a dive.

(4) Each beast must fly at least 10' between maneuvers.

(5) The first maneuver each round is "free"—safe. Subsequent maneuvers in the same round, or any dangerous maneuvers or circumstances, require the rider to make a Riding skill roll. Failure can lead to the beast making flying mistakes, or the pilot falling off, or many other possible results.

Those are the basic rules; the DM has the full set of rules, including those for falling from great heights and for beasts sustaining damage in aerial combat.

Special Equipment: The Bumber-Chute

Members of the Knights of the Air and Retebius Air Fleet need some specialized equipment for their own safety. First and foremost, it's a good idea for a flier to have some way to reach the ground safely if his flying beast is killed or if the flier is thrown from its back. Both the Air Fleet and the Knights of the Air manufacture one such magic item.

The Bumber-Chute. Cost: 500 gp. The Bumber-Chute looks like a large parasol and is worn on the flier's back, like a back-slung sword. If the flier is ever thrown out into the air, he need only pull the Bumber-Chute forth and press the button on its handle. The umbrella portion will open up and magically lower its wielder to the ground; the flier need only hold onto the handle for dear life.

When nearing the ground, the player-character rolls 1d20; on a 1, he takes 2d6 damage from a bad landing, but otherwise lands just fine. (If you're using the Falling Rates charts from *Book I*, the Bumber-Chute lowers people at a rate of 1,000 ft/minute or 166' / round, with a final bit of extra deceleration at the end; when the 1 is rolled, that last bit of deceleration fails to take effect.)

Bumber-Chutes are sold in a variety of colors and designs. They are not customarily sold to people outside the two orders.

More Special Equipment: Breathing Gear

Not many beasts can fly so high that humans can't breathe, but rocs and dragons can, and their pilots need to have special **Breathing Gear** if they're to survive.

The Gear fits in the front opening of an open-faced helmet or can be worn without a helmet. It looks like an oversized pair of goggles (which protects the pilot's eyes from cold high-altitude winds) attached to an elephant-like trunk which fits over the lower face. This leather object has been enchanted with a *create air* spell (see *Book III*) so that its wearer may breathe at any altitude where some air remains.

The Gear costs 3,000 gp.



Still More Special Equipment: Flying Beast Armor

We spoke earlier about armor for flying beasts. Here's how it is bought:

Beast Armor	Effect on AC	Basic Cost	Basic Enc.
Leather *	none	40	250
Scale *	-1 to AC	75	400
Chain	-2 to AC	150	600
Banded *	-3 to AC	400	1,500
Plate *	-4 to AC	500	3,000
Field *	-5 to AC	600	4,000
Joust *	-7 to AC	700	5,000

*: From the *Master Players' Book*

To purchase armor for your flying beast, select one of these armor types. Apply its "Effect on AC" to your beast's AC. (Example: A griffon, normally AC 5, wearing Chain barding would be AC 3.)

To figure the armor's cost and encumbrance, take the Basic Cost and Basic Enc figures given above and then multiply them by the "Cost and Weight Multiplier" figure from the Flying Monsters Chart presented earlier. (Example: Chainmail bought for a griffon starts at 150 gp and 600 Enc. The griffon's multiplier from the other chart is x5. The griffon's chainmail will cost 750 gp and weigh 3,000 Enc.)

Optional Armor and Damage Rules

Here, we're going to give you some optional rules which you may use in your campaign if your DM approves. These are *optional* rules, and they will change the way combat is handled in your campaign. It's best for you to learn these guidelines, play some combats with characters not actually appearing in the campaign, and then decide whether or not you and the DM want to use them. With this set of rules, the following general guidelines apply:

(1) You still roll 1d20 to determine whether or not you hit a target's Armor Class.

(2) Armor Class now is only determined by the character's shield, Dexterity bonus, and certain magic items; his body armor does not figure into the equation.

(3) Body Armor, instead of increasing a character's Armor Class, simply subtracts a certain amount of damage from the amount inflicted.

Refiguring Armor Class

To figure your character's Armor Class under these rules, do this:

(1) Start with AC 9. If a magical item confers a different starting AC, start with that number instead.

(2) Apply the bonus (or penalty) for his Dexterity.

(3) Apply the bonus for the shield he carries, from the following chart.

(4) Apply the bonus for any magical items or spells he is using.

The result is his AC. It's going to be lower than what it would be under the normal rules.

Shields

Here are several types of shields, of varying sizes, weights, and costs.

Optional Combat Rules:

New AC Values of Shields

SHIELD	AC	COST	ENC
Small Shield	-1	5	50
Medium Shield	-2	10	100
Large Shield	-3	15	200
Tower Shield	-4	25	300

Examples of small shields include the bucklers used in the European Renaissance, especially at the height of fencing. Medium shields include normal round shields (such as the Vikings' shields) and the medieval footmen's shield. Large shields include the kite shield of the medieval knight. The tower shield is a huge shield which protects from nose to ankle, and is best known from the *Iliad* and *Odyssey*.

The shield doesn't give its user any AC benefit against attacks from behind.

Armor Value

With these optional rules, armor doesn't increase your AC . . . it decreases the amount of damage that its wearer takes. The amount by which armor decreases the damage to its wearer is called its Armor Value (AV). When a character wearing armor is hit by an attack, one point of damage always gets through—from the impact or from penetration of the armor. Then, you deduct the AV from the damage from the rest of the attack. The AV is deducted from each separate attack.

The Fighters of Thyatis

AV doesn't lessen falling damage, or some sorts of magic, detailed under "Magic Spells," below.

ARMOR

Armor	Armor Value	Cost	Enc
Leather	2	20	200
Scale Mail *	3	30	300
Chain Mail	4	40	400
Banded Mail *	5	50	450
Plate Mail	6	60	500
Suit-Armor **	7	250	750

*: From *Players Companion*

** : From *Master Players' Book*

Example: Theodosius swings a sword at Lucian, who wears plate mail; he has an AC of 9 and an AV of 6. Theodosius hits, and does 8 points of damage with his sword. The first point of damage gets through. Lucian's AV of 6 takes off 6 points of damage. This leaves one more to get through. Theodosius has done Lucian 2 points of damage—after Armor.

BARDING

Horse armor follows the same pattern. Horses naturally have an AC of 7, so all horses you encounter will have an AC of 7 even with barding on. But, the barding will have an Armor Value.

Armor	Armor Value	Cost	Enc
Leather*	1	40	250
Scale*	2	75	400
Chain	3	150	600
Banded*	4	400	1,500
Plate*	5	500	3,000
Field*	6	600	4,000
Joust*	7	700	5,000

*: From the *Master Players' Book*

CRUSHING BLOWS

Any roll to hit which (with the natural roll plus modifiers) reaches a result of 20 is an automatic hit—if it's possible to hit the target at all. Also, if a natural (unmodified) roll to hit is an 18, and it hits the opponent, the weapon does its maximum possible damage—there's no need to roll. For instance, using a 1d8 broad sword, it automatically does 8 points of damage plus the character's Strength bonus.

If a natural (unmodified) roll to hit is a 19 and hits the opponent, the weapon does its

maximum possible damage—and bypasses armor entirely (caves it in, finds a gap, etc.). The AV does not apply against this attack.

If a natural (unmodified) roll to hit is a 20 and hits the opponent, it bypasses armor just like a roll of 19—and does twice the maximum amount of damage indicated for it. If you're using a normal 1d8 broad sword, it does 16 points of damage and two times your bonus from Strength.

MAGICAL ARMOR AND SHIELDS

The bonus from magical armor does not add to the Armor Value—it still adds to Armor Class. *Chainmail* +2 would provide an AC of 3 and an AV of 4.

Magical shields still add their bonus to the Armor Class. Also, their magical bonus is used as a plus to hit when rolling to Block (explained later in this section).

BOWS AND CROSSBOWS

Bows and crossbows have some special benefit against armor in these new rules—armor gets only half its damage-reducing value (round down) against bows and crossbows. Arrows and quarrels are very good at punching through armor.

So, if you're wearing banded mail (AV 5) and someone shoots an arrow at you, your armor acts as only AV 2 vs. that arrow.

FIGHTING ARMORED MONSTERS

If you use these variant rules, the DM may wish to re-interpret monsters and their ACs. Those which have high AC values because they're supposed to have thick armored hides, and those which can't be hit by non-enchanted weapons, should have their ACs changed.

Give a monster which is supposed to have a thick hide the Armor Value which corresponds to the AC it now has. If a monster has an AC of 5, corresponding to chainmail in the normal game, give it an AC of 9 (like normal humans) and a natural Armor Value of 4 (like chainmail in this system).

If a monster can't be damaged by non-enchanted weapons, that won't change; immunity is immunity.

If a monster appears to receive its high AC because of quickness and agility, then it keeps its old AC and receives little or no AV.

Magic Items

Magic items which, in the normal game, give the wearer improved ACs (like the *ring of protection*), still do exactly that in this system. They do not improve Armor Value.

Magic Spells

Some damaging combat spells are affected by Armor Value; some aren't. Damage from these spells is reduced by Armor Value: (Cleric) (3d) *striking*, (6th) *barrier*; (Magic-User) (1st) *magic missile*, (3rd) *fire ball*, (4th) *ice storm/wall*, *wall of fire*, (7th) *delayed blast fire ball*, *sword*, (9th) *meteor swarm*, *prismatic wall*.

Armor, as with normal attacks, lets the first point of damage through from any magical attack; even if it stops the rest of the attack.

Damage from these spells is *not* reduced by Armor Value:

(Cleric) (1st) *cure/cause light wounds*, (3d) *cureall*, (4th) *cure/cause serious wounds*, (5th) *finger of death*, *cure/cause critical wounds*, (7th) *holy word*, *raise dead fully/obliterate*, *restore/life drain*; (Magic-User) (3d) *lightning bolt*, (5th) *cloudkill*, (6th) *death spell*, *disintegrate*, (7th) *power word stun*, (8th) *explosive cloud*, *power word blind*, *rune*, (9th) *power word kill*, *heal*, *wish*; (Druid) (2d) *heat metal*, (3d) *call lightning*, (7th) *creeping doom*.

The spells of *shamans* and *wiccans* correspond to those of other magic-users and clerics, so use the guideline for the specific spell when a wicca or shaman is attacking.

The attacks of summoned monsters are usually affected by Armor Value, except when their attacks correspond to spells which bypass Armor Value.

Spells which improve a character's Armor Class, such as *shield*, still do exactly that; they don't grant an Armor Value.

What This Does to Your Campaign

If you use these rules:

(1) People will hit and be hit more often in combat. Armor Classes are lower, so hitting will be more common. This is good for lower-level characters; they'll be more useful in combat.

(2) Fights will take longer.

(3) Fighters, especially heavily armored ones, will be a little more competitive against monsters.

Variant Armor and the Orcs of Thar

If you're using GAZ10, *The Orcs of Thar*, and are using the special armor rules from that supplement, you can use them with these optional armor rules. There are two ways to do this, the Simple Way (so appropriate to humanoid characters) and the Complicated Way (which isn't that complicated).

The Simple Way

For your humanoid character with mismatched pieces of armor, calculate his Armor Class exactly as described in the GAZ10 *Players' Guide*, page 44.

Then, substitute the Armor Value equivalent for that Armor Class in this fashion:

AC 7 = AV 2
AC 6 = AV 3
AC 5 = AV 4
AC 4 = AV 5
AC 3 = AV 6

That's the Simple Way.

The Complicated Way

The complicated way is to wear the mismatched pieces of armor and receive the Armor Value of the types of armor the pieces are—but only on the parts of the body they protect.

When playing out combat, roll 1d20 and look up the result on the table below to find where the blow landed.

d20	Area Hit
1-2	Shield
3	Head
4	Torso
5-6	Shoulder *
7-8	Upper Arm *
9	Elbow *
10-11	Lower Arm *
12	Hand *
13-14	Waist & Back End
15-16	Upper Leg *
17	Knee *
18-19	Lower Leg *
20	Foot *

* Roll 1d6. 1-3 = left, 4-6 = right.

Each piece of mismatched armor would have the Armor Value of the kind of armor it came from. Here's an example of how this works.

Example: Urgham the Orc, from the example in GAZ 10, has a chain mail head gear,

one shoulder plate, and two leather arm pieces. That means he has Chain (AV 4) on location 3, Plate (AV 6) on location 5-6 (let's presume it's his right shoulder), and Leather (AV 2) on two arm locations—let's say his 10-11 on both arms.

Urgham plows his way up to Sir Glistenodosian and pounds on the knight's steely surface for about half an hour. Finally, the knight replies. He swings his sword, and hits. He rolls a location on d20, and rolls a 5—shoulder. He rolls 1d6 to see which shoulder and comes up a 4—right shoulder. Urgham is heavily armored on his right shoulder, and so gets to use his AV of 6 against the damage from Glistenodosian's sword. Sir G. rolls 12 points of damage. The first one gets through automatically; the next 6 are stopped by Urgham's sturdy shoulder piece; the remaining 5 get through. Urgham has taken 6 points of damage instead of 12. He celebrates; he cheers. But since he had only 5 hp to begin with, he dies.

Optional Fighting Rules

Combat Maneuvers

The *Players Companion* book introduced some Fighter Combat Options (page 18) but limited them to fighters of paladin, knight, or avenger status—i.e., Name level of experience. Well, you and your DM might allow options similar to those to anyone trained in combat—all the way down to 1st level. It makes combat more exciting and versatile.

The Maneuvers

With these rules, characters in unarmed or melee combat can use one of four different maneuvers per attack. These maneuvers are called Strike, Parry, Dodge, and Disarm.

Strike: This is the combat maneuver you've known for years. With your hand or whatever weapon is in it, you whack your opponent.

Parry: With this maneuver, you block the incoming attack (though you can't parry a missile attack). To Parry, you roll to hit normally. But if your roll indicates a hit, you have Parried: You have intercepted his attack with your weapon or shield; no damage is done. (An unarmed man may block another unarmed man's attack normally; an unarmed man may also block an armed man's attack, by getting his hand in the way of the weapon hand but not the weapon, but the parrying character is at -4 to hit.)

Dodge: When a fighter takes this combat option, he does not attack at all—he just tries to dodge the attack coming his way. His AC goes up by 5 against the one attack he names that he is trying to elude. His AC goes up by 3 against any other attack which comes in that he is aware of. His AC goes up by 1 against any other attack which comes in that he is not aware of. This AC bonus lasts until the end of the round; at the beginning of the next round, it is no longer in effect.

Disarm: This maneuver may only be used against an opponent using a one-handed weapon. Natural claws may not be disarmed. Two-handed weapons may be disarmed, but they don't go flying—one hand still holds onto the weapon, and the wielder must merely steady the weapon again.

To Disarm, the attacker makes a normal to-hit roll. If he hits, the victim must make a 1d20 roll. He subtracts his own Dexterity bonuses and adds the attacker's Dexterity bonuses to the roll. If the result is greater than the victim's Dexterity score, the victim has been Disarmed.

Example: Anaxibius, Dexterity 18, tries to Disarm Alexandros, who is Dexterity 12. Anaxibius rolls to hit, and hits. Alexandros must now roll 1d20. He rolls a 10. He subtracts his own Dexterity bonus (0) from the roll; he adds Anaxibius' Dexterity bonus (3) to the roll. The result, 13, exceeds his Dexterity. He drops his sword.

When retrieving a Disarmed weapon, a character must Retreat (as defined in the D&D® Basic Set) to do so. Should the weapon have fallen into a pit or been picked up by someone else, it cannot be retrieved so easily.

Changes to the Combat Sequence

If you use these maneuvers, you have to make a minor change to the Combat Sequence.

In the "Choose Targets" phase of the Combat Sequence, the side or character with initiative chooses his target—and, at that time, names his maneuver. Also at that time, his target, if he is aware of the attack, and if he has not yet gone that round, may decide to take the Dodge or Block maneuver. If the target has already gone that round, he may not choose to Dodge or Block.

The attacker makes his attack ("Make Hit Rolls; Roll Damage For Hits"). If the defender chose the Dodge maneuver, his AC is altered against that attack; if he chose the Block maneuver, he may try to Block that attack.

The Fighters of Thyatis

Multiple Attacks

If you're using *Companion* rules, your characters will have Multiple Attacks at higher experience levels.

If you want to use Multiple Attacks with the optional maneuver rules in this chapter, make the following modifications to the Multiple Attacks rules.

When you're using the Multiple Attacks rule with these optional maneuver rules, the character gets his Multiple Attacks every round—regardless of whether he can hit his opponent on a roll of 2 or not. A character with four attacks in a round could, theoretically, choose four Strike maneuvers (concentrating them on one opponent or dividing them among several), or do two Strikes and two Disarms, or do one Strike, one Disarm, one Dodge and one Block—there are many combinations open to him.

Other Companion Maneuvers

The Smash maneuver, from the same section in the *Players Companion*, really *should* be left to Name-level fighters. The Parry can be used by anyone.

Gladiatorial Combat

Gladiatorial Combat is a style of duelling, often involving exotic weapons, designed for showmanship. That doesn't make it any less deadly than normal fighting. Gladiators in Thyatis typically use one of the following weapons or weapons combinations at a time:

- Broad sword and shield
- Short sword and shield
- Net and trident
- Net and short sword
- Broad sword and whip
- Two cesti
- Two short swords
- Two broad swords
- Spear
- Halberd
- Pole axe

Horned shields, knife shields, sword shields, and tusked shields may be substituted for normal shields in any of the weapon combinations using shields.

Other weapons are occasionally used. A convicted criminal may be given a knife when released to fight a lion. A dwarf-gladiator may prefer an axe.

The two opponents don't have to have the same sets of weapons. Duels often have opponents armed with different weapon sets—

or facing off against wild animals and monsters.

Short swords, spears, broad swords (aka normal swords), and shields appear in the *Basic Set Players Manual*. The net, whip, and trident are added in the *Players Companion*. Halberd and pole axe are added in the *Master Players' Book*, and that book adds information on all the other weapons as well. We'll discuss cesti and two-handed technique in this section.

The Cestus

The cestus (plural: cesti) is a sort of thong or glove wrapped around the hand; it has rough, cutting edges on the back, so that a punching attack will inflict more damage on an opponent. In D&D® game terms, the cestus is a 1d3 (1-3) weapon, with strength bonuses adding damage normally to the weapon.

Using the additional information from the *Master Players' Book*, the cestus looks like this:

CESTUS	BS 1-3	—No minus/offhand
(P=H)	SK 1d4+1	
✦+⊕	EX 2-8	
CST: 5 gp	MS 2d4+1	
ENC: 10 cn	GM 3d4	

Two-Handed Technique

Gladiators often use a two-handed weapon or use a weapon in either hand. A fighter with a weapon in each hand must tell the DM which weapon is where—one will be in his good hand and one in his off-hand. If you're right-handed, then your right hand is your good hand. You can't just choose to be ambidextrous and not have an off-hand . . . though you could, with DM permission, spend two Skill Choices (from the General Skills section) to be ambidextrous.

The shield, net, and cestus may be used normally in the off-hand, but all other weapons used in the off-hand suffer a -4 penalty to hit. Two-weapon style is still good; if you're Disarmed, you still have a weapon. Also, you may Block or Parry with an off-hand weapon at no penalty.

When you reach a high-enough level to have two attacks per round, your off-hand minus disappears. You cannot then trade back the Skill Choices you used to become ambidextrous.

Carrying two weapons, one in either hand, doesn't mean that you can make two attacks in a round—only a high enough experience level will let you do that.

Non-Lethal Combat

If characters want to fight to see who's the best swordsman, but don't really want to injure one another seriously, or if they're trying to knock out an enemy without killing it, you can have them use Non-Lethal Combat rules. Under these rules, characters roll to hit and for damage normally. But take one-fourth the damage done (round down): That's the normal damage done by the attack. The remainder is also applied to the enemy's hit points, but should be recorded in a separate column; it's referred to as Non-Lethal Damage.

When the Normal Damage plus the Non-Lethal Damage equals the enemy's hit points, the enemy is unconscious. In 2d6x10 minutes, he'll recover half the lost Non-Lethal Damage, and wake up. An equal amount of time later, he'll recover the rest of his Non-Lethal Damage.

To use Non-Lethal Combat, an attacker may use:

- (1) Unarmed Combat.
- (2) A weapon designed to do Non-Lethal Damage—such as a wooden practice sword. You can automatically count shields (except spike-bearing shields), clubs and the like as weapons designed to do Non-Lethal Damage. A weapon designed to do Non-Lethal Damage does exactly the same amount of damage as the weapon it represents—but it can't be used to do normal damage.
- (3) Any non-missile weapon. (You can design special missile ammunition to do Non-Lethal Damage.)

If you're using Unarmed Combat or a weapon specially designed for Non-Lethal Damage, you fight with no penalty. If you're trying to use a normal weapon to do Non-Lethal Damage, you suffer a -3 to hit every time you try to do so.

Non-Lethal Damage makes it easier to conduct duels, capture enemies, and stop people without killing them. ★

That brings us to the end of the *Players' Guide to Thyatis*. You know enough to build a character from any of Thyatis' many reaches . . . and the DM, once he is through reading Book I, should know enough to be able to run a campaign set in those same lands.

DUNGEONS & DRAGONS®
GAZETTEER

**BOOK TWO:
Player's Guide to Thyatis**

by AARON ALLSTON

Welcome, adventurer, to the Empire of Thyatis.

If you are a fighter, you will be welcomed with open arms. You will be given opportunities for self-improvement that others will never see.

If you are anything else—well, try to stay out of the way.

In this booklet, players find all the information their characters need to survive in the Empire of Thyatis. They are introduced to important personages of the realm; they receive a detailed overview of the political, geographical, social, and economic state of the lands comprising the great military empire.

One entire chapter is devoted to the Fighters of Thyatis, so that players (with their DM's aid) can create likely candidates for success in the gladiatorial arenas.

Open this book, then, and learn of the mighty Empire of Thyatis!



TSR, Inc.
PRODUCTS OF YOUR IMAGINATION™

DUNGEONS & DRAGONS®

GAZETTEER

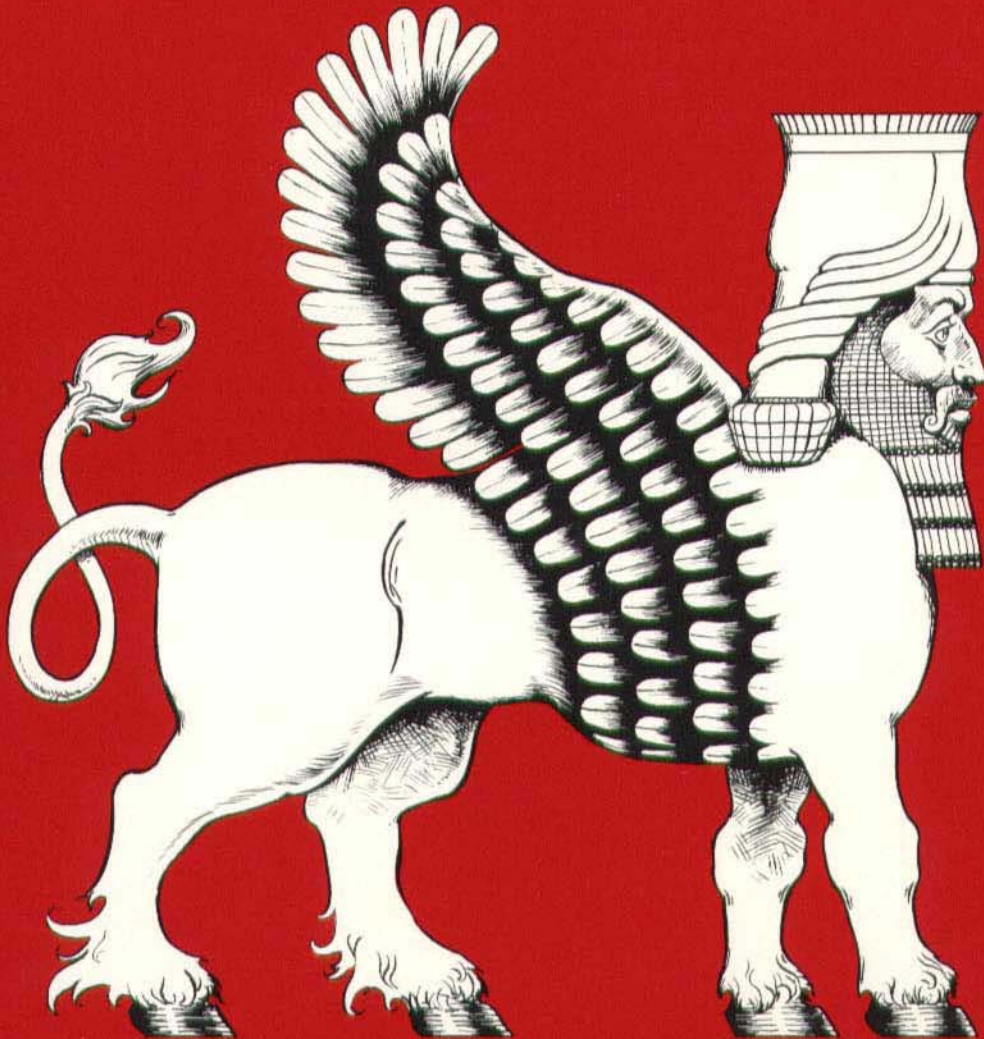

BOOK THREE:
Player's Guide to Alphatia
by Aaron Allston

GAZETTEER

An Official DUNGEONS & DRAGONS® Game Supplement

DAWN OF THE EMPERORS

by Aaron Allston

Table of Contents

BOOK THREE: THE PLAYERS' GUIDE TO ALPHATIA

Introduction	2	Dress	14
History of Alphatia	4	Weapons and Armor	14
Dawn of the Alphasians	4	Alphasians and the Immortals	15
The Time of Air and Fire	4	Food and Drink	15
Alphaks' Folly	5	Entertainments	15
The Year of the Scouring	5	Classes of Society	16
Landfall, and Other Survivals	5	Education	18
The New Alphasian Empire	5	The Law	18
The First 500 Years	6	Organizations	19
The First Decline	6	Economy	19
The First Alphasian/Thyatian War	6	The Calendar	19
Years of Rebuilding	7	Character Creation	21
Modern Times	7	Races and Character Classes	21
The Last Half-Century	7	New Magic-User Spells	21
Overview of Alphatia	9	Races	25
The Continent of Alphatia	9	Family	25
Subject Territories	10	Names	25
Alphasian Society and Politics	13	Languages	25
National Character	13	General Skills	26
Races	13	Magic-users of Alphatia	27
The Sexes	14	Making Magic Items	27
Age	14	Making Big Magic Items	30

Credits:

Design: Aaron Allston
Additional Material: Mark Bennett
Editing: Karen S. Boomgarden
Product Manager: Bruce Heard
Cover Artist: Clyde Caldwell
Interior Artist: Stephen Fabian
Cartography: Dave Sutherland

©1989 TSR, Inc. All Rights Reserved. Printed in U.S.A.

DUNGEONS & DRAGONS, D&D, ADVANCED DUNGEONS & DRAGONS, AD&D, and WORLD OF GREYHAWK are registered trademarks owned by TSR, Inc.

PRODUCTS OF YOUR IMAGINATION, BATTLESYSTEM, FORGOTTEN REALMS, and the TSR logo are trademarks owned by TSR, Inc.

Distributed to the book trade in the United States by Random House, Inc., and in Canada by Random House of Canada, Ltd. Distributed to the toy and hobby trade by regional distributors. Distributed in the United Kingdom by TSR Ltd.

This module is protected under the copyright laws of the United States of America. Any reproduction or other unauthorized use of the written material or artwork herein is prohibited without the express written permission of TSR, Inc.
1037XXX1903

TSR, Inc.
POB 756
Lake Geneva,
WI 53147 USA



TSR Ltd.
120 Church End, Cherry Hinton
Cambridge CB1 3LB
England

Introduction



What Everyone Knows About Alphatia

From the Correspondence of an Ierendian Traveler

"The most frightening thing about Alphatia is that everything said of that land is true . . . somewhere. I've spent years as envoy to the court in Sundsvall, I've traveled all over their Empire, and I've seen things I can barely describe.

"Yes, you're nothing in that land unless you possess magical knowledge. However, even the faintest of magical powers is enough to make you a nobleman there—thank the Immortals for my own poor skill with the arts! So all their rulers and great heroes are magic-users, and a few clerics and elves—all others are a mere step above slaves.

"There are two sets of laws, one for nobles and one for those with no magic. You can imagine which is the more humane . . . They treat their slaves as we treat our convicts, and treat their freemen as we treat our slaves. They are often a cruel people.

"Yet, they are very creative and artistic. The things they make with magic stagger the imagination. It is one thing to describe to you item after item, ship after ship, palace after palace so created, with all their fantastic colors and diversions and special functions—and yet another thing to see so many thousands of them laid in side-by-side like a mosaic across the city of Sundsvall. It must be seen to be believed.

"As for the darker stories . . . such things are not common. However, in a land as lawless as this (lawless, that is, for the ruling class), you will find magicians who will practice every sort of evil, from the summoning of ancient horrors to the creation of macabre creatures. Any nobleman with whom you dine and chat in light-hearted merriment today might tomorrow fly away to his hidden palace in the depths of the Blackheart forest and practice the most grisly sort of magical experimentation. The furtherment of magical knowledge is their only concern—justice and goodness, especially toward those who wield no magic, are not important to them . . ."

What Everyone Knows About Alphatia

Memoirs of Ecatrina, a Karameikan Thief

"We'd been two months in Alphatian lands after the shipwreck when we finally got the opportunity to get back to civilization.

"We'd already lost Joram. He'd insulted a seedy-looking gent in a tavern and the man had blasted him clean dead—a master wizard in disguise. There are a lot of them there. The local court let the man off with a fine, a hundred pieces of gold paid to the rest of us . . . that for murder. The rest of us kept a low profile after that.

"Finally, though, word got around that a crew of highly-trained specialists—us—was in need of work, and we got it, a commission from another wizard. Seems a local necromancer traveled a lot by one of those Alphatian flying boats. He had two important things: An ancient book our patron wanted, and some sort of device that would *detect magic* all the time. Meaning that our patron couldn't just use his own powers to get aboard and get his book; the other would detect and kill him. Our patron gave us the ship's travel plans, and asked us how we planned to do it; as deferentially as we could, we told him those were trade secrets. We didn't want to let those magical aristocrats know more than they had to know.

"Bomblin, our dwarf craftsman, rigged an arbalest so that it would launch special grapnels. The night of the raid, we all divested ourselves of every piece of magical equipment we had—and that was a sacrifice!—and, dressed all in black, made our way out to a place where the necromancer's ship would be passing.

"When it did pass, Bomblin fired his grapnel and hooked his line to the ship's anchor. We all got into position and let that flying ship take us right into the air—and a mad flight that was, too.

"Once we got aboard, the rest of the mission was a cinch. We slithered and sneaked our way through, had to knock only one guard over the head, and we made away with the book, the crystal ball that detected magic, and a fair horde of gold, too. Bomblin rigged a slip-line by

which we could lower ourselves back to the ground and bring the rope after us, and on a beach not two days' walk from our starting-point we found ourselves on the ground again. The necromancer slept through the whole thing.

"These people have hold of some ghastly magic . . . but because everything here depends on it, they underestimate pure intelligence, skill, and muscle. Something to keep in mind.

"We turned over the book, got paid for it, sold the crystal ball on the black market, got paid for that too, and—instead of booking passage out of this hellish land—we bought our own ship, with an eye toward doing some pirating on the way home . . ."

Alphatia First-Hand —

The young woman gave an irritated toss of her head and shoved away the letters and journals she'd been reading. She glared at the elderly man across the table, and he glared back. They'd been doing that a lot lately.

The woman belligerently flipped back her tumbling mass of red-brown hair and set her jaw. "I *don't* see why I have to learn all this extra foolishness. I don't *care* about 'foreigners' perceptions of Alphatia." I just want to learn to cast magic. Princess Asteriela said I could. But as if magical instruction weren't enough, you want to give me all this extra work. I am a Lady of the Court, and I am not accustomed—"

At that, the man broke out in laughter, his frame and his gray-spotted beard shaking in amusement. The woman ceased her tirade and glowered as he laughed.

Finally, wiping at the tears of laughter in his eyes, the man straightened himself up. Grinning with malicious amusement, he turned his attention back to the young woman. "Let us understand one another," he said with forced pleasantness. "Back in Thyatis, where you were a high-born lady-in-waiting to Princess Asteriela, you might have been a Lady of the Court. That's true enough.

"But here, in Alphatian lands, do you know what you are?" His expression turned serious, unfriendly. "You are the spittle on the sidewalk. You do not rule any person or any land. You do not know the ways of magic. You serve another. This makes you a servant by rank—you rate barely ahead of a slave, for all the Princess lets you dress nicely.

"Now, Asteriela has said you may learn magic. If you are an apt pupil, you may graduate from your degraded position to that of Aristocrat. If you are not an apt pupil—and that is *my* determination to make—you may remain a drudge until the end of your days."

The woman, shocked, struggled to reply, but he waved her silent. "No, I shall continue. Two years ago, the forces of Thincol of Thyatis captured young Prince Tredorian, youngest and least son of our Empress Eriadne, in Norwold. Eriadne, naturally enough, demanded her child back or there would be bloodshed. Instead, Thincol sent his own daughter, your Princess Asteriela, to be a hostage here while Tredorian remained in Thyatis. This shows how much your Emperor Thincol knows—Tredorian was hopeless with magic, while Asteriela is a natural at it; by far, we got the best of the deal.

"And so, Asteriela eventually sent for you, Galatia, her favorite Thyatian servant—"

"But I'm Alphatian," Galatia whispered, miserable under the man's barrage of contempt.

"Born on the Isle of Dawn, so you have good Alphatian bloodlines, true," the man conceded; he indicated Galatia's coppery skin and lustrous brown hair, much like his own had been when he was young. "But you've been reared as a Thyatian, and you, like them, have this foolish notion that birth-rank and unearned titles granted by politicians count for something."

Abruptly he rose and stepped to the room's one window, which was covered by a large velvet drapery. With a dramatic, sweeping gesture he pulled the velvet aside, uncovering the huge window—a single piece of thick, flawless lead crystal—and what lay beyond it. "Look upon Sundsvall, the city built of magic!" he cried.

Light streamed into the room, with the panorama that was the great city of Alphas. For as far as the eye could see, towers and keeps, castles and palaces, villas and manors—dwellings that seemed better-suited to locations far out in the wilderness, surrounded by farmlands or forests or mountain slopes—clustered thickly, separated by wavy, meandering streets. Each great dwelling was brilliantly colored, so the city-scape held a startling profusion of hues.

As Galatia watched, the prow of a flying vessel hove into view, floating majestically past this tenth-floor picture window, slowly and elegantly descending from its aerial path to the waiting berth in the imperial grounds below. Its sails flapped with a magical breeze

never felt by an oceangoing vessel, and passengers clustered at the rails, pointing and marvelling at the many sights of Sundsvall as seen from the air.

A figure rose from the ground to meet the craft—Prince Zandor, likely heir to the throne of all Alphatia, on the saddled back of his favorite griffon-steed, circled the descending ship and waved to those on its deck. With a wave of his hand and a spoken word of power, he ringed the ship with a translucent belt of rainbow colors, and the passengers cheered at his artistry.

Galatia's graybeard teacher drew the drapery home with an irritated snap of his wrist. But when the old man turned and spoke again, his voice was almost gentle. "This is not Thyatis," he said. "This is not any land you know. Learn its ways and you may have more power than you have ever conceived. Fail—or annoy those who would help you—and the best you can hope for, the most merciful fate, is to serve those who have power, to serve and drudge until the miserable end of your miserable life."

The young woman did not respond. The graybeard could see that she was cowed, but she did not burst into tears and wail at his manner, nor did she reject his words with unthinking denials. She just held her tongue.

He nodded, satisfied, and continued in a low tone. "We will begin today with history, the most ancient history preserved in our records . . ."

History of Alphatia



"The True History of our beloved empire," the graybeard began, "is not always a happy one. Accompanying our great achievements is a chronicle of disaster, treachery, and struggles for power.

"Much of this history is well-documented. Just as much, though, is merest legend, or genuine history warped by generations of change and incomprehension. What I tell you today is the true history of the Empire—as true as we can determine."

Dawn of the Alphatians

Millennia ago, on a far-distant world called Alphatia, the original Alphatians (a human race) achieved an unparalleled level of civilization and magical comprehension. The power they wielded as a race rivaled that of some Immortals. Manipulation of magic fed them, clothed them, and sheltered them.

These Alphatians looked different from the everyday Alphatians of today. You see their likeness in what we call "pure" Alphatians: Pale of skin, black of hair, light of eye.

Almost every representative of the race wielded magic. The rest, those few children born without the gift of magic, were trained to use their physical gifts at the utmost level of achievement.

The Alphatians built an empire on their world, subjugating other races. The greatest of these subject races was that of the Cypris, men with copper skin and brown or red hair. The Alphatians may have conquered the

Cypris—but eventually absorbed their culture and the race became more Cypric than Alphatian. The Alphatians who exhibit traits of the original pale-skinned race are now few and far-between.

The combined Cypri-Alphatians conquered their world and then extended their empire to other worlds near them. Conquest was invigorating; it affirmed their superiority over every other race; it was their right, or so they believed.

Not needing to work, except for occasional applications of magic, they grew soft and decadent. Great proportions of the population became addicted to the zzonga-fruit, which could reduce a mighty mage to tranquilized contentment for days at a time. As more of the populace became addicted to zzonga, the remaining mages had to work harder to hold the empire together and grew resentful of their zzonga-drugged colleagues. Distant colonies broke away from mother rule as the Alphatians' hold slackened.

And the Alphatians argued, squabbled, fought and warred among themselves. In a race where more than half of the population could, by modern standards, be counted as scholars, the scholarly feuds were centuries-long and centuries-bitter. Different philosophies were developed, accepted by many and opposed by just as many. Between the great families and churches of the Alphatians, bloody feuds and even all-out wars were sometimes fought on the most ridiculous of pretexts.

The Time of Air and Fire

Just over 2,000 years ago, Year -200 (Thyatians would say BC 1200) two schools of magic began a quarrel which was to end the first Alphatian empire.

The Most Righteous College of Aerial Splendor (today called the Followers of Air) was a sect devoted to the studies of the Plane of Air and aerial magic. The Air Wizards accomplished miraculous feats with their air magic—such as summoning a great bubble of breathable air to surround the Alphatians' solar system.

The Universal Truth of Fiery Dominion, a rival sect (today called the Followers of Flame), held that the Plane of Fire was the source of all power and wisdom, and that the Air followers were merely, ahem, full of hot air. But the Followers of Flame were hot-tempered and tended to destroy what got in their way.

The two sects had numerous fights and duels. These duels became popular public spectacles; the Alphatians, long bored by the administrative work needed to hold an empire together, and dulled into laziness and complacency by zzonga addiction, grew very interested in these clashes. New students and combatants were drawn by the thousands to these two enemy sects.

A neutral scholar, trying to route some of this hostility into more constructive ends, put forth a simple academic question: "Which is more powerful in our dimension—Air or Fire? If Air, why can Fire's smoke poison it? And if Fire, why does lack of Air smother it?" He invited

scholars of both sects to put forward essays arguing both sides of this query.

The leading debators of both sects eagerly embraced this argument and spent an incredible amount of time and energy writing their debates. The neutral judge took the best of their essays, assembled them, and published them. And if a great amount of work and genius had been lavished on a pointless argument, at least people were not perishing because of these sects' disagreements.

Alphaks' Folly

With this stage set, however, one man destroyed Alphatian civilization with just the stroke of a pen. Alphaks I was the emperor of the Alphatians. Highly intelligent, immensely powerful, prone to brilliant insights and childish tantrums, he had sat the throne of Alphatia during all the time this conflict had been going on, lending support to neither side, for he was wise enough to know that this could lead to ruinous war. Considering that he, himself, was a follower of Fire, he acted in a remarkably intelligent and disciplined fashion . . . for a while.

But now, with the conflict limited to the fields of academia (and therefore safe), he thought he'd put in his own opinion. He read the book of essays with as much interest and amusement as any other Alphatian, and then, with the powers given to the Alphatian emperor, signed into law a proclamation that the Universal Truth of Fiery Dominion, with their superior arguments, had won the debate, now and for all time.

The result on the part of the Air college was outrage. Radical elements of that sect went on a rampage through the Fire sect's university grounds and summoned mighty winds to blow buildings away. Alphaks, irritated, then signed another proclamation—outlawing the Air sect. Meanwhile, followers of the Fire sect made bloody reprisals on the Air magicians; the bloodiest of these Fire murderers made public their deeds, to the cheers of the followers, and Alphaks did not punish them.

The Year of the Scouring

More reprisals followed, from both sects, and suddenly Alphatia was caught up in civil war. The Fire followers, led by Alphaks, fought the Air followers in a war so terrible that it has gone down in legend as apocalypse. It ravaged the world, destroyed everything that was beautiful, killed the best of all the noble families, scoured the empire's satellite worlds. Millions perished.

And Alphaks, to his eternal regret, discovered which was the more powerful of the two sects—that of Air. More experienced, not as prone to fiery passions and fatal mistakes, the Air Wizards gradually eroded the might of the Fire Wizards, destroying their forces, battering them back to the citadels of Alphatia's capital.

Knowing their world was ruined, and could never again be the thing of beauty it once was, the surviving leaders of the Air Wizards sought out another world to live upon—and found a planet where Air was natural to the world.

Meanwhile, the Fire Wizards decided to try to make peace. They rose against Alphaks, banished him, and made overtures of peace to the Air Wizards. But the Air Wizards, bitter at the destruction of their families and their world, rejected the offer. Pouring their power into a single spell of destruction, evoking a huge windstorm that would cover the whole planet for years and smash it into numberless pieces, they fled, leaving Alphaks and the remaining Fire Wizards to perish.

Landfall, and Other Survivals

These Alphatians came to this new world, and that event is called Landfall—the Alphatian calendar is dated from Landfall, which is Year 0. The Alphatians slowly began to make this world fit for living.

Though it was not known at the time, many of the Fire Wizards survived, too. Though they had once presumed themselves nearly equal with the Immortals, some of them returned to their faiths before their world died. The Immortals intervened on their behalf and told them that their race would not perish . . . but that these Followers of Fire must wander the outer planes until all those who were alive in the time of the War of Air and Fire had perished or left their own kind.

Since so many of these survivors were long-lived wizards, this took a long, long time. It was 1,400 years before the survivors from Alphaks' time had died or departed, and their descendants, who called themselves the Flaems, were pure of Alphaks' taint.

The Immortals then directed the Flaems to a new world to rebuild their society. They came to the same world as their opponents, settling in the region that would one day be called Glantri, forming houses such as the Vlaardoens.

The New Alphatian Empire

While the surviving Followers of Fire were wandering the outer planes, the Followers of Air were settling on this world, on a continent which most reminded them of their former world. The Alphatians concluded that this planet had shifted the axis of its rotation no more than two thousand years before, and within the last two or three hundred years the ice had receded from this fair island—and no new human settlements of any consequence had been established here in the meantime. (Oh, there were some human settlements—quickly conquered, their populations absorbed into the new Empire as slaves.)

But the Alphatians were not as mighty on this world as they had been on their own. So many of their great artifacts had been used up, and so many of their great wizards had perished during the war that magical knowledge was not what it once had been; also, the very nature of magic was different, and mages found that they had to relearn their concepts of magic and its use.

That's not to say that it wasn't sufficient to make them masters of their world. They effortlessly dominated their island, which they named Alphatia, and began building cities and subjugating other human realms.

But their lack of magical power (compared to their strength on their own world) forced them to make certain concessions. Magic could no longer feed a nation, so agriculture became important; now, farmers raised crops and were aided by, instead of supplanted by, the wizards. Magic was no longer sufficient to raise every brick of every city; humans built the city walls and most of the buildings, and magic raised only the palaces and towers of the wizards themselves. Magic alone couldn't bring the Alphatians all the riches they wanted . . . so they conquered other peoples and forced them to send tribute.

History of Alphatia

The First 500 Years — The Grand Council of Alphatia

Soon after the Alphatians' arrival on this world, the leader of the Followers of Air, by name Kerothar, and the remaining few score master wizards convened. Most agreed that Kerothar should be the first emperor of the new Alphatia; most also agreed that he should *not* have the authority that Alphaks and his predecessors had. From this meeting, and those which followed, emerged the fashion of government found in Alphatia today.

The Empire is led by a single person, an Emperor or Empress. The title is hereditary, passing from parent to the child he or she names, so long as the Grand Council agrees.

The Grand Council is the other ruling body. Every user of magic who achieves ultimate mastery (36th level) can be on the Council—though not every one is, because the number of Counselors is limited to 1,000.

Fragmentation of Belief —

Inevitably, as magic-users began to study new fields of spellcasting, some left the faith of the Followers of Air. Some wizards, who had had beliefs of the Followers of Flame secretly handed down to them, began studying fire once more. Contact with the Immortals native to this world convinced many wizards to study and observe the philosophies of those mighty beings. Within a generation or two, there was no longer any single philosophy to which all the Alphatians could rally.

On the other hand, the destruction of the First Empire was still fresh in the minds of many. Thus wars between faiths and sects were very uncommon. Alphatian society developed strict rules for the settlement of arguments—in court, and in rigidly controlled duels and private wars. Those who broke the rules to settle arguments were terribly punished by the Emperor and Council.

The end result has been that this specialization of study and interest has broadened the knowledge of the Alphatians. Scholastic debate is now a helpful, rather than destructive, force, and the educational system of the Alphatians now encourages tolerance toward dissenting beliefs and religions.

The First Decline —

After several centuries, Alphatians had conquered all the lands around their beloved new

homeland, were receiving enormous annual tributes, and were complacently sitting on the top of the world. But rot was beginning to set in.

The ranks of the military were increasingly made up of barbarians, conquered by the Alphatians and made part of their empire, but owing principal loyalties to their original tribes and homelands.

The family of Kerothar I was dedicated to preserving the strain of "pure Alphatian," the racial stock characterized by pale white skin with blue tints, jet-black hair, and black, blue, or purple eyes. The clan bred its sons and daughters as though they were prize horses. The result was that the clan was as pure Alphatian as one could find . . . but the inbreeding meant that the ruling family was descending into insanity and sickness.

Five centuries after Landfall, the Alphatians met the Thyatian tribes when these barbarians began preying on the Alphatian sea-trade. Because the Alphatian nobility was in decline, little was done to curb this raiding . . . and, in time, it proved to be a serious drain on the Empire's economy.

At the beginning of the ninth century after Landfall, Kerothar IV was Emperor. He was sickly, clever in magic but stupid in matters of government, and lazy. The example set by him and his pitiable family helped the Empire continue its slide into decline.

The mighty zzonga fruit, too, had survived the death of its homeworld. Originally, one family brought the fruit to this world. It could not grow naturally here, but the family wizards quickly learned to set up magical hot-houses where it could flourish.

In the early centuries of this Second Alphatian Empire, the emperors tried to stamp out the presence of the zzonga fruit, but were never quite successful. Later, as Kerothar's clan fell into decline, one of its emperors permitted the zzonga-growers to operate undisturbed—but taxed the sale of zzonga products to benefit the imperial treasury. Now, the zzonga trade thrived again . . . and by the ninth century of the Second Empire, the fruit was again taking its toll on civilization.

The Thyatian Barbarians -

About now, the Alphatians decided to conquer the barbarians of the western continent. For three or four centuries, the Thyatians had proved that they were a menace to sea-trade. They had two other traits which were to bring grief to the Alphatians. They were smart, and they were stubborn. So stubborn were they that the phrase "He/she has a neck like a Thy-

atian" is still in use by the Alphatians—meaning that the person so described is more stubborn than any other sort of man or beast alive.

It was thought that these barbarians had nothing that the Alphatians wanted—until the Alphatians discovered that the Thyatians' mountains were rich with gold. The Thyatians themselves mined only a little of it; they preferred to steal their treasures from Alphatian ships and trade missions.

The Alphatians decided to kill two dragons with one blast. By conquering the Thyatians, they could cease the pirate raids, and could gain access to a lot of gold. So they moved in to subjugate the three Thyatian tribes.

The Thyatians were unusually difficult to subdue and a few Alphatian wizards were surprised to find themselves killed by these stiff-necked barbarians. But the Alphatians' usual response to a problem—pour magic upon it until it's solved—eventually worked, and the Thyatians became the latest addition to the Alphatian empire.

The Alphatians took gold mined from the mountains of Thyatis, herd-beasts and crops raised by the Thyatians, and the stout ships and seafaring knowledge developed by the barbarians. In return, they taught their magics and arts to their new subjects, traded items to the Thyatians, and educated them.

But, as every schoolchild knows, the stiff-necked Thyatians rejected Alphatian teaching—or rather learned it and corrupted it to their own way of thinking. They sat and brooded for two centuries, convincing themselves that they were being enslaved by an evil empire. And eventually they rebelled.

The First Alphatian/Thyatian War

A Thyatian-born but Alphatian-trained man, Lucinius the Governor of Kerendas, had achieved mastery in spell-casting in his short life. He evidently believed that this entitled him to kingship. With the aid of a warrior (a wretch unacquainted with magic) by the name of Zendrolion, he assassinated the Alphatian wizards present in Thyatis and declared that benighted land an independent kingdom.

The Thyatians' lack of civilization worked in their favor. Alphatian troops arriving to reclaim these territories were met with resistance—including clerical magic—so disordered that they could not immediately over-

History of Alphatia

come it. The Alphatians would certainly have prevailed eventually . . . if the Empire had not been sunk so far in decline.

Wizards preferred to spend their time in zzonga-drugged hazes instead of doing the work of the Empire. Alphatia found itself taking a defensive position in this war—the Thyatians took parts of the Isle of Dawn, an Alphatian protectorate for almost as long as the Empire had existed on this world, and threatened to assault the Alphatian mainland. Meanwhile, Emperor Kerothar IV was bleeding the land's treasuries dry—not in defense of Alphatia, but in continued spending for the Empire's upcoming millennial celebration.

Swift action had to be taken. The Grand Council deposed Kerothar IV. A youthful, energetic wizard took the throne and the time-honored name of Alphas, the sixth to wear that name.

Alphas made stern reprisals against wizards who would not fight for the Empire, and finished begging the imperial treasuries by hiring crack, non-magical troops from overseas nations. The Thyatian advance was stopped at the Isle of Dawn, and eventually peace was signed between Alphas VI and King Lucinius.

Had Alphatia not been in such sad shape, Thyatis would have been returned to the fold . . . but not all the good intentions in the world can make up for the centuries of neglect that Kerothar's clan had visited on Alphatia.

Years of Rebuilding

In the decades after the war, Alphas VI and the Grand Council set the empire on a schedule of rebuilding. They imposed fierce penalties for wizards who performed official acts of rulership, judgement, or government service while under the influence of zzonga-fruit; they turned the attention of their magics to rebuilding agriculture and trade; they purged their military of the incompetent and the addicted. Even so, the new Empire of Thyatis, under Emperor Zendrolion and later under Empress Valentia, recovered much more quickly from the war and prospered much sooner.

In this time, Alphatia turned much of its attention on building and holding its dominions in the far east. It hired northern reavers to smash one Thyatian trading post built in Alphatian lands (in what is now Norwold), and kept up a fierce military presence in the disputed Isle of Dawn, but mostly kept its attention on eastern territories.

It took until Year 1250 (AC 250 in the Thyatian calendar) for Alphatia to consider herself

sufficiently recovered to begin expansion again in the west. First, colonies were planted on the northern coasts of Ylaruam, and those rich colonies turned great profits for the Empire for 250 years. During that time, too, the Alphatian/Thyatian border lines on the Isle of Dawn moved back and forth numerous times; though Alphatian magical power was greater than Thyatian military power, the pathetic Thyatian habit of extending full citizenship to anyone who could speak his name endeared that empire's ways to much of the island's population, making Alphatian conquest there difficult.

Around Year 1400 (AC 400 in the Thyatian calendar), Alphatian sorcerers discovered that descendants of the Followers of the Flame had settled deep in the western continent. Fortunately for all concerned, these Alphatians, who called themselves Flaems, wanted only to build their own nation and had no desire for war with Alphatia.

Modern Times

A century later, the Alphatian colonies expanding southward down the coast of Ylaruam encountered the northward-moving settlers of the barbarian Thyatians. Fierce but sporadic fighting broke out between the colonies, and was to continue off and on for more than two hundred years.

However, this was otherwise a peaceful time in the Empire. At this time, the greatest period of building and internal strengthening took place within the Empire. Great schools were built, and the great cities were expanded and renovated.

A charismatic wizardess by the name of Mylertendal, a resident of the city of Aasla, began demonstrating a philosophy of growth and beautification. It was her belief that the Alphatians had been infected with the Thyatians' desire for conquest and land-grabbing and that the race must instead return to the older values of living by pure magic. She spent years beautifying her own tower in Aasla and preaching her political philosophies—that the Empire was as large as it ever should be, that the Grand Council should use its power to limit national growth and population, that magical energy should be expended in making the Empire the most glorious place to live in any world.

She was successful in converting thousands to her belief, and every city and kingdom in the Empire shows signs of this great Alphatian preoccupation with making toys and monuments and buildings of brilliant design and

beauty—and in the continued Alphatian indifference to military matters and questions of imperial expansion.

Mylertendal still lives, and is an instructor at the University of Aasla.

While this domestic revolution was taking place, the Alphatian colonies in Ylaruam were crushing their pitiful Thyatian rivals. But at the moment of Alphatian triumph, the barbarian Ylari banded together under the banner of a religious fanatic named Sulciman Al-Kalim. They attacked the Alphatian colonies in overwhelming numbers, attacking with berserk fury, not caring whether they lived, and so treacherously drove the Alphatians out of their lands.

Not long after that, 50 years or so, a Grand Council member named Halzunthram proposed a plan to conquer a distant nation for the Empire's glory—it was a plan which required little in the way of resources, and would strike a blow at the ancient Alphatian enemies of the Followers of Flame.

In far-away Flaem lands, the Alphatian descendants of the city of Braejr were suppressing other colonists in the same land—particularly Thyatian settlers and elves. With a few hand-picked wizards and little in the way of supplies, Halzunthram would travel there, offer his aid to the oppressed humans and elves, become their leader, and show them how to conquer the Flaems.

It was a good plan, and it worked. Within two years, the humans and elves under Halzunthram had defeated the Flaems of Braejr. But when he announced that the land was now an Alphatian protectorate, his citizens treacherously rose up against him—and collaborated with the Flaems in doing so! It took forty years of profitless warfare, and then the human/Flaem/elf coalition, led (naturally enough) by a barbarian Thyatian lordling, captured Halzunthram and drove him out of Braejr.

The Alphatian emperor Tylion IV, looking for a way to recoup some of the Empire's losses, began a colonizing effort in the long-forgotten lands of Norwold—and even so, not long after, Thyatians began their own settlements there, too.

The Last Half-Century

In Year 1959 (AC 959 to the Thyatians), the Thyatians broke a treaty concerning trade conducted between the Thyatian and Alphatian empires. This so angered Emperor Tylion IV—

History of Alphatia

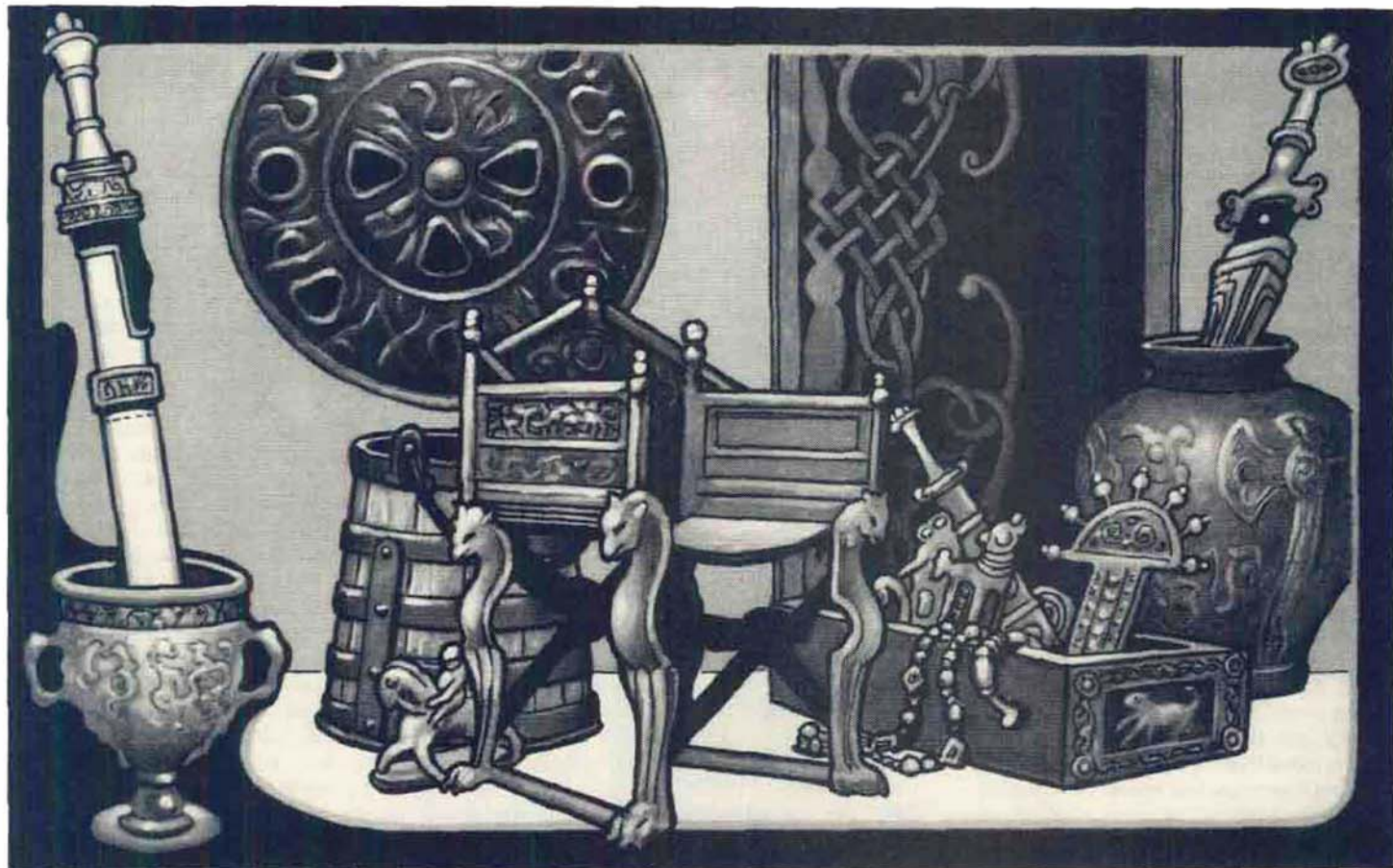

it was far from the first treaty broken by the barbarians while he sat the throne—that he decided to destroy the Thyatian Empire once and for all, and ordered a massive attack on mainland Thyatis. By year's end, he had taken most of the Isle of Dawn and was preparing for the next spring's assault on Thyatis itself.

The next year, Alphatian forces reached Thyatis City itself, slew its emperor, and—briefly—reasserted Alphatian domination of this barbarian land. But a sudden counter-attack by massed citizens—and led by the crude fighter who was to be the Thyatians' next Emperor—broke the tip off the assault's spearhead and drove the Alphatians out of the city. The barbarians' stubbornness and pride sufficed to throw the Alphatian army back to the Isle of Dawn, and recaptured most Thyatian holdings on that island.

For Emperor Tylon IV, this was the last blow. During his reign, the Empire had lost

all its Ylari colonies, had failed to take Braejr, had failed to keep Norwold clean of Thyatian settlers, and now had failed the most promising military enterprise in decades.

The Grand Council determined that he was no longer the man to head the Empire. Whatever the reasons for his failures, he had failed. The Council could not force him to step down (though individual sorcerers could have duelled him, he was still a potent magic-user); but it could oppose all his rulings, could hamper him in every way.

Tylon's daughter, herself a master magician and the named heir to the throne, recommended that he step down. In the face of the Grand Council's opposition, he did so, and his daughter, Eriadna the Wise, became Empress. In the years since, she has expanded colonization of Norwold, stabilized the borders of the Isle of Dawn, kept Thyatian expansion in check, and maintained

stern opposition to zsonga-trade. Though she has been Empress for less than 40 years, it seems she will be counted among the better rulers of the Empire.

"So that," the old man concluded, "is a rough outline of our history. You may make of it what you will—so long as you *learn it*. Study it in your free time. I will occasionally test the depth of your knowledge; do not disappoint me.

"The hour grows late, and you must attend on your princess. But return here at the same hour tomorrow . . . and I will introduce you to the very lands of Alphatia and her subject nations."

Overview of Alphatia

"Today," Terari announced, "we will look at the Empire as a whole—at the continent of Alphatia and all the lands she controls." Before him, on the table, was spread out a large map, its corners weighed down with drinking goblets. The map showed lands from the eastern coasts of the western continent, though the Isle of Dawn and Alphatia herself, eastward to the foreign shores of the easternmost continent.

"We will start with Alphatia herself. See, here . . ."

The Continent of Alphatia

On the fold-up sheet is the map of the continent of Alphatia, provided for reference for the description of this area.

To understand Alphatia, one must understand that the Empire is made up of scores of semi-independent kingdoms. Each obeys Imperial laws but may otherwise decide on laws of its own. Each is ruled by a great wizard and probably has a dozen or more wizards of the Grand Council residing therein.

Factors which would limit or benefit nations in less magical lands do not play a part here. If a kingdom is landlocked, it does not matter: Its great magicians may have necessary supplies and entertainments flown in by magical means. A great magician may have a long but safe underground road dug to the sea or to a friendly nation. Ordinary rules simply do not apply in Alphatia.

In the following descriptions, not every nation or city will be addressed—just important or interesting ones. Most nations have a large city as capital, and contain many smaller villages and communities. Some nations have no great city; some have several.

Southwestern Alphatia

This is sunny, temperate country, well-shielded from north winter winds by the mountains to the north. It is good land for growing, and so its cities tend to be surrounded by farmlands and pasturage. It's very settled and civilized country; monsters are few.

Nation: Haven. **City:** Aasla. Two thousand years ago, when the Alphatians made Landfall at what was later to become Sundsvall, they were led by Kerothar I. It was known that he preferred white-skinned "pure" Alphatians to copper-skinned "common" Alphatians. A

far-sighted wizardess named Aasla, a common Alphatian, decided to begin her own community, one where her own kind would not be held back by the prejudiced followers of Kerothar. She found a wonderful site overlooking a pretty gulf, built her tower and city here, naming the city after herself. Today, Aasla is the greatest port of Alphatia and the center of the Empire's sea-trade. It is the one of two great shipbuilding cities in the Empire; the other is Trikelios on the Isle of Dawn.

Nation: Vertiloch. **City:** Sundsvall. This city, the imperial capital of all Alphatia, is also called the City Built by Magic. It wasn't actually built by magic, but more magical building has occurred here than in any other city. By royal decree, this city is composed of large estates belonging mostly to aristocrats. Sundsvall is also the empire's center for the building of sky-ships.

Nation: Greenspur. **City:** Eagret. This is Alphatia's largest naval base. For that reason, there are more non-magic-users here than magic-users; it is one of the island's largest concentrations of fighters, and high-ranking members of the non-magical gentry tend to be treated more fairly and evenhandedly here than in Aasla or Sundsvall. The naval base here controls the southern waterway approaches to Aasla and its ships patrol the broad Gulf of Aasla.

Northwestern Alphatia

This land is very mountainous, particularly along the island continent's western coast; mountainous and more northerly, it has harsher winters and produces less food than southern climes. It is also wilder and not so densely populated as the southern half of the continent.

Nation: Limn. **City:** Trollhattan. On the western coast of Alphatia, in an area thick with mountains, is one large region of hilly but livable territory. Two thousand years ago, semi-sentient monsters such as trolls settled here in great numbers. Fifteen hundred years ago, Alphatian magic-users interested in the ways of the non-humans conquered this land—but did not subjugate the monster population. Instead, they gave them the same opportunity they gave humans in their dominions: Obey the laws and demonstrate magical ability, and you, too, will be aristocrats. So today Trollhattan is a city of magic-users of all kinds—humans, elves, and shamans and wiccans of many races (particularly centaurs, dryads, giants, goblins, orcs, and trolls) live and study here. It's a raw and

brutal city, with spell-casters living in dwellings ranging from the magnificent to the crude and disgusting. All non-magic-users must belong to the household of a magic-user or cleric (and travelers without magic must travel in the company of a magic-user or cleric) or be prey for magical experiments (or food for captured beasts). One of the great tourist attractions of this city is its enormous zoo, called the Living Bestiary, where one can view representatives of hundreds of different monster races captured by the city's magicians. Trollhattan is a center for the study of beasts, monsters, and nonhumans, and is a site of much monster-creation research.

Nation: Stonewall. **City:** Draco. This is perhaps the only city in Alphatia friendly to fighters and thieves. Fighters are tolerated and more or less fairly treated in Greenspur, and thieves can be found aplenty in some outlying areas—but only Draco likes these sorts of people. There are also more clerical temples here than anywhere else in Alphatia. The city's founder, an adventurer several hundred years ago, was fast friends with his "lessers"—fighters and thieves—and so founded a city where persons like them could find opportunity. Non-magic-users are still limited to Gentry status, but aren't oppressed here. Population-wise, Draco is the largest city in Alphatia, but its population is mostly non-magical; only magicians who agree with the city's philosophy live here, and they are few.

Nation: None. **Place:** Alphaks' Volcano. Off the western coast of Alphatia is an island perpetually wreathed with fog. It was discovered less than thirty years ago; it may have appeared some time earlier and remained undiscovered due to its mantle of mist. Ordinary sailing vessels cannot reach it; they are destroyed by sea-monsters and mystery whirlpools. Experienced magic-users who use their powers to get to the island discover that it reeks of the magics of the Immortal Alphaks, and swiftly leave (most, anyway; some are never seen again). It is said that there is here a small community of magic-users and clerics devoted to Alphaks, but it has never been seen. The volcano rumbles from time to time, but has not erupted since the island appeared.

Nation: Stoutfellow. **City:** Denwarf-Hurgon (Rockborn Caverns). The Alphatians like to have master craftsmen working for them; it's easier than learning crafts-mastery yourself. So, a mere fifty years ago, the imperial court issued an invitation to demihuman craftsmen to come settle in one region of Alphatia; the court promised that the city would have autonomy in the setting up of its govern-

Overview of Alphatia

ment structure, so long as it paid its taxes and designed beautiful things for the Alphatians. Dwarves came from Rockhome, and gnomes from all over the western continent, and halflings from both Norwold and the far-away Five Shires and settled this mountainous area with its great caverns. Most of the dwarves live in the Rockborn Caverns, and their halfling friends in the open-air city above; the gnomes are more or less evenly split between the two halves of the community.

Northeastern Alphatia

Like northwestern Alphatia, this region is cooler, with nastier winters, than the southern region. But it is unspoiled, beautiful and very popular with those who revere nature and her works. There are few farms here, and many lonely wizards' castles are tucked away, almost hidden, in the wilderness. Animals and monsters wander unchecked, and non-magic-using humans can live here ungoverned, living as hunters, trappers, furriers and shepherds.

Nation: **Ambur**. City: **Starpoint**. This city is notable for its many astronomers, who advance the science of star-watching, and its theatre system—there are more actors here, more theatres and amphitheatres, and more stage productions here than in any other city in the Empire. It's not enough just to be a magic-user in Ambur: You must also be an actor, playwright or stage director to be a celebrity here.

Nation: **Floating Ar**. City: **Skyreach**. Soon after Landfall, a mighty wizard named Ar came here to continue his ancient dream of making big things float in the air. Over centuries, he learned to make mansions, open fields, and eventually mountains float idly up in the air. The terrain of the country named for him features great chunks of territory floating above the ground, sometimes only ten feet above, sometimes miles above; and many wizards build palaces and cities on these floating islands. The islands drift around a little, as much as a mile or two in a radius around their point of origin, but never stray further than that. For these reasons, Floating Ar attracts many wizards interested in air magics, and Skyreach is a center of aeronautics research.

Southeastern Alphatia

This is the flattest and most agriculturally bountiful region in Alphatia; it has richer soil and more farmlands than any other place on the continent. It is here that one finds the

many greenhouses, public or hidden, where plants such as the intoxicating zsonga-fruit are grown. It is here that most of Alphatia's grapes are grown, and here that the wine industry has its base. It is a warm and lazy country (lazy for the rulers; of course, the non-magical working class must work as hard here as anywhere else) full of small, pretty cities and hard-working peasants.

Nation: **Aquas**. City: **Seashield**. Just off the shores of southeastern Alphatia is the city of Aquas—built *underwater* by ingenious wizards and engineers. The lower city of Aquas is dug out of the land-shelf bedrock; the upper city, full of remarkable experimental architecture, is built under a preposterously huge crystal dome at the ocean floor. Aquas is connected to the nearby shore by tunnels. The city is a center for the study of sea-monsters, their creation, rearing, and commercial uses.

Nation: **Arogansa**. City: **Bluenose**. Except for Sundsvall, this is the per-capita richest city in Alphatia . . . and it's far more haughty and prestigious than the capital city. This is where one buys property and builds a villa if he intends to entertain, to impress, to show off his extravagant lifestyle and personal worth. The city of Bluenose was once a fishing village named for the dolphins which frolicked in the sea; now wealthy idlers clutter up the beaches, enjoying themselves and spending their time in vacation and amusement.

Central Alphatia

Central Alphatia is a wild and lawless place. It is heavily overgrown with forest and there are many small mountainous regions here. Monsters and lawless men roam the thick woods, and no wanderer—other than a high-powered adventurer—is safe here.

Nation: **Shiye-Lawr**. City: **Alfeigh**. This is a deep-woods nation and city of elves. It was settled by permission of the emperors of Thyatis more than fifteen hundred years ago; it is very old, very deeply-hidden, and very mysterious except to friends of elvenkind. The Shiye (Alphatian elves) are distant cousins of the elves of Alheim and the western continent, and have the reputation of being malicious and threatening. This is said to be because they terrify those who wander unwanted into their realm . . . but they are still staunch allies of the Empire, and many elves leave the deep forests of Shiye-Lawr for decades or centuries to adventure in the outer world.

Nation: **Blackheart**. City: **Shraek**. Not many persons, other than Alphatian magicians, have heard of Blackheart and its capital

city, Shraek. It was founded by, and for, wizards who wanted to be away from the rest of humanity. It is occupied by antisocial wizards and their terrified servants, and is a place to visit only very briefly and when you have a specific person to seek. It is said that wizards build hidden towers and laboratories here when they want to conduct experiments that would horrify other Alphatian wizards and humans, and there is very little first-hand information available about these experiments. Blackheart's forests are filled with horrid monsters, many of them unique terrors which are probably the results of those experiments. In the court at Sundsvall and in many other places, Blackheart is not spoken of in polite company.

Subject Territories

Look at the map of the Alphatian Empire on page 12. It shows the continent of Alphatia, and also the rest of the empire's territories. Refer to it while reading the following.

The Alatians

These large islands, at the southern end of Alphatia, were once lightly peopled by farmers. But a few hundred years ago, when Mylertendal's philosophy of beautification was reaching its height, the Emperor ordered that the islands be depopulated (its farmers moved to Bellissaria and elsewhere) and turned over to magical artisans who would make whole nations that were works of art or centers of study. The experiment was a partial success: Two of the islands failed as artistic centers and were reverted to farming and trade communities, while two remained . . . unusual.

Island/Nation: **Aegos**. City: **Aegopoli**. The westernmost of the islands, Aegos reverted to agriculture. Though ruled by a magic-user and possessing its share of magical citizens, it is mostly a farming region.

Island/Nation: **Aeria**. City: **Featherfall**. The northernmost of the islands, Aeria is now the seat of scholastic learning of the Followers of the Air. The town of Featherfall boasts a large university and library, and there is more information concentrated here on the Plane of Air than in any other place on the known world.

Island/Nation: **Gaity**. City: **Rainbow Park**. The easternmost island is given over to amusements, recreation and pleasure. It is a resort for entertainments. All over the island, but especially concentrated in the city of Rainbow Park, are to be found strange amusements:

Overview of Alphatia

Dragon-rides upon captured beasts, simulated earthquakes, non-lethal training grounds for dungeon explorers, theatre communities where magicians with *impersonate* spells help visitors act out their most personal fantasies, and so on. All entertainments are free, but staying on the island costs a tremendous amount of money—a minimum of 5,000 gp per day—which is divided among all the island's operators in proportions determined by the King of Gaiety.

Island/Nation: Ne'er-do-well. **City:** Crossroads. After many years of failing to survive as an artisan's island, this site was taken over by a king who wanted to experiment with government. He renamed the island for the type of resident he wanted to attract. Any crime which does no physical damage to others is legal in Ne'er-do-well—theft, smuggling, etc. is all legal, and the wearing of masks is encouraged by the King. Taxes are high, and avoidance of taxes is a crime bringing gruesome punishments . . . but the bounty in taxes forwarded to the imperial treasury keeps Ne'er-do-well from being "corrected" by the imperial government. It is an island of thieves, traffickers, heretics, anarchists, and rogues, a way-station for illegal trade, a place where stolen goods from anywhere in the empire may be fenced, where the best-known wizards of Alphatia may draw masks over their faces and find bargains in rare substances and items, where identities are sold, where the most esoteric, profitable and dangerous rumors are found.

Bellissaria

Bellissaria is called Alphatia's Bread-Box, because so much food is grown here for the empire. It is the large island, nearly the size of Alphatia herself, that lies directly southeast of Alphatia. Like Alphatia, it is broken into many individual kingdoms and ruled by wizards, but it is considered more rural than Alphatia.

Nation: Meriander. **City:** Alchemos. This is a city dominated by sages and alchemists. Some part of the city is constantly being blown up in alchemical experiments. Many interesting scientific innovations are developed here, and the city has a good reputation even in Alphatia proper.

Nation: Surshield. **City:** Spearpoint. The king of Surshield rules from Spearpoint, a great military city which protects Alphatia from the far-eastern nation of Minaea. However, the rest of Surshield, the fertile strip running between the southern mountains and the

sea, is a land of anarchy, by the king's will. His law is that there is no law there—no justice other than personal might, no regulation, no order. That region is sparsely occupied by a few wizards (and their servant-communities) who wish to avoid imperial interference with their studies or activities; there are also many fugitives from imperial justice living off the land here.

Esterhold

Esterhold was wrested ages ago from the savage land of Jen, and must periodically repel invasions from its painted warriors and powerful shamans. But the gold found in Esterhold makes continued Alphatian presence here a certainty.

It is a harsh and unproductive land, except for its mineral mines, but well-suited to ambitious nobles wishing to colonize—the imperial court will grant permission to colonize to any Alphatian who can demonstrate that he's fit to take and hold land.

Nation: Blackrock. **City:** Skyfyr. The city was named Sky-Fire 1,000 years ago—so named by the Alphatians who invaded the Jennite city here and burned it to the ground. The name has corrupted over the years.

Nation: Verdian. **City:** Faraway. Faraway is a military community; the "kingdom" is actually a mercenary military force and allied community, its king a businessman. Faraway receives imperial moneys to guard parts of Esterhold's borders with Jen, and receives gold from the kingdom of Blackrock to provide additional defense to Skyfyr. The nation also produces food by using slave-labor of captured Jennites. It is a nasty, greedy, uncivilized, and very profitable community.

The Isle of Dawn

The Isle of Dawn, a narrow, long island with excellent fishing-waters and beautiful scenery, was settled by humans before the Alphatians ever made Landfall. Its peoples, the Thothians, were civilized and rich in wisdom; they traded peaceably with the Alphatians for hundreds of years. About the time the Alphatians were first encountering the barbarian Thyatians, the Thothians had some sort of revolt, revolution or other crisis (even today, Alphatian scholars can't figure out what happened); Alphatian forces moved in to quell the disturbance, and the emperor of the time decided that Thothia would remain as an Alphatian province. It was so for another five hundred years or so, with Alphatians gradu-

ally founding their own colonies among the Thothian settlements, until the first Alphatian/Thyatian war. Then, many parts of the island fell to the invading Thyatians. Over the last millennium, the Thyatian and Alphatian areas of control have changed many, many times; in the long run, the inhabited parts of the island remain pretty evenly divided between the two empires.

Nation: Confederacy of Dunadale (formerly Bogland). **Towns:** Dunadale, Deirdren. These towns, under other names, were originally Thothian settlements, abandoned when Thothia had its shakeups and was added to the Empire. Alphatians—particularly non-magical farmers—occupied these two cities and the surrounding lands, which were peat-bog territory. The region, then called Bogland, was walked back and forth upon by the Alphatian/Thyatian border many times. Eventually it petitioned the empire for full kingdom status (as the Confederacy of Dunadale; it may even split into more petty kingdoms in the future), raised its own armies, and more or less put a stop to the "crawling Thyatian border" problem. Kingship is hereditary, and the throne is in Dunadale—but other cities elect their city leaders!

Nation: Hillvale. **Town:** East Portage. This town, of 1,000 residents, is the counterpart of Thyatian-controlled West Portage. Great quantities of shipping goods and even small boats and ships are ported from one coast to the other. It is here that most legal trade between the empires of Alphatia and Thyatis takes place. The petty king here, Lornce N'Jozee, is reputed to have friends among the Thyatian merchant class and so the Grand Council keeps a stern eye on him.

The City-State of Ekto is a former Thothian colony; it is noted for its metallurgists, the most well-studied scholars of metals in all the world (though many dwarves would dispute that pronouncement).

The City-State of Trikelios is another former Thothian colony; it is noted for its great ship-building facilities and innovated ship engineering.

Nation: Thothia. **Town:** Edairo. This is a very old human culture, unlike any other in the known world; and, though Alphatian sages believe it originated elsewhere, they have not had much luck in determining whence the civilization came. The Thothian king is called a pharaoh; the people study mysticism and do not honor the Immortals; the Thothians build great pyramids to house the bodies of their dead kings.

Overview of Alphatia

The other regions shown on the island are Thyatian-controlled, except the wild and untamed Southern Plateau, which is no-man's-land. Thothia claims it but does not settle, patrol, or colonize it, so other nations ignore the claim.

NORWOLD

Norwold is one of Alphatia's most distant colony nations. It is a land of deep forest and thick glaciers, and has been infrequently fought over by Thyatian intruders. It belongs to Alphatia, and is ruled by the Empress' second son Ericall; but its population consists largely of Heldann settlers, Northern Reaches descendants, halflings, and men of Thyatian descent as well as Alphatians. Because King Ericall is no wielder of magic, in Norwold non-magic-users can achieve noble titles and rule dominions. This makes it an inviting region for the Gentry of Alphatia to settle. Norwold is not actively seeking independence, but would welcome it if it came.

City: Alpha. This is the nation's capital city. It has a good waterfront and rich farmlands.

Town: Lecha. This town is a central gathering point for the many halfling clans which live in Norwold.

City: Oceansend. This city, built and settled by Thyatians, wisely threw off the yoke of

Thyatian rule in the last half-century. It currently maintains its independence, but will eventually have to swear allegiance to Norwold and, by association, Alphatia. Its ruler styles himself a king.

Town: Landfall. This community, loosely called a town, is a pirate haven and city of thieves. It may well be the nastiest and dirtiest city of its size in all the Empire. Because it makes a show at paying its taxes and makes no official raids on other Alphatian cities, the empire has chosen not to interfere.

Qeodhar

This is a cold, distant, northerly island, and is technically only an ally of the empire. But its ambitious ruler has tried to wed a daughter of the Empress, and is thought to negotiate with the Thyatians as well; if he does not behave himself, Alphatia will move in to subjugate the place formally.

City: Farend. This city, like the rest of the island kingdom, is not a magocracy. It is closer in temperament to Norwold than to Alphatia.

The Yannivey Chain

These islands, owned by the imperial throne, are not officially settled; no one wants to colonize here. The islands are poor, its residents

mostly non-magical fishermen, raiders, pirates, and fugitives. It is usually cold and always uncomfortable. It is rumored that magicians from Blackheart often come to these lands to round up experiment victims.

"That," Master Terari finished, "is the Empire—far broader than you would conceive from your humble beginnings."

Galatia was impressed—her changing expressions as the master extolled the empires wonders were clear signs of that. Now, however, her expression held as much doubt as delight. "The wheres and whens and city-names don't tell me very much. I have known fighters who were great men and great rulers in Thyatis, but here they would be treated like rubbish. Why is this? Why do the Alphatians seem so powerful and creative in some things and yet get so little done? Why—"

Terari held up a hand to forestall her queries. "You think we Alphatians fail to live up to our potential?" he asked sternly.

Galatia's jaw set. "I do, and not all your magics can change the truth of that."

The master shrugged. "Good. For you are correct. I am glad you are thinking for yourself . . . but we will speak more on these thoughts tomorrow."



Alphatian Society and Politics



"Individuality and freedom are the bright promises of magic use," Master Terari announced. He leaned back in his chair, clasped his hands together over his belly, and looked contemplatively at Galatia. "At a certain point in your development in the study of magic, you find that you no longer need other people—for anything other than companionship, of course, and alliance against common enemies—and that you may increasingly turn your time to your own interests. Other demands on your time become pure annoyance, to be avoided whenever possible—and you have enough power to avoid all but the most important calls for your attention. Does any of this make sense so far?"

"I suppose so," the young woman replied. "But it's one thing to say all that, and another to relate it to real people—and to see how it affects this empire of yours."

Terari nodded agreeably. "Then let's make the example a little more personal. Let us say that you, Galatia, are a promising student of magic. You learn fast and well. You can slay the greatest warrior with a wave of your hand. You can project yourself to whole other planes of existence. You have found the love of the greatest and handsomest wizard in all Alphatia. And you have found another talent, say in the design of clothes, for which admirers from all over the Empire visit you and lavish praise upon you.

"And then all your male relatives perish in a war with the Chicken-People of Ploo. You must return home to rule your ancestral lands. And you find out that the demands of rulership on your time dictate that you give up your plane-wandering, your clothes-designing, and your lover. What will you do?"

Galatia didn't think about that for very long. "Why, I'd appoint others to do all the work of administering the dominion while I kept to my own pursuits."

"What if these others are untrustworthy?"

"They'd better not be! If I am so powerful, I can read their minds and *charm* their spirits and wipe them away if they betray me."

"Good. Now, you are at a crucial stage in your hobbies. Your lover is demanding more of your time, and you are arranging a fashion show in Sundsvall which is a week away. And suddenly, the Empress makes a general pronouncement that the military needs magic-users such as you to volunteer for a brief war with the Empire of Thyatis. What now?"

"Well . . . I wouldn't go. Alphatia has lots of other wizards more suited to that sort of enterprise. And I have more pressing concerns."

Terari grinned. "Now, conceive of an empire ruled by persons exactly like you. Is it any wonder the Alphatians, as you said yesterday, don't live up to their potential?"

National Character

Alphatians, as a people—their ruling classes, anyway—are chaotic, free, and individual. They believe in freedom of thought and choice . . . but only for those privileged enough to wield magic. Those who cannot utilize any sort of magic are destined to serve in one fashion or another.

The Alphatian attitude leads to the great beauty of their cities and arts, and to the great power possessed by individual magic-users. But it also means that the Alphatians have little strength in unity—they prefer to be off making their own studies. They cannot field as many wiz-

ards in war at any one time as they should be able; those they do field usually wish they were somewhere else and so do not fight as effectively as they might. This, obviously, limits the empire's effectiveness in war and in expansion.

Obviously, not *all* Alphatians share this attitude. Many, especially those who have spent years adventuring out in the world (and have been exposed to many other cultures), may think and act differently—they may respect non-spell-users, may execute their responsibilities quickly and without reservation. But they are in the distinct minority.

Races

Alphatians, unlike Thyatians, are not quick to blend their race with others; they tend to conquer other races and make them into servants rather than regard them as allies and citizens. The Thothians of the Isle of Dawn are an exception; they were civilized and had their own magic-users long before the Alphatians ever came to this world, so they are looked upon as equals in the Empire.

But others—the long-vanished humans which originally settled the Alphatian continent, the Thyatians, the Jennites and Minaeans—are fit only for indifference or conquest. Should a wizard or cleric from one of these lands visit Alphatia, he would be treated with the respect accorded any spell-caster; he would be an aristocrat and protected by Alphatian law. But non-spell-casters of those races are automatically thought of as servants.

Once upon a time, 99 in 100 Alphatians were magical. Today, that proportion is far, far smaller. After the Alphatians made Landfall on the known world, the children they bore were only about 50% magical—only about half could learn magic. The races they conquered were even less lucky.

Alphatian Society and Politics

Today, the proportion is even worse. Magic-users live longer and have fewer children than those who have no magic. So the estate of a mighty wizard may have numerous family members with magical ability . . . and scores of non-magical servants and slaves. It is estimated today that only one Alphatian in five is born with the trait of magic use.

In noble families, those unlucky ones born without the magical trait turn to clerical magic. Some do, anyway; the Alphatian indifference to Immortals is such that few of them do actually become clerics, even though to be a cleric is to be equal in status to a magic-user. Some others pursue fighting and thievery professions in parts of the Empire (and outside the Empire) where they will be appreciated.

The Sexes

In Alphatia, the sexes are considered equal. Across thousands of years, it has been impossible to determine whether one gender or the other has any advantage in magic-use; common wisdom is that neither is superior, and there are very few who argue for the dominance of one sex or the other.

The mainland Thyatians' attitude of male superiority grates on the Alphatians, especially female magic-users, and this is one cause of friction between the two cultures.

Age

Age is a tricky thing in Alphatia, particularly among the ruling magic-users. Through use of *potions of longevity* and *wish* spells, some of them live as long as five or six hundred years, maintaining a youthful appearance and spirit up to the end of their days. So it is impossible to estimate how experienced an Alphatian magic-user is by looking at him. If a wizard looks aged, it is because he allows himself to.

Dress

Spider Silk

The clothing of aristocrats is almost always made of spider-silk. The silk spider, an eight-legged invertebrate brought back from the Alphatians' home dimension, is raised in huge textile factories; the creature spins strong, thick (by spider standards) silken thread, which is collected, washed to get rid of the spidery glue, mechanically separated by a device like a cotton gin, dyed, and fabricated into clothing.

Spider-silk is one of Alphatia's great exports—especially to lands such as Thyatis and Glantri, where fashion is a pressing concern; Ylaruam, where light, strong fabric is very much desired by the wealthy classes; and Alfheim, whose elves appreciate the aesthetic qualities of the cloth.

Many subtle dyes are used on the cloth, and if you can conceive of a color, there is a silk-dye of that hue somewhere in Alphatia.

Noble Dress

The common garment among men and women of the nobility is the *kihara*, or robe. It is a floor-length robe with long, flowing, wide sleeves, belted at the waist. That's the basic form—but there are many variants as well. Adventurers usually wear it knee-length, with trousers or hose underneath. In warmer climes, there may be string-ties at the shoulders whereby the sleeves may be drawn up and tied off. In colder climes, the gown may be of a heavier material, often with an under-layer for insulation, and have an attached hood.

Only if one wants to remain anonymous does one leave the *kihara* undecorated. These robes are dyed in bright or striking colors, and embroidered in rich hues and extravagant designs.

The belt worn with the robe is usually a single, broad leather band from which pouches and sheaths may be hung. Often, though, it is a strand of leather or cord wrapped three times around and tied off in front, or a colorful sash knotted at the hip (a fashion especially popular with women).

Footwear includes slippers (for wear around the manor), soft shoes or low soft boots (for ordinary wear), or high hard boots (especially popular with adventurers and those wearing trousers).

Commoners' Dress

Wealthier commoners (gentry and freeman level) wear clothing in much the same style . . . but Alphatian sumptuary laws declare that only aristocrats and higher classes may wear spider-silk in Alphatia (regardless of who wears it in the lands to which it's exported). So lower-class *kiharas*, though they may be just as brightly-dyed, extravagantly embroidered, and exquisitely tailored, are made of other materials, chiefly Bellissarian cotton.

Poorer Alphatians, chiefly servants and slaves, wear a more or less featureless short-sleeved tunic which comes to mid-thigh or the knees and is belted or roped at the waist. Those who prefer to, or need to because of their work, also wear trousers and boots.

The military uniform is a variation of the above costume. Each kingdom in Alphatia dresses its military in a different uniform, but the uniform of the Empire (including the imperial navy) consists of the high-length tunic and trousers in gold, and boots and sword-belt in a dark golden brown. Cloaks (worn in cold weather and by officers) are dark brown, never hooded, and may have sleeves; tunics in cold-weather stations are long-sleeved and have lined hoods.

Hairstyles

The fashion among noble Alphatians is to wear the hair long—the longer, the better (it's a symbol of status). It may be straight, wavy, or arrayed in loose curls. It is sometimes worn in a single braid or ponytail; sometimes it is braided with decorative ribbons, chains, strings of beads or bells, etc. This fashion is for both men and women.

Adventuring Alphatians find that very long hair is a bother—it requires too much tending and can be grabbed by enemies in hand-to-hand combat. Magic-users typically keep it no longer than mid-back; fighter, thief, and cleric men tend to cut it to shoulder-length or shorter; fighter, thief, and cleric women tend to leave it at mid-back length but often wear it up.

Servants and slaves wear their hair as is dictated to them. For most, it is cut short. It is a sign of favor to let a servant or slave grow his or her hair out longer.

Makeup

Alphatians who can afford it like makeup—particularly face-painting. They paint clan markings, creatures, and other designs on their faces in brilliant colors. This is customarily done for parties and engagements, not for day-to-day wear.

One fashion that is catching on among women is "mask" makeup, where a mask-like design is painted around the eyes in a single color. The design may be like a broad robber's mask or in the shape of a butterfly.

Alphatians serving in the far east encountered the custom of tattooing and brought it home. Most Alphatians recoil from permanent tattoos, but have developed a *tattoo* spell which they use both for personal decoration and for art.

Jewelry

Alphatians tend to simplicity when it comes to jewelry. They will wear one or two finger-rings, simple earrings, necklaces, bracelets—but seldom all at once. These jewels tend to be very simple but elegant; they don't like a profusion of stones or gems.

Men wear the same sorts of jewelry as the women, including earrings.

Weapons and Armor

Each kingdom arms its military in a different fashion. One nation's forces may be famous pikemen; another's will be axemen; others will be sword-and-shield fighters; and so on. Because the noble classes are disinterested in the doings of the military, the non-magic-users in charge of the military forces tend to be very practical in the choice of weapons; you don't see forces ordered

into battle holding nothing but bagpipes and daggers, for instance.

Fighters of the Imperial Navy and other imperial forces carry one of the following weapons combinations: Broad sword, shield, and dagger; longbow, quiver, rapier, and dagger; crossbow, quiver, short sword, and dagger; pike (long spear), short sword, and dagger.

Alphatians and the Immortals

You've doubtless gathered that the Alphatians are disinterested in most matters of the Immortals. That's true. There are few clerics in Alphatia; not a large proportion of the lower classes attends temple services. However, because clerics wield magic, they are still equal in social status with magic-users.

Higher-level wizards pay increasing amounts of attention to the Immortals . . . in order that they might learn more of the workings of the universe and, perhaps, become Immortals themselves. But they do not look upon the Immortals with the sort of reverence that men of other nations do; rather, it's the sort of respect one pays to those of a higher social class, a class which one wants to attain himself some day.

Specific Immortals

Among the few Immortals studied in Alphatia are:

Alphaks. Though he is considered to be the Destroyer of the First Empire and hated throughout Alphatia, Alphaks is followed by some Chaotic clerics and magic-users of evil disposition. His presence has only been felt in the last couple of centuries; before that, it is assumed that he was following his path to Immortality and then, perhaps, having a difficult time finding the descendants of the original Alphatians. His followers intend to help destroy the Alphatian Empire; for this reason, this sect is outlawed, and ruthlessly purged by the Empire wherever encountered. Sphere of Death; Chaotic.

Alphatia. Within a couple of hundred years of Landfall, an Immortal female by the name of Alphatia was making her presence known in the Empire. Her goal is the preservation of the Empire, but she does not seem to favor Alphatian conquest of other territories. Sphere of Energy; Lawful.

Eiryndul. This elvish Immortal led the Shiye clan to Alphatia around Year 200 (BC 800 on the Thyatian calendar), and is the patron of elfkind in Alphatia. (The Shiye also know of Ilsundal, the first Immortal elvish patron, but do not worship him.) Sphere of Time; Neutral.

Koryis. The Patron of Peace and Prosperity is followed by a certain percentage of Alphatia's mercantile Gentry. Alphatian wizards privately

consider him to be useless—they perceive that they make their own peace and prosperity through proper studies of magic. Fighters, too, ignore him, disliking his aspect as a patron of peaceability. Sphere of Thought; Lawful.

Rathanos. This Immortal is worshipped by some Thothians; he is the patron of Thothia and of Fire Wizards, and so is studied by rogue descendants of the Followers of Flame. Sphere of Energy; Chaotic.

Zirchev. This Immortal is concerned himself with animals and monsters of all kinds; he promotes the study of beasts, of observance of nature, of the preservation of woods and animal-kind. He is studied and worshipped by some elves and by many clerics, magic-users, shamans and wiccans of the nation of Limn and city of Trollhattan. Sphere of Energy; Neutral.

Food and Drink

Given the Alphatian aristocrats' love of variety and access to incredible magics, it would be impossible to describe all their varieties of food and drink. Suffice it to say that they prefer their food arranged as delicacies rather than hearty meals: thin-sliced cold-cuts arrayed as flowers or in other shapes, pates, appetizers, sauces, fine wines, exotic liqueurs, and so on—no hearty hunks of meat, plates of vegetables, or bowls of stew for the Alphatians.

Freemen, the Gentry, and aristocrats who haven't made their fortunes yet (i.e., low-level magic-users and clerics) eat more sensibly. The rich farmlands of Alphatia and Bellissaria yield wheat and barley, corn, a wide variety of vegetables and fruits; the forests and pastures yield venison, beef, and mutton a-plenty (pork is not very popular).

Slaves and servants eat what they are allotted, which usually isn't much—bread, some vegetables, an occasional goblet of meat; stews and soups are more common among the lower classes.

Entertainments

Theatre

Alphatia has an active and skilled theatre system, supported by the nobility—who comprise most of the actors. The center of theatre arts is the city of Starpoint in the kingdom of Ambur, but every great city has a performers' community, and every city has some sort of theatre.

Unlike the theatre troops of other nations, Alphatian theatre companies do not tour. They are associated with one theatre and perform only there. Alphatian theatre sometimes includes ballet-like dance and operatic singing. Dramas tend to be low-key and underplayed; comedies tend to be biting satire and witty comedies of manners.

Display Arts

"Display Arts" is a catch-all title for entertainments that magic-users come up with and show off to others, usually through use of magical powers, alchemical knowledge, and so on. Some samples of Display Arts include:

Fireworks. Put on by alchemists, or by wizards with lots of fire-related spells.

Living Dioramas. Diorama "sculptors" arrange scenes, using golems, constructs, and other created beings instead of statues; the dioramas may move subtly, so that the scene is slightly different whenever viewed, or dramatically, for some shocking or storytelling effect.

Phantasms. A *phantasmal force* spell cast on an interesting medium (a canvas, a mirror, inside a bottle) and then hit with a *permanence* spell becomes a work of moving art . . . in the hands of the right artist. Moving, posing, apparently breathing portraits are sometimes made in this way; a favorite sort of present is a moving three-dimensional image of one's self cast into a bottle and then given to a lover. Some Phantasm artists set up whole galleries of their displays.

There are as many different Display Arts as one can imagine different uses for spells. However, not all Display Arts are good, artistic, or interesting, though their creators always believe they are. Some Display Artists really are geniuses, or at least creative technicians; many, however, are deluded, egotistical, talentless elitists who believe they are beautifying the world when instead they are wasting magical energy on purrulent trash.

Duels

Duels, as defined in Alphatia, are strictly-conducted battles between magic-users (or clerics). Duels are always to the death. They may be undertaken for revenge or to settle an issue. Few magic-users like to duel; many have to at least once.

Duels are public events; attendance costs from 10 to as much as 1,000 gp, depending on the fame of the duellists. Duels are not fought in an atmosphere of happy cheers or rude shouts from the watchers; the audience watches in horrified fascination as two or more magicians try to murder one another.

But, in spite of the fact that it's a disturbing business, duels are heavily attended. In big cities like Aasla and Sundsvall, there is at least one duel a day. Usually it involves lower-level magic-users, but the occasional big event—once or twice a year—may involve wizards who have reached ultimate mastery in their craft; in that case, the duel may be spectacular and horrible and go on for some time.

Alphatian Society and Politics

The "Barn-Raising"

Occasionally, a magic-user of medium levels—usually between 11th and 15th level—will decide that it is time for him to have a home. He purchases some land and notifies his friends. All study up on spells which pertain to making permanent dwellings. The wizard, if he is not himself an engineer and architect, hires one.

Then, starting one fine day and going on for a day to a week, these wizards and architects magically construct his dwelling in an event called a "barn-raising" (after the Alphatian farmers' barn-construction event). This is usually great fun, with everyone contributing unusual surprises to the building's design (practical jokes, hidden rooms, unexpected magical effects); every wizard participates in a few barn-raising in his lifetime.

Lower-Class Entertainments

The lower classes in Alphatia have four favorite sorts of entertainment (four we can talk about here, anyway).

Gambling. Gambling of all sorts (especially dicing, card-playing, and betting on hard-ball competitions) is a widespread pastime in the Empire.

Music. Alphatian musicians of the lower classes organize into bands and orchestras, composing brilliant, evocative, powerful music—ballads and fast-moving dances especially. The music played for the nobles and their dance affairs is usually milder and more traditional than the fast, harsh, often sad music they play for themselves. Many taverns in Alphatia are music-halls with bands of great renown. Some magic-users who study music are able to join these bands, but they are very rare.

Pub-Crawling. Lots of folks enjoy a night out, traveling from pub to tavern, seeing the sights and spending a good deal of money on wines and other beverages. Gambling and listening to music, among other recreations, are often part of pub-crawling.

Hard-Ball. This is the national sport of lower-class Alphatians. It's an athletic competition involving a hard rubber ball a few inches in diameter. The playing field is gridded off into squares 30' to a side; there is a goal-box with a net at the back, 10' wide and high, at the center of each end of the 300' by 150' field. In the game, each team of a dozen players tries to get the ball into the net of the other team's goal. The ball may be run with inside the 30' squares, but may only be *thrown* across the borders of those squares, so the ball must change hands numerous times in its progress up the field. Tackling, blocking, and wrestling-away of the ball are all legal; so is throwing the ball in the manner of a weapon. Magic use is not. Hard-ball is wildly popular among the gentry and lower classes.

It's to be noted that the upper-classes aren't entirely immune to the lure of lower-class entertainments. They're not supposed to be interested in these things, but many are. Lots of aristocrats dress down and conceal their elevated rank, then descend into the lower cities and tenement neighborhoods of their communities in order to enjoy these "lesser" entertainments. Many wizards use *crystal balls* directed at sporting arenas to watch the current hard-ball game.

Classes of Society

Alphatian society is broken down into nine classes. Everyone in Alphatia belongs to one of them. The four lower classes constitute the Commoner classes; the five upper classes constitute the Noble classes.

In order of increasing importance and power, here are the classes.

Slave. A slave is someone who has no magical ability (magic-user or clerical); owns no property; and belongs to another person, one of Freeman status or higher. From the age of 12, all slaves are listed with a government registry office, and the owner lists each slave with his or her monetary value; this may be changed from year to year as the slave's perceived worth varies. A person of Aristocrat rank or higher may legally kill any slave, for any reason or none; there is no investigation or censure. But he must compensate the owner the money-value listed for the slave. (It would seem that a noble wishing to protect his slaves could list each with a gross gp value—say, 50,000 gp each. But slave-owners pay annual taxes based on the declared value of the slave, so a more realistic declaration of value is usually used.) Slaves may not carry weapons; it is a required death penalty for a slave to touch a weapon for any reason other than defense of his owner. The children of slaves are slaves. Slaves may be freed only by their owners. The slave's life is usually one of heartbreaking, backbreaking labor from youth until death; few are permitted to learn to read; few ever hold a coin in their lives; runaways are executed, by imperial law. Obviously, player-characters should not be slaves.

Servant. The Servant is technically free, but has few rights. By definition, the Servant is someone who does not possess magical ability and does not operate a business. A Servant may not own land, and must belong to the household of someone of Freeman status or higher. However, Servants can own personal properties, and can move from the household of one master (even if it displeases that master) to that of another (with the other's permission, of course). Servants work for another, sometimes for nothing more than room and board, sometimes with a salary in addition. Farmers working a lord's lands are Servants; so are household staff

(though some may be well-educated and quite well-off); so are soldiers of less than commissioned officer rank; so are shop workers, wandering adventurers who do not own a registered business.

Freeman. Freeman are much like Servants, but they have saved up enough money to buy and register some sort of farm, shop, or business in Alphatia. A Servant can become a Freeman just by having enough money to do that. Many adventurers open small offices where they sell their services as explorers and mercenary officers some of the time, going on personal adventures the rest of the time, and so avoid being classed as Servants. Freeman do not have to belong to the household of any higher-class person. Freeman may own land, buildings, and slaves; they may employ servants; they may accept or refuse business as they choose. But they must make enough money to maintain their places of business and register their businesses with the imperium each year, or they will see those businesses stripped away and find themselves at Servant status again. Freeman may be military commissioned officers, but still must use some of their salary to maintain an office or shop somewhere in Alphatia—it is usually their official recruiting office in their favorite city.

Gentry. Being of the Gentry is just like being a Freeman, except: Members of the Gentry must keep at least 10,000 gp in one of Alphatia's banks; they may own branch businesses, or firms with branches in more than one city; they are treated much as lower-wealth aristocrats are, and are often permitted to mingle with aristocrats in social affairs. First-level clerics—who do not yet know how to cast a spell, but who belong to a clerical order—are treated as Gentry.

Aristocrat. Aristocrats are people who can use spells, regardless of their personal wealth or background. The daughter of a slave, if she has the ability to use magic and can be taught a spell, is automatically elevated to the rank of Aristocrat. She may not now own anything more than one dirty robe, but she soon will. Aristocrats, regardless of their wealth, may wear spider-silk garments, may attend imperial universities, and are treated as equals—as "one of us"—by the other aristocrats of Alphatia. They must be addressed as "Milord (name)" or "Milady (name)" by those of the lower classes, though no such title is required from other Aristocrats. Aristocrats may aspire to the rule of a dominion within Alphatia, where others may not ever do so. A cleric, as soon as he has learned his first spell, belongs to the Aristocracy.

Lord/Lady. Aristocrats who, like the Gentry, maintain at least 10,000 gold pieces in a bank, and who either own a business, provide a service, or occupy an imperial office of some sort (minister, ambassador, advisor, military officer, etc.), may style themselves as Lords or Ladies. Commoners must address them by their titles when

speaking to them: "Lord Hydenthal," "Lady Kara," etc. Nobles do not have to use those titles when addressing another Noble.

Prince/Princess. A Prince or Princess is the son or daughter of a King, Queen, Emperor, or Empress. Those whom it seems are destined to rule are usually addressed as Prince (name) or Princess (name) by commoner and noble alike. Those who are not likely ever to rule still must be addressed by title by commoners, but nobles usually omit the title. Being a prince or princess grants no advantage other than the lifestyle that befits the child of a ruler.

King/Queen. One who rules a dominion in the Alphatian Empire is a king or queen. To obtain a dominion, the person must inherit it from a relative (usually a parent), or be willing to colonize, settle and rule some distant point in the Empire (such as faraway Norwold)—and must meet the other customary requirements for ruling a dominion in the D&D® game. It won't do just to raise an army, conquer an existing kingdom, and declare yourself king; that's against the rules of the empire. Representatives of the Grand Council move in and take the kingdom back, killing you in the process.

In Alphatia and Bellissaria, all Kings and Queens *must* be magic-users, clerics, or elves. In the Isle of Dawn, Norwold, and other, more distant, territories, the empire allows rulers to be non-spell-casters.

It's a growing fad in the Empire for kings and queens to style themselves Barons and Baronesses. The term Baron, which normally applies to a western form of petty dominion ruler, is considered dramatic, roguish, and romantic by the Alphatians (springing from stories of rakish robber-barons). The kings of allied Qeodhar and the Isle of Dawn's little East Portage style themselves Barons . . . but make no mistake, an Alphatian baron is a king.

A king or queen may rule only one kingdom. He might conquer the neighboring kingdom and add it to his own, making one kingdom of it (*this isn't* against imperial law—a king can conquer another kingdom where a lesser noble can't), but it's still one kingdom; he cannot rule two separate kingdoms. A king could conceivably split his kingdom in two, giving half of it to another noble; the Empress would have to recognize it as a new kingdom for that person to be rated a king or queen, however.

Commoners must address this noble by his title: King (name) or Queen (name). "Your Majesty" is also appropriate. Nobles of Lord or Aristocrat also use these titles; those of Prince rank or higher don't.

Emperor/Empress. The Emperor (or Empress) rules the Alphatian Empire—sets policy, grants titles and dominions, orders wars and military strikes, etc. He is automatically the King of Vertiloch. If he was already the king of another nation, he *remains* king of that nation, and of

Vertiloch, if he chooses. However, most emperors retain the kingship of their original lands and grant the kingship of Vertiloch to those they name as their imperial heirs. Commoners must address this ruler as "Emperor" (name) or "Empress" (name), or "Your Imperial Majesty;" nobles of up to Prince rank customarily do; Kings, Queens, and members of the Grand Council do not, and may familiarly use the ruler's name.

In Alphatia, there is no recognition of marriage. Therefore, one does not gain any sort of status by marrying someone of higher status. If a King marries a slave, that person stays a slave . . . unless the spouse buys and then frees her. Then, she is a servant . . . unless he buys her a business, at which time she becomes a freewoman. If she acquires or is given 10,000 gp to keep in the bank, she will be of the gentry. She may never be any sort of aristocrat unless she can learn magic, regardless of whose wife she is.

The Status of Children

Until they reach adolescence, children are treated much as their parents are, because they will probably be the same rank.

At that time, noble children are tested by wizards to see if they bear the trait that will allow them to learn magic. If so, they themselves receive the official rank of aristocrat. If not, they are treated as freemen—freemen whom their parents may dearly love, but commoners nonetheless.

From 14 to around 16, later or earlier in some families, they learn the principles of magic and are taught their first spells at the end of that time. Nobles' children with no magic may join clerical orders during this time, and are considered gentry until they learn their own spells . . . whereupon they become aristocrats.

Foreign Titles

In distant subject lands of the Empire, classes may be a little different. In Norwold, for instance, King Ericall grants lesser dominions to rulers who swear fealty to him. In Norwold, this rank may be called Count or Baron, but back in Alphatia it ranks with Lord—this demi-ruler is considered a noble administrator for his King. The imperial throne does not rate this sort of dominion as a true dominion, for Ericall technically has the right to take it away from the ruler for breaches of the law.

Character Class and Social Class

Let's relate all that social class information to character professions.

Normal Men and Women, that is to say 0-level characters, are treated as commoners . . . unless they appear to be able to learn magic (in which

case treated as aristocrats) or clerical magic (in which case treated as gentry). Normal men and women who never adopt a character profession may be slaves, servants, freemen, or gentry.

Magic-Users are automatically aristocrats. When they're able to keep 10,000 gp in Alphatian banks, they're lords. If and when they're recognized as the children (or title-heirs) of kings, they're princes. When they inherit or carve out their own dominions, they're kings.

Fighters, like normal men and women, are commoners. If someone is a first-level fighter, he is at least a servant. Once he earns and spends at least 1,500 gp (300 for annual shop registration, at least 1,200 for annual shop or office rental), he can be counted a freeman. When he can keep 10,000 gp in a bank, he's of the gentry. At that point, he's stuck . . . unless he can achieve Name experience level and persuade the Empress to let him have a dominion outside Alphatia and Bellissaria—say, bordering Norwold, or in the Isle of Dawn, or Esterhold, or the Yannivey Island chain. If he can do so, he can become a king of a nation of the Empire . . . but will still more or less be counted a commoner when on continental Alphatia.

Thieves have the same opportunities and restrictions as fighters.

Clerics are counted as gentry when they join their clerical order and during their first experience level. Thereafter, they are aristocrats equal in status with magic-users; they no longer bear any social stigma. They may rise to lord/lady by the usual means of keeping 10,000 gp in the bank and operating a business or occupying a government office. To achieve higher rank, they must reach Name level and petition the Empress for a dominion. They may be kings and queens in Alphatia and Bellissaria, though this is unusual; it is very respectable for them to colonize elsewhere.

Elves, being wielders of magic, are automatically aristocrats within the empire. They may rise to lordship by the usual means, be princes if they are heirs to a throne, and may become king or queen of a nation.

Dwarves are mostly treated as fighters. A dwarf-cleric (see GAZ 6, *The Dwarves of Rockhome*) who is publicly known to be such (and this is increasingly common in the nations of Stoutfellow and Limn) is treated as a cleric.

Halflings are mostly non-magical and thus rise no higher than gentry level. But because halflings can become masters and learn magic (see GAZ 8, *The Five Shires*), and could conceivably take a late jump from commoner to aristocrat, Alphatians tend to take them a little more seriously. A non-magical halfling is never going to be granted a dominion in Alphatia or Bellissaria, but might be in Norwold and distant subject territories. A Master halfling can progress to lord/lady, prince/princess, and king/queen ranks by the usual means.

Alphatian Society and Politics



Only human wizards can ever achieve the rank of Emperor or Empress.

Shamans and wiccans, when tolerated (such as in Trollhattan), bear the rank of aristocrat.

Education

Parents and patrons must bear the cost of educating commoner children; those who can afford to hire tutors, buy lessons, or send their children to schools. These schools are not subsidized by the empire; the parents pay tuition and sometimes boarding costs. Those who cannot afford to buy any sort of education will teach their children themselves, whatever they can.

Clerical orders double as schools for their clerics. A cleric will receive a good education throughout his career. Additionally, some clerical orders provide low-cost or free tutoring for promising pupils, even those who seem to have no clerical leanings.

Alphatia boasts many fine schools and universities for magic-users. At the upper income level, there are schools costing thousands of gp in tuition a year. At the lower level, there are special types of boarding schools where students learn magic, assist their masters, and use their magics to earn income to offset their tuition and boarding costs—this works out to being “free” (no cost to the parents) education, but doesn’t get the student past about third experience level.

The Law

You’ve already seen that the Alphatian Empire is made up of many kingdoms ruled by their own kings, who are ruled by the Empress, who is in turn kept in check by the Grand Council. Imperial Law concerns itself with the maintenance of the status quo. It protects the rights of wizards to life, liberty, and the pursuit of knowledge; it sets the scale of social status used in most of the Em-

pire; it decrees how succession of lesser thrones is handled within the empire; it establishes imperial taxes (which are in addition to local-kingdom taxes) and enforces their collection; and so on.

However, beyond that point, individual kings have broad discretion as to other laws in their kingdoms. Theft may bring a fine in one nation, the death penalty in another. There may be no slaves in one nation; in another, persons not of aristocrat rank or above are automatically slaves.

High and Low Justice

Throughout the Empire, laws of crime and punishment are divided into two categories: Low Justice and High Justice. Low Justice is for commoners, High Justice for nobles. Each has its own set of judges in each nation.

In Alphatian law, the court tries to determine guilt or innocence. The courts lean to the side of innocence; the guilty verdict means that the defendant should not have done what he did or had evil motivations for his act and is unrepentant. Since *ESP* is always used in criminal proceedings, justice is swift and almost 100% accurate in Alphatia.

An innocent verdict may still be accompanied by court orders to compensate the victim . . . but the defendant is not otherwise censured by the court.

Here are some examples of Low and High Justice which are pretty common throughout the Empire.

Low Justice: Crimes by Commoners

Crime	Sentence
Assault	
on Commoner	Fine (1)
on Noble	Fine (1)x10
Fraud	
Same as Theft	

Insolence	
to Aristocrat	10 lashes
to Lord	20 lashes
to Prince	Confiscation (2)
to King	Confiscation (2)
to Emperor	Confiscation (2)
Murder	
of Commoner	Confiscation (3)
of Noble	Confiscation (3)
Rape	
of Commoner	Fine (1)
of Noble	Confiscation (2)
Theft	
to 10 gp	10 Lashes, Repayment
to 100 gp	20 Lashes, Repayment
to 1,000 gp	Confiscation (1)
above 1,000	Confiscation (2)
Treason	Confiscation (3)

Insolence includes deliberate insult, and not calling a nobleman by his title. *ESP* will confirm whether the insolence was deliberate or not.

Murder is defined as the deliberate and unjustifiable taking of a life (human, demihuman, and in a few cases nonhuman). If the killing was justifiable (remember *ESP* confirmation of testimony), the killing was not a crime. The sentences are the same whether or not the victim was brought back to life afterwards.

Fine (1) pays court fees and covers the cost of magically or medically restoring the victim to as close as his or her prior state as possible.

Confiscation (1) means the person has all his goods and wealth confiscated; revenues generated repay the victim for any losses (as Fine (1)) and the remainder goes to the kingdom treasury; this strips the offender to Servant status.

Confiscation (2) means the person has all his goods and wealth confiscated (as Confiscation (1)), but offender is stripped to Slave status and given to the person he offended.

Alphatian Society and Politics

Confiscation (3) means the offender has all his goods and wealth confiscated (as Confiscation (1)), and offender is put to death.

High Justice: Crimes by Nobles

Crime	Sentence
Assault on Commoner	Fine (1)
on Noble	Fine (1)
Fraud Same as Theft	
Murder of Commoner	Fine (1)x100 to heirs
of Noble	Confiscation (3)
Rape of Commoner	Fine (1)x10
of Noble	Confiscation (5)
Theft to 1,000 gp	20 lashes, Repayment
above 1,000	Confiscation (4)
Treason	Confiscation (5)

Confiscation (4) is only for spell-casters. It is the same as Confiscation (1), but the offender remains an Aristocrat. However, his spell-books are confiscated. For the period of one month, it is forbidden to give him any spell-books or scrolls, and he may be killed as if he were a slave during that month . . . which is often accomplished at the hands of vengeful relatives. Spell-casters with very powerful friends usually survive this period.

Confiscation (5) is also only for spell-casters. It is considered the most horrible fate for a spell-caster. The offender's titles and properties are impounded, as in Confiscations above. A panel from the Grand Council casts a united *feeblemind* on the offender, and then *permanence* on the first spell. The offender is reduced to Slave status and given to the victim. (If the offender is a cleric, and *feeblemind* will not work on him, substitute Confiscation (3).

As noted, though, crimes and punishments vary from kingdom to kingdom. In some nations, hunting without a license is no crime; in others, a form of Insolence; in others, a death-penalty crime. And so on. The DM is encouraged to be creative when working up these legal variations; characters had better be on their toes and learn the local regulations when they cross borders.

Organizations

Guilds

The empire has many trade guilds. On Alphatia and Bellissaria, they don't have much pull at all unless they are governed by magic-users. In more distant realms, they wield more power.

Trade guilds typically work to make sure that they get the best possible pay for their workers' efforts, to get high tariffs imposed on imported goods competing with their own, etc. Every major craft or industry will have its own guild; different kingdoms will have different guilds for the same craft.

Clergy

There are several clerical orders in Alphatia, at least one per each of the Immortals described earlier. They're ill-attended and not politically important, but they're there.

Criminal Societies

Because the use of ESP is so damaging to organized crime, there are no *Thieves' Guilds* in Alphatia. There are few in Bellissaria and the Isle of Dawn. Only when you get farther away from the mainland do you see organized thieves. On mainland Alphatia, thieves work with partners or independently.

Economy

The Alphatian Empire has a very strong economy built on two factors: Cheap labor in agriculture (slaves and servants), and magical disaster relief. If, for instance, a drought threatens to destroy the year's wheat-crop in Bellissaria, the Grand Council mobilizes as many wizards as can be shaken free from their interests, and uses magical powers to correct the problem. So the Empire has a very steady economy.

Here, we'll talk about the parts of the economy which affect PCs.

Adventuring Income

Alphatia has one advantage over many other nations: It charges no taxes on treasures won on adventures. Period. However, money earned by hiring one's self out is subject to the income taxes described above.

Coinage

All Alphatian coins bear the words "Alphatia Above All" on their backs (reverses), written in an old dialect of the language; this has been the custom for over 2,000 years.

Beyond that, though, nothing is necessarily the same. Each kingdom may mint its own coins. In weight, they must exactly match the equivalent imperial coins, but may have anything on the face; may have holes in the middle or be shaped like dice; etc.

The imperial coins, standards for the Empire, which are minted in Sundsvall, look like this.

The **Crown** is the gold piece. It is an eight-sided disk with a stylized portrait of Sundsvall, as

seen from the air, on the obverse (front).

The **Mirror** is the silver piece. It is a six-sided disk polished smooth on the obverse.

The **Judge** is the copper piece. It is a flat four-sided (square) coin which shows a stern-faced judge on the obverse. It has its name because it is, traditionally, the coin used to "judge" a random event (by flipping a coin).

But there are all sorts of different coins found in all the different kingdoms of Alphatia. In some places, platinum pieces and electrum pieces are minted; in others, you will find a gold piece ten times the size of a routine gold piece, or an oversized platinum piece worth 50 gp.

The Calendar

The Alphatians, when they made Landfall, found that the Thothians kept a properly-calculated calendar. It utilized twelve months of 28 days, each month broken down into four weeks of seven days each. The Alphatians, not needing to improve on its accuracy, more or less adopted it . . . but gave the months and days new names derived from their original calendar.

The Alphatians made landfall in around what we now would call the first part of Alphamir (Thaumont) of Year 0 (BC 1000 by the Thyatian calendar). Since then, they have counted their New Year's celebration as Alphamir 1, two months off from the new year's day of western peoples. For convenience, we're showing the calendar arranged as the Thyatian calendar is, with Nyxmir (Nuwmont) first.

Calendar dates which are of some importance to the Alphatians follow.

Alphamir 1: Start of the New Year. Art demonstrations, parades, celebrations.

Alphamir 7: Landfall Day. This is the actual, historical day when the Alphatian survivors made Landfall in Alphatia; it is solemn, celebrated with feasts, and ending the week of New Year's celebration.

Alphamir 15: Opening Day. The schools and universities which follow the nine-months-a-year educational plan of the empire now open their doors to students.

Sulamir 13: Empress Eriadna's birthday. It is customary for everyone of gentry level or higher to send a present to the Empress, or at least to donate a coin to a beggar or less-privileged soul in her name.

Sudmir 15: Howling Day. This is a day of the full moon, and it is a celebration of no restraint—Alphatians everywhere (except slaves, but including servants) are expected to neglect their work and their studies, run amok, have fun, and howl at the moon (in both a literal and figurative sense). It is a day of high romance in the Empire.

Alphatian Society and Politics

Islamir 15: Doggerel Days. In the heat of high summer, theatrical companies and scholarly guilds stage a week of competitions of music and the verbal arts. This includes plays, all kinds of music, the telling of jokes and puns, the writing and reading of cheap verse, etc. Alphatians save up their worst jokes, doggerel, and anecdotes all year to dredge it forth in these competitions.

Hastmir 8-15: Wine Festivals. This week-long celebration consists of drinking festivals all over Alphatia; it is more a commoners' festival than a nobles' event, but plenty of nobles participate.

Amphimir 15: Closing Day. The schools and universities following the annual nine-month plan close. Boarding students who have nowhere to go may stay these next three months and study at their own pace; there's not much else to do. All other boarding students are sent home to be burdens to their families during the winter months. This is also a minor feast-holiday in the empire, an acknowledgement of the arrival of winter.

Amphimir 28: The Extra Day. Though the calendar shows Amphimir 28 as part of the regular year, Alphatians actually calculate the year as ending with Amphimir 27. The next day is regarded as being "between the years." It is the Day When Magic Fails. No magic works in the Empire. Magical barriers fall, gates open, imprisoned beings rush free. Magicians prefer to stay indoors, powerless, protected by loyal commoners when possible, while horrible things may be out there roaming the streets.

<p>NUWMONT/NYXMIR</p> <p>Lunadain/Majhur 1 ● 8 ● 15 ○ 22 ○ Gromdain/Tijhur 2 9 16 23 Tserdain/Wojhur 3 10 17 24 Moldain/Thajhur 4 11 18 25 Nytdain/Flajhur 5 ○ 12 ○ 19 ○ 26 ○ Loshdain/Sejhur 6 13 20 27 Soladain/Lajhur 7 14 21 28</p>	<p>VATERMONT/AMPHIMIR</p> <p>Lunadain/Majhur 1 ● 8 ● 15 ○ 22 ○ Gromdain/Tijhur 2 9 16 23 Tserdain/Wojhur 3 10 17 24 Moldain/Thajhur 4 11 18 25 Nytdain/Flajhur 5 ○ 12 ○ 19 ○ 26 ○ Loshdain/Sejhur 6 13 20 27 Soladain/Lajhur 7 14 21 28</p>	<p>THAUMONT/ALPHAMIR</p> <p>Lunadain/Majhur 1 ● 8 ● 15 ○ 22 ○ Gromdain/Tijhur 2 9 16 23 Tserdain/Wojhur 3 10 17 24 Moldain/Thajhur 4 11 18 25 Nytdain/Flajhur 5 ○ 12 ○ 19 ○ 26 ○ Loshdain/Sejhur 6 13 20 27 Soladain/Lajhur 7 14 21 28</p>
<p>FLAURMONT/SULAMIR</p> <p>Lunadain/Majhur 1 ● 8 ● 15 ○ 22 ○ Gromdain/Tijhur 2 9 16 23 Tserdain/Wojhur 3 10 17 24 Moldain/Thajhur 4 11 18 25 Nytdain/Flajhur 5 ● 12 ○ 19 ○ 26 ○ Loshdain/Sejhur 6 13 20 27 Soladain/Lajhur 7 14 21 28</p>	<p>YARTHMONT/SUDMIR</p> <p>Lunadain/Majhur 1 ● 8 ● 15 ○ 22 ○ Gromdain/Tijhur 2 9 16 23 Tserdain/Wojhur 3 10 17 24 Moldain/Thajhur 4 11 18 25† Nytdain/Flajhur 5 ○ 12 ○ 19 ○ 26 ○ Loshdain/Sejhur 6 13 20 27 Soladain/Lajhur 7 14 ● 21 28</p>	<p>KLARMONT/VERTMIR</p> <p>Lunadain/Majhur 1 ● 8 ● 15 ○ 22 ○ Gromdain/Tijhur 2 9 16 23 Tserdain/Wojhur 3 10 17 24 Moldain/Thajhur 4 11 18 25 Nytdain/Flajhur 5 ○ 12 ○ 19 ○ 26 ○ Loshdain/Sejhur 6 13 20 27 Soladain/Lajhur 7 14 21 28</p>
<p>FELMONT/TSLAMIR</p> <p>Lunadain/Majhur 1 ● 8 ● 15 ○ 22 ○ Gromdain/Tijhur 2 9 16 23 Tserdain/Wojhur 3 10 17 24 Moldain/Thajhur 4 11 18 25 Nytdain/Flajhur 5 ○ 12 ○ 19 ○ 26 ○ Loshdain/Sejhur 6 13 20 27 Soladain/Lajhur 7 14 21 28</p>	<p>FYRMONT/ANDRUMIR</p> <p>Lunadain/Majhur 1 ● 8 ● 15 ○ 22 ○ Gromdain/Tijhur 2 9 16 23 Tserdain/Wojhur 3 10 17 24 Moldain/Thajhur 4 11 18 25 Nytdain/Flajhur 5 ○ 12 ○ 19 ○ 26 ○ Loshdain/Sejhur 6 13 20 27 Soladain/Lajhur 7 14 21 28</p>	<p>AMBYRMONT/CYPRIMIR</p> <p>Lunadain/Majhur 1 ● 8 ● 15 ○ 22 ○ Gromdain/Tijhur 2 9 16 23 Tserdain/Wojhur 3 10 17 24 Moldain/Thajhur 4 11 18 25 Nytdain/Flajhur 5 ○ 12 ○ 19 ○ 26 ○ Loshdain/Sejhur 6 13 20 27 Soladain/Lajhur 7 14 21 28</p>
<p>SVIFTMONT/HASTMIR</p> <p>Lunadain/Majhur 1 ● 8 ● 15 ○ 22 ○ Gromdain/Tijhur 2 9 16 23 Tserdain/Wojhur 3 10 17 24 Moldain/Thajhur 4 11 18 25 Nytdain/Flajhur 5 ○ 12 ○ 19 ○ 26 ○ Loshdain/Sejhur 6 13 20 27 Soladain/Lajhur 7 14 21 28</p>	<p>EIRMONT/EIMIR</p> <p>Lunadain/Majhur 1 ● 8 ● 15 ○ 22 ○ Gromdain/Tijhur 2 9 16 23 Tserdain/Wojhur 3 10 17 24 Moldain/Thajhur 4 11 18 25 Nytdain/Flajhur 5 ○ 12 ○ 19 ○ 26 ○ Loshdain/Sejhur 6 13 20 27 Soladain/Lajhur 7 14 21 28</p>	<p>KALDMONT/BURYMIR</p> <p>Lunadain/Majhur 1 ● 8 ● 15 ○ 22 ○ Gromdain/Tijhur 2 9 16 23 Tserdain/Wojhur 3 10 17 24 Moldain/Thajhur 4 11 18 25 Nytdain/Flajhur 5 ○ 12 ○ 19 ○ 26 ○ Loshdain/Sejhur 6 13 20 27 Soladain/Lajhur 7 14 21 28</p>

MAIN CALENDAR KEY

- | | | |
|-----------------------|-----------------------------|-----------------------------|
| ● New Moon | ○ Quarter Moon Waxing | ○ Three Quarter Moon Waxing |
| ○ Quarter Moon Waning | ● Half Moon | ○ Full Moon |
| | ○ Three Quarter Moon Waning | |

Character Creation



Races and Character Classes

You probably have a good idea of which character classes/races are represented (and how) in Alphatia, but let's briefly review those facts:

Cleric: There are not many clerics in Alphatia, but there are some. You are free to make your character a cleric. Most clerics in Alphatia live in the larger cities; there are more from the city of Draco (nation of Stonewall) than elsewhere, so you might think about your character being from Draco. Clerics are better-regarded in the colonies than in Alphatia herself, so the Isle of Dawn, Norwold, and so forth are good places of origin for clerics.

Clerics are automatically Gentry at first level, Aristocrats at higher levels, in the Alphatian culture. While Alphatians mostly aren't interested in clerical teachings, they accord magic-using clerics the respect that all spell-casters are accorded in Alphatia.

Don't forget to choose an Immortal for your cleric to honor; you may choose one of the ones mentioned in "Alphatian Society and Politics," or any other mentioned in this or other *Gazetteers*. When you have chosen, your cleric belongs to an order of clerics all honoring the same Immortal; the order may be of decent size or very small, depending on how popular and well-known the Immortal is in Alphatia.

Fighter: There are many fighters in Alphatia (though not so many as in Thyatis), and you are free to make your character a fighter. Note that fighters are second-class citizens in the Empire, especially on Alphatia proper. The nations of Greenspur and Stonewall are

good places for fighters to come from, as are outlying colonies, but a fighter can be from anywhere in the Empire.

Your Fighter character automatically starts out with the social rank of Servant, and you and the DM must figure out who is his employer; he will probably be able to graduate to Freeman very quickly.

Magic-User: You've already gathered that the magic-user is top dog in Alphatia. Magic-users are automatically Aristocrats.

Thief: The life of the thief is precarious in mainland Alphatia, because magic-based detective work is so successful. You might think about being one of the rake characters mentioned in Book II, in that book's "Character Creation" section. The nation of Stonewall is fairly friendly to thieves; the island of Ne'er-do-well certainly is. In the outlying colonies, thieves live their lives much as they do in foreign nations, and the city of Landfall in Norwold is a notorious haven for thieves.

Thieves, like fighters, automatically begin with the social rank of Servant, but should (with adventuring treasures) be able to graduate to Freeman fairly fast. Remember that there is no Thieves' Guild in Alphatia or Bellissaria, but there are Guilds elsewhere in the Empire.

Dwarf: There is only one dwarf-community in mainland Alphatia—Denwarf-Hurgon, in the nation of Stoutfellow. All native Alphatian dwarves are from there.

Because the dwarves arrange for all their sons and daughters to have it so, all dwarves begin play with the social rank of Freeman, and have official business addresses (if very small) back in Denwarf-Hurgon. If you're using GAZ 6, *The Dwarves of Rockhome*, and are playing a dwarf-cleric, you can be counted

an Aristocrat if you let it be known you are a dwarf-cleric; if you keep your clerical abilities a secret, then you stay a Freeman.

Elf: There are many elf-communities in mainland Alphatia; Alfleigh, in the nation of Shiye-Lawr, is the greatest of them.

All elves are Aristocrats in Alphatian culture.

Halfling: Most halflings in mainland Alphatia live in the nation of Stoutfellow. And, because magic-users are so revered here, most aspire to be Masters (if you're using GAZ 8, *The Five Shires*, that is).

Halflings begin play as Servants; once they learn their first spell as a Master, they are automatically promoted (from Servant or Freeman to Aristocrat; from Gentry to Lord/Lady). Norwold has many halfling communities as well.

Forester: The Thyatian class of Foresters is not represented in Alphatia.

First-Level Magic-User Spells

Bleach

Range: Touch

Duration: Permanent

Effect: Fades pigments, dispels color

This spell was created by hedge-wizards (low-level magic-users whose spells are mostly concerned with household affairs). Each application of the *bleach* spell will bleach a certain amount of material down to its original color—one basket of laundry, one painting, one application of *color* spell, one tattoo, etc.

Ordinary stains are automatically bleached. When cast on a *color* spell, it will only work if

Character Creation

the caster is the same level or a higher-level than the caster of the *color*. When cast on normal art, such as a painting or a tattoo, the DM gives the artwork a saving throw. The greater and more skilled the art, the more likely it is to survive unhurt. A child's scrawlings may get no saving throw, while the great work of a grand master may save as a 24th-level magic-user.

The spell will not discolor the surfaces beneath the pigments or paints. Cast on a tattoo, for instance, it will entirely eliminate the tattoo, but the skin beneath will be normally colored.

Second-Level Magic-User Spells

Color

Range: Touch

Duration: Permanent, until *bleached*; casting duration up to twelve turns (two hours)

Effect: Changes color of affected area

This spell allows the caster to lay magical color down on a surface. The surface may be as small as the nose on a tiny china miniature, or as large as a 20'x20' area of wall. The casting time may be as short as a round for one simple color (for instance, tinting a room wall sky-blue) or may go on for a couple of hours. During that time, the caster may vary the color of the whole area, or may color different parts of the area in different ways.

The effect of this is that the magic-user can "paint" for up to two hours at a time, colors that are permanent and nearly imperishable by age and weather. A *dispel* will not remove color; only *bleach* or a *wish* can.

Different spellcasters use this for different purposes. Artists use it to make paintings that will not fade, or to decorate themselves and others with brilliant body-colors and face-painting. Builders use it to retint stone and wood to be more beautiful.

If one casts a *color* on top of another *color*, the second spell has no effect . . . unless the second caster is of equal or higher level than the first, in which case the second spell covers up the first. But the first spell is not gone; to get rid of it, one would have to *bleach* away both *color* spells. Magic-users may leave messages for one another this way; they choose an agreed-upon message drop, and one wizard uses one application of *color* to write a message, and another to cover it up to look like it did before. The next magic-user will use a *bleach* to uncover the message, and then either cover it over again or use another *bleach* to erase it.

Just because a character can lay down color with this spell doesn't make him good at it. To be truly artistic with the use of this spell, a character must have some sort of Artisan skill, as described later in this section. Someone without Artisan will be able to lay down color just like anyone with no artistic ability.

Third-Level Magic-User Spells

Climate

Range: Immediate area, 8,000 cu. ft.

Duration: 1 hour per level of caster

Effect: Maintains area at specific temperature, humidity, etc.

This spell is used to alter an area to be more comfortable to its residents. When cast, it affects an area of up to 8,000 cubic feet (for instance, a 20'x20'x20' area, or eight connected 10'x10'x10' rooms) and changes the climate to the caster's liking. Each casting of the spell can change a different area to a different climate.

The spell cannot change a normal environment into a harmful one (cannot bring on freezing cold or blistering heat) or change a harmful environment into a safe one. But it can keep one's tower cool on hot summer days or warm on cold winter nights.

Magic-users often cast this spell on a room and use *permanence* to make it last. Each room may thus be a different, unvarying temperature; a workroom could be maintained cool and dry, while a "sauna" room could be very warm and humid.

The *climate* spell is *dispelled* normally.

Create Air

Range: Immediate area, 8,000 cu. ft.

Duration: 1 hour per level of caster

Effect: Provides breathable air

This spell is used to provide breathable air, especially in areas where otherwise there is none to be had. Like *climate*, above, it is cast on a volume of 8,000 cubic feet (like a 20'x20'x20' room) and, while it is in effect, everyone in that area has clean air to breathe.

Customarily, it's used when dungeon explorers are trapped in an area where air is running out.

However, it may be cast upon or enchanted upon different types of vehicle or magical transportation—such as a vehicle that travels underwater or one that sails so high that people cannot breathe. When it is so cast, the vehicle's cabin becomes pressurized with fresh air and its crew may breathe normally.

The spell may be cast upon one person, whereupon he can breathe normally. It's not the same as *water breathing*, though—if he dives underwater, he can still breathe, but great quantities of air are always bubbling up from him.

The spell may be cast upon a specific piece of equipment like a helmet, and whichever one person wears it may breathe normally.

The spell does not protect people from the effects of poison gasses.

Fourth-Level Magic-User Spells

Clothwall

Range: Touch

Duration: Permanent

Effect: Creates up to 30'x30' cloth

This spell creates quantities of cloth up to 30'x30'. The cloth created by a single spell must appear in one piece. Unlike many creation-type spells, this one creates cloth that is non-magical and non-*dispellable*.

If the caster has an appropriate craftsman skill, he may shape the cloth as he creates it. He may thus create a tent, a sail, a single garment, a drape, 60' of common rope, etc.

The cloth so created is much like undyed linen—tough and serviceable. A caster can create his cloth with an unfinished end, and later he or another caster can use another *clothwall* to create cloth joined to the first on that edge—and there will be no seam or weakness at the joining. This makes it a good spell for creating rugged, dependable sails.

When created, the cloth extrudes from the caster's hands and out along the ground. If there are obstacles, it piles up against them but does not shove them back. The spell may not be cast to create a huge sheet which falls over a unit of enemies, for instance. The cloth, when created, may not be attached to anything (other than as described in the paragraph above), so you cannot create a cloth barrier over a door.

The cloth cannot be cast in a space occupied by another object.

In adventures, this spell is often used to make quick shelters, to cover hastily-dug foxholes to ambush enemies, and to create rope.

Fifth-Level Magic-User Spells

Fabricate

Range: 10'

Duration: Permanent (casting time up to 1 turn)

Effect: Creates goods, foods

This is a catch-all spell which creates materials useful to adventurers and others. Food, drink, and clothing, and other soft goods may be so created. The spell may create food and drink, or cloth and leather, or softwoods and porcelain; hardwoods, stones, metals, etc. may not be created.

As a rule of thumb, each casting of the spell will create one person's worth of the material in question. When it is used to make food and drink, it creates one day's rations.

Therefore, one application of the spell could create:

One day's rations, including water and food (iron rations), but not the containers for them; or

A good meal for up to three people (this equals three meals for one person), including main course, side dishes, wines, etc.; or

Table settings (wood and porcelain) for up to three people; or

A complete outfit, including belt and boots (with leather ties or wooden buckles), waterskins and sheaths, for one person; or

A saddle and bridle for one horse; or

One softwood staff (other types of wooden weapons cannot be created), which always breaks on a 1 in 6; and so on.

Like the *clothwall* spell, this spell produces materials that may not be *dispelled*.

It helps if this spell is used with some sort of general skill. If the caster does not know how to cook, for instance, he can still *fabricate* food—but it is going to be plain. If he cannot sew or tailor, the clothes he creates will be shapeless and baggy. If he knows nothing of the cobbler's arts, the shoes he creates will probably be uncomfortable. Since the caster can stretch out the casting time to one full turn (he can make it take as little as one round), if he has an expert or craftsman on hand, he can get that person's advice and do a good job with his *fabrication*.

This spell is not so powerful as the clerical *create water* or *create food*, but it is more versatile.

Woodwall

Range: Touch

Duration: Permanent

Effect: Creates 1,000 cubic feet of wood

This spell creates a mass of wood equal to 1,000 cubic feet; it may be arranged in any fashion the caster desires (10'x10'x10' block, 25'x20'x2' wall, etc.)

Casting time varies depending on the complexity of the design. A simple wall and other simple shapes take 1 round. A simple staircase may take 10 rounds (1 turn). A complicated design which is supposed to adhere to very tight specifications—such as the keel of a ship—could take the maximum time allowable, 12 turns (2 hours) just to work up in rough form. When the caster wants to try a complicated or unusual design, the DM decides how long the casting will take.

The object must be created as a single piece, with no moving parts. The original caster of the spell may later cast *woodwall* on an object he has already created, in order to modify it for up to two hours. This is how magic-user artists often make fine woodcarvings, for instance. When he is satisfied with his work, he casts *woodwall* on it a third time to "lock it in place," and it may no longer be modified by magic—just destroyed.

The mass of wood must be created so as to rest on the ground or similar support, and cannot be cast in a space occupied by another object.

A caster can create his wood with one or more rough sides, and later he or another caster can use another *woodwall* to create wood joined to the first on that side—and there will be no seam or weakness at the joining. This makes it a good spell for creating strong ships and wooden buildings.

The caster may decide what sort of wood is created, within reason. Wood from an *elvish tree of life* is an inappropriate choice, for instance; the DM may refuse to allow the caster to pick very expensive, exotic, or magical woods.

The wood so created is not *dispellable*; it lasts until broken through, burned, or destroyed by spells like *disintegrate*.

The AC and hp of building materials are given in the *Master Players' Book* on page 28. Based on those guidelines, a wall of wood has an AC of -4(6) and 60 hp per 1' thickness. Most building exterior walls would be about 8" thick and have 40 hp.

Sixth-Level Magic-User Spells

Disguise

Range: Self Only

Duration: 144 Turns (1 Day)

Effect: Changes caster's form

This spell allows the caster to take on a disguise. He can change his height, weight, smell, gender, appearance, and species (to known demihuman or non-giant humanoid species, and only to heights and weights appropriate for those species). His Hit Dice and hit points do not change; special abilities and special immunities of the new form are not gained.

It does not allow the caster to take on the face of another specific person. In fact, he cannot even *accidentally* take on the face of some specific person; if he conceives of a face that matches some other person's, the spell will approximate what he is visualizing but not be able to duplicate it.

Spells may be cast while the caster is *disguised*.

This spell is *dispellable*. The caster may drop his *disguise* at any time; otherwise, it lasts one full day, even when the caster is asleep or unconscious. If he dies, though, he reverts to his original form.

Stonewall

Range: Touch

Duration: Permanent

Effect: Creates 1,000 cubic feet of stone

This spell creates a mass of stone equal to 1,000 cubic feet; it may be arranged in any fashion the caster desires (10'x10'x10' block, 25'x20'x2' wall, etc.).

Casting time varies depending on the complexity of the design. A simple wall and other simple shapes take 1 round. A simple staircase may take 10 rounds (1 turn). A complicated design which is supposed to adhere to very tight specifications—such as an ornate fountain or statue—could take the maximum time allowable, 12 turns (2 hours) just to work up in rough form. When the caster wants to try a complicated or unusual design, the DM decides how long the casting will take.

The object must be created as a single piece, with no moving parts. The original caster of the spell may later cast *stonewall* on an object he has already created, in order to modify it for up to two hours. This is how magic-user artists often make fine statues, for instance. When he is satisfied with his work, he casts

Character Creation

stonewall on it a third time to "lock it in place," and it may no longer be modified by magic—just destroyed.

The mass of stone must be created so as to rest on the ground or similar support, and cannot be cast in a space occupied by another object.

A caster can create his stone with one or more rough sides, and later he or another caster can use another *stonewall* to create stone joined to the first on that side—and there will be no seam or weakness at the joining. This makes it a good spell for creating strong walls and gigantic buildings—coliseums, palaces, etc.

The caster may decide what sort of stone is created, within reason. Valuable jade, for instance, is an inappropriate choice; the DM may refuse to allow the caster to pick very expensive, exotic, or magical stones. However, a caster can choose such stones as clear lead crystal, and so make thick, strong, perfect windows with this spell.

The stone so created is not *dispellable*; it lasts until broken through or destroyed by spells like *disintegrate*.

The AC and hp of building materials are given in the *Master Players' Book* on page 28. In general, from those guidelines, stone walls have an AC of -4(6) and 100 HP per 1' thickness; doing 500 HP damage to a 5' wall will definitely knock a hole in it. Building exterior walls tend to be about 7" thick and have 60 hp.

Seventh-Level Magic-User Spells

Ironwall

Range: Touch

Duration: Permanent

Effect: Creates 500 square feet of iron

This spell creates a wall of iron 2" thick (or less) with an area equal to 500 square feet; it may be arranged in any fashion the caster desires (10'x50' wall, or 25'x20' wall, etc.).

Casting time varies depending on the complexity of the design. A simple wall and other simple shapes take 1 round. A simple staircase may take 10 rounds (1 turn). A complicated design which is supposed to adhere to very tight specifications—such as a giant portcullis—could take the maximum time allowable, 12 turns (2 hours) just to create in rough form. When the caster wants to try a complicated or unusual design, the DM decides how long the casting will take.

The object must be created as a single piece, with no moving parts. The original caster of the spell may later cast *ironwall* on an object he has already created, in order to modify it for up to two hours. This is how magic-user artists often make fine bronze statues, for instance. When he is satisfied with his work, he casts *ironwall* on it a third time to "lock it in place," and it may no longer be modified by magic—just destroyed.

The iron wall must be created so as to rest on the ground or similar support, and cannot be cast in a space occupied by another object. Unlike the metal created by the *wall of iron* spell, it does not have to be created in a vertical position.

A caster can create his iron with one or more rough sides, and later he or another caster can use another *ironwall* to create iron joined to the first on that side—and there will be no seam or weakness at the joining. This makes it a good spell for creating iron reinforcements for walls.

The iron so created is not *dispellable*; it lasts until broken through or destroyed by spells like *disintegrate* or creatures such as rust monsters.

The AC and hp of building materials are given in the *Master Players' Book* on page 28. Following these general guidelines, an iron wall will have an AC of -10(2) and about 15 hp per 1" thickness.

Eighth-Level Magic-User Spells

Duel-Shield

Range: 120'

Duration: 12 Turns (2 hours), or Special

Effect: Creates an impenetrable force wall around duellists

This is a very special spell used to conduct duels in Alphatia. It requires two magic-users, both with the *duel-shield* spell, to cast one duel shield.

When it is cast, the spell creates a force-field bubble 60' in diameter. It can only be cast around persons consenting to be trapped within it, and those persons must be intending to duel one another to the death.

The force-field bubble created by this spell is impenetrable to most magics which mortals can cast. The magic spells cast within the field cannot penetrate the field at all, or affect it—not even a *wish* can affect the shield when cast from within it.

Most magic spells cast from outside the field cannot penetrate it; only a *wish* cast from

outside can bring it down. However, an Immortal can cast an effective *disintegrate* or *dispel magic*.

It is impossible to *teleport*, *gate*, or *dimension door* through the *duel-shield*; someone on the outside could *wish* himself in, but those within cannot *wish* themselves out.

The field lasts until one only one person (or party of allies) is left alive within it. When one side has triumphed and its enemies are all dead, the field evaporates. But if there are still enemies left inside the bubble at the end of 12 turns, the bubble evaporates . . . and everyone still living within it disintegrates, with no *Saving Throw* or resurrection magic possible.

Customarily, when Alphantian magic-users decide that they cannot bear for one another to remain alive, they agree to duel, and by Alphantian law magic-users may only duel within these fields. Usually, a duel consists of only two persons, two wizards fighting to the death. When a duel consists of two or more enemy parties, the duellists must declare allegiances as the spell is being cast, so the spell will know when all members of one side have perished in the duel.

If the judge of the duel chooses, he may have the *duel-shield* brought down with a *wish* . . . but this happens only very rarely.

Impersonate

Range: Self Only

Duration: One Day (144 Turns)

Effect: Change identity to that of other real person

This spell is similar to *disguise*, with two important differences.

First, the *impersonate* spell will allow the caster to take on the form, voice, and smell of a specific, real person. The caster must have studied the person closely to make it believable; if the caster has not made a study of the victim of at least 40 hours' length, the spell will not work. And the spell does not give the caster the ability to take on the victim's manner; that requires the Acting skill.

Second, the *impersonate* spell is not affected by *dispel magic*. However, a *wish* will bring it down, and an *ESP* will reveal that a person's thoughts do not match his face.

To pierce the caster's impersonation, another person must first have some reason to doubt that the caster is who he says he is. It is for the DM to decide if the person has any such reason. If he does, he may roll 1d20 against his Intelligence, as per the General Skills rules. The DM assigns him a modifier based on his familiarity with the real person in question; he'd get a bonus of up to +6 if the

person were his own spouse, or a penalty of up to -10 if he'd only met the person casually once before. If he makes his Intelligence roll, he perceives that the person is not acting quite right . . . but must draw his own conclusions from that.

If the *impersonator* has the Acting skill, he may use it to make his impersonation more believable. When someone is rolling against Intelligence to pierce his impersonation, he rolls against his Acting skill. If he makes his roll, the amount by which he makes it is also assigned as a penalty to the perceiver's Intelligence roll. But if he fails it, the amount by which he fails it is assigned as a *bonus* to the perceiver's Intelligence roll. It's a good idea to be an accomplished actor when using this spell.

Steelwall

Range: Touch

Duration: Permanent

Effect: Creates up to 500 square feet of steel

This spell is effectively identical to the 7th-level *ironwall* spell. However, the material created is of weapon-quality; a person with Swordmaking skill and this spell could cast the spell and create a high-quality sword in a jiffy.

Following the same general guidelines as *ironwall*, a steel wall will have an AC of -10(2) and about 20 hp per 1" thickness.

Ninth-Level Magic-User Spells

Sleep-Curse

Range: 5400' radius

Duration: 100 years, or Special

Effect: Puts victims into suspended animation

This is an appalling and nasty spell which even evil magic-users hesitate to use; they normally only do so when mortally offended. Only magic-users of 36th level may use the spell, and only a very few of them know it.

Persons under 5th level and creatures under 4 HD get no Saving Throw against this spell.

This spell is initially cast on a single victim. If that person makes his saving throw, nothing happens. But if he is of too low a level to have a saving throw, or fails his saving throw:

(1) All persons and creatures within the radius of effect must make their own Saving Throws (if they're of high-enough level) or fall victim to the spell.

(2) Everyone who falls victim to the spell lies down where he is and enters a state of suspended animation.

(3) The entire area of the spell effect is swiftly (within 6 turns) overgrown with massive creeping vines, thorn-bushes, and other obstructive vegetation.

(4) The entire area of the spell effect becomes eerie and uncomfortable. Normal animals will not enter the area. Humans of under 4th level will not willingly enter the area; if dragged in, they make every effort to leave.

(5) The people and animals who succumbed to the spell remain in suspended animation for 100 years or until the conditions named with the spell (explained below) are met. They do not age; animals and monsters will not feed on them. They take no damage from attacks. Victims who are carried outside the area of effect remain the same—they do not awaken.

The caster of the spell, of course, is not put to sleep by its effects. However, the spellcaster loses two experience levels and *permanently loses 3d6 (3-18) hit points immediately upon casting sleep-curse.*

When casting the spell, the caster must specify some sort of key action which will undo all the effects of the spell. The key action may consist of kissing the person on whom the spell is initially cast, or avenging some wrong done to the magic-user, or doing some great deed. The key action cannot be required of a specific person, though it can be targeted at a specific class or type of person. You cannot say, for instance, "Marcello must die for the curse to be broken." You could say, "A mighty fighter must bring the High Periapt of Yith to the castle to break the curse." The true conditions have to be made known to the peoples of the land within a week, or the curse will be lifted—the caster cannot keep the conditions secret.

The persons within the spell effect who do make their Saving Throws aren't entirely unaffected. They still fall asleep, for 1d6 hours, and are magically transported to the very edge of the spell effect—outside the new curtain of interwoven thorns and brambles. The caster does not know where they are transported, and neither he nor his minions will be able to find them before they wake up—they cannot be found and captured before they awaken.

This spell is only used by the most powerful and angry of magic-users.

Races

Common Alphatians have a skin tone ranging from golden to coppery brown; hair ranging from gold to brown, with many redheads also represented; eyes may be brown, gold, green, hazel, or amber, and tend to be

almond-shaped or slightly slanted; they tend to a tall, slender build. They are descended from both the pale-skinned Alphatians and their first imperial conquests, the copper-skinned, cheerful Cypri people.

"Pure" Alphatians have a very pale (nearly white) skin tone with bluish tints; black hair; eyes may be black, blue, or even purple, and are more round than the Common Alphatians'; they are also usually tall and slender. They are descended from Alphatian families who didn't intermarry with the Cypri and so kept many of the old Alphatian characteristics.

Thothians of Edairo and other places on the Isle of Dawn have a light brown complexion; brown or black hair; eyes generally brown; they tend to be short but many are powerfully built.

Jennites from Esterhold are usually descendants of tribes which have been conquered by Alphatians in the nations of Blackrock and Verdan. Typically, the only Jennites wandering the Empire are shamans (clerics) and druids. They have a deep red-brown complexion; brown or black hair and eyes; and tend to be of average height with lithe, strong builds. They paint themselves extravagantly, especially with blue paints, before entering battle.

Race Relations: Alphatia is very much dominated by the two races which came from the other world, common and "pure" Alphatians. They consider themselves, and the weak but cultivated Thothians, as the only really civilized nations in the world. So NPC Alphatians will tend to be condescending to representatives of other races. They won't be deliberately insulting, but will tend to think that persons from other nations are woody, folksy, and somewhat backward people.

Family

You should create details about your character's family background. Your character may come from any sort of family, with DM approval; no matter what you choose, you won't get any more or less the usual amount of starting gold (3d6x10 gp).

No matter what sort of family background you create, you start out as a Servant if you're a first-level fighter, thief, or halfling, one of the Gentry if you're a first-level cleric or dwarf-cleric (Aristocrat afterwards), and an Aristocrat if you're first-level magic-user or elf.

And, no matter what sort of family background you create, you won't automatically inherit any great titles or lands until you've proven you earned them—which is about the

Character Creation

same time other characters begin to win or inherit their own dominions as well.

So when creating details about your family background, you should be thinking about what sort of details make your character more interesting—not which ones would give him some sort of tactical advantage in the campaign.

Names

Alphatian names are created from syllable sounds which suggest the characteristics that the parents want the child to grow into. If the parents hope the child will be powerful and dramatic, they'll give him a name that sounds that way: Karburan or Trintillia, for instance, names which can be boomed across a battlefield. If they hope the child will be artistic and intellectual, they'll give him a name which suggests those qualities: Syndyls or Lourina, for example.

When choosing your character's name, make it sound the way your character is supposed to be—bold, meek, colorful, crude, amused, angry, whatever.

Languages

In the Empire of Alphatia, Alphatian is the Common Tongue. Within Alphatia and Bellissaria, few commoners and no nobles will suffer to have other languages spoken to them (except for some few adventurers who have been broadened by foreign travel). In the colonies, the Alphatian attitude is still not much more forgiving.

Other languages represented within the Empire:

Heldann: Many of the inhabitants of Norwold speak this tongue.

Thothian: Native tongue of the residents of Thothia on the Isle of Dawn. The commoners tend to speak Thothian almost exclusively, knowing only a few words of Alphatian; nobles tend to know both languages.

Thyatian: Most of the residents of Ocean-send in Norwold speak Thyatian.

Jennite: Those of Jennite speak their own tongue among themselves, but learn Alphatian to get by in the Empire.

Elf: The Elvish spoken in Shiye-Lawr is similar to that spoken by the elves of the western continent, but not identical; it is a more sibilant dialect.

Dwarf: This is identical to Rockhome dwarvish.

The halflings tend to speak Alphatian. Many non-human tongues are to be learned in the strange city of Trollhattan.

You should also read the section on "Alignment Language" in the "Character Creation" chapter from Book II.

General Skills

If you're using the General Skills rules in your Alphatian campaign, which we recommend, you should read those rules from the "Character Creation" chapter of Book II.

Specific skills which are of interest to Alphatian characters include:

Intelligence Skills

Alchemy: The ability to recognize and identify common alchemical substances and potions.

Alternate Magics: Basic familiarity with those magics which are not related to standard spell-casting. It includes knowing many magical abilities of well-known Prime Plane and extraplanar monsters, and of Immortal beings.

Artisan: This is the skill of creating art. There are several different types of Artisan skill (painting, sculpture, woodcarving, mosaic, etc.); the player must specify what sort of Artisan his character is. A character with all the color spells in the world cannot create true art with them unless he has Artisan skill. Artisan skill can be used to improve the reaction of NPCs to the party; if the artisan can present the person with a portrait or sculpture of that person (and makes his Artisan roll), he should receive a +2 to reaction.

Engineer: This is the skill of planning, designing, and building large constructions such as houses, bridges, dams, etc. You've seen that Alphatians have magics which enable them to build permanent structures—but without a trained engineer, the structure is just as likely to collapse, or be built on too-soft ground, or suffer some other calamity as is a structure built normally. Engineer can also be used to evaluate constructions the party is passing through or over—what sort of shape they're in, when and by whom they were likely to have been built, and so on.

Magical Engineering: This is the ability to recognize the basic principles of some unfamiliar magical devices. It does *not* include practical training in design or fabrication of magical artifacts. It does include recognition of most common magical items—on a successful skill roll.

Planar Geography: This includes a general knowledge of the Prime, Inner, Outer, Astral, and Ethereal Planes as described in D&D® Companion rules. It includes knowledge of techniques of travel among the planes and

common inhabitants of better-known planes. It does not include knowledge of the Spirit Plane.

Shipwright: This is the engineering skill of shipbuilding. Again, without a trained shipwright, all the magic-users in Alphatia can't put together a large vessel that will stand up to pounding waves and winds. Shipwright skill will also let characters evaluate the ships they're traveling in or encounter, determine who built them and when, etc.

Dexterity Skills

Hard-Ball: This is the skill of the commoner who plays the exciting Hard-Ball sport. The skill wins or loses Hard-Ball contests, of course, but can also help adventurers in tough situations. A successful Hard-Ball skill roll will:

Give a character a +1 to hit with any missile weapon, or a +3 with anything the approximate size, shape, and weight of the game's ball (4"-6" in diameter, spherical, less than three pounds/30 cn);

Give a character a +2 to Saving Throws which are based on agility (dodging the falling concrete block, for instance); and

Give a character a +1 to Opening Doors rolls.

Piloting: This is the equivalent of the Riding skill from Book II, but applies to the flying vessels of the Alphatians. You must take a different category of Piloting for each different type of vehicle, but fortunately air-boats/airships constitutes only one category and yet covers most types of flying vessels the Alphatians create. (Some other, more unusual, categories include flying castles and specialized aircraft shaped like dragons or rocs.)

Treewalking: This is a skill known (in Alphatia) only to the Shiye elves. It enables the elves to stay aloft in trees, transferring from one closely-set tree to another, and working and fighting from a tree branch. Elves with this skill usually succeed with it in normal situations; the skill roll is only necessary when the character is moving at over 15'/round, or fighting, or performing some other complex task while moving across the branches.

Required Skills

Read "Appropriate Skill Choice" from the Character Creation chapter of Book II. Most of its requirements remain the same for Alphatian characters, with one exception:

Elves: Required skills for Shiye elves are *Treewalking* and *Survival (Forest)*.

Magic-Users of Alphatia

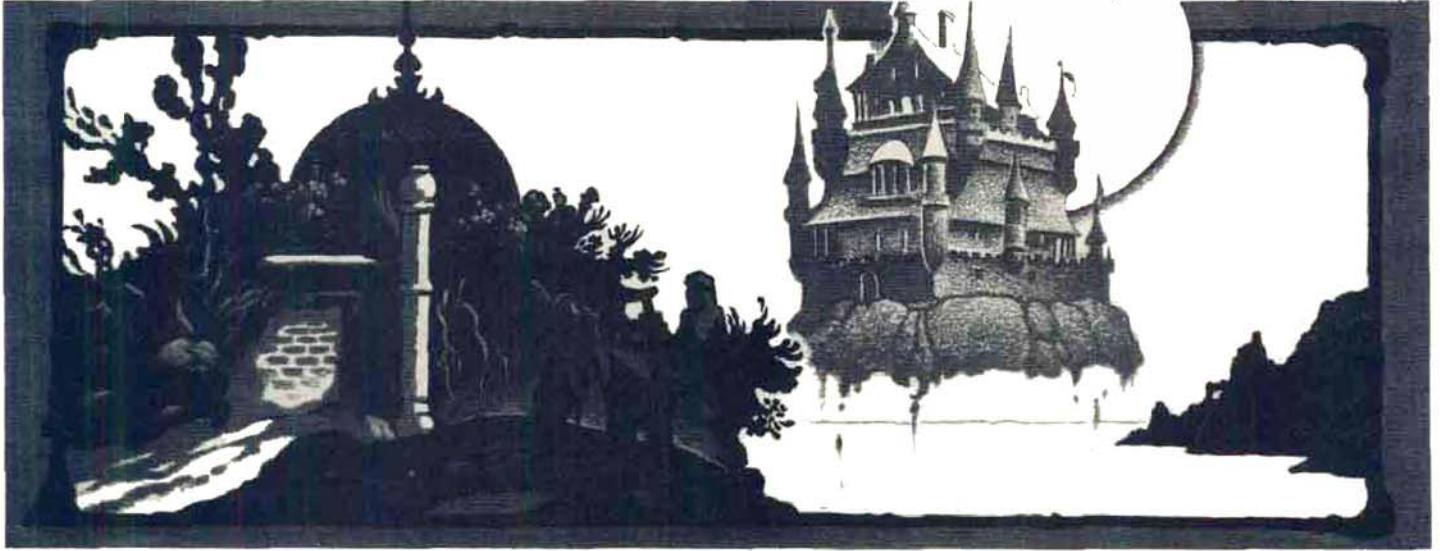

As they walked through the palace corridors, the servants—the luckless many who had no magical abilities—bowed to them. Galatia noted with some satisfaction that, truly, they were bowing to both her and Master Terari now, not just to the gray-beard teacher. But her expected pleasure at this new honor had given way to an unexpected sadness. As she walked, she brooded.

Terari, now long familiar with his charge's moods, smiled to himself. "What now, fair Galatia?" he asked. "Disappointed that they're not strewing rose petals before you?"

"Nothing like that," she snapped. "It just . . . bothers me. I *intend* to accomplish things, to create garments that will some day be looked upon as works of art, to go places and do things . . . and though I haven't done that so far, these servants kowtow to me as though I were a returning hero. They do the same to old Master Phyleret, for all that he slurps zsonga-juice and whiles the whole day away in a drunken stupor."

Terari laughed. "You complain because you feel you are receiving accolades for deeds you have yet to perform?"

"Something like that," she admitted.

The grizzled teacher shook his head. "If it's not too little with you, it's too much. This is something I can't help you with, chickling. It's now up to you to do what you wish to do and create what you wish to create. Garments, wasn't it? I think it's high time you ran off and began researching the magics which will help

you accomplish all these high-blown ambitions of yours . . . so you'll be more comfortable when the servants bow to you. A pity your sort of ambition isn't more widespread . . ."

Making Magic Items

In a land as replete with magic as Alphatia is, a lot of magical item creation takes place. The Alphatians don't just make magical weapons, armor, and potions: They create whole palaces, flying boats, floating castles, undersea cities—anything they can conceive of, they at least *try* to make. Here, we'll talk about the rules for making magical items, from the very small to the impossibly huge.

Permanence Spell

Before we start with the actual rules, we need to make a necessary clarification to the *permanence* spell.

As the spell is described in the *Players' Companion*, the spell "lasts until dispelled by a *dispel magic* from the caster or from some higher level spell caster . . ." But it also says that if "a *permanence* spell is cast on an item or area which already has one . . . both *permanence* spells are immediately negated, along with the spells previously made permanent."

What *that* means is that, even if you're not of high enough level to *dispel* someone else's *permanence*, you can get rid of it automatically by casting your own *permanence* on it. That's not the intent of the rule.

So let's revise the rule. Now, you *cannot* cast a *permanence* on an item or area that al-

ready has one, or a person or creature that already has two, or a weapon that already has five, unless you are the original caster of those spells or are of *higher level* than the caster of those spells.

Basic Magic Item Creation

These rules are derived from those presented in GAZ 3, *The Principalities of Glantri*, and GAZ 6, *The Dwarves of Rockhome*.

Minimum Level

To create any sort of magical item, the character must be at least 9th level. Some magical items will require that he be of higher-level.

Spell Effects

The magic-user must know a spell relating to the magical effect with which he is trying to enchant an object. For example, if he is trying to make a *flying carpet*, he must know the *fly* spell. If he doesn't know the spell, he can't enchant an item with a similar effect.

Spell Components

For every spell with which he's trying to enchant an object, the magic-user must adventure and find some sort of rare element or component. The DM determines exactly what that component is and tells the player. For example, a wizard trying to make a *flying carpet* might have to find a rare silkworm (in a monster-haunted land) or acquire a rare dye (which is processed from the bodies of giant crustacean sea-monsters).

On such an adventure, a magic-user might acquire enough quantities of the rare compo-

Magic-Users of Alphatia

ment to create several such magical items. That's all right, within reason. But if he comes back with a ton of giant murex dye and wants to use it to create *flying carpets* from now until eternity, what inevitably happens is that the dye spoils or is destroyed or stolen by some rival . . . meaning that the character will just have to go out adventuring again.

A magic-user might acquire a lot of a rare material and then try to spread the excess around, trading it to fellow magicians for their excess rare materials. This isn't so good. The DM can simply say that doesn't work—the materials have to be acquired and processed by the magic-user himself, or he isn't familiar enough with them to be able to rely on them. Alternatively, the DM can say this is all right—but the magic-user's project will always require one more rare component which he has to travel forth and acquire himself.

Chance of Success

The first time a character tries to create a specific type of magical item, he isn't necessarily going to succeed—he could fail. His chance for success is rolled on d100, and is calculated this way:

$$((\text{Int} + \text{Lvl}) \times 2) - (3 \text{ per spell level})$$

For example, a 10th level wizard with Intelligence 18 is trying to make a *wand of fire balls*, which utilizes a 3rd-level spell. His chance for success, when we plug all the numbers into the formula, is:

$$((18 + 10) \times 2) - (3 \times 3) = 47\% \text{ on d100}$$

If the character rolls that number or less on d100, he has succeeded in enchanting the item. Whenever enchanting an identical item (different numbers of charges don't make it a different item), he won't need to roll again. If he fails, he's used up all those gold pieces and time, and has to roll again the next time he tries . . . and so on.

This rule presumes the character is using a commonly-known spell, not a newly-discovered one. See GAZ 3, *The Principalities of Glantri*, for rules on inventing new spells and using them in magical items.

The Process of Enchantment

Now that all the spells are determined and all the rare components are assembled, the process of enchantment can begin.

Since this process varies between types of magical items, we'll discuss them individually.

Miscellaneous Magical Items

To create a miscellaneous magic item, the magic-user:

Determines which spells will be cast on the magical item;

Calculates the number of spell levels this adds up to; and

Multiplies that number by 1,000 to determine his cost in gp for materials used in the creation of the magical item.

That figure is called the *initial enchantment cost*. When the magic-user has collected his rare materials, paid his *initial enchantment cost*, and presumably gone through the first necessary rituals, what he has is an energized item which is ready to take its final enchantment.

To finish the job, the magic-user must spend some more money and effort on the item.

First, he must decide if the item is based on charges or is permanent. Items based on charges, such as wands, staves, potions, and scrolls, get used up, though some are rechargeable. Items which are permanent can be used anytime.

The cost for an item to have charges is 10% of the *initial enchantment cost* x the number of charges.

The cost for an item to be permanent is 5x the *initial enchantment cost*. (This is the same cost as if the item had 50 charges, and in GAZ 3 in fact, the cost is given as being as per 50 charges.) Making an enchantment permanent has nothing to do with, and does not require the presence of, the *permanence spell*.

Example: A magic-user wishes to create a wand of polymorph others. This is a 4th-level spell, and is the only spell on the wand, so his initial enchantment cost is (4x1,000 gp =) 4,000 gp. Now, he wants to charge it—and to give it 25 charges. The cost is (10% of the initial enchantment cost, or 4,000 gp, x the number of charges, or 25) 10,000 gp. Total cost of the wand: 14,000 gp.

Example: A magic-user wishes to create a ring of lore. This is a 7th-level spell, so the initial enchantment cost is 7,000 gp. Now, he wants to make it permanent; the cost is 7,000 gp x 5, or 35,000 gp. Final cost: 42,000 gp.

Time Used

Magical items take time to make: one week, plus 1 day per 1,000 gp cost. For the examples above, the *wand of polymorph others* would take 31 days—one week plus 1 day per 1,000 gold pieces cost. The *ring of lore* would take 49 days.

During this time, the magic-user must be working fairly steadily at his workshop—eight hours per day. (More hours per day really won't speed the process up; magic materials need time to "soak up" the magical spells. Fewer hours per day will slow things down, however.)

The magic-user cannot be running about adventuring during this time, though he could naturally get involved in adventures within a short traveling distance of his workshop.

If the magic-user takes a day or two break from the enchantment process, it won't do anything more than slow the creation down a day or two. If he takes more than two days off, however, the enchantment is spoiled; the item is ruined and cannot be enchanted. He loses all the gold the item costs, and has to start over.

Recharging Items

The cost of recharging items is equal to the original cost of charges—10% of the Initial Enchantment Cost x number of charges.

Potions or scrolls are items with charges, one charge per dose of potion or spell on a scroll. Note that different spells on one scroll are considered separate magical items.

Items with charges can't be recharged beyond the original number of charges they had when created.

A wizard may decide at the moment of creation that an item with charges is non-rechargeable. In this case, reduce the Initial Enchantment Cost by 20%.

Multiple Enchantments

If an item has several separate powers (this includes miscellaneous magic and weapons), then the creator must roll a chance for success (as described above under the headline "Chance of Success") for all spells, regardless of how many times he might have created the same sort of item. Each successful roll indicates the item gains the power rolled for. A failure means the corresponding effect is lost, and no more enchantments may be added.

In other words, if the first roll fails, the whole item is spoiled, the money spent, and the time lost. If the first roll is a success but the second one fails, then the first spell is successfully enchanted . . . but the second was a failure, and no new ones may be added.

Example: A 20th level, 18 Intelligence wizard makes a crystal ball with ESP. That's two effects—clairvoyance and ESP. The initial enchantment cost is 5,000 gp (one 2nd-level and

one 3rd-level equals 5 levels). The wizard must roll success for both spells.

He rolls for the clairvoyance first, as it's the main component of a crystal ball. His chance is: $((18 + 20) \times 2) - (3 \times 3)$ or 67%.

He rolls for the ESP next. His chance is: $((18 + 20) \times 2) - (3 \times 2)$ or 72%.

If he makes both rolls, he has a crystal ball with ESP. If he makes the first roll but fails the second, he has a plain crystal ball. If he fails the first roll, he has a spherical lump of crystal which cannot ever be enchanted again. Whether he succeeds fully, partially, or not at all, though, he has to pay the rest of the cost for the crystal ball: 5x the Initial Enchantment Cost equals 25,000 gp more. His total cost, succeed or fail, is 30,000 gp.

Uses per Day

Some permanent items may only be usable a certain number of times within a given time length. When creating a magical item with that sort of limitation on it, you reduce the Initial Enchantment Cost 20% for items which can be used once an hour, 25% for once a day, 30% for once a week, 35% for once a month, etc. Then, add the cost of 30 charges, plus one per use during the chosen time frame.

Example: A wand of fire balls usable twice per day is structured this way:

Initial Enchantment Cost: 2,250 gp (3,000 gp - 25%).

Cost for Charges: 7,200 gp (2,250 x 10% x 32 charges).

Total Cost: 9,450 gp.

Spells of Variable Power Levels

Some spells differ in power with the level of the caster—spells such as *fire ball* are especially dramatic examples. When creating magical items, magic-users must conform to the ordinary limits of the examples of such items already found in the D&D® game. Wands may not be made to do more than 6 dice of damage; staves may not be made to do more than 8 dice of damage; rings and many types of miscellaneous magical items cannot be enchanted with damage-type spells. When in doubt, find an example in the D&D books that most closely resembles the treasure you're trying to enchant and then see what the DM has to say; he may or may not let you create that magic item.

Also, when you begin creating magic items, familiarize yourself with the "Dispel Magic" section from the *Master DM's Book*. It describes what happens to permanent items when struck with *dispel magic* spells.

Limits on Magic Item Creation

It's nice to have magical items on hand—but it's not nice to unbalance the campaign with them. The DM is within his rights to forbid you to create any item that he thinks will unbalance the campaign.

One type of magical item which can critically unbalance a campaign is a wand or staff, especially of a damaging spell, created without charges (so one can fire spells with it continuously).

In Review

Miscellaneous Magic Items

Initial Enchantment Cost: Total Spell Level x 1000 gp

Cost of Charges: (10% of Initial Enchantment Cost) x number of charges

Cost of Permanency: 5x Initial Enchantment Cost

Total Cost: (Initial Enchantment Cost + Cost of Charges) or (Initial Enchantment Cost + Cost of Permanency)

Item with Charges is Non-Rechargeable: Reduce Total Cost by 20%

Items Usable Only a Certain Number of Times in one Time Period (affects Initial Enchantment Cost):

Usable # times per hour: -20%

Usable # times per day: -25%

Usable # times per week: -30%

Usable # times per month: -35%

Calculate as per 30 charges + # of charges used per time period

Weapons and Armor

The procedure for bestowing "plusses" or "minuses" on weapon and armor items requires a different method than for miscellaneous magical items. To find the Initial Enchantment Cost, multiply the item's normal price (in gold pieces) by its encumbrance (in coins). For armor, divide this result by 3; for weapons, multiply it by 5. Always round the result up to the next 10. This final result is the Initial Enchantment Cost.

Armor Initial Enchantment Cost:
(Item Price (gp) x Enc. (cn)) / 3

Weapon Initial Enchantment Cost:
(Item Price (gp) x Enc. (cn)) x 5

Example: A two-handed sword normally costs 15 gp and weighs 100 cn. Its Initial Enchantment Cost is $15 \times 100 \times 5$ or 7,500 gp.

Example: A chainmail hauberk normally costs 40 gp and weighs 400 cn. Its Initial Enchantment Cost is $(40 \times 400) / 3$, or 5,333 gp.

The initial enchantment makes a "+1" bonus or "-1" penalty, according to the wizard's choice. For each subsequent "+" or "-" of either armor or weapons, multiply the Initial Enchantment Cost by the total "+" or "-" figure.

If this is the magic-user's first enchanted weapon or armor of this exact type, you must roll his success chance. A +1 weapon or armor is counted as a 1st-level spell; a +3 weapon or armor, a 3rd-level spell; and so on.

Important Note I: For the sake of game balance, the minimum Initial Enchantment Cost may be no less than 100 gp for weapons, or 3,000 gp for armor. Daggers are considered short swords only for purposes of calculating the Initial Enchantment Cost.

Important Note II: All weapon and armor enchantments are limited to +/-5, maximum. You just can't make a +/-6 weapon or piece of armor, period.

Limited Bonuses and Special Enemies

If you wish to give a weapon a bonus (or penalty) against a special opponent, simply add the extra "plusses" to the original enchantment costs, at half price.

For example, a sword +1, +3 vs. *undead* counts as a sword +2.5 for purposes of calculating the enchantment cost. Initial Enchantment Cost for a normal sword is 3,000 gp; to get a sword +1, +3 vs. *undead*, would cost $(3,000 \times 2.5) = 7,500$ gp.

Enchantment Time

Enchantment time for weapons and armor is the same as for other magic items: One week, +1 day for each 1,000 gp spent on the weapon or armor.

Adding Magical Powers

Extra magical effects can be added to weapons or armor. Proceed as if enchanting a separate item as described for Miscellaneous Magical Items. The extra cost is added to the total weapon or armor cost (not to the original weapon or armor's Initial Enchantment Cost). The enchantment takes +1 day per +1,000 gp added to the total cost of the weapon.

Each additional spell effect added to the weapon or armor must be rolled for success. Failure will result in loss of the spell effect be-

Magic-Users of Alphatia

ing worked on, and no further ones can be added, but will not affect the enchantment already on the weapon or armor.

Sword "Talents" are considered spells; find the spell which corresponds most closely to the Sword Talent and enchant the sword with that.

Magical powers targeted toward special foes cost less. The cost of these limited extra magical effects is reduced 10% per restriction. One restriction would be a class of monsters; a second would be a species of monsters; a third would be a specific, named monster.

Example: A sword +2 with a charm dryads power would be bought this way:

Initial Enchantment Cost for Sword: 3,000 gp. +2 bonus means Initial Cost is x2. Total Cost for basic Sword +2: 6,000 gp.

Adding Spell Enchantment: Initial Enchantment Cost is 4,000 gp (charm monster is 4th-level spell). Permanency is +20,000 gp. Basic Enchantment Cost is 24,000 gp. -20% (humanoid class, species dryad) is 19,200 gp for enchantment.

Total Weapon Cost: 25,200 gp. Creation Time: 32 days (one week + 25.2 days).

Intelligent Swords

Only Immortals create Intelligent swords. However, there is the possibility that an Immortal will make Intelligent any sword being created. Whenever you are creating a magical sword, remind your DM of this. He will determine, in secret, if an Immortal has made the sword Intelligent. He won't tell you whether or not this has happened. It will be revealed within the campaign at his discretion.

DMs: See the *Dungeon Master's Companion*, page 46, Table 12c.

In Review

Weapons and Armor

Armor Initial Enchantment Cost:

$(\text{Item Price (gp)} \times \text{Enc. (cn)}) / 3$

Weapon Initial Enchantment Cost:

$(\text{Item Price (gp)} \times \text{Enc. (cn)}) \times 5$

Total Cost: Initial Enchantment Cost x Final "+" or "-"

Minimum Possible Initial Enchantment Cost: 100 gp for weapons, 3,000 gp for armor

Plusses Against Special Foes: Each limited +1 counts as +.5 toward Total Cost

Adding Other Magical Effects

Calculate Cost as for creating new miscellaneous magical item; follow earlier rules for multiple spells

If effect is vs. specific foe: -10% to spell effect cost if vs. monster class; additional -10% to cost if vs. specific species; additional -10% to cost if vs. specific named monster

NOTES

Dagger counts as short sword for calculating Initial Enchantment Cost

Making Big Magic Items

The Alphatians have pioneered the making of buildings and vessels which move by magic. They make a lot of such things, flying boats especially; in Alphatia, there are more of such items than anywhere else.

These things cost a lot of money to make, and are often some wizard's whimsical idea translated into reality—meaning that they often have little practical usefulness, and cost fortunes which could have been used to improve the lot of one's vassals, servants, lands, and country. Truthfully, now, having a mansion that rolls around on wheels is interesting, but doesn't much advance the cause of humanity.

But this fact doesn't even occur to these wizards. They've earned or been given their money so that they may please themselves and advance the state of magical learning in the world, so it's perfectly appropriate for them to squander the fortunes of nations on strange, ungainly new vehicles and homes and other paraphernalia. So, in this section, we'll learn how your own PC wizards can squander their fortunes on such neat toys.

Builder Requirements

Magic-users making such things must be of 18th level or higher, twice as experienced as the makers of lesser magical items.

Magic-users building such things must know, or employ somebody who does know, the general skill pertaining to that type of structure—Engineering or Shipwright, generally. The overseeing Engineer or Shipwright will have to make his skill roll three times per day of construction.

Three failures in the same day means that he has failed to notice an engineering flaw which will ultimately doom the craft. However, the flaw may not be revealed until well into the craft's maiden voyage or even after . . . so the DM should make these rolls for the character, not letting him know when he has failed.

For this reason, it's often a good idea for a builder to have two or three such experts on hand, so they can spot one another's mistakes.

The Frame

The entire *frame* of the construction will have to be enchanted. On a ship, the *frame* consists of the hull, topdeck, and masts. On a building, the *frame* consists of all exterior walls, building exterior walls, and an area of flooring at least as large as the building or complex. The walls may be of wood, stone, or metal; the flooring must be of stone or metal.

The *frame* must be created through the use of the spells introduced in the "Character Creation" section (i.e. *woodwall*, *stonewall*, etc.). Normal building techniques can't make a structure strong enough to stand up to regular moving. Interior partitions, such as the floors of a building or interior decks of a ship, may be constructed in the normal, human fashion.

Process of Building

The player-character designs the floorplans of the building or ship he plans to build. He and the DM must then determine how many applications of *clothwall*, *woodwall*, *stonewall*, *ironwall*, and *steelwall* spells must go into making the craft's frame.

When the builders decide to construct the craft, they must enchant each one of the individual *clothwall*, *woodwall*, *stonewall*, *ironwall*, and *steelwall* spells which goes into the frame with every spell which is to apply to the entire craft.

For instance, let us say you're creating a metal boat which will carry its passengers beneath the waves without drowning them. The craft is 60' long and some 12' in diameter. It is to be built of steel, with four large, thick lead-crystal windows in strategic locations (bow, bow deck, stern, amidships top).

The player and DM determine that it will take 2,262 square feet of steel to make the hull. (That's 12' diameter x pi x 60' length.) Since each *steelwall* spell creates 500 square feet of steel, it seems that the hull will take 5 *steelwall* spells to construct. Since it's to have four large crystal windows, it will additionally take 4 *stonewall* spells.

Now, each *steelwall* and *stonewall* spell must have the following enchantments made on it: *create air*, *fly*, and *climate*. (Here, the DM is interpreting *fly* as an underwater spell instead—it will not lift the vessel above the waves, only to the surface, but will allow it to move at 360'/turn underwater.)

Magic-Users of Alphatia

With these spells, the vessel can cruise around on top of or beneath the water, and fresh air will be supplied to its passengers. (If only *create air* were enchanted, without *climate*, the air would soon be stuffy in the closed-in vessel. It would still be breathable . . . but uncomfortable.)

Naturally, holes will be left in the frame as it's being magically constructed, and airtight doors built magically or by normal means will be fitted there afterwards. The doors do not have to be enchanted with these spells.

Now, the spells cast on one section of *stonewall*, *ironwall*, etc. count as multiple spells for that section only. If a character botches a success roll when casting the enchantment, that section is spoiled—but since it is still under construction, it may be magically removed and a new one started. It just costs more that way . . .

Speed of Construction

Speed of magical construction depends on how many magic-users will work on it.

Calculate how many different spells of which type need to go into the making of the frame. Determine how many spells of the proper types the participating magic-users can cast. Compare the two sets of figures and you should be able to figure out how fast the project will come together.

Walls and Floors

As mentioned before, the interior walls and floors may be created by magical or normal means. If the builder-organizer is using normal means, he pays the workmen as per the rates given on (or extrapolated from) the charts on page 23 of the *Expert Rulebook*. Costs and time are given for these procedures on the same page.

If the builder-organizer is using magic to finish the walls and floors, he and his crew use the spells already described to do the job. The time required is the same as for enchantment of the frame; it depends on the number of magic-users and the size of the job.

Individual walls and other partitions may have enchantments cast upon them. For instance, a specific set of rooms might have a *climate* cast on them to give them a different atmosphere from the rest of the building.

Finishing Details

Rules for creating other magical items associated with the craft are the same as for creating Miscellaneous Magic Items. In the example of that submersible vessel, for instance, a battery of *wands of magic missiles* might be set up in the bow to act as torpedos.

Enchantment Cost

Oh, yes, there is still an enchantment cost for creating such a structure.

Frame Enchantment Cost: Total # of Spell Levels x 3,000 gp

Extra Items Enchantment Cost: Same as for creating miscellaneous magic

In a barnraising (from the Alphatian Society and Politics section), you generally don't have to create an enchanted frame; all you're doing is casting *stonewall*, *woodwall*, and similar spells—which cost no gold piece value. However, if the home-builder wishes for there to be enchantments on various parts of his home, he is expected to assume *all* gold piece costs for the project.

A builder of a home or vessel might instead hire magic-users to do the job for him. If he does, he pays not only the amount dictated by the project, but also the salaries of the magic-user hirelings. A hired magic-user costs 500 gp/level/week (thus a 10th-level magic-user will cost 5,000 gp per week). Magic-users may be hired on a long-term basis (guaranteed employment of six months or more) for 250 gp/level/week.

Experience From Enchanted Items

You do get experience points for creating enchanted items and magical vessels—they represent a great investment in time, money, and effort, after all.

When you create a magical item or piece of armor, you get an XP award equal to the number of gp you spent on the item—if the enchantment was successful. If the enchantment failed, you get 1/10 the gp value as experience.

When you create an enchanted vessel, you get an XP award equal to one-third the gp you spent on the item—if the enchantments were successful. You only get 1/30 the gp value as experience for unsuccessful enchantments.

These XP awards are divided evenly among all magic-users working on the enchanted item; this is especially important to remember for enchanted vessels, which generate a lot of XP but are usually worked upon by numerous magic-users.

You do not get experience for spells which don't cost gp (such as *stonewall*) or from the non-magical fittings added to such vehicles.

The Shark

Our sample vehicle, above, is the Shark. In addition to the construction details mentioned above, the builders cast two normal *woodwall* spells to create interior partitions, had three iron doors put in for exterior hatches, had four sets of window shutters put in for the crystal windows, and had four ordinary wood doors put into the interior partitions. The final vessel looks like this:

The Shark (Magical Submersible)

Spells & Fittings	Spell Levels	Total Levels	Multiplier	Cost in gp
Steelwall	5 x 8 =	40	x3000	120,000
Stonewall	4 x 6 =	24	x3000	72,000
Create Air	9 x 3 =	27	x3000	81,000
Fly	9 x 3 =	27	x3000	81,000
Climate	9 x 3 =	27	x3000	81,000
Woodwall	2 x 5 =	10	x0	0
Iron Doors	3 x - =		50	150
Wood Doors	4 x - =		10	40
Shutters	4 x - =		5	20
TOTAL COST:				435,210 gp

Mult: x3,000 for Frame enchantments, normal costs for enchanted items, other figures for costs of normal fittings.

It could be further fitted with weapons, but this model is not.

The Air-Ship of Love

The Air-Ship of Love is a large flying liner based out of Rainbow Park on Gaiety Island; it flies cruises all over the Empire while its crew strives to serve up an atmosphere of romance for its passengers. It looks something like this:

Length 500', width 200' at deck, height 300' (not including masts)—frame is 1' thick and has surface area of about 400,000 square feet (about 400 applications of *woodwall* spell). Accommodations for 200 crew and servants, 400 passengers. Lavish appointments. Unarmed—recreational ship only.

Magic-Users of Alphatia

The Air-Ship of Love				
Spells & Fittings	Spell Level	Total Levels	Multiplier	Cost in gp
Woodwall	400 x 5 =	2000	x3000	6,000,000
Create Air	400 x 3 =	1200	x3000	3,600,000
Fly	400 x 3 =	1200	x3000	3,600,000
Climate	400 x 3 =	1200	x3000	3,600,000
Woodwall	200 x 5 =	1000	x0	0
Iron Doors	200 x - =		x50	10,000
Wood Doors	800 x - =		x10	8000
Shutters	250 x - =		x5	1250
Appointments				5,000,000
TOTAL COST				21,819,250 gp

Mult: x3,000 for Frame enchantments, normal costs for enchanted items, other figures for costs of normal fittings.

The generic "appointments" line includes all the lavish items built into the ship—elegant furniture, gold leaf everywhere, statues, carpets, paintings, etc. The DM has here just assigned an arbitrary number to that element; it could actually be much higher if the builder wished.

The Book of Wondrous Inventions

Supplement AC 11, *The Book of Wondrous Inventions*, includes many items which you can build according to these rules; such items as *Oddwaddle's Centipede* and *Volospin's Dragonfly of Doom* are especially appropriate.

If you decide to build such things according to these rules, you'll find that the costs given there are different from those here. This is because the builders of those things, in their own lands, are specialists in their construction and can do some things more cheaply, or through the use of machinery rather than magic; the costs presented here are a uniform set of costs whereby you can make such items anywhere in the Alphatian Empire.

Unless your DM says otherwise, use the costs from this book when creating such magic vessels and vehicles.

Dispel Attacks

It may be that a vessel built with these rules will be hit with a *dispel magic* spell while traveling. What then?

Well, first, the vessel's entire frame must fit within the 20'x20'x20' area affected by the spell. If it does not, the *dispel* has no effect on the vessel.

But, assuming it's a small vessel—or that several magic-users have banded together and aim precisely enough to blanket the vessel with the spell—we then have to find out if the *dispel* succeeded, by calculating the normal odds. The *dispel's* chance of failure must be checked against every different type of spell represented in the vessel.

Assuming it does succeed, all affected spells "go down." Those which are not permanent

enchantments are completely dispelled; those which are permanent only go down for 1d10 (1-10) rounds.

A flying vessel would begin to drop and would continue to do so until the *fly* spell returned. In the submersible, the vessel would stop moving and the air would slowly begin to go stale until the *create air* and *climate* spells returned (unless it was topside, in which case the operators could open a hatch for fresh air).

With flying vessels, this situation could result in a crash. See the rules for falling damage in the "Fighters of Thyatis" chapter of Book II to calculate damage sustained. In a fall, a vessel takes full damage—not the lesser damage done by siege machines—and every individual section of the frame and every passenger, crewman, or piece of cargo will take that damage.

If, however, "power" returns before the vessel has crashed, or if the passengers can save themselves with a *wish*, the vessel and its precious cargo will not hit the ground.

Partial Destruction

What happens when an enchanted vessel undergoes partial destruction? This is actually a role-playing decision for your DM to make—it's better to make an interesting, dangerous gaming situation out of such an occurrence rather than to apply a given set of rules to it. But here are some general guidelines anyway.

For a vessel's movement spell (usually the *fly* spell), the spell continues working until one-quarter of the vehicle's frame sections have been destroyed or penetrated. At that time, the vehicle's speed drops down to half its listed rate and the vehicle may no longer

climb—in fact, it begins a gradual drop (if it's flying, it slowly drops to the surface; if it's swimming, it slowly sinks to the ocean floor).

When half the vehicle's frame sections have been destroyed, the movement spell is not strong enough to hold the vehicle up—the vehicle drops. Additionally, the frame is now so damaged that the vehicle begins breaking up.

The effects on other frame spells are as the DM sees fit, within these general guidelines: When one-quarter of the frame sections are damaged, the spell begins operating at half-value, or unreliably; when half the frame sections are damaged, the spell ceases working altogether.

The DM must decide what final effect these results have. For instance, if the vehicle is a submersible, taking damage to one-quarter of the frame sections means that the submersible only moves at half-speed and its air-conditioning spells are not working well—but it also should mean, since the frame is damaged, that water is pouring in through cracks and holes and the vehicle is sinking regardless of the fact that it still has some propulsion. The DM should make such decisions based on how interesting and dramatic a scene he can make of the situation.

Costs for Buying Magic Items

Just because you can make a magic item for the costs described above doesn't mean you can buy one for the same cost. When you buy a magical item ready-made, its price is typically twice the cost of enchanting and constructing it. The extra money goes to things such as advertising the product, keeping it up while it languishes in a shop or a storeroom, sentimental value, and a fair profit for the maker.

The Magic Item Creation Sheet

Enclosed at the end of Book I is a Magic Item Creation Sheet for use with these rules. It provides convenient blanks for all the various creation-cost figures you just learned how to use.

AND NOW, LADIES AND GENTLEMEN . . .

Hopefully, all these campaign options will give you more things to do with your Alphatian or other magic-using character than when you opened this book. Now, it's time to begin putting your characters together and begin discussing campaign play of these rules with your Dungeon Master.

DUNGEONS & DRAGONS[®]
GAZETTEER

BOOK THREE:
Player's Guide to Alphatia
by Aaron Allston

The Empire of Alphatia welcomes you! (Provided, of course, that you're a magic-user...)

In this book are all the rules needed for players to create their own Alphatian magic-users, along with many new spells of various levels. Want to make a flying castle? Here are the rules! A submersible boat? Look inside!

In addition to all the wondrous magical information, players also learn about the history, geography, economics, and socio-political background of this other Empire.

ONWARD AND UPWARD, THEN! Alphatia awaits you!



TSR, Inc.
PRODUCTS OF YOUR IMAGINATION[™]

IRENEDI

12 5	12 5	5 7	5 7	5 7	5 7	5 7	5 7	5 7	6 6	6 6
Fourtyant	Dakari	Amogant	Valant	Fornoble	Sovereign	gorious	infantile	Supert	Panoptant	
6 6	7 6	9 6	3 8	6 7	11 6	3 8	3 8	3 8	3 8	5 7
Gallant	Ilustrious	Thunder	Fearless	Damless	Invincible	Intrepid	Adament	Courgeous	Victorious	

MINIROTHAD GUILDS

6 7	3 8	3 8	3 8	3 8	3 8	3 8	3 8	5 6	5 6	5 6
Silver	Emerald	Gold	Red	Black	White	Blue	Green	Yellow	Pink	
6 7	4 7	4 7	4 7	4 7	4 7	5 6	5 6	5 6	7 6	
Steppe	Zephyr	Crimson	Zodiac	Purple	Coral	Diamond	Coral	Alabaster	Agate	

PRIVATEERS & MERCHANTMEN

3 7	3 7	3 8	3 8	4 7	4 7	5 7	5 7	6 7	6 7	6 7
Spain	The Rose	The Swan	Uncan	Medusa	The Sun	Savage	Bindonore	Merman	Titan	
7 7	5 6	5 6	6 6	6 6	7 6	7 6	8 6	9 6	8 6	
Arctic	Cerberus	Seasled	Vigilant	Avant	Isabella	Challenge	Comusio	The Devil	Defender	

9 6	10 6	11 6	3 7	3 7	3 8	3 8	4 7	5 7	6 7	6 7
Dos Amigos	Hilbary	Worath	Amazon	Willow	Vien	Fantail	Valryne	Sea Dragon	Duwall	
2 7	2 7	2 7	2 7	2 7	2 8	2 8	2 8	3 7	3 7	
Crestler	Goodhope	Premia	Brandwyre	Moon	El Chiso	Harpoon	Heard	The Eagle	Foliant	

3 7	4 7	4 7	5 7	5 7	4 6	4 7	4 7	6 7	4 7	
Power	Espesanza	Pilgrim	Pringim	Princess	Comenall	All Faiths	Abor-Pakia	All-Kalm	Bit-Kalm	
4 6	4 6	5 6	5 6	6 6	7 6	3 7	3 7	3 7	3 7	
Giffin	Merinda	Prudence	Rinkew	Ricellat	Criztal	Mahmudsh	Nehid	Sibod	Makar	

Copyright 1987 TRS, Inc. All Rights Reserved. Printed in the U.S.A.

THYATIS

4 7	4 7	4 7	4 7	4 7	4 7	4 7	4 7	4 7	4 7	4 7
Olivia VI	Adrian X	Constantin	Adrus	Augustin I	Satan II	St. Valen	Alexander	Aedrocca	Octavian	
5 7	5 7	5 7	6 7	6 7	6 6	6 6	6 6	6 6	8 6	
Auroran	Basil XV	Belastan	St. Caliana	Diocetan	Gallen	Eugene	Emilian	Theodore	Sophia	

7 6	7 6	10 6	4 7	4 7	5 6	5 6	5 6	5 6	6 6	6 6
Here III	Julian XIII	Justin	King Leo	Miscal I	Michael	Lucas	Chesnut	Rognarus	Dogares	
3 7	3 7	3 7	3 7	3 7	3 7	3 7	3 7	3 7	3 7	
Nicomede	Zephia	Tiberian	Ardite	Ayas III	Micaphra	Ephesian	Che	Daphne	Tamarian	

DAROKIN

4 7	4 7	4 7	4 7	4 7	4 7	4 7	4 7	4 7	4 7	4 7
Waruhi	Amaros	Axazel	Coragelin	Athoros	Bomdall	Gulstvan	Helstrom	Raegaid	Gunnobon	
3 7	3 7	3 7	5 6	6 6	4 7	4 7	5 7	5 7	5 7	
Illiam	Serenia	Athiam	Malphoggl	Darulin	Einikon	Borgsen	Bowwill	Wilfred	Thorfin	

VESTLAND

OSTLAND

3 7	3 7	5 7	6 7	10 6	3 7	3 7	3 7	3 7	3 7	3 7
Radakus	Arvian	Ryran	Wendel	Arvian	Raher	Oluson	Sveron	Harad	Katvold	
7 6	7 6	4 7	4 7	4 7	4 7	4 7	4 7	4 7	5 7	
Estimere	Arvian	Wendel	Svein	Arvian	Wendel	Halled	Thorvald	Sigurd	Satruusen	

KARAMEIKOS















SODERFJORD JARLDOMS

7 7	7 7	7 7	3 8	3 8	4 7	4 7	7 6	9 6	3 8	3 8
Barnocul	Svein	Arvian	Blackbeard	Brycener	Svenhocker	Culliss	Sethwik	Revenge	Thorgrim	Siftrygg
3 7	3 7	3 7	4 7	3 7	3 7	3 7	4 7	5 6	5 6	3 8
Bliv	Arvian	Arvian	Set-Lum	The Pride	Sab-Big	Bocory	Tornagi	Hillegate	Eirikrossen	Magnussen















FIVE SHIRES

PIRATES

Copyright 1987 TRS, Inc. All Rights Reserved. Printed in the U.S.A.















3  King Doth	6  Goblin	1  Goblin	1  Goblin	1  Goblin
4  Queen Yazar	4  Goblin	2  Goblin	2  Goblin	2  Goblin
 Goblin	3  Goblin	3  Goblin	3  Goblin	4  Elite Goblin









6  Hutai-Khan	4  Hobgoblin	3  Hobgoblin
 Hobgoblin	3  Hobgoblin	4  Hobgoblin
 Hobgoblin	4  Hobgoblin	5  Elite

5  Supreme Hool	4  Red Orc	2  Red Orc	2  Red Orc	2  Red Orc
 Red Orc	2  Red Orc	3  Red Orc	3  Red Orc	3  Red Orc
 Red Orc	3  Red Orc	3  Red Orc	4  Elite	4  Red Orc

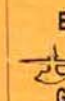
4  Mogul-Khan	5  Yellow Orc	1  Yellow Orc	2  Yellow Orc	2  Yellow Orc
 Yellow Orc	3  Yellow Orc	3  Yellow Orc	3  Yellow Orc	3  Yellow Orc
 Yellow Orc	3  Yellow Orc	3  Yellow Orc	4  Elite	4  Yellow Orc

3  High Doge Kol	6  Kobold	1  Kobold	2  Kobold	2  Kobold
4  General Zar	4  Kobold	2  Kobold	2  Kobold	2  Kobold
 Kobold	2  Kobold	2  Kobold	2  Kobold	2  Kobold
 Kobold	2  Kobold	2  Kobold	3  Elite	3  Kobold

5  Nizam-Pasha	5  Gnoll	3  Gnoll	4  Gnoll	6  Elite
 Gnoll	4  Gnoll	4  Gnoll	4  Gnoll	5  Gnoll

2  Small Fortress	2  Small Fortress	3  Fortress	3  Fortress
3  Fortress	3  Fortress	3  Fortress	4  Big Fortress
4  Big Fortress	5  Real Big Fortress	 Shaman	 Shaman

2  War Machine	2  War Machine	3  War Machine	3  War Machine
4  War Machine	 MINE	 MINE	 MINE
0  Spy Pup	1  Sr. Spy	2  Spy Master	 MINE

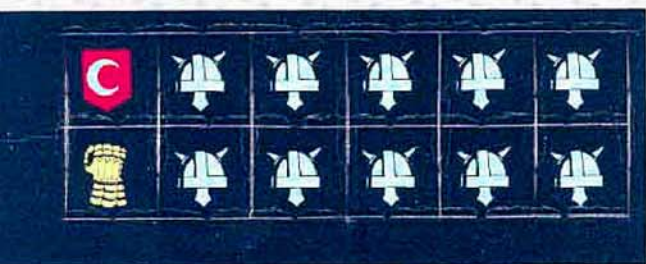

6 King Thar	3 Common Orc	3 Common Orc	3 Common Orc	3 Common Orc	3 Common Orc
3 Common Orc	3 Common Orc	3 Common Orc	4 Common Orc	5 Common Orc	Elite

Elite 8 Elite Troll	7 Troll	6 Troll
4 Haa'k Horadar	4 Troll	5 Troll

5 Prince Alebane	4 Ogre	3 Ogre	3 Ogre	4 Ogre
4 Ogre	4 Ogre	5 Ogre	Elite 7 Ogre	

4 Chief Ohr'i	5 Bugbear	4 Bugbear	4 Bugbear	4 Bugbear
4 Bugbear	4 Bugbear	4 Bugbear	Elite 6 Bugbear	

T → Y 	T → A 	T → G 	T → U 	F → S 	F → R
D → O 	D → S 	D → R 	D → F 	S → R 	S → D
A → Y 	Y → A 	Y → U 	O → U 	U → A 	O → D
O → D 	U → G 	G → Y 	R → S 	A → G 	O → T

3	3	3	3	3	3
4	4	4	4	4	2
4	4	4	4	4	2
Fools 0 Gold	Fools 0 Gold	Fools 0 Gold	Fools 0 Gold	5 Treasure	2
1	1	1	1	1	2

1	1	1	1	1	1
1	1	1	1	1	1
2	2	2	2	2	2
2	2	2	2	2	2
2	2	2	2	2	2
3	3	3	3	3	3
3	3	3	3	3	3
3	3	3	3	3	3

9241XXX1201

Caravan	Caravan	Caravan	Caravan	Caravan	Caravan
Caravan	Caravan	Caravan	Caravan	Caravan	Caravan
Caravan	Caravan	Caravan	Caravan	Caravan	Caravan
Caravan	Caravan	Caravan	Caravan	Caravan	Caravan



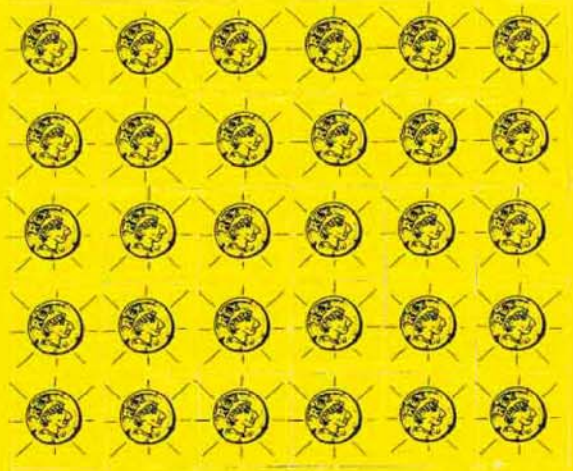
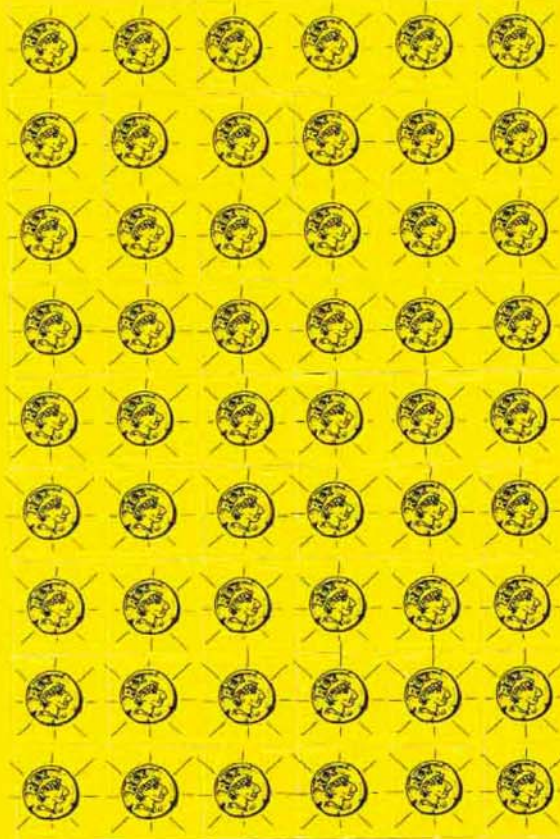

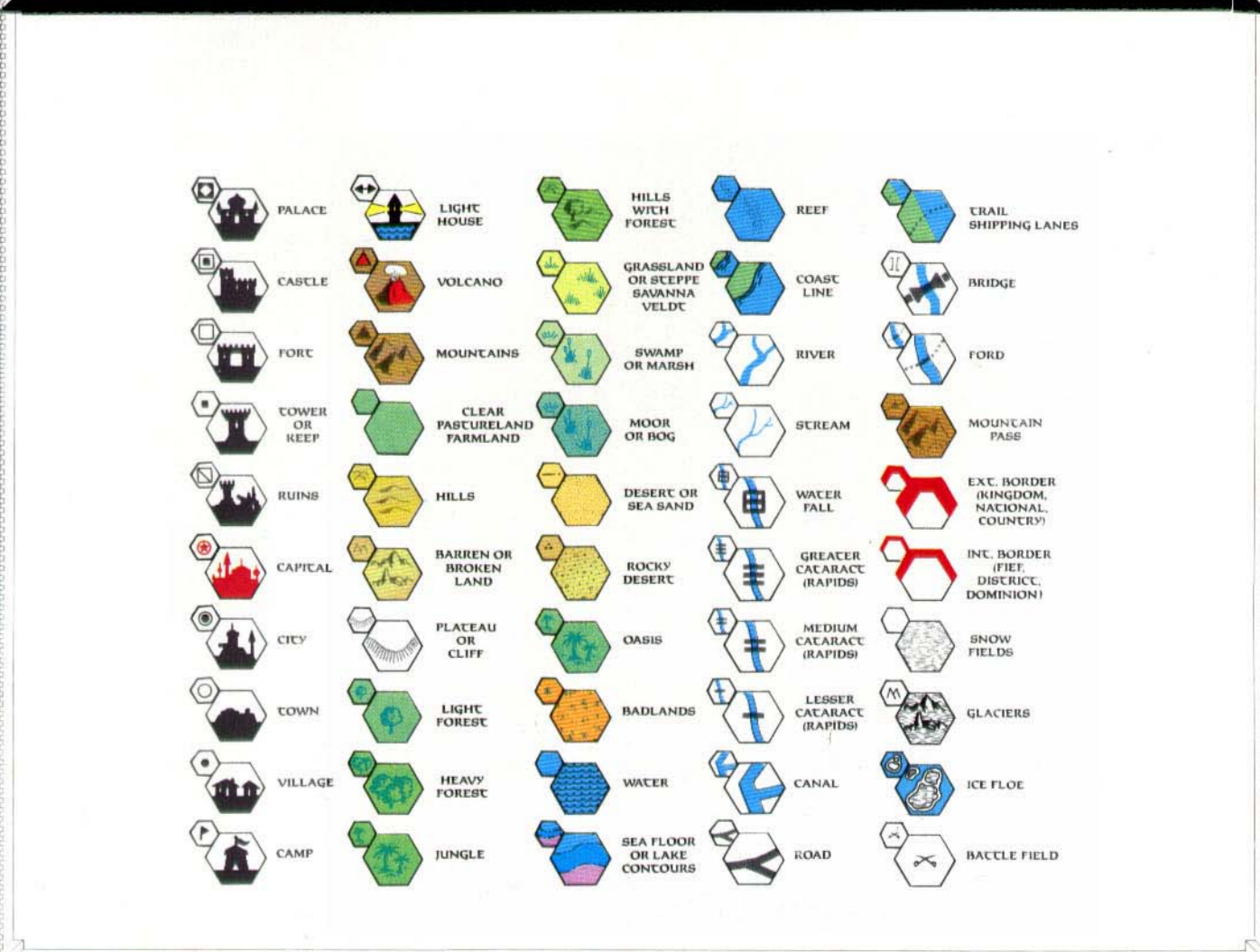
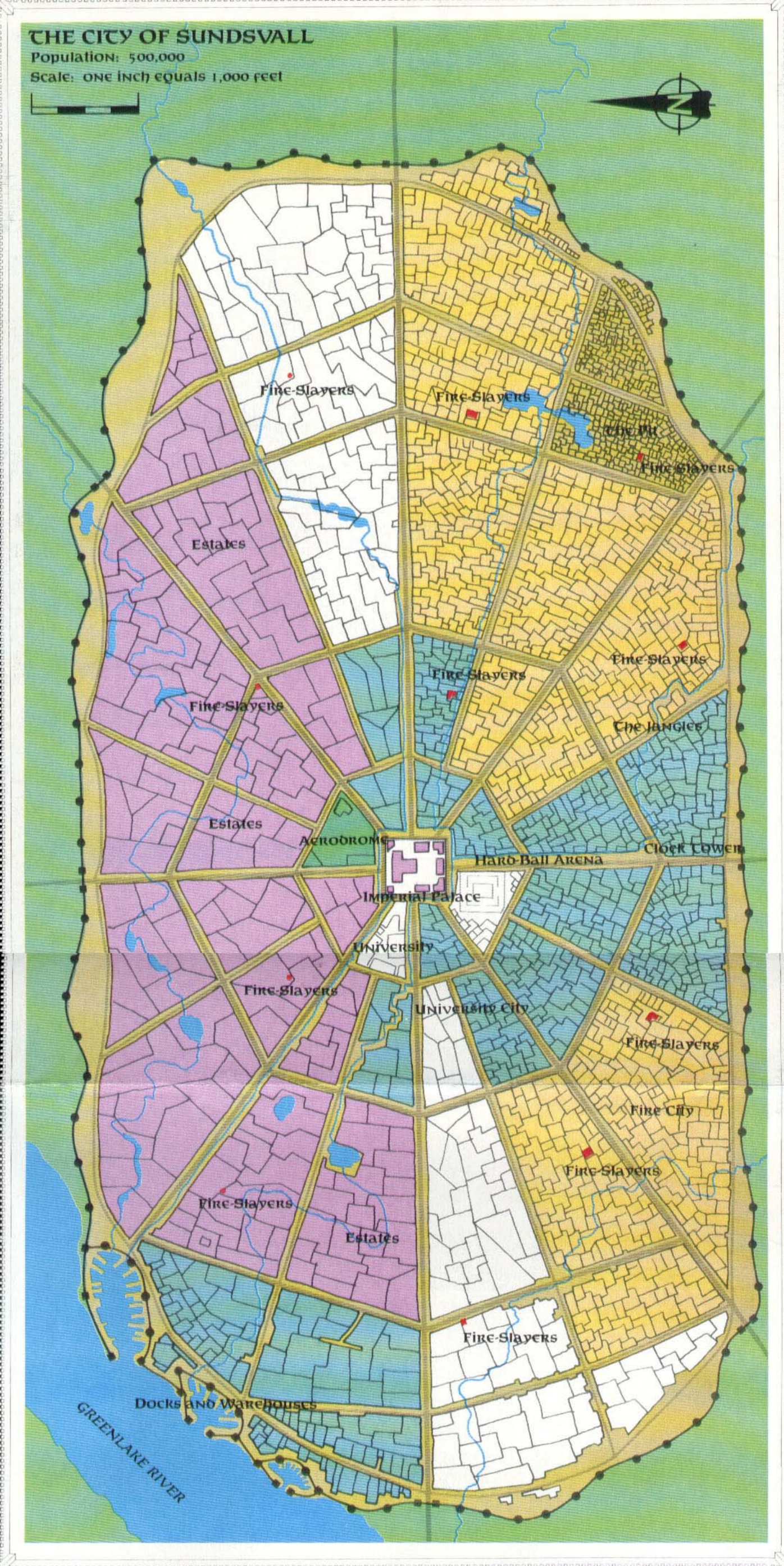
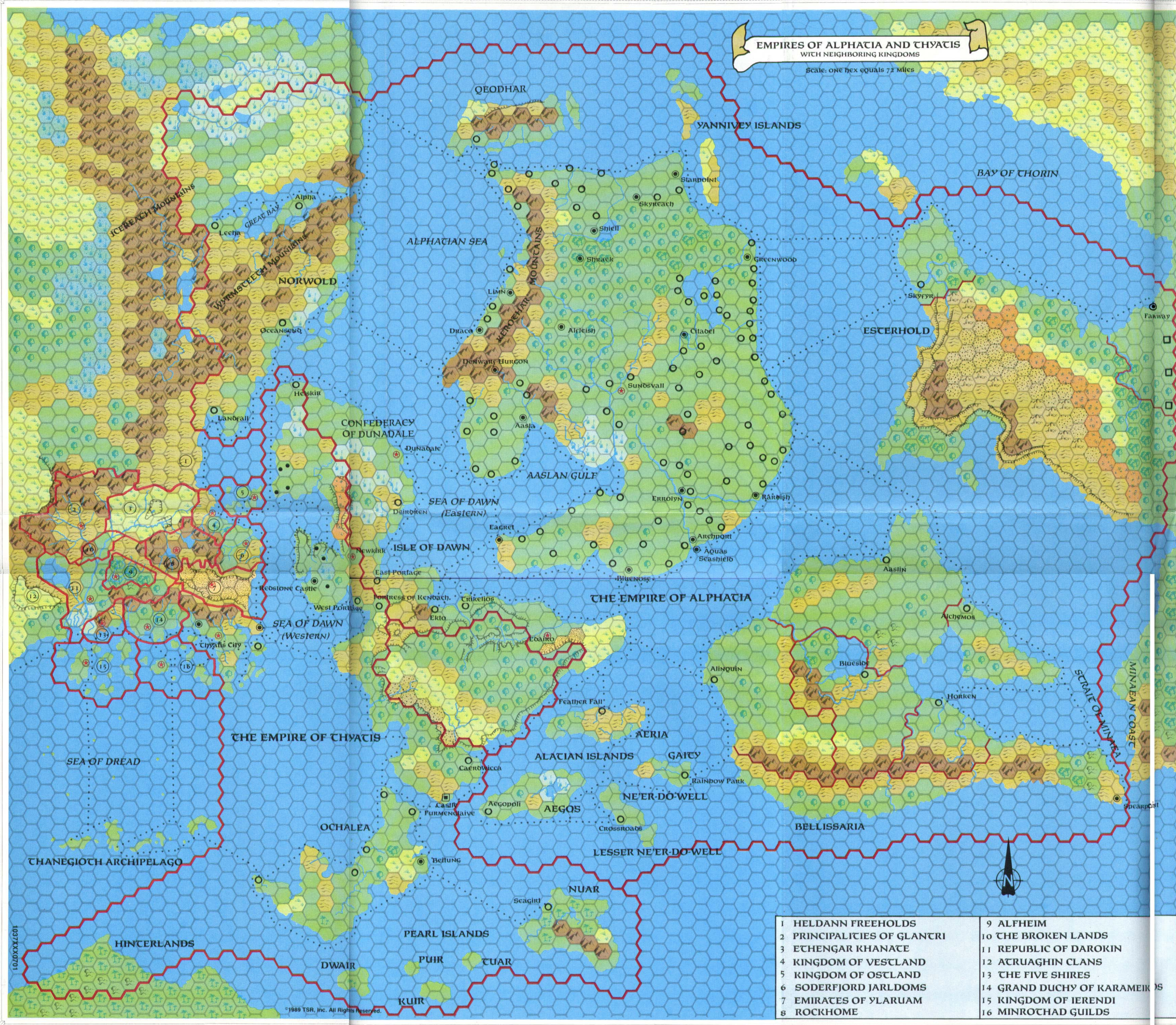
ISLE OF DAWN

Scale: ONE hex equals 24 miles



THE EMPIRE OF ALPHACIA

Scale: ONE HEX EQUALS 24 MILES



THE EMPIRE OF THYATIS

Scale: one hex equals 8 miles

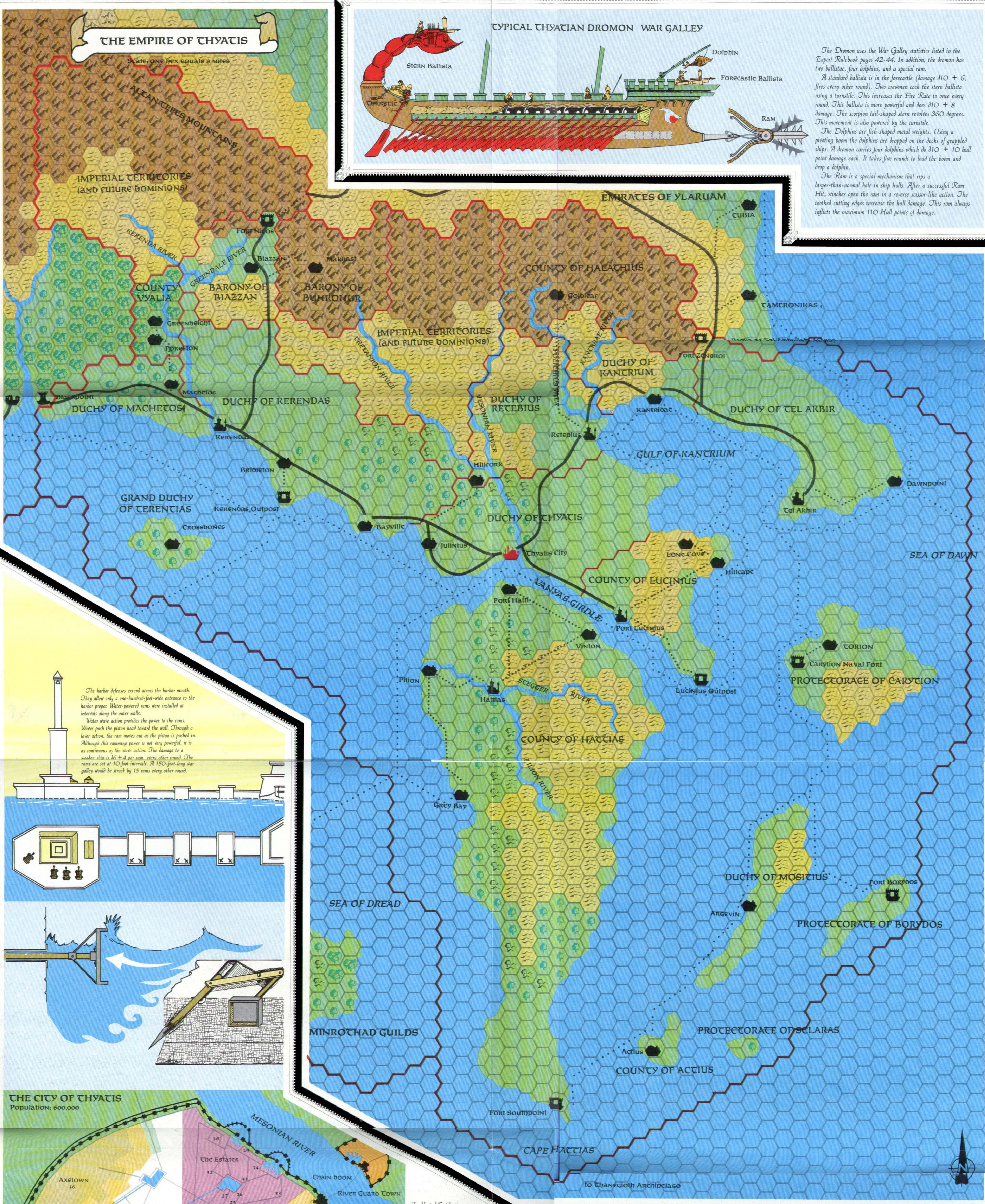

TYPICAL THYACIAN DROMON WAR GALLEY

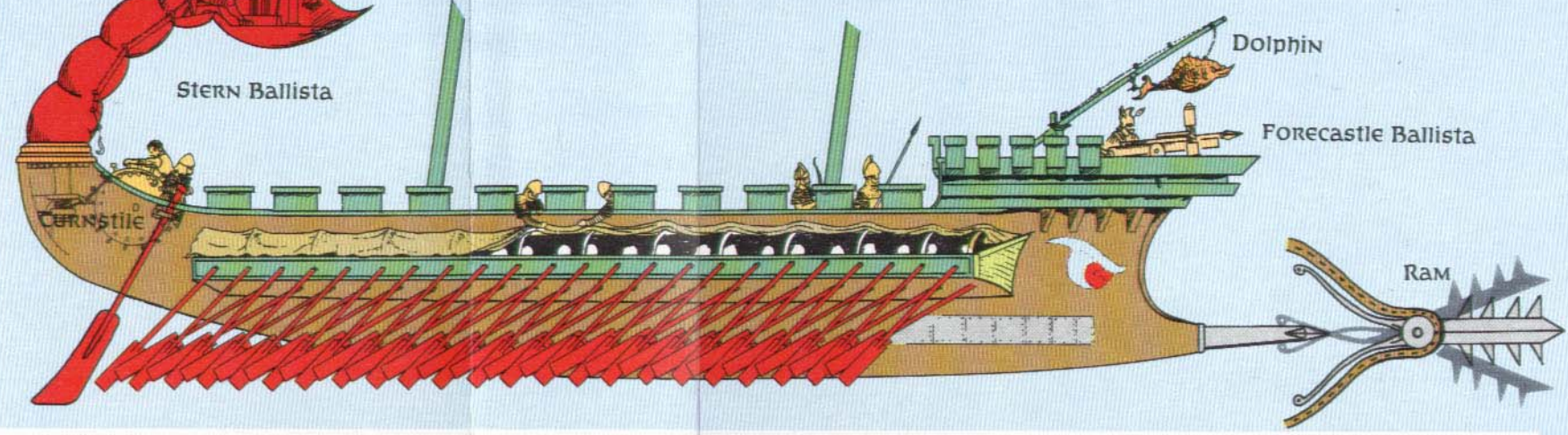

The Dromon uses the War Galley statistics listed in the Expert Rulebook pages 42-44. In addition, the dromon has two ballistae, four dolphins, and a special ram.
 A standard ballista is in the forecave (damage $d10 + 6$; fires every other round). Two crewmen cock the stern ballista using a turnstile. This increases the Fire Rate to once every round. This ballista is more powerful and does $d10 + 8$ damage. The scorpion tail-shaped stern revolves 360 degrees. This movement is also powered by the turnstile.
 The Dolphins are fish-shaped metal weights. Using a pivoting boom the dolphins are dropped on the decks of grappled ships. A dromon carries four dolphins which do $d10 + 10$ hull point damage each. It takes five rounds to load the boom and drop a dolphin.
 The Ram is a special mechanism that rips a larger-than-normal hole in ship hulls. After a successful Ram Hit, winches open the ram in a reverse scissor-like action. The toothed cutting edges increase the hull damage. This ram always inflicts the maximum 110 Hull points of damage.

The harbor defenses extend across the harbor mouth. They allow only a one-hundred-foot-wide entrance to the harbor proper. Water-powered rams were installed at intervals along the outer walls.
 Water wave action provides the power to the rams. Waves push the piston head toward the wall. Through a lever action, the ram moves out as the piston is pushed in. Although this ramming power is not very powerful, it is as continuous as the wave action. The damage to a wooden ship is $d6 + 4$ per ram, every other round. The rams are set at 10-foot intervals. A 150-foot-long war galley would be struck by 15 rams every other round.

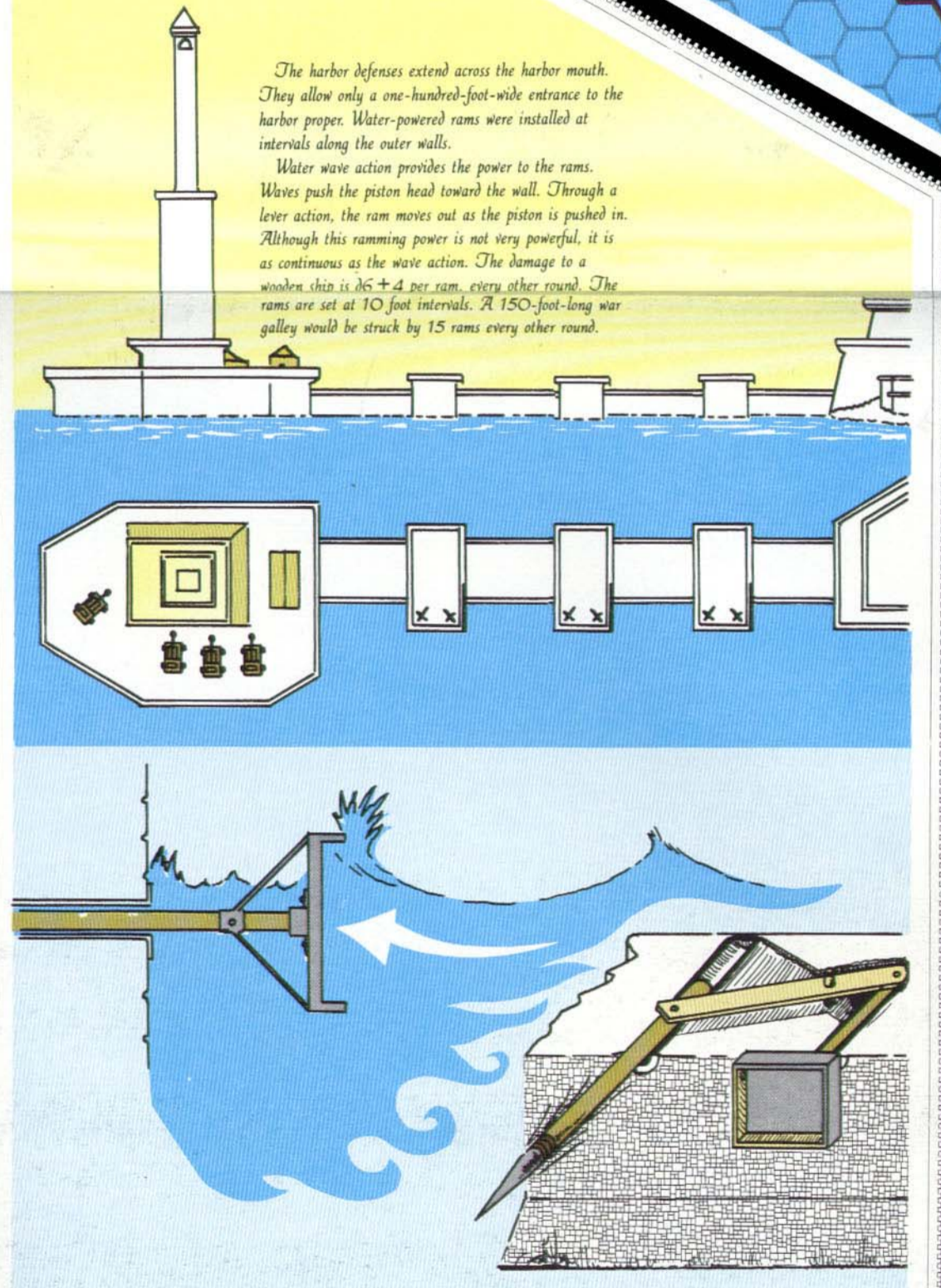

THE CITY OF THYATIS
Population: 600,000

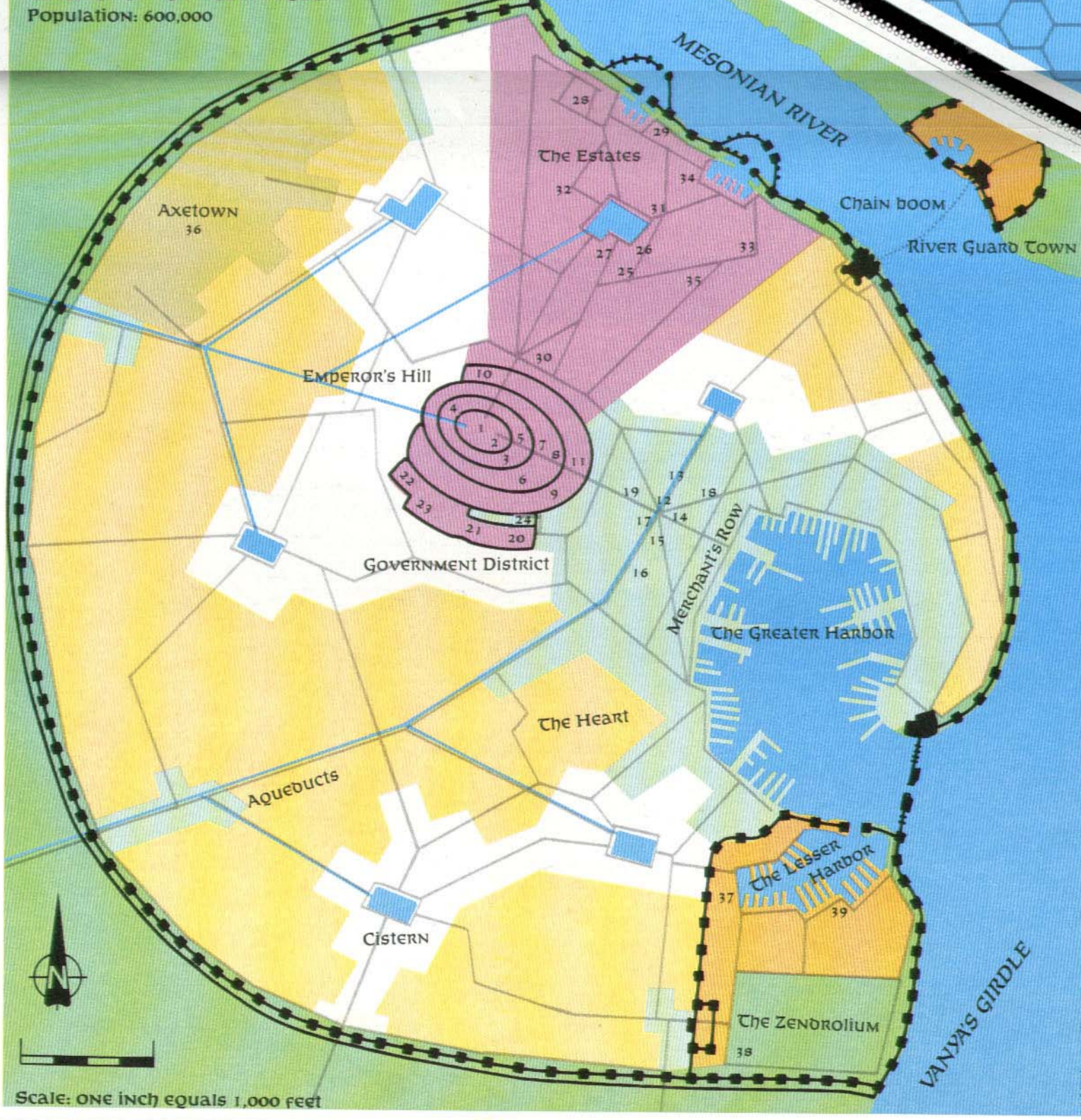

Top View of Fortifications
Scale: 1/8 inch equals 20 feet

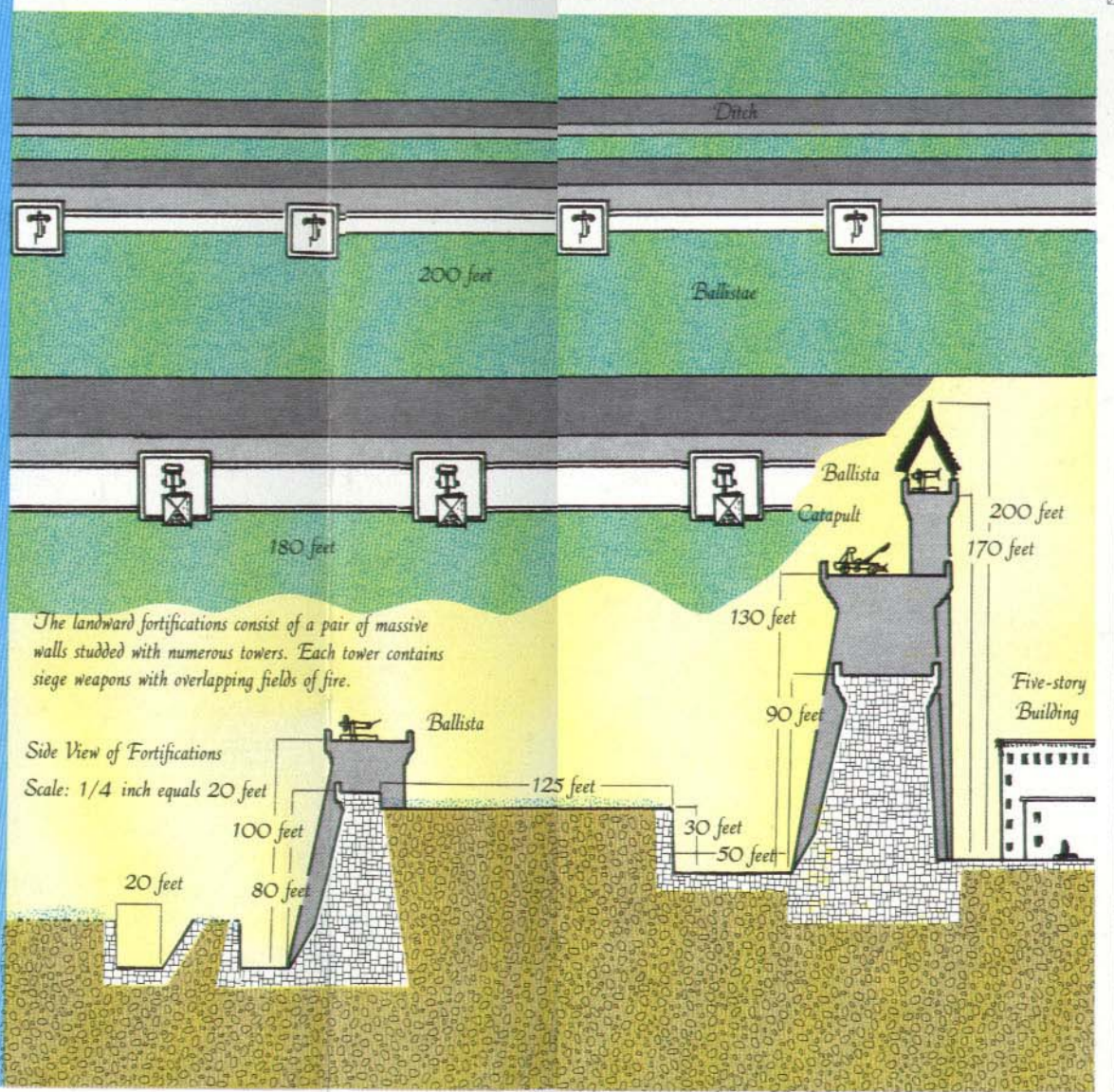

The landward fortifications consist of a pair of massive walls studded with numerous towers. Each tower contains siege weapons with overlapping fields of fire.
 Side View of Fortifications
Scale: 1/4 inch equals 20 feet

DUNGEONS & DRAGONS®

GAZETTEER

Official Game Accessory

Dawn of the Emperors

Thyatis and Alphatia

by Aaron Allston

Thyatis. AN EMPIRE RUN WITH MILITARY PRECISION. AN EMPIRE WHEREIN FIGHTING PROWESS IS THE MOST HIGHLY PRIZED TALENT OF ALL, AND GLADIATORIAL SKILL CAN LEAD TO GOVERNMENTAL STATUS.

Alphatia. AN EMPIRE NOT SO MUCH RUN AS ALLOWED TO EXIST BY ITS ARISTOCRACY. AN EMPIRE WHEREIN MAGIC-USE IS THE ONLY TALENT THAT COUNTS FOR ANYTHING, AND LACK OF IT CAN LEAD TO A LIFE OF SLAVERY.

IN THIS BOX, YOU WILL FIND:

- A 128-page DM's Guide, covering both empires in their entirety.
- Two 32-page Player's Guides, one for each Empire.
- New rules for aerial combat!
- New spells for building flying creations: castles, ships, islands...
- Two full-size map sheets, containing complete maps of both empires.
- Complete adventures for both Thyatian and Alphatian settings, and suggestions for mini-adventures also set in both empires.
- Ways and means to convert this material to ADVANCED DUNGEONS & DRAGONS® 2nd Edition games!

© 1989 TSR, Inc. All Rights Reserved. Printed in U.S.A.
ISBN 0-88010-716-X

TSR, Inc.
POB 756
Lake Geneva,
WI 53147 USA

\$18.00 US



TSR Ltd.
120 Church End, Cherry Hinton
Cambridge CB1 3LB
United Kingdom

1017

DUNGEONS & DRAGONS, DGD, ADVANCED DUNGEONS & DRAGONS, ADGD,
PRODUCTS OF YOUR IMAGINATION, and the TSR logo are trademarks owned by TSR, Inc.



0 46363 01037 9