

Advanced Dungeons & Dragons
2nd Edition

SPELLJAMMER™

Accessory

WAR CAPTAIN'S COMPANION

Combat In Fantasy Space!



Advanced Dungeons & Dragons
2nd Edition

SPELLJAMMER™

Accessory

War Captain's Guide

War Captain's Companion: Book 1

E. OLSON



The War Captain's Guide

War Captain's Companion: Book 1

CREDITS

Design: Dale "Slade" Henson.
Editing: Jon Pickens
Cover Painting: Erik Olson
Cartography: Diesel

Internal Art: Diesel, Jeff Easley,
Newton Ewell, Mark Nelson,
Erik Olson
Typography: Angelika Lokotz

Thanks To: Anne Brown, Rich Baker, Timothy B. Brown, David "Zeb" Cook, Andria Hayday, Rob King, Colin McComb, Bruce Nesmith, John Rateliff, Thomas Reid, Steven Schend, Dori Watry, Steve "Old Man" Winter, David Wise.

Very Special Thanks: Jeff Grubb, James M. Ward

ADVANCED DUNGEONS & DRAGONS, AD&D, DRAGONLANCE, FORGOTTEN REALMS and WORLD OF GREYHAWK are registered trademarks owned by TSR, Inc. MAGE STONES, SPELLJAMMER and the TSR logo are trademarks owned by TSR, Inc.

Random House and its affiliate companies have worldwide distribution rights in the book trade for English language products of TSR, Inc.

Distributed to the book and hobby trade in the United Kingdom by TSR Ltd.
Distributed to the toy and hobby trade by regional distributors.

This SPELLJAMMER game accessory is protected under the copyright laws of the United States of America. Any reproduction or unauthorized use of the material or art work printed herein is prohibited without the express written permission of TSR, Inc.

Printed in the U.S.A. Copyright ©1992 TSR, Inc. All Rights Reserved.

TSR, Inc.
P.O. Box 756
Lake Geneva
WI 53147
U.S.A.



TSR Ltd.
120 Church End
Cherry Hinton
Cambridge, CB1 3LB
United Kingdom

Table of Contents

Table of Contents	2	Crew Size	61
Introduction	4	Helm Selection	61
Concepts of Arcane Space	4	Weapon Selection	62
Air Envelopes	5	Ship Design and Architecture	63
Table 1-1: Air-Days By Creature Size	5	Sails and Culture	64
Gravity	6	Ship Construction Tables	65
Using a Spelljamming Helm	6	Table 5-1: Ship Types	65
Chapter 1: Spacefaring Proficiencies	7	Table 5-2: Tonnage/Cube Table	65
Table 1-1: Non-Weapon Proficiencies	7	Table 5-3: Hull Cost	65
Table 1-2: Large Weapon Proficiencies	7	Table 5-4: Precious Gems	65
Chapter 2: Cap'n Gyudd's Spacefaring Gear ...	11	Table 5-5: Precious Metals	65
Chapter 3: Spacefleets of the Void	18	Table 5-6: Basic Armor Ratings	65
Beholder Fleets	18	Table 5-7: Basic Ship Saving Throws	66
Elven Fleets	19	Table 5-8: Ram Prices	66
Free Neogi, Oerth	21	Table 5-9: Base MC Table	66
Kindori-Riders, Krynn	24	Table 5-10: Engine Weight Requirements ..	66
Scavver-Breeders, Oerth	27	Table 5-11: SR Using Minor and	
Wa, Toril	29	Major Helms	67
Chapter 4: Ship Building Companies	34	Table 5-12: SR Using Other Magical Engines	67
Repair Costs	34	Table 5-13: Tonnage Cost Per Weapon	67
Table 4-1: Standard Repair Modifiers	34	Table 5-14: Large Weapons List	67
Greyspace	35	Table 5-15: Weapon Turrets	67
Snagtooth Shipbuilding	35	Chapter 6: Ship Improvements	68
Blackdog's Frigate Infirmary	38	Weapons	68
Table 4-2: Blackdog Repair Costs	39	Weapon Installation	68
Krynnspace	41	Adding a Ram	69
Kristophan Nautical	41	Armor	69
Table 4-3: Kristophan NPC Encounters	41	Increased Thickness	69
Table 4-4: Kristophan Repair Costs	42	Plating	69
Table 4-5: Kristophan Repair Modifiers	42	<i>Optional Rule: Hide Plating</i>	70
Solamnic Schooner Sales	45	Stronger Materials	70
Table 4-6: Frequency of Ships	45	Maneuverability	70
Table 4-7: Very Rare Ships	45	Topping Out	70
Table 4-8: Rare Ships	46	Stripping	70
Table 4-9: Uncommon Ships	46	SR (Speed)	71
Table 4-10: Ships Never Sold	46	Cargo Capacity	71
Table 4-11: Common Ships	46	Thinning	71
The Black Market	48	Gutting	71
Realmspace	51	Table 6-1: Weapon Prices	72
Waterdeep	51	Other Modifications	72
Evermeet	54	Equipment Trade-Ins	72
The Dock	56	Special Arcane Modifications	73
Chapter 5: Ship Construction	59	Chapter 7: New Magical Items	75
Ship-Building Sequence	59	Accelerator	75
Ship Tonnage and Hull Construction	60	Amulet of Arachnid Control	75
Armor Rating and Saving Throws	60	Anchor of Staying	75
Rams and Ship Construction	61	<i>Lesser anchor of staying</i>	76
Maneuverability Class and Rigging	61	<i>Greater anchor of staying</i>	76
		<i>Cursed anchor</i>	76
		Antennae of Triangulation	76
		Astrolabe	76
		Ballistae, Magical	77

Table of Contents

<i>Neverending Barrel of Grog</i>	77	<i>Peg Leg of Walking</i>	84
<i>Neverending Barrel of Salt Pork</i>	77	<i>Net of Fishing</i>	84
<i>Basket of Devouring</i>	77	<i>The Plank</i>	84
<i>Bell of Warning</i>	78	<i>Magical Ram</i>	84
<i>Bombard, Magical</i>	78	<i>Rudder of Maneuverability</i>	85
<i>Box of Preservation</i>	78	<i>Rudder of Propulsion</i>	85
<i>Catapult, Magical</i>	78	<i>Rudder of Speed</i>	85
<i>Coat of the Seas</i>	78	<i>Sails of Maneuverability</i>	85
<i>Figurehead of Protection</i>	78	<i>Spelljammer Detector</i>	85
<i>Smiling Figurehead</i>	79	<i>Statue of Power (Old Salt)</i>	86
<i>Helmeted Figurehead</i>	79	<i>Medic with Bag</i>	86
<i>Armless Figurehead</i>	79	<i>Old Captain with Pipe</i>	86
<i>Armored Figurehead</i>	79	<i>Pirate with Peg Leg</i>	86
<i>Full-Bodied Figurehead</i>	79	<i>Pirate Mate with Rapier and Parrot</i>	86
<i>Sideways-Glancing Figurehead</i>	79	<i>Sails-Boy with Rope</i>	86
<i>Gravitic Stabilizer</i>	79	<i>Old Salty with Raincoat</i>	87
<i>Harpoon, Magical</i>	79	<i>Skipper with Hat</i>	87
<i>Bardic Spelljamming Helm</i>	80	<i>Swabbie with Bucket</i>	87
<i>Grand Spelljamming Helm</i>	80	<i>Weaponsmaster</i>	87
<i>Ki-Spelljamming Helm</i>	80	<i>Whaler with Harpoon</i>	87
<i>Radiant Spelljamming Helm</i>	81	<i>Sweeper, Gnomish, Magical</i>	87
<i>Helmet of Liaison</i>	81	<i>The Pump</i>	87
<i>Helmseeker</i>	81	<i>Trident of the Phlogiston</i>	88
<i>Hold of Holding</i>	82	<i>Turret, Magical</i>	88
<i>Jettison, Magical</i>	82	<i>Unseen Ship Crew</i>	89
<i>Lantern of Continual Light</i>	83	<i>Urn of Water Purification</i>	90
<i>Lantern of Spying</i>	83	<i>Vane of Location</i>	90
<i>Lighthouse</i>	83	<i>Wakizashi of Honor</i>	90
<i>Lyre of the Spheres</i>	83	<i>Ship's Wheel of Maneuverability</i>	90
<i>Mage Shot</i>	83		
<i>Ring-shot</i>	83	The Ship Record Sheet	91
<i>Dust-shot</i>	83		
<i>Snow-shot</i>	84	Appendix: Inspirational Reading	94
<i>Masthead of Durability</i>	84		

A Guide to Sidebar Subjects

Time	5	Rates of Exchange on Krynn	41
Celestial Body Classification	6	Fleet Movement	47
Signal Flags	8	The Evermeet Blockade	54
Spelljamming Speed	18	Elven Battlepoets	55
Who's Who in Fantasy Space	20	Insurance at The Dock	56
Scavvers	27	Wa, Pearl of the Orient	64
Air On Ships	28	Krynn Beyond Ansalon	68
Fix It Yourself	35	New Worlds	78
Scavenging in Spaceports	36	Ammunition Supply and Ship Combat	84
Marnar	38	Scro Fleets	88
The Flow of the Phlogiston	38	The Vodoni	89
Looking for a Crew	42		

INTRODUCTION

This, the first volume of the *War Captain's Companion*, details additional role-playing rules for characters who own their own ships. Herein can be found new proficiencies, new spacefaring items, new friends and foes. Also given are the details of new spelljamming companies around the spheres that have sprung up to maintain, rebuild, and improve spelljamming vessels—for a price.

Do the characters require a boat that can maneuver around a gold piece? How about one that can accelerate beyond the ship's maximum speed? Does the ship require a special magical item or a standard non-magical item that was previously unattainable? Does a character require a proficiency that isn't available yet? All these possibilities unfold in the pages that follow.

This book also details the rules and guidelines for constructing a ship from scratch. Building a ship from the hull up, adding accessories for as long as the money holds up, is the best way for a group of spelljamming adventurers to get the ships they really want. The biggest costs are those of money and construction time, as lack of funds (or the DM's discretion) can beach a party for awhile. New designs need shakedown cruises, which can lead to many additional adventures.

Within the pages of this tome, the possibility for splendid, almost hideously expensive ships exist! Imagine the excitement of boarding a ship built wholly of gold; the shining glory of a ship of mithril; the beautiful and rarest gem-laden vessels of celestial emperors. If the characters have a king's ransom to spend, they can do it right here!

The *War Captain's Guide* also describes the most prominent ship-building companies in the known spheres. From **Blackdog's Frigate Infirmary** in Grey-space, to **Solamnic Schooner** in Krynn-space, to **The Dock** (which sits on a glacier on the planet Toril in Realm-space), skilled workmen are available to help the characters repair, modify, improve (or booby trap) their vessel!

Finally, the greatest fleets in the known spheres come alive in an in-depth look at spacefleets of the void. The Torilian fleets of Wa, the Oerth fleets of the

Free Neogi, and the Kindori-Riders of Krynn are only a small sampling of the denizens that await the brave (and those who own a lot of ships!).

So, enter once more the realm of swashbuckling adventure, where pirates aboard spacefaring galleys seek to pillage and plunder calculating merchants and heroic adventurers; where elves in their great, butterfly-winged vessels patrol dangerous celestial shores, slaying evildoers who lurk in shadowed ways; where beholders, illithids, giffs, and neogi cross vast distances of space for their own, alien ends. Enter, and enjoy.

Concepts of Arcane Space

The SPELLJAMMER™ *Adventures in Space* boxed set details the basic concepts of arcane space; this chapter summarizes that information.

The particulars of fantasy space can be different from campaign to campaign and from world to world. Each major campaign setting is enclosed by a *crystal sphere*, and thus separated from the others.

All fantasy space, however, shares certain universal elements, which allow ships to fly between the planets and to voyage from one crystal sphere to another.

Fantasy space can be of two types: *wildspace* and the *phlogiston*. All space inside a crystal sphere is called wildspace. Crystal spheres are, in turn, surrounded by the phlogiston.

Wildspace is what comes to mind when we talk of "outer space." It is the vast emptiness lying between the planets. It is mostly airless void. Wildspace is filled with celestial bodies that are constantly in motion, and strange creatures that have adapted to life in this region.

The phlogiston is a turbulent, unstable, multi-colored, fluorescent gas (or gas-like medium) that fills the regions between the spheres. Like the crystal spheres themselves, the phlogiston is a great mystery; its origin and substance are unknown. When fire, sparks, or open flame comes into contact with phlogiston, they explode violently, making weapons or spells that use fire impossible to use safely here.

"Heed my warning, my son.
Take no stride upon the sparkling roads dancing above our heads.
Its addiction is far greater than that of any ale,
and its promise of demise is greater still."

Sarelk, Sage.

INTRODUCTION

Oddly, the phlogiston substance cannot be brought into a crystal sphere by any means. It evaporates immediately and without trace.

Each fantasy world setting is encased within a crystal sphere. Essentially, the crystal sphere keeps the wildspace in and the phlogiston out. The opaque crystal shell is an unbreakable barrier that must be penetrated before a journey to another realm can be accomplished. This passage is usually accomplished by spellcraft, magical item, or sheer luck (being at the right place at the right time).

Within wildspace (inside the crystal sphere), the planets, suns, moons, asteroids, comets, and the host of other planetary bodies traverse their endless courses. Most of these celestial bodies have an atmosphere of some sort, although it is dangerous to assume this is an inviolable rule.

Creatures great and small roam the vastness of wildspace. Spelljamming ships of all sizes, carrying those of human, demihuman, and unhuman kind, wend their ways through space.

The ships are powered by *spelljamming helms*, which turn magical energy to motive power. The common *minor helm*, and the less common *major helm*, allow powerful mages and clerics to move at *interplanetary speed* (a million miles per day!), until a large enough mass is encountered to drop the ship into a much slower *tactical speed*, which is used for planetary approaches, local travel, and docking.

Air Envelopes

Each object adrift in the void is assumed to carry with it a certain amount of air based on its mass. The bubble is known as the object's *air envelope*: The air envelope surrounding a ship in wildspace or the phlogiston is very important, for without it, the crew would die of suffocation. Spelljamming craft are assumed to take along 100 cubic yards of air per ton of the ship. Each "ton" of air has enough oxygen to support one man-sized crew member for four months. Creatures and characters of different sizes use different amounts of air, measured in man-sized air-days. Table I-1 gives these differences.

Table I-1: Air-Days By Creature Size

Size	Air-Days
Tiny	× 1/2
Small	× 1/2
Man-sized	× 1
Large	× 2
Huge	× 2
Gargantuan ¹	× 5

¹Gargantuan creatures are large enough to have their own gravity planes and atmospheric envelopes when operating alone.

Therefore, a ship of 60 tons can support 60 man-sized crew members for four months. In practice, however, ships do not always have a full complement of crew. This changes the amount of time a ship can stay in space. In most cases, this can be ignored, as entering a planet's atmosphere or using certain magics will freshen the air. In some cases, however, the players or DM may want to work out exactly how much air is left.

An easy way to determine the vessel's endurance in *air-days* follows. Four months equals 120 days (assuming 30 days per month). This number can be multiplied by the ship's tonnage in order to determine the number of "air-days" the ship has.

Example: A Hammership weighing 60 tons has 7,200 (120 × 60) days of air in its atmospheric envelope. This means a single man-sized crew member can live for 7,200 days (240 months or two years) on the ship. At the same time, 120 men on an identical ship can live comfortably for 60 days (two months). Simply divide the total air-days by the number of crew members, and the result is how many days they can survive on their ship before the air fouls.

A more complicated way to determine the amount of air available, is to subtract the number of crew spending each day on the ship from the total number of air-days left. This can be handy when the number of crew members changes due to deaths, crew lost overboard, or taking aboard passengers (or prisoners) from destroyed or damaged ships. This meth-

Time

Standard time in space is a 24-hour day, divided into three 8-hour watches. Seven days make up a week, four weeks make up a month. No standard year exists, but local years vary from ten to fifteen months, depending on local custom and conditions.

INTRODUCTION

od gives the most accurate account of air envelope usage, but slows down play considerably.

The air envelope of the ship is a naturally occurring phenomenon. The characters do not have to pay for it, nor count it in the ship's overall tonnage. Certain spells, such as *fog cloud* and *obscurement* can restore an atmosphere if no friendly planet is available.

Gravity

Every body in space has its own gravity. For smaller bodies, such as ships, gravity manifests as a *gravity plane* that passes horizontally through the object. Thus, in free space, a ship will have two "up" and two "down" directions, depending on what side of the gravity plane a crewman is standing on. For large bodies, such as planets, gravity pulls inward to a central point.

Even so, most ships have a definite "up". Not only is this more convenient for planetary landings, but in space, a smaller body's gravity plane will shift to match that of a larger body, if it comes within the gravitational field of the larger body. (Remember that "small" and "large" refer to tonnage, not necessarily physical size.)

This fact has been used to devastating effect in ship combat, leading to massive shifting of cargo, crew, and everything that isn't well-secured. Most ships, therefore, are well-supplied with netting and safety lines, and experienced spacefarers soon develop an eye for when to brace themselves against an unexpected gravitational shift.

The shell of a crystal sphere itself has no gravity, inside or out.



Using a Spelljamming Helm

The spellcaster operating a spelljamming helm finds his consciousness greatly expanded and, in fact, finds himself operating on two levels of perception at once. First, the helmsman retains the normal sensations of his physical body and is aware of actions going on around him. Although he cannot move or cast spells without breaking contact with the helm, he can talk with those around him normally.

On the second level, the helmsman feels the ship as an extension of his own body. The ship, to the limits of its gravity plane and air envelope, feels like a bubble under his control. Many helmsmen describe the sensation of being merged with the ship like that of personally flying among the stars.

Moving through wildspace or the phlogiston is no more than mentally visualizing the distance and direction the ship should move (usually given by the navigator, based on his charts) and willing the ship to move in that direction. The feeling of movement has been compared with moving a limb that has fallen asleep—a pins-and-needles sensation, though less painful than that.

The expanded consciousness of the helmsman makes him aware of the actions of the crew as though he stood on the aft deck (or equivalent), but their actions do not register directly unless he pays special attention to them.

The helmsman can maneuver the ship sluggishly, but any real maneuver—like a turn—takes the ship down to tactical speed. In combat, the helmsman is limited by the feel of the hull and its capabilities and cannot maneuver the ship above its capacity without additional magical aid. In most spelljamming ships, a crew is required to provide true maneuverability.

During combat, the helmsman is aware of damage to the hull as bright flashes of pain, but these are not usually severe enough to cause him to lose control. An exception is the "Spelljammer Shock" critical hit, which incapacitates the helmsman. Since this would render the ship helpless, most ships going into combat often to have a reserve helmsman or two.

Celestial Body Classification

All celestial bodies have a letter code that classifies them by size. These include:

Code	Miles Across	Code	Miles Across	Code	Miles Across
A	Under 10	F	4K-10K	I	1M-10M
B	10-100	G	10K-40K	J	10M or more
C	100-1K (1000)	H	40K-100K		
D	1K-4K		100K-1000K (1 M)		

Earth, and most earthlike fantasy campaign worlds are size E.

1: SPACEFARING PROFICIENCIES

This chapter details additional proficiencies that can be useful on a properly-run spelljamming ship. Some proficiencies grant a general ability to perform a task (those that have no *relevant ability* or *check modifier*). Others require the player to roll a proficiency check (if the skill is common or the task simple, such as general Carpentry, a proficiency check is not usually required).

To use a proficiency, the character must have access to any tools necessary, if applicable (e.g., a carpenter needs his tools). When rolling for the successful use of a proficiency, the player modifies the character's relevant ability score by the check modifier, and rolls a 1d20. If the roll is equal to or less than the adjusted ability score, the attempt succeeds. If the roll is greater than the character's adjusted ability score, the attempt fails (a roll of 20 always fails). The DM determines what effects, if any, accompany the failure.

Table 1-1: Non-Weapon Proficiencies

Proficiency	# of Slots Req'd.	Relevant Ability	Check Mod.
Astronomy	2	Intelligence	+0
Balance	1	Dexterity	-2
Carpentry	1	Strength	0
Fire Control	1	Wisdom	+0
Freefall	1	Dexterity	-2
Languages, Space	1	Intelligence	0
Leadership	2	Charisma	-2
Navigation, Celestial	1	Intelligence	-2
Planetology	1	Intelligence	+0
Sail Manipulation	1	N/A	N/A
Semaphore	1	Intelligence	+0
Slow Breathing	1	Constitution	-5
Spelljamming History	1	Intelligence	-1
Survival, Wildspace	2	Wisdom	-3
Weapon Loader, Ballista	1	N/A	N/A
Weapon Loader, Catapult	1	N/A	N/A
Weapon Loader, Jettison	1	N/A	N/A

Table 1-2: Large Weapon Proficiencies

Proficiency	# of Slots Required	Relevant Ability	Check Modifier
Ballista	1	N/A	N/A
Catapult	1	N/A	N/A
Jettison	1	N/A	N/A

Astronomy: This proficiency gives the character an understanding of celestial mechanics for both standard and non-standard systems. In any system, the character may be able to determine the relative placement and future courses of celestial bodies (even variable orbits of comets and asteroids) by studying the overall system pattern. The smaller the celestial body, the more difficult this task becomes.

The character can also use this proficiency to determine which planets have intelligent creatures, civilizations, etc. This use of the proficiency may require preparation by the DM, since information regarding a new crystal sphere might be discovered when the characters first enter it. Characters with this proficiency *and* Navigation gain a +1 bonus to all Navigation proficiency checks.

Freefall: This proficiency is handy when a ship's gravity plane shifts. This can cause objects, cargo, weapons, and crew members to fly across the deck, or even straight up! This proficiency gives the character the chance to personally counter these shifts.

If the proficiency check is successful, the character does not need to roll the usual Dexterity check. The character recovers quickly and continues with his current duties as though nothing happened. If he is manning a weapon, he can still attack. If loading, he is not interrupted. If the proficiency check fails, the character is required to roll the standard Dexterity check to see if he maintains his balance. This proficiency does not negate the disruption of activity due to a Ship Shaken critical hit.

Carpentry (Spelljamming): The character is familiar with the techniques for building and repairing wooden spelljamming ships, and can oversee nor-

"Ya see, just pitch a rock oota th' ship.
She waggles up an' down crosst th' center plane as she drifts out
t' th' edge o' th' void. Jump wrong an' miss the ropes, laddie,
and yer'l foller 'er."

Derek Flinthand, Sail Master (retired)

1: SPACEFARING PROFICIENCIES

mal carpenters working on spelljamming vessels. The tools, machinery, and materials necessary must be available. Unusual and complicated jobs may require a shipwright to oversee the work. Jury rigging to restore hull points, masts, or spelljamming rigging requires a successful proficiency check. If this check fails, the character either fails to repair the damage or the repair must save as thin wood vs. crushing blow each time it is stressed, at the DM's option.

Fire Control: Characters with this proficiency can fight fires more efficiently than others. Whenever a fire is being fought on a ship, the character who makes a successful proficiency check is able to cut the size of the fire by two points. If the save fails, the character lessens the fire's size by only one point.

Languages, Space: The character has mastered a difficult and obscure language once spoken in wildspace, now primarily found in the writings of pedantic sages. The main use of the language is to read tomes of ancient secrets written by long-dead mystics. This proficiency enables the character to either read or speak the language (his choice).

Large Weapon (Ship-Mounted): This weapon proficiency allows the character to better utilize the large weapon chosen. The character gives the weapon crew a +1 bonus attack when serving with them. Also, the character is familiar with the safe handling of the weapon, its maintenance, and can make simple adjustments and repairs to them. Characters with these proficiencies often receive double pay because of their skill.

Leadership: This proficiency benefits a ship captain only. By asserting himself (making a successful proficiency check) he can give the crew bonuses. They gain an additional +1 to their morale score, as well as a +1 THACO bonus, for 1d4 rounds. If the check fails, the crew suffers a -1 morale penalty, and a -1 THACO penalty for one round.

Navigation, Celestial: The character has learned the arts of wildspace navigation. This proficiency is not useful on land or sea. In wildspace, a successful proficiency check allows the navigator to know his position relative to his destination, course, speed, and approximate arrival time. A navigator can bypass large (celestial) obstacles and return easily to the desired course. A character with this proficiency on a ship equipped with a pool or series helm can use his THACO at half level to direct a ram attack.

Sail Manipulation: This proficiency allows a sails master (officer) to control the use of sails with such skill that the ship gains a one step bonus to its Maneuverability Class for one round. The ship's MC cannot go above A. If more than one character succeeds in using the Sail Manipulation proficiency in one round, the ship's Maneuverability Class is reduced by one step, to a minimum of MC F.

Planetology: The character has learned the legends, lore, and history of some planet or thread of time in some distant sphere. The knowledge must be world specific (e.g., Toril, Oerth, Karpri, Krynn, etc.). The DM can restrict the selection to certain planets, or can allow the player to choose. Thus, a player could know details about the Unhuman Wars, or the history of the planet Glyph, or whatever else is available in the specific campaign. The knowledge acquired gives the character familiarity with the principal legends, historical events, characters, locations, battles, breakthroughs (scientific, cultural, and magical), unsolved mysteries, crafts, and oddities of the time or place. The character must roll a proficiency check to identify places or things he encounters from that age or location.

Semaphore: This proficiency allows the character to use semaphore flags to signal other ships. Organized war fleets use these flags as a standard communications tool. Most fleets have at least two persons on each ship who can use the semaphore flags. No proficiency check is required under normal circumstances. In times of combat, however, a profi-

Signal Flags

Although various races have their own flags and ways of signalling with them, several flags are fairly universal in their meaning.

Yellow Flag with a Black Spot: The universal warning of plague and quarantine.

Red Flag: Flown in combat, this flag means "no quarter", no prisoners will be taken.

1: SPACEFARING PROFICIENCIES

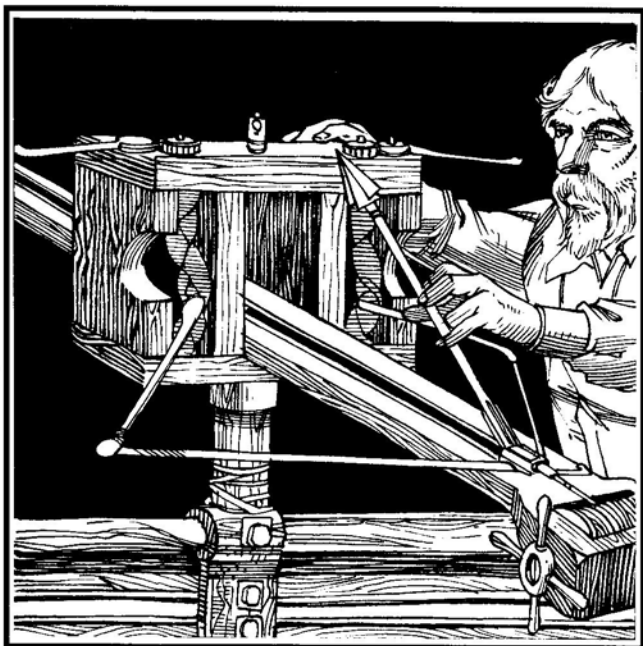

ciency check is required for receiving a signal. Failure means the signal was unclear. In this case, the sending character can start over the next round.

When one Semaphore proficiency is owned, the character can send ten words in a round, and can receive ten words the next round. For every additional proficiency, increase the number of words that can be sent or received by five. The characters should be careful that the messages they send are at the speed that the receiver can understand, and vice versa. Fast senders and receivers are often used to code the transmissions.

Slow Breathing: This technique is a special spell-jamming proficiency. It allows the character, with a successful proficiency check, to reduce by half the amount of air his body requires for one day. Concentration is required throughout the process, although simple actions like walking, sitting, eating, and listening to music are possible. Talking, fighting, etc., require the character to roll another proficiency

check. This proficiency is useful when a character is trapped on a small ship with very little air available.

Survival (Wildspace): This proficiency gives the character an understanding of the hazards he might face in wildspace. He knows the methods required for survival in the emptiness between the celestial objects. A character with this proficiency can survive on one-half food, water, and air rations each day he makes a successful proficiency check. Each day the character fails the proficiency check, he uses a full day's supply of water, food, and air.

Once the air, food, and water supplies are exhausted, the character must roll a Constitution check every day at a cumulative -1 penalty to stay alive. After three days consecutive with no food, water, or clean air, the character passes out, never to awaken until exposed to clean air, food and water. Once the character fails the Constitution check, he will die in a number of days equal to his Constitution unless rescued. If rescued, the unconscious character gets a Constitution check every day at a cumulative $+1$ bonus until he awakens. He must have complete bed rest for three days before he can exert himself again.

Weapon Loader: This proficiency allows a character to load and arm the large weapon of choice better and more quickly. These include large ship-mounted weapons such as ballistae, catapults, jettisons, bombardments, and others. The weapon crew to which this character is assigned can reload one round faster. This means if a character has proficiency in heavy ballista, the reloading time for the crew is decreased from $1/4$ to $1/3$. The Weapon Loader proficiencies of several different characters cannot be applied to the same weapon. Characters with this proficiency are valuable crew members, and often receive double pay because of their skill.

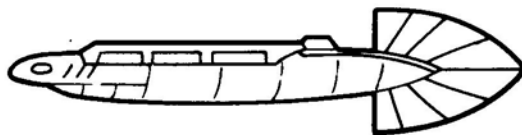

White Flag: A sign of surrender or non-hostile intent, usually hoisted after the ship's own colors have been lowered, or "struck". The white flag is also flown by ships carrying ambassadors.

Jolly Roger: The traditional "skull-and-crossbones" remains a favorite of pirates everywhere.

In addition to signal flags, a ship might fly the personal or rank flag of its captain, company, kingdom, or adventuring group.

1: SPACEFARING PROFICIENCIES

Semaphore Signals



A



B



C



D



E

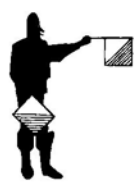

F



G

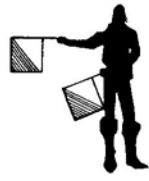

H



I



J



K



L



M



N



O



P



Q



R



S



T



U



V



W



X



Y



Z



ERROR



END OF
WORD



NUMBERS
FOLLOW



END OF
MESSAGE

Note: For numbers A = 1, B = 2 etc., to J = 0

2: CAP'N GYUDD'S SPACEFARING GEAR

Cap'n Gyudd owns a small shop on the west side of the Rock of Bral. (The west side is the section closest to the docks.) His company, simply named *Cap'n Gyudd's*, is a location most popular with the spacefaring crowd. (No tour to the Rock is complete without a jaunt through Cap'n Gyudd's.) Items of importance (all nonmagical) can be procured here for a relatively honest price. His favorite saying is "*If ya kin find it elsewhere fer cheeper, ya better git it.*"

Cap'n Gyudd (Fighter 14)
Warrior (retired)

Age: 172 Years
Sex: Male
Height: 47"

Race: Dwarf
XP: 575,000
Weight: 157 lbs

AL: CG	HP: 126	THACO: 11
AC: 3	#AT: 3/2	DMG: 1d8
STR: 18/23	INT: 13	DEX: 9
CHA: 14	WIS: 10	CON: 18

Magical Gear: *Hammer +3, dwarven thrower; chain mail +2; ring of jumping; ring of protection vs. charm.*

Cap'n Gyudd, as everyone calls him, goes by no other name. Even he claims that he has no given name. A long-time adventuring partner of Gamalon (a particularly colorful character living on The Rock as well), they throw business each other's way as often as possible. When a patron of Gyudd's is looking for magical items, he sends them to Gamalon, while Gamalon sends the "traditional" buyer to Cap'n Gyudd's.

Cap'n Gyudd is a wiry old dwarf with a whitening beard and noticeable limp. He, like most dwarves, likes his beer, and he prefers it even over womanly companionship. His shop smells of the rancid tobacco smoke he enjoys. He likes to listen to the yarns spun by his patrons; these same tales often bring in the land-lovers who listen to such tall fables with eagerness. (Cap'n Gyudd often sells space souvenirs and nautical mementoes to these wistful



dreamers.) Unfortunately, his store also attracts the "wish-I-weres" who wish they had the guts to travel in space, or never had the chance before they married. The Cap'n calls these people "Breakfast table commandos."

Back in his younger and wilder days, this elderly dwarf fought his way out of certain death in an illithid "cattle" ranch (the "cattle" being humans and demi-humans), and saved the lives of nearly three dozen other individuals. His most famed exploit, however, was when he climbed atop a heavy catapult, and shot himself to an enemy craft. Unfortunately, the force of the slingshot was so great, he passed out. When he awoke, he found himself on the enemy's deck, bleeding, with part of his left leg still caught high in the rigging. His leg was amputated and cauterized to stop the bleeding, and he almost died. At the ship's next stop, the Rock, he packed his bag and hopped off the ship, using his bag to balance himself. That was the day he officially retired.

He crafted himself a peg leg from what he termed

"Lookit all of this STUFF!"

Davida Wrenthead, Gnome Mechanic

**(Reputed last words before disappearance;
last seen entering Capt'n Gyudd's.)**

2: CAP'N GYUDD'S SPACEFARING GEAR

"a radiant dragon's eye-tooth," but to everyone else, it looks like nothing more than highly polished ivory. With the money he made adventuring, he bought a small shop on the west side of the Rock, on the edge of the dwarven community, where he still receives heavy traffic from the main docks. His business clears about 75 gp before taxes and property payments. (After all is said and done, Cap'n Gyudd takes home about 18 gp per month; a sufficient amount to secure his place in the lower upper class, a position he enjoys.)

Cap'n Gyudd sells miscellaneous equipment. This consists strictly of nonmagical items that are not necessarily standard options when purchasing a spelljamming ship. The items do make life on a spelljamming ship easier, so he considers his shop a convenience store. He purposely avoids stocking magical equipment because he does not like the company these items attract. When he originally carried magical items, the roughest and sleaziest adventurers would moor themselves in his store, steal him blind, and attempt to "bargain" themselves items for nothing by using *charm* and *control* spells.

Hating thieves and adventurers who act like he did in his earlier days, Cap'n Gyudd now sells only quality nonmagical items. He has a staff mage who circles the store occasionally to cast *detect magic* to see if there are any magical items in new stock. If there are, Cap'n Gyudd takes them over to Gamalon's Curios, selling them to his friend for a price significantly below cost. Gamalon then sells them for up to ten times that price.

Below, a list of items that can be purchased from Cap'n Gyudd's is given for the DM's approval. Many of these items may seem useless at first, but they are highly useful in nautical terms, perhaps mandatory for smooth ship running. Each item below has a basic price, but these costs can be altered for item scarcity. (These items can also be used with water-sailing craft as well.)

Anchors: Anchors are used to moor a ship in place when they land on the water. They are not necessary

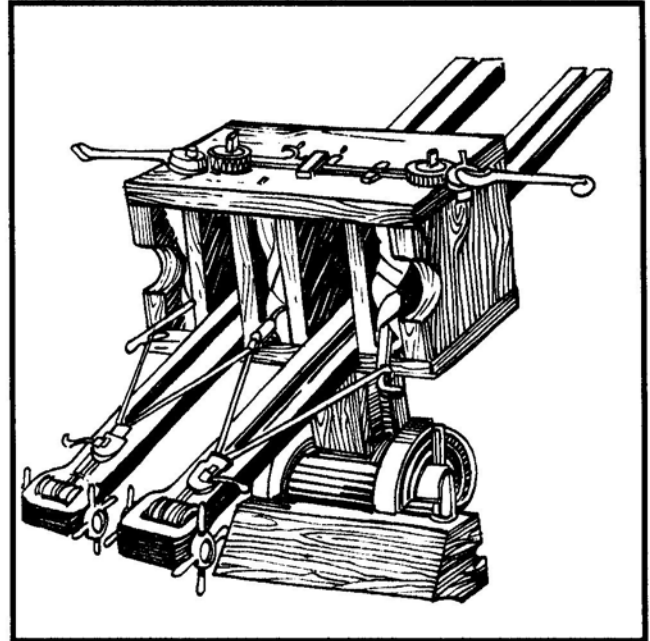

for ships that can only land on soil, or for those that can never land. (On those special spelljamming ships, anchors are usually attached anyway, but for aesthetics alone.) They cost 2 gp for every five tons of ship. (For example, a *nautiloid* anchor costs 14 gp since the ship weighs 35 tons.) In wildspace, dropping an anchor will not reduce the ship's MC, AR, or SR. Magical anchors, which may be able to pull a ship out of spelljamming speeds into a complete halt, can't be bought here (see New Magical Items).

Ballistae, Dual-Mounted: Dual-mounted ballistae have room for two ballista bolts along the weapon's main beam, allowing for multi-bolt firing. The firing cord is firmed and specially coated across the pull's apex to allow for dual firing without the bolts striking into each other as they soar from the weapon. The dual-mounted ballista fires the two ballista bolts together, approximately six to eight inches apart.

Note: If the weapon is used to fire only one bolt, the weapon receives a -3 penalty to its THACO.

"Trooper, what's better than a *Regulation Ballista*, single mount?"

"A *Regulation Bombard*, with powder, sir!"

(An example of Giff military humor)

2: CAP'N GYUDD'S SPACEFARING GEAR

After being misused three times, this weapon will break any time a 1 is rolled.

Light Dual-Mount Ballista

Cost: 800 gp
Range: 5 Hexes (2,500 yards)
Damage: 1d3 Hull Points
3d6 Hit Points
Crew: 2
Rate of Fire: 1/3
THACO: 16
Critical Hit on: 20

Medium Dual-Mount Ballista

Cost: 1,200 gp
Range: 3 Hexes (2,500 yards)
Damage: 1d4 Hull Points
2d10 Hit Points
Crew: 3
Rate of Fire: 1/4
THACO: 14
Critical Hit on: 19+

Heavy Dual-Mount Ballista

Cost: 1,600 gp
Range: 2 Hexes (1,000 yards)
Damage: 2d4 Hull Points
4d10 Hit Points
Crew: 5
Rate of Fire: 1/5
THACO: 12
Critical Hit on: 18+

Belaying Pin: These short rods of metal or wood are wedged into the railing of a ship to secure the lines from the booms and sails. These sails must be firmly anchored in place to properly catch the currents of wildspace and the phlogiston. Wooden belaying pins costs one silver piece for a set of 12, while metal ones cost one gold piece for a dozen.

Bells: Bells are used to summon the crew for meal breaks, shift changes, sleep period endings, or crew meetings. Bells cost 12 sp each, with each ship usu-

ally having up to six. They are all controlled from the navigator's, captain's, or the helmsman's chamber. Below, a list of bells is given with the standard meaning:

1 Bell: Shift change, Sleep period end.

2 Bells: Meals are being served.

3 Bells: Meeting on the main deck.

Constant: Planet Ho!, Sphere Ho!, Intruder Alert!

Boarding Planks: These removable wooden platforms are commonly used to during boarding actions, instead of swinging to the enemy ship using ropes and lines. These planks are laid across the ships' railings to form a makeshift bridge. The crew then boards the enemy craft on them to do battle.

If the ships move too far apart, the boarding planks fall back to the gravity well of the attacking ship. Boarding planks cost 3 gp each, are five feet wide, 30 feet long, and can support 1,000 pounds each. Stronger ones are available, with special hooks and grapples (grappling bridges), but cost up to ten times more.

Booms, Sail: Booms are long spars extending from the masts to secure the bottom of the sail. Without the bracing provided by this wooden spar, the sail would flap uselessly. Sail booms generally cost 1 gp to 40 gp, depending upon their size. Metal booms are also available, but may require an additional crew member to man. They cost ten times as much as their wooden counterparts.

Buttons: These are needed for sailor's clothing, especially those made of sailcloth. When sails are worn, ripped, or otherwise rendered useless, crew members are generally allowed to cut the fabric into pant and shirt material. This material, too strong for normal sewing methods, is usually held together by snaps, rivets, or buttons. The latter, sold by the gross (144 buttons per gross), cost 1 sp. See the *canvas* entry for more information.

"Beware the sly merchant and his warehouse full of tricks.
Simplicity serves the wise man best."

Sarelk, Sage

2: CAP'N GYUDD'S SPACEFARING GEAR

Canvas: Canvas is the main material used in the construction of sails. When its life as a sail (whether sea or space) is over, the canvas is often used as clothing. At 4 sp per square yard, this worn and comfortable material is often a prized possession, sought after by crewmen and port tailors.

The material is sized and riveted to the specifications of the wearer. Commonly, the ship's carpenter tailors the clothing when he has time. The carpenter tends to make 10 sp for every pair of pants, and 8 silver pieces per shirt. The cloth normally fits snugly, allowing the character to perform duties comfortably. (Some unpopular ship captains sell their worn sails to port tailors for 1 sp per square yard instead of giving them to their crew.)

Crow's Nest: The crow's nest is a small basket built near the top of the mainmast. Here, a crew member can stand and look about for land (when traveling on water), crystal spheres, planets, and other ships. If someone is up in the crow's nest, it is harder to sneak up on the craft (a bonus of +2 on all encounter distance rolls). A crow's nest costs 30 gp excluding the ladder.

A crow's nest can be placed on the bottom of the vessel as well. This, however, limits the craft's ability to land. (Landing on the ground would surely crush the nest, and anyone inside it!).

Figureheads: Originally, figureheads helped sailors overcome their superstitious nature and fear of the unknown. If the ship had a figurehead, the crew often felt more at ease knowing that something friendly was watching over them, constantly guiding their voyage onward. Today, figureheads are often added to ships for purely aesthetic reasons.

The table shows many different figurehead options and their costs. Add the prices of all options that are present on the figurehead being purchased. The starting price for figureheads is 100 gp. (See the New Magical Items chapter for magically-enhanced figureheads.)

Type	Cost (in gp)
Armless	-20
Armored	-10
Female	+30
Figure With Headgear	+20
Full Figure	+50
Half Figure	-10
Painted	+80
Sideways-Glancing	+30
Smiling	+10
Water-Living	+10

Grappling Hook: Grappling hooks are very effective when used to grapple (or pull) two ships together. They are useful in boarding enemy ships or in rigging a tow. The following rules can be used for individual characters using grappling hooks.

The table shows the attack penalties for distance when throwing these weapons, as well as the rate at which the weapon can be thrown. Note that when more distant throws are attempted, the rate of fire decreases. This is due to the amount of time necessary to wind the rope back up after a miss.

Range	Range in Feet	Attack Penalty	ROF
Short	1'-25'	-1	1/2
Medium	26'-50'	-2	1/3
Long	51'-75'	-4	1/4
Extra-long	76+'	-5	1/5

By spending a nonweapon proficiency slot, a character can throw a grappling hook at one-half the attack penalty (round fractions down). Individuals cannot be effectively attacked with this weapon. It is merely a tool used against ships. Grappling hooks never cause damage to a ship.

If the attack roll is a 20, the DM can roll on the Critical Hit chart in the *Combat Among the Stars* booklet.

If the result is a "Crew Casualty", a randomly determined crew member aboard the enemy craft suffers 1d6 points of damage, and the character must pull the grappling hook back and try again. Any other critical hit result is ignored.

"Hey, sailor—didja get them pants on sale . . .
or were they part of one?
Haw! Are you rigged or what?"

(A sure invitation to a spirited discussion in any pub that is frequented by sailors and groundlings. Bring your own splints.)

2: CAP'N GYUDD'S SPACEFARING GEAR

Grappling hooks cost 8 sp each.

Horn Tube: Horn tubes are a gnomish device used to communicate with remote areas of the ship. The device consists of two tubes that run into every room on the ship. There is a receiving tube as well as a sending tube. By blowing through the sending tube, the user alerts the operator and can ask to be connected to a specific room (or the whole ship). The operator connects the two tubes together, and the two distant room occupants can communicate with each other. When the communication is over, the operator unhooks the tubes, and awaits another communications alert.

Except in the case of an all-ship bulletin, only two rooms can talk with each other. Three cannot be connected together. Also, there is no limit to the number of communications that can occur at the same time. These items cost 1000 gp for an operator console that can hold tubes for 20 rooms. (Ships that have more than 20 rooms must get more than one console, and there is no limit to the number of consoles that can be used on a single ship.) Each pair of tubes costs 50 gp each. Each console takes 1 ton of cargo space.

Ladder: Ladders are commonly used to board ships whether they are landing on water or on land. Without ladders, it would take a great deal of time to scale the mainmast to enter the crow's nest. Ladders can be climbed at half the character's movement rate. A ladder costs 5 cp per 10 feet.

Lantern: Lanterns generally hold a flammable substance, such as oil, to provide a controlled burning that results in light, and occasionally warmth. Lanterns, however helpful in wildspace, are terminally lethal in the phlogiston. Whenever entering this volatile area, crews make sure that all lanterns are snuffed. There are three basic types of lanterns: the large signal *beacon* costing 150 gp; the *bull's eye*, costing 12 gp; and the *hooded lantern*, costing 7 gp. All these, as well as other standard lamps and lanterns, can be specially purchased without the oil res-

ervoir (no change in cost). The modified lanterns hold special items (usually gems) enchanted with the dweomer of the *continual light* spell. The magic must be acquired independently, of course. These special *continual light* lanterns can be taken into the phlogiston without dire effects to the air envelope.

(DM Note: All lamps that burn a substance in order to provide light will use man air-day of oxygen from the air envelope per week (see the section on Air Envelopes).

Life Preserver: Costing 4 sp each, life preservers are round floatation devices used to rescue a comrade who has fallen overboard. The basic cost of the item does not include a rope, which must be attached before the preserver can be used.

In wildspace, the preserver is thrown out into the gravity plane of the ship, where it falls up and down across the gravity plane until it is caught by the crew member who has fallen overboard or comes to rest on the plane. The rescued person can then be pulled toward the ship, where he can grab netting, a ladder, or some other support. Some ships, especially those that see heavy battle, have been seen with several dozen life preservers.

Map case: Map cases are cylinders of bone, ivory, or leather that can hold up to two rolled maps or similar papers. Once sealed inside, the papers are immune to water damage and take no damage from special attacks if the map case makes its saving throw. Map cases cost 8 sp each.

Mooring Bits: Mooring bits are very similar to belaying pins in function. Mooring bits, however, are used to secure a ship to a dock. A ship needs one mooring bit for every 25 tons (or portion thereof) of displacement. (For example, the *Quad of Thay*, a 63 ton ship, requires three mooring bits). Without the required number of mooring bits, the ship cannot be securely fastened to the dock. For example, in a storm, the ship might have to save vs. crushing blow or take 1d4 points of hull damage for every mooring bit missing. Mooring bits cost 2 gp each.

**"I like to buy a dozen belaying pins at a time.
Actually, I don't believe in beating obedience into a crew.
I do believe in getting their attention."**

**Kyrial Alathar Pellinore, son of Chiros Pellinore
Third Lord of Everlund and proud servant of Tyr**

2: CAP'N GYUDD'S SPACEFARING GEAR

Netting: Netting is common among ships like the Skeleton Ship or the Sidewheeler. It is used to keep crew from falling off the ship during battle, such as when taking a "Ship Shaken" critical hit. Exposed crew gain +2 to their AC against missile weapons or magic that creates solid objects. Netting also gives all exposed crew a save vs. death to avoid damage from catapult stones. Netting is destroyed under the following circumstances: one heavy catapult hit; two medium catapult hits; two rounds exposure to greek fire. Light catapults, jettisons, and ballistae cause no damage to netting. In a boarding action, boarders must cut through the netting before they attack the crew. Netting has 5 hit points and AC 10. Defenders under the netting can attack boarders if armed with piercing or blunt weapons. Netting costs 3 gp per ton of the ship.

Paper: This is a high quality writing paper that can be bought by the strip or by the page. Paper is used to make maps or to record details of a voyage (such a record is called a *log*). A strip of paper one foot wide and ten feet long costs 2 gp. Ten pages that are one foot square also cost 2 gp.

Parchment: This is a lower quality paper-like substance that can be used for the same purposes as paper. Parchment is sold on scroll bars and is available in pages that are one foot square. A piece one foot wide and twenty feet long, or twenty one-foot-square pages can be bought for 1 gp.

Peg Leg: Now more a novelty item than anything else, peg legs were originally designed to replace a leg lost to accident or misadventure. Different sizes are available, but they all generally cost the same, depending upon the manufacturing material used. Only characters too poor or weak to bargain for a clerical *regeneration* spell resort to these devices.

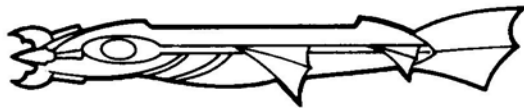

Material	Value
Child Novelty	1 cp
Wood	1 sp
Metal	1 gp
Ivory	3 gp
Brass	25 sp
Copper	25 sp
Silver	25 gp
Gold	250 gp
Platinum	1,250 gp

Rope, Nautical (Hawser): Rope serves two general purposes on a ship. The hawser is a rope of great size and strength used for mooring and tethering. Hawser are very rough and can cause bleeding and blistering of the palms even after only a few short minutes of use. Twice pentad-braided for the greatest possible raw strength, almost nothing will break them (multiply the diameter in inches by 5 for its hit points). Hawsers can be purchased in lengths up to 1,000'. The raw weight of the rope is given in parenthesis.

	Diam.	50 ft length	100 ft length
Thin	2"	8 gp (140 lbs)	15 gp (280 lbs)
Average	3"	15 gp (320 lbs)	30 gp (640 lbs)
Thick	4"	30 gp (570 lbs)	60 gp (1,140 lbs)

Rope, Standard: The standard hemp rope is also available. Constructed from high-quality, tightly-wound hemp, these are shaved to be less irritating to the unprotected hand. Made of a blend of fibers, standard ropes are triple-braided for extra strength. Standard hemp rope costs 1 gp per 50' of length.

	Diam.	50 ft length	100 ft length
Extra thin	1/4"	2 sp (2 lbs)	4 sp (4 lbs)
Thin	1/2"	5 sp (10 lbs)	1 gp (20 lbs)
Average	3/4"	1 gp (20 lbs)	2 gp (40 lbs)
Thick	1"	2 gp (35 lbs)	4 gp (70 lbs)

Rope, Silk: For lightweight strength and a smooth, non-tearing surface, silk ropes are the superior rope to own. Perfect for ship sails, these silken lines do

"The broadside attack is the greatest threat the giff Clipper ship has. Trust me. Don't mess with them!"

Sharondel, Gauntlet Company

2: CAP'N GYUDD'S SPACEFARING GEAR

not cause blistering of palms, and their graceful construction keeps them from twisting into knots, or tearing the delicate sails. However, silk is rare, ten times the cost of hemp, if it is available.

	Diam.	50 ft length	100 ft length
Extra thin	1/8"	3 gp (2 lbs)	6 gp (4 lbs)
Thin	1/4"	5 gp (4 lbs)	10 gp (8 lbs)
Average	1/2"	10 gp (8 lbs)	20 gp (16 lbs)
Thick	3/4"	20 gp (16 lbs)	40 gp (32 lbs)

Sextant: Normal sextants are simple brass navigational instruments that are used to measure the altitudes of familiar celestial bodies in order to find the location of a ship on a planet. (Usually a stationary object, like the brightest and most northern star, is used.) Nautical sextants are useless on a spelljamming ship.

Sextants are usually made of brass or copper. The standard brass sextant sells for 20 gp, and it well withstands the effects of saltwater and normal tarnishing. The special collector's edition copper sextant sells for 50 gold pieces. (The copper costs much more because it is sold pre-tarnished to give it that old, worn look.)

Sextant, Spelljamming: The spelljamming sextant is a specialized navigational instrument that is used to measure the altitudes, and relative distance between three special, bright, and stationary celestial bodies. This sextant can determine the location of a spelljamming craft within a crystal sphere when it is used by a character with the Celestial Navigation proficiency.

This item can be used on seafaring ships, but somewhat less efficiently than a nautical sextant. The spelljamming sextant sells for 100 gp for the brass model, and 250 gp for the copper tourist collector's version. (Like the standard sextant, this copper version is sold pre-tarnished to give it an old, worn, antique look.)

Spyglass: The spyglass consists of a two-part brass outer sheathing that protects two precisely-ground

lenses. The outer sheathing comes in two parts, one fitting snugly into the other. By slipping the inner sheath in and out, objects far away can be seen as though closer, and objects near can be seen as though very close. The outer mechanism is difficult to construct, and the special lenses inside are extremely expensive and time-consuming to produce. Spyglasses allow the user to see three times as far, or to see three times the detail. A spyglass costs 1,000 gp.

Wheel, Ship's: The ship's wheel controls the angle of the rudder and helps direct the ship. While this is important for a seagoing vessel, it is not necessarily as important in wildspace, unless the ship has one of the magical rudders (see New Magical Items). The wheel itself costs 200 gp, but the mechanisms that run from the wheel to the rudder, on the other hand, costs 50 gp per ton to buy, mend, or replace.

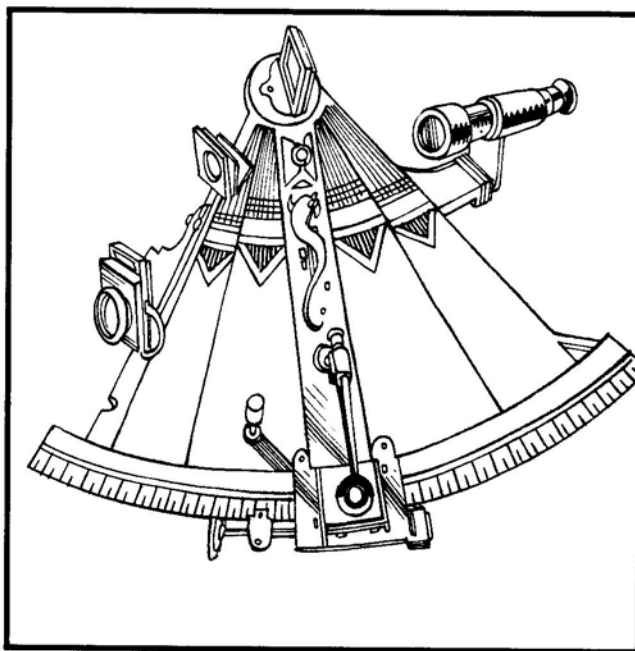

“... Never met a mind flayer on the end of my halberd that I didn't like!”

Saive Flayerbane, Halberd Company

3: SPACEFLEETS OF THE VOID

Space is filled with the denizens of nearly every conceivable race. The beholders, neogi, illithids, humans, and the elves have always had a place in space. Other races, however, like the goblins, orcs, scro, and other goblinkin races, are making a strong comeback. Newer races, like the drow elves and the Krynnish kender, seem to be making a giant leap forward in space-travel technology as well. As of yet, however, their influences are minuscule. This chapter details some major fleets, their leaders, and their ships and crews.

Beholder Fleets

Beholder fleets revolve around disjointed family units that share a common genetic pattern. Those with physical traits that do not match those of the rest of the family are destroyed or thrown out of the group. These unstable fleets flow through space, searching to purify their race. Each group believes it is the perfect strain, so they are constantly trying to exterminate every other beholder band. All, however, accept orbis beholders, who link in series to power the beholder ships.

The beholders ride about in fairly small, yet gruesomely repulsive ships. Normal spacefaring individuals avoid them. If you think one beholder by itself is a nasty opponent, picture yourself tussling with a full beholder ship, or even a fleet! Luckily for all spacefarers, the beholders are concerned with the ships of the "inferior" beholders. They do not give other races a second thought, unless they need new supplies or an air freshening.

The Beholder Chain of Command

There is only one chain of command in a beholder fleet:

- The fleet's hive mother
- The ship's hive mother
- The ship crew in order of power.

The table below determines how many vessels are encountered when a beholder fleet is confronted.

The table uses a percentile roll to find the size of the fleet, giving the number of Tyrant Ships and Tyrant Scout ships present.

Alternatively, the DM can split the forces into relatively equal halves, and pit the beholders against each other. The two factions differ in some way which makes them mortal enemies!

Die Roll	Tyrant Ship	Tyrant Scout
01-09	1	1
10-18	1	2
19-27	2	1
28-36	2	2
37-45	3	2
46-54	3	3
55-72	4	3
73-99	5	4
00	6	5

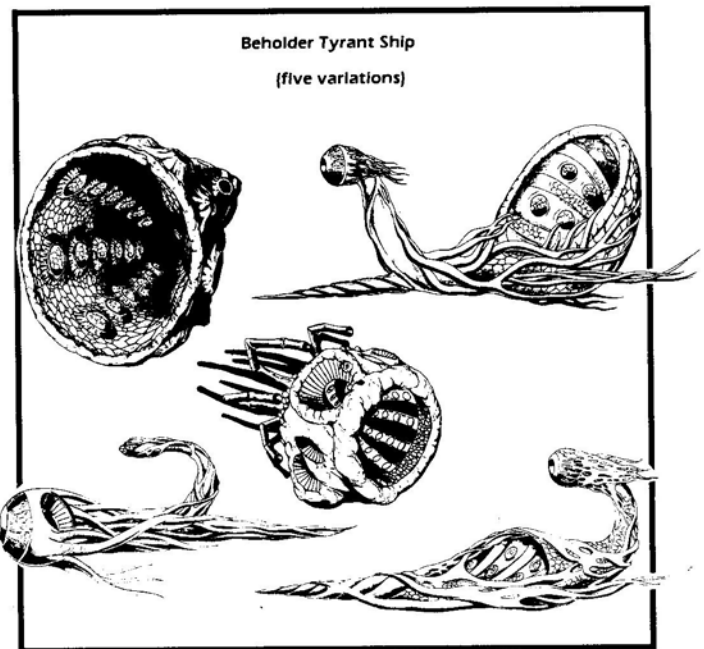

Spelljamming Speed

Since small objects don't make ships drop into tactical speed, what happens when a ship collides with such an object at spelljamming speeds?

In fact, no contact occurs at all. When a ship is moving at spelljamming speed, the small mass becomes a free-floating object as soon as it enters the air envelope. As a free-floating object, it first stabilizes with respect to the ship's gravity plane, and then drifts outward toward the edge of the envelope, from which it eventually leaves the envelope altogether.

3: SPACEFLEETS OF THE VOID

Elven Fleets

Attempting to fully cover the elven navies is an impossible task. First, their fleets were decimated during the second Unhuman War (even though they won), and even the elves do not know how many ships survived. Second, elven forces are so numerous and widespread that a journal the size of the *Spelljammer* itself would be needed to document every known elven ship and fleet. This entry, therefore, details only the average fleet.

(One historian points out that the first Unhuman War caused a widespread dispersion of the unhumans as they fled in every conceivable direction to escape destruction. This historian believes the elves will experience the same fate in the long run.)

The Elven Chain of Command

The current elven chain of command is so strictly structured that it has been called a straightjacket even by those high in its command. At the top of the organizational chain is the Admiral of the Evermeet fleet herself. She controls every facet of the space fleet, including the administration of the Evermeet blockade. Under her, a council of 11 senior elves advise her on happenings in space. This council is simply called the Cabinet.

The Bench (the judiciary branch) and Accounting Services are next in the command chain. Accounting Services, with no real power, consists of accountants and draft-registrars. This group is responsible for paying the navy's wages, administering benefits for the disabled and the widowed, and drafting new crews during times of war.

The list below summarizes the complete chain of command. Note that the years given under entries like Navigator/Helmsman are not character levels. Instead, they are the number of years of fleet experience the character has in that field. In other words, a Cleric/Medic/Priest achieves the rank of 1st-Class after 61 years with the navy. These numbers should be considered averages, and individual exceptions most certainly exist.

Admiral of Evermeet Fleet

The Cabinet

The Bench

Accounting Services

Admiral

Captain

First Mate

Navigator/Helmsman 1st Class 40th+ year

Cleric/Medic/Priest 1st Class 61st+ year

Quartermaster 40th+ year

Battlepoet 1st Class 40th+ year

Cleric/Medic/Priest 2nd Class 31st-60th year

Navigator/Helmsman 2nd Class 13th-39th year

Battlepoet 2nd Class 13th-39th year

Weapons Sergeant 20th+ year

Rigging Sergeant 20th+ year

Battlepoet 3rd Class 1st-12th year

Cleric/Medic/Priest 3rd Class 13th-30th year

Navigator/Helmsman 3rd Class 1st-12th year

Cleric/Medic/Priest 4th Class 1st-12th year

Weapons Aimer (crew chief)

Crewman

Personalities

Icarus (Fighter 12)

Captain of elven flagship *The Arrow of Justice*

AL: LG

HP: 101

THAC0: 9

AC: 10

#AT:3/2

DMG: 1d10+2

STR: 17

INT: 14

DEX: 13

CHA: 18

WIS: 17

CON: 15

Icarus is one of the most colorful captains in the Elven fleets. Working strictly in the RealmSpace crystal sphere, he is the veteran of nearly fifteen battles. His current assignment, the *Arrow of Justice*, is an Elven Armada.

He has been attempting to get the Admiralty to reinstate the Karpri space station. This marvel of elven ingenuity consists of seven archaic Elven Monarch Class Man-O-War ships welded together by the growth of their crystalline wings. The ships share the same gravity plane, and all their weapons point out

"When you hit a scro ship, get in, use magic, and get out. Don't try to board them. They have a nasty habit of carrying more armored marines than anything that's friendly to you . . ."

Captain Icarus, Elven Fleet

3: SPACEFLEETS OF THE VOID

toward open wildspace. This 700 ton satellite was an elven military base generations ago, but when the base was razed by an illithid squadron, it was abandoned. The air has long turned deadly, smelling of dank death, even to this day.

Icarus is the captain of one ship, but he also is a Fleet Admiral. He personally controls a force of:

- 7 Elven Armadas (with 85 elves each)
- 1 Monarch-Class Armada (with 75 elves)
- 50 flitters (with one elf each)
- Stored on the Armadas
- 12 Man-O-Wars (with 45 elves each)
- 1 Radiant Ship (with 10 crew members)
- 5 Eel supply ships (with 20 crew members each)
- 1,370 Elven crew (total)

Yerthad (Fighter/Mage 7/7)

Captain of elven flagship *Liira's Kiss*

AL: LG	HP: 37	THACO: 14
AC: 8	#AT: 3/2	DMG: 1d10
STR: 12	INT: 13	DEX: 15
CHA: 12	WIS: 11	CON: 14

Yerthad is the captain of the Elven ship *Liira's Kiss*, a Man-O-War, and the admiral of the outer Krynn-space fleet. Spending a great deal of time near Zivilyn (the last Krynnish planet), Yerthad prefers to stay away from the sphere's home world in light of the fairly recent cataclysm.

The Yerthad fleet is designed to protect the trading posts on Zivilyn's moons, as well as making sure the goblinkin and the neogi do not infiltrate the system. Yerthad realizes that his current assignment is a pipe dream, because it is impossible to cover the whole sphere at once with his small fleet. Yerthad's fleet consists of the following ships:

- 5 Elven Armadas (with 100 elves each)
- 3 Barges of Ptah (25 crew members each)
- 100 Flitters (1 crew member each)
- Stored on the Barges of Ptah
- 8 Man-O-Wars (with 50 crew members each)
- 3 Radiant Ships (with 20 crew members each)
- 1,135 Elven crew members (total)

Krissos (Fighter/Mage 6/7)

Captain, Elven Flagship *Luminary of Ehlonna*

AL: CG	HP: 35	THACO: 15
AC: 8	#AT: 1	DMG: 1d8
STR: 14	INT: 19	DEX: 15
CHA: 17	WIS: 19	CON: 13

Oerth, the center of the Greyspace crystal sphere, is home to this once great fleet. They patrol everything inside of The Grinder, preferring to keep a wide berth between their ships and this extensive asteroid shell. Captain Krissos, while chasing neogi intruders, has lost too many ships (seven in the last 12 months alone) to this area. (A sage advisor to Krissos believes the neogi are purposely leading the elves into The Grinder to be destroyed.) In keeping with the Oerth mentality that they are at the center of the universe, Krissos and his 800 crew members believe they are the largest force in wildspace. In the central locations of Greyspace, they may be right.

During the second Unhuman War, a fleet of 75 scro Mantis ships attacked them in a battle known as the *Borka Maneuver*. All but 15 Mantis ships spiraled in flame to the surface of the Type A planet Borka before the scro finally turned tail and fled into The Grinder. The scro destroyed over half of the elven ships during the fight. Originally, this fleet consisted of 24 Armadas, 120 Flitters, 18 Man-O-Wars, 8 Shrikeships, 7 Radiant Ships, 12 Eel Ships used for fleet supply, and 4,160 elven crew, but the fleet has been reduced to:

- 10 Elven Armadas (with 75 elves each)
- 12 Flitters (no crew members)
- Stored on the Man-O-War
- 1 Man-O-War (with 12 crew members)
- 4 Shrikeships (with 20 crew members each)
- 3 Confiscated Mantis Ships at half hull points (20 heavily armed elven crew members each, 20 Scro prisoners each)
- 1 Radiant Ship (with 15 crew members each)
- 5 Eel Ships (with 10 crew members each)
- 967 Elven crew members, 60 Scro prisoners

Who's Who in Fantasy Space

Elves: Their roving patrol ships often rescue the unfortunate. However, is their star fading?

Dwarves: They keep to themselves in their great asteroid Citadel ships, powered by mighty forges.

Humans: The most numerous and free-wheeling race in space, with adventurers as their vanguard.

Gnomes: Seemingly harmless, if chaotic, tinkers. Their odd mechanical gadgets work . . . well, mostly.

3: SPACEFLEETS OF THE VOID

Free Neogi, Oerth

The Free Neogi are a strange lot. Traversing exclusively in Greyspace, this large company exists solely to haul cargo from one location to another for a hefty price, or so they want you to believe. The Free Neogi own eight Mindspiders, three Deathspiders, and two Elven Man-O-Wars. Each of these large craft carry seven Wreckboats for emergencies. The Mindspiders and the Man-O-Wars have been modified to carry one additional medium weapon apiece, of the DM's choice. The Deathspiders carry an additional heavy weapon of the DM's choice. Each of the craft also has an insignia carved and painted into the bow and aft to set their craft apart from any other. This insignia looks like a spider with two hands held outward in the universal sign of friendship.

The Free Neogi always split their fleet into two squadrons. Each squadron has one of the elven Man-O-Wars. These elven ships are used to gain the confidence of groundlings, as well as the trust of spacefaring races.

This company refers to itself as the "only neogi Free Traders in existence." Whenever this company makes a stop on Oerth, the neogi allow the docking officials to inspect everything. This helps legitimize their passage. Upon inspection, the holds will be found to contain sealed boxes and crates, and their contents are legal. They commonly haul cargo from Oerth, through the dangerous terrain surrounding The Grinder, and deliver the packages to a moon of the planet called The Spectre.

Most of the neogi in the Free Neogi Company are highly educated spellcasters. They mask their cargo with illusion and phantasmal spells, often transmogrifying their "cargo" to appear as something completely different. By wearing *amulets of nondetection*, the neogi avoid being revealed as liars; nor are their alignments determinable. Standard dock hands and dock inspection teams have no chance to discover the neogi deceit.

The Free Neogi of Greyspace kidnap average persons—those they personally would have no problem defeating without the help of their umber hulk

slaves—and bind and gag them. Taking these prisoners, hidden in crates and boxes, back to their vessels, they cast illusion and alteration spells to make the victims appear as cloth bolts, hay or grains, cattle and other farm animals, etc. Once the dock inspectors finish their audits, the neogi head into space. The illusion and alteration spells are maintained until they reach their destination—The Spectre—outermost planet in Greyspace.

Once the neogi reach this disc-shaped planet, they head straight for the planet's only moon, Olarius. This Class A moonlet has a frigid atmosphere and its land area is a wasteland of permanent frost, creating a very dangerous terrain at best. The neogi dispel their illusions and alteration spells and usually abandon their victims—still tied and helpless—on the moonlet's frozen landscape. Within just a few rounds (1d4), these ill-fated people freeze to death.

The Free Neogi place their cargo here to supply their compatriots, who pass through the Greyspace crystal sphere and need a source of food. Most of those who enter the sphere for the first time are unable to traverse the asteroid belt known as The Grinder without being destroyed, so the Free Neogi have placed an easily reached food supply relatively near the crystal shell itself for their brethren to find.

In return, these traveling neogi pay a handsome fee to the Free Neogi, who orbit Olarius, guarding their investments. Occasionally, even an illithid ship passes through, looking for a morsel. The Free Neogi, though wary of these octopoid humanoids, sell some of their "fresher" (unfrozen) samples to them for an even higher price.

Generally, the Free Neogi sell their frozen rations for 2 sp per pound. When an unfrozen provision is requested, the Free Neogi sell the still-conscious victim for 1 gp per pound. (The "fresh" rations are far more rare, since they require constant food, water, and air supplies to keep them alive. Therefore, only one or two are available at any one time.)

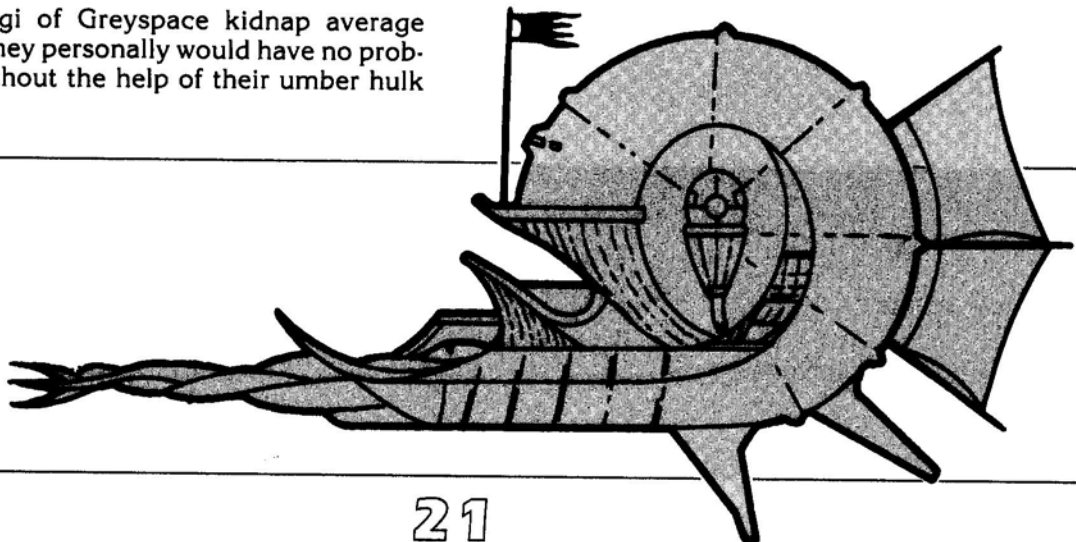

3: SPACEFLEETS OF THE VOID

The Chain of Command

The Free Neogi is constantly in a state of turmoil. First one neogi vies for control, and then another. Whenever they are not bickering, they get a lot of work done, and they make a lot of money. The fleet is controlled only by one neogi. Currently, this position is filled by Griktha, a former trader from Krynn-space. He is known as the Fleet Commander. Griktha has been in control of the Free Neogi Company for approximately six months.

Under the Fleet Commander, the Squadron Warrants (there are two of them) command the two separate squadrons when the fleet is separated. One Squadron Warrant controls the ships that protect their investments on the moonlet, Olarius. The second Squadron Warrant (who must answer to the fleet commander, who travels with this squadron) controls the ships that consistently travel back and forth between Oerth and Olarius.

After the Squadron Warrants, there are few official titles. The chain of command below lists titles for all ranks, and their relative importance. (The ranking below is identical to other neogi companies.)

- Fleet Commander
- Squadron Warrant
- Ship Captain
- Mage 1st Class 3rd + level
- Priest 1st Class 4th + level
- Fleet Commander's umber hulk slaves
- Mage 2nd Class 1st-2nd level
- Priest 2nd Class 1st-3rd level
- Squadron Warrant's umber hulk slaves
- Captain's umber hulk slaves
- Prisoner currently manning the *lifejammer* helm (No real power)
- All nonspellcasting neogi (Ranked by their hit dice totals)
- Umbur hulks
- All neogi-born slaves/prisoners
- The next neogi meal
- All other prisoners
- All other slaves

Personalities

The Free Neogi have several captains and helmsmen that have attained distinction. These individuals are listed below.

Griktha (Enchanter 6)

Neogi merchant

AL: NE HP: 40 THACO: 12 (staff), 15 (bite)
AC: 0 #AT: 2 DMG: 1d6 + 3 (staff), 1d6 (bite)
STR: 12 INT: 19 DEX: 15
CHA: 16 WIS: 14 CON: 10

Griktha first came to light when the Vodonoï first threatened the known spheres (see SPELLJAMMER™ adventure SJA4, *Under the Dark Fist*). Griktha is one of those beings who comes off as so slick, no one knows he's lying through his teeth whenever he says anything, but no one can figure out just which part of his speech is false and which is truth. (His *amulet of nondetection* also aids in this inability to determine when he is lying.) He is a consummate manipulator, specializing in forked-tongue diplomacy. He cannot be trusted, nor can one avoid hearing him out.

Though not a transmuter like the rest of his companions, he has used his enchantment abilities to gain succession over the last Free Neogi leader, and plans to continue to use his spellcasting abilities to maintain his seat.

He carries the following magical items: *wand of paralyzation* (45), *staff +3*, *wand of fire* (60), *bracers of defense AC 6*, *cloak of protection +3*, *ring of protection +2*, *potion of gaseous form*, and a *brooch of shielding* (45).

He is protected at all times by Spinesnapper, an umber hulk slave with maximum abilities and hit points: AC 2; MV 6; HD 8 + 8; hp 72; THACO 11; #AT 3; Dmg 3d4/3d4/1d10; SA eye contact causes *confusion* as per the spell at a range of 90'; SD *infravision*; SZ L (8' tall, 5' wide); ML Fearless (20); XP 4,000.

Who's Who in Fantasy Space

Goblinkind: Decisively broken by the elves in the Unhuman Wars, they may be coming back. Principle races include: hobgoblins, kobolds, orcs, ogres, and scro.

Neogi: Evil spider-like slavers, they are served by umber hulks. They created life-draining helms. Nobody likes them much, and the feeling is returned, with interest.

3: SPACEFLEETS OF THE VOID

Oolph Clawstem Neogi archmage

AL: NE HP: 26 THACO: 14 (staff), 15 (bite)
AC: 0 #AT: 2 DMG: 1d6 + 3 (staff), 1d6 (bite)
STR: 10 INT: 18 DEX: 13
CHA: 11 WIS: 13 CON: 12

Oolph is a widely known and respected (*i.e.*, feared) neogi in wildspace. Working with the Free Neogi for over five years, he was commissioned the Squadron Warrant over the ships that make the run from The Spectre's moonlet to Oerth. His value truly manifested itself when he created what the neogi now refer to as the *Oolph Maneuver*.

This maneuver consisted of jettisoning less than 10 tons of material in the path of a pursuer. As the Free Neogi fled (at spelljamming speed), their pursuers followed (also at spelljamming speed). The material Oolph jettisoned collided with a pursuing Shou Lung Dragonship. The extra damage this caused was just enough to destroy the enemy craft.

As a transmuter/illusionist mage, Oolph has the following spells available to him: (1st level) *enlarge* (×2), *featherfall* (×2); (2nd level) *invisibility*, *levitate* (×2), *misdirection*; (3rd level) *delude*, *invisibility 10' radius* (×3); (4th level) *hallucinatory terrain*, *illusionary wall*, *improved invisibility*, *polymorph other*; (5th level) *advanced illusion*, *Leomund's secret chest*, *major creation*, *teleport*; (6th level) *permanent illusion*.

Oolph also has an *amulet of advanced arachnid control*. He uses the amulet to force the neogi under his command to obey him. (With this magical item, a neogi must make a successful save vs. spell at a -2 penalty or be magically compelled to obey his command to the letter. If the save is successful, the neogi character can choose whether to obey or not.)

He is also protected by an umber hulk slave: AC 2; MV 6; HD 8 + 8; hp 55; THACO 11; #AT 3; Dmg 3d4/3d4/1d10; SA *confusion* at a range of 90'; SD *infravision*; SZ L (8' tall, 5' wide); ML Fearless (20); XP 4,000.

Fleet Statistics:

The statistics below are for encounters with the Free Neogi in Greyspace. The DM should remember these Deathspiders are modified with an additional heavy weapon, and the Man-O-Wars and Mindspiders each carry an extra medium weapon.

Squadron I: (This squadron is 25% at The Spectre, 50% in transit, 25% at Oerth.)

Deathspider (2): Ton 100; HP 100; Crew 30/100; MC E; AR 5; Save Crystal; Power Major helm; SR 4; Arm 1 Heavy catapult; 1 Heavy jettison; 4 Heavy ballistae; SZ 175' × 50'.

Mindspider (4): Ton 40; HP 40; Crew 3/40; MC C; AR 4; Save Metal; Power lifejammer; SR 3; Arm 2 Medium catapults; 1 Medium jettison; SZ 40' × 15'.

Elven Man-O-War (1): Ton 60; HP 60; Crew 10/60; MC C; AR 7; Save Ceramic; Power major helm; SR 6; Arm 1 Medium catapult; 1 Medium jettison; 2 Medium ballistae; SZ 200' × 20'.

Wreckboat (48): Ton 4; HP 4; Crew 1/4; MC A; AR 6; Save Thick Wood; Power Minor helm; SR 2; Arm 1 Medium ballista; SZ 30' × 15'.

Squadron II: (Always located at The Spectre)

Deathspider (1): Ton 100; HP 100; Crew 30/100; MC E; AR 5; Save Crystal; Power Major helm; SR 4; Arm 1 Heavy catapult; 1 Heavy jettison; 4 Heavy ballistae; SZ 175' × 50'.

Mindspider (4): Ton 40; HP 40; Crew 3/40; MC C; AR 4; Save Metal; Power lifejammer; SR 3; Arm 2 Medium catapults; 1 Medium jettison; SZ 40' × 15'.

Elven Man-O-War (1): Ton 60; HP 60; Crew 10/60; MC C; AR 7; Save Ceramic; Power major helm; SR 6; Arm 1 Medium catapult; 1 Medium jettison; 2 Medium ballistae; SZ 200' × 20'.

Wreckboat (42): Ton 4; HP 4; Crew 1/4; MC A; AR 6; Save Thick Wood; Power Minor helm; SR 2; Arm 1 Medium ballista; SZ 30' × 15'.

"The neogi may be one of the most feared race in wildspace, but I found a way to beat 'em by using their base against 'em. My favorite tactic is to dive the ship toward their asteroid base with weapons firing.

Not surprisingly, the stupid neogi follow me, like a ballista is going to destroy a moonlet!

"As they approach, I get closer to the asteroid, and pull up at the last moment before I splatter my ship and crew against the side of a cliff. Since the neogi ships are not as maneuverable as mine, they always hit the cliff with a glorious thud. Get's them every time!"

Kyrial Alathar Pellinore, son of Chiros Pellinore,
Third Lord of Everlund, and proud servant of Tyr

3: SPACEFLEETS OF THE VOID

Kindori-Riders, Kryn

The kindori, also known as space whales, are among the largest creatures in known space. They resemble aquatic whales in shape and general physiology. They are mammals, they lack any noticeable mouth, and their small eyes line the leading edge of their fishlike bodies.

Kindori: (2-8/3-30) INT low (6); AL LN; AC 5; HD 18; hp 18-144; THACO 3; #AT 1; Dmg 3-30 (1-3 Hull Points); SA *blinding*; SD nil; MR 5%; SZ G (80' long); ML Elite (13); XP 11,000 each.

Near the planet Chislev in Krynnspace, a pod of eight kindori live, soaking in the rays of the sun, and are home to a human tribe of kindori-riders. These people's whole lives revolve around the care and welfare of the massive domesticated beasts. The tribe cleans the scavver barnacles from the kindoris' tender underbellies, wards the beasts from possible dangers, and makes sure the overgrowth of vegetation does not interfere with the creatures' ability to see.

The kindori-riders are able to control the actions of the pod, except in times of herding. The kindori herding instinct that occurs once a year causes the kindori male population to grow increasingly violent as they establish breeding rights. During this one-month period, the kindori-riders can do nothing but hold on.

The violent tail-slapping and furious ramming can rip whole villages off the kindori male's back. This explains the rareness of villages on the males' backs, except on the venerable males. The female kindori, which are also the largest of the beasts, are a far better and more stable choice.

Kindori-Riders: (1d10 + 10 per kindori) INT average (10-12); AL N; AC 8; HD 6; THACO 15; #AT 1; Dmg 1D8 (sword); SA nil; SD nil; MR nil; SZ M (6' tall); ML Elite (13); XP 270 each.

The kindori-riders have a very strange way of life. Everyone in the tribe has a voting privilege, whether

man, woman, or young adult. Some people, however, get more voting privileges than others. The chief, for example, gets 25 votes, his wife gets 10, his children get 5 each. Other tribal leaders get 10 votes apiece, and all Brave Warrior Leaders get 12. Everyone else gets 1 each. Everyone must vote or lose his voting abilities for the rest of his life. Disease and injury are not an excuse to miss a vote, unless the voter is unconscious, in a coma, or has a special exemption agreed on by the tribe.

Trading Information

Direct trade with the kindori-riders is generally too dangerous. The riders tend to believe that any intrusion into their space is an act of aggression. The table describes the reactions of the kindori-riders toward intruders. The DM should add the total number of ships the characters arrive with to the d20 reaction roll. (Assume the kindori-rider tribe is immediately hostile if the ships they encounter are kindori whaling ships.)

Die Roll	Reaction
02-05	Flight
06-08	Friendly
09-11	Indifference
12-14	Cautious
15-17	Threatening
18+	Hostile

If the characters are able to get favorable reactions from the tribesmen, they can conduct fortuitous trading with them. The *gold piece* as a bartering tool is ineffective, although the lists below give a gold-piece equivalent of their apparent worth to the tribesmen. This is to assist the DM in instilling a base "worth" to all items. The tribesmen have no need for the metal, as it can't be eaten, worn, or fed to cattle. The tribesmen are in need of the following materials, however, and will trade their goods for them:

Cloth: The tribe cannot create cloth, so it is a very important import item. In trade goods, they will trade 10 gp equivalent for each bolt of cloth.

Who's Who in Fantasy Space

Beholders: Floating spheres festooned with eye-stalks that shoot magical rays, the "eye tyrants" war mainly on each other. Lucky us.

Illithids (Mind Flayers): These reclusive, octopus-headed traders have strange mental powers. They seek minds to dominate or devour. They keep slaves, but better them than the neogi.

3: SPACEFLEETS OF THE VOID

Meat: The meat they desire is usually in the form of cattle, like domesticated beef, lamb, and pork. They pay 2 sp per pound for these animals. They do not trade for kindori, scavver, neogi, umber hulk, or krajen flesh. They will always view the selling of humanoid, dracon, giff, beholder, or dragon flesh as an abomination, and will immediately halt trade negotiation with the offenders.

Plant Seed: Plants that can grow in a relatively humid location with a high degree of light are highly prized by the tribesmen. Unless they have a great abundance of seed, they will buy almost any type.

Metallic Weapons: Spears, swords, daggers, halberds, or anything else they recognize are prized items for them. They will buy them at the equivalent price stated in the *Player's Handbook* in trade goods.

Brave Warrior Leaders: Warrior leaders are always in high demand, since adventurers are always trying to steal the few trade goods they possess. Any officer, or a warrior higher than 7th level, is considered a potential warrior leader. The tribesmen offer the crew member's captain the equivalent of 100 gp of material, and promises the warrior leader a job for at least seven years, a wife (or husband) of his choice, first eating rights, and 12 voting privileges.

In return, the tribesman have several goods they, too, can trade:

Meat: The kindori-riders sell scavver, neogi, umber hulk, and krajen meat. They only sell kindori flesh when an animal dies. The beasts are far too valuable to them to slay for mere possessions. They sell their meat for the equivalent of 2 sp per pound. Kindori meat, however, costs 3 sp per pound.

Greek Fire: The flesh of the kindori can be rendered into oil, much like that of terrestrial whales. This kindori flesh is the source of most of the greek fire in known space. (This explains why the tribesmen have such a hatred for whalers, and the lizard men who mostly occupy such ships.) They will sell greek fire, if they have it available, for 100 gp of trade goods per shot. The kindori-riders will rarely exploit their mounts for this substance, as the process is fatal to the beast.

Plant Foods: The tribesmen sell vegetables and fruits over any other plant byproduct. The fruits help protect the voyagers from deadly diseases like scurvy, and the vegetables give the other elements and vitamins necessary to sustain a healthy life. The other products they sell are grains like wheat, corn, and barley. These sell for the price stated in the *Player's Handbook*.

Healing/Medicinal Plants: Several plants that grow on the kindori are unique, and found nowhere else in the known spheres. Their byproducts are rare and may not always be available.

- The *mill plant*, whose leaves can be ground into a fine greenish paste, helps the body heal from poisonous bites (giving the user another saving throw vs. poison with a +2 bonus). This paste is sold for 100 gp per dose.

- The *accede plant* can be split across its stem, thus allowing a clear, watery fluid to drip out. When this fluid is imbibed or placed on the eyes, it heals any magical and most nonmagical *blindness* with a successful saving throw vs. spell. This byproduct is sold for 200 gp per dose.

- *Raze* is a rare plant whose thorns are often used instead of bone, stone, or metal arrow tips. The thorn gives the weapon a -1 attack penalty, but it causes an additional +2 points of damage due to its unusual sharpness. It also causes the struck target to save vs. poison, or fall catatonic with occasional fits of violent seizures for 1d4 turns. Each arrow can be used once only. Thorns are sold for 50 gp each; finished arrows for 100.

- *Renewed* is a special potion made from the blood of the kindori mixed with the pollen of the renewed. This potent mixture can increase the imbiber's Strength and Constitution by one point each for 1d20 rounds. If more than one dose is taken, it does not increase the effects of the renewed. Instead, the character must roll a save vs. poison or fall into a hysteria involving a lot of knee-hugging, screaming, and wide-eyed blinking. This condition lasts for 1d4 hours, and causes a loss of one Wisdom point permanently. No more than one dose can be taken in a 24-hour period without the hysteria effects above taking

"How many times did I tell him that the kindori savages eat traders? Turns out they don't . . . their scavvers do, though. And the little scavvers sucked off our air, too."

Sliith Darkscale, Retired Lizardman Merchant

3: SPACEFLEETS OF THE VOID

the character over. This product is sold for 150 gp per dose.

Personalities

The humans number from 10 to 20 per kindori. They all use bone spears (1d6 hit points) and ivory breast plates (AC 6). They speak a crude form of the common tongue, that requires all who speak with them to have an Intelligence of 16 or better to understand their dialect. (A *tongues* spell provides the spell's user a complete understanding of the language and its idioms.)

Stefano (Fighter 11)
Kindori-Riders' Chieftain

AL: LN	HP: 87	THACO: 10
AC: 9	#AT: 3/2	DMG: 1d8+6
STR: 18	INT: 15	DEX: 17
CHA: 16	WIS: 14	CON: 15

Stefano is a very charismatic leader. Some of his tribe look upon him as destined toward godhood, but he passes this off as the ultimate in love and adoration. Everything he does is for his people. He loves them so much, he would risk and give his life if it would save them.

He is the one whom the characters must deal with when conducting trade with the kindori-riders. He is not the wisest man when dealing with trade agreements and the like, but he is a respected man in his society, nonetheless. Whenever he makes a trade, the DM should roll against his Wisdom. If this roll fails, the characters can weasel a 10% discount out of him for that particular item.

The 60-year-old man has lost a great many teeth in past wars with lizard-man whaling ships, and the rest are browned with rot. Unfortunately, he smiles often, revealing this oral failing. This gives everyone he meets the impression that his Intelligence and Wisdom are actually much lower than they actually are. If insulted (such as being treated as an imbecile) he generally does his best to make sure he steals them

blind (at this time, Stefano's Wisdom rolls have a -4 bonus.)

Elke
Stefano's Wife

AL: N	HP: 8	THACO: 20
AC: 10	#AT: 1	DMG: 1d4
STR: 12	INT: 12	DEX: 14
CHA: 3	WIS: 18	CON: 18

Elke, probably the wisest in the tribe, is also the homeliest. When asked about his wife, Stefano agrees she is nothing to look at, but her mind is the most beautiful star in the heavens. She always serves as Stefano's advisor when trading with newcomers.

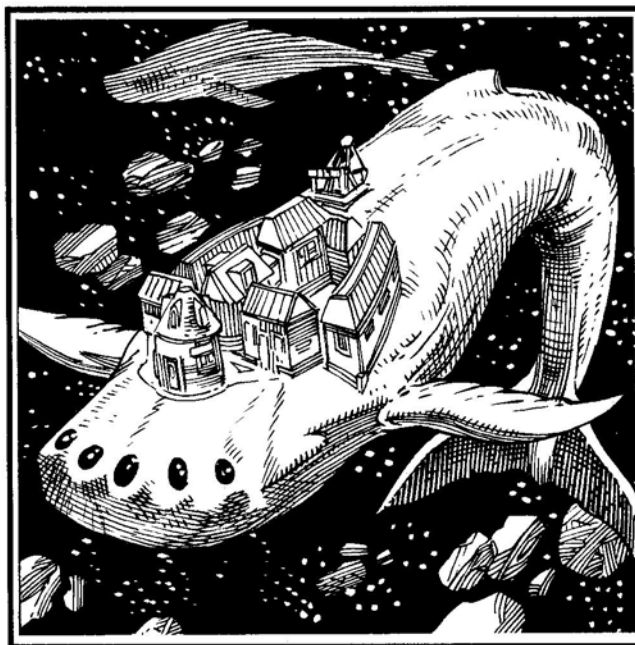

Who's Who in Fantasy Space

Arcane: Lanky blue giants with six fingers, these merchants supply ships and helms to all races.

Giff: Tough hippopotamus mercenaries, liking flash and noise—the bigger, the better. They are military, reliable, and built like walls.

Lizard Men: Obsessed with breeding intelligence, lizard men are crude, suspicious, and short-tempered. Not our favorite people.

3: SPACEFLEETS OF THE VOID

Scavver-Breeders, Oerth

No matter how beautiful something is or how precious, someone has to spoil it for everyone. On Oerth, the Scavver-Breeders in The Grinder are the spoilers. These malicious, piratical individuals prey on everything that comes in their sights. More accurately, their pets do the preying.

The Scavver-Breeders have taken over a large portion of The Grinder, and have turned it into their personal breeding farm. By inbreeding, overbreeding, and selective breeding, they have created a scavver that has some semblance of intelligence. These one-eyed beasts can obey a simple command, and the command is not forgotten for the creature's entire life, though their desire to obey it may change from minute to minute.

The Scavver-Breeders teach their livestock to attack any ship that is not painted bright red. This edict is so strongly imprinted in the scavver, that the crew on the red-painted ships must also wear red, otherwise they are personally attacked.

This training has proven very successful for the Scavver-Breeders. Whenever their creatures come home to the ranch, the breeders take the scavvers and, using a *dimension door* item, extract any valuables from the creature's gullet. Using a *ring of telepathy* on the scavvers, they are also able to determine where wreckage can be found. Their job becomes very simple at that point: loot the remains, and take on survivors if any exist. The Scavver-Breeders sell the loot they receive at reputable trading posts throughout The Grinder and other locations. The prisoners they rescue from certain death in wildspace eventually wish they had died. They are held against their will, bound and gagged until the breeders need to feed one of their scavvers.

Brown Scavver (2-20): INT Semi- (4); Treasure from J to U, 1% chance of magical item; AL N; AC 5; MV 12; HD 4; THAC0 17; #AT 1; Dmg 1d4; SA Swallow on a 19+; SD poison gas; SZ L (10' long); ML Unsteady (7); XP 420 each.

Night Scavver (1-10): INT Semi- (4); Treasure from J to U, 1% chance of magical item; AL N; AC 3; MV 18; HD 6; THAC0 15; #AT 1; Dmg 1-10; SA Swallow on a 19+; SD nil; SZ H (15(FM) long); ML Average (9); XP 975 each.

The Chain of Command

The Scavver-Breeders do not have a chain of command, per se. Instead, they are set up much like a guild. The Breeders have their leaders, a group of seven who sit on the High Council and cannot agree on anything. Everyone else is below the council. If any of these "lower" individuals are given more power, it is because the High Council, or at least a majority of them, wishes it for a time.

This creates an incredibly high turnover rate in the important positions. Positions like Supervising Breeder, Administrating Feeder, Aptitude Adjustor, and Fleet Commandant, see a new person in the position almost weekly. (Whoever is the favorite in the eyes of the High Council gets the position. Nothing more is considered.)

The *Supervising Breeder* controls every aspect of scavver breeding. Which creature breeds with which is the main duty of the Supervising Breeder. He also must keep a complete log of all breeding activities, is responsible for proper tagging and numbering of the beasts, and oversees the retirement of old stock.

The *Administrating Feeder* is responsible for all prisoners (human, demihuman, nonhuman, and animal alike) the Scavver-Breeders take, for these are the main diet of the scavvers.

The *Aptitude Adjustor* is in charge of experiments to adjust the intelligence of the scavvers. The program has been able to raise scavver's intelligence by three points already. (Some believe that *wishes* were involved in the process, but the Scavver-Breeders, of course, aren't saying.)

The *Fleet Commandant* leads the few spelljamming ships the Scavver-Breeders own into battle whenever the need arises. See Fleet Statistics below for more information on the ships of the fleet.

Scavvers

This long, fishlike creature lives in wildspace. The leading edge of its head is dominated by a single huge, human-like eye and a wide, sweeping mouth. Scavvers are of various types: gray, brown, night, and void. The black void scavver is the largest and most dangerous.

3: SPACEFLEETS OF THE VOID

Personalities

Alec (Fighter 4)

Supervising Breeder

AL: NE HP: 29 THACO: 17
AC: 4 #AT: 1 DMG: 1d6 (spear)
STR: 13 INT: 16 DEX: 14
CHA: 10 WIS: 13 CON: 12

Alec, a human, recently was appointed this position. Not knowing a thing about breeding, he has been breeding the scavvers at random, with apparent success. Everyone under his supervision has commented on his brilliance and his ingenious approach to breeding. Alec, as invisible to the outside world as the High Council itself, is never seen outside his laboratory.

Danij Viper

Administrating Feeder

AL: NE HP: 30 THACO: 18
AC: 8 #AT: 1 DMG: 1d4 (dagger)
STR: 14 INT: 17 DEX: 14
CHA: 10 WIS: 25 CON: 15

Danij, a lizard man, feels no apprehension when he must feed a human, dwarf, elf, gnome, mind flayer, or whatever, into the mouth of a "well-deserving" scavver. This is his job, and he likes what he does. (Frankly, he has the choice of either doing his duty, or perishing like the prisoners.)

Danij inherited the Administrating Feeder position from a dwarven outcast who accidentally fell into the mouth of a hungry scavver. Everyone denies the fact that the dwarf was not a well-liked individual, and few claim that he was very careful about where he stepped. Still, no one can imagine how the *wall of ice* ended up on the scaffold above the scavver pit the dwarf fell into. Since everything said and done is nothing more than speculation, Danij has been very careful not to make any of the workers angry.

Volt (Fighter 12)

Fleet Commandant

AL: LE HP: 85 THACO: 9
AC: 0 #AT: 3/2 DMG: 1d8+2
STR: 17 INT: 12 DEX: 16
CHA: 14 WIS: 16 CON: 17

Volt, a human born on Oerth, recently resigned from a pirates' fraternity to take a job as the Fleet Commandant. Still possessing the piratical "Let's go out and slay some swine" attitude, he is constantly curbed by the High Council who wish to maintain a lower profile. They only want the fleet to go out and unearth the spoils of the ships the scavvers have destroyed. In this way, the fleet remains intact and healthy.

Fleet Statistics:

The ships below are the only ones that the Scavver-Breeders own (most of their pillaging is performed by their scavver creations; see their statistics listed above). The ships only return to the scene of the crime to get the larger items of worth. If they are met with opposition, the crew and captain are considered to have a morale of Unsteady (7), even if they have the superior odds. The Scavver-Breeders must roll a morale check every time they take losses in battle.

Angelship (8): Ton 33; HP 33; Crew 8/33; MC C; AR 6; Save Thick Wood; Power Minor Helm; SR As for helmsman; Arms 2 Medium ballistae, 1 Medium catapult, 1 Blunt ram; SZ 135' x 130'.

Barge of Ptah (2): Ton 60; HP 60; Crew 24/60; MC F; AR 8; Save Thin Wood; Power Major Helm; SR As for helmsman; Arms 6 Medium ballistae, 4 Medium catapults, 2 Medium jettisons; SZ 145' x 60'.

Bolaship (1): Ton 25; HP 25; Crew 10/25; MC D; AR 5; Save Thick wood; Power Bolawhip; SR special (Maximum 6); Arms 1 Bolawhip, 2 Light ballistae; SZ 15' x 12'.

Air on Ships

Foul Air: As the crew uses the air, it turns stale or foul. For an individual stranded alone in the void, this happens after 2-20 turns. For a ship or large creature of 1 ton or more, foul air lasts from the start of the 5th month through the 8th month. Combat in foul air is at a -2 attack penalty.

3: SPACEFLEETS OF THE VOID

Wa, Toril

Wa is an island country located off the east coast of Toril's largest continent. Known for its large vessels, Wa, unfortunately, has very few craft. The emperor believes that a few ships with great power and strength are far better than less-expensive ships that can fall apart easier.

This "larger is better" mentality has brought about some of the largest vessels created by the humans in wildspace. The *Tsunami*, otherwise known as "the tide that crusheth the enemy", is the Wa mothership. Two hundred tons of finely-carved wood is laminated to an understructure of tempered iron and steel, creating a nightmarish craft. Shaped like a long space-going centipede, the *Tsunami* quietly threads its course through Realspace, keeping in check the Shou Lung and the Elven fleets.

The Wa space fleet continues to function in the role for which it was designed. Wa authorities were very concerned when they learned that their old counterpart, Shou Lung, possessed a fine space fleet. This concern, however, did not compare to their paranoia when they discovered the Elven fleets.

Wa had fought many a battle since its infancy, and they knew the power of higher ground. Knowing that their former enemies had the higher ground should a war ever break out again, the emperor decided to get an even footing. With the help from the arcane, Wa developers created a ship that would move with the strength of the eel and the dexterity of the leopard. Nearly one decade of trial and error finally paid off when the 140-person developmental team left the sanctuary of their retreat with the plans for both the *Tsunami* and the *Locust*. (Later that same month, handbills with the Emperor's stamp sadly announced the unfortunate deaths of all 140 persons on the developmental team. Their demise was attributed to a freak greek fire explosion at the docks of Akkaido.)

At last count, Wa had the following ships in its space fleet, either on the ground, in the air, or in space: 8 *Tsunami* and 160 *Locusts*. Wa policy demands that at least half of the fleet (meaning half of

every type of ship Wa owns) are in the air at one time. Whether that means the ship is in space or in the atmosphere, is strictly a matter of interpretation. The rest of the ships are hidden in cavernous hangars scattered across the Tsukishima and Shinkoku islands.

When Wa has its hand extended into space, they only patrol two locations in space at any one time. By splitting their space fleet into two parts, they are able to patrol twice the area, and they do not over-extend themselves too badly. At any one time, a Wa fleet consists of one or two *Tsunami* and 20 to 40 *locusts* (20 per *Tsunami*). Never leaving the vicinity of their planet, Toril, the Wa space fleet is always on the alert for attacks on their homeland, attacks on their water-sailing craft, and confrontations with piratical spacefarers.

The fleets take two-for-month terms in space, and are sent back to Wa for an equal number of months for grounding duties and ship maintenance. These short terms of duty are designed to minimize sailor fatigue and to maintain a sense of cohesion between the sailors and their families.

Wa has two known ports that are open to space-faring ships. Akkaido is located on the southern coast of the Tsukishima Island in the Sea of Patience. Though not a major port by Wa standards, it is the port most heavily used by the Wa space fleet. By using a fairly obscure port, the emperor feels he can easily keep his spacefaring ships a secret (but since he demands such extravagant ships like the *Tsunami*, he cannot keep it secret for long).

Iiso is located on the southeastern coast of Tsukishima Island. A major Wa port, Iiso is connected to most of the other major cities on the island. All spacefarers use this port when trading with Wa. However, the emperor's paranoia demands that every non-Wa citizen who docks at Iiso must not leave their ship. All trespassers are warned once, maybe twice, then slain.

Deadly Air: This air is depleted of oxygen. For an individual, this happens at the beginning of the 31st turn. For a ship, this happens at the beginning of the 9th month. Creatures who need to breathe must roll a saving throw vs. poison at the start of each round or pass out (revivable with fresh air). A second failure means death.

3: SPACEFLEETS OF THE VOID

The Chain of Command

The Wa chain of command is a very structured entity. Everyone has their definite positioning in the structure. At the top of the organization is the Emperor himself. He controls every facet of the space fleet. Under him, a group of seven persons advise him and counsel him on fleet (and space) occurrences. This Council is considered the second tier of the navy structure.

The Tribunal (the judiciary branch of the navy), the Admiralty of the Navy, and Registrar Services, are the third tier of command. The Registrar, with no real power, consists of accountants. This group of nearly 100 persons is responsible for paying the navy's wages and disbursing benefits to the disabled and the widowed.

Under the Admiralty of the Navy are the captains and the rest of the navy. The list below shows the chain of command.

Captain	
First Mate	
Cleric/Medic/Priest 1st Class	19th+ year
Navigator/Helmsman 1st Class	10th+ year
Cleric/Medic/Priest 2nd Class	13th-18th year
Navigator/Helmsman 2nd Class	5th-9th year
Cleric/Medic/Priest 3rd Class	8th-12th year
Weapons Sergeant	8th+ year
Rigging Sergeant	8th+ year
Weapons Aimer 1st Class	4th-7th+ year
Cleric/Medic/Priest 4th Class	4th-7th year
Weapons Loader 1st Class	4th+ year
Rigging Attendant 1st Class	4th-7th+ year
Cleric/Medic/Priest 5th Class	1st-3rd year
Navigator/Helmsman 3rd Class	1st-4th year
Weapons Aimer 2nd Class	1st-3rd year
Weapons Loader 2nd Class	1st-3rd year
Nutritionist/Quartermaster	
Rigging Attendant 2nd Class	1st-3rd year
Requisitions Attendant 1st Class	2nd+ year
Crewman 1st Class	2nd+ year
Requisitions Attendant 2nd Class	1st year
Crewman 2nd Class	1st year

Personalities

Wa has several captains and helmsmen that have attained distinction in Wa society. These esteemed individuals are listed below.

Daimyo Akahu Nagasa

17th level Bushi

AL: LN HP: 78 THAC0: 4
 AC: 3 #AT:2/1 DMG: 1d8 + 1 (sword)
 STR: 15 INT: 17 DEX: 17
 CHA: 14 WIS: 14 CON: 13
 Honor: 78

The captain of the Tsunami ship *Sakura*, a craft that carries 52 Locusts, Daimyo Nagasa is a veteran of seven battles. His scribes have detailed two attacks from elven Man-O-Wars and one battle with an Armada; the latter disabling his craft's ability to land for three months. The other four major battles were against various other humanoid races. He has captained two separate Tsunami ships in his lucrative four-year career.

A man of few words, Akahu maintains a strict chain of command at all times. No one can go over the head of his immediate superior without suffering 50 lashes for insubordination, except in rare occasions. Every rule of the Wa command is followed to the letter, no matter how difficult it makes life. Akahu believes that only by following the rules can they survive in the lawless voids of space.

Akahu is well-liked by those under his command. Their respect and admiration gives the his fleet cohesion every military force needs to properly function under pressure.

He has been decorated thrice for bravery and twice for battle excellence. In one battle in particular, *The Selune Tear Elmonitae*, Akahu and his Tsunami battled six neogi Mindspiders. The moonlet Elmonitae was a neogi stronghold, and the Admiralty of the Navy feared that the small asteroid was housing captive Wa citizens. Akahu, then captaining the Tsunami *Storm of Honor*, flew to the rescue. After nearly 28

Air Replacement: A ship's air supply is replenished when it enters the atmosphere of a planetary body (although this can be a problem if the atmosphere of the planetary body is itself unusable by the crew). A very small ship (such as a Flitter) will be replenished when it enters the air envelope of a very large ship (such as an Armada). Spells that create fog or similar vapors will freshen the air supply, depending on the ship size and caster level.

3: SPACEFLEETS OF THE VOID

straight hours of battle, the two Mindspiders that remained fled the area, leaving the *Storm of Honor* to salvage the wreckage.

The Tsunami landed on Elmonitae, and found nearly 100 captives; 40 of whom were Wa citizens. The other 60 were of elven descent, and Akahu personally delivered them to the elven Armada *Wings of Glory*. (This act created five years of peace between the elven fleets of RealmSpace and Wa, interrupted only by the "accidental" destruction of an elven Man-O-War, when a Shou Lung spy leaked information that drow were using the Man-O-War for smuggling illegal goods into Wa.)

Salmone Healsmith

17th level Priest of Eldath

AL: N	HP: 46	THACO: 10
AC: 7	#AT: n/a	DMG: n/a
STR: 11	INT: 17	DEX: 14
CHA: 13	WIS: 16	CON: 12

Born in the Daleland's town of Scardale, Salmone quickly became renowned for his abilities as a cleric for hire. His carelessness about the character of his partners, however, soon gained him a bad name. He soon became known as "Salmone-for-anyone's-hire", and after awhile he fell into financial ruin, working only when the evilly-inclined came to him. As this cycle continued, he became a wanted man in as many cities as he had fingers.

To escape the haunting footfalls of mercenaries and bounty hunters who were closing in on him, Salmone braved the Endless Waste to reach a small inlet town named Winterkeep. There, he met a fine daimyo named Akahu Nagasa, who captained the Tsunami battlejammer *Storm of Honor*. He became a Cleric/Medic 2nd Class, a position he holds to this day on the good ship *Sakura*. (The ship was named after a famous scribe who lived in the previous century. The scribe was known for his insatiable curiosity).

Wo Han Do of Chozawa

16th/14th level Samurai/Ninja

AL: LN	HP: 78	THACO: 5
AC: 0	#AT: 2/1	DMG: 1d10 + 10
STR: 18/00	INT: 14	DEX: 17
CHA: 15	WIS: 18	CON: 15
Honor: 99		

Wo Han Do is a legend in his own right. He is well known for pulling stunts that no other captain would dare. Several months ago, he fought a neogi Deathspider. During battle, he had the First Mate and the Navigator 1st Class take over the Tsunami *Hagure Jima*, while he took a Locust ship. Flying through enemy fire, he landed on the neogi vessel. Using his ninja skills, he overcame the ship's navigator and freed the prisoner in the ship's lifejammer helm.

After threatening the life of, and subsequently gaining superiority over, the neogi captain, Wo Han forced all neogi and their umber hulk slaves to surrender. This selfless act virtually saved many a member of his crew. It also brought about the arrest and conviction of seven Wa persons, who were selling secrets to the neogi regarding places to land and locate prisoners. (These arrests also significantly lessened the number of mysterious disappearances reported in the mountains of Wa.)

For his selfless acts as a spacefaring captain, Wo Han was given the *Wakizashi of Honor*. (See the New Magical Items chapter for more information on this magical item.) For his exceptional work in protecting the people of Wa, Wo Han was awarded the *Silver Star of Excellence*. He is one of thirty in Wa's history to receive the award, and he is the only one currently living to possess it.

His ship, the *Hagure Jima* was renamed the *Silver Star* in recognition of this award. The *Silver Star* is now the ship most frequently requested by new recruits and by those requesting transfers. Some believe that Wo Han Do has honor surpassed only by the Emperor himself!

The interaction of ship air envelopes is up to the DM. As a rule of thumb a ship with a "deadly" envelope and a ship of the same size with a fresh air envelope will combine to leave both ships with "fouled" air. Note that some creatures, such as troglodytes, might foul an air envelope for others while remaining unaffected themselves. Magical effects should be treated on a case-by-case basis; for example, although *cloudkill* will blanket a ship in deadly gas, the gas flows downhill (toward the gravity plane), so the envelope of a caster's ship far enough above the gravity plane of the target ship could remain unaffected by the spell.

3: SPACEFLEETS OF THE VOID

Lakara of the Tree 16th level Monk

AL: LN HP: 64 THACO: 13
AC: -4 #AT: 1 DMG: Weapon +8
STR: 17 INT: 12 DEX: 16
CHA: 13 WIS: 17 CON: 14

Lakara of the Tree is a Master of Spring Monk, well noted for his mastery of the Serpentine martial arts. (The serpentine martial arts style consists of: #AT 2/1, Dmg 1-4, AC 7, PA Hand; SM Movement 1, 6; Throw 2; Vital 1, 2, 4; Mental 1, 2, 3. He has 3/1 additional attacks and +3D + 1 damage bonus with his martial arts, and Movement 4 as a class bonus.)

Generally unknown to the public, Lakara is a very well-known figure in the Wa navy. One of the few First Mates to also serve as a Helmsman 1st Class, he is a highly desirable addition to any ship's complement. Currently serving on the *Taibohanto*, it is said that he has turned down a position as captain twice. (If this is true, he is the only one to turn down such an honor even once.)

He claims he is a better asset to the navy performing as a helmsman, as opposed to the captain's position. (As a helmsman, he gives the ki-helm on a *Tsunami* 80 total ki points. These points accounts for four Ship Rating points! In combination with seven other ki-endowed characters, they can propel a *Tsunami* at incredible speeds. Lakara's single-handed contribution to the ki-helm is extraordinary.)

Lakara shares the First Mate duties on the *Taibohanto* with a kensai named Tansai Ibhei. Together, she and Lakara are responsible for assuring that the wishes of the captain are met with expediency. As the helmsman, Lakara and the other 12 helmsmen's duties are to assure the highest possible SR when the captain demands it. Other than these duties, Lakara's life on the *Tsunami* is an easy one. He is comfortable in his position. Well into his 50's, Lakara has considered retirement, but it is doubtful the navy will let him go easily.

Fleet Statistics:

The statistics below are for the Wa Space Fleet in Realmspace (i.e., the campaign sphere of Toril, the FORGOTTEN REALMS® setting). Only in times of war will the number of airborne ships increase beyond the 50% mark. This means that half of Wa's ships are always drydocked.

Squadron I: (Located in hangars across the Tsukishima and Shinkoku islands.)

Tsunami (4): Ton 200; HP 200; Crew: 1/200 (400 in war); MC B; AR 2; Save Metal; Power Ki-Helm; SR Special (minimum 5); Arms 6 bombards, 3 Medium jettisons, 12 Heavy ballistae, 10 Heavy catapults; SZ 950' x 70'.

Locust (80): Ton 1,500 lbs; HP 1; Crew: 2/3; MC A; AR 4; Save Light Wood; Power rudder of propulsion; SR 6; Arm 1 Light catapult or 1 Light ballista; SZ 14' x 4'.

Squadron II: (Airborne; whether this means the ships are in space or in the atmosphere is strictly a matter of interpretation.)

Tsunami (4): Ton 200; HP 200; Crew: 1/200 (400 in war); MC B; AR 2; Save Metal; Power Ki-Helm; SR Special (minimum 5); Arms 6 bombards, 3 Medium jettisons, 12 Heavy ballistae, 10 Heavy catapults; SZ 950' x 70'.

Locust (80): Ton 1,500 lbs; HP 1; Crew: 2/3; MC A; AR 4; Save Light Wood; Power rudder of propulsion; SR 6; Arm 1 Light catapult or 1 Light ballista; SZ 14' x 4'.

In addition, the Wa fleet has a number of captured Shou Lung Dragonships that are not part of the normal fleet, and the Emperor can call on perhaps 40-odd junks of various sizes for fleet supply or troop transportation if necessary.

"All I really need is the air that I breathe . . ."

Denys of Shiningburg, Paladin

3: SPACEFLEETS OF THE VOID



4: SHIPBUILDING COMPANIES

Ship manufacturers and reconditioners from around the known spheres are vying for the purses of those who travel the swarthy spacelanes. Some are reputable, but just as many are not. This chapter details the highest profile, the most notorious, and the most reputable shipbuilding companies in the spheres. If you have work to be done on your ship, you will need to take your vessel to one of these companies, and often, you must settle for the less-than-honest marauder to fix your ship. (DMs should feel free to modify these companies or to create their own firms to better fit their individual campaigns.)

If the characters decide to rely on one of the not-so-trustworthy ship builders, the DM should be very careful how he explains their workmanship. Not all disreputable carpenters are going to produce noticeably shabby work. The buyer may not realize he has a lemon until he is well out of the ship builder's docks and the warranty immediately (and often magically) expires. Usually the faulty work is never noticed until the ship enters combat, at which point every ship builder in the spheres stops guaranteeing their work. The following companies are listed in order of the crystal sphere where they reside for easy reference.

Generally, everybody knows everyone else in their town, unless the city is on a larger scale. If someone unrecognized stops at a port for ship repair or for the construction of a new ship (usually dismantling their original ship in the process), it generally means the person is a newcomer to the village, and probably won't be back, especially when they spin unbelievable tales about wildspace.

If this is the case, the owner of a disreputable shipbuilding company will undoubtedly instruct the characters where to go for a good time, where the finest restaurants are, and where to buy and sell the shadier cargoes. Therefore, this information is given for each entry.

The reputable companies, however, will not know or will refuse to tell the characters where the illegal or questionable can be obtained or sold. The crooked establishments will be a viable well of illegal information; but these are the ones to stay away from for important ship repairs.

Repair Costs

Spelljamming ships are easy to repair. Their similarity to standard seafaring ships is so close that anyone with the shipbuilding or carpentry proficiency can repair damage done to a ship.

In most civilized areas, a crew of five workers can mend one hull point in one day for 2,000 gp. For each additional five man crew and 2,000 gp, another hull point can be repaired in one day. Costs include all materials necessary for repair. If the ship is in poor repair (50% or more of its hull points lost) the cost increases to 5,000 gp.

Unless otherwise stated, shipbuilding companies listed in this book will repair ships for the prices stated above. There may be other factors, like saving throw penalties, if the players are not on guard against shoddy or substandard work.

The work that the companies do is divided into five different classifications. Table 4-1 below details these five classifications of repair work and their modifiers to the ship's saving throws, its AR, as well as additional damage it takes from any attack. Note that the negative numbers under AR Modifiers and Saving Throw Modifiers are bonuses, while the positive numbers are penalties.

Table 4-1: Standard Repair Modifiers

Work	AR Modifier	Saving Throw Modifier	Additional Damage
Superb	-2	+1	+0
Above Average	-1	+0	+0
Average	+0	+0	+0
Substandard	+0	-1	+1
Inferior	+1	-2	+3

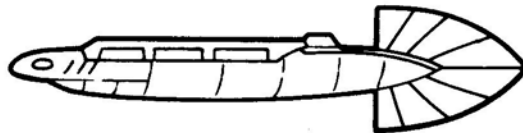

"Everything, in time, degenerates. Magic is not exempt. I don't know how, and I don't know why. It is just a law that applies to everything and everyone. This is why I don't believe in immortality."

Sarelk, Sage

4: SHIPBUILDING COMPANIES

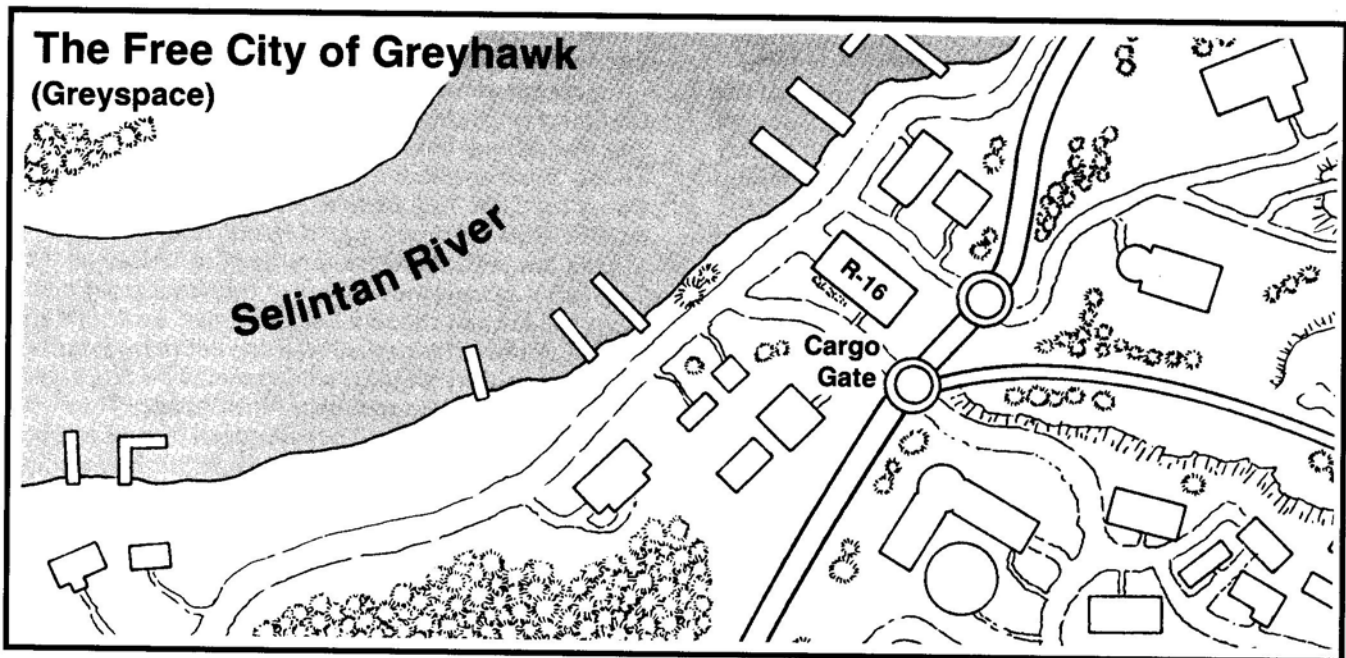

Greyspace

Snagtooth Shipbuilding

Located in the River Quarter of the Free City of Greyhawk, this company inhabits one of the few buildings (yet one of the largest) outside the city gates and walls. Snagtooth Shipbuilding can be found at location R16 near the Selintan River, the closest building to the Cargo Gate. Located on The Strip (a fairly popular street), the business gets a great deal of work from the ships that sail the river, as well as miscellaneous carpentry and stonework jobs within the city. (For more information on this city itself, refer to the *City of Greyhawk* boxed set.) The company's owner and manager also owns a tavern and inn called the Barge Inn. Brack Snagtooth, a dwarven male, recently purchased the shipbuilding company from a human named Samuel Keelson, who fell into a nasty tax evasion suit; and lost. Snagtooth was there just in time to buy the company for

what the human owned, and got Samuel Keelson out of financial trouble. Some people say that Brack purposely informed on the former owner, but Snagtooth firmly denies all allegations.

A reputable dwarf in dwarven culture, Brack Snagtooth is known for telling slighting jokes at the expense of humans and elves; especially humans. Humans and other nondwarven demihumans in the area surrounding Greyhawk city, though, see Snagtooth as an abrasive and intellectually stunted individual.

Though Brack owns the shipbuilding company, he has never set foot there. After buying the place, he had the original sign removed, and his name put in its place. He hired an unknown shipbuilder from the city of Marnar (in the country of Ratik) named Fionor Clawhand.

Fionor received his given name when he proved he could pull one hundred nails from ironwood in a single day. (He cheated in that bet when he carefully placed two pieces of iron in his gloves to give him

Fix It Yourself

If someone in the crew has the proper proficiency, ship damage can be repaired without going to a shipyard. Damage of less than 50% can be repaired without going to a drydock; more requires a special repair effort or runs a greater risk of serious mishap. A crew of 5 men can repair 1 hull point of damage in a week. Cost of materials is highly variable, but the most common, wood, is usually available for about 50 gp per point of damage repaired.

4: SHIPBUILDING COMPANIES

better pulling power.)

Shipbuilding: This company can build some of the finer water craft; unfortunately, they sometimes just choose not to. For standard sea-going vessels, they spend their time perfecting their work, making above-average craft.

Space lovers, those who come from wildspace and brag about their feats in order to "gain a better price," however, usually find themselves getting a better bargain. Fionor, the company's manager, always acts surprised and enthralled whenever anyone speaks of wildspace. He pulls information from them like a curious puppy after a kitten. After listening to their tales for hours on end if need be, Fionor "guarantees" them an under-the-barrelhead price they cannot beat. If the characters accept, he always smiles, winks and walks away.

The work that Snagtooth Shipbuilding performs on spelljamming ships is at the standard price, unless the characters try to bargain for a cheaper rate. The cheaper repairs cost 1,500 gp per hull point, and 4,000 gp for the really damaged ships.

The work on the standard price schedule is considered *average*. Average repairs do not penalize the ship in any way.

If the characters flaunt their spacefaring abilities in an attempt to get a cheaper price, the work they receive is *substandard*.

Port: The Free City of Greyhawk rests on the eastern shore of the Selintan River. This river flows southward from the Nyr Dyv into Woolly Bay and the Sea of Gearnat. It is suggested that the ship's captain not land the ship directly at the Greyhawk port. This is considered in bad taste, and results in an automatic *inferior* repair job.

When heading toward the City of Greyhawk, the captain has only one logical choice: land the ship on Nyr Dyv Lake's Midbay and float 60 miles downstream to the city.

Another choice is to land in Woolly Bay and float 210 miles upstream. Granted, a spelljamming craft can float upstream easily, but throughout the water-

based movement, the ship suffers a -1 SR penalty due to the resistance from the river.

In recent years, the widespread panics caused by spelljamming ships flying overhead have ceased, and the ships have become objects of curiosity. Those ships that have cargo for sale can sell their wares for 50% higher than the prices stated in the AD&D® 2nd Edition *Player's Handbook*.

This angers the retailers in the area, as the Greyhawk people would rather buy exotic products from space than those from their own world. (Many people believe the items have special magical properties since they were in wildspace.) The city's vendors pressure Snagtooth Shipbuilding to fix spelljamming ships with substandard parts and poor workmanship in hopes that the spelljamming ships will break apart before they can return to cause more economic damage.

Information: The employees of Snagtooth Shipbuilding are a verifiable wealth of information; from the macabre, to the sociable. Coinage greater than the silver piece must first grease the palm of the person before facts are revealed.

If the characters are looking for an inn to rest their heads, the employees tell them to go to the Barge Inn. (The Barge Inn is owned by Brack Snagtooth, the owner of Snagtooth Shipbuilding.) Whether the characters are looking for the nicest, the cheapest, the most expensive, the sleaziest; the answer is still the same. The Barge Inn has the loudest and the rowdiest tavern in the city. Half of its patrons are of dwarven descent, while the rest of the clientele consists of humans of the city, barge folk, mercenaries, and sailors.

If the characters are looking for felonious excitement and adventure, the employees tell the characters that the City Mint contains the largest collection of monetary treasure in all of Oerth; the Jewelers' and Gemcutters' Guildhall is the repository for a legendary cache of precious stones and metal; a great many donations are known to go into the coffers of the Temple of Xerbo (but the priests keep the treasure well hidden); the Master of the Thieves' Guild maintains a posh mansion in the High Quarter, where

Scavenging in Spaceports

The fine art of scavenging allows a crew to get something they want or need, usually spare parts, charts, or information or aid of an unusual nature.

The base chance of finding the item in a given week is 10%.

In addition to the base chance, there is a 20% chance of getting a lead. The chance of getting a lead increases by 5% per week.

4: SHIPBUILDING COMPANIES

he has a tremendous hoard of money that he squanders at a fantastic rate on good-looking women and expensive drink.

Other miscellaneous entertainment included the following (the city quarter where the establishment can be found is given in parenthesis as well):

- Dancing: Patricians' Club (High).
- Drinking: Fat of the Hog (Artisan), Low Seas Tavern (River), Nymph and Satyr (Garden), among many others.
- Gambling: Wheel of Gold Gambling (High)
- Inn: Barge Inn (River), Golden Phoenix (Garden), High Tower Tavern and Hostelry (Garden), Star of Celene (Garden), among many others.
- Miscellany: Assassins' Guild (Slum), Devin Half-hock's Pawnshop (Old City), Mercenaries' Guild (Foreign), Sages' Guild (Foreign), Money-changers' Guild (Foreign), Silver Garter (River), Stairnezh Stables (Slum), Thieves' Guild (Undercity).
- Music: Royal Opera House (High).
- Sports: Free City Arena (Clerkburg).
- Tours: City Botanical Gardens and Well (Garden), City Mint (Clerkburg), Lord Mayor's Palace (High).

Personalities:

Brack Snagtooth (Dwarf Fighter 12)
Owner of the Barge Inn and Snagtooth Shipbuilding

AL: NG HP: 72 THAC0: 9
AC: 5 #AT: 3/2 DMG: 1d8 + 4 (battle axe)
STR: 17 INT: 14 DEX: 11
CHA: 13 WIS: 14 CON: 15

Brack, explained above in greater detail, carries a *ring of protection* +4 and a *battle axe* +3. He is very selfish, often relying upon the shadier methods to protect his two greatest investments: the inn and the shipbuilding business. He is a divorced grouch who is far more irritating than the average dwarf.

Fionor Clawhand (Human Fighter 6)
Manager of Snagtooth Shipbuilding

AL: LN HP: 48 THAC0: 10
AC: 6 #AT: 3/2 DMG: 1d8 + 8 (battle axe)
STR: 18/00 INT: 16 DEX: 18
CHA: 10 WIS: 10 CON: 16

Fionor, explained in greater detail above, was hired not too long ago to manage the Snagtooth Shipbuilding business. The quality of workmanship has increased since his arrival, but the quality of work for outworld ships has decreased significantly. Fionor was cheated by a man in a spelljamming ship once, and he has promised himself vengeance upon everyone in space.

He carries a *ring of protection* +3 and a *battle axe* +2. He uses his weapon only when he absolutely must. He prefers to talk his way out of a battle, and kill his enemy with substandard workmanship.

The shipyard also employs at total of 42 carpenter/workers (carpenters, ship builders, etc.)

Employees of Snagtooth Shipbuilding
(Dwarven and Human Fighter 2)

AL: LN HP: 14 THAC0: 19
AC: 8 #AT: 1 DMG: 1d4 each

These are the nameless faces that throng the bowels of the Snagtooth Shipbuilding warehouse, making and repairing the ships that pass through. Every worker possesses the Carpentry proficiency, and every fifth worker has the Shipwright proficiency as well. They all make between 2 and 10 gp per month in wages.

When attacked, the workers use the miscellaneous tools of their trade, like wrenches, hammers, crow bars, screw drivers, and winch heads. When used as improvised melee weapons, all of these will inflict 1d4 points of damage.

As an example of scavenging, assume a group of giff land at the Rock of Bral looking for smokepowder. They don't find any, and don't get a rumor (the DM rolls a 42). They hang around a week. No smokepowder becomes available, but they hear a rumor that the merchant Lo Wei has some for sale to the right bidder at The Dock (the DM rolls a 33; the extra 5% made the difference).

The DM can adjust the chances to better control the pacing of the adventure.

4: SHIPBUILDING COMPANIES

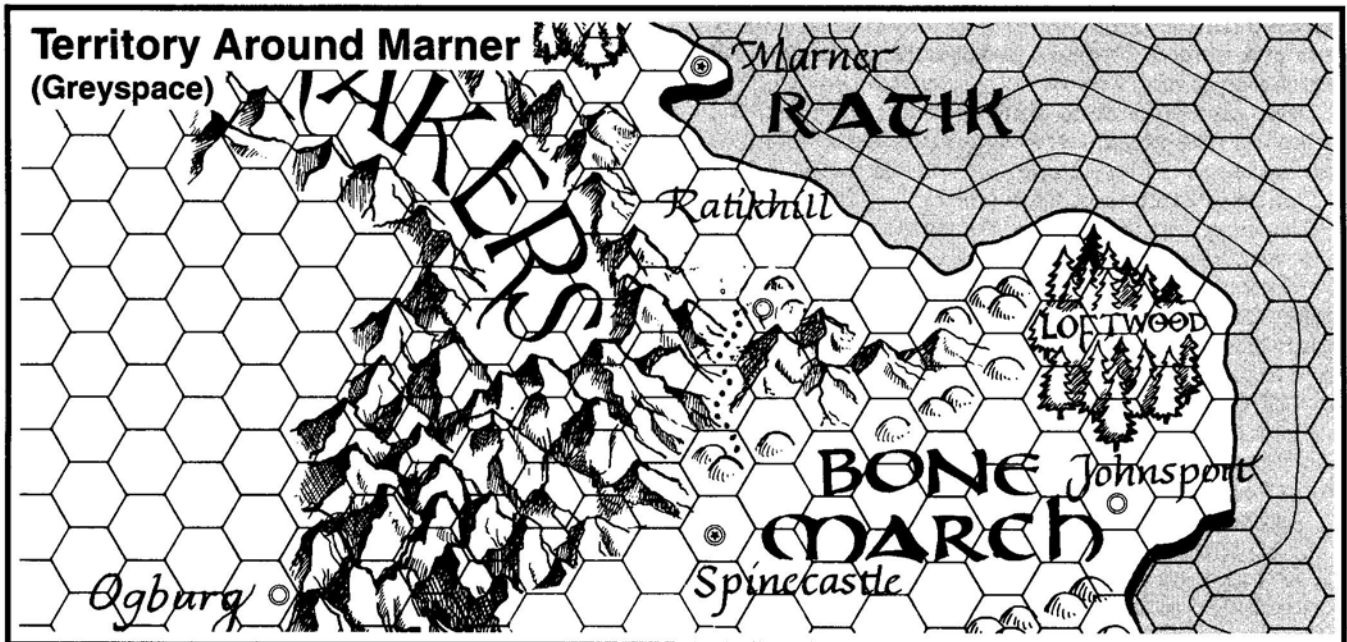

Blackdog's Frigate Infirmary

Located on the western periphery of the Grendep Bay, a small, quaint city named Marner sits quietly on the coast. Its 3,300 or so population enjoys the stature of being the capital of the Archbarony of Ratik. The city is quite rich, being the trail's end to all the archbarony's taxes. It is in this city that the port enterprise, Blackdog's Frigate Infirmary, holds a popularity unmatched in this part of the world.

Blackdog, the owner of this company, has seen poverty come and go. Recently, though, the wars that ravage the lands have made his business prosper. In the two years that the war raged in Oerth, his business grew from a small 10-man business, to a 400-worker company. He saw business from as far away as the Scarlet Brotherhood come into port for repairs. Blackdog's Frigate Infirmary is now the major employer in the city of Marner.

This elitist status has allowed Blackdog to influence the creation of laws and the rerouting of taxes

under threat of closure. In the Ratik government, he is hated and publicly ridiculed, but the people who work for him, and those who are trying to gain employment with his company, love him.

Being a former pirate and privateer (see the NPC description below), Blackdog understands the needs and wishes of his fellow compatriots. He also knows their underhanded transaction styles, and knows how to handle all their scams. He never loses money on a deal, turning every agreement into a profit-making proposition.

Last year, his first mate, a human born and raised in Marner, left his company to work for dwarven shipbuilder in the Free City of Greyhawk. Fionor Clawhand took the experience and the know-how that Blackdog taught, and became the manager of Snagtooth Shipbuilding. Since Fionor's departure, Blackdog hates Greyhawk and hates Brack Snagtooth—a man he has never seen. Blackdog always talks down the Greyhawk-born shipbuilder.

Marner

Marner is the capital city of the Archbarony of Ratik, on the eastern coast of the continent, north of the Great Kingdom. The city is rich in resources, the most important being shipbuilding supplies, gold, furs, and gems.

4: SHIPBUILDING COMPANIES

Ship Repair: Blackdog's company does not build ships; they only repair them. Anyone bringing in a ship can expect to get the work he has commissioned done. No one gets more than he pays for, yet no one gets any less. When it comes to ship repair, Blackdog is very serious. The customer gets the kind of repair job he demands. Below, a sampling of responses and their subsequent work classifications are given.

Work	Description
Superb	"Do the best job you can."
Above Average	"Baby her."
Average	"Just fix it."
Substandard	"Quick" or "cheap."
Inferior	"Quick and cheap."

The kind of work that Blackdog's Frigate Infirmary does depends upon the requested work, but the price fluctuates as well. Below, a table describes the cost of work on a ship that has suffered only minor damage, as well as the price to fix a ship that has been heavily damaged (suffered a 50% or more loss in hull points). The prices listed below are in terms of gold pieces per hull point repaired.

Table 4-2: Blackdog Repair Costs

Work	Standard Cost	Heavy Damage Cost
Superb	4,000	7,000
Above average	3,000	6,000
Average	2,000	5,000
Substandard	1,500	4,000
Inferior	1,000	3,000

Port: When approaching the city of Marner, the captain need not be too concerned about disguising the vessel as a standard sea-going craft. The city does not panic or charge extra tax for port. When docking, the ship is met by a crew of dock hands who, by using enchanted hawsers and mooring bits, tie the ship securely to the dock.

After docking, a government official stands by to charge a copper piece in dock tax for every ton of ship. If this tax is not paid, the ship is untethered and released, whether the characters are on board or not. Once this tax is paid, the characters and their ship can stay for as long as they wish. The dock berth rents for one silver piece per day.

Information: In the hills surrounding the city of Marner, gold mines and gem fields have prospered. Much of the world's gold comes from the mines here, and this has affected the price of items as well. When purchasing with gold pieces, the DM should raise the price by 20%, but when buying with any other monetary coin, the price should remain the same. For example, instead of a platinum piece being worth 5 gp, it is worth 6 gp in Marner. Gems are worth only 80% of their true value as well. Fur and lumber, plentiful in this area as well, are 20% cheaper.

Because of the gold glut, many traders who enter the town to sell objects in great demand insist that their buyers pay in gold. This means that they can get an additional 20% on their wares, which makes trips to this town greatly profitable.

Recently, the Archbarony government has intervened and has limited the amount of gold a single individual can take from the city to 1,000 coins each. This statute came about when towns as far away as 300 miles were complaining about the loss of trade and the devaluation of the gold piece.

At the same time, the people of Marner have become disillusioned with the gold piece, so they tend to spend it more freely than they do any other coin. This makes the prospect of "selling" platinum, silver, or electrum, highly profitable, since Marner citizens are willing to invest in virtually any commodity that is not gold.

This town has all the amenities of the larger town, but has fewer vendors. The neighborhood inn commonly serves a dual purpose as local tavern. The grocer often serves as a moneychanger, while the neighborhood gem cutter has become the local investment consultant.

The Flow of the Phlogiston

The currents of the phlogiston make travel between some spheres easy and other journeys maddeningly slow. Sometimes the currents themselves change course.

Stable currents run in both directions between Realmspace and Greyspace, and between Greyspace and Krynnspace. No currents run between Realmspace and Krynnspace, making a route through Greyspace the fastest way to get to the other sphere.

4: SHIPBUILDING COMPANIES

Blackdog (Human Fighter 14)

Retired pirate, owner of Blackdog's Frigate Infirmary.

AL: CN	HP: 100	THACO: 7
AC: 0	#AT: 2/1	DMG: 1d4 + poison
STR: 14	INT: 13	DEX: 13
CHA: 10	WIS: 12	CON: 14

Not an extraordinary man by any means, Blackdog feels he has bettered everyone he has faced because he has the tenacity and the willpower they lack, despite many of his opponents having shouldered that scraped the ceiling.

His life as a pirate seemed cursed from its inception. On his first leg into the phlogiston, a league of Mantis ships caught his ship by surprise, and Blackdog and his crew mates were left for dead. Luckily he located the helmsman, and they bound their two chunks of the ship together and sailed to their home sphere. The first planet they reached, The Spectre, revitalized their air envelope, and they were able to make it to a base in The Grinder.

The story of his close brush with death won him a second mate position on the *Galica*, a Jade Spider in a pirate company. His captain, Ordo Darkskin, a half-breed drow/human with the disposition of an alley cat dipped in hot tar, was abusive and the crew hated him, but their fear of his wrath kept them in line. When the *Galica* headed for an attack against a gnomish Sidewheeler, Blackdog ran down to the drill room to tell the crew to prepare for an attack.

Blackdog always hid his favorite weapon, a *rapier* +2 behind the drill bit. As he reached for the weapon, the captain yelled down for the drill crew to start working. Unfortunately, as Blackdog was pulling his arm out, the adamantite drill bit crushed and removed his hand three inches above the wrist. As he screamed in agony, listening to the drill grind his rapier and hand, the Jade Spider plummeted into the side of the gnomish ship and Blackdog fainted.

When he awoke, he found himself adrift once again. The ship's cook was clinging to the same piece of the keel he was. He learned then that the

gnomish Sidewheeler was a Man-O-War disguised by a powerful illusion. A few days later, they were rescued by an elven Flitter and returned to Oerth.

Three hungry weeks later, Blackdog (a hook replacing his left hand) hired himself out to the same pirate company on a Mantis named the *Thread of Hate*. This time he was placed as a first mate. His captain was a meek human named Dunan. This was Dunan's first command, and he was not adept at controlling his men. He flew into rages, cried, and threw fits, losing all respect from his crew.

One evening as Dunan and Blackdog were standing on the poop deck, one of the pirates on board shot an arrow, attempting to assassinate the captain. Blackdog saw the pirate at the last moment and tried to push Dunan away. Unfortunately, the arrow grazed Blackdog's right eye, and stopped about five inches through Dunan's throat. Dunan died from the fatal shot, and Blackdog lost the use of his eye. Now the captain of the *Thread of Hate*, Blackdog was determined to make some money at pirating. His seven previous months had earned him naught but three square meals a day, and that wasn't getting him anywhere near retirement. He sent his ship into the heavily traveled spacefaring lanes looking for a cargo hold to steal, when the lookout reported a new ship type, a Triop, to starboard.

His ship attacked, but he wasn't prepared for the Triop's violent ram attack. As the ram smashed into the side of his ship, Blackdog fell overboard. The Triop, however, was unable to handle the strain of the attack, and split apart. The front end crumbled, sending the midship splintering into the *Threads of Hate*. As Blackdog fell toward his ship's gravity plane, the crumbling Triop caught his leg and removed it at the knee. After the attack, Blackdog and his crew shared a 120,000 gp cargo hold of gold-laden silk, which they sold at the nearest port.

When Blackdog received his share, he fled to Oerth, where he started his own business. Being extremely superstitious, Blackdog feels the next time he enters wildspace will be the end of his life. Considering his experiences, he's probably right.

**"Aye laddie, we wuz a free trader ooter Toril.
Free ship crews don't owe no loyalty but to the capt'n
an' t'each other . . . An' dun ya think
the navy boys dint envy us that."**

Derek Flinthand, Sail Master (retired)

4: SHIPBUILDING COMPANIES

Krynnspace

Kristophan Nautical

Kristophan is a major city on the continent of Taladas. In fact, the city is the seat of the Southern Hosk Empire. Here, the Empire rules, the Senate meets, and the Imperial Arena stands. Kristophan is not a beautiful city. Built around an old human settlement, the capital is divided into three districts: the Old City, the New City, and the Imperial City.

The Old City district centers around the original human town of Kristophan and the neighborhoods immediately around it. The buildings are older; most of them are two stories and built of wood. Most of the buildings and walls constructed of stone were destroyed to construct the Imperial City district.

Fire, especially during dry summers, is the greatest threat to the inhabitants. Disease, carried by sewage muddied street-living rats, is a close second. Once the heart of Kristophan, the Old City is now a gloomy and dangerous ghetto. Humans, elves, and dwarves make up the majority of the population since few minotaurs dwell here, preferring instead the company of their own kind.

There are numerous cheap taverns, tea shops, coffee stalls, houses of ill-repute (another major cause of death), gambling halls, and smoking dens. These dens of crooked games are the meeting vestibules of the informal fraternities of high-lawyers (bandits), versers (card cheats), nips (cutpurses), foins (pickpockets), rufflers (muggers), charms (lockpickers), jackmen (forgers), and anglers (burglars).

Walking down the narrow, filth congested alleyways can, in itself, be an adventure. The footpad, wearing the obligatory hooded cloak that hides the tools of homicide, lets his shifty eyes dart from window to alley, looking for an opportunity; the paranoid convict, with the brands and tattoos of the criminal, perceives even the small children as threats; the racketeer skulks at the cracked window and the slit in the door, ready to exchange a hot tip or rumor of adventure for a steel piece in the hand.

If the characters enter the Old City, the DM can roll against the following chart to determine NPC encounters. This chart uses a percentile roll to determine the NPC type, and names the NPC type, the number and the class levels.

Table 4-3: Kristophan NPC Encounters

Die Roll	NPC Type
01-08	Angler (1d4 thieves, 1d4 + 4 lvl)
09-11	Charm (1 thief, 1d6 + 10 lvl)
12-31	Citizen (1d10 zero-level fighters)
32-42	Convict (1d4 fighters, 2d12 lvl)
43-50	Criminal (1d4 fighters, 1d10 + 4 lvl)
51-70	Foin (1d4 thieves, 1d4 + 2 lvl)
71-78	High-Lawyer (2d4 fighters, 1d4 + 4 lvl)
79	Jackman (1 thief, 3d6 lvl)
80-83	Murderer (1d2 fighters, 1d10 lvl)
84-93	Nip (1d4 thieves, 1d4 + 6 lvl)
94-97	Racketeer (2d4 thief or fighter, 1d12 lvl)
98	Ruffler (1d6 thieves, 2d6 + 6 lvl)
99-00	Verser (1 thief, 1d10 + 8 lvl)

The New City district, surrounding the Old City district and built after its conquest by the minotaurs, reflects their tastes and skills in architecture. Most of the buildings are low, one or two stories, and built of brick. Only a few stone or wood buildings exist. The better part of the docks and quays of Kristophan are found in the New City, built by the minotaurs for the great ocean fleets.

The streets, avenues, alleys, and lanes twist and turn almost randomly, making the New City a dense maze of buildings. Apparently the minotaurs seem to like things this way, for most other cities of the Empire follow suit. Others, particularly the dwarves, find the system maddening and frustrating.

The Imperial City is the most isolated and secure section of Kristophan. Nestled in the center of the New City, it is separated from all else by a decorative, solid, and well-manned fortification. This wall not only keeps the common people out of the Imperial City, but it also serves as the final line of defense for the city.

Rates of Exchange on Krynn

Steel is the metal standard on Krynn. One steel piece (stl) has the same purchasing power as a gold piece on most other worlds. Also, there are iron pieces (ip) and bronze pieces (bp), each worth $\frac{1}{2}$ steel piece. The rest of the exchange rate is:

1 pp = 5 stl
1 stl = 2 ip
1 stl = 2 bp

1 stl = 10 gp
1 stl = 20 sp
1 stl = 100 cp

4: SHIPBUILDING COMPANIES

Entrance into this district is facilitated through one of four gates. During the daytime, citizens are allowed to pass through the gates, but at night they are closed to all. Furthermore, the citizens of the Old and New City must leave before the gates are closed or be arrested for breaking the curfew.

Ship Repair: Kristophan has the best ship builders on Krynn. They cannot aid spacefarers who have lost their spelljamming helms, but they build hulls of the finest craftsmanship. The table below gives the cost for standard repairs and heavy damage repairs (in steel pieces per hull point).

Table 4-4: Kristophan Repair Costs

Work	Standard Costs	Heavy Damage Cost
Superb	6,000 stl	10,000 stl
Above average	5,000 stl	8,500 stl
Average	4,000 stl	7,000 stl
Substandard	3,000 stl	5,500 stl
Inferior	2,000 stl	4,000 stl

Work done at Kristophan may give the ship a single one-time bonus selected by the DM. (A ship could not dock twice, get superb work both times, and end up with a +6 SR bonus). The bonus lasts until the ship is repaired again, when it reverts to its standard AR, MC, or SR.

Table 4-5: Kristophan Repair Modifiers

Work	AR Bonus	MC Bonus	SR Bonus
Superb	-2	+1	+2
Above average	-1	+0	+1
Average	+0	+0	+0
Substandard	+0	-1	-1
Inferior	+1	-3	-2

Port: The better part of the docks and quays of Kristophan are found in the New City district, built by the minotaurs for the great ocean fleets. The docks lining the southeastern section of the bay all belong to the New City district. Dozens of spars stretch into the clear blue sea, able to moor a ship smaller than 400 feet in length (keel), and 50 feet in width (beam). Ships larger than this must moor almost a quarter mile from the docks, dinghy the crew into port, and barge the cargo into customs.

Customs is an intricate network of laws, etiquette, and tariffs that can, at times, seem almost overwhelming. Every item brought into the port city is taxed. The tariff is one copper piece for every steel piece of value the items have. Everything is included in this surcharge, and everything must be declared, scribed and sent to the taxmaster for approval. After approval (1d100 minutes later), the foreigner is allowed passage.

When the nonnative leaves the city, everything is declared once again, but this time, the outsider is given a tax amelioration. This means that the value of everything being taken out of Kristophan is added together, and the visitor receives one copper piece for every steel piece value he has (this includes the items he may have purchased while visiting the city). Foodstuffs, drinks, worn out clothing or other discarded items are not included in this tax refund.

This tax reimbursement was created almost 20 years ago when the city's economy started faltering. Instead of raising taxes to pay for the constabulary needed to combat the increased crime rate, they devised a plan to improve exportation of goods. Every item sold in the city is charged a flat 10% tax (equating to one silver piece for every steel piece spent). Then, when the products are exported, the shipped wares gains a tax break of 1% (one cp for every stl). This still leaves the city with nine copper pieces in tax for every steel piece spent in exports. Since this program was incorporated, the city of Kristophan has increased its exportation by 15% every year, on the average.

Looking for a Crew

Green crew is easy to find almost anywhere: greenhorns, groundlings, and press gang fodder.

Average crew can be found in any city or settlement that caters to spacefarers.

Trained crew are found mostly in large bases and spaceports the size of major cities; an average of 3d10 can be found per week.

4: SHIPBUILDING COMPANIES

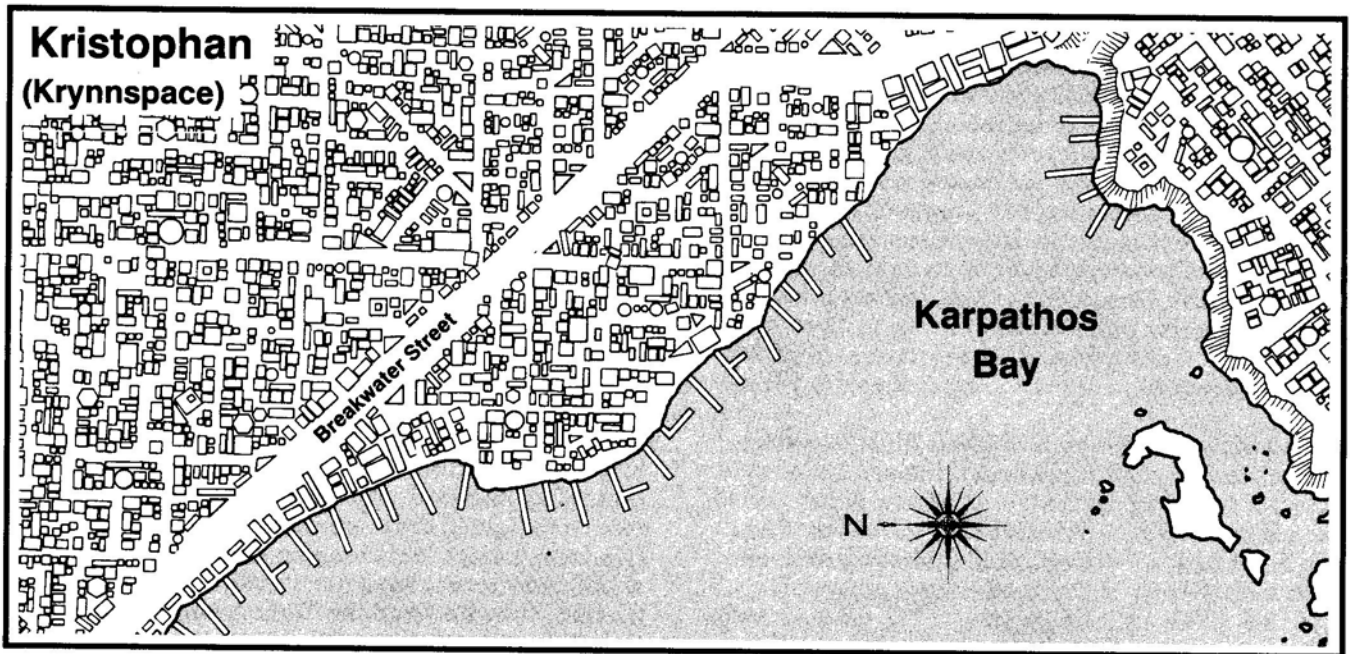

Information: The levy refund (spoken of earlier) is one of the most attractive aspects of the city. This is the only city known that has such a program, and it works, bringing merchants and adventurers back again and again.

This program also has one other aspect that made it attractive to the Imperial City delegation: it was a fantastic way to control the trafficking of illegal and stolen goods to and from the city limits. Those found possessing these items are immediately arrested and sent to the nearest branch of the constabulary. If they are found guilty, they usually are sent to the Imperial Arena for the rest of their lives to compete in the obligatory skirmish to the death with other convicted criminals.

If characters are attempting to remove stolen property, there is a 5% chance *per item* that the theft is detected. Each character also has a 1% chance of being accused of trafficking. If this unfortunate incident occurs, a character who is cleared is released within 1d4 days with a multitude of apologies and an

offer of monetary compensation for the tremendous inconvenience equal to 3d20 stl. (If the character wishes, he can hire a minotaur lawyer and sue for an additional 2d100 stl; this process takes 1d12 months, during which time the character must stay in the city. The time required should remain a secret from the character until the trial is over, as the length of a court case is unpredictable.)

In the Port section, the docks and quays of the New City district were covered, but no mention was made of the docks of the Old City district. There is a reason for this: It is not a nice place to visit. Six quays jut from the rocky shore adjacent to the smelliest, and ugliest port in the known spheres. Thousands of rotting fish heads bob in the waves near the rocks where carp and angler-like fish offer nibbles from their stinking flesh. The quays stand like broken fingers over the sewer-like waters, providing a mooring unfit even for the rattiest of rafts.

No one works at the docks, and anchorage is free. No one rushes out to moor the ship, and no one

Crack crew are made by the captain of a ship in the course of spacefaring. There's no other way to get them. The teamwork of training together is vital, as is an actual ship-to-ship action.

Specialists, like trained crew, are found at major spaceports; an average of 1d10 can be found per month. Specialists usually get double pay.

4: SHIPBUILDING COMPANIES

comes to buy the product, or offers to remove barnacles. It is a very lonely, melancholy place. To the east and northeast, the city lights and several of the taller and closer buildings can be seen.

Those who berth their precious ships in this harbor should beware. Mysterious fires are common for the unwary merchant selling his wares. (Each night, a 20% chance exists for the ship to sustain a one hull point fire that grows one hull point in strength every round. See the Fire rules in the *Combat Among the Stars* booklet for more details.)

Personalities:

Boris Lionheart (Minotaur Fighter 8)
Excise, Tariff, and Assessment Official

AL: LG HP: 39 THACO: 13
AC: 5 #AT: 2 DMG: 2d8/2d4 or by weapon
STR: 17 INT: 18 DEX: 14
CHA: 16 WIS: 15 CON: 16

When the characters port at the New City district docks, the first, and last, person they meet will be Boris Lionheart, or someone in his employ. Boris controls the taxation of all incoming items, making sure everything is accounted for and properly documented. When the characters leave, he assures their proper refund of taxation within the city, and the return of all money taken on personal items.

Boris is an average-looking minotaur, and by human standards, difficult to discern from another. He often adorns his horns with small brass and gold trinkets when he takes in the night life with his beautiful wife and seven children. At work, he takes matters seriously, withholding wages from underlings who take any aspect of their employment lightly. This makes him a respected official, but it also makes him very difficult to work with. The turnover has been so great (especially around legal holidays), that the Imperial City officials have been watching his performance. If things do not improve quickly, the PCs may find themselves facing another, less tractable, official in the near future.

Devan Cory (Human Fighter 21)
Outlaw and convict

AL: NE HP: 108 THACO: 0
AC: -1 #AT: 2 DMG: 1d8 + poison
STR: 15 INT: 13 DEX: 15
CHA: 16 WIS: 10 CON: 16

Once in a great while a person is born whose very name strikes fear and terror into the soul. Rarely is a name so linked with hate and abhorrence that it is spoken with bated breath and airy whispers. Devan Cory is such a name. A human born on the continent of Ansalon, he has grown to be a major underground figurehead in Kristophan society.

Convicted of multiple murders, robbery of the Imperial City museum, and tax evasion, Devan was sentenced to fight in the Imperial Arena. He served there five years before launching an escape plan with seven of his closest (and most violent and virulent) friends. They fled into the Tombs; catacombs in the Old City district dating back to the original Kristophan human settlement. This necropolis, with its crumbling gravemold, now serves as home and headquarters for this slipshod company of devious and diabolical criminal minds. Currently, Devan's compatriots in crime include:

- Bartnel the Cripple (male rogue, 13th level)
- Azous Blackstaff (male priest, 16th level)
- Desiree Dreamscape (female mage, 18th level)
- Modeus Khan (male fighter, 10th level)
- Komoda the Fearless (female fallen ranger, 17th level)
- Thaedran Meridian (female fallen paladin, 14th level)
- Omar Zargoma (male rogue, 14th level)

Together, these three women and five men ravage the Old City docks, causing death and terror, trying to hurt the city that imprisoned them in the Imperial Arena. The myth behind Devan Cory is so great that the Kristophan citizenry is starting to believe he is nothing more than a juvenile tale used to keep children disciplined.

Crew Pay

Crew Type	Pay	Prerequisite
Green	2 gp/mo	None.
Average	4 gp/mo	30 days in space.
Trained	6 gp/mo	90 days in space plus one trip into the phlogiston.
Crack	6 gp/mo	180 days in space plus one trip into the phlogiston and combat with at least one enemy ship.

4: SHIPBUILDING COMPANIES

Solamnic Schooner Sales

Palanthus, the largest city on the Ansalon continent, fared best through the dark years of the War of the Lance. Because Palanthus was spared the death and anguish suffered by most other cities, the people have become aloof, believing their city deserved to be spared, and all others got their just desserts.

The center of good philosophies, Palanthus has been the city quested for by people following such deities as Paladine, Majere, and Mishakal, to name the three greatest.

In this city, a group of seven carpenters teamed up and created a new business. Settling for some very expensive land just south of Branchala Bay, they built three large hangars near the waterfront and called their ship resale business Solamnic Schooner Sales.

Ship Sales: The Solamnic Schooner owners never hire themselves out to perform ship repairs. If an individual has a craft that needs reconditioning, Solamnic Schooner buys the vessel and then sells it reconditioned. (The owners say they work in this manner so as not to feel rushed.)

When Solamnic Schooner buys a ship, they offer a base price by marking down the vessel 5% to 10% (1d6 + 4). In addition, they decrease their offer to buy in proportion to the amount of hull damage the ship has taken. Buying seriously damaged ships is where the company makes its real money.

In other words, if a new Yacht (actual sale price 625,000 stl) was brought in, the company would cut their buyout price by as little as 31,250 stl (5%) to as much as 62,500 stl (10%). If the ship was not damaged, the price cutting would stop there. If the ship was damaged, however (say it lost three of its 10 total hull points) the price would be slashed an additional 30% (since it lost 30% of its total hull points), or 187,500 stl. In addition, they always sell ships that are completely refurbished, reconditioned, and restored. These ships sell for the equivalent in steel pieces of the cost listed in the *Ship Recognition Manual*.

Since the ships available for sale change monthly,

a series of tables have been created to simulate this change. The DM should feel free to alter and adapt these charts to the individual campaign. At any one time, Solamnic Schooner will have 1d12 ships available for sale. When the number of ships is determined, the DM needs to ascertain which ships are available by using the following tables.

When determining which ships are available for sale, the DM should roll d100 against Table 4-6 once for each ship available for sale to determine the ship's relative rarity. Each rating frequency has its own chart to determine the actual ship that is available. All tables use percentile rolls to generate their results.

A special table, Table 4-10: Ships Never Sold, lists vessels that are never for sale at Solamnic Schooner Sales. Some of these ships, however can be purchased (however rarely) on the black market for 1d4 + 1 times the going price. (The black market and the villainous people who run it are detailed on page 48.)

Table 4-6: Frequency of Ships (Roll 1d100)

Die Roll	Rarity	Reference
01-04	Very Rare	See Table 4-7
05-15	Rare	See Table 4-8
16-35	Uncommon	See Table 4-9
36-00	Common	See Table 4-11

Table 4-7: Very Rare Ships (Roll 1d100)

01-05	Armada	51-55	Locust
06-10	Black Widow	56-60	Man-O-War
11-15	Clipper	61-65	Monarch Armada
16-20	Dreadnought	66-70	Narwhal
21-25	Flying Pyramid	71-75	Pirate Dreadnought
26-30	Great Galley	76-80	Scalpel
31-35	Hummingbird	81-85	Smalljammer
36-40	Hunter-Killer	86-90	Unity
41-45	Jade Spider		
	Commandship	91-95	Whelk
46-50	Klicklikak	96-00	Yacht

Crew payment is usually in advance for two months at a time. Adventurers and privateers may demand a "crew's cut", a sum equal to the leaders' share to be divided among the surviving crew. Some captains kidnap crew members, or pay a bounty to freelance "press gangs". In the long run, this is often more trouble than it's worth (you never know when you're going to get a hero).

4: SHIPBUILDING COMPANIES

Table 4-8: Rare Ships (Roll 1d100)

01-04 Antlership	54-57 Skiff
05-09 Battle Dolphin	58-62 Swan
10-14 Bloatfly	63-66 Thorn
15-18 Bolaship	67-70 Triop
19-22 Corbina	71-75 Turtle
23-27 Dolphin-Shuttle	76-79 Tyrant
28-31 Iambus	80-83 Tyrant Scout
32-35 Jade Spider	84-87 Uspo
36-40 Lamprey	88-91 Werewolf
41-44 Nautiloid	92-95 Yawl
45-48 Nightwolf	96-00 Zoocraft
49-53 Skeleton	

Table 4-9: Uncommon Ships (Roll 1d100)

01-05 Angelship	51-55 Leech
06-10 Catamaran	56-60 Mantis
11-15 Depowered Flitter	61-65 Mindspider
16-20 Dragonship	66-70 Radiant Ship
21-25 Drakkar	71-75 Scorpion
26-30 Dromond	76-80 Speed Clipper
31-35 Eagle	81-85 Superheavy Damsel fly
36-40 Flitter	86-90 Urchin
41-45 Flying Fortress	91-95 Vagabond
46-50 Juggernaut	96-00 Yawl Wagon

Table 4-10: Ships Never Sold (Roll 1d100)

01-07 Argosy	54-60 Quentin's Libraria*
08-13 Batship*	61-67 Leviathan
14-20 Citadel	68-73 Spacesea Giant Galleon
21-27 Cuttle Command	74-80 Spelljammer*
28-33 Great Bombard	81-87 Stoneship
34-40 Mammoth	88-93 Tsunami*
41-47 Octopus	94-00 Wraith*
48-53 Quad of Thay	

*These ships are never found on the black market, and therefore, can never be purchased. These ships are never for sale because they are either unique, as is the case for the *Spelljammer*, *Batship*, or *Quentin's Libraria*, or too powerful for private ownership.

Table 4-11: Common Ships (Roll 1d100)

01-03 Barge of Ptah	51-53 Junk
04-06 Battlewagon	54-56 Leaf
07-09 Bee	57-59 Longship
10-12 Blade	60-62 Mosquito
13-15 Bumble Bee	63-65 Porcupine
16-18 Caravel	66-68 Shrike
19-21 Cargo Barge	69-71 Sidewheeler
22-24 Coaster	72-74 Squid
25-26 Cog	75-76 Stinger
27-29 Damsel fly	77-79 Tradesman
30-32 Dragonfly	80-82 Tradesman Light Cruiser
33-35 Eel	83-85 Viper
36-38 Firefly	86-88 Wasp
39-41 Galleon	89-91 Whale
42-44 Gnat	92-97 Wreckboat
45-47 Hammership	98-00 Xebec
48-50 Heavy Hammership	

Port: The port of Palanthus is a beautiful sight to behold. Large cliffs stand majestically on either side of the north-facing bay. The city itself, on the southern shore of the bay, descends upon the water like a flowing chromatic robe to meet the lapping waves where hundreds of docks and twice as many ships list in the cool, narwhal-filled bay.

The waterfront city, the beach, and the docks are surprisingly clean. The smell of rotted fish and the unsightly mess associated with port cities is not present here. The city officials maintain a strict set of laws and a large, vigilant force to enforce these edicts and maintain a clean, safe environment. This assures continued patronage of their cities by most traders throughout Krynn. This has also increased their trade with spacefaring traders as well. Palanthus is known as the most beautiful city in the sphere.

When the bay is entered, tiny tug boats, powered by *rudders of propulsion*, approach the ship, rope it, and pull it safely into port. If the ship is too large for the docks, free passage to and from the ship is given

*"The Asteroid Queen was a system ship.
That means she just ran from planet to planet
and never left the sphere.
The guard work was steady, but dull."*

Dairn, Emerald Brotherhood Company

4: SHIPBUILDING COMPANIES

to the crew and the ship's cargo. Palanthus does not charge a docking fee, but the cargo levy is 5%.

Information: Palanthus is a strongly human settlement, with a smattering of other races, including minotaurs. Several spelljamming races, including the giff and arcane, have relocated businesses and bought personal property here. These new businesses have increased the export and import trade of the city to the point where local taxes have actually been on the decrease. (The taxes pay for the beautification of the city, as well as the continued war against the neogi infiltration in the lower city. See The Black Market for information on the Lower City.)

Palanthus has a great number of specialist sailors. The best in the sphere, the Palanthian sailors demand a high price and they are worth every copper piece. Other exports include constructed and reconditioned ships. Solamnic Schooner is by far the best in the city, but other options do exist. Printed material in all forms, be it books, scrolls, or pamphlets, are a great export item as well.

Magical writing and spell trading are extremely volatile money makers in Palanthus. Both for selling and purchasing, nearly everyone in the spellcasting business looks for that elusive spell that someone else may have created.

Spell research, the study of mystical energies and the shaping of that power, is happening everywhere. Almost 5,000 individuals to date hire themselves out to create (or find) the spells that their employers want. Usually, these citizens hire themselves out as freelance personnel, working for up to three people, trying to locate a spell or actually work on the creation of the spell. They usually charge a great deal of money for their services—with one-half the money paid before work is done—and the rest paid at time of delivery.

These researchers often work together, sharing information and ideas in their quest for perfect spellcraft. At last count, over three million steel pieces have been spent in this city on research.



Laws to be Aware of: Surprisingly, for a relatively neutral people, Palanthus has some very strict laws that it upholds. Two in particular are very important for spelljamming individuals to be aware of.

Narwhals, a species of whale, are common in the waters of Vinas Bay. Many of the city's people believe that life in the sea must be actively protected. They have passed an extremely tough statute that forbids narwhal hunting. Those found hunting the "unicorn of the seas" are punished by serving 1d12 years in a hard labor camp.

The second law to be passed in recent decades is the illegalization of certain types of literature not approved by a local advisory board (mainly literature proposing ideas different from orthodox reasoning or belief), the sale of such goods, and the sale of anything without the city tax being incorporated into the price. All literature and items not possessing the seal of approval and tax payment cannot be sold on the open market, which leads to . . .

Fleet Movement

Fleet movement in space is can be tricky. The inability of ships to move at spelljamming speed when close to other ships makes coordinating the movement of numerous ships difficult. The usual procedure for a small number of ships is to spread them out a bit further apart than the critical distance at which they will drop each other back into tactical speed and try to move in the same general direction.

4: SHIPBUILDING COMPANIES

The Black Market

It is unfortunate, but any large city has its slums; the region where the crime rate is unusually high, and the population so dense that no one gets a chance to experience privacy. Palanthus is no different. Its slum, called the Lower City, is located in the southernmost suburbs of Palanthus.

In this area, the mood is darker. Bars cover the windows, taverns line every street, and the constabulary prefer to patrol only the perimeter. Every block has demolished or fire-gutted buildings where abandoned urchins and homeless plebeians (who possess their own cant) clutter to hide from the frequent thunderstorms.

These forsworn follow what is known as the *code of the street*. This unspoken code allows the homeless to use any abandoned building or warehouse for shelter. The homeless, the destitute, and the abandoned refer to themselves as "the crush". The "crush", however, is also used as an all-encompassing term that refers not only to them, but to their language, and their condition.

No one "on the crush" can, or at least should, cast another out of a sleeping locale (although this happens to some pathetic loners). No one on the crush informs on another; this, the greatest of their laws, makes it very difficult for the constabulary to maintain order, since no one sees, hears, or knows anything. The constabulary realizes this is part of being on the crush, so they never expect to solve any of the lower city's problems.

Another aspect of the code is what is known as "the hunt". The hunt is a term that refers to a crush who is prowling to steal, be it food, money, or goods. The person on the hunt paints his face in dark, preferably black paint, and dirties his clothing with dark soil. This is the only time that all other crush laws break down. A person on the hunt is allowed to do whatever is necessary to complete his prowl. (This feat usually involves thievery, but can include murder for pay, or other larcenous acts.)

Entwined in the culture of the crush, the black market seethes with heinous and diabolic intent. De-

signed to undermine everything that law and order stand for, the black market in recent years has grown bolder and more vile. Every malefic and atrocious act reported in the Palanthus is blamed on the black market and on those on the crush, and justifiably, to a point. When the crush are not to blame, the black market is.

Controlled by a contingent of death knights, the black marketeers dominate their followers, their customers, and their suppliers, by fear alone. Those who cross the black market, whether by accident or design, meet with a fate often termed worse than death.

Nearly anything can be found in the black market, assuming that money and time is no object. Grossly illegal literature (the complete writings of Zeboim, for example) and crown jewels from this and distant worlds can be found.

There is one thing any prospective black market customer should remember. If you approach the black market, you better be serious about the sale. They do not like wasting their time, and they are very stern about this. They have been known to break the knee caps of vague people, and they have killed those who as much as threaten to divulge a thread of information to the authorities. This group of individuals effectively turns the sunny skies of Palanthus to a dreary dusk.

For the everyday citizen of Palanthus, the black market is an entity to be feared and ignored whenever possible. For the spelljamming citizenry, however, the black market can be a place to purchase the spells and magical items that cannot be purchased on the open market because they may be considered too offensive. Ships that the standard dealers would never dare sell (See Table 4-10: Ships Never Sold on page 46) can be purchased here.

When making a purchase, the DM should multiply the cost of the items by $1d4 + 1$. This tremendous overhead is used to combat the forces of good that commonly strive to shut down the black market. The profits are also used to assure the long life, wealth, and comfort of those in control.

Sadly, the black market controls a few figures in

Larger fleet movements are made up of "waves" of smaller groups. The second wave will appear 24 hexes behind the first wave, the third 24 hexes behind the second, and so on. Ships trying to support each other have to move closer to each other using tactical movement. Thus, trying to get around in fleets takes some skill at group maneuvering.

4: SHIPBUILDING COMPANIES

high places. The constabulary and the House of Commons both suffer from the spying eyes of informants. This keeps the black market one step ahead of the city watch, as well as attempting to influence the lawmaking process to make their actions less underhanded. (Noticeably, however, the black market has met with failure in its endeavors to reconstruct the statutes, since its actions are yet illegal.)

Personalities:

The four death knight NPCs that follow are well over six feet tall and weigh over 300 pounds. Their magical abilities make them especially dangerous. None of them have ever been known to smile, though laughter, on occasion, has emitted from their chambers—usually when they want to discipline one of their clients. They constantly generate *fear* in a five-foot radius and can cast *detect magic*, *detect invisibility*, and *wall of ice* at will.

Twice per day, they can cast *dispel magic*. Once per day, *power word: blind*, *power word: kill*, or *power word: stun* can be used. The Death Knights can cast *symbol of fear* and *symbol of pain*, as well as a 20-dice *fireball* once per day.

Death knights cannot be *turned* but can be *dispelled* by a *holy word* spell. They have power over and can control undead as a 6th-level evil priest. Their magic resistance is 75%, and if an 11 or lower is rolled on the percentile roll, the spell is *reflected*—at full strength—back at the caster.

The DM should remember that the death knights' magic resistance is rerolled each time a spell is cast at them (if more than one spell attacks a single knight in one round, roll for each). The magic resistance pertains to area effect spells as well. Each of these death knights has a morale of 17 (fanatic) and is worth 5,000 XP.



Dirk Cartel

Black Market Pioneer, Death Knight

AL: CE HP: 100 THAC0: 9
AC: -3 #AT: 5/2 DMG: 1d10 + 10/3d6 + 10
STR: 18/00 INT: 18 DEX: 18
CHA: -2 WIS: 17 CON: 18

The leader of the black market, Dirk Cartel is one of the most feared death knights in existence. He and his three compatriots (all of whom are described below) control the complete black market with an iron fist. He appears as all death knights do: covered with shreds of shriveled, half-rotted flesh, and having two tiny, glowing orange-red pinpoints of lights for eyes. His deep, chilling voice seems to echo from the depths of a bottomless cavern.

Long ago, Dirk insisted that everyone who worked full time with the black market change his given name to Cartel. Since everyone has done this, including his three companions, he is known as the Black Father by the constabulary. This is one way the constabulary can detect a black market employee—or family member. Once in the black market, the individual is stuck for life. (If anyone attempts to get out, the constabulary always find the body in an inconvenient place, even if the victim had been heavily protected.)

Dirk uses a single *two-handed long sword* +4 with one hand, and with the expertise of a master. He also carries a *ring of invisibility* and a *ring of fire immunity*. He uses the *ring of invisibility* to spy upon the constabulary and the House of Commons, but usually he uses the *ring* to make sure that the larger illegal dealings happen as planned. His *ring of fire immunity* is so strong that any magical or nonmagical related fire or heat damage is immediately negated.

Dirk Cartel has not changed his name from the time he was a Solamnic Knight, over 300 years ago. When he found his wife being courted by another man, Dirk lost control of his rage, killing them both. He later was cursed to be a death knight.

In many cases, the most convenient approach is to assume that no problems occur unless the current plotline calls for it. The next most convenient approach is to assume that average delays will depend on the size of the fleet, see table.

No. of Ships

1-2
3-6
7-20
21 +

Daily Movement (in Millions of Miles)

100 M
75 M
50 M
25 M

4: SHIPBUILDING COMPANIES

Lancet Cartel

Black Market Pioneer, Death Knight

AL: CE HP: 90 THACO: 11
AC: 0 #AT: 2 DMG: 1d6 + 6/1d8 + 6
STR: 18/00 INT: 18 DEX: 15
CHA: 4 WIS: 17 CON: 18

Lancet Cartel was a Solamnic Knight from Tarsis. He was soon bored by the everyday activities of the Knighthood, so he traveled southwest to the Ice Mountain Bay, where he was hired as the security mate on the trade barge *Star of Whitestone*. The captain of the barge, Mandauran, was a disillusioned paladin of Kiri-Jolith. Mandauran left the order when he was reprimanded for killing a man who was assaulting a woman. He was told that the actions he took were too extreme, in spite of the violence of the assault. He left the organization, bought the barge, and left Sancrist Island for the mainland.

While on board, the two former Solamnic Knights spoke commonly of the injustices they suffered. One night, their complaints were heard by Kiri-Jolith. The deity cursed them both, rendering them wanderers as well. The two death knights traveled together for nearly one century, when they were attacked by a band of glory-seeking adventurers.

Lancet could not believe the joy and the vitality he felt while in battle. He swung his *short sword of life stealing* deftly, like it held the wind. The seven adventurers quickly fell to his and Mandauran's blades, but at a high cost: the undead Mandauran perished. This battle still lingers in the songs Lancet sings every night.

Sabra Cartel

Black Market Pioneer, Death Knight

AL: CE HP: 90 THACO: 11
AC: 0 #AT: 2 DMG: 1d6 + 6/1d8 + 6
STR: 18/00 INT: 18 DEX: 16
CHA: 4 WIS: 17 CON: 18

If a death knight could have a sense of humor, Sabra would possess it. She can be seen often, deep in thought, breathing deeply with growling undertones. (It is believed the growl is actually a laugh, but no one is certain.) She often reflects on different ways to make the average man scream. Sabra is responsible for the torture devices and interrogation procedures the black market uses.

In combat, Sabra primarily uses a *short sword of dancing*. She is also known to supplement the weapon with either another short sword (when her primary weapon is *dancing*) or a specially-made *dagger of venom* +3 (the +3 applies to Sabra's THACO roll, the damage roll, and also as a penalty to the saving throw vs. poison of anyone struck by the dagger.)

Vex Cartel

Black Market Pioneer, Death Knight

AL: CE HP: 90 THACO: 11
AC: 0 #AT: 3/2 DMG: 1d10 + 9/3d6 + 9
STR: 18/00 INT: 18 DEX: 14
CHA: 4 WIS: 17 CON: 18

Vex Cartel is a mysterious figure. He has never divulged his past life to anyone, even Dirk. Any attempts at *telepathy*, *empathy*, *hypnosis*, or *scrying* by any means (including magical, nonmagical, or psionic), renders no information whatsoever. (Vex's *amulet of nondetection* keeps all divination spells, like *know alignment*, from functioning. The *ring of resistance against scrying and detection* makes him nearly impossible to locate through any means.

In battle, he carries his closest friend, a *two-handed long sword* +3. This weapon is secured by an ornately worked silver-inlaid sheath that keeps the weapon at his back at all times. The hilt sticks up above his right shoulder, giving Vex easy access to his sword when he needs it, while discouraging the efforts of enterprising thieves.

Sometimes, especially the first time or two the players try to coordinate their own movements, the DM can play through the details. If the ships have not practiced moving in formation, each navigator (or helmsman) must make a Navigation proficiency check to avoid accidentally dropping out of formation during a day's travel at spelljamming speeds. If the ships have practiced, only one check is needed, by the least accomplished navigator, to see if there is an incident. If there is, all ships check to see which are involved.

4: SHIPBUILDING COMPANIES

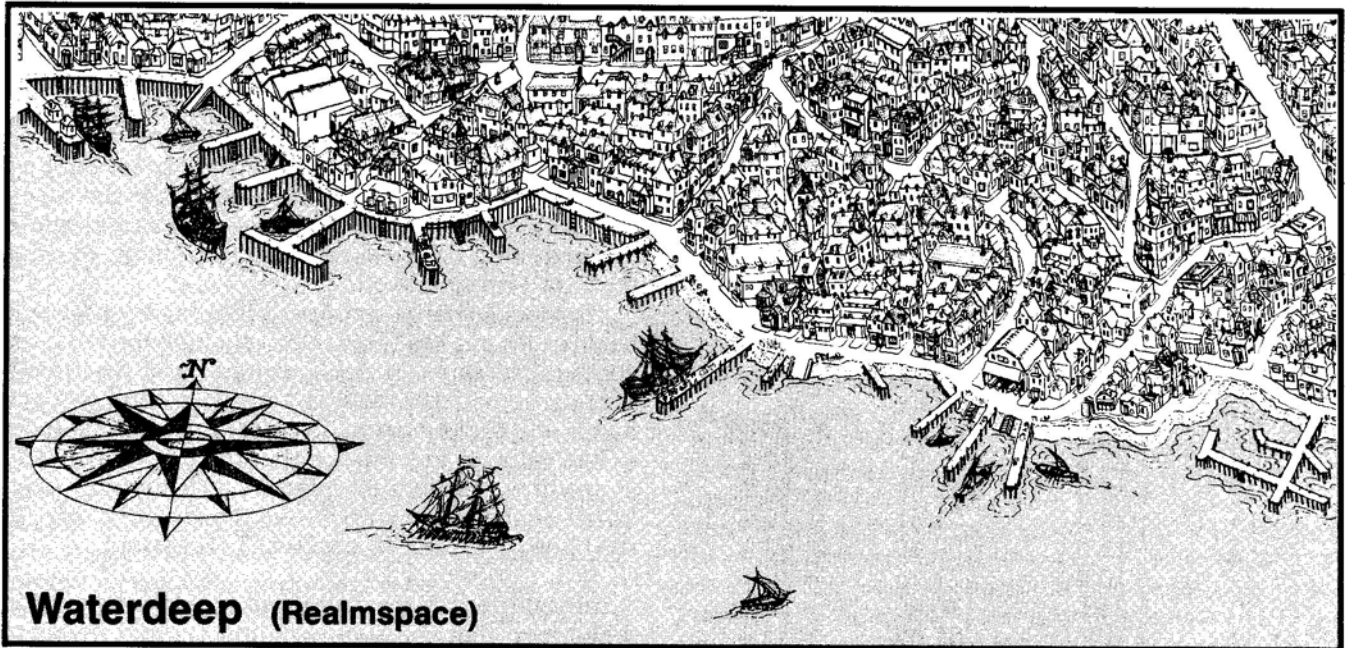

Waterdeep (Realspace)

Realspace

Waterdeep

Toril, the third world in the Realspace crystal sphere, holds the greatest promise of wealth for spacefaring adventurers and tradesmen alike. Located on the Heartland continent of Toril, Waterdeep is known as the City of the North. The second most populous city, Waterdeep has all the glitter and prestige that Calimport, the largest city, deserves yet does not have. Located west of the Anauroch desert, Waterdeep nestles against the Sword Coast and the Trackless Sea. Spelljamming ships, their crew, and their business are welcome.

Over one million people live in this city and the surrounding territories, and they are always looking for interesting objects. Trinkets apparently worthless on one world may be incredibly profitable here. The chart below allows the DM to rate the popularity rating of a new, unique object with a single percentile

die roll. Note that only *new* items (magical or not) should be checked on this table. Standard items like daggers, swords, bracelets, charms, *rings of protection*, etc., will not excite the popular imagination here. A few examples of new objects of interest are *pet rocks* that purr, *self-tying boots*, *carrier pigeons*, or *silk lace gloves* for women. The possibilities are endless and determination of the items' rarity is at the discretion of the DM.

Die Roll	Success	Game Terms
01-05	Condemned	-50% cost
06-11	Criticized	-25% cost
12-20	Unaccepted	-10% cost
21-29	Below Average	-5% cost
30-60	Average	At cost
61-70	Above Average	+5% cost
71-89	Popular	+10% cost
90-96	Acclaimed	+50% cost
97-00	Frenzied	+100% cost

"I just brought this in from a place called Krynn . . . you'll love it. They call it the 'Mage Stones' game and all the wizards there play it. It's easy. Now move in close and I'll show you 'Raistlin's Gambit' . . .".

Overheard in the Dock Ward

4: SHIPBUILDING COMPANIES

Ship Sales: Finer ship builders, repairers, and carpenters make their homes in Waterdeep. With over one million people sharing the air, it is no wonder that some of the best deals can be found here. When a ship enters the Waterdeep port for repairs, many ship companies have their signs posted on poles and walkways, advertising their wares. When the characters seek these companies out, the DM should roll percentile dice against the following table to determine the deal they can make at that location. Negative price modifiers lower the cost while positive modifiers increase the cost.

Die Roll	Price Modifier	Die Roll	Price Modifier
01-05	+25%	51-55	-50%
06-10	+15%	56-60	-40%
11-15	+20%	61-65	-45%
16-20	-15%	66-70	+40%
21-25	-10%	71-75	+35%
26-30	-25%	76-80	+50%
31-35	+10%	81-85	-35%
36-40	-5%	86-90	+30%
41-45	-20%	91-95	+45%
46-50	+5%	96-00	-30%

Port: One word explains the docks, the quays, and the overall view of the city: spectacular. The quays are always neatly swept and stained, the docks are clean and free of floating debris, and majestic trees and ornamental bushes grow right up against the city walls.

Many fine businesses thrive in Waterdeep, but several sleazy operations exist as well. So many people come to the city, even from as far away as the Maztican continent, that any business can sell just about anything at any price and still survive, which explains the widely varying prices charted above.

When a ship approaches the Waterdeep docks, up to five golem-rowed vessels (one for every 20 tons of displacement) approach the craft. The captain on the largest ship hails a friendly greeting and escorts the ship into an empty slot at the quay. The quay can render services for ship no larger than 400 feet in length

(keel) and 100 feet in width (beam).

Ships larger than these dimensions must dock at the Naval Wall, the boundary separating the Great Harbor and the Naval Harbor. At this wall hang four-inch-thick mooring lines. It doesn't quite matter on which side of the wall a ship berths, since the lines extend into the water on both sides. Near the mooring lines, large ladders allow the crews to climb to the path atop the wall, and there are large winches for lifting cargo as well.

The docks charge a copper piece for every foot in keel length per day. This relatively high mooring tax encourages ships to dock, unload, and disembark quickly, sometimes resulting in a wild frenzy of deck hands and broken cargo. Broken cargo that no longer has value to anyone is either left on the docks to clutter the already tight quarters or is dumped overboard as the cargo ship leaves the Great Harbor (to the bane of the sea elf enclave, T'Question).

Information: A few rules and regulations exist in Waterdeep that the spelljamming captain needs to be aware of. Strictly enforced laws require all spelljamming ships to land on the Trackless Sea, miles away from the city. This means that all ships wanting to use Waterdeep as a port must be able to land on water. The government realizes that this law limits the city's economic growth possibilities, but they do not care. All who flagrantly disobey this law are arrested, fined, jailed, and indentured for no less than 12 years and no more than 20 (1d8 + 12).

The people in Waterdeep are very likely to buy items from spelljamming traders if they see the ship sail in from the sky. Since the native traders and store owners cannot compete with such a dramatic entrance, this law was passed. The spelljamming traders can speak all they want to about their voyages into space, and how some nobility on a floating ball of earth and water once owned a trinket or bracelet. The Waterdeep people, for the most part, will just consider the stories as tall tavern tales.

**"Steel? Steel money? Who're you tryin' ta' kid?
Now either pay me in real money
or your boat's gonna sit there 'til it rots!"**

Waterdeep Dock Worker

4: SHIPBUILDING COMPANIES

Personalities:

Kelben Arunsun (Human Wizard 18)
Mage of Waterdeep

AL: LN HP: 45 THAC0: 15
AC: 0 #AT: 1 DMG: 1d4 (dagger)
STR: 14 INT: 18 DEX: 16
CHA: 15 WIS: 16 CON: 16

Khelben, ever working to influence trends and always looking toward the future, has viewed spelljamming as a major breakthrough for Toril. He will do anything to see it continue and thrive. He has personally arranged for spelljamming to appear as a vital necessity for the continued trade-worthiness of Waterdeep. (He is heralded as the father of spelljamming in Waterdeep.)

He stressed the need to actively compete against Calimport, since its ventures are most likely to hurt Waterdeep than any other city on the continent. The love for his hometown (Waterdeep), has sustained him through the years of heartache and ridicule his demands and constant public appearances to bolster support for spelljamming have brought him.

Khelben can be seen touring the docks, looking at all the unusual spelljamming ships that pass through. He likes to line draw the ships in a large tome labeled *Soul d'Art*. In the evening, he returns to his study and paints the art with pastel colors. He has painted over 100 different ships to date. (Khelben's art book is worth 800 gp.)

Lately, Khelben has been turning his sights elsewhere—outward, so to speak. The planes (and traveling to these unique locations) have been of major interest to him in recent years, and he sees this as the next major wave. (He has plans to introduce a *planar port* in Waterdeep, but he thinks he will have major problems introducing it to the Waterdeep officials. The concepts of spelljamming were difficult for the dignitaries to envision. Imagine the challenge he has to make the officials accept planar travel!)

Vladimir Duarte
Dock Sanitation Chief

AL: LN HP: 5 THAC0: 20
AC: 9 #AT: 1 DMG: 1d2 (fists)
STR: 09 INT: 11 DEX: 16
CHA: 12 WIS: 13 CON: 12

Vladimir has thirteen people under his direction, who constantly tour the Waterdeep docks, cleaning the refuse left behind by careless tradesmen. He has performed the chief duties for 17 months to date, after serving as a sanitizer for nearly 20 years. Vladimir still performs sanitizer duties, but only during daytime hours. If he, or any of the other seven people on duty, catches anyone leaving filth or rubbish on the quays (5% chance per refuse dumping), he apprehends and detains the miscreant until a constabulary official approaches (after 2d4 rounds). When the constable arrives, he fines the character 2 gp if he admits to dumping with intent to leave without cleaning up after himself.

Justina Sittas
Tax Collector, Administrator

AL: LN HP: 8 THAC0: 20
AC: 6 #AT: 2 DMG: 1d2 (fists/kicks)
STR: 12 INT: 13 DEX: 18
CHA: 17 WIS: 9 CON: 10

This beautiful woman may end up being the player characters' greatest nemesis. Her job includes approaching every ship in the docks, every day, to collect dock taxes. If taxes are not paid, she insists that the ship leave immediately. If the tax evaders refuse to leave the premises of the docks, she calls the constabulary, who arrive in 2d10 rounds

Constables (2d4): Int Average (8-10); AL LN; AC 8; MV 12; F3; hp 20; THAC0 18; #AT 1; Dmg 1d8 (scimitar); SA nil; SD nil; MR nil; SZ M (6' tall); ML Steady (11-12); XP 120 each.

"The first mate always told me to aim for the weapons or the crew, but I don't think he ever used a ballista or a catapult. You're lucky if you can hit an enemy on their broadside with these things."

Dairn, Emerald Brotherhood Company

4: SHIPBUILDING COMPANIES

Evermeet

Evermeet, a small island group, lies deep within the Trackless Sea, several thousand miles west of the Heartland continent. Araksa, Sumbrar, Belinholme Island, and Evermeet itself, are the four main islands (in reverse-size order).

It is a splendid land, filled with wondrous forests, and beautiful waterfalls that cascade thousands of feet into large, life-filled ponds. This is the final home of the Elven Nations. The art, music, and magical research are all much more advanced here than anywhere else on Toril, and the elves do their best to protect what they have.

Ship Sales: Ships are sold only to elves who captain elven crews on elven ships. This explicit disregard for other humanoid races is not merely a demonstration of their naturally contemptuous nature (which, of course it is), but rather a "them against us" attitude that permeates their very beings. They fear that their meticulous policing of the space trade routes is justified, but they realize that it irritates the privateers and pirates and other well-meaning non-elves. All elven ships (and that is all they have) are sold for 10% under the going price listed in the *Ship Recognition Manual*, to elves only.

Port: Evermeet Island, the largest in the island cluster, has many port cities across its outer perimeter. The capital city, Leuthilspar, is the largest city and the finest choice for a port of call. Other cities like Elion, Luirund, and Ruith, are excellent alternatives as well.

Elves manning elven-crafted ships are allowed to moor their craft without charge, and they can stay indefinitely. Elves who use non-elven ships must pay a docking fee equal to one silver piece for every ton, and they must pay this amount every day the craft stays in port. If non-elves dock at any port city while using an elven craft, the ship is confiscated and the whole crew and the cargo are *teleported* to a point just outside the Waterdeep docks.

Information: All elves except drow and half-elves are welcome at Evermeet, and many sea-elves live within the cool surrounding waters. Humans, other demihuman races, and unhumans are never allowed within sight of the island. Using twelve or more *spelljammer detectors*, the elven fleet constantly patrols the area, looking for intruders.

When trespassers are detected (always, within ten miles of the island), a dozen or so Armadas approach the ship. Elven ships are allowed free passage; other intruders are instructed to turn back or be destroyed. If the ship does not turn back, the elves open fire for one to three rounds. If this does not deter the non-elves, they will be attacked and destroyed.

Elven ships come in a variety of shapes and sizes, but one of the more popular patrol vehicles is a double-hulled catamaran scout ship with three mainmasts. These small craft run across the waves, making sure no one breaks the constant naval blockade surrounding the islands. Over 200 such craft are on patrol in the ocean at one time.

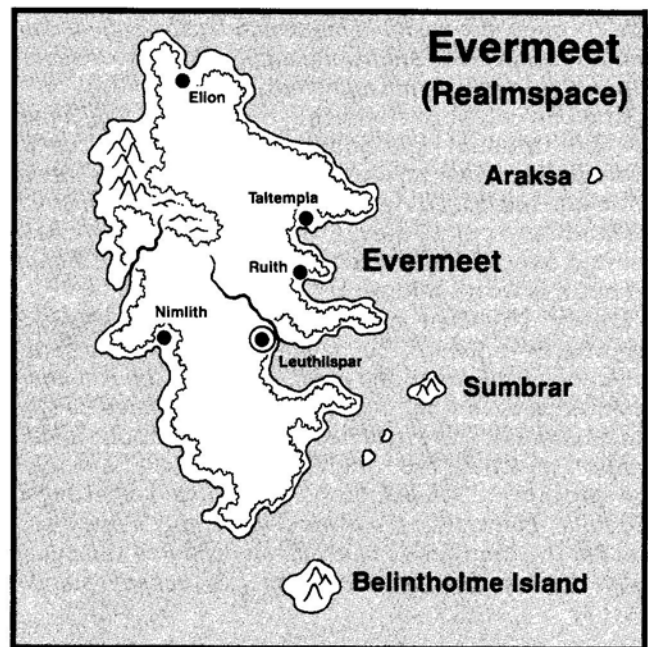

The Evermeet Blockade

The elves of Evermeet protect their base with an efficiency that borders on fanaticism. Any flying ship coming within 100 miles will be stopped and turned back by elven patrol ships. Only full-blooded elves are normally allowed in (unless the situation is truly exceptional, from the elves' viewpoint). Those who try to force their way past the blockade face destruction.

4: SHIPBUILDING COMPANIES

Ship Name: Catamaran/Scout
Built By: Elves of Evermeet
Used Primarily By: The Elves of Evermeet
Cost: 500 gp
Tonnage: 5-8 tons
Hull Points: 5-8
Crew: 10/10
Maneuverability Class: B
Landing-Land: No
Landing-Water: Yes
Armor Rating: 8
Saves as: Thin Wood
Power Type: Nonmagical sails or oars
Ship Rating: 1
Standard Armaments:
2 Medium Ballistae (FP, FS)
Crew: 2 each
Cargo Capacity: 2½ to 4
Keel Length: 30'
Beam Length: 10'

Another phenomenon is a number of *spheres of annihilation* that randomly orbit in the air over Evermeet. These spheres are invisible and can be completely avoided only if the onlooker possesses some means to detect them. Those who can will see perfectly spherical, clear objects that move by their own power. Those who cannot see the spheres have a 5% chance per turn to run into one of them.

Ramming a *sphere of annihilation* causes the front 5% to 20% (1d4 × 5) of the ship to disintegrate. The spelljammer helmsman immediately falls into Spelljammer Shock (no saving throw) and the craft begins to fall to the ocean below. Unless someone else takes the helm, the ship will crash into the ocean in only 2d4 rounds.

Rumors that the Evermeet elves have created a new ship called the *Dirge* are yet unfounded. If correct, this ship is much larger than the elven Armada. If, some day, the ship takes its place as the mightiest elven ship, then it may be time to sing a requiem for the enemies of the elves.

Personalities:

Serin Ghar (Elf, Ranger 15)
Admiral of the Evermeet Fleet

AL: NG	HP: 92	THAC0: 6
AC: 5	#AT: 2	DMG: 1d8 + 1
STR: 17	INT: 18	DEX: 14
CHA: 17	WIS: 19	CON: 12

Serin Ghar is a beautiful elven woman in her middle age. She has at her command every catamaran/scout patrol, every elven armada, and every other non-private ship Evermeet has in its possession. She is the most public figure in the fleet.

Called by her full name as if it were but one, Serin Ghar is synonymous with loyalty and honor. She is known by every elf on the island, she is the idol of every young woman and the preoccupation of every young male.

Slow to anger yet quick to act, she is not a figure to be trifled with. When on patrol, she commands an elven Armada armed to the teeth with the most advanced weapons available. At this time, her craft sports twenty-one heavy weapons.

Cuthwahl Cuthbert (Elf, Wizard 15)
Master of Transportation

AL: LN	HP: 36	THAC0: 16
AC: 10	#AT: 1	DMG: 1d4 (dagger)
STR: 11	INT: 19	DEX: 11
CHA: 14	WIS: 19	CON: 10

Cuthwahl Cuthbert is an elderly yet virile elf, whose main duty is to remove unwanted trespassers from the Evermeet isle. He and three assistants control a device that can teleport nearly 10 tons of cargo and crew from Evermeet to the Waterdeep docks. A quiet and loyal servant of Serin Ghar, he occasionally affects an air of doddering senility. He will use his device only under direct orders from Serin Ghar or the island officials.

Elven Battlepoets

Most elven warships of 20 tons or more will have a special officer, the battlepoet. This officer has the abilities of a bard of equal level. The level of the battlepoet is usually equivalent to that of the other middle-rank officers on the ship, and large ships may have more than one battlepoet. In random encounters with elven military ships, there will be a 4th level battlepoet for every 40 elves. If 80 or more are encountered, there will also be a 7th-8th level master battlepoet.

4: SHIPBUILDING COMPANIES

The Dock

Wu Pi Te Shao is the name of the mountain range that separates Shou Long from the Great Sea. Here, in the middle of the largest glacial ridge, lies an arcane base called The Dock. It is the strangest spelljamming port on Toril and a free trade zone with a charter from the Shou Lung Emperor himself.

The Dock has over three hundred separate dry docks (mooring platforms) for spelljamming ships of 300 tons or less. There are notices of all sizes and in many languages posted across The Dock's mooring platforms, or cut into the glacial ice of the surrounding ridges, that invite ships stop and visit the "Only Arcane Trading Post on Toril."

The Dock has an indoor bazaar where everything imaginable is sold, sometimes even at bargain prices. Occasionally, the neogi show up to purchase items of value and to sell the slaves they no longer wish to keep (or eat). When a spelljamming mage is looking for a crew in this part of the world, or a crew member is looking for a ship, the most likely place for him to look is at The Dock. This is where the majority of crews are thrown together. The place has become a thriving, bustling, polyglot settlement, overrun with coin-hungry, quest-seeking adventurers and traders from a multitude of worlds.

Ship Sales: The arcane sell more ships in this port than anywhere else in Realspace. Curiously, not a ship of theirs can be found until a sale is made. The arcane will sell any ship in the *Ship Recognition Manual* except the following:

Argosy, Armada (including *Monarch-class*), *Batship, Battlewagon, Bolaship, Caravel, Citadel, Coaster, Deathglory, Dromond, Flitter, Galleon, Great Bombard, Jade Spider, Jade Spider Commandship, Leech, Locust, Mammoth, Man-O-War, Quad of Thay, Quentin's Libraria, Radiant Ship, Sidewheeler, Space Leviathan, Spelljammer, Stoneship, Scalpel Ship, Tsunami, Urchin, Uspo, Vagabond, Vulkarus, Whelk, Wraithship, Yawl, and Yawl Wagon.*

At The Dock, the arcane sell their ships for 10%

less than they are listed in the *Ship Recognition Manual*. This discount is designed to attract the adventurers and ship captains who are scared away by the high taxes that The Dock charges for anchorage. (This also assures that their ships are the ones bought and sold, giving them a monopoly.)

Port: When a ship docks, magical *tether ropes* and docking mechanisms guide the vessel into a safe and secure docking position. A dock hand with two glowing wands guides the ship into the mooring facilities. Once the docking procedures are complete, the ship's crew will meet a thin man carrying a briefcase made from the skin of some unfortunate reptilian creature that has seen the worse for wear. This man immediately demands the sum of 1 cp per ship ton as a dock maintenance tax. If the characters refuse to pay the tax, he demands their ship leave immediately. (The thin man can produce impressive-looking credentials on request and can, after due process, have the port authorities seize or seal the ship if he is ignored.)

When this tax is paid, the man asks the characters if they wish to purchase docking insurance at 1 sp for every ten tons of their craft. The insurance guarantees the characters a replacement of materials stolen, destroyed, or damaged while their craft is moored at The Dock. If the insurance is not paid, the character's ship might suffer unexplainable fire or hull damage. (The odds are 10% that something will happen during their stay if they refuse.)

Once the dock maintenance tax is paid, the crew is encouraged to bring their goods to the bazaar located at the center of The Dock. The seller is charged an import tax on any trade goods he removes from his ship. This tax is 2% of the total worth of all items. The tax agent (again, the thin man with the briefcase) has a complete list of every imaginable item and its estimated worth, and taxes are levied according to that list. The prices are accurate and continually updated. Once the tax is paid, these items can be carried to the bazaar for sale. All items sold at the bazaar are taxed at 10% of their value, but this sales tax is paid by the purchaser.

Insurance at The Dock

While insurance at The Dock is a reasonable way to cover accidental or minor damage, it does not and cannot cover everything. Gaps will be found if the buyer would but ask. Acts of war or the gods, curses, and the baneful effects of artifacts are excluded. Ownership of items claimed as stolen may need to be proved. Official investigations may be lengthy. Plaintiffs may have to submit to magical scrutiny themselves. Occasionally a minor agent or official will have been bribed to block or end the process.

4: SHIPBUILDING COMPANIES

Once the traders have sold all they can, they can either choose to return all items to their ship or they can pay for the services of one of many storage companies that have sprung up at The Dock. These companies, under the direct supervision of the arcane, charge 1 cp per ton of cargo per month. If the rent payment is even one day late, the items stored there may mysteriously disappear. The rent can be paid months or even years in advance. In fact, this is the preferred method of payment. (Rumors persist of a human mage who paid two centuries in advance for a 400 ton unit storage facility.)

When the crew is ready to leave The Dock, they must pay a 1 sp dock fee for every day their ship spent in the docks. This rental fee pays for the policing of the area, the tax agent wages, and other miscellaneous expenses. If this last tax cannot be paid, the characters are banned from The Dock area (without their ship) until the debt is made good.



Information: Food is expensive here since the facility does not have land to grow crops. Most of the food is sold by merchants. The arcane are known to purchase food from these traders, as well, and then sell it to The Dock's visitors and residences at ten times its normal price when no other sellers are available. The water they sell is in the form of frozen blocks of ice carved from the glacier. They do not take the time to melt it for the buyer. Unfrozen water can be bought at The Dock for 1 cp per glass.

Personalities:

Calabrie Zhentle Arcane

AL: LN	HP: 80	THAC0: 11
AC: 3	#AT: 1	DMG: 1d8 (weapon)
STR: 15	INT: 18	DEX: 13
CHA: 12	WIS: 17	CON: 14

Calabrie Zhentle is the presence behind the other arcane in The Dock. All buying and selling deals with any arcane must have her seal before they are final. She will allow the arcane to sell spelljamming ships for as much as 10% under the price given in the *Ship Recognition Manual*, but all spelljamming helms are sold at the stated price—no discount whatsoever.

Many believe that this tall, blue-skinned giantess controls every aspect of The Dock's operations, but this rumor is unconfirmed. She is certainly a highly respected citizen, and does seem to have authority over everyone else of her race.

She has two human body guards of superb fighting ability. Their names are Shoah and Jor Demyse, and they are synonymous with catastrophe. Together, these two warriors are capable of stopping almost any assault against Calabrie Zhentle. The more-than-generous salary she affords them assures their continued support. These two body guards are detailed below.

Some unscrupulous small insurers create contracts with obscure clauses and exclusions that render them all but worthless. However, many pitfalls can be avoided carefully asking the right questions in the right quarters. Purchasing insurance is as much a matter of good form as protection, and protected ships are rarely troubled by accidents in loading or provisioning, or by acts of petty theft.

4: SHIPBUILDING COMPANIES

Jor Demyse (Human Fighter 10) Bodyguard

AL: N (NE)	HP: 100	THACO: 11
AC: 0	#AT: 3/2	DMG: 1d8+5
STR: 18/94	INT: 14	DEX: 15
CHA: 5	WIS: 7	CON: 18

Jor Demyse is a homely young man who lacks the wisdom to save his own skin. He is a brawler and a dangerous opponent in combat, however. He wields an unusually long sword—a *long sword* +2—that improves his THACO to 9. A man of few words, he can carry on an intelligent conversation, but he is blunt enough to offend everyone around him. Calabrie hired Jor Demyse some time ago on the recommendation of his former captain. Jor was a cargo barge guard officer for three months until the captain grew tired of having to perform weekly memorial services. Jor is now well paid and very happy with his job. He gets to meet new people and can still use his considerable combat skills on over-ambitious and none-too-bright adventurers.

Shoah (Human Fighter 9) Bodyguard

AL: N	HP: 78	THACO: 12
AC: 0 (-1)	#AT: 2	DMG: 1d8+3
STR: 18/25	INT: 11	DEX: 18
CHA: 13	WIS: 12	CON: 15

Shoah, an exotic warrior from an unknown land, adorns himself with the 1½ feathers of a “reptilian hunter.” As every male in his tribe, he had to pass from childhood by slaying one of the beasts and then sewing a set of armor from its greenish-gray feathers. Now that he is fully grown, he has kept a similar set of armor that gives him a base armor class of 4.

Shoah wields a pair of 3½-foot-long halberd-like blades that he uses with the dexterity of a surgeon. In close combat, he often braces their shafts against his forearms and pirouettes like a dancer. This unusual fighting style gave him the nickname *Deadly Dancer* (the style betters his AC to -1.) Shoah claims his name means *Destruction* in his native language. His friends believe it.

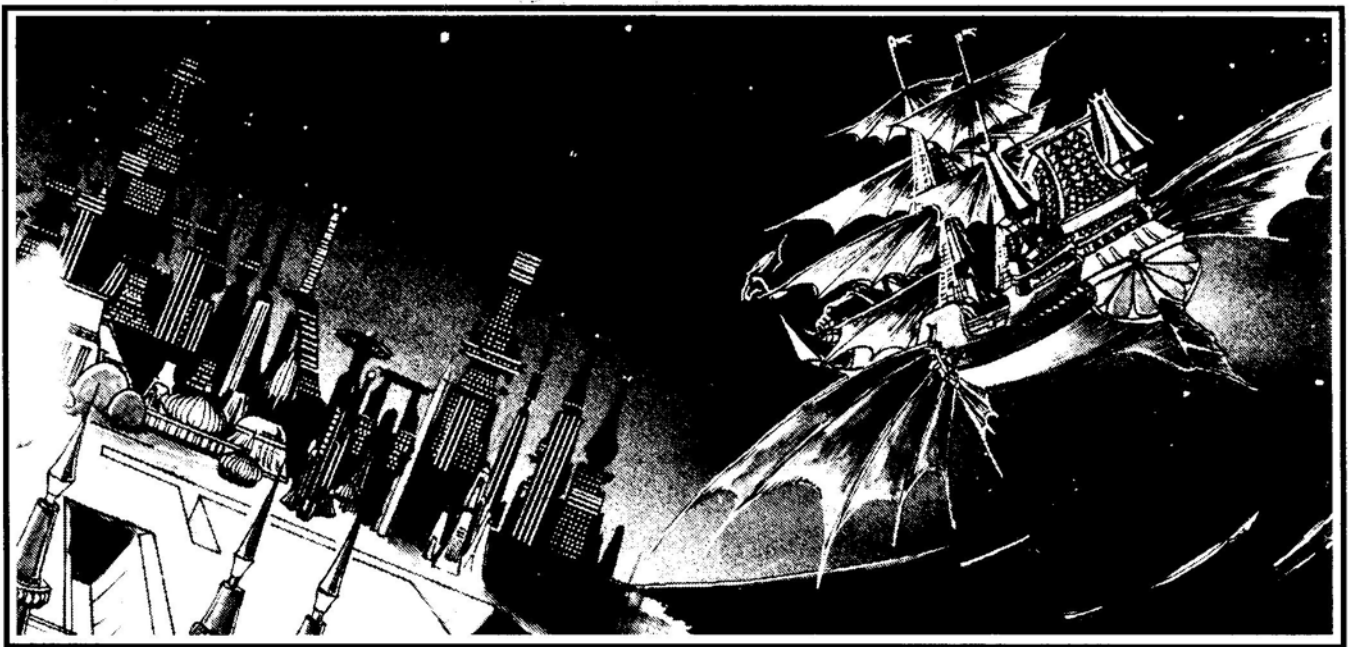

“My old captain tried to avoid the dock fees, once.
That’s why I have a new captain.”

Sharondel, Gauntlet Company

5: SHIP CONSTRUCTION

The players and DM can experiment with new spelljamming ship designs themselves, or they might handle ship design as a campaign activity undertaken by the player characters. Either way, the basic factors of ship design are *tonnage*, *cost*, and *time*. (If player characters are designing their own ship, see the section, Ship Plans and Architecture).

Tonnage determines ship size (by limiting the size of the air envelope), minimum crew size (a function of minimum rigging needed), maximum crew size (the amount of air available), the type of spelljamming helm that can be fitted, the number and type of ship-mounted weapons carried, and how much cargo space is available.

Cost is determined by the materials used in the ship's hull (which determine Armor Rating and saving throws). Some special costs are keyed to tonnage (such as rigging and any ram fitted).

Time is the amount of time needed to build, repair, or modify a ship. This comes into play in an ongoing campaign, when the activities of many characters need to be coordinated.

Page 93 of this book displays a Ship Record Sheet. Photocopy this sheet and outline the newly crafted ship's statistics as it is being constructed. The players can easily keep track of pertinent ship data, rendering the DM's job just a little bit easier.

Ship-Building Sequence

1. Pick tonnage; determine hull size and cost
2. Determine AR and saving throws
3. Add ram if desired
4. Determine MC and rigging required
5. Determine maximum/minimum crew size
6. Select helm type
7. Determine ship-mounted weapons
8. Customize as desired

Ship Tonnage and Hull Construction

Select the size of ship desired. Table 5-1 equates general ship types with tonnages.

Hull Size: The easiest way to decide on a ship's size is to find an existing ship with a similar hull shape and use that general layout and tonnage. The deck plan from an existing ship (like the Hammership) can be used, or a new one can be created. If a new shape is desired, the DM should oversee the process. The cost of creating a hull varies widely with the materials of which it is made (see Hull Cost).

(The maximum dimensions of a new ship can be derived from its tonnage, since a "ton" is defined as 100 cubic yards of volume. To figure a ship's dimensions, picture a cube of volume equal to the ship's, then slice it up into "building blocks" from which the hull is formed. In short, multiply tonnage by 100, find the cube root (to convert the cube's volume to its side length in yards), then multiply by 3 (to convert yards to feet, rounding off). Thus, a 100-ton ship can be shaped from a cube 65' on a side. The cube sizes for various ship tonnages are given in Table 5-2 on page 65.

The dimensions of the basic cube can be altered as desired (e.g., a 30' cube can be shaped in several ways: 90' x 30' x 10', 50' x 27' x 20', 125' x 18' x 12', etc.). Final sizes can be rounded down to the nearest 5 feet for ease of figuring.

Note: A ship's deck should measure at least 10' of vertical space (double for giant-sized creatures). Thus, the minimum height of a three-deck ship would be 30'.

Hull Cost: To find the cost of manufacturing the hull, multiply the ship's tonnage by the base cost on the Hull Cost table. The AR column gives the base Armor Rating of the material.

The costs can be altered by a material's scarcity, and by the availability of qualified craftsmen. The DM can change the costs as desired. If other materials are made available in the campaign, their values

The instructions for assembling the fold-up ships in the *War Captain's Companion* are in the *Ship Recognition Manual*, page 63.

5: SHIP CONSTRUCTION

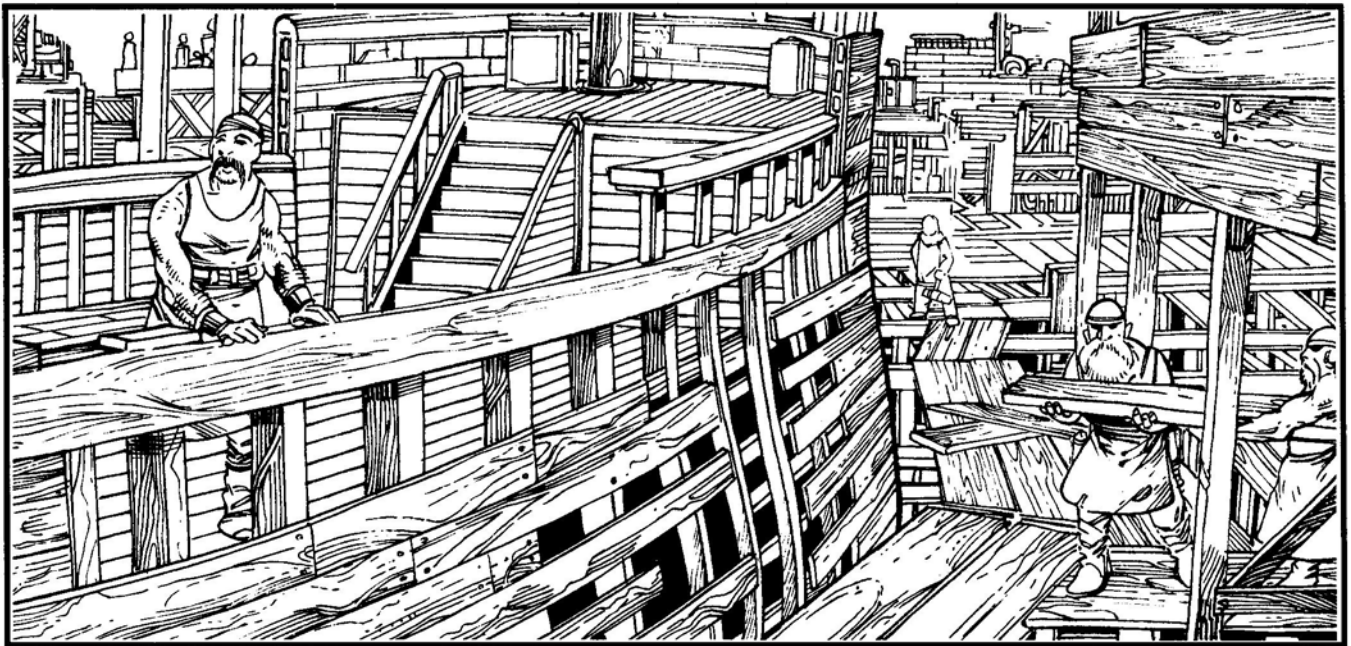

should be set according to the base Armor Rating and base MC of the substances. The tables assume human capabilities and construction methods.

Creating a craft from precious gems or metals does not necessarily give any bonuses to its statistics. Much expensive construction is mere window dressing—the kings and queens from the richest of worlds often place the prestige of their pleasure craft before its performance.

Time: The basic time required for new construction is one day per ton in a drydock capable of handling ships designed for spelljamming operations. Some spelljamming cultures can reduce the time required by up to one-half. The arcane can reduce this time even more, if they are working on a familiar and standardized design.

If sub-standard facilities are used, or if the required specialists are not available, the time required might be one-and-a-half, twice, or even more times the base period.

New construction is treated quite differently than repairs for cost and time. The ship builders are much more interested in building new ships than in fixing old ones, and this is reflected in their charges and in the priority they give the work.

Armor Rating and Saving Throws

Ships will have a basic Armor Rating and a basic saving throw (see tables on pages 65-66).

Most of the time, the construction material determines the Armor Rating and base saving throws of the ship. If unusual circumstances apply (for example, if a the builder experiments with a combination of materials), then the DM decides the base AR and saving throws of the ship. Sometimes, both AR and saving throws can be modified, but at a great price (see the Ship Improvement chapter for more information). Some modifications will be mutually exclusive.

These values should be recorded on the ship's Ship Record Sheet. The values may change during

Ship Fold-Ups in *War Captain's Companion* boxed set:

1 Battlewagon

4 Eel Ship

2 Mantis

1 Deathspider

1 Leech (on Kindori)

3 Mindspider

1 Dromond

3 Lamprey

2 Nautiloid

5: SHIP CONSTRUCTION

testing if the optional Ship Architecture rules are used.

Rams and Ship Construction

Many spelljamming ships designed as warships have rams. Such ships tend to have long keels and narrow beams. See Table 5-8 for costs.

Single and Multiple Rams: Ram-armed ships, as a rule, have only one ram; ships like the Dreadnought and the Squidship are exceptions. A double ram is not noticeably more effective in combat than a single ram, and the costs for installation are comparable. The fitting of a stern ram in addition to a bow ram requires additional strengthening and must be paid for separately.

Maneuverability Class and Rigging

A ship designed for spelljamming operations has a base Maneuverability Class that corresponds to its material (see Table 5-9). If the ship is a groundling vessel with a spelljamming engine patched on, the ship has a rating of MC F.

A ship over 60 tons has a penalty of one class (MC D becomes MC E); a ship under 5 tons has a bonus of one class (MC C becomes MC B).

A ship can be given "standard rigging", "no rigging", or "special rigging":

Standard rigging means approximately 1/10th of the ship's tonnage is made up of rigging and sails, giving the ship a +1 bonus to MC (a rating of MC D becomes C). This costs 100 gp per ton of the ship.

No rigging means the rigging expense is saved, but the MC of the ship will be one class worse.

Special rigging for some ships, like the Triop, do not affect MC, but confers some special movement ability. The decision as to the effectiveness of such gear is up to the DM.

Rigging adds one step to a ship's Maneuverability Class. If the characters do not want the rigging, use the ship's MC from Table 5-9.

Most ships can have their maneuverability raised by simply adding more rigging (see "topping out" in

the Ship Improvement chapter).

Crew Size

The number of crew a ship can safely hold is always **equal to its tonnage**. (Safe transport is equal to four months of possible travel time before the air turns foul.) The minimum number of crew a ship needs to properly function (without MC penalties) is the first number of the Crew entry in the ship statistics section of each ship description.

Crew Minimum: Generally, it takes one crewman per ton of sails. In other words, if a coaster is 20 tons, it has 2 tons of sails, requiring two crew members (*deck crew* or *sailors*) to maneuver the sails. The captain, officers, helmsman, and navigator are added to the deck crew to get the minimum crew size. If the minimum crew is not available, the ship's MC class is lessened.

Crew Maximum: Spelljamming craft have 100 cubic yards of air per ton of ship. This air has enough oxygen to support one man-sized crew member for four months. Creatures and characters of different sizes use different amounts of air (see Air Envelopes section).

Weapon Crews: The number of crewmen a ship needs to man all weapons is determined by the number of weaponeers needed per weapon carried (see Weapons Table on the back of this book). Weapon crews are *not* included in the minimum crew needed to maneuver the ship. Most ship designers make sure that the number of the minimum crew and the weaponeers fall within the safety limit, but some do not. (The giff Clipper, for example, typically carries only half the full complement of weaponeers).

Helm Selection

Most ships of 50 tons or less are equipped with a minor helm. Most ships of greater than 50 tons are equipped with a major helm. Some helm types are typically used by specific races, and some are so rare as to be effectively unique (see Tables 5-10 through 5-12, pages 66-67, for details).

1 Battle Dolphin
1 Dolphin Shuttle
2 Triop
1 Vipershup

2 Angelship
2 Cog
1 Octopus
2 Dragonship

1 Batship
1 Great Bombard
1 Man-O-War
1 Smalljammer
1 Yawl + Wagons

5: SHIP CONSTRUCTION

Weapon Selection

All spelljamming vessels are capable of carrying large weapons. The craft's size determines the amount of space that can be dedicated to weapons.

Only one-half of the ship's total tonnage can be used for weapons. (Exceptions do exist, and are dealt with in the next chapter.) All ships, however, regardless of their size, are able to carry at least one light weapon.

The addition of weapons does not increase the overall tonnage of the ship. For example, an elven Flitter, being a 10-ton vessel, can hold up to five tons of armaments. It might have one heavy and one light weapon, one medium and three light, or five light weapons (the DM should make sure that there is actually enough room on the ship to mount the weapons).

Most of the weapons listed on the Weapons Table are detailed in the SPELLJAMMER™ Boxed Set, *Adventures in Space*. Those that are not, however, are detailed under New Magical Items (Chapter 7).

Turrets: Normally, ship-mounted weapons only fire in a limited arc, depending strictly upon their placement. A weapon mounted at the rear of a craft can only fire in the aft firing arc; a weapon that points off to the starboard can only fire in the starboard arc. Turrets are rotating platforms that allow weapons to be turned to face different targets quickly.

Protected turrets: These turrets provide shielding for the weapon crew. They are double the cost of standard turrets, but give the weaponers' armor class a -4 bonus. Table 5-15 gives the cost of turrets. (Magical turrets with additional armor class bonuses are available for exorbitant prices; see the New Magical Items chapter for more information.)

Dual-mount turrets: A dual-mount for a large ship-borne weapon does not increase turret size; a dual-mounted medium ballista takes a medium turret. If the players wish to develop unusual mounts, the details must be approved by the DM.

Examples of Ship Design: The Hammership, for example, is a smartly built ship. Weighing 60 tons, it

can safely hold 60 crew members, and it has a minimum crew of 24 individuals. Its three weapons (two heavy catapults and one heavy ballista) require 14 weaponers to man all three. Added together, this means 38 crew are necessary to run the ship and man the guns. Subtracted from the 60 crew maximum, the Hammership has 22 reserve crew members, should any "working" crew die for one reason or another.

The Clipper ship, a giff spelljammer, however, is not a smartly built craft. It weighs 65 tons with a minimum crew of 18. With 26 bombards, it requires 78 crew members to run just the guns! This means a total of 96 crew members is needed to run everything—nearly 50% higher than the ship's safe limit of 65.

However, most giff Clipper ships have 65 crew members. During moments of peace, the crew loads all the bombards. A single crew member stays with each of the 26 bombards, ready to fire at a moment's notice. Inefficient, but it works for the giff.

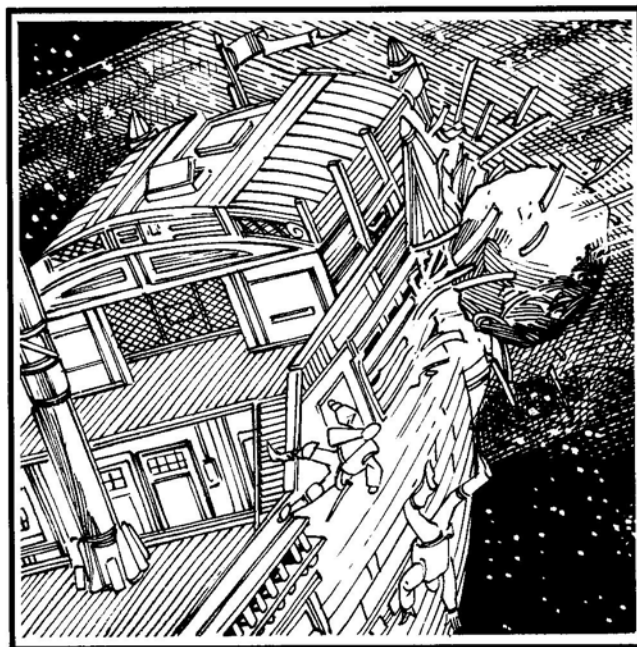

More ship fold-ups can be found with the SPELLJAMMER™ DM's Screen (#9313):

3 Damselyf
3 Dragonfly
2 Dragonship
1 Deathspider
6 Flitter
2 Galleon

2 Hammership
2 Man-O-War
3 Mindspider
3 Nautiloid
3 Scorpion
2 Shrikeship

1 Sidewheeler
2 Squidship
3 Tradesman
3 Tyrant (different)
2 Wasp

5: SHIP CONSTRUCTION

Ship Design and Architecture

This assumes that the players have commissioned or designed a new ship type and wish to build it. The stages of design are: planning, building, and the shake-down cruise.

For the planning, a shipwright-engineer with spell-jamming design proficiency must be hired to oversee the project at an engineer's salary. Only one such engineer can work on a design at one time. Completion of the plans for a design takes as long as building the prototype. Once the plans are complete, the ship can be built at the standard costs and time.

Once the construction is complete, the ship must sail on a shakedown cruise of at least two weeks. At

this time, the DM rolls 2d6 for MC and 2d6 for AR. One die of each pair is a "plus" die and one die is a "minus" die. If the total is plus 2 or more, upgrade the MC or AR by 1 (superior design). If the total is -2 or less, reduce the MC or AR by 1 (design flaw). If the total is 1, 0, or -1, the MC or AR is as designed. An MC worse than F or AR worse than 10 means the design is fatally flawed and must be abandoned.

Once at least three shipwright-engineers have established a design with identical plans and identical generated statistics, the ship becomes generally available for volume production. The arcane, if presented with a prototype, may adopt and produce the design sooner if the DM chooses.

Optional Ship Design Bonuses

If the DM wishes, each race has its own special adjustments that apply to the craft it constructs:

Aracokra: +1 SR; +1 AR with wood.

Arcane: Up to +3 overall, on any stat or combination of stats; build for others.

Beholder: Unique ship design and weaponry.

Drow: Adamantite hulls and repair facilities to work this material.

Dwarf: +2 AR with stone or gem materials only.

Elf: +1 MC if hull grown; MC A if under 5 tons.

Giff: 75% of hull tonnage can be used for weapons if half or more are bombards.

Gnome: +1, 0 or -1 (roll) on MC and AR; mechanical helm or power source.

Goblin: +1 AR or MC.

Halfling: +1 AR or MC.

Human (general): +1 AR or MC, or one special (aka Triop, Vipership)

Human (groundling): -1 AR, MC F when standard rigged.

Human (Wa): +1 MC; double construction rate with thin wood.

Illithid: +2 AR with thick wood; has MC as if rigged without standard rigging.

Lizard Men: +1 AR.

Neogi: +1 MC; grapple/ram; lifejammer.

Scro: +1 AR or MC; claw-ram; usually doubles up on assigned crew.

Thri-Kreen: +1 MC; ships under 4 tons are MC A.

Vodono: Weapons have double range if manned by Enforcers/Destroyers; no greek fire.

If the ship is being designed by a shipwright-engineer, the design specifications must be within the parameters for *both* the constructing workers *and* the shipwright-engineer. If the builders' races are mixed, the shipwright-engineer must make a successful engineering proficiency check at half his ability score to include the parameter in the design. Only one race's bonuses can be built into a design.

For example, if a human shipwright is working with the illithids, the design can include a +1 AR bonus at no penalty if the material is thick wood, because either race can do that. If he wants to build a very strong +2 AR wooden hull (an illithid bonus), he has to make an Engineering proficiency check at half his Intelligence to get it right. Likewise, if he wanted to build Triop fins (a human bonus).

"... ah-ah ... ah-ah-ah ... AH-CHOO ... (*snuffle*)!"

Sarelk the Sage

(When asked if he was enjoying his trip on an aarakocra Corbina.)

5: SHIP CONSTRUCTION

Sails and Culture

Many races in Wildspace view sails as a demonstration of culture and attitude:

- The elven ships are grown from living plants. They have beautiful, lacy sails that form monastic and fragile wings over their ships, imparting an air of delicacy and elegance. Natural beauty and aesthetics are the highest goals of elven design.

- The giff prefer a stout burlap material for their sails, giving the ships a feel that is robust and primitive, yet on the fringe of civilization. "Aesthetics are for the elf," is a favored insult among the giff. The giff favor the hard-edged, shin-scraping utility that leaves little room for comfortable lounge-chairs or padded railings. They can use 75% of their tonnage for weapons in bombard-armed ships, and their gun crews are usually crack troops. If they have access to *smoke-powder*, the air is likely to be soot-filled as well.

- Aarakocra ships are unmistakable. The aarakocra and their avian kin alike use feathered hides and cloth to catch the magical currents of the spelljamming helm. Their ships are inherently faster than most designs (+1 SR bonus) and riding in one is a most interesting experience. Their lurching, fluttery motion, as they bounce through space like a ball on a string, sheds feather down and fluff, surrounding the ship with a cloud of itchy white. Not only can this be disconcerting to those unaccustomed to it, but those subject to attacks of vertigo or allergies may find a voyage on an aarakocra ship to be an uncomfortable, or even nightmarish, journey.

- The goblinkin ships are dirty and unkempt. Their sails are often patched or tattered, and sometimes are made from the flayed skins of their enemies. The goblins have a tendency to throw their rinds, bones, and uneaten food thrown all over the decks. The stench is incredible. Disease and sudden death are commonplace on goblin ships, and especially so among prisoners, who get the worst of the available food and quarters.

- The neogi have sails resembling great, spiraling webs, evoking the instinctive human and demi-human fear of arachnids. They also prefer ships that

have a basic arachnid style to their construction. Long, multi-jointed legs used mainly for grappling attacks are standard features aboard these craft.

- The drow elves have design tastes similar to the neogi, but their sails are of a finer and more delicate silky material. Drow are rarely seen on open decks, but instead equip their navigators with special magical items that allow them to see outside without the adverse effects of any bright celestial light. Their craft often have great adamantite drills to pierce the sides of enemy craft so they can invade and seize prisoners.

- The reclusive illithids project an ominous dignity. They don't like clutter, so their ships generally have few sails. A bright, colorful flag, usually dual-tailed, flutters from the highest point on the mainmast. Graceful lines and the ability to observe in all directions from enclosed positions are the main traits. Like the elves, they appreciate beauty, but they can be as ruthless and cruel as the goblins.

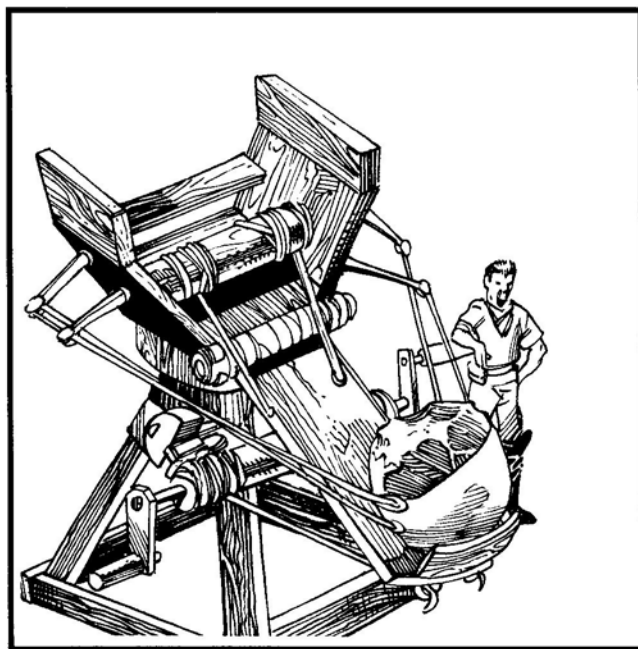

Wa, Pearl of the Orient

The land of Wa is comprised of a number of islands. The largest, *Tsukishima*, is composed of ranges of extinct volcanoes that border fertile lowlands. The capital city, *Uwagi* is located on the coast, as are most of the other major cities of Wa.

SHIP CONSTRUCTION TABLES

Table 5-1: Ship Types

Ship Type	Tonnage
Fleet Flagship	80-100 tons
Large Warship or Large Cargo Ship	60-80 tons
Medium Warship or Medium Cargo Ship	40-50 tons
Small Warship, Privateer, or Trader	20-30 tons
Coastal or Groundling Craft, Shuttle	10-20 tons
Fighters, Flitters, or Escape Craft	0-5 tons

Table 5-2: Tonnage/Cube Table

Ship Tonnage	Size of Cube
100 tons	65'
80 tons	60'
60 tons	55'
50 tons	50'
30 tons	45'
20 tons	40'
15 tons	35'
10 tons	30'
5 tons	25'
3 tons	20'
1 ton	15'

Table 5-3: Hull Cost (Workmanship and Materials)

Material	Base Cost	AR
Bone	1,000 gp	10
Ceramic	2,000 gp	9
Crystal	5,000 gp	8
Earthen	3,000 gp	8
Gems, Precious	— ¹	8
Leather	1,500 gp	9
Metal	3,000 gp	7
Metal, Precious	— ²	8 ³
Stone	4,000 gp	6
Wood, Thick (heavy)	1,000 gp	9
Wood, Thin (light)	500 gp	10

¹Precious gems are detailed in Table 5-4.

²Precious metals are detailed in Table 5-5.

³Platinum has AR 7. Mithral silver has a base and maximum AR of 3. Adamantite has a base and maximum AR of 0.

Table 5-4: Precious Gems

Material	Base Cost
Jewels (Gem Stones)	500,000 gp
Gem Stones	100,000 gp
Precious Stones	50,000 gp
Fancy Stones	10,000 gp
Semi-Precious Stones	5,000 gp
Ornamental Stones	2,500 gp

Table 5-5: Precious Metals

Material	Base Cost
Adamantite	— ¹
Silver, Mithril	800,000 gp ²
Platinum	200,000 gp
Gold	50,000 gp
Electrum	25,000 gp
Silver	5,000 gp
Copper	3,000 gp ³

¹Not usually available for sale.

²Or not available if the referee chooses.

³Minimum cost for base metal construction.

Table 5-6: Basic Armor Ratings

Construct	Base AR
Adamantite	— ¹
Silver, Mithril	— ²
Stone	6
Metal	7
Platinum	7
Crystal	8
Earthen	8
Gem, Precious	8
Metal, Precious ³	8
Leather	9
Ceramic	9
Wood, Thick (heavy)	9
Bone	10
Wood, Thin (light)	10

¹Base and maximum AR are both 0.

²Base and maximum AR are both 3.

³The base AR of Precious metal is 8 unless otherwise stated in the table.

SHIP CONSTRUCTION TABLES

Table 5-7: Basic Ship Saving Throws

Item	Acid	Crushing Blow ¹	Dis	Fall	Mag Fire	Nor Fire ²	Cold	Light	Elec
Bone	11	16	19	6	9	3	2	8	2
Ceramics	4	18	19	11	3	2	4	2	2
Cloth	12	—	19	—	16	13	2	18	2
Crystal, Gems	3	17	18	8	3	2	2	14	2
Glass	5	20	19	14	7	4	6	17	2
Leather	10	3	19	2	6	4	3	13	2
Metal ³	13	7	17	3	6	2	2	12	2
Stone	3	17	18	8	3	2	2	14	2
Rope	12	2	19	—	10	6	2	9	2
Wood, Thick	8	10	19	—	7	5	2	12	2
Wood, Thin	9	13	19	2	11	9	2	10	2

¹Crushing Blow includes crashes.

²Normal fire includes greek fire attacks and smokepowder.

³Metal includes the *glassteel* spell. Precious metals have a -1 penalty to roll; mithral has a +3 bonus, adamantite +5. A roll of 1 always fails.

Table 5-8: Ram Prices

Ram Type	Cost ¹	Space Needed ²
Ram, Blunt	100 gp/ton	1 ton
Ram, Grappling	200 gp/ton	1 ton
Ram, Piercing	100 gp/ton	1 ton

¹Cost is given in gold pieces per ton of the ship.

²This assumes the ram is built into the structure of the ship.

Table 5-9: Base MC Table

Construct	Base MC
Bone	D
Ceramic	D
Crystal	D
Earth	F
Gems	D
Leather	E
Metal	E
Metal, Precious	E
Stone	F
Wood, Thick (heavy)	D
Wood, Thin (light)	C
Ship over 60 tons	-1 MC
Ship under 5 tons	+1 MC
Rigging is standard	+1 MC

Table 5-10: Engine Weight Requirements

Engine Type	Minimum Weight	Maximum Weight
Artifurnace	10 Tons	<i>Unknown</i>
Bardic	5 Tons	100 Tons
Box	10 Tons	100 Tons
Crown of the stars	1 Ton	50 Tons
Forge	300 Tons	700 Tons
Furnace	1 Ton	100 Tons
Gnomish helm	1 Ton	50 Tons
Grand helm	1 Ton	<i>Unknown</i>
Insectare	5 Tons	100 Tons
Ki-helm	5 Tons	200 Tons
Lifejammer	1 Ton	100 Tons
Major helm	1 Ton	100 Tons
Minor helm	1 Ton	50 Tons
Nonmagical engine	1 Ton	100 Tons
Orbus	1 Ton	60 Tons
Pool helm	5 Tons	200? Tons
Pump	5 Tons	100 Tons
Rudder of propulsion	500 lbs	1 Ton
Series helm	5 Tons	50 Tons
Ultimate helm	10 Tons	<i>Unknown</i>

SHIP CONSTRUCTION TABLES

Table 5-12: SR Using Other Magical Engines

Engine Type	Ship Rating and Notes
Artifurnace	SR 5. The artifurnace is destroyed if the artifact is removed.
Bardic Helm	As <i>major helm</i> . Usable only by a bard or a character with musical proficiency.
Box Helm	As <i>major helm</i> . This engine is unique to the Batship.
Crown of the Stars	As <i>minor helm</i> . This is a portable helm.
Forge	1 SR/100 dwarves. The forge is found mainly on dwarven Citadels.
Furnace	SR 2. Burns magic. Power lasts for a number of weeks equal to magical item's XP value divided by 1,000. SR 3 if two items are burned at once.
Gnomish Helm	As <i>minor helm</i> .
Grand Helm	1 SR/4 levels of helmsmen; up to 4 helmsmen. Objects under 200 tons do not drop ship to tactical speed.
Ki-Helm	1 SR/20 ki points. The minimum ki need to operate is 10 ki points.
Lifejammer	As <i>minor helm</i> . Uses victim's level or hit dice. Each day, victim takes 1d8 damage and must save vs. death or perish.
Major Helm	The most common helm for ships over 50 tons (see Table 5-11).
Minor Helm	The most common helm for ships of 50 tons or less (see Table 5-11).
Nonmagical Engine	SR 1. Can't achieve spelljamming speeds.
Orbus	1 SR each, maximum of 5. These creatures power beholder ships.
Pool Helm	SR 5. Powered by an illithid life-pool, which counts as two crew members.
Radiant Helm	As <i>major helm</i> . Used by drow elves only (see New Magical Items).
Rudder of Propulsion	SR 6. Used mainly by Wa (see New Magical Items).
Series Helm	1 SR/helmsman, to 5 SR. Much used by humans and illithids.

Table 5-13: Tonnage Cost Per Weapon

Weapon	Tonnage Cost
Light	1
Medium	2
Heavy	4

Table 5-11: SR Using Minor and Major Helms

Level of Wizard or Priest	Major Helm	Minor Helm
1	1	1
2	1	1
3	1	1
4	2	1
5	2	1
6	3	2
7	3	2
8	4	2
9	4	3
10	5	3
11	5	3
12	6	4
13	6	4
14	7	4
15	7	5
16	8	5
17	8	5
18	9	6
19	9	6
20	10	6

Table 5-14: Large Weapons List

Weapon	Tonnage	Cost	Crew
Accelerator	4	45,000 gp	1
Ballista, Light	1	400 gp	1
Ballista, Medium	2	600 gp	2
Ballista, Heavy	4	800 gp	4
Bombard	2	20,000 gp	3
Bombard, Great*	20	60,000 gp	5
Catapult, Light	1	500 gp	1
Catapult, Medium	2	700 gp	3
Catapult, Heavy	4	1,000 gp	5
Greek Fire Projector	2	1,000 gp	3
Jettison, Light	1	400 gp	2
Jettison, Medium	2	600 gp	3
Jettison, Heavy	4	800 gp	4
Sweeper, Gnomish	2	800 gp	3

* Ship must be designed for this weapon.

Table 5-15: Weapon Turrets

Turret Size	Standard Cost	Protected Cost
Light	— ¹	500 gp/1 ton
Medium	500 gp/1 tons	1,000 gp/2 tons
Heavy	1,000 gp/2 tons	2,000 gp/3 tons

¹Light weapons do not normally require turrets.

6: SHIP IMPROVEMENTS

Often, the improvements an adventurer desires is a ship with more weapons, one that is faster, more maneuverable, one with special abilities, or one with a tougher hide. All such improvements cost money, and some are mutually exclusive.

There are five basic improvements that characters can have spelljamming shipyards perform on their ships. The time required for major structural work is usually 1 day per ton of the ship being modified. The main improvement options include:

1. Weapons
2. Armor
3. Maneuverability
4. SR (speed)
5. Cargo Capacity

Weapons

Weaponry improvements include replacing smaller weapons with heavier ones, the addition of more weapons, adding turrets, or upgrading to magically enhanced weapons.

Maximum Weapons: As a general rule, the amount of space allotted to weapons cannot exceed one-half the total tonnage of the ship. (Exceptions do exist, however. In some giff ships, like the Clipper, weapons can take up to 75% of the cargo space.)

Weapons displace breathable air, so the crews in these over-equipped ships cannot travel as far as their counterparts in vessels that contain less weaponry. If PCs decide to over-equip their ships with weapons, the DM should reduce their traveling range accordingly.

For example, a Hammership, at 60 tons, can carry 30 tons of weapons. If this ship is loaded with 40 tons of weapons (ten tons beyond the maximum of 30), the ship loses 16% of its air envelope: 10 (the excess tonnage of weapons) divided by 60 (the tonnage of the ship). The ship also has used ten tons of its cargo capacity.

Since a ship of 60 tons can carry 60 men for four months (120 days), the 16 percent loss of breathable air shortens the ship's traveling ability by 20 days.

(As it is impossible to add more than the total cargo tonnage of weapons onto a ship, the craft never suffers more than a 50 percent loss to its air envelope.)

Weapon Installation

Characters can place new ship-mounted weapons nearly anywhere they choose. They must keep in mind, however, the DM may impose fire arc or other special penalties depending on how the weapons are fitted. Typical examples follow.

- **Underside Placement:** Since the gravity plane allows the characters to stand on this part of the ship as easily as the decks, no attack penalties are incurred. However, this prevents the ship from landing (at least without crushing the weapon and crew). Water landings become difficult or impossible.

- **Side or Wing Placement:** Special "blisters" or turrets can be fitted for weapons. These positions, though, require a special ladder or staircase to get to the weapon, as well as a unique turret or mount costing as much as a standard turret mount.

Even with this mounted turret, the side-mounted weapons can never fire out of their sideways arc (e.g., starboard-mounted weapons can only fire in the starboard arc).

- **Deck Placement:** Weapons can be placed on the exposed decks, or at firing ports on an enclosed deck. One popular tactic on gnome ships is to have ballistae positioned at windows. This gives the weapons greater protection, but also limits their firing arcs. Such a weapon position:

- defends like protected turret, and
 - is limited to one fire arc (forward, port, aft, etc.).

- **Cargo Hold Placement:** Weapons carried in the cargo holds cannot be used unless they are positioned at windows or other ports. They are used primarily as replacements when a deck weapon is destroyed.

It takes 2d10 + 10 rounds to remove the destroyed weapon, pull a replacement out of storage, and install it in its place. If the original weapon was turret-

Krynn Beyond Ansalon

Where can you go on Krynn if you don't go to the main continent of Ansalon?

South lies the icy vastness of the Icewall Glacier, covering the southern polar region for several hundred miles.

West lies a savage sea of tempests and typhoons that makes sailing or flying nearly impossible.

6: SHIP IMPROVEMENTS



ed, then a 50% chance exists that the turret will need to be replaced also.

Adding a Ram

If the PCs wish to install a ram on a ship that was constructed without a ram, the DM should raise the price of the initial ram installation an additional 50%. This rise in cost is due to the tremendous structural reinforcement needed for this type of improvement. Ships that have rams must have extraordinarily strong frames to survive the impact of ramming without breaking up. Ships that are not constructed with rams are not sufficiently reinforced, so additional bracing must be added at time the new ram is installed. (Without any reinforcement, the ram would break off after the first use.)

Armor

Armor plating can improve the ship's overall Armor Rating, but it also hurts the Maneuverability

Class as well. Unarmored ships without armor have a base AR according to Table 5-6, Basic Armor Ratings, according to construction material.

There are several ways to increase the Armor Rating (or Armor Class) of the spelljamming craft.

1. Increase the thickness of the ship's hull;
2. Add plates of metal (or possibly hide);
3. Replace the construction material with a stronger substance.

- **Increased Thickness:** This is strengthening the hull with more layers of the original material.

Cost: Multiply one-tenth the tonnage of the ship by the base cost of the material used (see Tables 5-3, 5-4, or 5-5 on page 65).

Effects: Add -1 to Armor Rating; reduce cargo space by 20% (minimum decrease is 1 ton). Thin wood becomes thick wood.

Restrictions: A ship that does not have the cargo capacity of at least one ton available cannot have its hull thickened. The hull of a ship with a current AR of 4 or better cannot be thickened. The material used to thicken a hull must be the same as that used in its original construction. A ship can have its hull thickened only once.

Example: A 40-ton lambus made of thick wood could improve its Armor Rating from 5 to 4, but its cargo capacity would be reduced from 20 to 16. The cost of the improvement would be 4,000 gp.

- **Plating:** Hull plating consists of covering the hull's outer surface with a stronger material than the hull, usually metal scales or plates.

Cost: Multiply one-third the tonnage of the ship by the base cost of the plating material (see Tables 5-3, 5-4, and 5-5).

Effects: Add a -1 bonus to the Armor Rating; lower the Maneuverability Class by one step. Saving throws and cargo capacity are unaffected.

Restrictions: There are no special restrictions on plating.

Example: A 60-ton giff Clipper ship is plated with iron. Its Armor Rating changes from 4 to 3, but its MC is reduced from E to F. The plating costs 60,000 gp.

North lie the tropics. Legendary locations, many weeks' sailing time, include the Isle of the Dragons and the fabled land of the Irda.

East lies an ocean of unspeakable vastness, made crossable after many months sailing by strong winds from the east. At the end of the journey lies the continent of **Taladas**.

6: SHIP IMPROVEMENTS

Optional Rule: Hide Plating

This process includes covering a ship with animal hides or similar materials. Using larger creatures is generally cheaper.

Cost: The cost is 1 gp per XP value of each animal used in the improvement.

Effects: This gives the ship a -1 Armor Rating bonus if the creature's armor class is better than the ship's AR. In addition, certain types of hides, such as dragon skin, can be magically strengthened to -2 or even -3 at great cost. Table 6-1 shows the number of creatures needed to increase the ship's AR, according to size.

Restrictions: Until the number of hides required are attached to the ship's hull, the ship does not gain the AR bonus. Some materials, such as molds and jellies, are not safe to use. Alignment and culture may restrict use of these materials at the DM's option. (Most human and demihuman cultures would not allow the use of intelligent or near-extinct creatures.)

Hides Needed to Increase AR

Size	# Needed per Ship Ton
Tiny (2' or less)	32
Small (2+' to 4')	16
Man-Sized (4+' to 7')	8
Large (7+' to 12')	4
Huge (12+' to 25')	2
Gargantuan (25+')	1

• **Stronger Materials:** This is a complete overhaul and reconstruction using different (and much stronger) materials.

Cost: Multiply the tonnage of the ship by the base cost of the new material. Options include using metal, *glassteel*, stone, thicker wood, etc.

Effects: Change the ship's Armor Rating and saving throws to those of the new material. The material may affect the ship's ability to land on water or land, at DM's option. Maneuverability Class and hull

points will not be changed.

Restrictions: The PCs must have access to materials, skilled workmen, and a dry dock with the capability to work on spelljamming ships.

Example: A 30-ton ship constructed of Thin Wood is rebuilt with Copper. The improved ship's saving throws changes from Thin Wood to Metal (-1). The improvement will cost is 90,000 gp.

Maneuverability

Each ship has a Maneuverability Class determined primarily by its design, by the materials used to construct it, and by such standard features as sails, oars, spars, etc. Such gear is called *rigging*. Methods to improve MC include "topping out" and "stripping".

• Topping Out

Cost: "Topping out" costs 100 gp per ton.

Effects: The process improves MC one step; however, minimum crew requirements increase by 50%.

Restrictions: A ship can be topped out once only. This process is often used to offset the effects of "plating". Note that "topped out" rigging is easily recognized by anyone familiar with the ship's basic design.

Example: A 60-ton ship with MC E is improved to MC D at a cost of 6,000 gp. If the original minimum crew was 20, it now takes 30 crew to run the ship.

• **Stripping:** This process removes nonessential weight.

Cost: The cost is 100 gp per ton; the required time is 1 day/10 tons.

Effects: Improves MC by 1; worsens AR by 2. This cannot be noticed by the casual observer. This process does not affect tonnage.

Restrictions: Ships with AR 9 or worse cannot be stripped. A ship can be stripped only once. A ship with an adamantite or mithral hull cannot be stripped.

Krynnspace: The History of Taladas

There is no grand written record of the history of Taladas; no great work such as the *Iconochronos* of Astinus, which details the history of Ansalon, exists. Most cultures of Taladas have no written language at all, relying instead on oral traditions.

6: SHIP IMPROVEMENTS

SR (Speed)

Speed is a function of the power of the spelljamming engine, and does not vary with the tonnage of the ship. The most common way to alter SR is to add a more powerful helm.

Aracokra designs have an innate +1 SR bonus, and it is rumored that the arcane can modify ships for increased speed, but that this is rare. Certain shipyards may be able to increase SR on occasion, at the DM's option.

Cargo Capacity

The storage capacity of a ship can be improved a number of ways, including "Thinning" and "Gutting".

- **Thinning:** The hull thickness is decreased and some internal bracing is removed.

Effects: This gives a +1 penalty to AR, but in-

creases the available cargo space by 20% of hull tonnage.

Restrictions: Thick wood becomes thin wood. Thin wood cannot be thinned further. A ship under 5 tons or with AR 10 cannot have its hull thinned. A ship with an adamantite or mithril hull cannot have its hull thinned. A ship can have its hull thinned only once.

- **Gutting:** This means that most of the interior bulkheads, cabins, and internal reinforcement has been sacrificed to increase cargo space.

Cost: The process costs 100 gp per ton and requires 1 day/10 tons of the ship.

Effects: Cargo space increases to 75% of total tonnage; AR worsens by 2. This modification cannot be noticed by the casual observer and does not affect the ship's total tonnage.

Restrictions: Ships with AR 9 or worse cannot be gutted. A ship can be gutted only once. Adamantite and mithral hulls cannot be gutted.

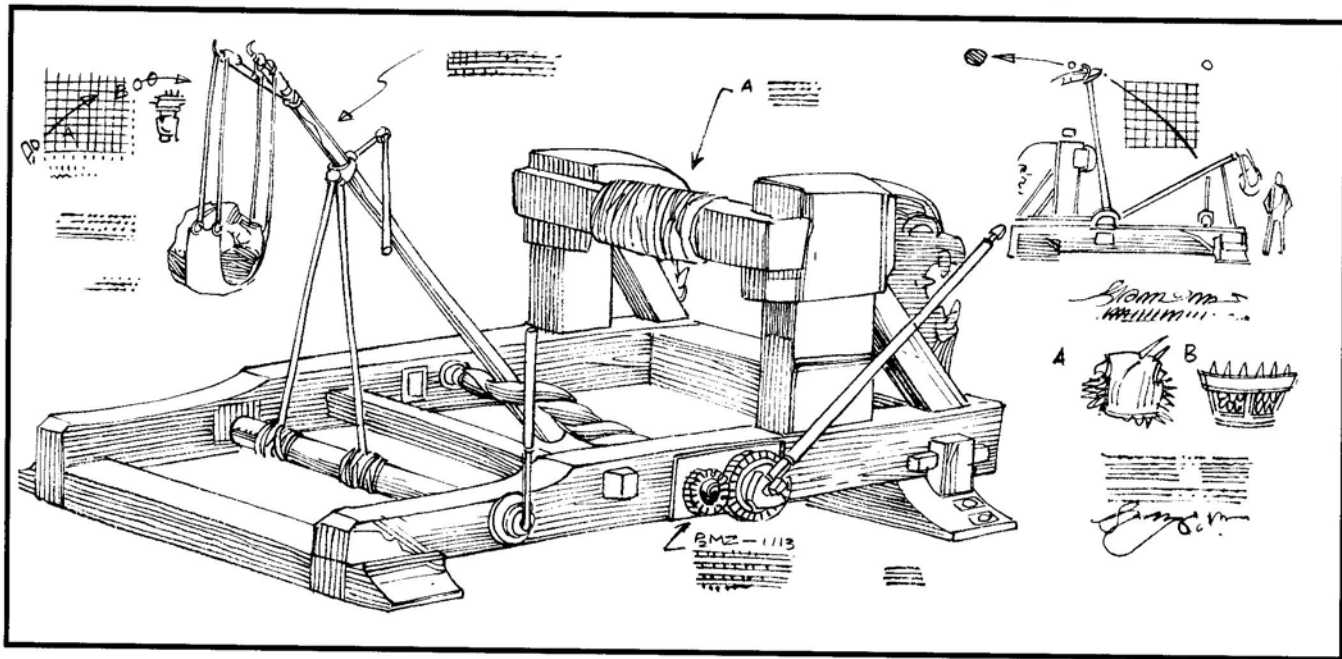

The primary written histories are found among the gnomes of Hitehkel, the Lost Silvanesti, and the cities of the Imperial League of Minotaurs. Most written histories follow the dating conventions of Ansalon, brought over by the minotaurs of the League and the Lost Silvanesti.

6: SHIP IMPROVEMENTS

Table 6-1: Weapon Prices

Large Weapon	Cost	Buy back Price	Space Needed	Crew
Accelerator ¹	45,000 gp	0-22,500 gp	1 ton	1
Ballista, Light	400 gp	0-200 gp	1 ton	1
Ballista, Medium	600 gp	0-300 gp	2 tons	2
Ballista, Heavy	800 gp	0-400 gp	4 tons	4
Bombard	20,000 gp	0-10,000 gp	2 tons	3
Catapult, Light	500 gp	0-250 gp	1 ton	2
Catapult, Medium	700 gp	0-350 gp	2 tons	3
Catapult, Heavy	1,000 gp	0-500 gp	4 tons	5
Greek Fire Projector	1,000 gp	0-500 gp	2 tons	3
Jettison, Light	400 gp	0-200 gp	1 ton	2
Jettison, Medium	600 gp	0-300 gp	2 tons	3
Jettison, Heavy	800 gp	0-400 gp	4 tons	4
Ram, Blunt	100 gp/ton ²	0-50 gp/ton ²	1 ton	—
Ram, Grappling	200 gp/ton ²	0-100 gp/ton ²	1 ton	—
Ram, Piercing	100 gp/ton ²	0-50 gp/ton ²	1 ton	—
Sweeper, Gnomish	800 gp	0-400 gp	2 tons	3

¹New item, see New Magical Item chapter.

²gp/ton signifies gold pieces per ton of the ship. The larger a ship, the stronger and larger the ram needs to be, and therefore the greater the resale value.

Other Modifications

Multiple Modifications

Stripping and Topping Out: This combination improves MC by 2; worsens AR by 2; and increases minimum crew by 50%. Changes are cumulative with improvements in armor plating, cargo capacity, and speed.

Magical Modifications

MC can be altered by magical sails without increasing the crew required.

Crew can be replaced with the *unseen ship crew* magical item that automatically increases the number of crew members on a ship when activated.

One of the most popular ways of increasing ship storage is to use a magical item called the *hold of holding* (as detailed in Chapter 7).

Equipment Trade-Ins

When a player decides a character will get a new ship's weapon, older equipment can be traded in. This sometimes allows the new weapon to be bought at a significant discount.

The buy-back price depends on the condition of the weapon. In game terms, the seller buys the older weapon for 0 to 50 percent (1d12-2 × 5) of the going price. For example, the light jettison, a weapon that normally sells for 400 gp, would be bought back anywhere from 0 to 200 gp. The seller must make a profit to assure his company's survival, and he has no problem stepping on a few coin purses to do it. Table 6-1 shows the price of standard weapons, their buy-back prices, and the amount of (cargo) space required to hold the weapon.

Spelljamming merchants should be aware that the laws of Taladas punish "theft by force" according to the rules of trial by combat. If the property is recovered, the parties use their own armor; if not, then the guilty may wear none. Intentional and malicious disposal of stolen property requires combat to the death (see the "Regulations of Ambeortin VII" in the *Legal Codex of the League*).

6: SHIP IMPROVEMENTS

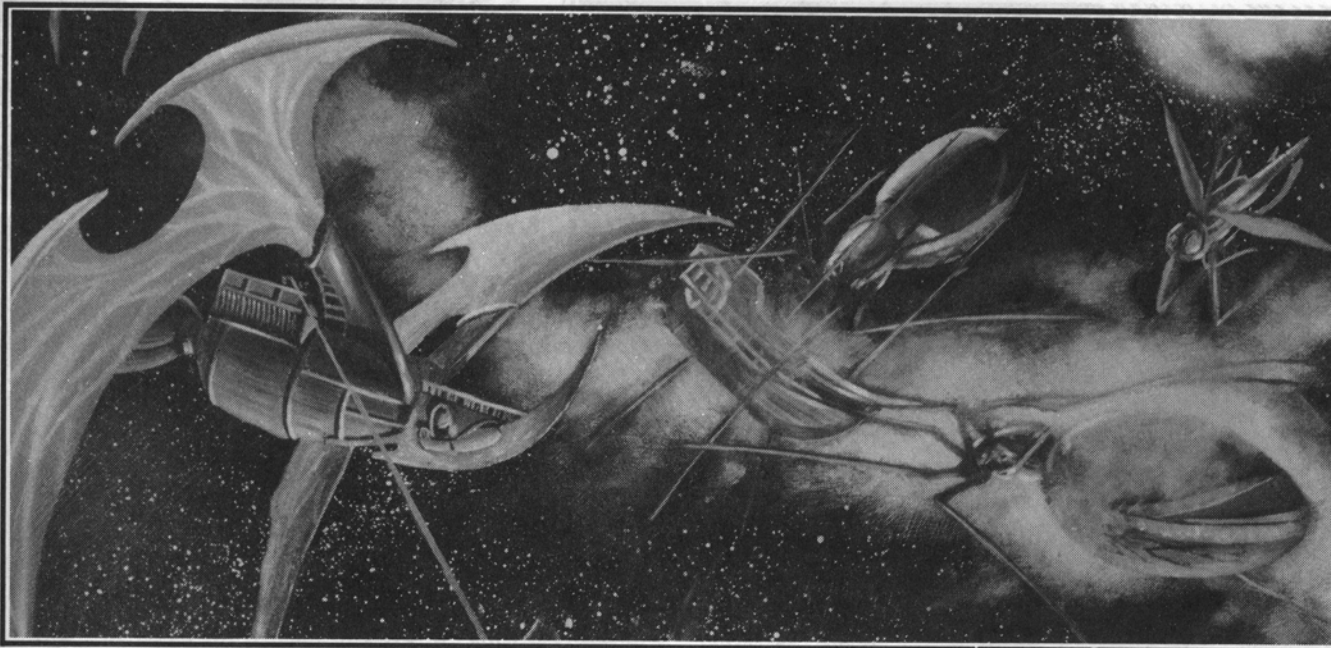

Special Arcane Modifications

Adventurers may occasionally be of great service to the mysterious arcane, master merchants and source of much spelljamming equipment. Should this occur, the DM may decide that the arcane will offer the adventurers a special overhaul to their ship as a return favor for their assistance.

The modification will be completed at a time and place chosen by the arcane. The time required will be the standard rate for new construction (1 day per ton) unless the DM decides otherwise. All of the modifications to a ship by the arcane are unique to that ship, and their techniques cannot be duplicated by any shipyard. The arcane will perform only one modification at a time as a special favor, although it is possible that they could, over time (and many favors), upgrade a ship several times. Typical modifications include:

- * Add +1 MC (to a maximum of B; "topped out" rigging is removed and lost during this process)
- * Add +1 SR (to a maximum of +3, total)
- * Subtract one AC rating (to a maximum of AC 4)
- * Add Triop-style "flip-fins" for rapid maneuvering
- * Add an extra-dimensional cargo space of 5 tons (takes 1 week)
- * Install a better ship's helm, for example replacing a minor helm with a major helm (takes one day to one week)
- * Ship minimum crew is reduced to 1 ("topping out" requires standard crew only)
- * Install an unusual piece of equipment, such as a gnomish water cannon or a cone ram (see Lamprey ship)

**"Every hour of every day is a fight for survival.
No man nor woman is exempt, and only the strong survive.
Combat is no different; it's just a great deal more noisy."**

Sarelk the Sage

6: SHIP IMPROVEMENTS



7: NEW MAGICAL ITEMS

Accelerator

The *accelerator* is a rapid-fire weapon built by the arcane for use on spelljamming craft of all types. Much in the same way that *spelljamming helms* gain their magical properties from the spellcasters who sit in them, the *accelerator* gains its magical properties from the activated spelljamming helm (without the helm, the *accelerator* is nonfunctional). When first found or purchased, it does not possess any dweomer whatsoever. Only when it is fitted to a ship with a functioning (and occupied) spelljamming helm, does the *accelerator* radiate an aura of magic.

Looking much like a gigantic sextant, the *accelerator's* main arm is a 4-foot-long, 6-inch diameter hollow tube with a hand-sized cup at one end. The arm can be elevated and swiveled once the weapon is bolted in place. Items placed in the cup are magically grabbed, *accelerated* through the arm's length, and shot out the far end. The weapon can be fired twice in a single round. The range of this weapon is six hexes. It causes 1d2 hull points of damage to ships and 1d10 hit points of damage to individuals. On a THAC0 roll of 19 or greater, it inflicts a critical hit. The item costs 45,000 gp and its XP value is 4,500.

When the *accelerator* is aboard a spelljamming ship, it decreases the ship's total SR by one point, even when the *accelerator* is not mounted or in use. The penalty occurs even if the *accelerator* is merely in the presence of an activated *helm*. There is no way to block the penalty or gain the lost SR back.

The weapon-handler must beware. Anything placed in the cup is shot out the other end, including sleeves, knives, daggers, fingers, toes, hands, rocks, *helmseekers*, etc. Anything living, including any of the vast number of slimes, jellies, and molds, will die when shot by the *accelerator*.

It is not known if the arcane themselves use this weapon, but apparently only the arcane can repair or service it, should anything damage its delicate mechanisms.

Amulet of Arachnid Control

This *amulet* can control one giant or 1d10 normal

arachnids of any type. This includes beings who have magically assumed any arachnid form in whole or in part. Arachnids are allowed a saving throw if they have an Intelligence of three or better. Unlike the *ring of arachnid control*, all neogi (even the Great Old Masters) must make a saving throw vs. spell at a -2 penalty in order to avoid being magically compelled to obey the command of the *amulet's* wearer. (If the save is successful, the neogi can choose whether to obey or not.) This item has an XP value of 2,000, and a suggested gp value of 8,000.

Anchor of Staying

This item appears as a standard anchor, except for a faint magical aura it, and its chain, gives off. When pitched over the side of a ship moving at tactical speed, the *anchor* comes to rest on the gravity plane, stopping the ship (reduces SR to 0). The ship becomes stationary with respect to the closest Class A or greater celestial body. When the *anchor* is pulled up, the ship can once again move.

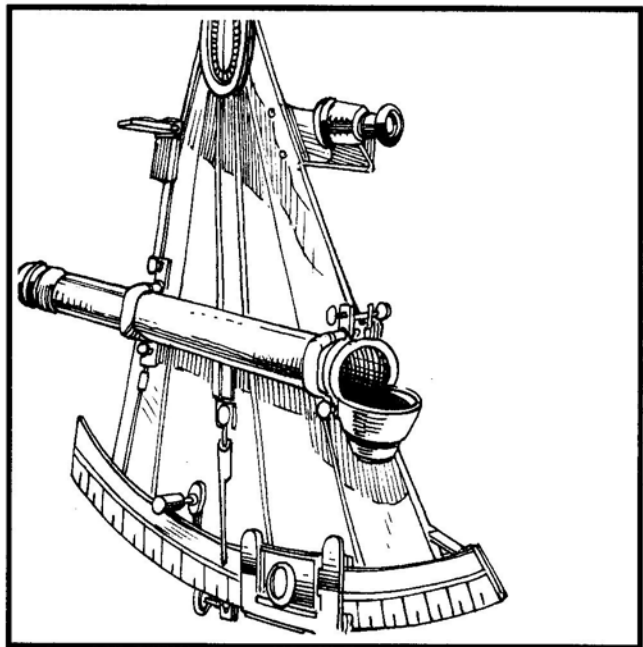

"I didn't like the new accelerator we captured.
I liked it even less after it fired Ferrin's arm."

Dairn, Emerald Brotherhood Company

7: NEW MAGICAL ITEMS

The anchor can be dropped while moving at spelljamming speed, but at dire effect. The ship instantly stops, while everything in the ship tries to continue forward. All crew members suffer 3d10 points of damage (save vs. spell for half damage). Unsecured items must roll a save vs. falling or be broken.

Typical anchor variations include:

Lesser anchor of staying: This item gives off a faint auburn aura when cast over the side. It will stop a ship powered by a *minor helm* or equivalent. Its dweomer is not sufficient to halt the progress of a ship with a *major helm*. A ship with a *major helm* or equivalent will be slowed by 3 SR (to a minimum of SR 1). This item is worth 3,000 gp and has an XP value of 300.

Greater anchor of staying: This item gives off a faint bluish aura when cast over the side of a ship. It can be used on any spelljamming ship. Its dweomer is sufficient to stop a ship powered by the equivalent of a *major helm* or less. This item has 5,000 gp value, with an XP value of 500.

Cursed anchor: The item appears to be a *greater anchor of staying*, to all tests and divinations. However, when activated, it moves the ship toward the nearest body greater than 10 tons at an SR of one. This motion is at first so subtle that it is virtually undetectable; except for the fact that a planet, or ship can be seen (eventually), moving toward the ship. The ship gradually accelerates to spelljamming speed. If the anchor has been in place for 24 continuous hours, it cannot be pulled in. Only by the use of a *remove curse* on the item itself, can the *cursed anchor* be brought back into the ship, and the motion thus stopped. After 24 hours under the effects of the *cursed anchor*, the spelljamming helm ceases to function. This item has 2,000 gp value, with no XP value whatsoever.

Antennae of Triangulation

This rare item creates a tactical battle display of nearby space in the mind of the user. This allows

three-dimensional tracking of objects larger than eight feet across that are within a 10,000-yard radius (20 hexes) of the user's position.

These antennae can be 20' or more in length, and they appear to be the antennae removed from a gargantuan insect. A *helm of liaison*, which usually accompanies the antennae when first found or purchased, links the antennae to the wearer of the helm. The helm relays the information found by the antennae in exact detail to the wearer.

When the helm is put on, the wearer immediately gains a mental picture of the 360° sphere of the space around his ship. The positioning of objects in this area changes when his craft changes heading, location, etc. If there is a chance the user might lose an object being tracked, or that some significant detail might be missed, the user must make a Wisdom check to successfully use the antennae.

Using the antennae is fully as fatiguing as manning a spelljammer helm, and is subject to the same requirements for resting afterwards.

The *antennae of triangulation* and the *helm of liaison* can be purchased for 250,000 gp or more, depending upon the reaction roll of the seller, but never for less. It has no XP value.

Astrolabe

The *astrolabe* is a large, fixed device used to display the location of astronomical bodies of Class A and larger as a large spherical projection. The *astrolabe* must be used inside a crystal sphere, in a dark room or during night when no lights can disturb the picture. The item creates a to-scale three-dimensional picture. The *astrolabe* shows the orbital path and the current location of every large or major celestial body in the crystal sphere. The 3-D picture perfectly fits the room it is in, or a radius of 30', whichever is smaller.

The points of varying colors of light that the *astrolabe* creates shows the motions and the colors of all planets, moons, suns, asteroids, comets, etc. (some anomalies cannot be penetrated, however). A small pinpoint of white that blinks once every second shows the relative position of the *astrolabe* in the sys-

“Arter the kindori smashed us t’ flinders,
I floated for nigh on t’ two weeks before an illithid ship
picked me up. Took me t’ a base on H’Catha . . .
that’s where I got these ‘ere slave tattoos.”

Derek Flinthand, Sail Master (retired)

7: NEW MAGICAL ITEMS

tem. The item is often used in navigation rooms to check course changes and to verify headings.

The *astrolabe* always operates, and cannot be turned off. Merely bringing a light source into its room, however, is enough to nullify the faint picture it presents. Thus conferences and meetings can be held in a room containing an *astrolabe* without the attendees realizing one is present. An *astrolabe* has 8,000 gp value, and is worth 2,000 XP.

Ballistae, Magical

Somewhat rare items, magically enhanced ballistae are a highly desirable addition to any ship. Most (65%) the weapons gain the bonus to their attack and damage rolls. The rest (35%) of the ballistae apply the bonus toward the range (speed) of the missile being shot.

Ballista	GP Value	XP Value
Light +1	4,000	800
Light +2	8,000	1,600
Light +3	16,000	3,200
Medium +1	6,000	1,200
Medium +2	12,000	2,400
Medium +3	24,000	4,800
Heavy +1	8,000	1,600
Heavy +2	16,000	3,200
Heavy +3	32,000	6,400

Neverending Barrel of Grog

Often, the greatest worry ship captains have is maintaining a healthy supply of clean liquids for the ship's crew to drink. One way this is accomplished is by using a *neverending barrel of grog*. Grog, a watered down version of cheap, rot-gut rum, is not particularly good for the crew, but it will keep them alive (and not complaining) almost indefinitely.

The *barrel* has a magical dweomer, but remains empty until it is tapped. When tapped, it needs to be set upright and lidded. When the handle of the wooden tap is turned to either the left or right, a dirty-looking, foul-smelling fluid gurgles forth, filling the cup (or mouth) lying beneath the spout.

The *barrel* will forever pour forth grog, without a

daily limitation. (After the fifth glass in an hour's time, an imbiber must roll a Constitution check with each glass or pass out. If the check fails, the character falls asleep for 2d8 hours, and cannot be awakened by nonmagical means.) The *neverending barrel of grog* has 4,500 gp value, and is worth 900 XP.

Neverending Barrel of Salt Pork

Another worry that ship captains have is being able to store food safely on their ships, especially on the long journeys between crystal spheres. Food kept in dark, often damp cargo holds has the unsavory habit of turning bad and spoiling quickly. Therefore, other means to preserve food need to be found. Salting meats and vegetables is a common practice. This curbs spoilage, but storing the bulk and the extra weight of the meat and salt is a problem. The *never-ending barrel of salt pork* allows the ship's cook to pull up to 100 pounds of salted pork each day (feeding about 50 crewmen). Once the salt is scraped, shaken, and dissolved off, the meat can be cooked, rendering a safe (although somewhat salty) meal. The *neverending barrel of salt pork* has 9,000 gp value, and is worth 1,800 XP.

Basket of Devouring

Baskets of devouring are common items in ship studies and captain's quarters. They are small, 1' in diameter, and 1 1/2' tall, and have a natural ability to always land open-end up. Anything large enough to fit completely into the basket will disappear once its total mass passes under the lip.

All items placed into the *basket of devouring* have a 5% chance per turn of disappearing. This can be helpful when an item or valuable piece of paper is thrown into the basket before its importance is revealed. (Unfortunately, it can also cause some problems when incriminating information needs to be destroyed and the basket doesn't operate for several days!)

(It is rumored that items placed in the *basket of devouring* are not destroyed. They are dimensionally shifted into the Astral plane. Here, the arcane have a special asteroid base where they sift through the

"In every man's heart,
a spark of fear drives him toward perfection,
but in every man's mind,
is the inability to endure the heartache of failure."

Sarelk, Sage

7: NEW MAGICAL ITEMS

refuse looking for valuables. All valuable information and items are catalogued and placed in a vast library.)

This item does not function while the ship is in the phlogiston. The *basket of devouring* has 2,500 gp value, and is worth 250 XP.

Bell of Warning

The *bell of warning* is a new arrival to the spelljamming universes. It is designed to warn the crew when another ship approaches within ten hexes (5,000 yds.). Whether the approaching ship is friend or foe, whether visible or invisible, whether under one ton or the *Spelljammer* itself; this bell rings whenever a spelljamming ship approaches. This ringing continues for three rounds. It does not react to creatures, even to those of gargantuan size. The *bell of warning* has 1500 gp value and is worth 150 XP.

Bombard, Magical

Somewhat rare items, magically enhanced bombards are highly desirable additions to any giffmanned ship. Magical bombards have the same chance of backfiring as standard bombards have, but they are not destroyed by such explosions. Sixty-five percent of the weapons gain the bonus to their attack and damage rolls. Thirty-five percent of the bonuses listed in the chart apply toward the range (or speed) of the missile being shot.

Bombard	GP Value	XP Value
+1	50,000	4,000
+2	100,000	8,000
+3	200,000	16,000

Box of Preservation

These large boxes measure 8' long, 4' wide, and 3' deep. A hinged lid on the box's top allows easy access to the material it contains. This box magically *preserves* whatever it contains indefinitely. The item permanently maintains its current temperature, texture, ripeness, etc., for as long as it is within the box.

The *box of preservation* has no limit to the amount of weight it can hold. Its only limitation is its size. All

items placed in the box must be inanimate or dead. If a living creature is placed in the box, the creature enters a state of suspended animation until removed. When removed, the creature must roll a *system shock* roll. If this roll fails, the creature dies.

The *box of preservation* has 11,000 gp value, and is worth 2,200 XP.

Catapult, Magical

Somewhat rare items, magically enhanced catapults are a highly desirable addition to any ship. Sixty-five percent of the weapons gain the bonus to their attack and damage rolls. Thirty-five percent of the bonuses listed in the chart above apply toward the range (or speed) of the missile being shot.

Catapult	GP Value	XP Value
Light +1	5,000	1,000
Light +2	10,000	2,000
Light +3	20,000	4,000
Medium +1	7,000	1,400
Medium +2	14,000	2,800
Medium +3	28,000	5,600
Heavy +1	10,000	2,000
Heavy +2	20,000	4,000
Heavy +3	40,000	8,000

Coat of the Seas

This leathery coat comes with an attached hat. It keeps its owner dry, even during typhoons and hurricanes. If the wearer ever is thrown overboard, the character is kept warm magically. The character is kept afloat, and his breathing is unaffected by waves of any size.

In the phlogiston or in wildspace, the coat constantly regenerates the character's air supply. The coat cannot *create food and water*, so rescue must be quick if the wearer is unprepared. The coat has 10,000 gp value and is worth 2,000 XP.

Figurehead of Protection

Figureheads are used primarily as decorations on the front spar of a ship. The figureheads listed here are not for use as rams, and if one bears the brunt of

New Worlds

Darkspace: This is a sphere with a dead sun, surrounded by debris the size of small planets. There are strange winds here, biting and cold, even in the void. Undead are found here in great numbers. This space is closest to and most direly threatens "Greatspace". These conditions may be alleviated by adventurers (SJA3, *Crystal Spheres*).

7: NEW MAGICAL ITEMS

a collision, it must save as thick wood vs. crushing blow or be destroyed. Only one figurehead can function on a ship at one time. If more than one is mounted, the power of the lesser one is used, and the greater one lies dormant.

Below, several types of figureheads are listed. Rarely, the effect of one can be combined with others in order to create a more powerful *figurehead of protection*.

Smiling figureheads improve the reactions encountered ship crews (see to the *Dungeon Master's Guide* page 103). The bonus modifies the reaction roll. A figurehead with a -1 bonus has 4,000 gp value (800 XP), a -2 bonus has 8,000 gp value (1,600 XP), and a -3 bonus has 16,000 gp value (3,200 XP).

Figureheads with headgear allow the owner to re-roll a single ship-related die roll once in any gaming session. This type includes figurehead with any type of headgear: a helmet, hat, bonnet, flower wreath, etc. This figurehead has 6,000 gp value (1,200 XP).

Armless figureheads protect their ship against ram attacks. Such attacks are at -2 against the ship. This figurehead has 8,000 gp value (1,600 XP).

Armored figureheads increase the AR of the ship against large missile weapons. A *figurehead +1* has 4,500 gp value (900 XP), a *figurehead +2* has 9,000 gp value (1,800 XP), and a *figurehead +3* has 18,000 gp value (3,600 XP).

Full-bodied figureheads (as opposed to the bust or half-bodied figureheads) regenerate and purify air. The figurehead purifies 1d12 man-days of air every day. A *full-bodied figurehead* has a 1,500 gp value (and 300 XP value) per man-day that it purifies.

Eyes-closed figureheads protect their ship against magical location and scrying. It has 20,000 gp value (and 4,000 XP).

Sideways-glancing figureheads give the crew a -1 bonus to their morale checks. The figurehead has 8,000 gp value (1,600 XP).

When creating stronger *figureheads*, the DM should add the values of all combinants to determine the total value. For example, a *sideways-glancing and armored figurehead +2* has 17,000 gp value and its worth 3,400 XP.

Gravitic Stabilizer

This one-ton object looks like a standard keel mount for a 10-ton ship. Originally designed for the Yacht, it has appeared in a few other 10-ton ships as well. The *gravitic stabilizer* rotates the ship to automatically realign with the greater mass whenever the ship is subjected to the effects of another gravity plane. In other words, if the Yacht is rammed by a Hammership, the yacht rotates at the beginning of the next round so its orientation matches that of the Hammership. This is a luxury item that delivers maximum comfort for the crew, thus its extraordinarily high cost.

The *gravitic stabilizer* can be used only on ten-ton ships matching, at least approximately, the keel size of the Yacht. It cannot function on larger ships, and as yet, the arcane refuse to construct larger ones. They sell for 550,000 gp apiece (no XP value), due to their scarcity.

Harpoon, Magical

Magical *harpoons* are large, barbed spears shot by ballista to impale or grapple another vessel or creature. They can have magical bonuses from $+1$ to $+3$. A 100' to 600' rope is attached to an eye at the end of the harpoon, so that the target can be pulled in after it has been hit. Barbs at the front end of the harpoon render it very hard to get out.

Against spelljamming ships, a magical harpoon causes no damage, and it is used mainly as a grappling weapon. Against creatures and crews, however, the harpoon becomes a very lethal weapon. It causes 1d10 points of damage to its target (plus bonus), and another 1d10 when it is pulled out. If more than one harpoon per five hit dice is wedged into a creature, then the creature cannot escape without outside assistance. The harpoon is the preferred weapon of those who hunt kindori and krajen.

Harpoon	GP Value	XP Value
+1	2,000	400
+2	4,000	800
+3	8,000	1,600
cursed -1	1,000	—

Faeriespace: This sphere contains a huge tree, from which hang four suns and eight planets. Any planet can be reached by traveling on the great tree. The four upper worlds are known as *Uppgood* and the lower four are known as the *Vastdarken*. The god-like ruler of this sphere, Aelivere, lives in a fabled mushroom palace at the heart of the great tree (SJA3, *Crystal Spheres*).

Gamaro Base: This huge floating base serves for goblin fleets as the Rock of Bral does for adventuring parties (SJS1, *Goblins' Return*).

7: NEW MAGICAL ITEMS

Bardic Spelljamming Helm

Found primarily on the *lambus*, a vessel used by traveling bards, this helm has a musical instrument attached to it. As long as a bard is strumming, or making music, the ship has the motive power necessary to propel the ship as a major helm. Any bard character, or character with musical proficiencies in the instrument attached to the particular bardic helm, can propel the ship. Often, *lambus* ships will have strange and exotic instruments on their helms, disallowing the possibility of their theft. A *bardic helm* costs 200,000 gp and has no XP value.

Grand Spelljamming Helm

The *grand helm* allows up to four mages or priests to sit and concentrate their magical energies to move a ship. The levels of the mages are added together and divided by four, rounding all fractions up. This number is the SR of the ship. For example, if four mages, levels 15, 5, 6, and 10 were all sitting on the *grand helm*, the ship would have an SR of 9.

When the ship enters spelljamming speeds, the *grand helm* turns the ship partially ethereal. This allows the ship to travel at double spelljamming speeds. At the same time, gravity from a body greater than or equal to 200 tons can pull the craft out of spelljamming speeds into tactical speeds. Since ships smaller than 200 tons will not be pulled out of spelljamming speeds by a ship with this helm, the ships might pass near, or even through, one another without their crews' knowledge.

Because of the *phasing* capabilities of the *grand helm*, a ship possessing it can never enter the phlogiston; nor can it travel there. It must be physically carried by another, more typically-helmed, spelljamming vessel if it is to be transferred to another crystal sphere. Because of this limitation, the *grand helm* is extremely rare outside Realmspace.

The *grand helm* is a very rare version type of helm that, oddly enough, was never manufactured by the arcane. (When asked why they never created a similar *helm*, the arcane, as usual, had no comment.) The *Quad of Thay*, a new spelljamming ship type, uses the *grand helm* exclusively. See the *Ship Recognition*

Manual for more information on this unusual craft. The *grand helm* costs 1,000,000 gp and has no XP value.

Ki-Spelljamming Helm

The *ki-helm* can be manned by up to eight ki-empowered persons. The helm appears as a large onyx circle with the yin-yang symbol within it. In the middle of the circle, a crystalline octagon absorbs the ki energy of those who sit at the helm.

Around the crystal are eight circles engraved into the onyx material of the helm. The ki-endowed helmsmen sit in these circles. Together, the eight helmsmen concentrate their inner strength, while a ninth person, sitting on the crystalline octagon, focuses this power into movement and maneuverability. Without this focal person, the power of the ki is wasted and the ship lies idle.

For every 20 combined points of ki the helmsmen put into the helm, the ship's SR increases by one point. Anything below the required 10 ki, means the ship fails to move. A minimum of 10 ki points are necessary to propel the craft (e.g., 9 points is insufficient to allow SR 1, and 19 ki points only supplies the ship with an SR of 1). The table shows the number of ki points any given oriental character at any level can expend into the *ki-helm*. Remember that some of the character classes have level limits.

A character who spends one day on the *ki-helm* must rest one full day before returning, or his contribution to the total ki is cut in half (rounded down). This penalty continues until the full day of rest is taken.

A character can man the *ki-helm* for 12 hours, or a number of hours equal to his total ki strength as per the chart below (whichever is the lesser). After this time, the ki strength is completely exhausted for the remainder of the day.



Greatspace: This sphere with seven planets is home to an advanced human culture that worships the Greek pantheon and scientific inquiry. The center of population is the third planet, *Thesalys*, overseen by the dominant and benevolent House Shambraht, largest of the five major families. The fourth planet, *Lagor's World*, is most populous, with a riot of human cultures, gnomes, and halflings. The sixth world, the wildwood wilderness planet of *Hecht*, is home to humans and elves of exceptional beauty (SJA3, *Crystal Spheres*).

7: NEW MAGICAL ITEMS

Class	Ki Points Possessed
Barbarian	None.
Bushi	1 point only.
Kensai	1 point at 1st-level. 2 points at 2nd-level. 2 points per level thereafter.
Monk	5 points per level.
Ninja	3 points per level.
Samurai	1 point per two levels.
Shukenja	2 points only.
Sohei	0 points at levels 1-2. 1 point at levels 3-4. 2 points at levels 5+.
Wu Jen	1 point at levels 1-3. 2 points at levels 2+.
Yakuza	1 point per level.

Radiant Spelljamming Helm

This *helm* is used only on drow-constructed ships. It looks like a crown constructed from the legs of a large, poisonous spider. It radiates an aura that can be seen only by those possessing exceptional (120') infravision.

The *radiant helm* functions as a *major helm* in all important respects. The level (or hit dice) of the drow helmsman determines the SR that the helm can generate. The helm can be used only on drow ships because its construction and operation are intimately related to the unusual radiation associated with the drow homeland. The helm somehow utilizes the drow's natural magical abilities, supplemented by a radiation source within the craft. Only a drow or other innately magical creature can use a *radiant helm*. By using the helm, the helmsman loses all innate magical abilities until a full sleep period is taken.

It is believed that all drow ships carry some of the cyst-like ore found in the cavernous realms of the Underdark. The radiation from this ore would allow the drow items to keep their special powers. The adamantite drills of the drow, however, are designed to operate at full force in the light of fireworlds, and are therefore not restricted to using either the radiation of the Underdark or the power of the *radiant helm*.

Helmet of Liaison

These helmets can be purchased for both the *antennae of triangulation* and the *spelljammer detector* magical items. For more information on the *helmet's* purpose, please see these two magical item descriptions. The *helms* can be purchased for 10,000 gp each, and are worth no XP. Without either of the companion items, the *helmet of liaison* is useless.

Helmseeker

The *helmseeker* is a specially enchanted missile fired from a large, ship-mounted weapon. Any large ship-mounted weapon with a range greater than one can use *helmseeker* rounds.

Helmseekers are unlike normal missiles in that they lock onto and move toward spelljamming ships. The missile moves at SR 6 and MC A, just like a ship, and in the missile movement part of the combat round. When fired, the missile moves toward its target. After moving three hexes the *helmseeker* begins tracking. Once within three hexes of a helm in its forward arc, it locks onto the helm's magical emanations. It moves directly toward the target, making any turns necessary to take the shortest route. If it enters the hex of a ship it makes an attack using the weapon's base THACO. If it hits, the ship takes damage and the *helmseeker* is expended. If it misses, in each following missile movement step it immediately targets on the nearest helm in its forward arc. If none, the missile moves straight. Since it tracks on helm magic, it is unaffected by physical obscurement, such as fog, gas, or smoke.

Helmseeker greek fire rounds are possible and can be created for a catapult or a ballista. The greek fire moves at the *helmseeker* speed, but causes greek fire damage.

A favorite tactic for captains targeted by a *helmseeker* is to move behind another slower ship, in order to make the *helmseeker* lock in on the slower craft, or to hide behind a debris field.

This includes the following weapons:

Herospace: A sphere whose nine suns and nine planets match the nine alignments. Holdings are restricted to the worthy; the sphere is controlled by the Rational Order of Magistrates, who are located on the sphere's only moon, Borden (SJA3, *Crystal Spheres*).

Rock of Bral: A major asteroid base from which many adventures can be started, including: SJA2, *Skull & Crossbows*; SJA4, *Under the Dark Fist*; and SJR5, *Rock of Bral*.

7: NEW MAGICAL ITEMS

Shot Type	GP Value/		Size	Volume	GP Value	XP Value
	Shot	XP Value				
Accelerator	1,000	100	10' x 10' x 10'	1 ton	50,000	4,500
Ballista*	250	25	20' x 10' x 10'	2 tons	100,000	5,000
Bombard, Iron**	900	90	20' x 25' x 10'	5 tons	150,000	5,500
Bombard, Stone**	600	60	40' x 25' x 10'	10 tons	250,000	6,500
Catapult*	300	30	50' x 30' x 10'	15 tons	350,000	7,500
Greek Fire	1,500	150	50' x 40' x 10'	20 tons	500,000	10,000
Jettison*	350	35	50' x 50' x 10'	25 tons	750,000	15,000

* Light shot; 150% cost for medium, 200% for heavy.
 ** Great bombard shot is three times cost.

Hold of Holding

The *hold of holding* is actually a knocker that one bolts on the door of the cargo bay. When this item is placed on a door *inside* a ship, it creates a portal to an interdimensional space. The number of knocks and the command word must be known in order to enter this special interdimensional space. Over 80% of these will be 5 tons or less, and only 1% will be of 20 tons or more.

The room inside appears as the rated size, but from outside, the room and the walls appear to be the size the room was before the knocker was attached. This is due to the interdimensional space created within the room. Beings can inhabit both the interdimensional space and the actual room without danger of suffocation.

Those within the actual room cannot leave the room as long as the door to the interdimensional space is open. (The door becomes impassable.) Those within the interdimensional space can leave provided the knocker is still attached to a door and the door is not currently open (thus exposing the original room).

Because of its nature, this magical item ceases to function in the phlogiston, rendering the material in the interdimensional space unavailable until the ship once again enters a crystal sphere. Each *hold of holding* is irrevocably tied to a specific interdimensional location. Therefore, by stealing someone's *hold of holding*, you also steal its contents!

Jettison, Magical

Much like other magical ship-mounted weapons, magical jettisons are a highly desirable addition to any ship. Sixty-five percent of the weapons gain the bonus to their attack and damage rolls. Thirty-five percent of the bonuses listed in the chart apply toward the range (or speed) of the missile being shot. The price, regardless of the enhanced function, is still the same.

Jettison	GP Value	XP Value
Light +1	4,000	800
Light +2	8,000	1,600
Light +3	16,000	3,200
Medium +1	6,000	1,200
Medium +2	12,000	2,400
Medium +3	24,000	4,800
Heavy +1	8,000	1,600
Heavy +2	16,000	3,200
Heavy +3	32,000	6,400

Lantern of Continual Light

These items are popular, especially in the phlogiston. They illuminate the interior of ships with a constant light source without heat. The *lantern's* glass is tinted to dim the *continual light* spell cast within. A hood allows the lantern light to be covered at will.

The item has 300 gp value. For an extra 10 gp, the *lantern of continual light* can have a shutter installed to signal to ships as far as five miles away.

Vodoni Empire: This collection of twelve spheres is the focus of an epic that may leave its forces smashed and scattered. The evil empire is centered in **Vodonispace** and **Vodonikaspace**. Of particular note are **Lostspace**, dead wreck of an advanced civilization, and **Vergonspace**, where the inhabitants of six planets are locked in warfare that rivals that of the beholders (SJA4, *Under the Dark Fist*).

7: NEW MAGICAL ITEMS

Lantern of Spying

The *lantern of spying* looks and functions identically to the *lantern of continual light*. It is, however, even more popular with paranoid ship captains. The lantern allows the individual using it to hear the voices of every person on the ship with clarity, even if they are all talking at once. Whispers and distorted yelling can be clearly understood. The user, however, must be fluent in the languages he is listening to in order to understand them. The lantern does not interpret. By twisting the *wick wheel*, a knoblike projection at the base of the lantern, the user is able to increase or decrease the volume.

If there are more than one *lanterns of spying* on a single ship, the owners hear only a high pitched and irritating whine whenever the *wick wheel* is turned to increase the lantern's volume. No spying can be done when more than one *lantern* is on the same ship. Any magics that defeat *clairaudience* will foil the *lantern*. This item has 8,000 gp value, and is worth 1,600 XP.



Lighthouse

Magical *lighthouses* are small, spherical objects that are normally placed on small asteroids and ships. They magically broadcast their location (via a telepathic process) to a particular imprinted owner. This allows the owner to know in which direction the *lighthouse* lies.

It takes three weeks of constant close contact for an item to imprint upon its owner. After this 21-day period, the *lighthouse* loses any previous imprint, and melds with the new owner (until it is owned by another for the same period). These items have 3,000 gp value each, and are worth 300 XP.

Lyre of the Spheres

This musical instrument is used near a crystal sphere to locate or create a portal that a spelljamming ship can pass through. Any bard can use this item to create a portal. All other characters can use the item only to locate the nearest existing portal. The item can be used but once a week, and has 11,000 gp value, with an XP value of 2,200.

Mage Shot

"Mage shot" is the common name for unusual enchanted *accelerator*, bombard, catapult, or jettison ammunition. Mage shot that misses dissipates harmlessly.

Ring-shot causes any ship constructed totally or partially of metal to ring for 1d4 rounds. At the start of the ringing, every crew member must roll a saving throw vs. spell or be incapacitated with agony one round longer than the ringing. *Ring-shot* has 1,000 gp value per shot and is worth 100 XP.

Dust-shot causes an incredible number of fine white particles to spread throughout the air envelope of the ship. It causes all attack die rolls from the ship to be penalized by -4. During that time, all attacks against the ship are made at a -2 penalty (except *helmseeker* weapons), since the powdery material blocks complete view of the ship within. This dust is not flammable, and magically dissipates in 1d4 rounds. *Dust-shot* has 1,000 gp value per shot and is worth 100 XP.

"I don't know what hit us then . . . the only mage they should have had was their helmsman. Our rigging iced over and the decks got slippery fast. If I hadn't been tethered and wearing heavy clothes, I wouldn't be here now. We sheared off at a fearful angle, and left that galleon as fast as we could jam."

Alcabon Terminus, Privateer

7: NEW MAGICAL ITEMS

Snow-shot causes a large snow storm, with clouds above the gravity plane forming above and below the ship. The snow is so fierce and frigid, it causes 1d4 points of damage to all on the exposed decks (save vs. spell for half damage), unless winter clothing is worn. The snow storm lasts for 2d4 rounds, during which the target ship is obscured, and the snow immediately dissipates at the end of the last round. When the snow disappears it leaves behind a water-damaged vessel (1d2 hull points). *Snow-shot* has 900 gp value per shot and is worth 90 XP.

Masthead of Durability

This small, silver item is nothing more than the lower support for a mast. It physically bolts the mast to the deck, rendering the mast indestructible from all but fire damage. If a ship attempts to shear the mast off, the mast actually tears into the attacking ship, causing 1d2 hull points of damage per 10 tons of the attacking vessel (e.g., if a 40-ton ship attempted a shearing attack, it would receive 4d2 points of hull damage). If the mast is subjected to fire, it is given the normal saving throw. If this roll fails, the mast burns as normal. The *masthead* still functions, but is useless until the burned mast is replaced with a new one. A *mastheads of durability* has 8,500 gp value and is worth 1,700 XP.

Peg Leg of Walking

This magical item can only be used by those who have lost one or both of their legs. By attaching the item to the stump, the peg leg conforms to the precise configuration required for greatest comfort. The *peg leg of walking* allows the recipient to walk at a normal pace, even run, as though whole. This item has 4,500 gp value and is worth 900 XP.

Net of Fishing

This net is used to fish in the wide open seas on worlds. It can operate in the phlogiston (an almost unheard of practice similar to standard ocean fishing). The minimum size fish that a *net of fishing* will catch is 24 inches long, and the maximum size is 100 feet long. If the net is used to capture anything larger

than 100 feet long, the *net* must save vs. acid or break from the strain (treat the net as "rope"). A total of 1,000 pounds of fish can be scooped and brought aboard without any difficulty. Whether there are fish to be caught is up to the DM.

When the *net of fishing* has captured a school of fish, the weight of the catch for purposes of drawing in the net is 1/100th of its actual weight. The net measures 120' by 160'; a total of 19,200 square feet of surface area. The *net of fishing* has 4,000 gp value and is worth 800 XP.

The Plank

This magical item is popular among the piratical and privateering humans throughout the Greyspace crystal sphere. When extended, the *plank* magically stretches far beyond the gravity plane and atmosphere envelope of the ship. Prisoners destined to "walk the plank" are sent out on this plank to be sent adrift in wildspace to suffocate.

On the *plank*, a step taken is actually the equivalent of four steps, meaning a character taking yard-long strides actually moves four yards with every step. This allows the blindfolded plank walker to be set adrift much faster than normal. It also helps alleviate the irritating tendency of prisoners to stand at the brink of disaster overlong. The plank has 3,500 gp value (and is worth 700 XP), and can be extended once per hour.

Magical Ram

Somewhat rare items, magically enhanced rams are highly desirable additions to any ship. The bonus they possess applies to both the attack roll and the damage determination. A *small ram* will fit a ship of 10+ to 40 tons. A *medium ram* will fit a ship of 40+ to 60 tons. A *large ram* will fit a ship of 60+ tons.



Ammunition Supply and Ship Combat

In a role-playing situation, the players run out of ammunition when the DM says they run out. For those who want more detailed recordkeeping, assume 10 shots per weapon are carried.

In a single tactical game, ammunition is usually ignored, although it might be limited by a special game condition. (For example, a Great Bombard might have only 0-2 bombard shots for the game; decided by secret die roll before play.)

7: NEW MAGICAL ITEMS

Ram	GP Value	XP Value
Blunt +1	1,000/ton	50/ton
Blunt +2	2,000/ton	100/ton
Blunt +3	4,000/ton	200/ton
Grappling +1	2,000/ton	50/ton
Grappling +2	4,000/ton	200/ton
Grappling +3	8,000/ton	400/ton
Piercing +1	1,000/ton	50/ton
Piercing +2	2,000/ton	100/ton
Piercing +3	4,000/ton	200/ton

Rudder of Maneuverability

This item grants a vessel a higher Maneuverability Class score. The chart below shows these MC ranges and their values.

MC Given	GP Value	XP Value
E	10,000	2,000
D	20,000	4,000
C	30,000	6,000
B	40,000	8,000
G (cursed)	1,000	—

Rudder of Propulsion

This magical rudder is a specialized item developed by the Kara-Tur empire of Wa to propel their tiny Locust ships. The item is able to propel ships greater than 1,000 pounds (1/2 ton) and less than 4,000 pounds (2 tons), whether in water, wildspace, or the phlogiston. This item gives the craft an MC of A and an SR of 6 (it is unknown whether the rudder will work on a ship constructed of any material other than "thin wood"). The *rudder* looks like a normal rudder one would see on a small oriental rivercraft. The *rudder* creates a small gravitational force behind the ship, pushing it forward.

There are limitations to the item, however. It saves vs. fire at -4. Further, it has insufficient power to escape the gravity well of a planetary body larger than Class A. If the pilot desired, he could land on such a planet, or continually fly about at any altitude desired. He could not leave the confines of the atmosphere, however, without outside help (he could have another spelljamming ship carry him out of the grav-

ity well of the planet).

The *rudder* costs an average of 3,000 gp (and is worth no XP), assuming someone can find a citizen willing to die for treason to part with it.

Rudder of Speed

This item grants a vessel a bonus to its Ship's Rating (SR). The chart below shows these SR ranges and their values.

SR Bonus	GP Value	XP Value
+1	10,000	2,000
+2	20,000	4,000
+3	40,000	8,000
Cursed -1	5,000	1,000

Sails of Maneuverability

These magical sails are made of the same material from which *cloaks of protection* are tailored. When they are in use, they allow the ship to perform as though it were one maneuverability class higher than it actually is. There are four different types of *sails of maneuverability*, each one giving a ship a different MC bonus.

The cursed *sails* are usually the result of a failed enchantment (so they do not register as evil or evilly cursed items). When more than one *sail of maneuverability* is placed on a single ship, the ship only gains the bonus of the strongest sail. The others stay inactive until the stronger is destroyed or removed. When these items are required to make a saving throw, they save as "cloth", with whatever MC bonus they possess as a plus to the saving throw.

Sail	GP Value	XP Value
+1	10,000	2,000
+2	20,000	4,000
+3	40,000	8,000
Cursed -1	5,000	—

Spelljammer Detector

This rare, almost priceless item looks much like a huge insectoid face that stares blankly into the void of space. Commonly 40' long or more, and found on

In a series of games, the following ammunition rule avoids extensive recordkeeping: A ship that fights a battle is assumed to have depleted half its ammunition. A ship that fights a second battle has exhausted its ammunition. Ammunition can be replaced at any port or planet that has the materials available, or by a supply ship carrying extra ammunition.

7: NEW MAGICAL ITEMS

an asteroid or similar base, the detector shows the locations of all man-sized or larger objects within a 20,000-yard radius (40 hexes). A *helmet of liaison* is needed to link the detector to the wearer of the helmet (much as with the smaller *antennae of triangulation*). The helmet relays the information found by the detector in exact detail to the wearer.

When the helmet is put on, the wearer immediately gains a 360° sphere picture of the space around his base. Every minute detail can be seen in his mind. The positioning of these items changes as the base revolves, rotates, changes heading, etc. If there is a chance the user might lose an object being tracked, or that some significant detail might be missed, the user must make a Wisdom check.

Using the detector is fully as fatiguing as manning a spelljammer helm, and is subject to the same requirements for resting afterwards.

The *spelljammer detector* (and a *helmet of liaison*) might be purchased for 300,000 gp or more, depending upon availability and the reaction roll of the seller, but not for less. Additional helmets (of which elven fleets may use as many as 12 on a single asteroid base) can be bought for 10,000 gp each (no XP value). The *spelljammer detector*, can be used as long as a rested user is available.

Statue of Power (Old Salt)

There are several types of *old salt statues of power*. Each appears as a small statue of a sailor a foot or so tall. When the statue is rubbed and the command word (usually engraved on the bottom of the stand) is spoken, its power is activated.

If an *old salt statue of power* is broken or destroyed, it is forever ruined, all magic is lost, and it has no power. If it is slain in its human form, it merely reverts to statue form and can be used again at a later time. They can be used once per day, unless otherwise stated in the following text.

Medic with Bag: At a word, this statue grows to human size. It has AC 10, hp 8, and MV 12. The statue can *cure light wounds* five times per day, *cure serious wounds* twice per day, or *cure critical wounds* once per day. It cannot use more than one cure type in a

single day. Alternately, the statue can *heal* once per week, but this power replaces all other curative powers of which the statue is capable for that week.

The *old salt statue* can only be used to cure an individual once in a single 24-hour period, which means that all five *cure light wounds* cannot be spent on the same individual. The *medic with bag* has 7,500 gp value, and is worth 1,500 XP.

Old Captain with Pipe: Once per day, this statue can be activated to give the ship's captain unerring advice. The advice the statue can give is limited to the direction toward an intended destination, or the advice on how to attack a ship better. (When the latter advice is used, the ship gains a +1 bonus on all initiative and attack rolls for 1d4 rounds.) The statue has AC 4, hp 23, and MV 12. After use, it reverts back to its statue form, leaving behind a pleasant odor of beechwood pipe smoke. The *old captain with pipe* has 9,500 gp value and is worth 1,900 XP.

Pirate with Peg Leg: When this statue is activated, all enemies aboard the ship must roll a save vs. spell or be forced to dance the pirate's jig for 1d6 rounds. During that time, all those who failed the save cannot fight. Those who make their save have their attack rolls penalized by -1. The statue has AC 10, hp 2, and MV 12. If destroyed, its magical effects on the opponents are immediately dispelled. The *pirate with peg leg* has 7,000 gp value and is worth 1,400 XP.

Pirate Mate with Rapier and Parrot: Once per day, this statue can be activated to fight with the ship's crew. With an evilly aligned crew, the statue gains the following statistics: Int Average; AL LE; AC 4; MV 12; HD 6; hp 60; THAC0 15; #AT 3/2; Dmg 1d8+3; SA +3 to hit and damage; SZ M (6' tall); ML 20; XP 650.

With a good or neutrally aligned crew the statue has the following statistics: Int Average; AL N; AC 5; MV 12; HD 5; hp 50; THAC0 16; #AT 3/2; Dmg 1d8+2; SA +2 to hit and damage; SZ M (6' tall); ML 20; XP 420. The *pirate mate with rapier and parrot* has 4,500 gp value, is worth 900 XP, and can be used once per day.

Sails-Boy with Rope: This statue can be activated

Cargo tonnage can be allotted to extra ammunition as follows: Each ton of cargo space used to store ammunition can supply a 50-ton ship for one battle. A ship of 51-100 tons counts as two ships. An overgunned ship counts as two ships. All fractions are rounded up. Thus, a 60-ton, overgunned ship taking supply after a battle would empty 4 tons of the supply ship's capacity.

7: NEW MAGICAL ITEMS

once per day for one hour each use. The *sails-boy* can increase the MC of a spelljamming ship (or even a normal sailing ship) by one class for that time. If killed while performing his duties, the *sails-boy* cannot be reactivated for one full week. Only one can be active on a ship at one time.) It has AC 6, hp 12, and MV 12. The *sails-boy with rope* has 4,500 gp value and is worth 900 XP.

Old Salty with Raincoat: This statue of power has no human form. Instead, it divines the weather for the next 24 hours. (If the weather is being magically tampered with, the sailor's squinty eye glows and the divination will change to match the approaching weather.)

When the weather is divined as being fair, the statue appears as a bare-chested sailor with short legged pants and no shoes.

If the weather is to be stormy and wet, the statue wears a raincoat. If the weather is cold and/or snowy, the statue wears a thick parka and tall, stout boots.

This item is useful in the phlogiston as well, since it predicts the occasional eddies and high and low pressure cross-currents that resemble ocean storms. It operates constantly, and cannot be deactivated or fooled, save by magic. The *old salty with raincoat* has 4,000 gp value and is worth 800 XP.

Skipper with Hat: When this statue is active, it directs the motions of the ship by yelling (often obscene) commands to the helmsman. As a result the ship is able to perform faster than normally. The ship gains a +1 to its SR. The skipper can be used once per day for one hour at a time. If more than one skipper is used on the ship at one time, the number of skippers equals the SR penalty the ship receives instead. With two *skippers with hat* statues, SR 6 turns into SR 4. This penalty arises from the skippers yelling different commands; thus confusing the crew. The statue has AC 2, hp 35, and MV 12. The *skipper with hat* has 5,000 gp value and is worth 1,000 XP.

Swabbie with Bucket: When activated, this statue will clean and polish every deck on the ship. The job takes one round per 5 square feet (keel length multiplied by beam width gives square footage). It continues its job until it either finishes, or until killed. It

has AC 8, hp 12, and MV 9, and can be activated once per week. The *swabbie with bucket* has 3,500 gp value and is worth 700 XP.

Weaponsmaster: This statue takes the place of a whole weapons crew. It can be activated for one hour every day, or until the human form is destroyed. Costing 8,500 gp and worth 850 XP, this statue has AC 4; hp 45; MV 12.

Whaler with Harpoon: When activated, this statue goes to the edge of the ship, armed with its harpoon, and summons fish. Even in the phlogiston, the whaler can summon and spear 1d12 fish every day (each fish averages 1d20+20 inches long). Once the DM-determined number of fish are caught, the whaler returns to its statue form, and cannot be reactivated for 24 hours.

If a large aquatic creature (whale, sea serpent, kraaken, etc.) is attacking the ship, the whaler can, if not previously activated, fight during the encounter with a +2 bonus, inflicting double damage. The *whaler with harpoon* has 4,000 gp value and is worth 800 XP.

Sweeper, Gnomish, Magical

A rare item, and perhaps not terribly useful, but a few magical gnomish sweepers are rumored to exist.

Sweeper	GP Value	XP Value
+1	4,000	400
+2	8,000	800
+3	12,000	1,200

The Pump

The Pump is a spelljamming helm that must be fed material in order to create SR. The type of material placed in *The Pump* will determine the SR that this spelljamming engine generates (see the following table).

Simply stated, one pound of material (10 coins or gems) can move a spelljamming ship of up to 100 tons for one hour. After that, absolutely nothing is left of the material placed in the helm. (If the fuel used was flesh, there is nothing left to *resurrect*.) *The Pump* cannot digest magical items at all. Spell

Reloads for unusual weapons (anything except standard ballista bolts, catapult stones, and jettison shot) cost an extra ton each. (Thus, if the sample 60-ton ship also had a greek fire projector, it would have emptied 5 tons of capacity.) Likewise, special reloads are available in places determined by the referee.

7: NEW MAGICAL ITEMS

books, enchanted swords, and artifacts that are placed in *The Pump* are never metabolized. They are ejected from the ship after being in the helm for over 24 hours.

A particularly gruesome contraption, *The Pump* is a creation of the unhumans; basically for the goblins and goblin races. Since the latest Unhuman Wars began, *The Pump* has increased in potency as well as popularity. Now, every captain in the goblin fleets wants one for his ship.

The goblin's favorite fuel is the slaves they take in their raids throughout wildspace. *The Pump* costs 600,000 gp and no XP value.

SR 1 Material: Cloth, Liquids, Paper, Plant products, Rope, Stone, Wood

SR 2 Material: Copper, Glass, Greek fire, Metal

SR 3 Material: Bone, Ivory, Silver

SR 4 Material: Crystal, Electrum, Flesh, Leather,

SR 5 Material: Ceramics, Gold, Ornamental Gems

SR 6 Material: Platinum, Semi-Precious Gems

SR 7 Material: Fancy Gems, Precious Gems, Gems,

SR 8 Material: Jewels, Mithril Silver*

SR 9 Material: Adamantite**

* One ounce of mithril lasts one turn

** One ounce of adamantite lasts one round

Trident of the Phlogiston

This special weapon was designed by an unknown power, and is extremely old. The blades show centuries of nicking armor. Thousands of polishings, rust removals, and sharpenings are evident. The leather-bound hilt looks worn, tattered, and partially rotted. The trident appears on the verge of uselessness. It is actually a *trident +4*, which causes 1d6 + 5 points of damage to small and man-sized opponents, and 3d4 + 4 points of damage to larger opponents (this damage includes the +4 bonus).

When wielded on a world, it acts as a *trident +4*, and nothing more. When wielded in the wildspace or in hostile other-planar environments, it can purify enough air for one person to use in a single day.

When wielded in the phlogiston, it has the powers

stated above, as well as its greatest power. When the weapon strikes an opponent of opposite alignment to the wielder (as given on the table below), the weapon creates a concentrated bead of fire when the opponent is struck. This detonates on the target, only, the wielder being protected by the length of the shaft. The 2' fireball inflicts 1d3 points of fire damage plus the level of the *trident's* wielder upon the opponent (a 6th level wielder would inflict 7-9 points of fire damage in addition to the trident damage). The oppositions are:

LG—LE
NG—NE

CG—CE
LN—CN

It takes a week for the weapon to adopt the alignment of a new owner, after that time it will register as the owner's alignment if tested.

The gp value of the *trident of the phlogiston* is 18,000 gp, and it is worth 1,800 XP.

Turret, Magical

Somewhat rare items, magically enhanced turrets are a highly desirable addition to any ship. About 10% of all magical turrets will be magically stabilized. They are non-protective, but give a +1 bonus to the attack roll of the weapon.

Most magical turrets, however, are protective turrets. Such a turret adds its magical plus to the standard -4 AC bonus that non-magical protective turrets provide. For example a *turret +2* would give the crew a total AC adjustment of -6; an AC 7 crew would be AC 1.

Second, the turret takes the brunt of any magical attack. If it makes its saving throw, then the protected weapon is unharmed and the crew saves for half damage or none, with a saving throw bonus of +4. If the turret fails its saving throw, then its protective value is destroyed and the crew and the protected weapon save normally. Magical turrets take up the same amount of space as non-magical turrets of the same type.

The following table assumes the magical turret is of ceramic material. Subtract 25% if the turret is bone or thick wood. Add 25% if the turret is metal.

Scro Fleets

When scro fleets appeared on the scene, they took many small craft: Eels, Lampreys, Tradesmen, and others. Now, not only are groups of the large scro warships a worry, but small raiders converted from captured merchant ships are becoming more and more common. Scro raiding crews are usually double the standard number of crewmen for a ship of that type, something to consider when setting out to attack them.

7: NEW MAGICAL ITEMS

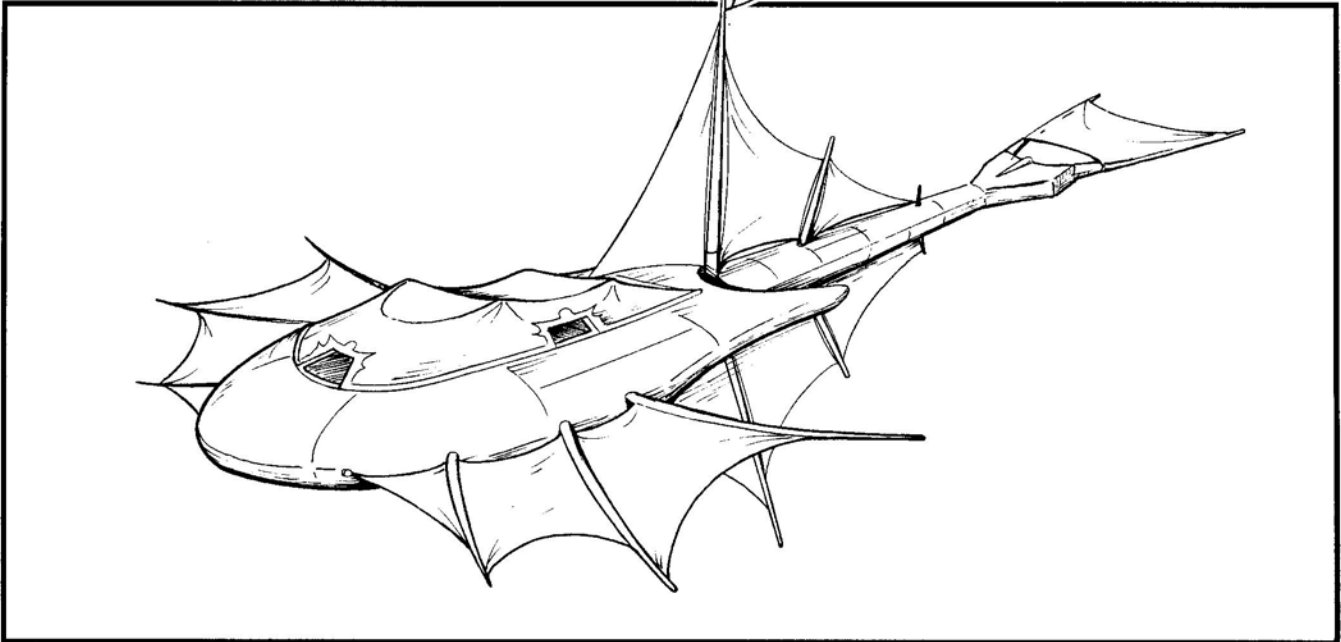

Stone turrets are possible only to races that can manipulate or shape stone (such as xorn, pech, etc).

Turret	GP Value	XP Value
Light +1	4,000	800
Light +2	8,000	1,600
Light +3	16,000	3,200
Medium +1	5,000	1,000
Medium +2	10,000	2,000
Medium +3	20,000	4,000
Heavy +1	10,000	2,000
Heavy +2	20,000	4,000
Heavy +3	40,000	8,000

Unseen Ship Crew

When activated, this magical item (often a bosun's whistle) summons an unseen crew that will increase the number of ship's crew by 50%. The unseen crew are effectively *unseen servants* that perform sailors' tasks (manning sail booms, working rudders, manning oars, etc., depending upon the ship design). The

item can be used once per day for 1d4 + 4 turns, but cannot be activated in the phlogiston.

Though the unseen crew is invisible, some of them can be seen occasionally as they pass through the magical currents of the spelljamming helm. Though these sightings may occur as often as once per turn, the glimpse is only for a brief second.

The *unseen ship crew* works stations that are not currently manned. If an oar is unused, the unseen crew will man that oar, but if a three-man oar was currently manned by only one individual, they would let it alone, manning something else instead. The unseen crew will take proportional losses as if they were 1 HD sailors (including area effect weapons) but can be used the next day.

Captains who possess this magical item tend to have very superstitious crews. Whenever the ship comes into port, the crew often speaks of ghosts manning the sails, throwing a life preserver overboard to a fallen comrade (whether to an unseen crewman or a real one), or looking out from the

The Vodoni

This slave empire, before it was decisively broken, spanned twelve spheres. The Vodoni "enforcers" were huge wolf-like warriors, created by malevolent magics and unspeakable processes and subject to terrible fits of battle rage. Their spelljamming helmsmen were human wizards of nearly archmage level. Undoubtedly survivors remain, just as goblinkind survived the Unhuman Wars.

7: NEW MAGICAL ITEMS

crow's nest.

These rare items are prized by everyone who possesses them. They have a 25,000 gp value and 2,500 XP value.

Urn of Water Purification

This magical copper urn purifies all water placed into it. It has the capacity to hold 30 gallons of fluid, which it purifies at the rate of one gallon per turn. (In the phlogiston, the purification rate drops to one gallon per hour.) The *urn* removes all trace of pollutants, disease, alcohol, poison, salt, dirt, and every other known and unknown thing from the water. All that is left of 100% pure water—the *urn* even turns milk or juice into pure water.

The *urn* looks much like a large jar, with several brass bands reinforcing its curving sides. It has a copper lid which is used primarily to keep excess dirt out, and to keep the water from evaporating too quickly. The lid is nonmagical. These somewhat rare items are valued at 15,000 gp, with an XP value of 1,500.

Vane of Location

This divination device is usually mounted on the foredeck, in the vicinity of the spelljamming helm, or in sight of the navigator. To activate the vane, the helmsman merely needs to ask it where a certain location is: crystal sphere, planet, or similar celestial body, and the *vane of location* points in the immediate direction (even up and down).

The vane points in the direction of the body last requested until that location is arrived at; at which point it spins around slowly, waiting for its next command. The *vane of location* cannot be used to find the location of a specific individual or item. If the *vane* is set for a specific location, and a new location is wanted, a *dispel magic* spell must be cast on the *vane* to make it ready to receive the new command.

If a location specified cannot be determined from another (e.g., two bodies with the same name), the crystal sphere name must be given as well. The *vane of location* has a 10,000 gp value, with an XP value of 2,000 gp. *Lesser vanes*, of half value, are keyed to the countries and cities of specific spheres.

Wakizashi of Honor

This is an extremely rare short sword awarded only to the bravest of commanders in the Wa navy and army. It grants the bearer a +4 to all saves against mind-altering and mind-controlling spells and influences; both magical and natural. For example, the bearer gains the bonus to saves with respect to the *confusion* attack of an umber hulk, the mind altering effects of alcohol, the effects of the *hypnosis* spell, and so on. It does not affect psionic attacks, though it is itself immune to psionic effects. The *wakizashi of honor* has a 12,000 gp value on the open market, and has a 1,200 XP value. In Wa, the sale of such an item is illegal, and punishable by death. All such swords are named.

Ship's Wheel of Maneuverability

When used on a ship that does not have a magical helm (see section on Nonmagical Helms), this device gives the ship a greater MC. A ship cannot be helped by this item if its MC is already equal to or greater than that of the available wheel. The table details the different types of *ship's wheel of maneuverability* that are most commonly available.

MC Given	GP Value	XP Value
E	10,000	1,000
D	20,000	2,000
C	40,000	4,000
B	80,000	8,000
G (cursed)	2,000	—

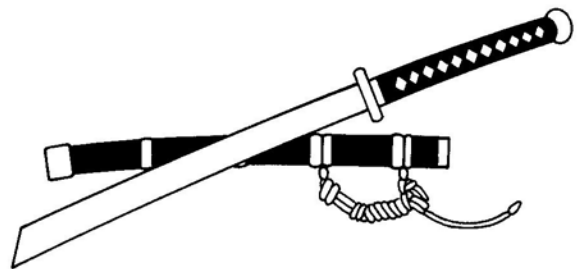

"They'll be back."

Sarelk the Sage
—A Prediction

THE SHIP RECORD SHEET

The Ship Record Sheet is a convenient way to keep track of the status of the ship and crew during play. Each ship should have its own sheet (sometimes a group of very small ships, such as elven Flitters, will be recorded on a single sheet).

This section describes in detail how to fill out a Ship Record Sheet. Use a pencil to fill in the sheet, as many entries will change during play. If a ship will be used often, you may wish to make a master copy of its sheet to reduce the time needed to set up a game.

Ship Name: Write in the name of the ship; for example, "Starfire II." If part of a group, just the ship type and an identifier can be given; for example, "Cog B."

Ship Type: This is the type of ship as listed in the *Ship Recognition Manual*; for example, "Elven Man-O-War."

Player Name: The player's name.

Company Name: The company or adventuring group that owns the ship; for example, "The Wildfire League."

Hull AR: The Armor Rating of the ship, as listed in the *Ship Recognition Manual*.

Hull Point Total: The original number of hull points from the *Ship Recognition Manual*, one hull point per ton.

Hull Points Remaining: This is where you keep track of hull point losses. Unless the ship has been previously damaged, this line starts blank.

Total Initiative Modifier: Write in all the modifiers that apply, those for MC, crew quality, etc., as listed in *Combat Among the Stars*, page 5. Long-lasting initiative modifiers from magical items or spells can be written in as they occur.

MC: Write in the Maneuverability Class of the ship, as listed in the *Ship Recognition Manual*.

Change of Face, Speed, and Reverse: Record information from Table 3-1 in *Combat Among the Stars*.

SR: Write in the Ship's Rating of the ship, based on the type of *helm* powers it (see Tables 5-10 through 5-12 in the *War Captain's Guide*).

Current Speed: This is the speed of the ship during each round of play. Starting speed is usually set just before play begins.

Ram Type: Write in the ram type (Blunt, Piercing, or Grapple). Also note if the ram has a forward or aft position; for example, a neogi Mindspider has a forward grappling ram and an aft piercing ram.

Ram THACO: This is the helmsman's or navigator's THACO as given in *Combat Among the Stars*.

Damage: Write in the ram damage multiplier ($1/10 \times$ Tonnage), if the ship has a blunt or piercing ram.

Save As: This is the type of material the ship saves as; for example, "Metal", "Ceramic", etc.

Attack Types: Write in the ship's saving throw vs. each of these attack forms, as given in *Combat Among the Stars*.

Special Notes: Any special notes about the ship or crew; for example, the Triop's special movement. This space can also be used to keep track of repairs (which cannot exceed 20% of the ship's hull points).

Total Fire Damage: This space is used to record fire damage, which may result in fouled air.

Air: The spaces for "Fouled" and "Deadly" air are marked when the ship's air reaches that state. Players may wish to record in these blanks in parenthesis how much fire damage will yield these results.

Special Ammunition (Helmseekers): Record the number and type of any unusual ammunition carried.

Standard Armament: Record the details of the weapons carried on the ship.

Weapon: Ballista, catapult, jettison, etc.

THACO: From the Weapon Table.

Crit. Hit #: From the Weapon Table.

Hull Damage: From the Weapon Table. Note that in the tactical game, this number is also used for crew losses.

Crew Damage: From the Weapon Table, the amount of damage caused in a role-playing game.

Range: From the Weapon Table.

Fire Arc: From the *Ship Recognition Manual*.

ROF: Rate of fire; from the Weapon Table.

Crew Needed: The standard crew; from the Weapon Table.

Current Crew: This space is used in play to record crew losses.

Last Rnd. Fired: This space is used in play to record the number of the most recent round in which the weapon fired.

Built By; Keel; Beam; Tonnage; Cost; Cargo Capacity; Landing Capacity: These are role-playing game details that can be copied out of the *Ship Recognition Manual*.

Special Mod.: Record here any special modifications that have been made to the ship (such as bonuses from shipyards or ship improvements).

THE SHIP RECORD SHEET

The Ship Crew Section

Starting Crew Number: Write in the minimum and maximum number of crew from the *Ship Recognition Manual*.

Crew Quality: This is an overall rating of a crew's training and experience. From lowest to highest, these ratings are Green, Average, Trained, and Crack. Crew quality affects initiative, grappling, and morale. Write in the crew quality; for example, "Average."

Crew Morale: Morale Rating (MR) is a measure of a crew's willingness to fight. An average value is 12 on a scale of 2 to 20. A high number is better than a low number. Write the crew's original morale in the brackets; use the rest of the space to record changes in morale during play.

Crew: Fill in the details of the ship crew in this section, using one line for each combination of Type, AC, THACO, and HD. PC's can use the "Special" blanks if necessary.

No.: This is a table for a 2d6 roll, which determines which crew are hit by missile fire and melee attacks. Note that a roll of "2" will hit either the helmsman or the navigator, and that a roll of either "5" or "6" will hit marines. The "Crew" lines (07) are used to record crew not assigned to a special crew function at the start of play.

Title: This is the position held by the crewman. These will be defined in greater detail later.

Type: Usually a racial name: Elf, Dwarf, Goblin, etc.

AC: Armor Class defines the degree of protection worn by the crew (as rated in the AD&D® rules). Lower numbers are better than higher numbers. See the Crew Summary table on the back of the *Ship Recognition Manual* for AC ratings.

THACO: The roll on 1d20 necessary for the crewman to hit armor class 0; see the Crew Summary table.

Number: The number of crew of that type on the ship.

HD: The number of hit dice (or levels) of the crewman. This is the number of hits a crewman or individual can take before being killed.

Crew Left: This space is used to keep track of crew losses in play. Crew will usually take losses in hit dice.

Crew Titles

This section defines the crew titles and suggests some average values for tactical games.

Captain: The captain, an individual of 7th to 12th level (1d6+6), commands the ship. Losing a captain causes morale penalties. All ships have a captain.

First Officer: The first officer is an individual ranking just after the captain. The first officer tends to be two (2) levels lower than the captain. If the captain is killed, the first officer takes over as captain at the end of the round. Ships with more than 10 crewmen usually have a first officer.

Helmsman: The helmsman, an individual of 6th to 13th level (1d8+5), causes the ship to move (a victim in a lifejammer helm is considered a helmsman). All ships have a helmsman.

Navigator: The navigator, an individual of 6th to 11th level (1d6+5), must be found on ships with a series or pool helm, but is otherwise optional. Often a second helmsman doubles as a navigator.

Officers: At least one officer is required per 10 crewmen (the captain and first officer count as officers for this). Other officers are usually lower level than the first officer, and 1-2 levels higher than the crew. If officers are lost, the crew must check morale. Officers are individuals.

Crew: Standard crew members of 1st to 3rd level (1d6 divided by two, round up) work the ship. The crew is further divided into specialized groups as noted below. In general, crew of all types are organized into sections of five crewmen when attacking or taking losses.

Sailors: Crew, of 1st to 3rd level, are crew assigned to ship-handling duties. If their number (including officers, helmsman, and navigator) is less than the minimum crew required to run the ship, the ship's *maneuverability class* suffers. Sailors tend to be lightly armed and armored so they can do their job more effectively.

Weaponers: Weaponers, of 1st to 3rd level, work the large ship-mounted weapons such as catapults and ballistae.

Marines: Marines, of 2nd to 5th level (1d4+1), are trained to fight in hand-to-hand combat. They tend to be more heavily armored, have higher morale, and may have small missile weapons. Not all ships have marines.

Special: These individuals include any unusual non-player characters or monsters on the ship. Used by special game condition, the most common specials will be wizards of 6th-11th level (1d6+5).

PCs: These individuals are any player characters on the ship. Their presence is usually by special game condition.

Crew Quality: Quality can be determined randomly before a game by rolling 1d10:

1-2 Green, 3-7 Average, 8-9 Trained, 0 Crack

Nonhuman Crews: The guidelines for crew levels assume a human or demihuman crew. Creatures with more than one hit die use their base hit dice instead. Nonhuman officers usually have 1 hit die more than the base, and captains have 2-4 hit dice more, though this may vary by creature type.

SPELLJAMMER SHIP RECORD SHEET

Ship Name: _____
 Ship Type: _____

Player Name: _____
 Company Name: _____

Hull (AR): _____ Hull Point Total: _____
 Hull Points Remaining: _____

Built By: _____
 Keel Length: _____ ft Beam Length: _____ ft
 Tonnage: _____ Cost: _____ gp
 Cargo Capacity: _____
 Landing Capacity: Land: _____ Water: _____
 Special Mod.: _____

Helm Type: _____
 Total Initiative Modifier: _____
 (Crew + MC Mod.)
 MC: _____ SR: _____
 CHANGE: Face: _____ Speed: _____ Reverse: _____
 SR _____
 Current Speed: _____

Starting Crew Number: _____ / _____
 Crew Quality: _____
 Crew Morale: _____

Ram Type: _____ Damage: Current Speed × _____
 Ram Type: _____ Damage: Current Speed × _____
 Pierce/Blunt/Grapple Tonnage/10
 Ram THACO: _____
 Saves As: _____ Mag. Fire: _____
 Acid: _____ Norm. Fire: _____
 Cr. Blow: _____ Cold: _____
 Disint.: _____ Lightning: _____
 Fall: _____ Electricity: _____

Crew:	No.	Title	Type	AC	THACO	Number	HD	Crew Left
	02	Helmsman						
		Navigator						
	03	Captain						
		First Off.						
	04	Officers						
	05	Marines						
	06	"						
	07	Crew						
	08	Weaponers						
	09	Sailors						
	10	"						
	11	Special						
	12	PCs						

Special Notes: _____

Total Fire Damage: _____
 Air: Fouled _____ Deadly _____

Special Ammunition: _____
 (Helmseekers): _____

Standard Armament:

Weapon: _____ Range: _____
 THACO: _____ Fire Arc: _____
 Crit. Hit #: _____ ROF: _____
 Hull Damage: _____ Crew Needed: _____
 Crew Damage: _____ Current Crew: _____
 Last Rnd. Fired: _____

Weapon: _____ Range: _____
 THACO: _____ Fire Arc: _____
 Crit. Hit #: _____ ROF: _____
 Hull Damage: _____ Crew Needed: _____
 Crew Damage: _____ Current Crew: _____
 Last Rnd. Fired: _____

Weapon: _____ Range: _____
 THACO: _____ Fire Arc: _____
 Crit. Hit #: _____ ROF: _____
 Hull Damage: _____ Crew Needed: _____
 Crew Damage: _____ Current Crew: _____
 Last Rnd. Fired: _____

Weapon: _____ Range: _____
 THACO: _____ Fire Arc: _____
 Crit. Hit #: _____ ROF: _____
 Hull Damage: _____ Crew Needed: _____
 Crew Damage: _____ Current Crew: _____
 Last Rnd. Fired: _____

APPENDIX: INSPIRATIONAL READING

The TSR game products listed below are suggested for full utilization of the material printed herein. They are not necessary for play, it only helps in establishing atypical backgrounds and uniqueness to the distinctive places a spelljamming crew can drop anchor. This is necessary in a long-standing campaign, since players can weary of landing on planets that all appear and feel similar.

The City of Greyhawk 1043

This **WORLD OF GREYHAWK**® boxed set details the greatest city on Oerth: The Free City of Greyhawk. An important spacefaring port in Greyspace, its details are vital to the spacefarers who port here often. The set fully details the city, its unique people, their customs, and its laws. A large poster map of the city is included.

City System 1040

It is called the City of Splendors: Waterdeep, the most populous and powerful of the cities of the North. It is a city of wealth, adventure, and danger. This **FORGOTTEN REALMS**® boxed set includes 12 maps of this incredible city, 10 of which fit together to form the complete map of the city.

Complete Spacefarer's Guide 2130

This 128-page **SPELLJAMMER**™ accessory gives everything the players need to survive in wildspace, from new proficiencies to innovative equipment. This booklet is designed along the parameters of the **COMPLETE CLASS** handbooks. (Coming soon.)

Crystal Spheres 9299

This **SPELLJAMMER**™ adventure takes the characters to an area of space known as Greatspace, where whole worlds are controlled by individual alignments. Included is the first poster showing the relative sizes of many ships.

DRAGONLANCE® Adventures 2021

This **DRAGONLANCE**® hardbound rule book details the game mechanics of this epic world. New character and NPC races are detailed herein, as well as a slew of new monsters, a timeline of Krynn's history, and the chronicles of the Solamnic knights.

Dungeon Master's Screen 9313

This **SPELLJAMMER**™ accessory gives the DM a wide range of charts and tables that are commonly used in play. The other side of the screen features a panoramic view for the players. Also included are eight sheets of 3-D ship fold-ups that are perfect for use with the combat rules supplied in the War Captain's Companion set.

FORGOTTEN REALMS® Adventures 2106

This **FORGOTTEN REALMS**® hardbound rule book describes the world of Toril after the Avatar crisis. New spells, the deity's avatars, and further explanation of important cities and secret societies are its greatest strengths.

FORGOTTEN REALMS® Campaign 1031

This boxed set describes the entire world of Toril, in Realspace, with great detail regarding the Dalelands. Cities like Waterdeep, an important spacefaring port, are described.

Goblin's Return 9343

At one time, goblins and their kind were overthrown by the elven armadas in a 1,000 year war. Now, the goblins are back with a vengeance. This recent **SPELLJAMMER**™ adventure begins the second of the Unhuman Wars.

Greyspace 9374

This **SPELLJAMMER**™ accessory details the the crystal sphere that contains Oerth. Those who spend hours spelljamming or in the **WORLD OF GREYHAWK**® setting will find this supplement invaluable. (Coming soon.)

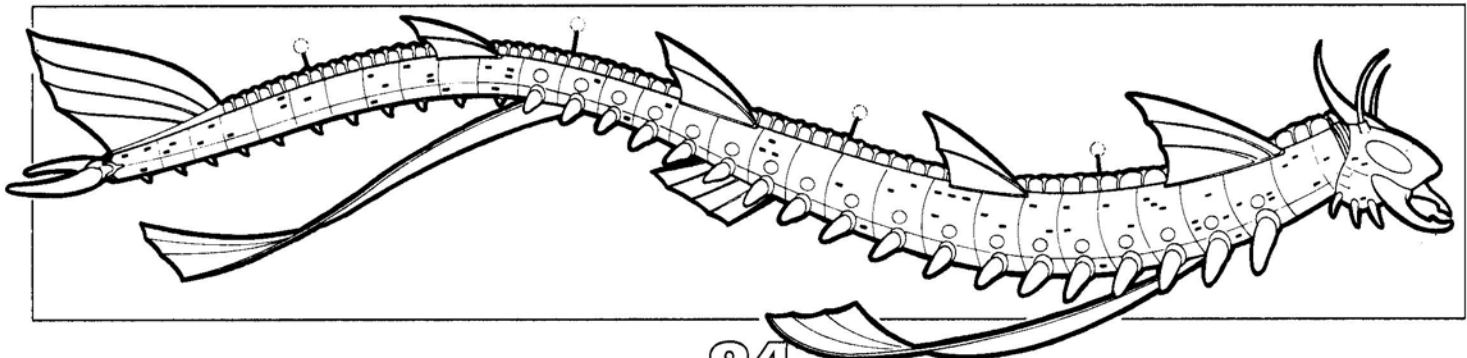

APPENDIX: INSPIRATIONAL READING

Heart of the Enemy 9347

This SPELLJAMMER™ adventure continues the terror and unimaginable violence of the second Unhuman Wars.

KARA-TUR The Eastern Realms 1032

This FORGOTTEN REALMS® boxed set describes the oriental cultures of the planet Toril. Wa, Shou Lung, and many other countries are detailed.

The Legend of Spelljammer 1065

This SPELLJAMMER™ boxed set details the great *Spelljammer* herself, and the characters and races that call her home. New ships, spelljamming helms, and spacefaring items are listed as well.

Lost Ships 9280

This SPELLJAMMER™ accessory combines new ships with adventures into lost areas of space. Unknown and lethal monsters fill these 96 pages with things DMs love and players hate.

Monstrous Compendium Volume 4 2105

This, the fourth supplement of the ever-popular Monstrous Compendiums, details the major DRAGONLANCE® Setting monsters, including the Draconians and the fey Death Knights.

Monstrous Compendium Volume 7 2109

This is the first set of monsters for the SPELLJAMMER™ campaign.

Monstrous Compendium Volume 9 2119

This is the second set of new monsters for the SPELLJAMMER™ campaign.

Practical Planetology 9328

This SPELLJAMMER™ accessory details 15 new planets, and 10 new monsters to chill your spelljamming blood.

Realmspace 9312

This SPELLJAMMER™ accessory opens the FORGOTTEN REALMS® campaign to the ever-expanding universe. A must-have for all serious spelljamming players and DMs alike. Includes a map of Realmspace, new creatures, and three new ships to put zest into the game.

Rock of Bral 9361

This 96-page SPELLJAMMER™ supplement details the most famous asteroid base. The characters who run the base, and more who do not, are described herein. (Coming soon.)

Skull and Crossbows 9286

Looking for adventure and swashbuckling fun? This SPELLJAMMER™ adventure has it all. From battling space pirates to talking your way out of interstellar war, this challenging collection of adventures will provide hours of role-playing fun.

SPELLJAMMER™ Boxed Set 1049

The SPELLJAMMER™ boxed set was the first glimpse into AD&D® Adventures in space. Herein lie the rules, the original ships, the spacegoing races, the NPCs, and the sciences that started it all. This is the foundation of the line and the only other product needed to properly use the *War Captain's Companion*.

Time of the Dragon 1050

This DRAGONLANCE® boxed set details the city of Kristophan and the continent of Taladas (the "other side" of the world). Here, minotaurs are as prevalent as humans are elsewhere.

Under the Dark Fist 9325

A sphere-spanning SPELLJAMMER™ epic for experienced adventurers in high level campaigns, this adventure is a lethal penetration into the heart of enemy territory. Only the strong will survive, and then only if they are lucky!

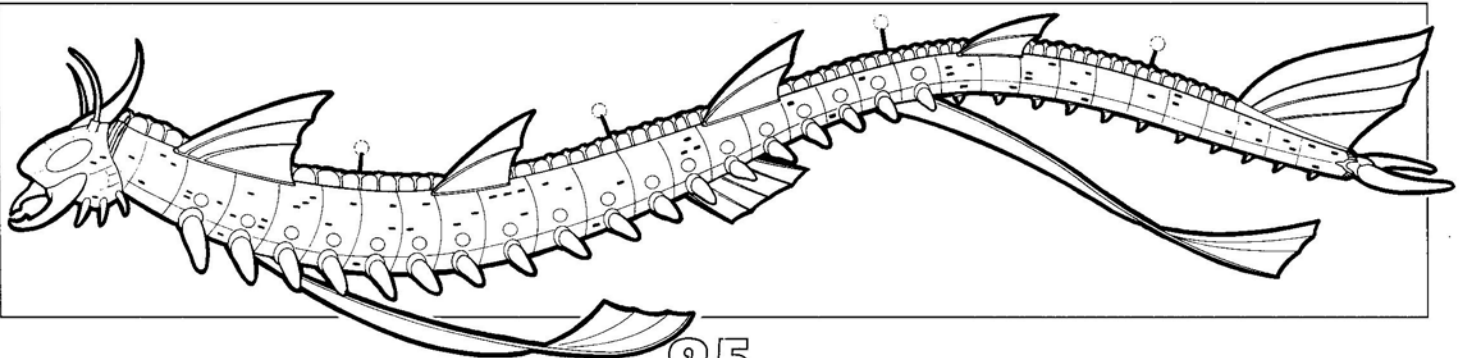

IF YOU LIKED WAR CAPTAIN'S COMPANION...



**Wanted: A
FEW GOOD
MEN to spoil
the GOBLINS'
plans . . .**

The Unhuman War is about to return with a vengeance. Incensed by defeat and expulsion from the Known Spheres, the goblins are planning a surprise party for the elves . . . and it's been a few hundred years in the making.

Centuries ago, the goblinkin were purged from the Known Spheres. Driven to the depths of space, their legions of orcs, hobgoblins, kobolds, bugbears and ogres have plotted their revenge, and their day of reckoning is about to arrive. And considering the destruction they're plotting, *revenge* is an understatement.

So the elves are in a fix. Needless to say, they're looking for a few good *volunteers* to infiltrate an orc base and steal

their war plans. Sound familiar?

Can you help the Elven Armada stop the massive war fleet? Your PCs can become heroes or bite the bullet trying.

Find **Goblins' Return** on sale at book and hobby stores everywhere. It's the first of an exciting two-part module series set in the second Unhuman War. It can also be linked with **Heart of the Enemy**.





ADVANCED DUNGEONS & DRAGONS is a registered trademark owned by TSR, Inc.
SPELLJAMMER and the TSR logo are trademarks owned by TSR, Inc.
©1992 TSR, Inc. All Rights Reserved.

1072XXX1901

Advanced Dungeons & Dragons
2nd Edition

SPELLJAMMER™

Accessory

Ship Recognition Manual

War Captain's Companion: Book 2

Ships by Tonnage

Ship Name	Tonnage	Race	Ship Name	Tonnage	Race
Spelljammer	1,500,000	Unknown	Whelk	30 - 40	Gnome
Space Leviathan	400	Unknown	Porcupine Ship	30	Goblin
Citadel	300 - 700	Dwarf	Quentin's Libraria	30	Human
Stoneship	300	Xorn	Shrikeship	30	Elf, Halfling, Human
Tsunami	200	Human (Wa)	Sidewheeler	30	Gnome
Zooecraft	200	Any	Unity Ship	30	K'r'r'r
Argosy	150	Grav	Vagabond	30	Human (Aperusa)
Armada	100	Elf	Vipership	29	Human
Cuttle Command	100	Human, Mind Flayer	Lamprey Ship	26	Human, Goblin
Deathspider	100	Neogi	Bolaship	25	Gnome
Jade Spider Commandship	100	Drow	Cargo Barge	25	Human, Mind Flayer, Neogi
Monarch Class Armada	100	Drow	Radiant Ship	25	Elf
Vodoni Diamond	100	Vodoni	Tradesman	25	Any
Drædnought	90	Mind Flayer	Tyrant Ship	23	Beholder
Flying Pyramid	90	Undead	Cog	20	Human (Groundling)
Mammoth	90	Ogre, Human, Mind Flayer	Dolphin-Shuttle	20	Any
Whaleship	90	Human, Mind Flayer	Eel Ship	20	Human
Battlewagon	80	Scro	Great Galley	20	Human (Groundling)
Battle Dolphin	70	Any	Jade Spider	20	Drow
Deathglory	70	Gnome	Junk	20	Human (Shou Lung)
Leaf-Ship	70	Thri-kreen	Klicklikak	20	Insectare
Octopus	70	Human, Mind Flayer	Leech	20	Neogi
Clipper	65	Giff	Smalljammer	20	Any
Quad of Thay	63	Human	Wasp	18	Human, Lizardman
Barge of Ptah	60	Human	Dromond	16	Human (Groundling)
Galleon, Spacesea Giant	60	Spacesea Giant	Tyrant Scout Ship	13	Beholder
Hammership	60	Elf, Human, Lizardman, Mind Flayer	Xebec	12	Human (Groundling)
Hunter-Killer	60	Vodoni	Skeleton Ship	1 - 12	Undead
Man-o-War	60	Elf, Human	Caravel	10	Human (Groundling)
Mantis	60	Scro	Coaster	10	Human (Groundling)
Scorpion	60	Orc	Damselfly	10	Human
Werewolf	60	Vodoni	Dragonfly	10	Elf, Human
Antlership	50 - 100	Undead	Drakkar	10	Human (Groundling)
Bloatfly	48	Lizardman	Yacht	10	Human
Batship	45	Human	Yawl	7(10)	Gnome
Dragonship	45	Human (Shou Lung)	Hummingbird	7	Human
Squid Ship	45	Human	Mosquito	6	Any
Triop	45	Gnoll, Goblin, Human, Mind Flayer	Corbina	5	Aarakocra
Galleon	40	Human (Groundling)	Scalpel Ship	5	Xixchil
Great Bombard	40	Giff	Longship	4	Human (Groundling)
Mindspider	40	Neogi	Wreckboat	4	Human
Nightwolf	40	Vodoni	Thorn-Ship	3	Thri-kreen
Turtle Ship	40	Human, Lizardman, Mind Flayer	Urchin	3	Neogi
Uspo	40	Dohwar	Arrow	2	Kobold
Eagle Ship	35	Aarakocra	Blade	2	Goblin
Iambus	35	Human	Catamaran	1	Human
Nautiloid	35	Mind Flayer	Flitter	1	Elf
Angelship	33	Kobold	Yawl Wagon	1	Gnome
Swan Ship	32	Elf, Giff, Halfling, Human, Mind Flayer	Locust	³ / ₄	Human (Wa)
			Skiff	¹ / ₃ - ¹ / ₂	Rock Hopper
			Wraith	Variable	Undead

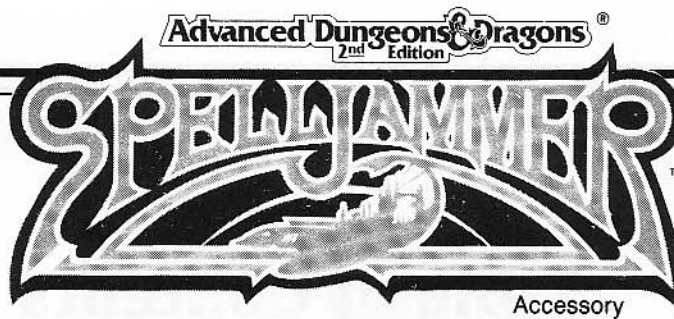

Ship Recognition Manual

War Captain's Companion: Book 2

CREDITS

Design: Dale "Slade" Henson
Editing: John D. Rateliff
Cover Painting: Eric Olson
Cartography: Diesel

Internal Art: Mark Nelson, Diesel,
Stephen D. Sullivan
Typography: Angelika Lokotz

Thanks To: Anne Brown, Timothy B. Brown, David "Zeb" Cook, Andria Hayday, Colin McComb, Bruce Nesmith, Jon Pickens, Steven Schend, Dori "The Barbarian" Watry, and Steve "Old Man" Winter.

Very Special Thanks: Jeff Grubb and James M. Ward.

ADVANCED DUNGEONS & DRAGONS is a registered trademark owned by TSR, Inc.
SPELLJAMMER and the TSR logo are trademarks owned by TSR, Inc.

Random House and its affiliate companies have worldwide distribution rights in the book trade for English language products of TSR, Inc.

Distributed to the book and hobby trade in the United Kingdom by TSR Ltd.

Distributed to the toy and hobby trade by regional distributors.

This SPELLJAMMER accessory is protected under the copyright laws of the United States of America. Any reproduction or other unauthorized use of the material or artwork herein is prohibited without the express written permission of TSR, Inc.

Printed in the U.S.A. Copyright © 1992 TSR, Inc. All Rights Reserved.

TSR, Inc.
P.O. Box 756
Lake Geneva
WI 53147
U.S.A.



TSR Ltd.
120 Church End
Cherry Hinton
Cambridge, CB1 3LB
United Kingdom

ISBN 1-56076-343-3

Table of Contents

Introduction	4	Leaf-Ship	31
Definition of Terms	5	Leech	31
Ships of the Spelljammer Universe	6	Locust	32
Angelship	6	Longship	32
Antlership	6	Mammoth	33
Argosy	7	Man-o-War	33
Armada	7	Mantis	34
Armada, Monarch Class	8	Mindspider	35
Barge of Ptah (Battle Barge)	8	Mosquito	35
Batship	9	Nautiloid	36
Battlewagon	10	Nightwolf (Vodoni Scout)	36
Blade (Arrow)	10	Octopus (Tailgunner)	37
Bloatfly	11	Porcupine Ship (Spine-Ship)	37
Bolaship	11	Quad of Thay	38
Caravel	12	Quentin's Libraria	39
Cargo Barge	12	Radiant Ship	39
Catamaran	13	Scalpel Ship	40
Citadel	13	Scorpion	40
Clipper	14	Shrikeship	41
Coaster	15	Sidewheeler	41
Cog	15	Skeleton Ship (Boneship)	42
Corbina	16	Skiff	42
Cuttle Command	16	Smalljammer	43
Damselfly	17	Space Leviathan	43
Deathglory	17	Spelljammer	44
Deathspider	18	Squid Ship	44
Dolphin, Battle	18	Stoneship	45
Dolphin-Shuttle	19	Swan Ship	45
Dragonfly	19	Thorn-Ship	46
Dragonship	20	Tradesman (Fish Ship)	46
Drakkar	20	Triop	47
Dreadnought	21	Tsunami	48
Dromond	21	Turtle Ship (Battleboat)	49
Eagle Ship	22	Tyrant Scout Ship	49
Eel Ship	22	Tyrant Ship	50
Flitter	23	Unity Ship	50
Flying Pyramid	23	Urchin	51
Galleon	24	Uspo, Dohwar	51
Galleon, Spacesea Giant	24	Vagabond	52
Great Bombard	25	Vipership (Darkviper)	52
Great Galley	25	Vodoni Diamond	53
Hammership	26	Wasp	53
Hummingbird	26	Werewolf (Vodoni Butcher)	54
Hunter-Killer (Vodoni Assassin)	27	Whaleship	54
Iambus	27	Whelk	55
Jade Spider	28	Wraith	55
Jade Spider Commandship	29	Wreckboat	56
Junk	29	Xebec	56
Klicklikak	30	Yacht	57
Lamprey Ship (Striker)	30	Yawl	57
		Yawl Wagon	58
		Zoocraft (Ark; Gardenship)	58

Table of Contents

Other Ship Configurations	59	Flitter, Wild	60
Bee Class Wasp	59	Gnat	60
Black Widow	59	Hammership, Heavy	60
Bombard Ram	59	Juggernaut	61
Broodship Lander	59	Killer Whales	61
Bumble Bee	59	Man-o-War, Wild	61
Damselfly, Super-Heavy	59	Narwhal	61
Domed Deck	59	Power Whelk	61
Dragonfly, Heavy	59	Snowflakes	61
Dreadnought, Heavy	59	Speed Clipper	61
Dreadnought, Pirate	60	Stinger	61
Firefly	60	Tradesman, Light Cruiser	61
Firewinds	60	Tyrant Rammer	61
Flaming Dragons	60	Tyrant Wrecks	61
Fleet-Footed Wasp	60		
Flitter, Depowered	60	Blank Ship Work Sheets	62
		Assembly Instructions	63

INTRODUCTION

... Looking through eyes of terror, Captain Icarus scanned the stygian depths of wildspace. He knew it was out there: taunting, flexing its claws, waiting for the right time to strike. Suddenly, Fingers, the rogue crew member, screamed in terror and agony as a ballista shot sliced through his unprotected chest, spilling his dark, red blood onto the deck of the ship. The crew erupted in cries of panic, many running for the Wreck-boats.

Frantically, Icarus screamed orders to his elven crew as the abomination flew into the Man-o-War on bated wing, but his voice fell on deaf ears. All they could do was gasp in horror as the 180-foot terror bit into the flesh of the ship, its monstrous, crystalline claws raking the tender underbelly with jaw-shattering scrapes. The spellcasters returned fire with their cache of spells, only to have them reflected back with un-

daunted severity.

The pirates swooped onto the elven ship in a fury unmatched since the Unhuman Wars. Never before had Icarus believed he would meet his match. He scanned the dead and dying remnants of his crew and wept. Icarus bent his head, preparing for the worst. "How do you fight such a beast?" he thought as a merciless pirate charged at him with her halberd. The only answer he received was the tear flowing down his cold cheek...

"How do you fight such a beast?" This question has flowed across many a captain's lips as he faces seemingly unstoppable opponents. Undoubtedly, these same words fell from your lips as well. If so, this manual is for you.

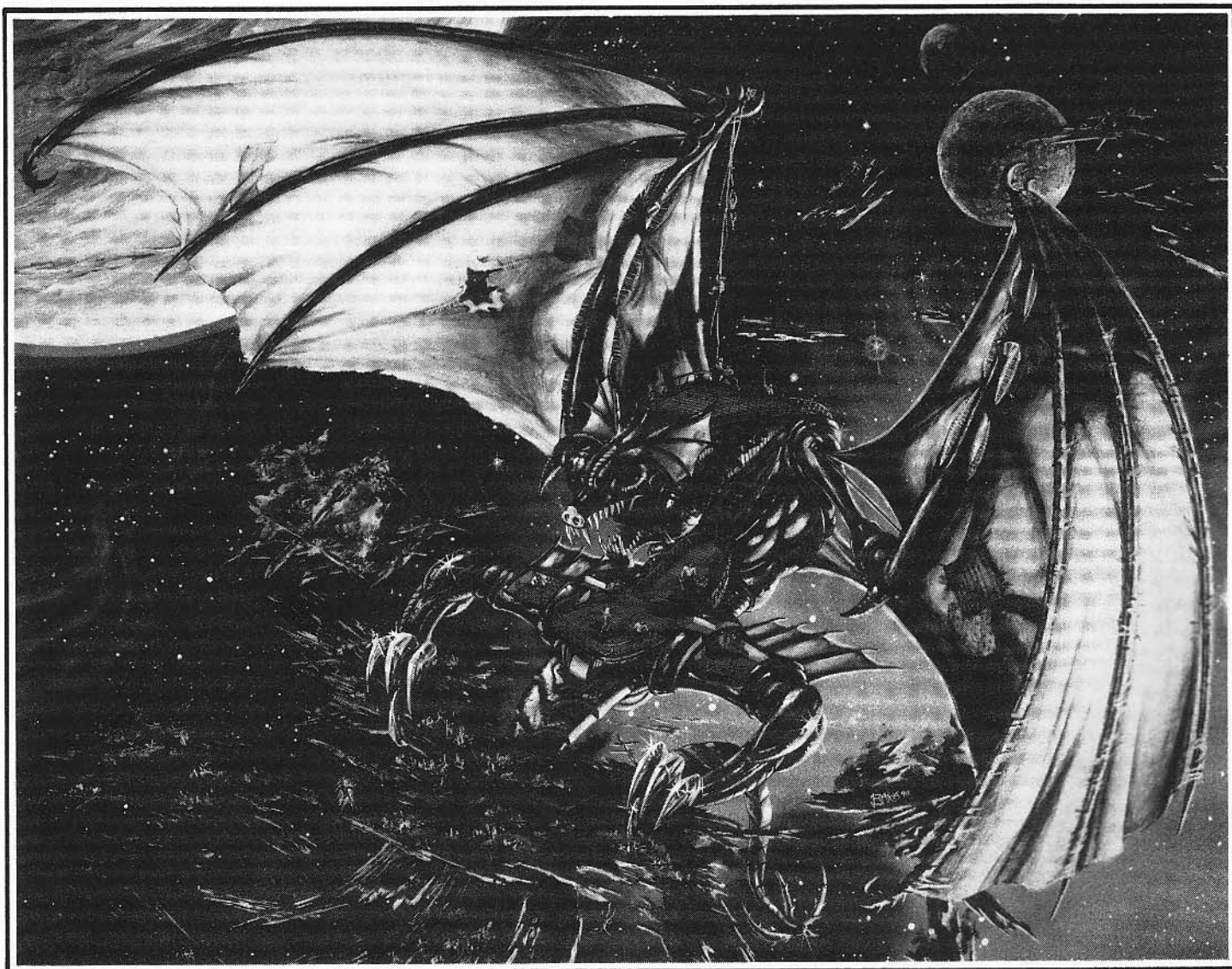

DEFINITION OF TERMS

Name: common name of the ship type described.

Built By: the races that build this type of ship.

Used Primarily By: the major races that use this type of ship. Other races may use this ship type, but those listed are the most common.

Cost: the price the Arcane charge for the craft in new, unmodified condition. Modified, upgraded, or damaged condition can vary the price greatly.

Tonnage: the tonnage of a ship determines its Hull Points as well as the amount of crew and passengers that may safely be aboard.

Hull Points: the amount of damage the ship can withstand before breaking apart. One Hull Point equals 10 hit points.

Crew: the number before the slash dictates the number of sailors required to operate the craft without sacrificing maneuverability; this includes officers, helmsman, and navigator but not weapon crews. The number following the slash is the maximum number of man-sized passengers and crew the ship can safely carry without straining its air envelope. Many ships regularly carry crews in excess of this number, but this is a risky proceeding that endangers the ship's air supply.

Maneuverability Class (MC): the rating for the ship's maneuverability. This affects the ship's ability to turn and evade in combat. A is the best maneuverability class, while G is the worst.

Landing: whether the ship can land safely on water or land without damaging the craft. This does not affect ships in orbit or the ability to use space docks. If a percentage is given, that is the chance the craft has of landing on that type of surface (whether water or land) successfully.

Armor Rating (AR): the strength of the ship's hull; roughly equivalent to a character's Armor Class.

Saves As: the saving throw category for the ship. See the Saving Throw table in *Combat Among the Stars*.

Power Type: the form of spelljammer engine usually found with this type of ship. Replacement and alternative engines are common, but in general this type of engine is best suited for this ship.

Ship's Rating (SR): the speed of the ship in combat (combat occurs at Tactical Speed). In ships using major or minor helms, the speed will vary according to the level of the spellcaster manning the helm and the type of helm in use.

Standard Armament: the typical weaponry of this type of ship, as well as the crew required to load and fire them (these are in addition to crew needed for ship maneuvering). After each weapon is the firing arc, indicating which directions the weapon can fire: Forward (F), Aft (A), Port (P), and Starboard (S).

Cargo Capacity: the amount of space available for cargo, passengers, and other sundries. This capacity is the remaining space available once the amounts required for crew, weapons, and the helm are taken into account. This space may be filled with food, trading goods, passengers, or extra weapons.

Keel Length: the length of the ship's hull from stem to stern.

Beam Width: the width of the ship's hull at its widest point.

Description: a general summary of the ship and its appearance. This section also details the most common uses for this type of craft.

A sample ship page for designing your own ships and ship variations can be found on page 62 of this book.

A "character card" for a ship can be found on page 93 in the *War Captain's Guide*, the first book of this set.

Both sheets can be reproduced for private use only.

SHIPS OF THE SPELLJAMMER UNIVERSE

Name: Angelship

Built By: Kobolds

Used Primarily By: Kobolds

Cost: 33,000 gp

Tonnage: 33 tons

Hull Points: 33

Crew: 8/33

Maneuverability Class: C

Landing—Land: Yes

Landing—Water: No

Armor Rating: 6

Saves As: Thick wood

Power Type: Minor helm

Ship's Rating: As per helmsman

Standard Armament:

2 Medium ballistae (F)

Crew: 2 each

1 Medium catapult (A)

Crew: 3

1 Blunt ram (F)

Cargo Capacity: 21 tons

Keel Length: 130'

Beam Width: 135'

Description: Rarely seen nowadays, these basic but versatile ships were the backbone of the kobold space presence until they were all but wiped from the void by the elven fleet during the Unhuman Wars. Named for a kobold legend of beautiful, winged beings who healed fallen warriors, these ships have distinctive flaring wings, making them well-suited for movement in planetary atmospheres.

The crew sizes given above are for humans. For kobolds and other S-sized creatures, the minimum crew size is 12, and the maximum is 66.

The Angelship is now used primarily as a trading vessel. Rumor, however, has it that a few kobold warships are still active. Painted black and cloaked by invisibility spells, these "Night Angels" are both deadly and (fortunately) rare.

Name: Antlership

Built By: Unknown

Used Primarily By: Undead

Cost: 75,000-150,000 gp

Tonnage: 50-100 tons

Hull Points: 50-100

Crew: 5-10/50-100

Maneuverability Class: E

Landing—Land: No

Landing—Water: No

Armor Rating: 3

Saves As: Bone

Power Type: Major helm

Ship's Rating: As per helmsman

Standard Armament:

2 Light catapults (360°)

Crew: 1 each

2 Rams (special) (F)

Cargo Capacity: 25-50 tons

Keel Length: 45'

Beam Width: 250'

Description: Antlerships are theoretically constructed from the antlers of gargantuan celestial beasts. To date, however, no spacefarer has seen the creatures themselves—at least none who has survived to report the encounter. Each Antlership has two rams, one for each part of the antler. These rams are considered blunt rams for most attacks, piercing the hull of an enemy craft only on a critical hit roll of 19 or 20.

There is only one deck on these craft, so the spelljamming helm is located in plain sight of enemy fire. For this reason, Antlerships tend to have up to 2d4 "helms" scattered through the ship, all of them manned but only one capable of powering the ship. When a PC is trying to attack and disable the helm, the DM should determine which is the true helm prior to the called shot.

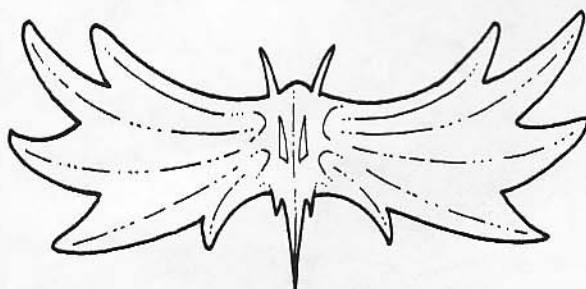
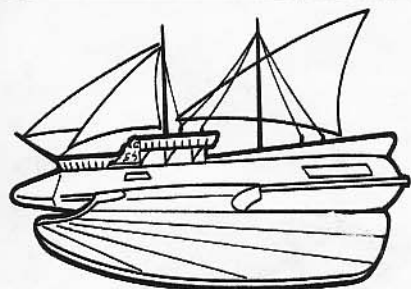

SHIPS OF THE SPELLJAMMER UNIVERSE

Name: Argosy

Built By: Gravs
Used Primarily By: Gravs
Cost: 300,000 gp
Tonnage: 150 tons
Hull Points: 150
Crew: 55/200
Maneuverability Class: D
Landing—Land: Yes
Landing—Water: No
Armor Rating: 0
Saves As: Stone
Power Type: Grav helm
Ship's Rating: As per helmsman
Standard Armament:
2 Heavy ballistae (F, A)
Crew: 4 each
2 Medium ballistae (P, S)
Crew: 2 each
Cargo Capacity: 100 tons
Keel Length: 175'
Beam Width: 175'

Description: The grav ship, the Argosy, strongly resembles the dwarven Citadel. The ship's stone surface is pitted and scarred with craters, much like an airless moon. Some craters are concealed portholes.

One part of the Argosy is flattened, allowing it to land and take on passengers and precious cargo. Most of the interior of the ship is taken up by cargo space for mined ore and gems. Both the Miner gravs and their Elite overseers sleep in the cargo holds.

The Argosy's armaments are strictly for defense. The ballistae are hidden within the deep craters to keep their ship nonthreatening in appearance. One curious feature of the Argosy is that the ship's air envelope is completely contained within the ship's hollow interior. The exterior of the ship does not attract any atmosphere whatsoever, even though it has a gravity. This helps facilitate the dead-rock illusion the grav prefer their ships to have.

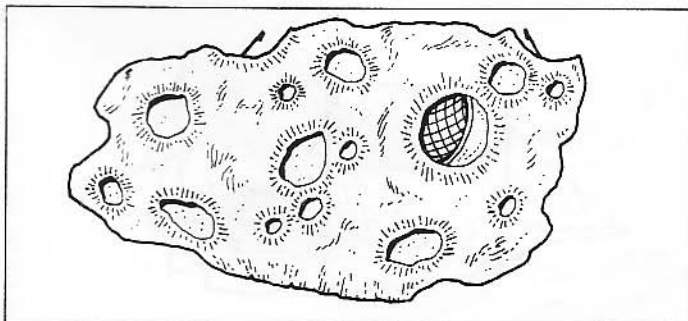

Name: Armada

Built By: Elves
Used Primarily By: Elves
Cost: 400,000 gp
Tonnage: 100 tons
Hull Points: 100
Crew: 40/100
Maneuverability Class: D
Landing—Land: No
Landing—Water: No
Armor Rating: 5
Saves As: Ceramic
Power Type: Major helm
Ship's Rating: As per helmsman
Standard Armament:
6 Heavy catapults (3-P, 3-S)
Crew: 5 each
6 Heavy ballistae (3-F, 3-A)
Crew: 4 each
2 Heavy jettisons (A)
Crew: 4 each
3 Bombards (F, S, P) (Optional)
Crew: 3 each
Cargo Capacity: 50 tons
Keel Length: 300'
Beam Width: 30'

Description: The largest of the elven ships, the Armada is reserved exclusively for the elven nations. Possession of an Armada by anyone else is punishable by death at the hands of the elven fleet.

The elven Armada is built along a butterfly-like body, but the wings are straightened and strengthened so that the upper surfaces form a landing surface for elven Flitter ships.

The chief use of the Armada is as a base for large military actions. Their heavy firepower and accompaniment of Flitters make them particularly deadly. Each Armada has 40 Flitters (5 of them with spell-jamming helms) for use as strike craft to disable enemy heavy weapon emplacements or seize the enemy's bridge.

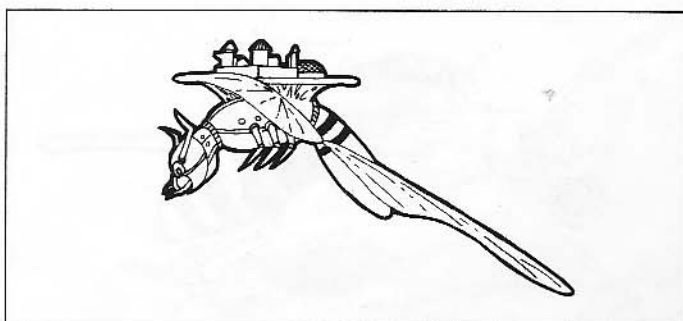

SHIPS OF THE SPELLJAMMER UNIVERSE

Name: Armada, Monarch Class

Built By: Elves (obsolete design)

Used Primarily By: Drow

Cost: 400,000 gp

Tonnage: 100 tons

Hull Points: 100

Crew: 40/100

Maneuverability Class: D

Landing—Land: No

Landing—Water: No

Armor Rating: 4

Saves As: Ceramic

Power Type: Major helm

Ship's Rating: As per helmsman

Standard Armament:

2 Heavy catapults (F)

Crew: 5 Each

4 Heavy ballistae (2-F, 2-A)

Crew: 4 Each

2 Heavy jettisons (2-A)

Crew: 4 each

2 Bombards (P, S)

Crew: 3 each

Cargo Capacity: 50 tons

Keel Length: 300'

Beam Width: 50'

Description: Only half a dozen of these rare ships were built by the elves before the Unhuman Wars, when the design was abandoned. The configuration of the Monarch class is quite different from the more common Armada ships now in use. The citadel is carved from the body of the ship, rather than built on top of it. Like the modern Armadas, Monarchs are primarily used as carriers for large complements of tiny Flitters.

The wings are not the familiar green color of the current Armadas; instead, they are colored orange like the monarch butterflies of Toril. Unlike more modern elven ships, the wings of Monarch-class Armadas are made from a nonliving material and cannot repair themselves once damaged.

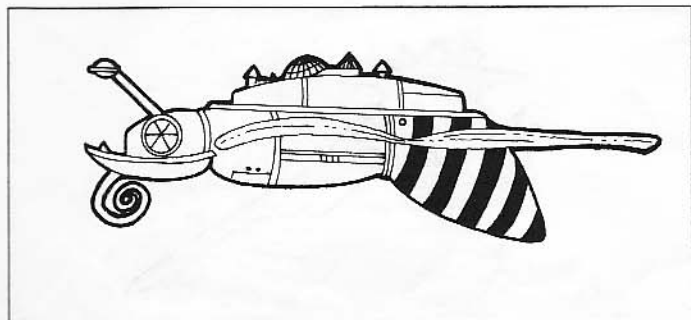

Name: Barge of Ptah (Battle Barge) ✓

Built By: Humans

Used Primarily By: Humans

Cost: 60,000 gp

Tonnage: 60 tons

Hull Points: 60

Crew: 24/60

Maneuverability Class: F

Landing—Land: No

Landing—Water: Yes

Armor Rating: 8

Saves As: Thin wood

Power Type: Major helm

Ship's Rating: As per helmsman

Standard Armament:

6 Medium ballistae (3-FP, 3-FS)

Crew: 2 each

4 Medium catapults (2-F, 2-A)

Crew: 3 each

2 Medium jettisons (2-A)

Crew: 3 each

Piercing ram (F)

Cargo Capacity: 40 tons

Keel Length: 145'

Beam Width: 60'

Description: Built to defend early spacefaring humans against orc, ogre, kobold, and goblin attacks, the Barges of Ptah (also known as the Battle Barges) were home to the faithful of Ptah. Designed as ornate, mobile temples in space where the clerics of Ptah could live and minister to the spacefaring faithful, the Barges became famous across space as refuges where stricken folk could find healing and help in repairing their ships. The templeships grew rich from tithes charged for these services.

Unfortunately, these treasures attracted pirates and other raiders. Slow and clumsy in battle, Battle Barges offered little protection for their crews and often proved to be deathtraps for all on board. Many riddled Barges drift abandoned in the flow, while only a few still fulfill their original function.

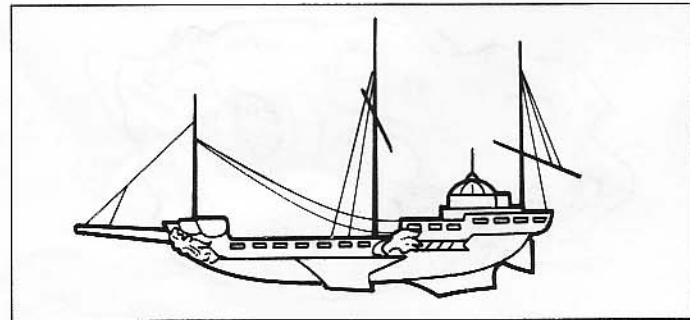

SHIPS OF THE SPELLJAMMER UNIVERSE

Name: Batship (Unique)

Built By: An unknown human mage

Used Primarily By: Humans

Cost: 225,000 gp

Tonnage: 45 tons

Hull Points: 45

Crew: 1/45

Maneuverability Class: Special

Landing—Land: Yes

Landing—Water: No

Armor Rating: 3

Saves As: Best of Metal and Crystal

Power Type: Unique

Ship's Rating: 4

Standard Armament:

4 Light ballistae (1-FP, 1-FS, 2-A)

Crew: 1 each

Quasi-breath weapon (17 die *fireball*) (F)

2 Claw attacks (1-2 Hull Points) (F)

1 Bite attack (1-4 Hull Points. A critical hit roll of 20 will cause Spelljammer Shock to the victim's ship.) (F)

1 Grappling-hook tail (1 Hull Point. Usually used as a towing device.) (360°)

Cargo Capacity: 23 tons

Keel Length: 180'

Beam Width: 30'

Wingspan: 150'

Description: This ship looks like a giant bat with crystalline teeth and a metallic hide, giving it the best saving throws of metal and crystal. It looks so much like a living creature that many believe it to be one. It has two exposed decks: one along its stomach and another on its back. A long ladder within an interior corridor connects the two decks.

The ship has two modes. During flight mode it appears as other spelljamming craft: flat, with two exposed decks. When it enters battle mode, the ship curls and attacks feet first. The gravity plane bends to match the pitch change of battle mode.

The ship is controlled by a box helm, a large obsidian cube that magically keeps alive the trapped, levi-

tating mage inside. While inside this helm, the mage undergoes sensory deprivation and can only feel the ship's body, not his or her own. Whenever the mage moves, the Batship responds in a like manner, allowing the helmsman to control every aspect of ship movement, be it wings, head, legs, etc. In addition to this, the Batship detects all other spelljamming ships within 10,000 yards (20 hexes), a distance of over five miles.

The wings give the Batship protection as per a *cloak of reflection*, plus immunities to any helm altering or damaging spells, reflecting them back to the caster's ship. It reflects *magic missile*, *irritation*, *ray of enfeeblement*, all *polymorph*, *hold*, and *slow* spells, and *feblemind*, as well as nullifying *shocking grasp* and *entangle* effects.

The ship's maneuverability is controlled by the helmsman's Dexterity (the current helmsman, Burnayette Skyansdanya, has a Dexterity of 19). This maneuvering is facilitated by the motion of the wings and tail. The wings do not flap but act as rudders and pivot points.

Dexterity	Maneuvering Class
01-04	F
05-08	E
09-12	D
13-16	C
17-18	B
19+	A

The Batship has several curses associated with it:

- Once the helmbox is entered, there is no way out, except via a *wish* spell cast from outside the box.
- All who board must save vs. spell with every step or become *charmed*, becoming one of the crew until a *remove curse* is cast on the character.
- The helmsman can never die. The helmbox also does not allow the helmsman to commit suicidal acts. For the rest of the helmsman's existence, his or her senses are limited to hearing, speech, sight, and pain. There is no way to feel anything else, not even with a *wish*.

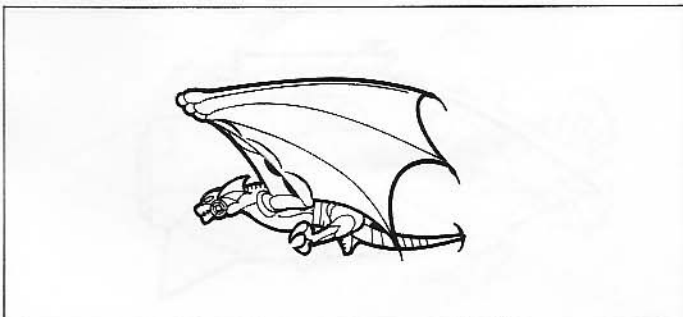

SHIPS OF THE SPELLJAMMER UNIVERSE

Name: Battlewagon

Built By: Scro

Used Primarily By: Scro

Cost: 240,000 gp

Tonnage: 80 tons

Hull Points: 80

Crew: 40/160

Maneuverability Class: E

Landing—Land: No

Landing—Water: No

Armor Rating: 3

Saves As: Metal

Power Type: Major helm

Ship's Rating: 2

Standard Armament:

4 Turret-mounted bombard (360°)

Crew: 3 each

1 Greek fire projector (FPS)

Crew: 3

6 Medium ballistae (3-F, 3-FPS)

Crew: 2 each

8 Medium catapults (2-F, 2-P, 2-S, 2-A)

Crew: 3 each

Blunt ram (F)

Cargo Capacity: 20 tons

Keel Length: 150'

Beam Width: 50'

Description: The massive Scro Battlewagon symbolizes the Scro's emerging power within the spelljamming arena. The Scro give their ships names intended to strike fear in their enemies. Only six Battlewagons have been built to date: *Decapitator*, *Conflagrator*, *Devastator*, *Eviscerator*, *Mutilator*, and *Defenestrator*.

The Scro have inherited all the many enemies of their orc ancestors, a fact which does not disturb them in the least. Their goal is to eliminate all other races from wildspace, beginning with their nemeses, the elves. Absurd as this sounds, the deadly efficiency of the Battlewagons shows that they are a threat to be taken seriously.

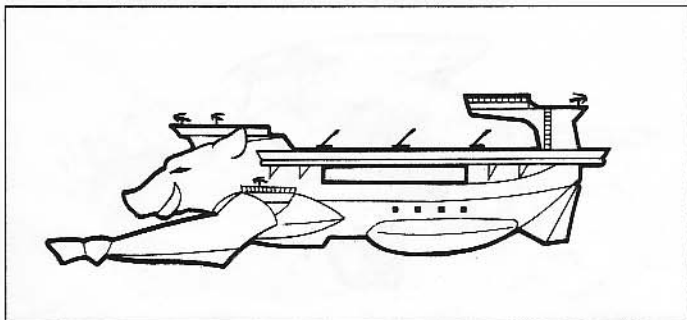

Name: Blade (Arrow)

Built By: Goblins (Kobolds)

Used Primarily By: Goblins (Kobolds)

Cost: 6,000 gp

Tonnage: 2 tons

Hull Points: 2

Crew: 1/2

Maneuverability Class: A

Landing—Land: No (see below)

Landing—Water: No

Armor Rating: 4

Saves As: Metal

Power Type: Lifejammer helm or death helm

Ship's Rating: As per victim

Standard Armament:

1 Greek fire projector (A)

Crew: 3

Piercing ram (F)

Cargo Capacity: 1/2 ton

Keel Length: 20'

Beam Width: 20'

Description: Goblin Blades are small, short-range attack ships. Developed from the earlier, unarmored kobold Arrow, the Blade was primarily used in kamikaze ram attacks against enemy ships in space battles. The kobolds mainly used their ships on reckless ground raids as well as space attacks. Many ships were fitted with wooden runners to enable them to land on sand, salt pans, and flat grasslands. The skeletons of a few ill-fated Arrows can still be found moldering on worlds scattered across space.

The Blade (or Arrow) is shaped like an arrowhead, with the spelljamming helm amidship and the weapon (if any) mounted at the top rear. If unarmed, a rail-lined crew platform surrounds the weapon-mount, connected by hatch and ladder to the interior. This ship is popular among the goblin races and humans because it is inexpensive and excellent for short-range use. The giff and gnomes use these small craft to test experimental weapons.

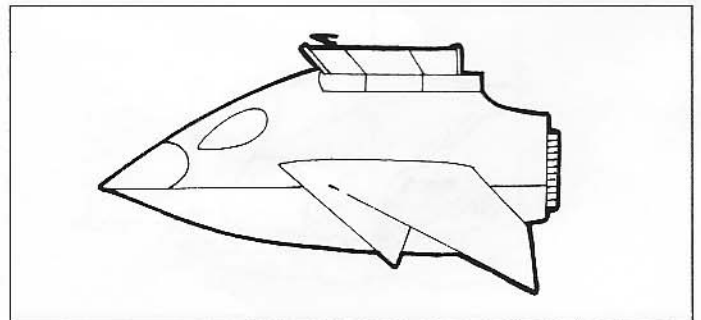

SHIPS OF THE SPELLJAMMER UNIVERSE

Name: Bloatfly

Built By: Lizard men

Used Primarily By: Lizard men

Cost: 144,000 gp

Tonnage: 48 tons

Hull Points: 48

Crew: 6/40

Maneuverability Class: E

Landing—Land: No

Landing—Water: No

Armor Rating: 6

Saves As: Metal

Power Type: Furnace (15%); minor helm (85%)

Ship's Rating: 2 (Furnace) or as per helmsman

Standard Armament:

36 Medium ballistae (in pairs) (4-FP, 4-FS, 10-P, 10-S, 4-AP, 4-AS)

Crew: 2 each

Cargo Capacity: 6 tons*

Keel Length: 155'

Beam Width: 55'

*This is in addition to 36 tons of egg-tubes.

Description: These vessels are found only in close orbit of fire worlds (warm suns). Built by the advanced-intellect lizard men of space as egg incubators, they warm the eggs for new generations of lizard men. This helps guarantee that the hatchlings will be born smarter and stronger.

Bloatfly ships represent the present pinnacle of lizard man ship design. Their metal construction incorporates all the advanced gear the lizard men can devise, steal, or purchase. The black bloatflies have a distinctive spindle shape, tapering at the nose and tail, and studded with 18 wartlike bumps. Each of these bumps is a special type of turret, containing a double ballista mount. Two sets of skeletal wings or outriggers protrude from the Bloatfly's flanks.

The rumor that these ships are being used for lizard man colonization is validating itself.

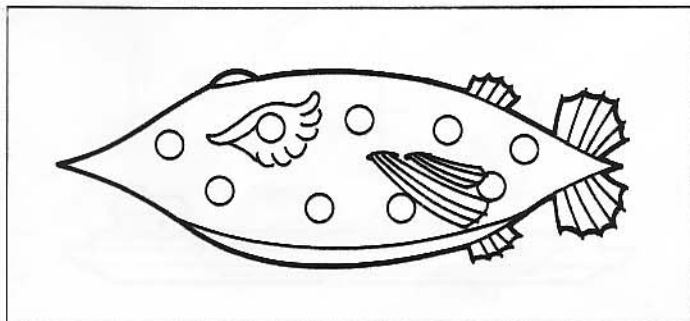

Name: Bolaship

Built By: Gnomes

Used Primarily By: Gnomes (who else?)

Cost: 25,000 gp

Tonnage: 25 tons

Hull Points: 25

Crew: 10/25

Maneuverability Class: D

Landing—Land: Yes

Landing—Water: Yes

Armor Rating: 5

Saves As: Thick wood

Power Type: Bolawhip (special)

Ship's Rating: Special (maximum 6)

Standard Armament:

1 Bolawhip (F)

Crew: 12

2 Light ballistae (A)

Crew: 1 each

Cargo Capacity: 12½ tons

Keel Length: 12'

Beam Width: 15'

Description: The Bolaship—perhaps the strangest contraption in fantasy space—is propelled physically through space by the movement of six whip-like appendages placed on the nose of the craft. These appendages also serve as the Bolaship's main (and only) forward-facing weapon.

As the bolas pick up speed, the ship's speed also increases. Each round, the ship can be accelerated or decelerated by one SR. If the bolaship uses its whiplike appendages to attack another ship, its SR immediately drops to 1, and it must accelerate all over again. Twelve gnomes can be seen through the windows, pedaling wildly to keep the bolas moving.

When the Bolaship strikes with its whip, each of the six appendages must make a separate attack for 1 hull point (1d10 hit points) of damage. If the attack roll results in a 1, that particular bolawhip breaks and the ship's maximum SR is penalized by one point. If all six break, the whip ship is immobilized.

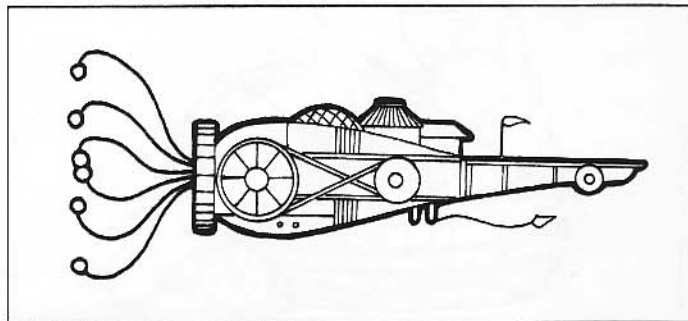

SHIPS OF THE SPELLJAMMER UNIVERSE

Name: Caravel

Built By: Groundling humans
Used Primarily By: Groundling humans
Cost: 10,000 gp
Tonnage: 10 tons
Hull Points: 10
Crew: 8/10
Maneuverability Class: F
Landing—Land: No
Landing—Water: Yes
Armor Rating: 9
Saves As: Thick wood
Power Type: Major or minor helm
Ship's Rating: As per helmsman
Standard Armament:
 1 Medium ballista (360°)
 Crew: 2
Cargo Capacity: 5 tons
Keel Length: 70'
Beam Width: 20'

Description: Unfortunately, the most common form of first-time ship an adventurer is likely to own is something along the lines of a Caravel. This ship is a cheap vessel with low armor rating and maneuverability, little capacity to maintain a crew above the listed minimums, and woefully inadequate weaponry. This is the type of ship created by groundling adventurers who happen upon a spelljamming helm in the ruins of an ancient civilization or in the remains of a larger, unsalvageable crashed spelljamming ship.

If such an adventuring team survives their first adventure into space and discovers other civilizations with better, more refined ships, they quickly junk the Caravel for at least a Tradesman. As a result, Coasters, Cogs, Caravels, and the like are often abandoned by their owners, who wise up and leave them propped on the side of an asteroid base as a source of lumber and scrap.

Name: Cargo Barge

Built By: Humans
Used Primarily By: Humans, mind flayers, neogi
Cost: 25,000 gp
Tonnage: 25 tons
Hull Points: 25
Crew: None
Maneuverability Class: F
Landing—Land: No
Landing—Water: Yes
Armor Rating: 8
Saves As: Thick wood
Power Type: None*; 15% have minor helm back-up
Ship's Rating: None or as per helmsman
Standard Armament:
 None
Cargo Capacity: 20 tons
Keel Length: 40'
Beam Width: 20'

*100% of mind flayer craft are fitted with series helms.

Description: These unglamorous, usually battered spacecraft are simple boats dominated by massive hitching-bollards for towing. In some cases, these vessels have high, removable side walls used to make carried cargo more secure.

Towed barges decrease the MC of the towing ship by one step for every Barge towed. If the tonnage of the Barges exceeds the limitations of the helm type, neither the Barges nor the towing vessel can move. In times of crisis (e.g., a pirate attack), the lost maneuverability can be regained simply by cutting the tow lines, either abandoning the Barge or (a favorite neogi trick) turning it into an immense ram.

Simple but extremely useful, Barges are mainly used to haul freight—either trading goods or, in the case of the infamous illithid slave boats, captives. Since they increase the size of the towing ship's air pocket, they are often carried by explorers and abandoned on the way.

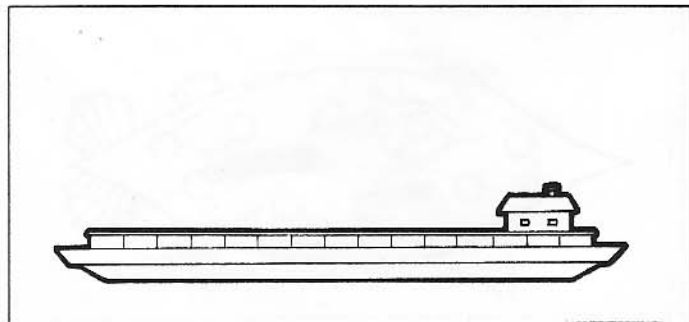
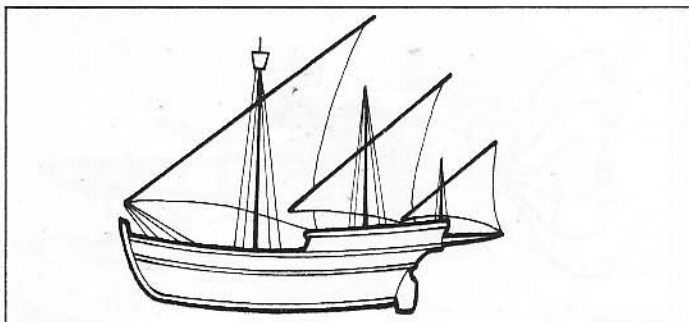

SHIPS OF THE SPELLJAMMER UNIVERSE

Name: Catamaran

Built By: Humans

Used Primarily By: Humans

Cost: 500 gp

Tonnage: 1 ton

Hull Points: 1

Crew: 2/1

Maneuverability Class: B

Landing—Land: Yes

Landing—Water: Yes

Armor Rating: 9

Saves As: Thin wood

Power Type: Non-magical helm

Ship's Rating: 4

Standard Armament:

None

Cargo Capacity: None

Keel Length: 25'

Beam Width: 10'

Description: The Catamaran is a very small craft, commonly used for pleasure trips into low planetary orbit or as an escape vessel. It has two parallel hulls, connected by perpendicular struts to hold the craft together. Its tall, broad sail makes the vessel very maneuverable. Using nearby gravitational forces, the sail also allows the craft to move at SR 4. If the craft is in space that would normally allow a ship to enter spelljamming speeds, the ship's SR is reduced to 2 and its Maneuverability dips to D.

In order to maneuver the craft, the crew members must lean far over the side, holding onto the sail to catch the gravitational pulls. If the sail is ever removed due to a Critical Hit or a direct hit to the sail or mast, the craft's maneuverability drops to G and it travels in a straight line at its last SR.

Whenever the craft is hit in combat, all crew members must roll a Dexterity check (penalized by the ship's SR) to stay aboard. Those who fail fall through the ship's gravity plane and are lost at the end of the next round. If the ship breaks up, only 1d2 large, atmosphere-sustaining pieces will be left.

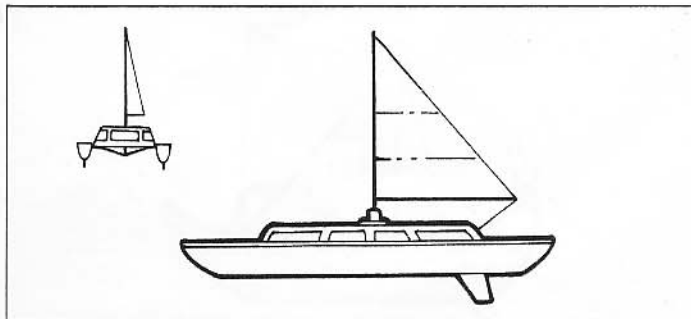

Name: Citadel

Built By: Dwarves

Used Primarily By: Dwarves

Cost: 100,000-600,000 gp

Tonnage: 300 tons (and up)

Hull Points: 300

Crew: 100/300

Maneuverability Class: E

Landing—Land: No

Landing—Water: No

Armor Rating: 0

Saves As: Stone

Power Type: Forge

Ship's Rating: 1-3

Standard Armament:

1-4 Heavy catapults (360°)

Crew: 5 each

2-8 Medium catapults (360°)

Crew: 3 each

3-12 Light catapults (360°)

Crew: 1 each

3 heavy jettisons (360°)

Crew: 4 each

Cargo Capacity: 150 tons

Keel Length: 250'

Beam Width: 200'

Description: The Citadel is the smallest and most common of the mobile asteroids used by the dwarves as a combination home and base. The larger the asteroid, the more busy dwarves it can hold to power its forge; as a result, larger asteroids have higher SR values.

The largest Citadel that may move by forge-power is 700 tons. Ships greater than 700 tons have an SR of 1 and are incapable of spelljamming speeds, taking years to travel from one planet to another—even in the same crystal sphere. This is why these very large ships tend to stay in orbit around planetary bodies for defense.

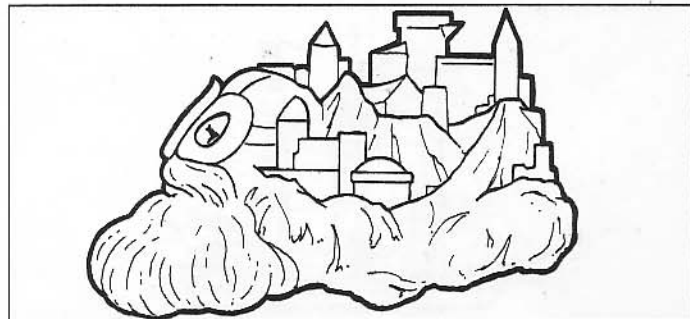

SHIPS OF THE SPELLJAMMER UNIVERSE

Name: Clipper

Built By: Humans

Used Primarily By: Giff

Cost: 195,000 gp

Tonnage: 65 tons

Hull Points: 65

Crew: 18/65

Maneuverability Class: E

Landing—Land: No*

Landing—Water: Yes

Armor Rating: 4

Saves As: Metal (hull) or Wood (deck)

Power Type: Major helm

Ship's Rating: As per helmsman - 1

Standard Armament:

26 Bombards

Crew: 3 each

- 12 on starboard side

- 12 on port side

- 1 aft (turret mounted for full arc firing)

- 1 forward (turret mounted for full arc firing)

Cargo Capacity: 23 Tons (usually used primarily for smokepowder, *helmseekers*, and Greek fire)

Keel Length: 260'

Beam Width: 40'

*If an attempt is made to land on anything but water, the ship must make a saving throw versus Crushing Blow. If this save fails, the unstable Greek fire and smokepowder erupt, ripping the ship apart. This includes any attempt to land on another ship as well. If the Clipper ship explodes, the ship landed on receives damage as per a 17d6 *fireball*.

Description: A Clipper ship is one of the finest water-sailing craft in the known worlds. It has three central-hull masts, one aft mast, and a bow mast, with several lateral sails between the masts. Regardless of the fact that it has 29 individual sails, Clippers still suffer from poor maneuverability in space, due to their "groundling" construction. The ship's heavy maneuvering also diminishes the effectiveness of

the helmsman. This loss of function translates into a one point SR penalty for any helmsman of a Clipper. Since giff are incapable of spelljamming themselves, they hire human mages (usually chaotic in alignment and fond of spells that go "boom").

Originally built by the humans for water sailing and eventually for space travel, the trade craft was soon abandoned for faster and more maneuverable vessels. The giff, however, love the design and have upgraded its original armaments to complement their love of high explosives, pyrotechnic displays, and loud noises.

They have lined the port and starboard sides with 24 bombards, giving excellent "broadside" attacks whenever the opportunity arises. The giff, in fact, usually allow enemy craft to come in very close (with the illusion that the vessel is helpless) in order to use this lethal combat maneuver. This tactic entails the firing of every side, aft, and forward gun in range. Those who survive such a barrage never close with a Clipper again.

The bow (front) and aft (rear) have one bombard apiece. These were installed after the giff lost several ships to wiser pirates who chose to stay out of the Clipper's side firing arcs.

Whenever possible, giff Clippers travel in packs of at least two. This assures that a broadside attack can be made against a target within the aft or forward firing arcs of another Clipper. This practice has greatly diminished their losses over the last decade or so.

There is one deadly drawback to these vessels. Whenever a Fire critical hit is sanctioned against the Clipper, the vessel must make an immediate saving throw versus non-magical fire, using its Metal rating. If this saving throw fails, the fire immediately guts the deck, exposing the Greek fire and smokepowder in the lower decks. The next round, the ship explodes into a fireball so large that any ship in the same hex must make a saving throw versus fire or suffer the effects of a 17d6 *fireball*.

The giff often use a Clipper as the headquarters of their fleet. If a giff fleet is larger than 20 ships, at least three (1d4 + 2) of those ships will be Clippers.

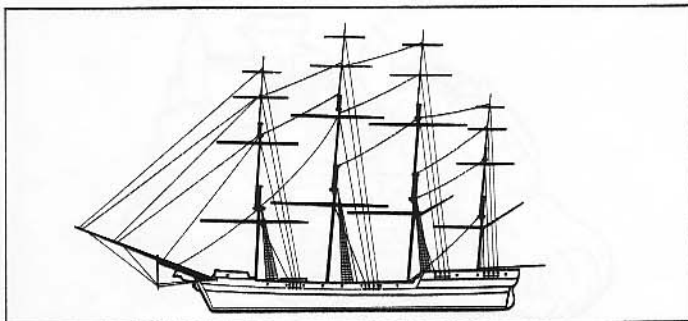

SHIPS OF THE SPELLJAMMER UNIVERSE

Name: Coaster

Built By: Groundling humans
Used Primarily By: Groundling humans
Cost: 10,000 gp
Tonnage: 10 tons
Hull Points: 10
Crew: 8/10
Maneuverability Class: F
Landing—Land: No
Landing—Water: Yes
Armor Rating: 9
Saves As: Thick wood
Power Type: Major or minor helm
Ship's Rating: As per helmsman -1
Standard Armament:
1 Heavy ballista (360°)
Crew: 4
OR
1 Heavy catapult (360°)
Crew: 5
OR
1 Heavy jettison (APS)
Crew: 4
Cargo Capacity: 5 tons
Keel Length: 60'
Beam Width: 20'

Description: The Coaster is a groundling coastal trader ship set with a major or minor spelljamming helm. Because it is a groundling vessel, the craft is clumsy and difficult to handle, reducing its SR by one step no matter how high in level the spelljamming priest or mage is.

Name: Cog

Built By: Groundling humans
Used Primarily By: Groundling humans
Cost: 20,000 gp
Tonnage: 20 tons
Hull Points: 20
Crew: 10/20
Maneuverability Class: F
Landing—Land: No
Landing—Water: Yes
Armor Rating: 9
Saves As: Thick wood
Power Type: Major or minor helm
Ship's Rating: As per helmsman -1
Standard Armament:
None
Cargo Capacity: 10 tons
Keel Length: 90'
Beam Width: 20'

Description: The Cog is a groundling ocean trader, popular with merchants. Its design is woefully inadequate for the rigors of arcane space, being both clumsy (hence the low MC and penalty to SR) and fragile (AC9). However, since it is comfortably familiar to groundlings new to arcane space, it is often used in the early stages of a culture's spacefaring era.

Most Cogs are incapable of defending themselves; occasionally, the owners will mount a heavy or medium weapon on the ship's aft in order to protect their lives and cargo. This modification, however, is unpopular because it cuts into profits, lessening the ship's cargo capacity to seven tons.

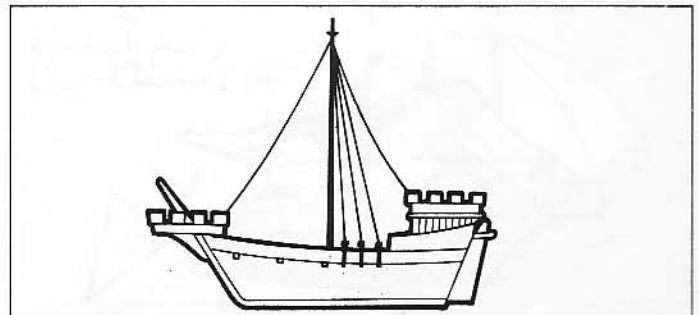
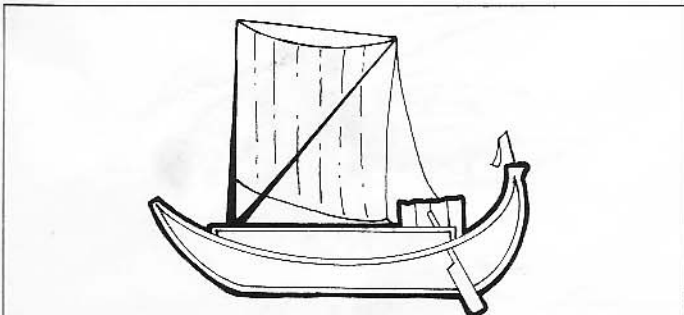

SHIPS OF THE SPELLJAMMER UNIVERSE

Name: Corbina

Built By: Aarakocra
Used Primarily By: Aarakocra
Cost: 2,500 gp
Tonnage: 5 tons
Hull Points: 5
Crew: 1/5
Maneuverability Class: D
Landing—Land: Yes
Landing—Water: No
Armor Rating: 9
Saves As: Thin wood
Power Type: Major or minor helm
Ship's Rating: As per helmsman + 1
Standard Armament:
1 Light ballista (F)
Crew: 1
OR
1 Medium ballista (F)
Crew: 2
OR
1 Light jettison (A)
Crew: 2
Cargo Capacity: 2½ tons
Keel Length: 60'
Beam Width: 50'

Description: These strange-looking craft are solely constructed by the spacefaring aarakocra. Its lack of sails makes the vehicle appear more clunky and unwieldy than it actually is. However, like all aarakocra craft it gains +1 to its SR.

Unlike most spelljamming craft, it cannot rise vertically into the air. Instead, it needs 300 feet of flat surface in order to gain enough speed to lift off the ground. The helmsman controls the pitch of the frontal and rear wings which, in turn, control the craft's lift and dive capabilities. The vessel's tail (the vertical rudder) controls the craft's ability to turn. Even with the most highly magical equipment, the highest MC available to the craft is B. The ship cannot be armor plated, as the wings will not support the added weight of the metal.

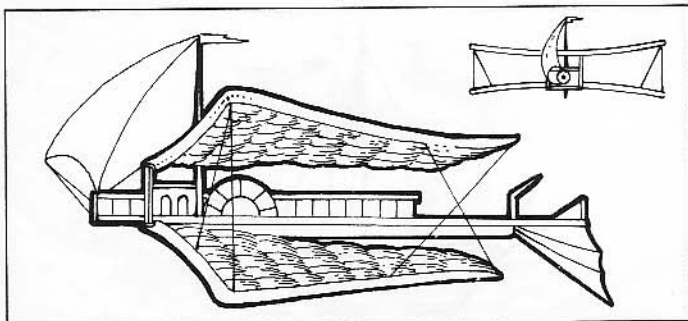

Name: Cuttle Command

Built By: Humans, mind flayers
Used Primarily By: Human wizards
Cost: 100,000 gp
Tonnage: 100 tons
Hull Points: 100
Crew: 30/100
Maneuverability Class: E
Landing—Land: Yes
Landing—Water: No
Armor Rating: 8
Saves As: Thick wood
Power Type: Major helm
Ship's Rating: As per helmsman
Standard Armament:
4 Heavy ballistae (1-FP, 1-FS, 2-360°)
Crew: 4 each
2 Heavy catapults (360°)
Crew: 5 each
1 Heavy jettison (A)
Crew: 4
Cargo Capacity: 50 tons
Keel Length: 120' (high)
Beam Width: Variable

Description: The Cuttle Command is a ten-story-tall tower in space. It is even taller than it is wide. It maintains its gravity plane by having large weapons on four of the eight tentacles. These tentacles extend out far enough horizontally to change the orientation of the gravity plane to a horizontal axis running through the eyes of the Cuttle. As a result, the Cuttle is much bulkier and nowhere near as maneuverable as a ship built along more normal lines.

The Cuttle was originally built for the Unhuman Wars as a mobile command base. It was primarily designed and used by humans, using many of the same design techniques as the Octopus. The Cuttle appealed to human wizards in particular (despite the natural laws of space survival, wizards felt safer in a tower-like setup). Vintage Cuttles are now mostly abandoned or torn apart for salvage.

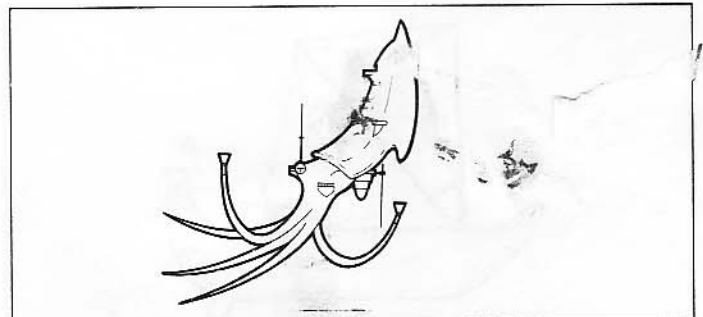

SHIPS OF THE SPELLJAMMER UNIVERSE

Name: Damsselfly

Built By: Humans
Used Primarily By: Humans
Cost: 30,000 gp
Tonnage: 10 tons
Hull Points: 10
Crew: 2/10
Maneuverability Class: D
Landing—Land: Yes
Landing—Water: No
Armor Rating: 4
Saves As: Metal
Power Type: Major or minor helm
Ship's Rating: As per helmsman
Standard Armament:
 1 Heavy ballista (FPS)
 Crew: 4
 OR
 1 Heavy catapult (FPS)
 Crew: 5
 OR
 1 Heavy jettison (A)
 Crew: 4
Cargo Capacity: 5 tons
Keel Length: 100'
Beam Width: 20'

Description: A second generation version of the Dragonfly, the Damsselfly has the same general configuration but has been totally redesigned along its main body. The thin wood has been replaced with metal and other harder substances, and all exposed decks are covered. A sliding hatch just behind the wings is used for the ship's single heavy weapon, though some versions use this for cargo space, turning the aft section into a weapon deck instead.

The Damsselfly is a hermit's ship, used by those who want to shut the universe out. It is very popular among the more daring smugglers, particularly in areas where open warfare is common or the local authorities have the power to back up a blockade.

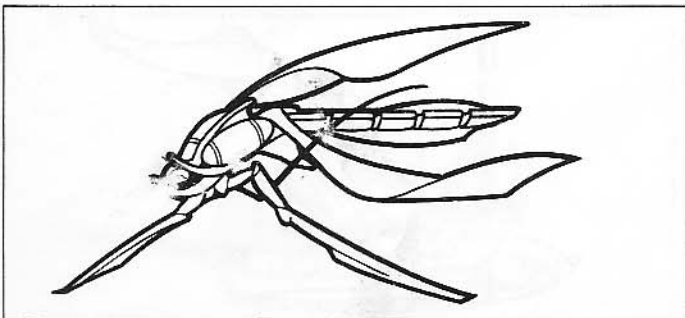

Name: Deathglory

Built By: Gnomes
Used Primarily By: Gnomes
Cost: 210,000 gp
Tonnage: 70 tons
Hull Points: 70
Crew: 18/70
Maneuverability Class: D
Landing—Land: No
Landing—Water: Maybe (leaks badly!)
Armor Rating: 6
Saves As: Metal
Power Type: Gnomish major helm
Ship's Rating: As helmsman - 1 (due to *spell reflector*)
Standard Armament:
 2 Medium ballistae (1-F, 1-A)
 Crew: 2 each
 2 Medium catapults (2-FPS)
 Crew: 6 each
 1 Medium jettison (A)
 Crew: 3
 2 Tangle line guns (1-FP, 1-FS)
 Crew: 4 each
 2 Water cannons (2-F)
 Crew: 3 each
Cargo Capacity: 35 tons
Keel Length: 80'
Beam Width: 55' (85' including outriggers)

Description: This gnomish dreadnever-class ship actually works! These top-heavy vessels are ruggedly overbuilt and equipped with the best gnomish weapons and technology. A Deathglory has outrigger weapon spars jutting from its sides, ending in weapon batteries reached by covered crawlways. Weapons located here command larger fields of fire than those of more conventional ships.

Deathglories are kept busy escorting gnomish merchant ships along favored trade routes and through pirate hunting grounds, as well as exploring for new worlds to settle.

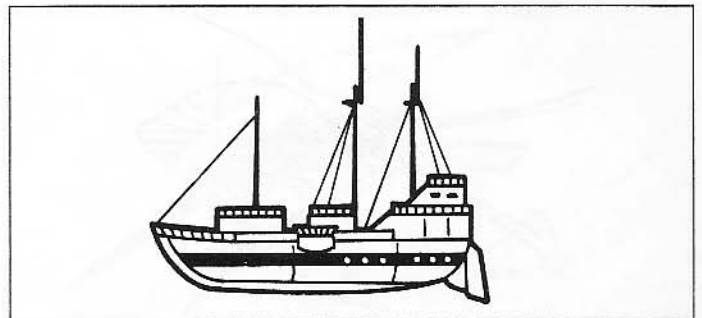

SHIPS OF THE SPELLJAMMER UNIVERSE

Name: Deathspider

Built By: Neogi
Used Primarily By: Neogi
Cost: 500,000 gp
Tonnage: 100 tons
Hull Points: 100
Crew: 30/100
Maneuverability Class: E
Landing—Land: No
Landing—Water: No
Armor Rating: 5
Saves As: Crystal
Power Type: Major helm
Ship's Rating: As per helmsman
Standard Armament:
1 Heavy catapult (1-A)
Crew: 5
1 Heavy jettison (1-A)
Crew: 4
4 Heavy ballistae (2-F, 2-APS)
Crew: 4 each
Grappling ram (F)
Cargo Capacity: 50 tons
Keel Length: 175' (excluding legs)
Beam Width: 50'

Description: As one of the largest of the standard ships of space, the Deathspider is the pride and joy of the neogi fleet. Its large size and distinctive shape make this craft easily recognizable. As a result, it is usually attacked on sight.

This huge ship usually carries only eight neogi (including their spelljamming mage), each with its own umber hulk attendant. The remainder of the crew is made up of human, demi-human, and humanoid slaves, who toil in the depths of the ship, forestalling the day when they will be served up as a main course for the crew. A standard crew takes as much air as 34 normal humans. In times of war, the standard crew complement is more than tripled.

A single Deathspider can carry up to 16 Urchins or an entire Mindspider inside its hollow abdomen.

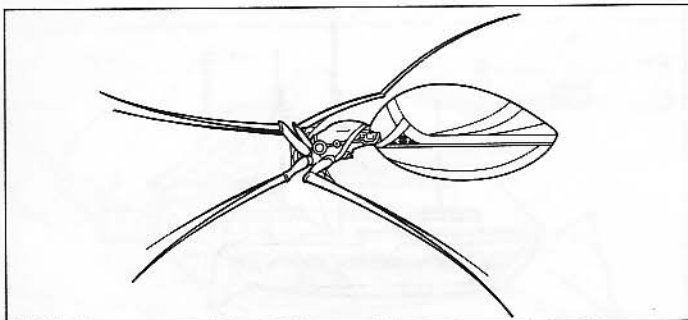

Name: Dolphin, Battle

Built By: Human
Used Primarily By: Any race
Cost: 70,000 gp
Tonnage: 50 tons (70 with Shuttle)
Hull Points: 70
Crew: 12/70
Maneuverability Class: D
Landing—Land: No
Landing—Water: No (see below)
Armor Rating: 5
Saves As: Thick wood
Power Type: Major helm
Ship's Rating: As per helmsman
Standard Armament:
2 Medium catapults (2-FSP)
Crew: 3 each
Cargo Capacity: 35 tons
Keel Length: 250'
Beam Width: 30'

Description: The graceful Battle Dolphin is the latest human ship in any quantity in the void. It combines a number of design features necessary to human travel, commerce, and comfort in space. Like the hard-shelled Nautiloid, the bulk of the Battle Dolphin is enclosed. Its upper surveillance level is placed above the decks of most opposing ships. Most importantly of all, the Galleon-like portion of the upper deck can separate from the main ship and make planetary landings. This small Shuttle is less likely to attract attention in groundling ports than more exotic spacegoing vessels.

The Battle Dolphin, sometimes just called the Dolphin, is quickly becoming a popular ship for adventurers and other small parties, in particular those that need to make planetfall on large worlds filled with excitable groundlings. The lander unit allows access to most worlds without arousing attention, while the main body of the ship is laid out to meet the challenges of wildspace. The landing craft of the Battle Dolphin is called the Dolphin-Shuttle.

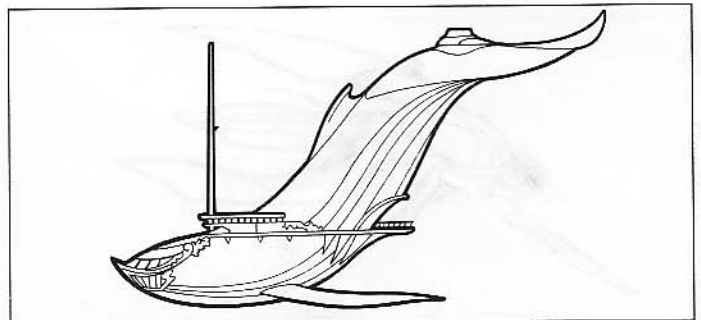

SHIPS OF THE SPELLJAMMER UNIVERSE

Name: Dolphin-Shuttle

Built By: Humans

Used Primarily By: Any race

Cost: 10,000 gp

Tonnage: 20 tons

Hull Points: 20

Crew: 4/20

Maneuverability Class: C

Landing—Land: No

Landing—Water: Yes

Armor Rating: 6

Saves As: Thin wood

Power Type: Major or minor helm

Ship's Rating: As per helmsman

Standard Armament:

None

Cargo Capacity: 15 tons

Keel Length: 40'

Beam Width: 15'

Description: The Dolphin Shuttle is the Galleon-like portion of the Battle Dolphin, able to separate from the main ship and make planetary landings. This removable shuttle is necessary since the Battle Dolphin is unable to make safe planetary landings of any kind. It also has the advantage that a small Galleon is less likely to attract unwanted attention from unenlightened groundlings than, say, a Nautiloid or a fully-armed Hammership.

Please see the Battle Dolphin entry for more information on this unique configuration.

Name: Dragonfly

Built By: Humans

Used Primarily By: Humans, elves

Cost: 5,000 gp

Tonnage: 10 tons

Hull Points: 10

Crew: 3/10

Maneuverability Class: C

Landing—Land: Yes

Landing—Water: No

Armor Rating: 8

Saves As: Thin wood

Power Type: Major or minor helm

Ship's Rating: As per helmsman

Standard Armament:

1 Light ballista (F)

Crew: 1

OR

1 Light catapult (A)

Crew: 1

Cargo Capacity: 5 tons

Keel Length: 100'

Beam Width: 20'

Description: The Dragonfly, with the Tradesman, is one of the workhorses of space. Its small size and good maneuverability make it ideal for transporting small groups, very important persons, and small packages. These features also make the Dragonfly the ideal ship for smuggling and fast exploration.

The Dragonfly is also highly recommended as a wizard's ship. A truly antisocial mage can load his supplies on board and turn the Dragonfly into a mobile laboratory and workshop, placing himself literally millions of miles from nowhere where he can work in relative peace. A large number of Dragonflies found in the various systems were once used for this exact purpose, abandoned when their masters moved on or died as a result of their experiments.

The Dragonfly is capable of being handled, though badly, by one person, but it operates best with a three-man crew.

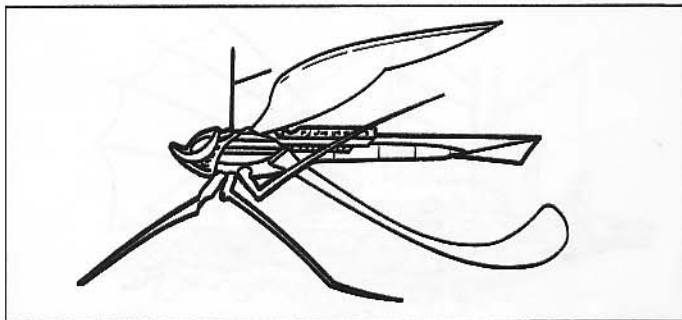
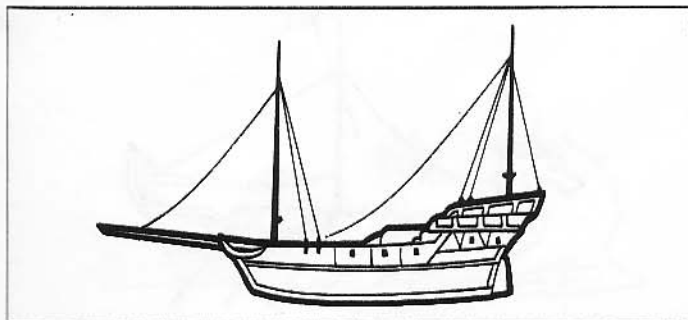

SHIPS OF THE SPELLJAMMER UNIVERSE

Name: Dragonship

Built By: Shou Lung humans of Toril
Used Primarily By: Shou Lung humans of Toril
Cost: 45,000 gp
Tonnage: 45 tons
Hull Points: 45
Crew: 20/45
Maneuverability Class: D
Landing—Land: No
Landing—Water: Yes
Armor Rating: 5
Saves As: Thick wood
Power Type: Major or minor helm
Ship's Rating: As per helmsman
Standard Armament:
2 Medium ballistae (2-FSP)
Crew: 2 each
Cargo Capacity: 22 tons
Keel Length: 150'
Beam Width: 20'

Description: As a rule, groundling nations tend not to think about the empires that battle far over their heads. The chief exception is the Toril empire of Shou Lung, which has recently become a noted presence throughout Realspace and beyond.

The chief mission of a Shou Dragonship is to seek out the unusual, the odd, and the new, and bring it back to the spiritual center of the universe (the emperor's palace in Shou Lung). So far, such wonders as a captured neogi (thought to be a fiend), a preserved orbis, and a *crown of the stars* have been returned and presented to the emperor. Of course, some Shou captains exposed to the marvels of arcane space began to wonder why they had thrown-in with some small-time emperor when there are whole worlds waiting to be discovered or even conquered. The result is a large number of Dragonships no longer loyal to the emperor. Such rogue ships often turn to piracy, and a few even end up in the hands of adventurers.

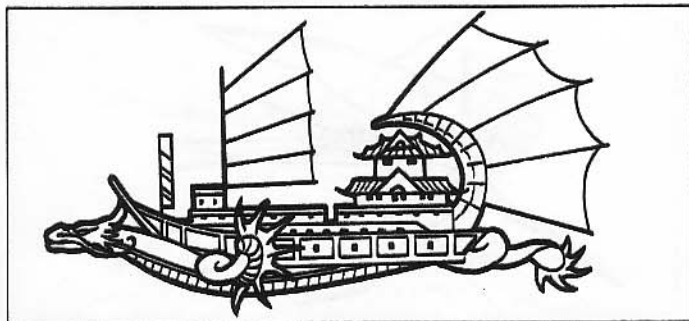

Name: Drakkar

Built By: Viking groundling humans
Used Primarily By: Viking groundling humans
Cost: 10,000 gp
Tonnage: 10 tons
Hull Points: 10
Crew: 20/10
Maneuverability Class: F
Landing—Land: No
Landing—Water: Yes
Armor Rating: 7
Saves As: Thick wood
Power Type: Major or minor helm
Ship's Rating: As per helmsman
Standard Armament:
1 Heavy ballista (F)
Crew: 4
OR
1 Heavy catapult (F or A)
Crew: 5
OR
1 Heavy jettison (A)
Crew: 4
Cargo Capacity: 7 tons
Keel Length: 100'
Beam Width: 20'

Description: The Drakkar is a large longship used by Viking peoples. It requires more people to operate it than its tonnage can comfortably support and therefore is not a good ship for long voyages.

The ship is good for short-term raids and piracy, and this is its main purpose. It is (occasionally) used in legal trade as well.

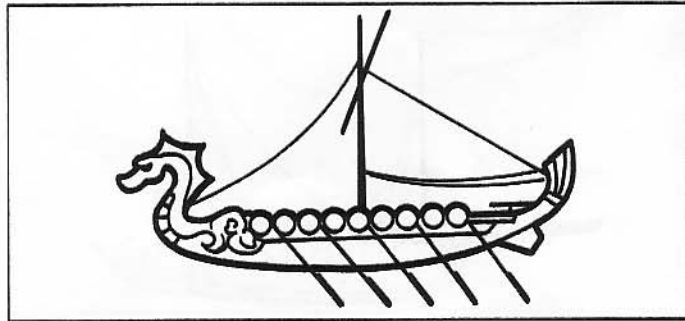

SHIPS OF THE SPELLJAMMER UNIVERSE

Name: Dreadnought

Built By: Mind flayers

Used Primarily By: Mind flayers

Cost: 90,000 gp

Tonnage: 90 tons

Hull Points: 90

Crew: 20/90 (usually 25 mind flayers)

Maneuverability Class: E

Landing—Land: No

Landing—Water: Yes

Armor Rating: 4

Saves As: Thick wood

Power Type: Pool helm

Ship's Rating: 5

Standard Armament:

2 Heavy catapults (2-F)

Crew: 5 each

4 Medium ballistae (1-P, 1-AP, 1-S, 1-AS)

Crew: 2 each

1 Heavy jettison (A)

Crew: 4 each

Piercing ram (F)

Cargo Capacity: 45 tons

Keel Length: 175'

Beam Width: 95'

Description: The newest and largest ship in the illithid fleets, the Dreadnought represents the fullest exploitation yet of the pool helm to produce ships above 50 tons but still beneath the apparent 100-ton maximum. The Dreadnought looks like a great snail-shell laid on its side and resting on two hulls. The hulls are similar to the forward halves of the standard Nautiloid, the workhorse of the illithid fleets. One of the hulls is the command hull and contains the officer's quarters, while the other is the battle hull and is used for ramming. Both hulls mount catapults for assaults.

One mind flayer is deadly, but 25 of them, the maximum number to be found on a Dreadnought, are a disaster waiting to happen. Luckily, these ships are still relatively rare.

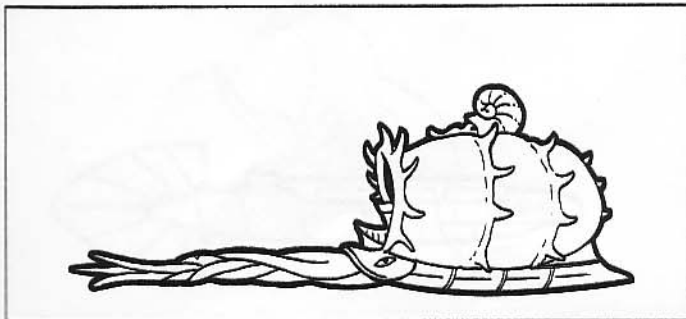

Name: Dromond

Built By: Groundling humans

Used Primarily By: Groundling humans

Cost: 8,000 gp

Tonnage: 16 tons

Hull Points: 16

Crew: 10/16

Maneuverability Class: E

Landing—Land: No

Landing—Water: Yes

Armor Rating: 9

Saves As: Thin wood

Power Type: Major or minor helm

Ship's Rating: As per helmsman

Standard Armament:

3 Heavy ballistae (2-FPS, 1-A)

Crew: 4 each

OR

3 Heavy catapult (2-FPS, 1-A)

Crew: 5 each

OR

3 Heavy jettison (1-A, 1-AP, 1-AS)

Crew: 4 each

OR ANY COMBINATION OF THE ABOVE

Cargo Capacity: 8 tons

Keel Length: 175'

Beam Width: 15'

Description: The Dromond is a groundling vessel converted for use in fantasy space. Its low cost and size make it a relatively good choice for initial star voyages, but its fragile nature leaves much to be desired. Those who own this craft tend to be very quick in surrendering to pirates and privateers unless they can outrun them; the weaponry on board is meant more to discourage attackers than to actually be used to defend the ship. Ambushes by neogi and mind flayer slavers, however, are another story, as many spelljamming races prefer a quick death in battle to the type of slavery practiced by the neogi or illithids.

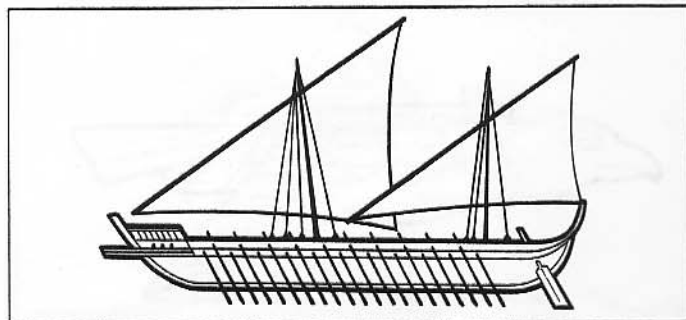

SHIPS OF THE SPELLJAMMER UNIVERSE

Name: Eagle Ship

Built By: Aarakocra
Used Primarily By: Aarakocra
Cost: 35,000 gp
Tonnage: 35 tons
Hull Points: 35
Crew: 8/35
Maneuverability Class: C
Landing—Land: Yes
Landing—Water: Yes
Armor Rating: 6
Saves As: Thick wood
Power Type: Major or minor helm
Ship's Rating: As per helmsman + 1
Standard Armament:
 2 Heavy jettisons (2-A)
 Crew: 4 each
 2 Medium ballistae (1-P, 1-S)
 Crew: 2 each
 1 Light catapult (360°)
 Crew: 1
Cargo Capacity: 18 tons
Keel Length: 150'
Beam Width: 50'

Description: The Eagle Ship is a fairly recent development; as such, very few have been spotted in wild-space and even fewer in the phlogiston. The ship maneuvers by slanting its wings when it turns, giving it a relatively high MC. Aarakocra shamans and mages have only modest spellcasting abilities, resulting in relatively low SRs; however, aarakocra understanding of aerodynamics translates into a + 1 SR for any of their ships.

The aarakocra seem to be more concerned with defense than with offensive capabilities—hence the two heavy jettisons in the aft. Preferring to run from battle whenever possible, the aarakocra have found that these jettisons help deter unfriendly pursuit.

The ships were designed for exploratory expeditions. The low crew needs allow them to travel for long periods of time in search of their brethren.

Name: Eel Ship

Built By: Early humans or insectoid race?
Used Primarily By: Humans
Cost: 10,000 gp
Tonnage: 20 tons
Hull Points: 20
Crew: 4/20
Maneuverability Class: C
Landing—Land: No
Landing—Water: Yes
Armor Rating: 6
Saves As: Thin wood
Power Type: Furnace (15%); major or minor helm (85%)
Ship's Rating: 2 (Furnace) or as per helmsman
Standard Armament:
 1 Medium ballista (F)
 Crew: 2
 1 Medium catapult (A)
 Crew: 3
Cargo Capacity: 8 tons
Keel Length: 110'
Beam Width: 15'

Description: An earlier, cruder version of the Lamprey, these slim vessels are popular for planetary defense. They are also used by pirate raiders unable to get anything better or by commandos conducting stealthy hit-and-run damage missions.

The origin of this small, dangerous-looking craft is unknown. A persistent rumor declares that they were first used by an insectoid race, either the precursors of the thri-kreen or a highly intelligent race of giant wasps. Others believe this to be an early human design sacrificing crew comfort for efficiency.

Whatever their origin, these ships quickly became popular, and when helms began to replace early furnaces, they became even more attractive. Primarily a short range combat craft, Eel Ships were used as escorts against the goblin in the early days of human spacefaring and as the ships of pirates and other reavers, a purpose they serve to this day.

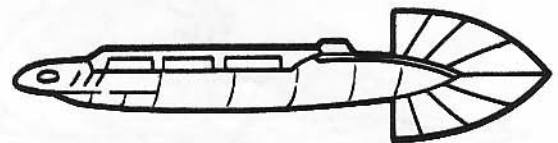
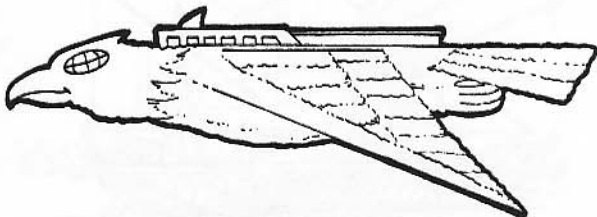

SHIPS OF THE SPELLJAMMER UNIVERSE

Name: Flitter

Built By: Elves

Used Primarily By: Elves

Cost: 4,000 gp

Tonnage: 1 Ton

Hull Points: 1

Crew: 1

Maneuverability Class: B

Landing—Land: Yes

Landing—Water: Yes

Armor Rating: 8

Saves As: Ceramic

Power Type: Non-magical; major or minor helm

Ship's Rating: 2 (Non-magical) or as per helmsman

Standard Armament:

None

Cargo Capacity: None

Keel Length: 20'

Beam Width: 5'

Description: The Flitter is one of the smallest standard ships in fantasy space and is little more than a modified helm tucked within a small butterfly frame. It carries a single passenger/captain/helmsman, who sits just ahead of the wings. The Flitter is really nothing more than an extension of the user's own form.

The Flitter is not recommended for long trips, given its small size and delicate construction. It has insufficient interior space for anything but personal items in a tiny cargo hold. The ship is too small to carry any large weaponry.

Large elven warships of the Armada class carry a number of depowered Flitters (SR 2). While these ships cannot manage interplanetary flight, they are capable of attacking enemy ships. Controls are set into the seat of the Flitter, and the ships are manned by archers or mages who soften up a target before the main attack. These depowered versions of the Flitter are also used for planetfall, since the elves have a strict policy of not allowing any helm-carrying ship to touch ground.

Name: Flying Pyramid

Built By: Human followers of Ptah?

Used Primarily By: Undead humans

Cost: 180,000 gp

Tonnage: 90 tons

Hull Points: 90

Crew: 6/90

Maneuverability Class: F

Landing—Land: Maybe (40%)

Landing—Water: No

Armor Rating: 1

Saves As: Stone

Power Type: Death helm or furnace (90% have both, 10% lack a furnace)

Ship's Rating: 2 (Furnace) or as per victim

Standard Armament:

10 Heavy ballistae (3-F, 2-P, 2-S, 3-A)

Crew: 4 each

10 Heavy jettisons (2-F, 3-P, 3-S, 2-A)

Crew: 4 each

Cargo Capacity: 26 tons

Keel Length: 80'

Beam Width: 80'

Description: A favorite space tavern tale is the ship-raiding of the Dark Pharaoh, an undead mummy of unusual powers who preys upon all spacefarers in his pyramidal ship to gain additional undead servitors. The pharaoh is said to plan a kingdom of undeath in the stars and seeks to bring ships under his sway.

Wise spacefarers speak of more than one pyramid ship: ancient vessels of Ptah-worshippers or temple-ships of similar deities whose influence waned until they have been forgotten in space. They do exist and have been found as planetary defense craft in human-dominated spheres, as undead raiders, drifting derelicts, and even as dwarven shuttles, traveling from a worked-out Citadel ship to an asteroid selected as their new ship.

Many Pyramid ships have Wreckboats or Flitters hidden inside, waiting to take the crew to safety should the mother ship break up.

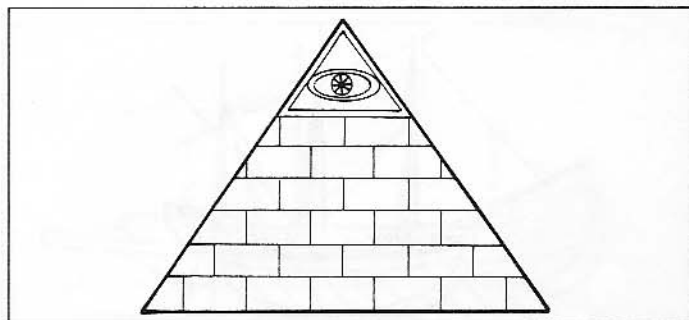
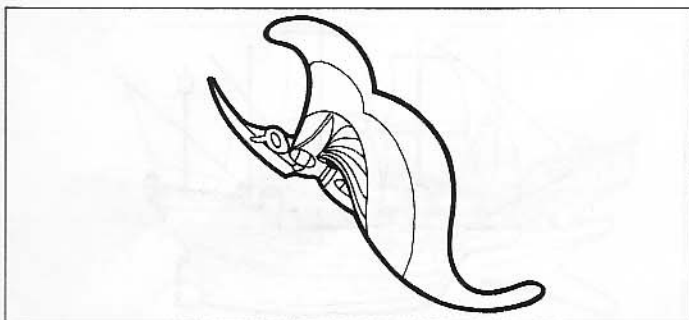

SHIPS OF THE SPELLJAMMER UNIVERSE

Name: Galleon

Built By: Groundling humans
Used Primarily By: Groundling humans
Cost: 40,000 gp
Tonnage: 40 tons
Hull Points: 40
Crew: 20/40
Maneuverability Class: E
Landing—Land: No
Landing—Water: Yes
Armor Rating: 7
Saves As: Thick wood
Power Type: Major or minor helm
Ship's Rating: As per helmsman
Standard Armament:
1 Light catapult (A)
Crew: 1
2 Medium ballistae (1-FP, 1-FS)
Crew: 2 each
Cargo Capacity: 20 tons
Keel Length: 130'
Beam Width: 30'

Description: The Galleon is the best ocean going craft that groundling nations can bring into space. It is nothing more than a sailing ship with a spelljammer helm, purchased or salvaged from some wreck, attached.

Of the peoples of the known worlds, only the nations of Shou Lung and Wa on Toril sponsor a realistic approach to space travel. Other nations dabble, though, and the most thoughtful of them use the Galleon as their vessel of choice. Bulky and slow, it still gets the job done, and its large cargo hold can carry a great deal of spoils from other lands across known fantasy space.

The standard choice of weaponry is listed above, but many nations upgrade their Galleons to make them better able to defend themselves. At the sacrifice of five tons of cargo space, a Galleon can carry four additional light weapons, giving the ship a lethal broadside attack.

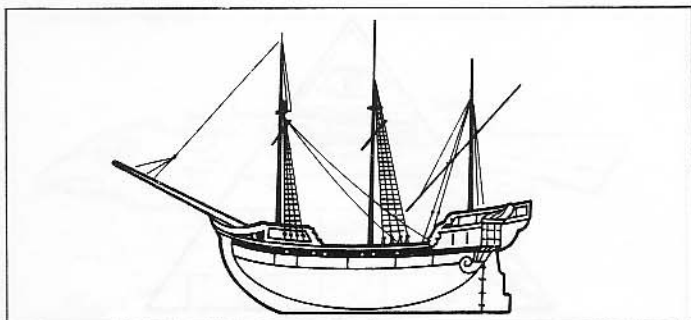

Name: Galleon, Spacesea Giant

Built By: Spacesea giants
Used Primarily By: Spacesea giants
Cost: 120,000 gp
Tonnage: 60 tons
Hull Points: 60
Crew: 11 giants/20 giants
Maneuverability Class: E
Landing—Land: No
Landing—Water: Yes (it floats!)
Armor Rating: 3
Saves As: Stone
Power Type: Major helm
Ship's Rating: As per helmsman
Standard Armament:
3 Heavy ballistae (FPS)
Crew: 2 giants each
11-20 Giants throwing boulders (360°)
Damage: 3d10 hit points or 1d3 Hull Points
Cargo Capacity: 30 tons
Keel Length: 200'
Beam Width: 50'

Description: These huge stone Galleons are larger than the standard Galleon to accommodate their giant owners' greater size. Like their groundling ancestors, the spacesea giants feel more comfortable with a large mass of rock under their feet (see MC7 for more information on the spacesea giant). With the exceptions above, the spacesea Galleon is not much different than its human groundling counterpart.

For every 10 giants, one is an elder who can use *stone shape*, *stone tell*, and *transmute rock to mud* as a 7th level mage. They can use their magical abilities and the ever-present boulders to repair their ship even while in combat. Each boulder yields enough material to repair 1d4 points of hull or mast damage. Rigging damage cannot be repaired in this manner. None of these magical powers are useable while their ship is in the phlogiston.

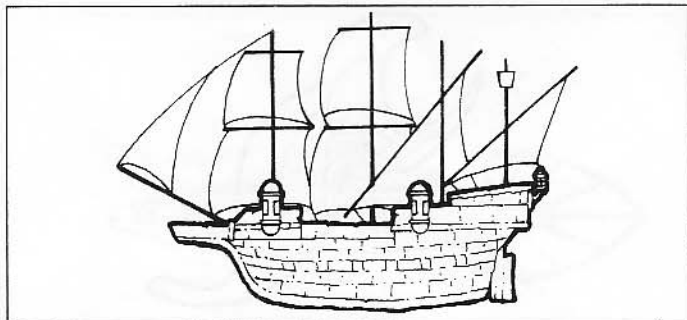

SHIPS OF THE SPELLJAMMER UNIVERSE

Name: Great Bombard

Built By: Giff
Used Primarily By: Giff
Cost: 100,000 gp
Tonnage: 40 tons
Hull Points: 40
Crew: 20/40
Maneuverability Class: E
Landing—Land: No
Landing—Water: Yes
Armor Rating: 6
Saves As: Thick wood
Power Type: Major or minor helm
Ship's Rating: As per helmsman
Standard Armament:
1 Great bombard (F)
Crew: 5
2 Light ballistae (1-AP, 1-AS)
Crew: 1 each
Blunt ram (F)
Cargo Capacity: 20 tons
Keel Length: 140'
Beam Width: 20'

Description: The Great Bombard resembles a single-decked bireme, a groundling craft initially used as the frame for earlier versions of this vessel. Its rowing banks are planked over and its prow replaced with a huge bombard of cold iron banded with steel rings that runs fully half the length of the ship.

The Great Bombard is dominated by the gun that gives it its name. This gun costs 60,000 gp when available at all, has a range of 2,000 yards (4 hexes), and does 2-24 (2d12) Hull Points or 3-30 (3d10) hit points of damage per strike. It can fire once every three rounds and has a THACO of 16, inflicting a Critical Hit on any roll of 19 or 20. It takes a prodigious 20 charges of smokepowder to fire a single shot.

The crew sizes listed above are for M-sized creatures; 10 giff are sufficient to manage both the ship and its gun.

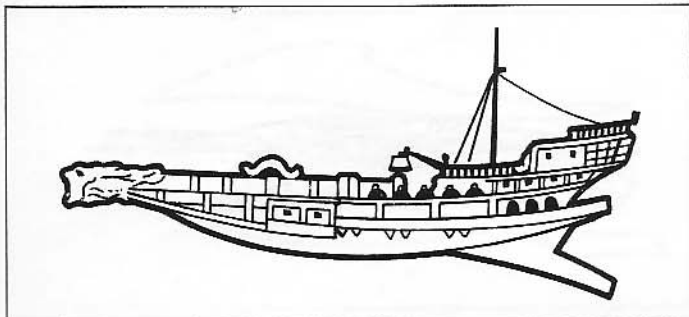

Name: Great Galley

Built By: Groundling humans
Used Primarily By: Groundling humans
Cost: 20,000 gp
Tonnage: 20 tons
Hull Points: 20
Crew: 15/20
Maneuverability Class: F
Landing—Land: No
Landing—Water: Yes
Armor Rating: 7
Saves As: Thick wood
Power Type: Major or minor helm
Ship's Rating: As per helmsman - 1
Standard Armament:
3 Heavy ballistae (1-F, 1-P, 1-S)
Crew: 4 each
OR
3 Heavy catapults (1-F, 1-P, 1-S)
Crew: 5 each
OR
3 Heavy jettisons (1-A, 1-AP, 1-AS)
Crew: 4 each
OR ANY COMBINATION OF THE ABOVE
Cargo Capacity: 10 tons
Keel Length: 130'
Beam Width: 20'

Description: The Great Galley is a groundling vessel powered by slave or freeman rowers; its poor adaptability to wildspace takes the form of a -1 penalty to its Ship Rating. Often experimental wizards take an entire Galley team into space in their first experiment with spelljamming technology. This all too often leads to no further experiments for the more audacious and less cautious mages, since the crew quickly exhausts the ship's air envelope and dies.

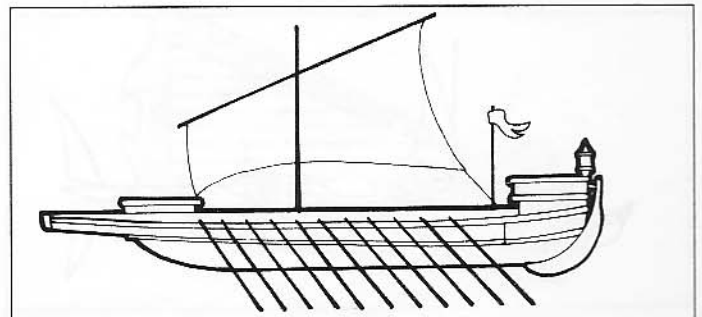

SHIPS OF THE SPELLJAMMER UNIVERSE

Name: Hammership

Built By: Humans, lizard men

Used Primarily By: Humans, lizard men, mind flayers, some elves.

Cost: 60,000 gp

Tonnage: 60 Tons

Hull Points: 60

Crew: 24/60

Maneuverability Class: D

Landing—Land: No

Landing—Water: Yes

Armor Rating: 6

Saves As: Thick wood

Power Type: Major helm

Ship's Rating: As per helmsman

Standard Armament:

2 Heavy catapults (1-A, 1-360°)

Crew: 5 each

1 Heavy ballista (360°)

Crew: 4

Blunt ram (F)

Cargo Capacity: 30 tons

Keel Length: 250'

Beam Width: 25'

Description: Another standard human ship of space, the Hammership is both powerful and roomy, capable of withstanding large amounts of punishment and dealing out a massive amount with its blunt ram. Hammerships are found throughout known space with small modifications to their design and weapon specifications.

A Hammership requires a larger crew than the more common Squid Ship but can carry more cargo. Though not commonly used as a pirate vessel, the Hammership is the favorite craft of some of the more stylish and brazen pirates and privateers in known space. The Hammership is also a common transport craft, capable of hauling many men across space and returning with supplies to support an invasion of any size.

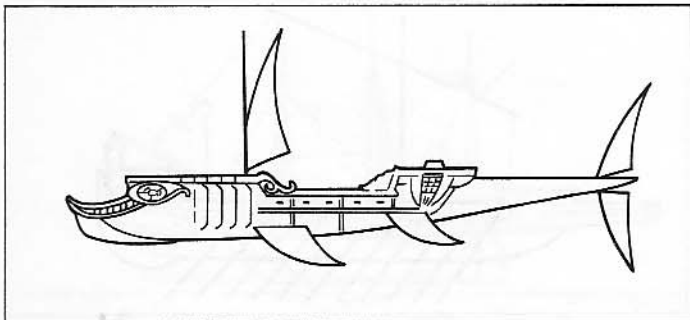

Name: Hummingbird (Unique)

Built By: Humans

Used Primarily By: Humans

Cost: 18,000 gp

Tonnage: 7 tons

Hull Points: 7

Crew: 2/10

Maneuverability Class: A

Landing—Land: Yes

Landing—Water: No

Armor Rating: 8

Saves As: Thin wood

Power Type: Major helm

Ship's Rating: As per helmsman

Standard Armament:

Special (F)

Piercing ram (F)

Cargo Capacity: 3 tons

Keel Length: 100'

Beam Width: 20'

Description: The Hummingbird is a ship created by Thesalys engineers in Greatspace. It is typically used as a court ship, carrying visiting dignitaries. The magical energies of the spelljamming helm focus through the craft's wings, causing them to vibrate rapidly. This has the effect of constantly displacing the mass of the craft, making it appear to be less than its actual mass. This effect also gives the ship its MC A. So smooth is the vibration and so superior the engineering that the moving wings have no noticeable effect to someone on the craft.

Although the ship's long beak is capable of serving as a piercing ram, the Hummingbird's main weapon is a specialized form of *magic missiles*. Any mage not acting as helmsman who is capable of casting a *magic missile* spell can make use of this weapon. The mage simply casts the spell at a crystal mounted on a pedestal. The missiles are absorbed, amplified, and launched out the end of the beak. The crystal launches one missile per round which deals one Hull Point of damage per missile cast into it.

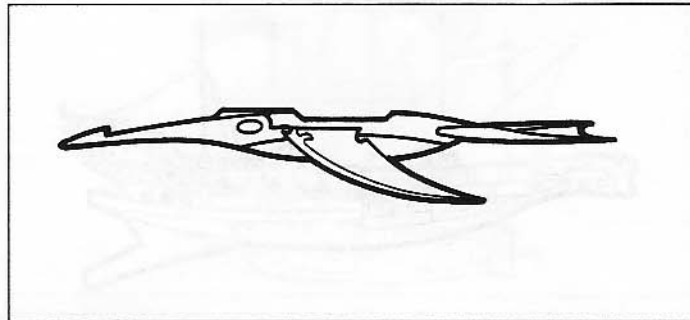

SHIPS OF THE SPELLJAMMER UNIVERSE

Name: Hunter-Killer (Vodoni Assassin)

Built By: Zalani

Used Primarily By: Vodoni

Cost: 240,000 gp

Tonnage: 60 tons

Hull Points: 60

Crew: 10/60

Maneuverability Class: C

Landing—Land: Yes

Landing—Water: No

Armor Rating: 5

Saves As: Ceramic

Power Type: Major helm

Ship's Rating: As per helmsman

Standard Armament:

2 Medium ballistae (1-FS, 1-AP)

Crew: 4 each

2 Medium catapults (1-FP, 1-AS)

Crew: 6 each

2 Bombards (1-F, 1-A)

Crew: 4 each

2 Medium jettisons (1-F, 1-A)

Crew: 6 each

Cargo Capacity: 30 tons

Keel Length: 260'

Beam Width: 40'

Wingspan: 400'

Description: The Hunter-Killer (also known as the Vodoni Assassin) is designed to look like a twin-headed, winged, smiling she-wolf. It looks the same from ahead and behind. The ship is wide but very maneuverable, due to a swiveling mast that allows it to change course very quickly.

The Hunter-Killer is the Vodoni ranged-combat war ship. Its specially designed ballistae, catapults, jettisons, and bombards allow the vessel to remain out of range of its opponents while attacking. These weapons have double the standard range and require extra weaponeers to load and fire. Since the fall of the Vodoni empire, the secret of these weapons' construction has been lost.

Name: lambus

Built By: Arcane

Used Primarily By: Bardic humans

Cost: 35,000 gp

Tonnage: 35 tons

Hull Points: 35

Crew: 4/35

Maneuverability Class: D

Landing—Land: No

Landing—Water: Yes

Armor Rating: 5

Saves As: Thick wood

Power Type: Bardic helm

Ship's Rating: As per Bard helmsman

Standard Armament:

3 Light ballistae (1-FP, 1-FS, 1-APS)

Crew: 1 each

1 Heavy ballista (F)

Crew: 4 each

Cargo Capacity: 17½ tons

Keel Length: 180'

Beam Width: 20'

Height: 150'

Description: The lambus is a specialized ship designed specifically for a bardic helmsman. Musical proficiencies of any type can be used, but skill in the musical instrument attached to the ship's helm is mandatory to propel the ship. Acting like a major helm, the bardic helm gives the ship SR points in accordance to the bard's experience level.

As the bard plays his instrument, the ship moves forward. The music created has a soothing effect on the crew, who heal damage twice as fast as normal. However, the crew and helmsman are always surprised when attacked, being allowed to attack only in the second melee round of combat after a standard initiative roll.

An lambus can appear in any shape, but each resembles (slightly) the musical instrument attached to the helm.

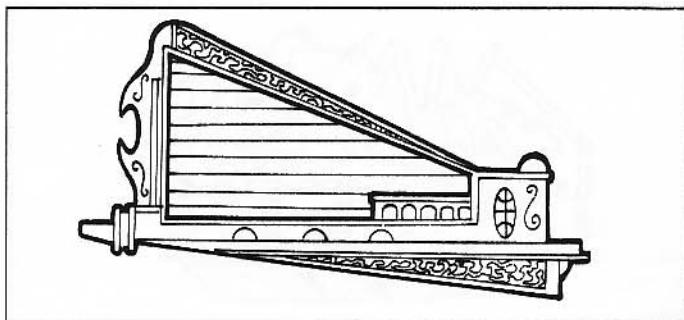
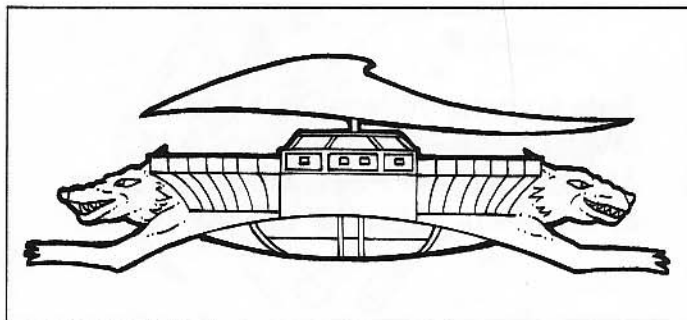

SHIPS OF THE SPELLJAMMER UNIVERSE

Name: Jade Spider

Built By: Drow

Used Primarily By: Drow

Cost: 150,000 gp

Tonnage: 20 tons

Hull Points: 20

Crew: 7/20

Maneuverability Class: B

Landing—Land: Yes

Landing—Water: No

Armor Rating: 0 (hull)

2 (legs)

-2 (drill assembly)

Saves As: Best of Ceramic or Metal

Power Type: Radiant helm (55%); lifejammer (45%)

Ship's Rating: As per helmsman or victim

Standard Armament:

1 Adamantine drill (F)

Crew: 6

1 Grappling ram (F)

Cargo Capacity: 10 tons

Keel Length: 40'

Beam Width: 20'

Description: These attack craft are constructed from rock, precious metals, and radiant substances found only in the drow's Underdark realm. These elements bind together to form the hard (AR 0) shell around the body of the craft. The only way into or out of the craft is a man-sized hatch out of which the ship's main weapon, an adamantite drill assembly, protrudes during its attack.

The legs are constructed of a metallic substance highly resistant to heat (+2 to save). The legs end in spiked claws used to bring a captured ship adjacent to the body of the Jade Spider. In order to capture a ship, the helmsman must roll a successful hit against the AR of the opponent's ship. If this occurs, the legs hit and stick, pulling the crafts together by the end of the round.

Once adjacent, the Jade Spider ship extends its drill assembly and begins boring into the side of the

enemy ship. It takes but a single round for the drill to penetrate the opponent's hull, inflicting 5 Hull Points damage and causing an immediate Hull Holed critical hit in the process.

Once the boring is complete, the drow within pour forth from the drill, attacking and stealing whatever valuables they can find. If the drow ship is attacking the neogi (their primary enemy in wildspace) they send several jade spiders (see box below) into the belly of the opposing ship first. Umber hulks, the preferred slave for the neogi, are violently allergic to and deathly afraid of these mechanical spiders, running in fear whenever they encounter them. Each drow ship carries 4-24 (4d6) jade spiders for just this purpose.

When the victim's ship is gutted and all valuables removed, the drow retreat into the Jade Spider, retract the drill assembly, and continue on their way.

The living quarters within the body of the Jade Spider hang from the "ceiling"—i. e., the craft's outer hull. The spelljamming helm is located near the drill hatch, where a drow spellcaster or human mage (hired or enslaved) sits and propels the craft.

Luckily, Jade Spider ships mainly attack the neogi. Drow, in their endless destruction of the "ugly," have turned their sights on the neogi, viewing these hideous creatures as an insult to Lolth (the drow's leading deity) and the drow aesthetics.

Jade Spiders are commonly carried on the back or in the webbing of the great Jade Spider Commandships. These craft are huge bulky vessels that strike fear in every neogi heart. Ironically, they are sometimes attacked by humans unable to distinguish the elegant drow spider-ships from those of their hated neogi nemeses.

On Jade Spider ships containing lifejammer helms, the preferred victim will be either neogi or their umber hulk slaves. If none of these creatures are available, the drow will use elves (especially those with a haughty, better-than-thou attitude), dwarves, and humans. When no other victims are available, they use each other, creating daily lifejammer shifts.

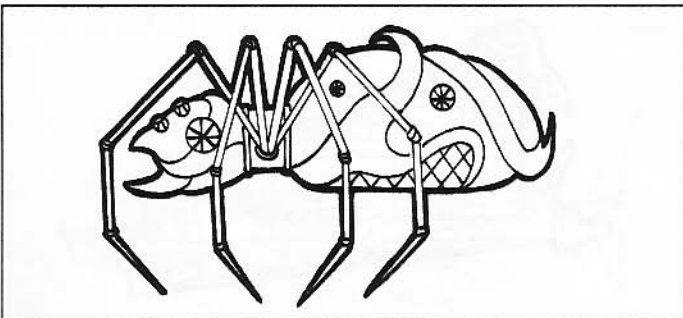

Jade Spiders: Int Non; AL N; AC 5; MV 10; HD 6+6; Hp 54; THAC0 15; #AT 3; Dmg 3d4x2/2d4; ML 20; SD saves as 16th Mage; SZ H (15' tall); XP 10,000.

SHIPS OF THE SPELLJAMMER UNIVERSE

Name: Jade Spider Commandship

Built By: Drow
Used Primarily By: Drow
Cost: 1,000,000 gp
Tonnage: 100 tons
Hull Points: 100
Crew: 20/100
Maneuverability Class: F
Landing—Land: Yes
Landing—Water: No
Armor Rating: 0
Saves As: Best of Ceramic or Metal
Power Type: Radiant helm
Ship's Rating: As per helmsman
Standard Armament:
1 Adamantine Drill (F)
Crew: 8
1 Grappling/piercing ram (F)
Cargo Capacity: 50 tons
Keel Length: 250'
Beam Width: 180'
Height: 150'

Description: This completely enclosed ship looks from the outside like an enormous Jade Spider. Inside, it is a miniature hollow world, with buildings hanging upside-down from the inside of the outer hull, creating a dark, cave-like environment that the drow find comfortable.

Each Commandship can carry up to 5 Jade Spider attack craft on its back or in the webbing between its legs. This towing capacity is due to the strength of the ship's *radiant helm*, which can tow an additional 100 tons of external weight at spelljamming speeds (see *The War Captain's Guide* for details).

The only way into the ship is via the drill assembly, just as with the smaller attack craft; up to three drow can fit side by side on the catwalk inside. The damage from this drill is 10 Hull Points, a Hull Holed critical hit, and another randomly rolled critical hit, all inflicted in a single round.

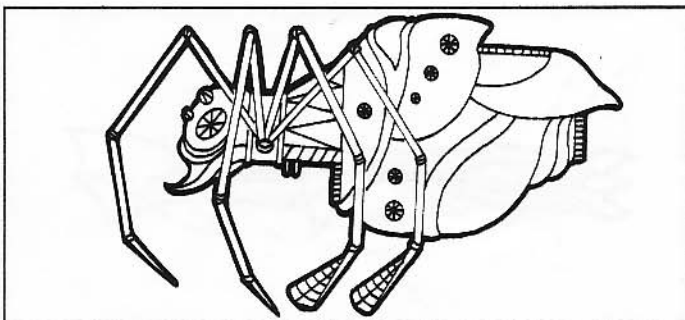

Name: Junk

Built By: Groundling humans of Shou Lung on Toril
Used Primarily By: Groundling humans of Shou Lung on Toril
Cost: 2,500 gp
Tonnage: 20 tons
Hull Points: 20
Crew: 4/20
Maneuverability Class: F
Landing—Land: No
Landing—Water: Yes
Armor Rating: 9
Saves As: Light wood
Power Type: Major or minor helm
Ship's Rating: As per helmsman at -1 penalty
Standard Armament:
None
OR
2 Light ballistae (1-FPS, 1-APS)
Crew: 1 each
1 Bombard (A)
Crew: 3
Cargo Capacity: 14 tons
Keel Length: 75'
Beam Width: 30'

Description: These nondescript ships are nothing more than the Junks common in Shou Lung marsh and coastal areas adapted to wildspace. Generally, these craft do not possess any weapons, since they are used primarily as civilian ferries. However, now that the Shou Lung have experienced the perils of wildspace, they are beginning to bolt weapons on modified Junks as convoy security.

Junks tend to have three times as many passengers as the ship can theoretically hold, causing an ever-increasing number of them to be found floating derelict with a poisoned atmosphere. These ships are usually good sources of riches and cargo for those bold enough to brave the poisoned atmosphere.

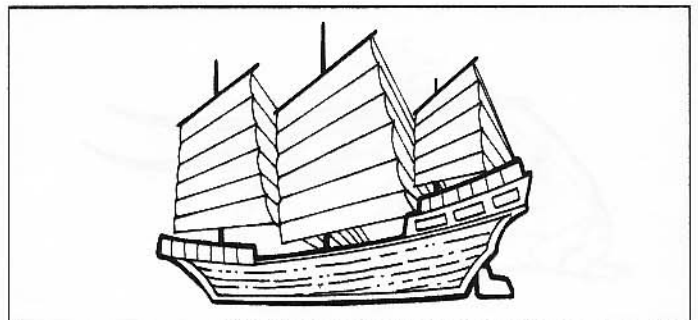

SHIPS OF THE SPELLJAMMER UNIVERSE

Name: Klicklikak

Built By: Insectare

Used Primarily By: Insectare

Cost: 20,000 gp

Tonnage: 20 tons

Hull Points: 18

Crew: 10/20

Maneuverability Class: C

Landing—Land: Yes

Landing—Water: No

Armor Rating: 6

Saves As: Thick wood

Power Type: Insectare helm (major or minor)

Ship's Rating: As per helmsman

Standard Armament:

1 Heavy ballista (360°)

Crew: 4

Cargo Capacity: 10 tons

Keel Length: 80'

Beam Width: 30'

Description: The Klicklikak is a distinctive, sleek-looking ship that resembles a grasshopper's head with two long antennae trailing behind it. The ship's name means "Service to Klikral" in the insectare native tongue.

The insectare power the Klicklikak, their standard spelljamming craft, with a special spelljamming helm consisting of a shiny copper sphere with two holes. To propel the Klicklikak through space, an insectare inserts its two antennae into these two holes. Only insectare can use this helm, and, conversely, insectare cannot use other helm types.

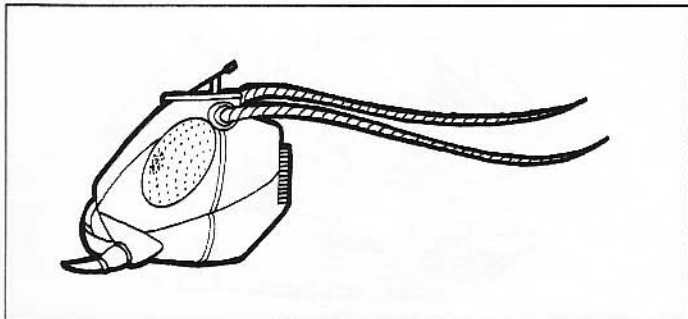

Name: Lamprey Ship (Striker)

Built By: Early human or insectoid spacefaring race?

Used Primarily By: Humans, goblinkin

Cost: 26,000 gp

Tonnage: 26 tons

Hull Points: 26

Crew: 8/26

Maneuverability Class: B

Landing—Land: No

Landing—Water: No

Armor Rating: 4

Saves As: Thick wood

Power Type: Furnace (20%); minor helm (40%); major helm (40%)

Ship's Rating: 2 (Furnace) or as per helmsman

Standard Armament:

3 Medium ballistae (1-FP, 1-FS, 1-A)

Crew: 2 each

Cone ram with medium ballista (F)

Crew 2

Cargo Capacity: 6 tons

Keel Length: 115'

Beam Width: 25'

Description: This slim, ancient ship is well represented in space. It is serviceable enough to be widely used by human spacefarers and copied by gnolls, orcs, and goblins trying to conceal their identities.

A development of the Eel Ship, the Lamprey was designed specifically as a fighting craft. It is sufficiently different to have a distinct entry, although the two craft are similar in appearance when seen from afar. Many Lampreys were designed with special "jaw-grapples" operated by winches in the command cabin. When the ship rams, the grapples crush the enemy ship for 1-2 additional points of hull damage.

Warrior Lampreys (Strikers) sacrifice the controversial cone ram and its ballista in exchange for a blunt ram and an under-mounted medium catapult. Cargo shrinks to a mere three tons, and practical minimum crew rises by one crewman.

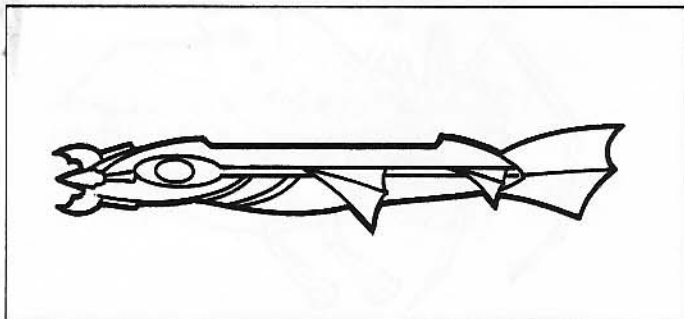

SHIPS OF THE SPELLJAMMER UNIVERSE

Name: Leaf-Ship

Built By: Thri-kreen

Used Primarily By: Thri-kreen

Cost: 280,000 gp

Tonnage: 70 tons

Hull Points: 70

Crew: 20/65

Maneuverability Class: D

Landing—Land: No

Landing—Water: Yes

Armor Rating: 6

Saves As: Ceramic

Power Type: Crystal throne

Ship's Rating: 4

Standard Armament:

1 Heavy catapult (F)

Crew: 5

4 Heavy ballistae (1-FP, 1-FS, 1-AP, 1-AS)

Crew: 4 each

Piercing ram (F)

Cargo Capacity: 30 tons

Keel Length: 250'

Beam Width: 40'

Description: The Leaf-Ship resembles a long leaf. There are stations around the hull where up to four Thorn-Ships can dock. Leaf-Ships are very resilient. As with elven ships, these vessels are grown from living crystal. Their color is usually a delicate, translucent green or yellow.

Their source of power is a device the thri-kreen call the "crystal throne." This is a huge multi-faceted crystal formed roughly in the shape of a wide-armed throne. It glows with a pale inner light and operates as a minor spelljamming helm. Any thri-kreen can operate the throne; no spell casting abilities are necessary. The ship's SR is determined by the construction of the device, as opposed to the attributes of the individual using it. There are no spelljamming after-effects from its use. No race other than the thri-kreen can use a crystal throne because all others lack the correct mental architecture.

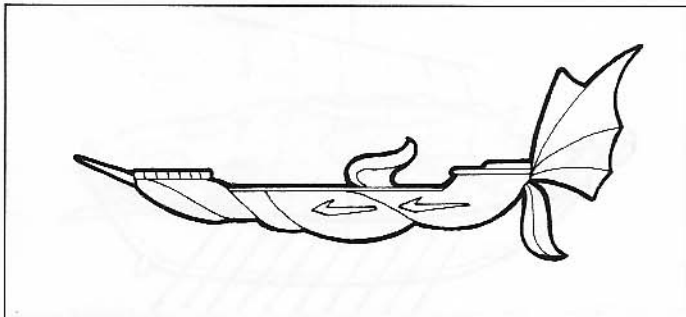

Name: Leech

Built By: Neogi

Used Primarily By: Neogi

Cost: 60,000-300,000 gp

Tonnage: 20

Hull Points: 20

Crew: 2/20

Maneuverability Class: B (alone)
D (when mounted)

Landing—Land: No

Landing—Water: No

Armor Rating: 9

Saves As: Metal

Power Type: Lifejammer

Ship's Rating: As per victim

Standard Armament:

1 Light catapult (F)

Crew: 1

Cargo Capacity: 10 tons

Keel Length: 50'

Beam Width: 30'

Description: The Leech is little more than a lifejammer drive mounted within a small dome. The dome is supported by eight grappling legs, giving the entire structure the appearance of a headless spider. It can be operated by a single neogi with its umber hulk slave.

The Leech is designed to fit on the back of another living creature, which may or may not have space-faring abilities of its own, and turn the tandem device and being into a spelljamming ship. The process of using the lifejammer drive kills the harnessed creature, so the neogi can only use it in situations where time is of importance or where replacement creatures can be found.

Of concern to the elves is the growing use of leeched kindori or other creatures as weapons of terror. Leeches loaded with Greek fire are being crashed into civilized areas. The dead pilot is usually neogi, but charred humans and dwarves have been dragged from the resulting firestorm.

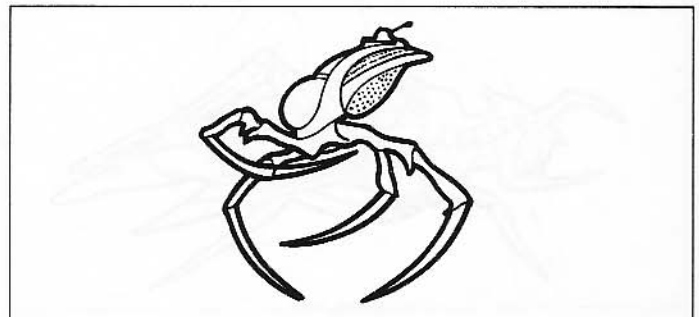

SHIPS OF THE SPELLJAMMER UNIVERSE

Name: Locust

Built By: Groundling humans of Wa on Toril
Used Primarily By: Groundling humans of Wa
Cost: 375 gp
Tonnage: 1,500 pounds
Hull Points: 1 (8 hp)
Crew: 2/3
Maneuverability Class: A
Landing—Land: Yes
Landing—Water: Yes
Armor Rating: 4
Saves As: Light wood
Power Type: *Rudder of propulsion*
Ship's Rating: 6
Standard Armament:

1 Light catapult (A)

Crew: 1

OR

1 Light ballista (F)

Crew: 1

Cargo Capacity: 750 pounds of Greek fire, ammunition, or a single passenger

Keel Length: 14'

Beam Width: 4'

Description: A Locust looks like a grasshopper made of balsa wood. It is very light and maneuverable but easily destroyed. This small craft has enough room for two crew members and one passenger or 750 pounds of cargo. These craft are so fast and agile that they are very difficult to hit, but once hit they are usually completely destroyed.

As war ships, these craft are nothing more than suicide machines. The ship requires one member of the crew to man the *rudder of propulsion* while the other works the armament. The *rudder of propulsion* gives the craft its speed and maneuverability.

The weapon uses the legs and antennae as supports. On a natural to hit roll of one, the weapon breaks off, splitting the ship in half. This usually kills all on board, crushing them between the two halves of the ship.

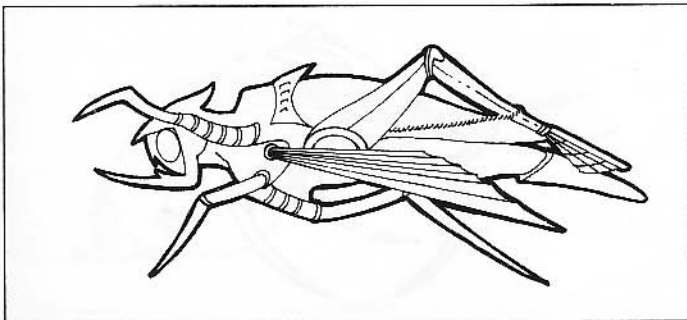

Name: Longship

Built By: Groundling humans
Used Primarily By: Groundling humans
Cost: 2,000 gp
Tonnage: 4 tons
Hull Points: 4
Crew: 12/4
Maneuverability Class: E
Landing—Land: No
Landing—Water: Yes
Armor Rating: 8
Saves As: Thin wood
Power Type: Major or minor helm
Ship's Rating: As per helmsman
Standard Armament:

1 Heavy ballista (F)

Crew: 4

OR

1 Heavy catapult (F)

Crew: 5

OR

1 Heavy jettison (A)

Crew: 4

Cargo Capacity: 2 tons

Keel Length: 75'

Beam Width: 15'

Description: The Longship is an ideal carrier for small numbers of adventurers into fantasy space. However, as with Galleys, taking a full crew beyond the atmosphere envelope of a planet quickly results in fouling of the ship's air envelope and a premature-ly terminated journey.

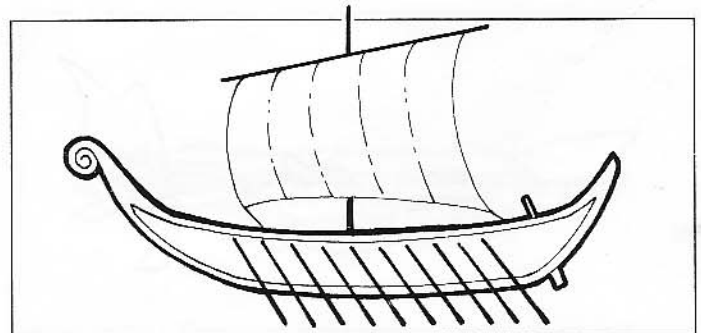

SHIPS OF THE SPELLJAMMER UNIVERSE

Name: Mammoth

Built By: Ogres

Used Primarily By: Ogres

Cost: 90,000 gp

Tonnage: 90 tons

Hull Points: 90

Crew: 27/90

Maneuverability Class: E

Landing—Land: Yes

Landing—Water: No

Armor Rating: 4

Saves As: Thick wood

Power Type: Furnace (20%); major helm (10%); death helm (70%)

Ship's Rating: 2 (Furnace) or as per helmsman or victim

Standard Armament:

4 Heavy ballistae (2-FP, 2-FS)

Crew: 4 each

4 Heavy catapults (1-P, 1-S, 2-A)

Crew: 5 each

1 Heavy jettison (A)

Crew: 4

Blunt ram (F)

Cargo Capacity: 36 tons

Keel Length: 135'

Beam Width: 45'

Description: Formerly the pride of the ogre space fleets, since the fall of ogre power these massive vessels have seen service as mobile bases for human pirates and as mind flayer slaving vessels.

Ogres using a Mammoth in war use slaves to power their death helms, load the ship with weaponry, and cram aboard as many ogre warriors as they can gather (usually 500-600; a maximum of 788 can fit). They ignore air considerations, believing that the victorious can breathe the air of their victims and the defeated are better off dead anyway.

Mammoths often carry 3-6 (1d4 + 2) goblin Blades lashed to the underside of the hull for use as boarding boats or rams.

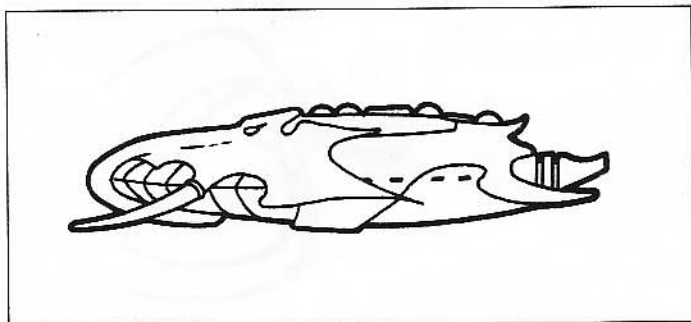

Name: Man-o-War

Built By: Elves

Used Primarily By: Elves, some humans

Cost: 240,000 gp

Tonnage: 60 tons

Hull Points: 60

Crew: 10/60

Maneuverability Class: C

Landing—Land: No

Landing—Water: No

Armor Rating: 7

Saves As: Ceramic

Power Type: Major helm

Ship's Rating: As per helmsman

Standard Armament:

2 Medium ballistae (1-FP, 1-FS)

Crew: 2 each

1 Medium catapult (F)

Crew: 3

1 Medium jettison (A)

Crew: 3

Cargo Capacity: 30 tons

Keel Length: 200'

Beam Width: 20'

Description: Built on the largest elven hull available outside the great Armadas, the Man-o-War is a highly maneuverable, dependable ship. These elven ships are grown from glossy, relatively brittle plants, giving them their shiny, ethereal appearance. Each ship stays alive, much like a tree, throughout its life. Hence, a Man-o-War's crystalline wings require constant pruning and shaping to keep the ship from becoming too unwieldy. A good adventuring craft for deep space, this ship should serve its owners well.

Like all elven ships, Man-o-Wars can be repaired in normal fashion, since blocks of wood and stone can be easily grafted into the craft. Thus, any character with woodworking or carpentry proficiencies should be able to keep the ship in good trim.

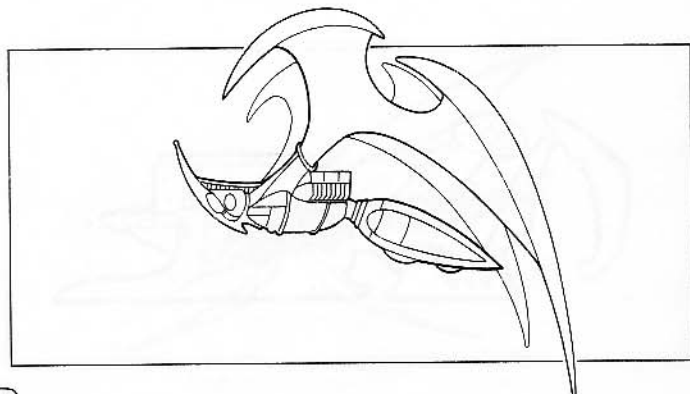

SHIPS OF THE SPELLJAMMER UNIVERSE

Name: Mantis

Built By: Scro

Used Primarily By: Scro

Cost: 90,000 gp

Tonnage: 60 tons

Hull Points: 60

Crew: 12/75

Maneuverability Class: C

Landing—Land: Yes

Landing—Water: No (see below)

Armor Rating: 4

Saves As: Metal

Power Type: Major helm (30%) or death helm (70%)

Ship's Rating: As per helmsman or victim

Standard Armament:

2 Grappling rams (F)

Crew: 3 each

2 Medium ballistae (360°)

Crew: 2 each

1 Heavy catapult (F)

Crew: 5

Cargo Capacity: 20 tons

Keel Length: 170'

Beam Width: 25'

Description: The Mantis ship was specifically designed to combat the elven fleets. Its grappling rams do 1d4 Hull Points of damage each. The razor-sharp crest on its back does 1d4 Hull Points of damage whenever it grazes an enemy ship, as do each of the runners under the vessel. All of these weapons are designed to slice through the wings that exist on virtually all elven vessels.

The arms of the Mantis are retractable. They can be folded down under the front of the ship to allow an unobscured view from the forward portals. The ship can land on solid surfaces, but the arms must be raised out of the way first. The ship is watertight, but it rarely lands on water because its rear cargo doors are mounted so low.

Once a ship is grappled, a boarding party waiting in the sally room shoots down a slide mounted in the mouth of the Mantis. Up to 12 scro per round can

board a grappled ship. The first six can attack the same round they board; the rest must wait until the next round to get into position. The slide is slick enough that it cannot be climbed to get back into the Mantis. The mouth of the Mantis can be pulled shut as well. It takes two crewmen to work the winches that open and close the mouth.

Since the scro regard personal combat as a form of artistry, the Mantis is not as heavily armed with ballistae or catapults as it could be (there is plenty of room on the top deck for more weapons). Scro tactics usually involve making several passes, slicing away at the enemy ship, before sending in the boarding party.

The exterior of the Mantis is metal plated. It is dulled and pitted, as the scro are not particularly concerned with beauty and aesthetics. By contrast, the functional parts of the ship (the tips of the grappling rams, the razor back, etc.) are oiled, burnished, and buffed regularly to keep them all in tip top shape.

The spelljamming helm room is considered a holy place by the scro, one that can only be entered by the warpriest and the captain. Even the captain can enter only if given express permission by the warpriest. Anyone needing to speak to the warpriest while he is at the helm must stand in the narrow hallway that adjoins the room. Anyone breaking this taboo is immediately put to death.

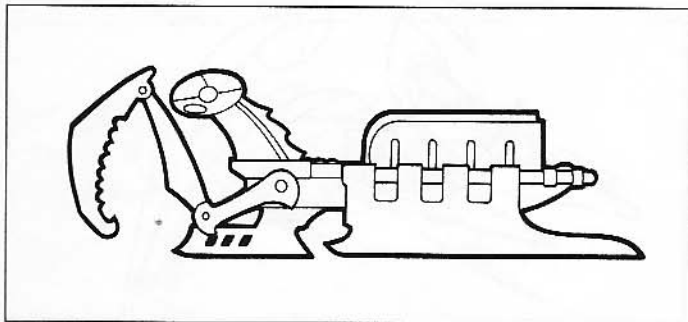

SHIPS OF THE SPELLJAMMER UNIVERSE

Name: Mindspider

Built By: Neogi
Used Primarily By: Neogi
Cost: 120,000 gp
Tonnage: 40 tons
Hull Points: 40
Crew: 3/40
Maneuverability Class: C
Landing—Land: No
Landing—Water: No
Armor Rating: 4
Saves As: Metal
Power Type: Lifejammer
Ship's Rating: As per victim
Standard Armament:
 2 Medium catapults (2-A)
 Crew: 3 each
 1 Medium jettison (A)
 Crew: 3
 Piercing/grappling ram (F)
 Piercing ram (A)
Cargo Capacity: 20 tons
Keel Length: 40' (excluding rams)
Beam Width: 15'

Description: The Mindspider is a new ship, but it is proving to be as deadly as the Deathspider, one of the most feared ships in space. The Mindspider is a lighter, faster, more maneuverable, and stronger craft than the Deathspider but carries less weaponry. It is used in situations where subtlety (or what passes in neogi terms for subtlety) is needed.

When more than one Deathspider is present, a Mindspider will be used as the command vessel and lair of the fleet owner. The neogi find this a useful bit of misdirection, since opponents naturally assume their chief foe will be on the largest enemy vessel.

It is almost unheard of for anyone other than neogi to use one of these craft, not just for fear of neogi reprisals but because the neogi have so many enemies; PCs aboard a stolen Mindspider can expect to be avoided or attacked by every ship they encounter.

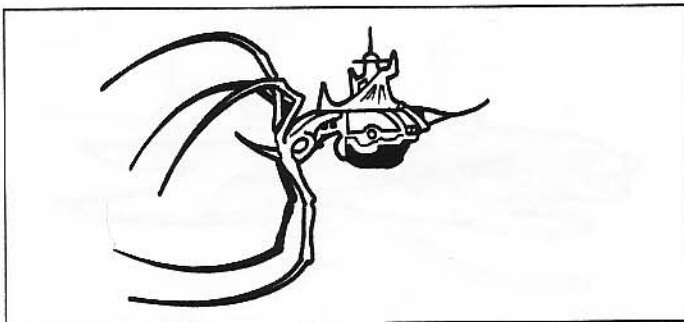

Name: Mosquito

Built By: Humans
Used Primarily By: All races
Cost: 3,000 gp
Tonnage: 6 tons
Hull Points: 6
Crew: 1/6
Maneuverability Class: C
Landing—Land: Yes
Landing—Water: Yes
Armor Rating: 5
Saves As: Thin wood
Power Type: Major or minor helm
Ship's Rating: As per helmsman
Standard Armament:
 None
Cargo Capacity: 3 tons
Keel Length: 100'
Beam Width: 15'

Description: The Mosquito, along with the elven Flitter, is among the smallest spelljammer helm-carrying vessels in common use in fantasy space. The Mosquito is used as a shuttle, landing craft, spy ship, and infiltrator. Its small size makes it unsuitable for combat. One good hit from a heavy weapon can usually knock it out.

Most Mosquitos are carried on larger ships and used occasionally as rescue craft and lifeboats. Often the spelljamming helm is stripped out of the mosquito landing craft, as that is the most expensive part of the vehicle.

In sections of space with long-standing wars, Mosquitoes are often stripped of their helms and cast adrift after being filled to the brim with Greek fire canisters and other flammable substances. The hope is that such space hulks will fall into the gravity planes of larger enemy ships and crash, setting them on fire. Often swarms of Mosquitos are left in orbit around enemy planets.

Races sensitive to light, such as mind flayers, cover the upper deck of their Mosquitos with a dome; this does not affect the MC or AR or the ship.

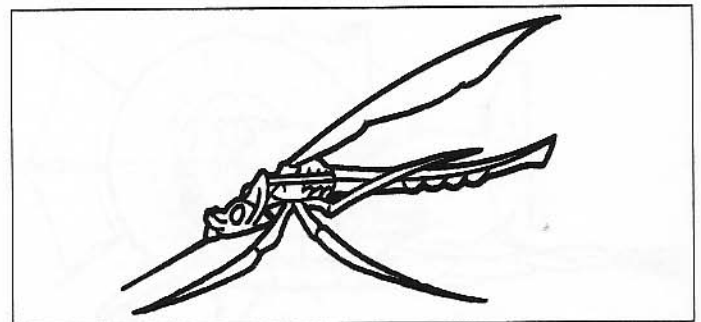

SHIPS OF THE SPELLJAMMER UNIVERSE

Name: Nautiloid

Built By: Mind flayers

Used Primarily By: Mind flayers

Cost: 35,000 gp

Tonnage: 35 tons

Hull Points: 35

Crew: 10/35

Maneuverability Class: D

Landing—Land: No

Landing—Water: Yes

Armor Rating: 4

Saves As: Thick wood

Power Type: Series helm (90%); pool helm (10%)

Ship's Rating: 2-5 (series); 5 (pool)

Standard Armament:

3 Medium ballistae (1-FP, 1-FS, 1-F)

Crew: 2 each

1 Medium catapult (F)

Crew: 3

1 Medium jettison (A)

Crew: 3

Piercing ram (F)

Cargo Capacity: 17 tons

Keel Length: 180'

Beam Width: 30'

Description: The Nautiloid is the standard ship of the line of the various spacefaring illithid nations; its design reflects the nature of the race. Its coiled shell provides the comfort of enclosed spaces while protecting the illithids from the irritating rays of the suns. A standard mind flayer crew numbers 10 illithids, plus 2-5 helmsmen to power the series helms. The Ship Rating of a Nautiloid ship is determined by the number of such helms in use. A Nautiloid has a single captain and first officer, the remainder of the group being crew.

In addition to the 12 to 15 mind flayers on board, the remainder of the crew (up to 35) will be slaves and (rarely) passengers. Since slaves usually serve as rations on long voyages, there is a high attrition rate among them.

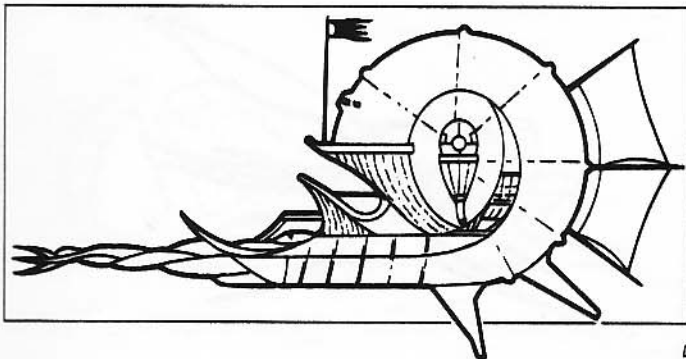

Name: Nightwolf (Vodoni Scout)

Built By: Zalani

Used Primarily By: Vodoni

Cost: 160,000 gp

Tonnage: 40 tons

Hull Points: 40

Crew: 3/40

Maneuverability Class: B

Landing—Land: Yes

Landing—Water: Yes

Armor Rating: 4

Saves As: Ceramic

Power Type: Major helm

Ship's Rating: As per helmsman

Standard Armament:

2 Medium catapults (1-FP, 1-FS)

Crew: 3 each

1 Medium jettison (A)

Crew: 3

Cargo Capacity: 20 tons

Keel Length: 50'

Beam Width: 20'

Wingspan: 80'

Description: The Nightwolf (also known as the Vodoni Scout) looks like a long, sleek, winged black wolf. It is not equipped with any form of ram, the wolf's head at the prow being purely decorative. The ship's appearance was designed to strike terror into the hearts of the Vodoni's enemies (e.g., just about everybody). Most survivors of an encounter with one of these ships agree it does just that.

The Nightwolf is a scout and spy ship—small, black, and fast. It is unusually maneuverable for a ship of its size (MC B) and has better armor than any other Vodoni ship, making it a truly formidable opponent, one few would willingly face twice.

Occasionally Nightwolves are sent on suicide missions with only a minimal crew; these "lone wolves" quickly become disabled on any hit roll that inflicts crew casualties.

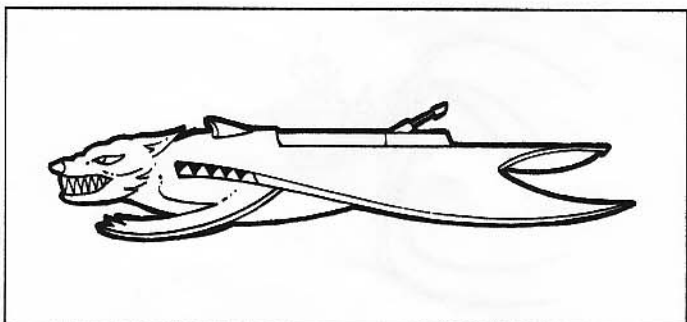

SHIPS OF THE SPELLJAMMER UNIVERSE

Name: Octopus (Tailgunner)

Built By: Humans, mind flayers

Used Primarily By: Humans, mind flayers

Cost: 70,000 gp

Tonnage: 70 tons

Hull Points: 70

Crew: 13/70

Maneuverability Class: D

Landing—Land: Yes

Landing—Water: No

Armor Rating: 7

Saves As: Thick wood

Power Type: Major or minor helm; pool helm

Ship's Rating: 5 (Pool helm) or as per helmsman

Standard Armament:

2 Heavy catapults (2-360°)

Crew: 5 each

2 Heavy ballistae (2-360°)

Crew: 4 each

Cargo Capacity: 35 tons

Keel Length: 100' (not including tentacles)

Beam Width: 50'

Description: A huge ship reminiscent of the earthy cephalopod of the same name, the Octopus moves through space in a manner similar to those creatures, its bulbous end first, trailing its armed tentacles. Originally designed as a convoy protector during the Unhuman Wars, its weapon layout earned it the nickname *Tailgunner*, although the vessel actually has a very good all-round field of fire.

The Octopus is a relic of another time and place. It appeared at the height of the Unhuman Wars during an unlikely alliance between neutral humans and mind flayers. The resulting hybrid has many illithid characteristics but was piloted by human mages and used primarily to guard caravans and convoys from goblin depredations. With the destruction of the goblins, the need for large groups of ships traveling in convoys diminished, the human/illithid alliance broke up, and the ships were retired, their equipment scavenged for more maneuverable ships.

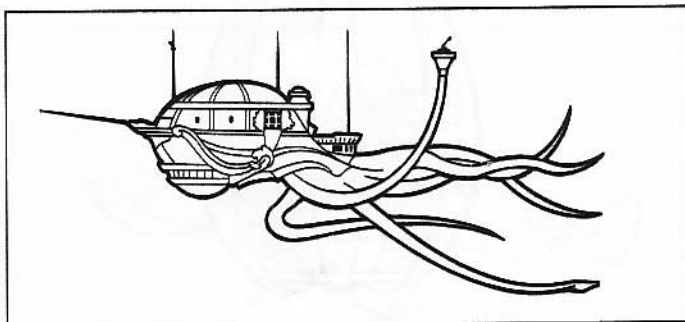

Name: Porcupine Ship (Spine-Ship)

Built By: Goblins

Used Primarily By: Goblins

Cost: 15,000 gp

Tonnage: 30 tons

Hull Points: 30

Crew: 8/30

Maneuverability Class: D

Landing—Land: No

Landing—Water: Yes (many leak!)

Armor Rating: 7

Saves As: Thin wood

Power Type: Minor helm

Ship's Rating: As per helmsman

Standard Armament:

4 Light ballistae (F, P, S, A)

Crew: 1 each

Ram-mines (360°)

Cargo Capacity: 18 tons

Keel Length: 85'

Beam Width: 60'

Description: This comical-looking ramshackle ship type was one of the first paranoid attempts at spacecraft design by the goblin race. Fairly cheap and easy to build, Porcupine Ships appeared by the thousands in the early days of goblin spacefaring.

The ballistae fire through holes set between the spines on the ship's exterior. Every third spine (in some battle-ready craft, *every* spine) is hollow and fitted with a ram-mine at its tip.

Ram-mines are almost as dangerous to the user as to the enemy. When one of these mines strikes another solid object, the collision will ignite the mine. Each mine has a cup-like metal collar which directs most of the explosion outward and away from the Porcupine. When a ram-mine explodes, it cause 3-18 points of damage to unprotected crew within 70' of the impact point (saving throw applicable) and 2-5 points of Hull Damage to the vessel hit, which must then save versus Fire or suffer an additional 1-4 points of fire damage per round.

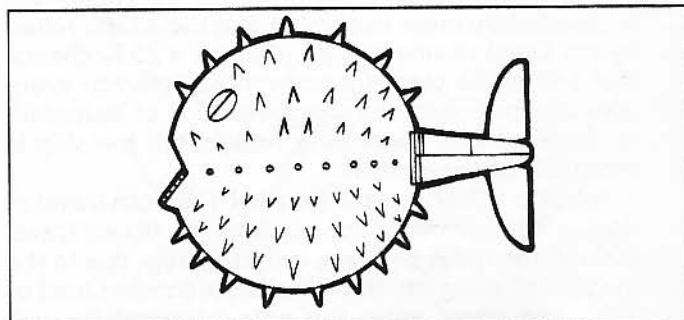

SHIPS OF THE SPELLJAMMER UNIVERSE

Name: Quad of Thay

Built By: Thay mages and priests

Used Primarily By: Thay mages and priests

Cost: 567,000 gp

Tonnage: 63 tons

Hull Points: 63

Crew: 10/63

Maneuverability Class: A

Landing—Land: Yes

Landing—Water: No

Armor Rating: 3 (-1)

Saves As: Best of Metal or Crystal

Power Type: Grand helm

Ship's Rating: As per helmsmen

Standard Armament:

4 Rams (F)

Cargo Capacity: 31½ tons

Keel Length: 50'

Beam Width: 50'

Description: The Quad of Thay is a unique ship design. Instead of having a defined helm and helmsman, the whole external ship (above the living quarters) is part of the spelljamming helm.

This *grand helm*, as it is called, allows up to four mages to sit and concentrate their magical energies toward motive force. The level of each mage is added together and divided by four, rounding up all fractions. This gives the craft's SR. In other words, if three mages of 20th, 5th, and 14th levels were concentrating their energies, the ship's SR would be $[20 + 5 + 14]$ divided by 4, or 10.

The four ram-like appendages, or claws, above the ship's upper deck are used to concentrate both the mages' power and light from surrounding fire bodies and other sources (e.g., spell effects). This magical energy and light is focused through two-inch triangular prisms inlaid on the four claws. This focusing effect causes the entire ship to be bathed in bright, colorful light for as long as at least one mage sits on the grand helm. This light causes all who attack the Quad of Thay to do so at a -4 penalty.

When in combat, the Quad of Thay generally attempts to run away, since its only attack form is a ram using the magic-focusing claws. If an opponent is rammed by these in combat and the attack rolled by the Quad results in a 20, there is a 25% chance that 1d4 of the claws (or rams) break off. For every claw that is broken, the ship loses 25% of its mobility. Once all four claws have broken off, the ship is incapable of movement.

When in wildspace, the Quad of Thay can travel at double spelljamming speeds (that is, it can travel 200 million miles per day). Unfortunately, due to the magical phasing the ship goes through, the Quad of Thay can never enter the phlogiston on its own

power, nor can it travel in the rainbow oceans. Only by being physically carried on the back of another spelljamming ship able to navigate the flow could it be transferred to another crystal sphere. Because of this limitation, the Quad of Thay is an extremely rare ship anywhere outside of Realspace.

When traveling within wildspace, a Quad is unaffected by the gravity planes and well of bodies smaller than 200 tons. Normally, a spelljamming ship must reduce its speed to tactical when it encounters any body weighing 10 tons or more. The Quad of Thay, however, has such a powerful magical disturbance around it that its gravity plane cannot extend beyond the outer boundaries of the claws, nor can other ships' gravity planes enter. Since gravity plane intersection does not occur, the Quad of Thay rarely slows to tactical speeds.

Very large ships (200 tons or more) and planetary bodies of Type A and larger do have sufficient gravity to touch the Quad of Thay and pull it out of spelljamming speeds. When this occurs, all the mages and priests aboard band together to increase the ship's SR and attempt to outrun any attacks.

The cramped living quarters of the ship are below the gravity plane; here up to 63 individuals can live and sleep. The majority of the space in a Quad of Thay is dedicated to an immense library of both common and rare magical books.

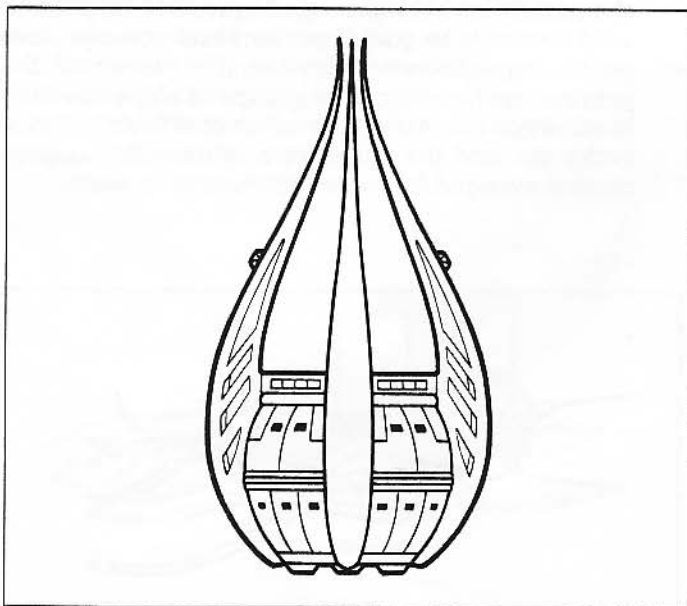

SHIPS OF THE SPELLJAMMER UNIVERSE

Name: Quentin's Libraria (Unique)

Built By: Human (Quentin Axan)
Used Primarily By: Human (Quentin Axan)
Cost: 30,000 gp
Tonnage: 30 tons
Hull Points: 30
Crew: 5/30
Maneuverability Class: E or better (varies)
Landing—Land: Yes
Landing—Water: No
Armor Rating: 7
Saves As: Thick wood
Power Type: Unique
Ship's Rating: As per helmsman (10 for Quentin)
Standard Armament:
1 Light ballista (F)
Crew: 1
Piercing ram (F)
Cargo Capacity: 15 tons
Keel Length: 120'
Beam Width: 25'

Description: The *Libraria* is a unique ship created by Quentin Axan in his pursuit of the *Spelljammer*. A modified Tradesman, it has a great stone idol with flaming eyes and mouth set on its stern castle. The whole ship is packed with books and bookshelves, which serve both as Quentin's reading library and as the ship's power source.

The idol dominating the ship's stern combines qualities of a major helm with a furnace. It works like an ordinary helm in most ways, but can be used to attain improved MC through offerings burned in its mouth, primarily paper and books.

The ship's normal MC is E. Depending upon the type of knowledge fed into the flaming mouth, the MC can be briefly improved.

- MC D:** Normal paper (lasts one round).
- MC C:** Priest or mage scroll (lasts four rounds).
- MC B:** A spell book (lasts six rounds).
- MC A:** A magical tome (lasts ten rounds).

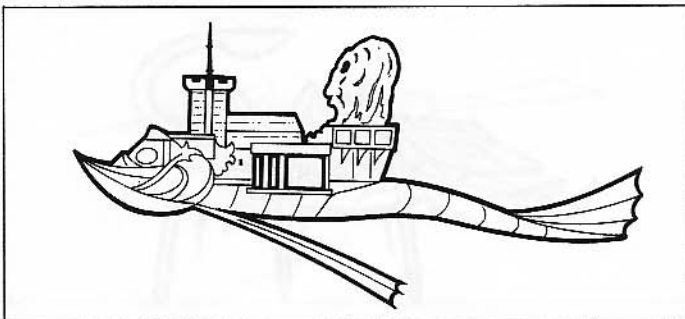

Name: Radiant Ship

Built By: Elves
Used Primarily By: Elves
Cost: 12,500 gp
Tonnage: 25 tons
Hull Points: 25
Crew: 4/25
Maneuverability Class: D
Landing—Land: Yes
Landing—Water: Yes
Armor Rating: 8
Saves As: Thin wood
Power Type: Major or minor helm
Ship's Rating: As per helmsman
Standard Armament:
3 Light catapults (1-F, 1-P, 1-S)
Crew: 1 each
3 Light ballistae (1-F, 1-P, 1-S)
Crew: 1 each
Cargo Capacity: 13 tons
Keel Length: 90'
Beam Width: 30'

Description: The Radiant Ship is a new development in the elven fleets. These small ships first appeared in Greyspace and Krynnspace, evidently as testing grounds for the prototype. The entire surface of a Radiant Ship is covered with *continual light* spells, making the ship as bright as the sun. These ships are evidently designed to provide light for the elven fleets when in deep space.

Any enemy attempting to fire at a Radiant Ship receives a -4 penalty on the "to hit" roll, unless the attacker possesses *goggles of darkness*. These goggles are mandatory equipment on every Radiant Ship, as otherwise blindness would incapacitate everyone on board. Nothing more than ordinary goggles with a *continual darkness* spell cast on each lens to counteract the effects of the ship's *continual light* radiance, these devices allow the wearer to see normally. Cost: 200 each. XP: 300 each.

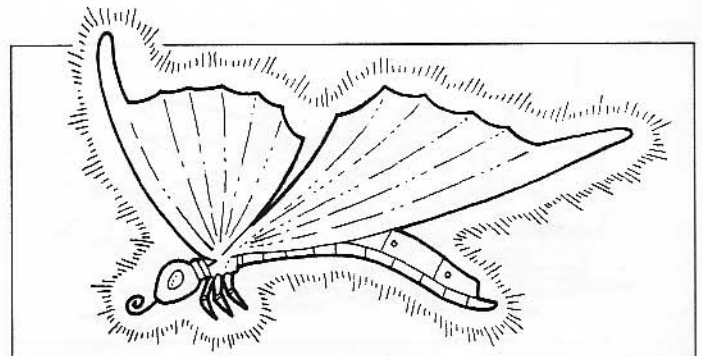

SHIPS OF THE SPELLJAMMER UNIVERSE

Name: Scalpel Ship

Built By: Xixchil
Used Primarily By: Xixchil
Cost: 20,000 gp
Tonnage: 5 tons
Hull Points: 5
Crew: 2/5
Maneuverability Class: B
Landing—Land: Yes
Landing—Water: No
Armor Rating: 6
Saves As: Ceramic
Power Type: Major or minor helm
Ship's Rating: As per helmsman
Standard Armament:
1 Light ballista (FPS)
Crew: 1 each
1 Light catapult (A)
Crew: 1 each
5 "Scalpels" (1-F, 1-S, 1-P, 1-A, 1-B)
Cargo Capacity: 2½ tons
Keel Length: 25'
Beam Width: 10'

Description: These fascinating ships resemble the elven Flitters in that they are grown, not built. Like the Flitters they have long, thin, flowing wings that aid in maneuverability, but there the similarities end. Each Scalpel Ship has several sharp protrusions or "scalpels" across its body that cause damage to any ship that attempts to ram or crash into the craft. If the Xixchil helmsman makes a successful saving throw versus petrification, the Scalpel Ship evades the ram or crash, inflicting 1d6 points of hull damage to the attacking ship as it does so. These scalpels are a purely defensive weapon and cannot be used to initiate an attack against another craft.

The Xixchil move about continuously on the ship's outer surface, cleaning, polishing, and sharpening the hull, wings, and scalpels. If this continual maintenance is not performed, the living material dulls and the ship loses its special attack.



Name: Scorpion

Built By: Orcs
Used Primarily By: Orcs
Cost: 180,000 gp
Tonnage: 60 tons
Hull Points: 60
Crew: 6/60
Maneuverability Class: C
Landing—Land: Yes
Landing—Water: No
Armor Rating: 4
Saves As: Metal
Power Type: Major helm (40%); lifejammer (60%)
Ship's Rating: As per helmsman or victim
Standard Armament:
1 Medium ballista (F)
Crew: 2
2 Heavy catapults (2-360°)
Crew: 5 each
2 Ram-claws (F)
Cargo Capacity: 12 tons
Keel Length: 75'
Beam Width: 20'

Description: These solid, deadly warships represent the pinnacle of orcish spacefaring innovation. Relatively few survived diligent hunting by the elven fleets, but most spacefarers think orcs on scattered worlds have been steadily building new Scorpions, as have other races who are able to copy them.

The ram-claws of a Scorpion are controlled by the captain and his second, using levers set around them in seats located in front of the helm. A ram-claw may strike once per round at a target in the same hex only, either to grab or hit.

Each claw should roll to hit (THAC0 15) twice per round. Two successful hits means a grab has been made; a single hit means only a hit has occurred. Each hit causes 1-2 points of hull damage to the opposing ship (2-24 points of damage to an individual). A grab causes 3 Hull Points of damage and a Hull Holed critical hit result.

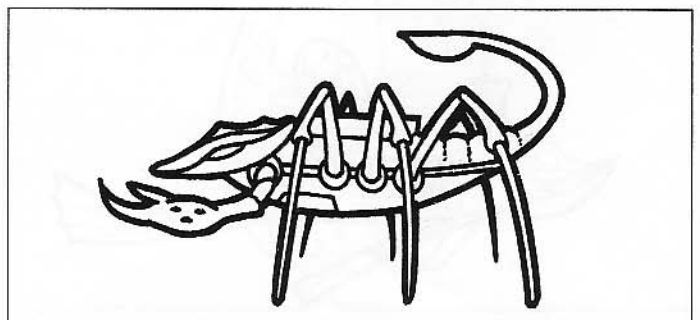

SHIPS OF THE SPELLJAMMER UNIVERSE

Name: Shrikeship

Built By: Humans

Used Primarily By: Humans, halflings, elves

Cost: 30,000 gp

Tonnage: 30 tons

Hull Points: 30

Crew: 14/30

Maneuverability Class: B

Landing—Land: Yes

Landing—Water: No

Armor Rating: 5

Saves As: Thick wood

Power Type: Major or minor helm

Ship's Rating: As per helmsman

Standard Armament:

3 Heavy ballistae (2-F, 1-A)

Crew: 4

1 Light jettison (A)

Crew: 2

Piercing ram (F)

Cargo Capacity: 20 tons

Keel Length: 100'

Beam Width: 20'

Description: This slim, light raiding ship is used as a fast merchant trader and a light warship by humans and halflings. A recent design, it is gaining popularity among private merchant traders operating in known space. Even with a minor helm, it can tow up to two cargo barges for long-range or heavy-hauling voyages, yet is large enough alone for shuttle runs within a sphere. The crew sizes given are for M-sized beings; for halflings, the minimum and maximum numbers are 18/60.

Some human and elven fleets have adopted this ship for patrols or planetary defense. Of late, the elves have been unable to grow ships fast enough to meet their increasing needs and have taken to buying "acceptable" ships like the Shrikeship to fill the demand. These "warbirds" are armor-plated, raising the AR to 4 but reducing the MC to C.

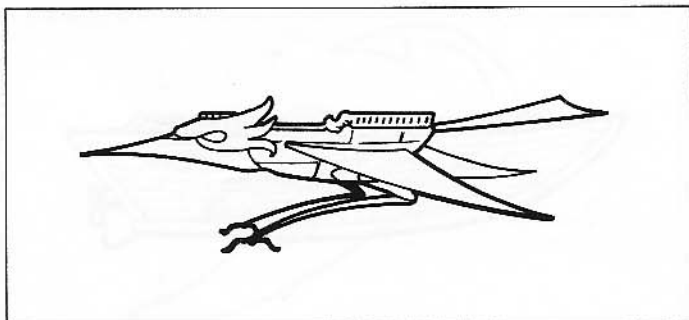

Name: Sidewheeler

Built By: Tinker gnomes

Used Primarily By: Tinker gnomes

Cost: 90,000 gp

Tonnage: 30 tons

Hull Points: 30

Crew: 20/30 (double that in gnomes)

Maneuverability Class: E

Landing—Land: 50% likely

Landing—Water: 50% likely

Armor Rating: 7

Saves As: Metal

Power Type: Non-magical or gnomish helm

Ship's Rating: 2 or as per gnomish helmsman

Standard Armament:

None

Cargo Capacity: 15 tons

Keel Length: 120'

Beam Width: 25'

Description: Each gnomish Sidewheeler is unique, a composite of scraps and leftover bits from other ships. Gnomish individualism and personality are found in each Sidewheeler, so no two look exactly alike. For that matter, the same Sidewheeler will look different each time it is encountered, as its gnomish crew modify various portions of the ship to meet their ever-changing needs. Given the unstable design of gnomish ships, there is a 50% chance that any landing will result in a crash.

Gnomish ships are the proverbial "slow boat to Krynn." If you're sending a message, package, or ill-favored relative somewhere, and it doesn't matter when (or if) they arrive, gnomish ships are the cheapest way to travel.

Gnomish Sidewelers have two power sources: giant space hamsters and gnomish helms. The giant hamsters running in circles in the sidewheels are incapable of spelljamming speeds; their tactical speed is 2. Gnomish helms are large, grandiose creations that look like a calliope mated with a Gothic cathedral. Few are reputed to work without constant tinkering and repair.

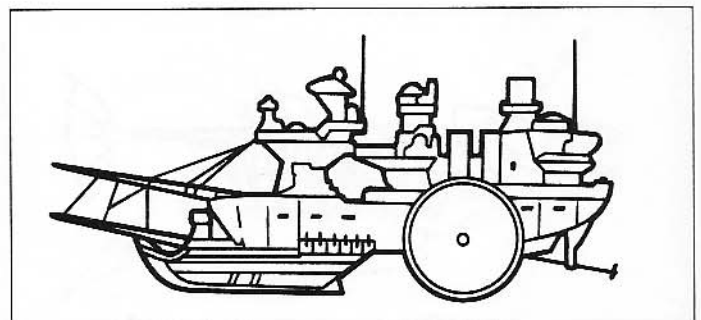

SHIPS OF THE SPELLJAMMER UNIVERSE

Name: Skeleton Ship (Boneship)

Built By: Undead humans

Used Primarily By: Undead humans

Cost: 2,000-24,000 gp

Tonnage: 1-12 tons

Hull Points: 1-12

Crew: 1/1-12

Maneuverability Class: C

Landing—Land: No

Landing—Water: No

Armor Rating: 9

Saves As: Bone

Power Type: Major or minor helm; furnace; lifejammer

Ship's Rating: 2 (Furnace) or as per helmsman or victim

Standard Armament:

2 Medium ballistae (360°)

Crew: 2 each

Cargo Capacity: Up to 1 ton

Keel Length: 200' (varies)

Beam Width: 30-41' (29 + 1d12)

Description: Some desperate or fey spacefarers have been sighted using the skeletons of gargantuan creatures as spacecraft. The statistics of such ships naturally vary from skeleton to skeleton, but a representative version appears here.

Undead pirates, particularly liches, use these vessels to plunder and raid, mounting one ballista in the jawbone of a kindori skeleton and the other aft of amidship on the spine. Ballista bolts are tied to long tether lines running the length of the vessel. The belly-ribs support the helm.

Often such ships have lifejammers into which unfortunate captives are thrust. To avoid having waiting captives shatter a ship while struggling for freedom, the undead crews often break all the joints of these unfortunates.

A typical undead crew consists of a vampire, lich, or mummy captain, served by 1-2 wights or ghosts, 2-5 ghouls or zombies, and 3-18 skeletons.

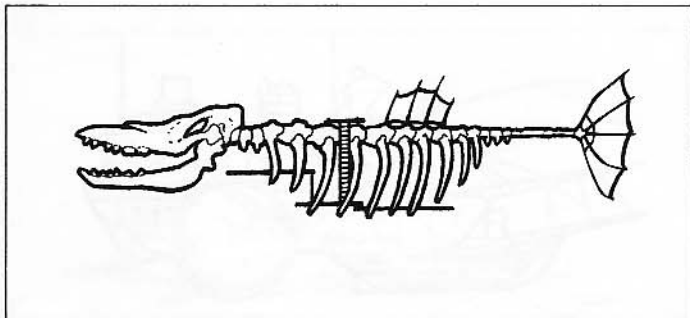

Name: Skiff

Built By: Rock hoppers

Used Primarily By: Rock hoppers

Cost: 166 to 250 gp

Tonnage: 1/3 to 1/2 ton

Hull Points: 1

Crew: 12/1

Maneuverability Class: D

Landing—Land: Yes

Landing—Water: No

Armor Rating: 9

Saves As: Thin wood

Power Type: Non-magical (pedals)

Ship's Rating: 1

Standard Armament:

Harpoons (360°)

Crew: 1 each

Cargo Capacity: 1/4 ton

Keel Length: 16'

Beam Width: 6'

Description: Rock hopper Skiffs are built for travel between asteroids. They are meant for short "hops" and carry only enough air to travel short distances.

These Skiffs carry no spelljamming helms. Instead, they are powered by propellers that operate from a turn crank attached to foot pedals. The pedalers sit on benches set up much the same way as rowing benches aboard a Viking longboat. A system of gears transmits their effort to a central drive shaft running the length of the Skiff, and hence to one or sometimes two propellers at the rear.

Rock hoppers are peaceable by nature, and their Skiffs are usually unarmed and unarmored, the only weaponry on board being hunting harpoons. If confronted by a belligerent ship, a Skiff will flee if at all possible. If forced to fight, its crew will use poisoned harpoons against such foes as cannot leave well enough alone.

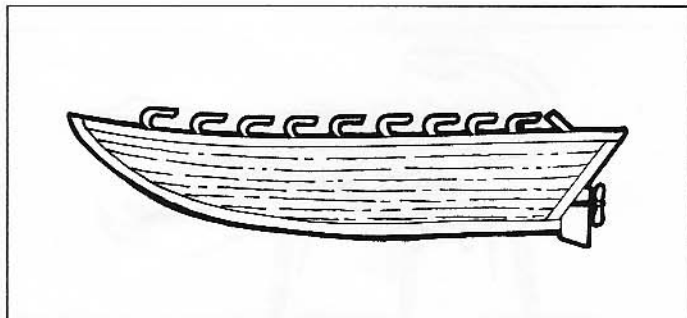

SHIPS OF THE SPELLJAMMER UNIVERSE

Name: Smalljammer

Built By: Spelljammer

Used Primarily By: Any race or none

Cost: 30,000 gp

Tonnage: 20 tons

Hull Points: 20

Crew: 1/20

Maneuverability Class: B

Landing—Land: Yes

Landing—Water: Yes

Armor Rating: 6

Saves As: Leather

Power Type: Major or minor helm

Ship's Rating: As per helmsman

Standard Armament:

None

Cargo Capacity: 15 tons

Keel Length: 65'

Beam Width: 40'

Wingspan: 140'

Description: A Smalljammer is a miniature version of the Spelljammer itself. This living vessel retains the basic manta shape with upswept tail but replaces the parent ship's citadels with enclosed crew quarters. The landing platform gives way to a small outer deck.

While this is the Smalljammer's true appearance, very few aside from its crew ever see the ship as it is. A Smalljammer can project an illusion around itself, usually of an asteroid, space creature, or other ship type (up to a maximum of 50 tons). The illusion is perfect and undetectable until the atmospheric envelope is breached. The Smalljammer does not gain the abilities of ships it imitates, keeping instead its own abilities. This may provide sharp observers with clues as to its true nature (it would appear a surprisingly mobile asteroid or Galleon).

Smalljammers are excellent exploration vessels, as they prefer the emptiness of space to the potential dangers of civilized space. Their lack of armament, small need of crew, and high MC make them ideal for lone-wolf adventurers of all types.

Name: Space Leviathan

Built By: Unknown

Used Primarily By: Unknown

Cost: 1,200,000 gp

Tonnage: 400 tons

Hull Points: 400

Crew: Unknown/400

Maneuverability Class: F

Landing—Land: No

Landing—Water: No

Armor Rating: 3

Saves As: Metal

Power Type: Unknown

Ship's Rating: Unknown

Standard Armament:

8 Heavy catapults (2-FPS, 2-FP, 2-FS, 2-A)

Crew: 5 each

3 Bombards (1-FP, 1-FS, 1-A)

Crew: 3 each

Blunt ram (F)

Cargo Capacity: 290 tons

Keel Length: 306'

Beam Width: 96'

Description: Only a handful of badly-damaged wrecks represent this truly lost type of spacecraft. The Arcane refuse to say anything about them when asked (even when offered money). These ships are large enough to serve as bases or hiding places for spaceships. Each Leviathan is made from a single, seamless piece of metal of a type unknown even to dwarves, now brittle with the fatigue of age.

These wrecks are sometimes used by raiders, who enter the interior of the hulks through large holes torn in their hulls. A single wreck can serve as a home base, emergency repair spot, hiding place, or ambush cover.

Some human sages believe such huge ships must have been crewed by giant-sized creatures—perhaps spacefaring titans of old. The elves scoff at this idea, but the truth is that nobody knows who built and sailed these ponderous wrecks in ancient times.

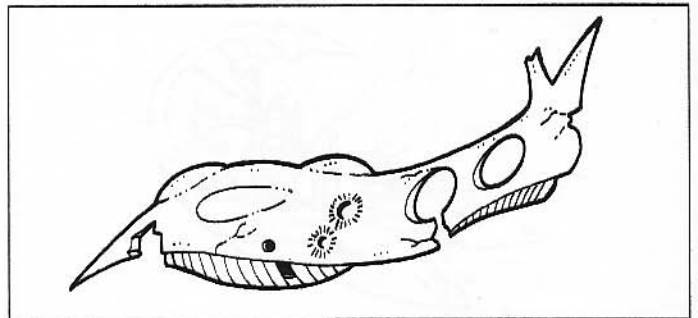
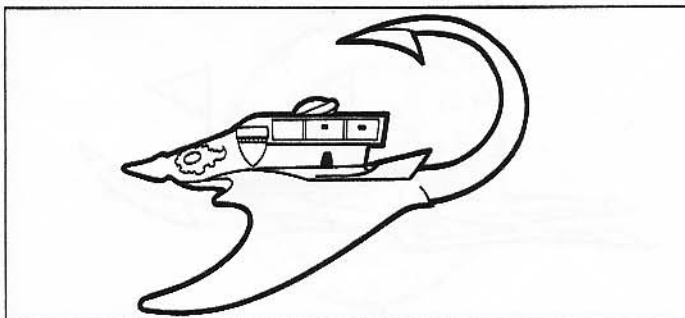

SHIPS OF THE SPELLJAMMER UNIVERSE

Name: Spelljammer (Unique)

Built By: Unknown

Used Primarily By: Unknown

Cost: 7,500,000,000 gp

Tonnage: 1,500,000 tons (estimated)

Hull Points: 1,500,000 (estimated)

Crew: none/5,240

Maneuverability Class: B

Landing—Land: No

Landing—Water: No

Armor Rating: 5

Saves As: 20th-level Mage (50% MR)

Power Type: Ultimate helm

Ship's Rating: 8

Standard Armament:

30 Heavy catapults

Crew: 5 each

15 Medium catapults

Crew: 3 each

15 Light catapults

Crew: 1 each

40 Heavy ballistae

Crew: 4 each

30 Medium ballistae

Crew: 2 each

20 Light ballistae

Crew: 1 each

Tail sting (*sphere of annihilation*)

Cargo Capacity: 750,000 tons (estimated)

Keel Length: 1,575'

Beam Width: 3,100'

Description: The Spelljammer is a unique ship, the largest in all of known space. It has attracted a large body of myth. No one knows its origin or its purpose. Few encounter it, and almost no one who has landed on it has ever escaped. Persistent rumors say that it is both a ship and a living entity. Its motive powers are a mystery because nothing that big should be able to move that fast.

For more information on the Spelljammer, see *The Legend of Spelljammer* boxed set.

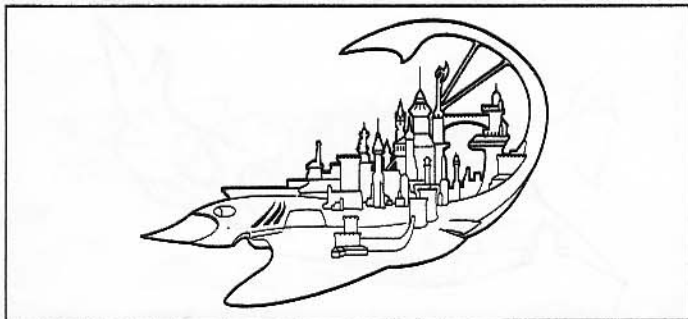

Name: Squid Ship

Built By: Humans

Used Primarily By: Humans

Cost: 45,000 gp

Tonnage: 45 tons

Hull Points: 45

Crew: 12/45

Maneuverability Class: D

Landing—Land: No

Landing—Water: Yes

Armor Rating: 5

Saves As: Thick wood

Power Type: Major or minor helm

Ship's Rating: As per helmsman

Standard Armament:

1 Heavy catapult (360°)

Crew: 5

2 Medium ballistae (1-AP, 1-AS)

Crew: 2 each

Piercing ram (F)

Cargo Capacity: 23 tons

Keel Length: 250'

Beam Width: 25'

Description: The Squid Ship is well known throughout space. Despite its cephalopod appearance, it is never used by mind flayers, having far too little enclosed space for this cautious and photophobic race. Many scholars believe that the original design for the ship was created by revolting prisoners of an illithid slave-world who fused together elements of human and mind flayer design.

Straight lines and good maneuverability, along with its devastating ram, make the Squid Ship one of the more popular vessels of its size. It is usually used for trading, exploration, and privateering. Capable of lying in wait for other ships for long periods, pirate Squid Ships carry a full crew of 45, usually fighters of level 2-5. They also carry a second mage, usually less powerful, in addition to the spelljamming mage or priest.

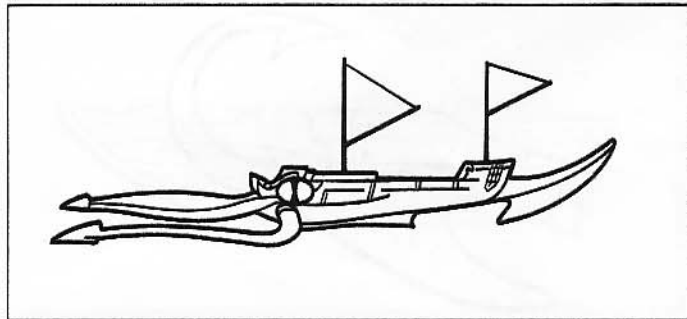

SHIPS OF THE SPELLJAMMER UNIVERSE

Name: Stoneship

Built By: Xorn

Used Primarily By: Xorn

Cost: 900,000 gp

Tonnage: 300 tons

Hull Points: 300

Crew: 54/300

Maneuverability Class: E

Landing—Land: No

Landing—Water: No

Armor Rating: 0

Saves As: Stone

Power Type: Forge (10%); series death helm (20%); elemental power (70%)

Ship's Rating: 1 (Furnace) or as per victim

Standard Armament:

8 Heavy catapults (2-FP, 2-FS, 2-AP, 2-AS)

Crew: 5 each

2 Heavy jettisons (2-A)

Crew: 4 each

3 Blunt rams (1-F, 1-P, 1-S)

Cargo Capacity: 75 tons

Keel Length: 250'

Beam Width: 200'

Description: These rare ships are simply solid or nearly solid asteroids fitted with weapons and used by spacefaring Xorn. The xorn have devised a way of using death helms in series to power these huge ships. These horrible devices drain 4d6 hit points per day from any being put into them, creating a constant need for new slaves. Most Stoneships, however, are powered by captured fire elementals, using a process known only to the xorn, who jealously guard their secret. Naturally, these apparatus do not work in the phlogiston.

These ships are sometimes captured by dwarves who convert them into Citadels. Battles between dwarves and xorn in the heart of a Stoneship are vicious, protracted affairs that may rage for years.

Name: Swan Ship

Built By: Halflings

Used Primarily By: Humans, halflings, elves, mind flayers, giff

Cost: 16,000 gp

Tonnage: 32 tons

Hull Points: 32

Crew: 12/32

Maneuverability Class: C

Landing—Land: Yes

Landing—Water: Yes

Armor Rating: 7

Saves As: Thin wood

Power Type: Major or minor helm

Ship's Rating: As per helmsman

Standard Armament:

2 Medium ballistae (2-F)

Crew: 2 each

1 Heavy catapult (A)

Crew: 5

Cargo Capacity: 26 tons

Keel Length: 100'

Beam Width: 40'

Description: Perhaps the best spaceship yet devised by the halflings, this is another of the rare designs deemed acceptable by the elves and purchased for inclusion into their navies. The crew numbers given above are for M-sized beings; halflings and other S-sized creatures have a crew minimum and maximum of 16/64.

The Swan Ship is a graceful and sturdy merchant vessel capable of landing on bodies of water, beaches, or even grasslands. Its high maneuverability and large cargo hold (twice that of a Tradesman) have led to its gaining popularity with human spacefarers, especially merchants.

Despite their light AR, some Swan Ships have been modified for wartime use by the addition of heavier weaponry. Spacefarers are warned that illithids, giff raiders, and slavers all now use Swan Ships for their own nefarious purposes.

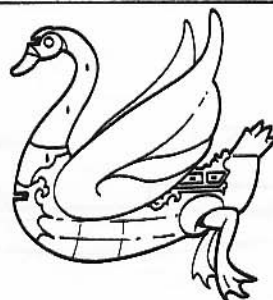
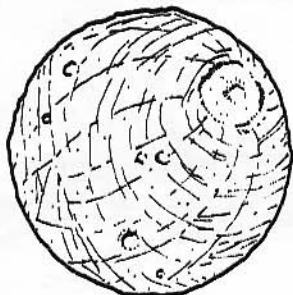

SHIPS OF THE SPELLJAMMER UNIVERSE

Name: Thorn-Ship

Built By: Thri-kreen

Used Primarily By: Thri-kreen

Cost: 12,000 gp

Tonnage: 3 tons

Hull Points: 3

Crew: 1/6

Maneuverability Class: B

Landing—Land: Yes

Landing—Water: Yes

Armor Rating: 7

Saves As: Ceramic

Power Type: Crystal throne

Ship's Rating: 3

Standard Armament:

1 Light ballista (F)

Crew: 1

1 Greek fire projector (FPS)

Crew: 3

Cargo Capacity: 2 tons

Keel Length: 50'

Beam Width: 10'

Description: The Thorn-Ship is a tiny open ship that acts as a screen vessel and fighter for a thri-kreen task force. It is highly maneuverable, making up for its lack of armor by its agility. Each Thorn-Ship carries 1-10 charges of Greek fire. Thorn-Ships are frequently used to make suicide runs against powerful enemy vessels, detonating their stored Greek fire cache on or just before impact.

Their source of power is a device the thri-kreen call the "crystal throne." This is a huge multi-faceted crystal formed roughly in the shape of a wide-armed throne. It glows with a pale inner light and operates as a normal spelljamming helm. Any thri-kreen can operate the throne; no spell casting abilities are necessary, and there are no spelljamming after-effects from its use. No race other than the thri-kreen can use a crystal throne because all others lack the correct mental architecture.

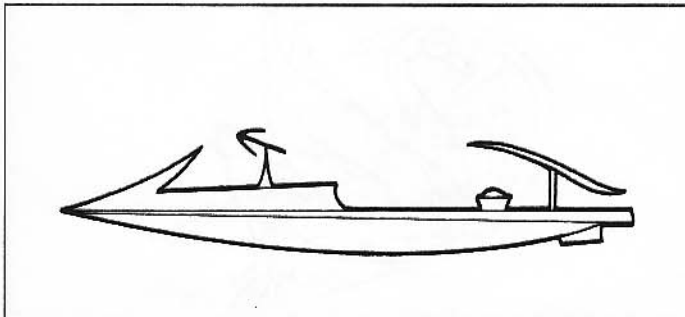

Name: Tradesman (Fish Ship)

Built By: Humans

Used Primarily By: All races

Cost: 25,000 gp

Tonnage: 25 tons

Hull Points: 25

Crew: 10/25

Maneuverability Class: D

Landing—Land: No

Landing—Water: No

Armor Rating: 5

Saves As: Thick wood

Power Type: Major or minor helm

Ship's Rating: As per helmsman

Standard Armament:

1 Light catapult (F)

Crew: 1

1 Medium ballista (APS)

Crew: 2

Cargo Capacity: 13 tons

Keel Length: 120'

Beam Width: 30'

Description: The Tradesman is the most common ship in space, varying little from Greyspace to Realmspace to Krynnspace and beyond. It is used by humans, lizard men, elves, dwarves, gnomes, mind flayers (under duress), and even races like orcs and halflings. The Tradesman is often a first ship for deep-space adventurers.

The Tradesman is a common short-range merchant ship, plying its way from planet to planet, buying and selling as it goes. It carries only light weaponry, since this reduces valuable cargo space, and will sometimes travel in convoys guarded by one or more warships.

Some Trademen are independently owned and operated, but the majority belong to merchant guilds which pool their resources, sharing both profits and losses. Each of these companies has its own flag which all of its ships fly.

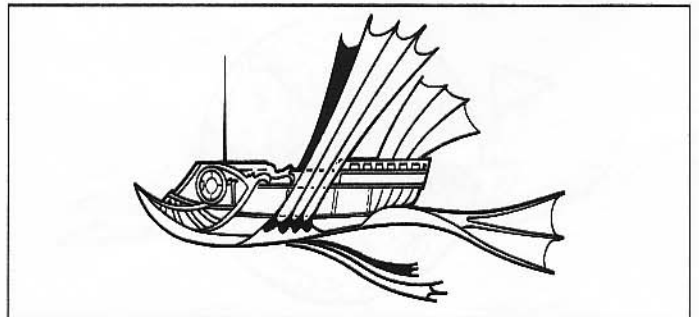

SHIPS OF THE SPELLJAMMER UNIVERSE

Name: Triop

Built By: Arcane

Used Primarily By: Gnolls, goblins, humans, mind flayers

Cost: 90,000 gp

Tonnage: 45 tons

Hull Points: 45

Crew: 10/45

Maneuverability Class: C¹

Landing—Land: Yes

Landing—Water: Yes²

Armor Rating: 1

Saves As: The worst of Bone and Stone

Power Type: Major helm (15%); minor helm (45%); lifejammer (40%)

Ship's Rating: As per helmsman or victim³

Standard Armament:

2 Light ballistae (F)

Crew: 1 each

2 Light catapults (P,S)

Crew: 1 each

2 Light jettisons (2-A)

Crew: 2 each

1 Blunt ram (F) (special damage; see below)

Cargo Capacity: 22¹/₂ tons

Keel Length: 135' (including ram)

Beam Width: 60' (at head)
10' (at tail)

¹The Triop can spin to face any direction at the cost of 2 SR points. In melee game, this movement must take place at the beginning or end of movement.

²The Triop has the unique ability to submerge itself into water and other non-acidic fluids for 2d8 rounds before sinking.

³When traveling in a straight line, the Triop can briefly increase or decrease its SR by two points, even if this exceeds its usual maximum. It can only do this once every four rounds and cannot make any turns in the same round.

Description: The Triop is a relatively new ship to the Spelljamming universe, but it has proven to be an opponent even the elven captains do not wish to re-engage. Its hard, chitinous shell is extremely difficult to penetrate. The ship has a few open decks, but the weapons that protrude from these openings limit the amount of walking space. Its thick, shelled doors can be closed and partially sealed to keep out air and water. This ability also allows the Triop to submerge in liquids for 2d8 rounds. If the vessel is still under water at the end of this time, it never surfaces again.

The Triop has the unique ability to increase or decrease its SR (even above its normal maximum) by two points for one round, once every four rounds. It accomplishes this feat by simply flexing its lateral fins with a very quick, jerky motion. (For example, it could speed up from its maximum SR of 6 to SR 8 for one round. Its SR would return to its previous speed the following round.) Any attempt to turn while making this sudden burst of speed will result in the ship spinning wildly out of control.

A Triop can also manipulate its fins to spin and face any direction, but only at the expense of two SR points. Only one of these two special maneuvers can take place in a four round time period. These fins will be damaged on any Maneuverability Loss critical hit, making it impossible for the Triop to perform these special maneuvers until they are repaired (this critical hit will not affect the ship's standard maneuverability).

The blunt ram on the Triop is a very special construction. Instead of having a ram assembly placed onto the front of the ship, the whole frontal carapace of the vessel is the ram. This gives the ship a 45' wide ram. This ram is so sturdy that it acts as a bumper, reducing by 50% any damage the Triop might otherwise suffer while inflicting a ram on another ship.

The aft sails on the Triop are used primarily as a steering mechanism. If these are destroyed, the craft loses one MC step.

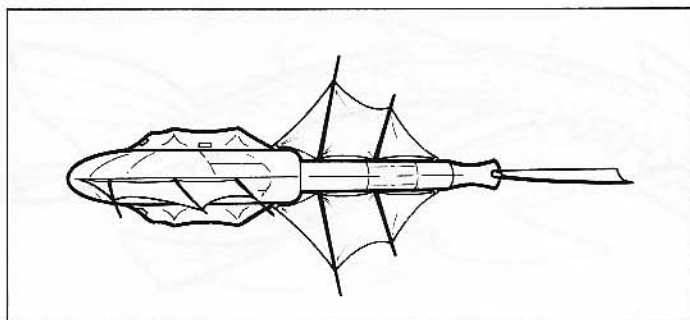

SHIPS OF THE SPELLJAMMER UNIVERSE

Name: Tsunami

Built By: Groundling humans of Wa on Toril
Used Primarily By: Groundling Humans of Wa
Cost: 600,000 gp
Tonnage: 200 tons
Hull Points: 200
Crew: 75/200
Maneuverability Class: C
Landing—Land: Yes
Landing—Water: No
Armor Rating: 2
Saves As: Metal
Power Type: Ki-helm
Ship's Rating: As per helmsmen (special)
Standard Armament:
 3 Medium jettisons (3-A)
 Crew: 3 each
 6 Bombards (1-F, 1-A, 2-P, 2-S)
 Crew: 3 each
 12 Heavy ballistae (6-P, 6-S)
 Crew: 4 each
 10 Heavy catapults (1-F, 4-P, 4-S, 1-A)
 Crew: 5 each
Cargo Capacity: 100 tons
Keel Length: 950'
Beam Width: 70'

Description: These monstrous ships are the largest craft native to Realmspace. The Tsunami looks like a giant centipede, winding its way through space. It is said that seeing the Tsunami turning in space is a most beautiful sight to behold, but seeing it turning on you is the most terrifying. Only six of these craft exist, and only two will be in space at any one time.

Each Tsunami carries a full complement (a "plague") of 36 Locust ships. There is a hatch above each leg that opens to allow the Locust ships to fly out when combat is imminent. Weaponry juts through open decks on every segment of the ship's body. *Continual light* spells cast upon poles on these decks light up the dozens of beautifully manicured gardens that help purify the ship's air envelope. This helps the ship to stay in wildspace for longer periods

with 300 or more crew members during times of war. At the tail end of the ship are two long appendages that are used to take derelict ships in tow. The ship's antennae constantly relay a picture of space to the captain, showing the location of all ships within 20 hexes.

The ki-helm used to propel the craft through space can be manned by up to eight persons. This, aside from the admiralty, is the most prestigious position on the Tsunami. Only those persons possessing the oriental ki ability can work this craft's special helm.

A minimum of 10 ki points is needed to propel the ship. For every 20 points of ki energy the helmsmen possess, the ship's SR increases by one, up to a maximum of SR 8. If this safety limit is exceeded, the ship must save vs. Magical Fire or suffer damage equal to its SR every round until the speed is reduced to SR 8 or below.

The chart below gives the ki strengths of the various oriental character classes. A character who spends one day on the ki-helm must rest for one full day before returning, or his contribution to the total ki strength of the ship is reduced by half. This penalty remains until the required resting period is met. An oriental character can man the ki-helm for a number of hours equal to the character's total ki strength or 12 hours, whichever is less. After this time, one's ki strength is exhausted.

Class	Ki Points Possessed.
Barbarian	No points available.
Bushi	1 point only.
Kensai	1 point at 1st level, 2 points at 2nd level, 2 points per level thereafter.
Monk	5 points per level.
Ninja	3 points per level.
Samurai	1 point for every two levels.
Shukenja	2 points only.
Sohei	0 points at 1st and 2nd levels, 1 point at 3rd and 4th levels, 2 points at 5th level and thereafter.
Wu Jen	1 point at 1st through 3rd levels, 2 points at 4th level and thereafter.
Yakuza	1 point per level.

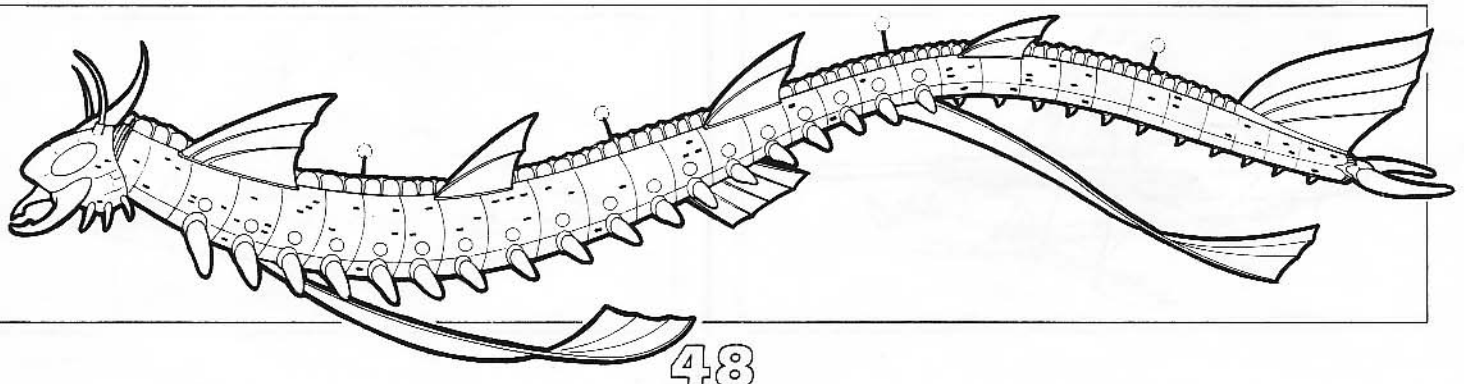

SHIPS OF THE SPELLJAMMER UNIVERSE

Name: Turtle Ship (Battle Boat)

Built By: Lizard men

Used Primarily By: Lizard men, humans, mind flayers

Cost: 120,000 gp

Tonnage: 40 tons

Hull Points: 40

Crew: 12/40

Maneuverability Class: D

Landing—Land: Yes

Landing—Water: Yes

Armor Rating: 3

Saves As: Metal

Power Type: Major helm (25%); minor helm (75%)

Ship's Rating: As per helmsman

Standard Armament:

3 Light ballistae (1-F, 1-FP, 1-FS)

Crew: 1 each

1 Medium catapult (A)

Crew: 3

Blunt ram (F)

Cargo Capacity: 28 tons

Keel Length: 95'

Beam Width: 70'

Description: A rugged lizard man trading ship, the Turtle Ship is a design popular with humans, especially pirates and free traders who run dangerous routes and fight often. Turtle Ships have a distinctive shape and appearance. A recent design, they are beginning to appear in great numbers. Mind flayers have been quick to seize Turtle Ships, turning them into slaving vessels.

The trading configuration of the Turtle Ship is the version described above. A Battle Boat, however, carries a crew of around 30, with three shamans and at least three wizards. Also in the crew are three warriors of 7th or greater level; the captain will generally be 10th to 12th level. The weaponry changes to three heavy ballistae and one heavy catapult, and the ship is stripped inside, improving its MC to C. These ships travel in groups of three.

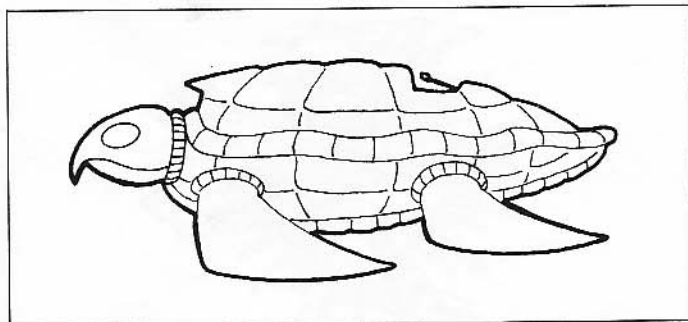

Name: Tyrant Scout Ship

Built By: Arcane

Used Primarily By: Beholders

Cost: 26,000 gp

Tonnage: 13 tons

Hull Points: 13

Crew: 8/10

Maneuverability Class: B

Landing—Land: No

Landing—Water: No

Armor Rating: 2

Saves As: Stone

Power Type: Orbus

Ship's Rating: 2

Standard Armament:

Special

Cargo Capacity: 5 tons

Keel Length: 120'

Beam Width: 90'

Description: The Tyrant Scout appears as a smaller version of the Tyrant Ship. Each beholder nation uses its own design. The ship's functions are built into its body and mentally controlled by the crew.

The Tyrant Scout Ship carries only six ordinary beholders and two orbi, who propel the ship. Tyrant fleets employ these ships for scouting and exploration when they do not want to risk a queen or large investments of effort. The Arcane produce these smaller vessels at a lower cost than Tyrant ships, so they make a sensible alternative to the larger craft.

Scout ships do not use a queen to focus their innate powers, so they do not have the offensive capabilities of Tyrant Ships. Instead, they use a device that projects small bolts of power similar to *magic missiles*. It requires a crew of two beholders, can be fired once per round, and has a maximum range of three hexes (1,500 yards). It generates up to three THACO 13 bolts per round that inflict 2-16 (2d8) hp or 1-2 Hull Points each.

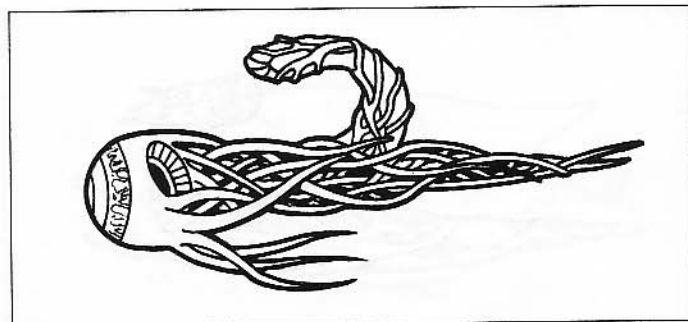

SHIPS OF THE SPELLJAMMER UNIVERSE

Name: Tyrant Ship

Built By: Arcane

Used Primarily By: Beholders

Cost: 46,000 gp

Tonnage: 23 tons

Hull Points: 23

Crew: 15/23

Maneuverability Class: C

Landing—Land: No

Landing—Water: No

Armor Rating: 0

Saves As: Stone

Power Type: Orbus

Ship's Rating: 1-6

Standard Armament:

Special

Cargo Capacity: 11 tons

Keel Length: 100' (varies)

Beam Width: 100' (varies)

Description: The Tyrant Ships are the most diverse class of ships in fantasy space. They look like walnut shells, huge eyeballs, globes carried by squidlike tentacles, even huge beholders. The above statistics apply to a typical Tyrant Ship, but there are many larger and smaller Tyrant Ships in the spaceways.

Beholder ships lack conventional weapons but make up for it with one of the most terrifying weapons in space: the combined force of a large number of beholders in a single place. A "beholder circuit" of common beholder, orbus, and queen can provide a beam of magical energy about 400 yards (1 hex in tactical combat) in length and up to 100 yards wide at the base. This beam can do a number of things, based upon the beholders' natural magical abilities: *charm person*, *charm monster*, *sleep*, *telekinesis*, *flesh to stone*, *disintegrate*, *fear*, *slow*, *cause serious wounds*, *death ray*, and *anti-magic ray*. Please see the *Lorebook of the Void* in the SPELLJAMMER™ boxed set for more information on these powerful and dangerous ships.

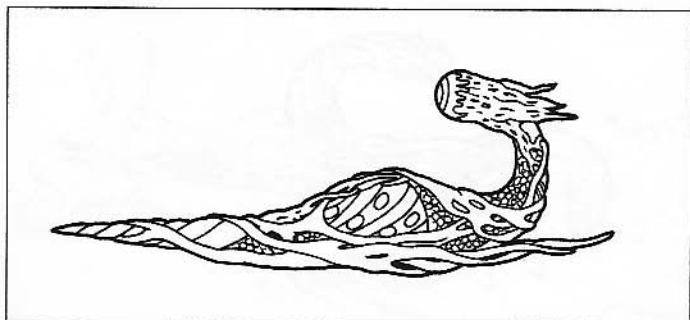

Name: Unity Ship

Built By: K'r'r'r

Used Primarily By: K'r'r'r

Cost: 90,000 gp each

Tonnage: 30 tons each

Hull Points: 30

Crew: 15/30

Maneuverability Class: C

Landing—Land: No

Landing—Water: No

Armor Rating: 8

Saves As: Metal

Power Type: K'r'r'r helm

Ship's Rating: As per helmsman

Standard Armament:

3 Medium ballistae (F)

Crew: 2 each

Piercing ram (F)

Cargo Capacity: 10 tons

Keel length: 120'

Beam Length: 25'

Description: The Unity Ships are the creation of the spiderlike K'r'r'r, a race native to deep space. Their ships are great Catamarans with three outer decks and three outriggers. Each deck carries a medium ballista at the bow. The gravity plane runs along the length of the ship, but the Catamarans provide three downward directions, allowing the K'r'r'r to operate in all three dimensions. The dimensionality of the design is unique to the K'r'r'r and appears profoundly alien to beings of any races that evolved from ground-dwelling creatures.

All Unity Ships are identical and modular, able to link together to form a single huge ship—hence the name. The resulting composite ship occupies only one hex, regardless of its eventual size. The binding maneuver is practiced by the crews until it is second nature to them: two ships only need to move into the same hex to link up. The minds of the K'r'r'r helmsmen meld during linkage, with all ships sharing the SR of the slowest.

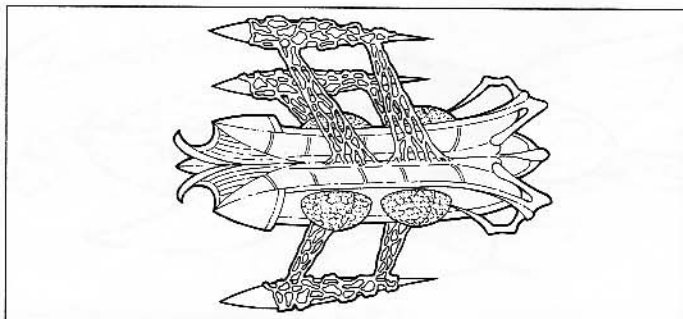

SHIPS OF THE SPELLJAMMER UNIVERSE

Name: Urchin

Built By: Neogi

Used Primarily By: Neogi

Cost: 1,500 gp

Tonnage: 3 tons

Hull Points: 3

Crew: 1/2

Maneuverability Class: C

Landing—Land: Yes

Landing—Water: Yes

Armor Rating: 9

Saves As: Thin wood

Power Type: Lifejammer

Ship's Rating: As per victim

Standard Armament:

Piercing rams (360°)

Cargo Capacity: 1 1/2 tons

Keel Length: 5' radius (21' including spikes)

Beam Width: 5' radius (21' including spikes)

Description: The Urchin is the neogi response to the elven Flitter: a light, inexpensive craft for tactical support or emergency use. An Urchin with a lifejammer moves according to the hit dice of the victim; Urchins equipped with more conventional, non-spelljamming drives have a tactical movement rate of one. Up to 16 Urchins can be carried inside a single Deathspider and strewn like mines behind it.

The Urchin looks like its ocean-dwelling namesake, with 8' spikes jutting out of a spherical body. A single neogi sits in a separate central sphere encased in the spiked hull, weighted so that the pilot remains upright regardless of how the ship moves or rolls. The spikes are sharpened so that they can be used as rams against small ships or, more importantly, as anti-personnel weapons.

The Urchin is used primarily as a close-assault vehicle. Its tactic is to land on the deck of an enemy ship and simply roll over the crew (1-4 attacks per round for 1d10 hp each). It takes 50 hp damage to destroy enough spikes to disable the craft.

Name: Uspo, Dohwar

Built By: Dohwar

Used Primarily By: Dohwar

Cost: 40,000 gp

Tonnage: 40 tons

Hull Points: 40

Crew: 20/60

Maneuverability Class: E

Landing—Land: Yes (75% chance)

Landing—Water: Yes

Armor Rating: 6

Saves As: Thick wood

Power Type: Minor helm

Ship's Rating: 2

Standard Armament:

None

Cargo Capacity: 20 tons

Keel Length: 200'

Beam Width: 90'

Description: The Uspo is shaped like a huge penguin lying on its stomach. Its massive wings are movable and are deployed perpendicular to the body during planet landings. Theoretically the wings are supposed to make the ship more maneuverable, but this does not work in practice.

Although the dohwar Uspo has no large weapons for defense or offense, there is a 50% chance that the ship has 4d12 giff mercenaries on board as security. There is also a 5% chance of 4d12 "death-squealers," or warrior dohwar, being present; if so they will fly out of the ship's beak wielding weegas (beak-blades).

Since the dohwar are merchants born and bred, each Uspo is filled with odds and ends of merchandise of all kinds, including magic items. There is an 80% chance that any specific non-magical item will be aboard and, if it is, a 100% chance its dohwar owner will be willing to sell it—for a price.

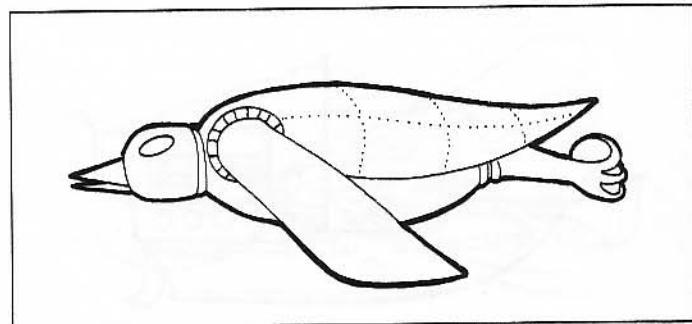
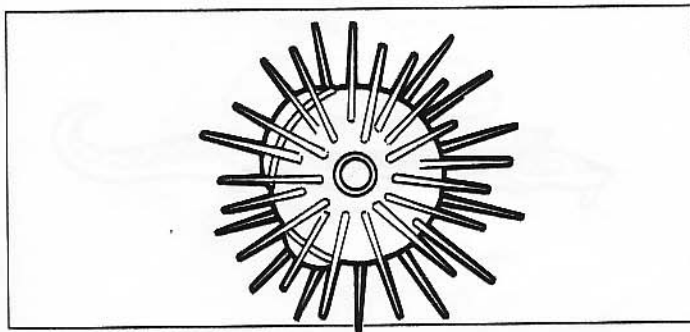

SHIPS OF THE SPELLJAMMER UNIVERSE

Name: Vagabond

Built By: Humans (Aperusa)

Used Primarily By: Humans (Aperusa)

Cost: 30,000 gp

Tonnage: 30 tons

Hull Points: 30

Crew: 10/40

Maneuverability Class: E

Landing—Land: Yes

Landing—Water: No

Armor Rating: 7

Saves As: Thick wood

Power Type: Minor helm

Ship's Rating: As per helmsman (usually 5)

Standard Armament:

None

Cargo Capacity: 15 tons

Keel Length: 90'

Beam Width: 20'

Description: A Vagabond is an assorted collection of parts from other vessels, usually attached to a wooden hull. The ships are asymmetrical nightmares, but they work. Vagabonds are painted in bright, clashing colors, with multi-colored banners hanging from masts that seem to have no apparent function. Each clan has its own ship, though some larger clans require two or more ships.

All Vagabonds are unarmed. Fond of company, the Aperusa often hail passing ships and offer to tell fortunes, swap news, and make minor repairs. This not only satisfies their love of gossip but gives them a chance to steal everything aboard the other ship that is not closely watched.

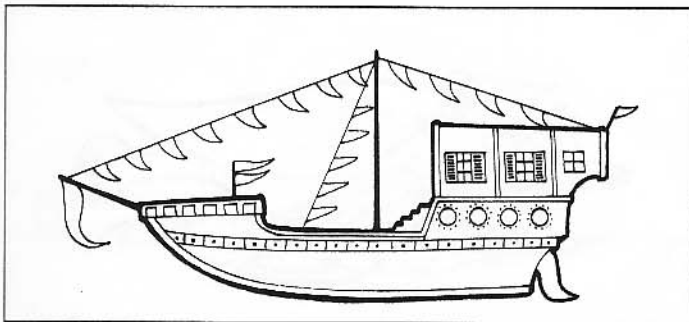

Name: Vipership (Darkviper)

Built By: Humans

Used Primarily By: Humans

Cost: 87,000 gp

Tonnage: 29 tons

Hull Points: 29

Crew: 1/29

Maneuverability Class: A

Landing—Land: Yes

Landing—Water: Yes

Armor Rating: 5

Saves As: Metal

Power Type: Major helm (75%); minor helm (15%); furnace (10%)

Ship's Rating: 2 (Furnace) or as per helmsman

Standard Armament:

3 Medium ballistae (1-F, 1-AP, 1-AS)

Crew: 2 each

1 Light catapult (F)

Crew: 1

1 Heavy jettison (A)

Crew: 4

Piercing ram (F)

Cargo Capacity: 16 tons

Keel Length: 125'

Beam Width: 15'

Description: The most successful early human ship design, Viperships were popular with navies, smugglers, pirates, and explorers. The favorite ship of Wonderseekers because it is easily handled by a single person, each Wonderseeker's "Darkviper" will reflect the personality of its eccentric occupant.

The Fireviper is a re-armed and heavily armored version of the Vipership. Its AR rises to 4, and the MC drops to B. Two ballistae are replaced by two bombardments in turrets, and the cargo bays are filled with smoke powder. The Stingviper, another variant, serves in world or sphere defense. The tail jettison is replaced with a heavy ballista, and the other ballistae are upgraded to Heavy, dropping the MC to B.

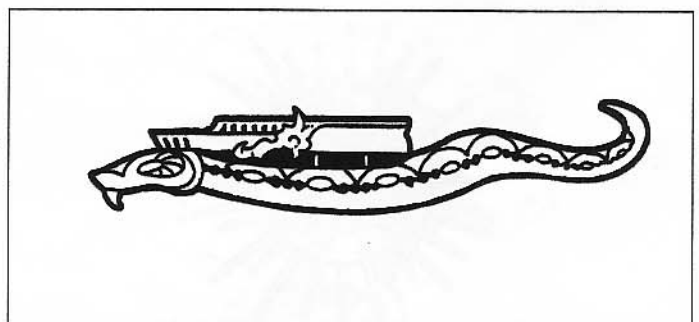

SHIPS OF THE SPELLJAMMER UNIVERSE

Name: Vodoni Diamond (Unique)

Built By: Zalani
Used Primarily By: Vodoni
Cost: 200,000 gp
Tonnage: 100 tons
Hull Points: 100
Crew: 1/100
Maneuverability Class: C
Landing—Land: No
Landing—Water: No
Armor Rating: 5
Saves As: Stone
Power Type: Major helm
Ship's Rating: As per helmsman
Standard Armament:
1 Piercing ram (top)
Cargo Capacity: 50 tons
Keel Length: Special
Beam Width: Special

Description: The Vodoni Diamond was an opaque, gemlike structure comprised of huge, hollowed crystals. The bridge (the location of the major helm) was in the uppermost crystal and the large base crystal was a storehouse for the Vodoni treasury.

The Vodoni Diamond was the imperial headquarters of the Vodoni fleet. Not designed for combat, it possesses little or no armaments. Instead, it appeared to be nothing more than a huge crystal palace resting on the planet's surface. Nevertheless, it could take off during emergency situations (e.g., when the capitol was under attack), often to the great surprise of the attackers. Surprisingly fast, well-armed, and maneuverable, the Diamond's crystal spire served as a very dangerous ram on these rare occasions.

The original Vodoni Diamond was destroyed during the Vodoni wars (see module SJA4, *Under The Dark Fist*), but there is no reason why the Zalani, given sufficient time and resources, could not build another such ship, custom-tailored to their client's request.

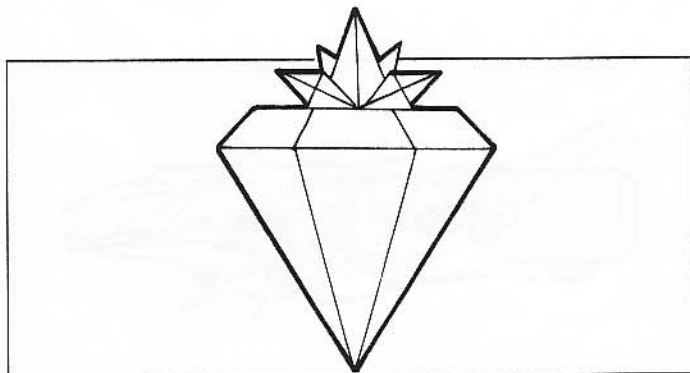

Name: Wasp

Built By: Lizard men
Used Primarily By: Lizard men, humans
Cost: 18,000 gp
Tonnage: 18 tons
Hull Points: 18
Crew: 8/18
Maneuverability Class: D
Landing—Land: Yes
Landing—Water: No
Armor Rating: 6
Saves As: Thick wood
Power Type: Major or minor helm
Ship's Rating: As per helmsman
Standard Armament:
1 Heavy ballista (FPS)
Crew: 4
Cargo Capacity: 9 tons
Keel Length: 80'
Beam Width: 20'

Description: The Wasp is a relative of the Dragonfly, built to suit the lizard man's physique. One of the few ships designed by and for lizard men, its chief use is as a pirate vessel. The central shark-filled pool even provides a place where unwanted prisoners can be forced to "walk the plank." The raised hump on the Wasp's back provides high ground for the ship's main weapon turret, usually filled by a ballista.

Many adventurers use the Wasp because it is relatively inexpensive, easily purchased or captured from the lizard men. Despite its small size, the Wasp is an attractive, even impressive, ship, highly suitable for awing untraveled locals. In some worlds, an ebon-painted Wasp has even been confused with the *ebony fly* magical item.

A third use for the Wasp, aside from pirate vessel and adventuring craft, is as a luxury craft for the wealthy. Large enough for comfort (even opulence) and small enough for easy handling, Wasps make ideal "homes away from home" for these lucky few.

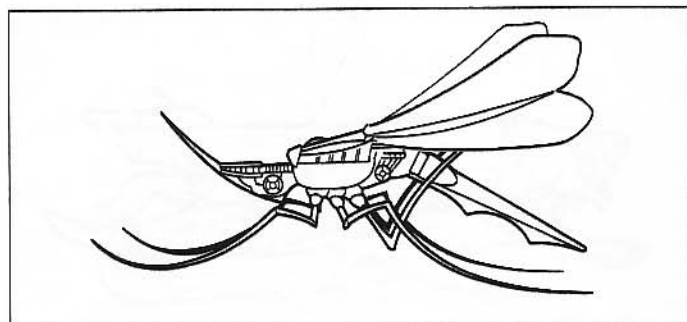

SHIPS OF THE SPELLJAMMER UNIVERSE

Name: Werewolf (Vodoni Butcher)

Built By: Zalani
Used Primarily By: Vodoni
Cost: 240,000 gp
Tonnage: 60 tons
Hull Points: 60
Crew: 24/60
Maneuverability Class: D
Landing—Land: Yes
Landing—Water: Yes
Armor Rating: 8
Saves As: Ceramic
Power Type: Major helm
Ship's Rating: As per helmsman
Standard Armament:
 2 Heavy catapults (1-FP, 1-FS)
 Crew: 5 each
 1 Heavy ballista (F)
 Crew: 4
 1 Piercing/grappling ram (F)
Cargo Capacity: 30 tons
Keel Length: 230'
Beam Width: 50'

Description: The Werewolf, or Vodoni Butcher, is a heavily armored, ramming behemoth shaped like a huge red-winged wolf. On the prow is a wolf's head with open jaws that rip, tear, and grab a hull mercilessly when ramming.

The Zalani created the Werewolf as a close-combat warship designed to ram and board an enemy craft, making the Werewolf the workhorse of the Vodoni fleet. Modified versions of the Werewolf serve both as cargo ships and slave galleys.

In combat situations, the Werewolf is purely an attack vessel, as indicated by its light AR and the forward placement of all its weapons. This accords well with Vodoni philosophy—i.e., kill them before they have a chance to kill you. The favorite tactic of Werewolf captains is to ram hapless victims and then send the lycanthropic crew over to slaughter everyone aboard the other ship, leaving no survivors.

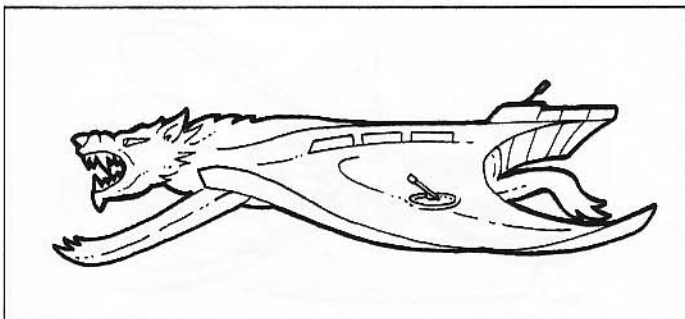

Name: Whaleship

Built By: Human
Used Primarily By: Humans, mind flayers
Cost: 90,000 gp
Tonnage: 90 tons
Hull Points: 90
Crew: 20/90
Maneuverability Class: E
Landing—Land: No
Landing—Water: Yes
Armor Rating: 4
Saves As: Thick wood
Power Type: Major helm
Ship's Rating: As per helmsman
Standard Armament:
 1 Medium jettison (A)
 Crew: 3
 Blunt ram (F)
Cargo Capacity: 50 tons
Keel Length: 250'
Beam Width: 40' (90' with tail flukes)

Description: As long as the Hammership but much taller, with a large number of enclosed decks and a heavy, armored, blunt ram in the front, the Whaleship strongly resembles the animal that gave it its name. Known for its size, not its grace, it is the perfect hauler of large bulk freight and passengers. Its great bulk gives it a low MC, yet it has proved effective as a combat vessel in the past, largely due to its devastating ram. A Whale's greatest advantage is that all of its considerable tonnage is enclosed.

Whale-class ships are used to haul both people and equipment. Cargo haulers specialize in products like cloth, grain, and other foodstuffs. Some Whaleships are modified so that one side of the hull can be detached for easy loading and unloading. Otherwise, all material is loaded through the ship's mouth. Passenger liners, including the famous Glass Whales with their *glassteel* picture windows, do a thriving business providing luxury cruises for adventurers who occasionally want to "get away from it all."

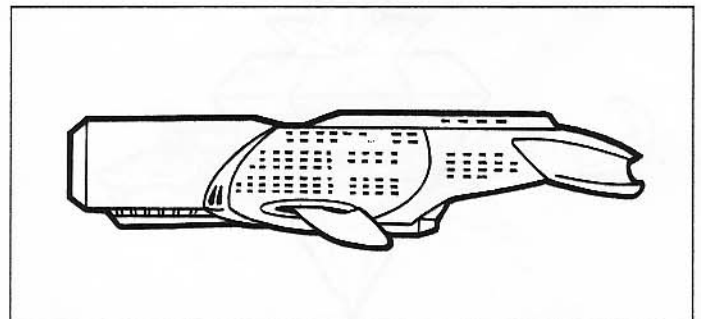

SHIPS OF THE SPELLJAMMER UNIVERSE

Name: Whelk

Built By: Illusionist gnomes
Used Primarily By: Illusionist gnomes
Cost: 120,000 gp
Tonnage: 30-40 tons
Hull Points: 30-40
Crew: 20 gnomes/30-40 gnomes
Maneuverability Class: D
Landing—Land: Yes
Landing—Water: Yes
Armor Rating: 6
Saves As: Ceramic
Power Type: Major or minor helm
Ship's Rating: As per helmsman
Standard Armament:
1 Medium catapult (360°)
Crew: 3
1 Medium jettison (A)
Crew: 3
Piercing ram (F)
Cargo Capacity: 15-20 tons
Keel Length: 120-125'
Beam Width: 25-35'

Description: The Whelk is a grown ship, much like the elven Flitters and Armadas. It appears as a spiralled sea shell dotted by sharp spikes along the mouth of the shell. The jettison is mounted in the narrow aft while the catapult is set atop the shell's thickest point. Inside, everything (doors, passages, rooms) is gnome-sized, as human visitors will find to their discomfort.

The command staff are all gnome illusionists of levels 2-12, with an additional 1d4 gnome illusionists (levels 1-6) among the crew. All of these gnomes are very good at using their magic to make the ship appear more dangerous than it actually is, with illusions of large monsters or undead on deck, flaming projectiles on the catapult, etc. A favorite trick is to halt the ship and then use *hallucinatory terrain* to cause it to merge into the background star field, rendering it virtually invisible until it moves.

Name: Wraith

Built By: Various
Used Primarily By: Revenants
Cost: Cannot be bought
Tonnage: Variable
Hull Points: Variable
Crew: Variable (minimum of 1)
Maneuverability Class: Variable
Landing—Land: Yes
Landing—Water: Yes
Armor Rating: Variable
Saves As: Variable
Power Type: Variable
Ship's Rating: Variable
Standard Armament:
Variable
Cargo Capacity: Variable
Keel Length: Variable
Beam Width: Variable

Description: Wraith ships are only one of many types of ghost ships that exists in wildspace. They are created when a ship and crew are utterly destroyed without cause. Wraiths are semi-corporeal vessels used by revenants to relentlessly hunt down their destroyers and exact revenge.

Each Wraith appears as the ship did immediately before its destruction. The number of crew, number of weapons, MC, number of Hull Points, and SR are identical to the ship's prime condition; it only *looks* ready to break apart. The ship tracks across space, following and searching for its murderers. No one sits at the helm; the ship gains its momentum from the brewing hatred of its revenant passengers.

Once the Wraith and its crew destroy their quarry, they dissolve into nothingness. If destroyed, the Wraith re-forms in 1d4 days to continue its pursuit. There is no known limit to the number of times it can come back, but six months seems to be the limit of most Wraith ship pursuits.

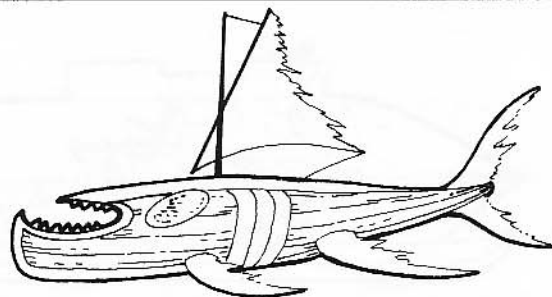
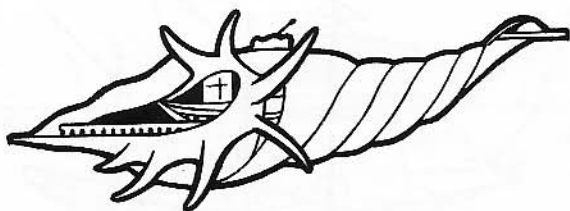

SHIPS OF THE SPELLJAMMER UNIVERSE

Name: Wreckboat

Built By: Humans

Used Primarily By: Humans

Cost: 4,000 gp

Tonnage: 4 tons

Hull Points: 4

Crew: 1/4

Maneuverability Class: A

Landing—Land: Yes

Landing—Water: Yes

Armor Rating: 6

Saves As: Thick wood

Power Type: Minor helm

Ship's Rating: As per helmsman

Standard Armament:

None (60%)

1 Medium ballista (40%) (F)

Crew: 2

Cargo Capacity: One half ton maximum

Keel Length: 30'

Beam Width: 15'

Description: Wreckboats are small lifeboats intended for use as escape vessels in case of disaster, such as a ship catching fire or breaking up.

Wreckboats retain their original use but their everyday function is as a shuttle or captain's gig. They are often towed by spacefaring ships incapable of making planet-fall. Concealed with *invisibility* to reduce theft, a towed Wreckboat is always protected with a *retain air envelope* spell to keep its air clear of disasters that might befall the mother ship. It must be regularly inspected and kept clear of flow barnacles, spaceworms, and the like.

Cargo in a Wreckboat is personal gear and small valuables only, to a maximum of a half ton if the crew is two or less. If the crew is larger than two, cargo space drops to a quarter of a ton or less. Up to 9 M-sized beings can cram into a Wreckboat in emergencies (12-13 if the ballista is jettisoned), but this severely strains its air envelope.

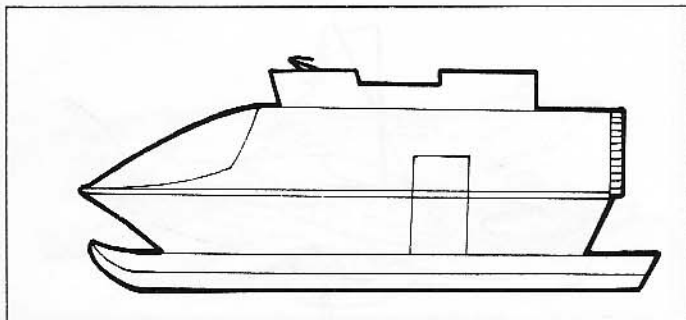

Name: Xebec

Built By: Humans

Used Primarily By: Humans

Cost: 18,000 gp

Tonnage: 12 tons

Hull Points: 12

Crew: 5/12

Maneuverability Class: F

Landing—Land: Yes

Landing—Water: Yes

Armor Rating: 9

Saves As: Leather

Power Type: Minor helm (75%); major helm (25%)

Ship's Rating: As per helmsman

Standard Armament:

2 Light jettisons (2-A)

Crew: 2 each

1 Bombard (F)

Crew: 3 each

1 Blunt ram* (F)

Cargo Capacity: 6 tons

Keel Length: 64'

Beam Width: 12'

*On an attack roll of 2 or less, the blunt ram breaks, and the Xebec receives the damage instead.

Description: The Xebec is the personal relocation vessel of the spelljamming universe. Companies across the phlogiston rent these craft by the dozens to families and individuals wishing to change their sphere, planet, or continent of residence.

When the crafts are chartered, the company supplies the renter with two spelljamming helmsmen and enough crew to man the sails. All wages and fees are paid up front, before services are rendered. Companies typically refuse to rent Xebecs to persons moving outside the crystal sphere(s) where the company does business; the risk (and cost) of bringing the craft back is just too high, unless the colonist pays *very* handsomely beforehand!

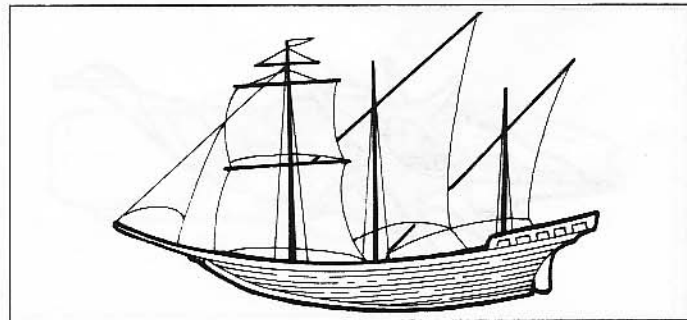

SHIPS OF THE SPELLJAMMER UNIVERSE

Name: Yacht

Built By: Arcane
Used Primarily By: Humans
Cost: 625,000 gp
Tonnage: 10 tons
Hull Points: 10
Crew: 5/10
Maneuverability Class: A
Landing—Land: No
Landing—Water: Yes
Armor Rating: 9
Saves As: Thick wood
Power Type: Major helm
Ship's Rating: As per helmsman
Standard Armament:
5 Light ballistae (360° arc)
Crew: 1 each
Cargo Capacity: 5 tons
Keel Length: 75'
Beam Width: 15'

Description: The Yacht was originally a converted ocean-sailing vessel used for pleasure cruises into near orbit. Recently, however, Yachts have been created specifically for use in Wildspace.

These luxury vessels have the finest quality furnishings, including plush carpeting. These trappings are one of the things that increase the price of the vessel three-fold. The turreted ballistae are standard accessories on the Yacht, but they can be removed to lessen the craft's price by 3,000 gp (the Arcane use this as a bargaining chip with purchasers who love to dicker). Replacing the major helm with a minor helm can lessen the price by nearly 100,000 gp as well.

The craft's most prized "extra" is its ability to re-align itself with the nearest gravity plane. If a Yacht encounters a larger ship, it smoothly rises or falls to match the level of its gravity plane with that of the other ship. Along with its maneuverability, it is this feature more than any other that makes the craft so expensive and desirable.

Name: Yawl

Built By: Gnomes
Used Primarily By: Gnomes
Cost: 21,000 gp
Tonnage: 7 (10 with golem helmsman)
Hull Points: 7
Crew: 2/2
Maneuverability Class: F
Landing—Land: Yes
Landing—Water: No
Armor Rating: 3
Saves As: Metal
Power Type: Major gnomish helm
Ship's Rating: 9 (Special)
Standard Armament:
None
Cargo Capacity: 1/2 ton (3 1/2 without golem)
Towing Capacity: 90 tons
Keel Length: 30'
Beam Width: 10'

Description: The Yawl is a strange device created by the tinker gnomes of Krynn as a vehicle for interplanetary colonization. The Yawl gains its motive and spelljamming capabilities through the use of a pedalling greater iron golem. Without this creature at the helm, and its controlling gnomish wizard, the Yawl cannot function. The power needed to pedal the vessel is equivalent to Str 22.

The Yawl can be found traversing the distances between the planets of Krynnspace, trailing a string of Yawl Wagons behind it. A Yawl can carry up to 30 fully loaded wagons, 90 empty ones, or any combination of the two that does not exceed the tonnage ceiling of its helm (100 tons). For every 10 wagons, loaded or unloaded, the Yawl loses one point of SR, to a minimum of SR 1.

The price given above is for the vehicle only. The iron golem to power it costs 30,000 gp to construct and generally sells for around 45,000 gp. The helm is an additional cost as well.

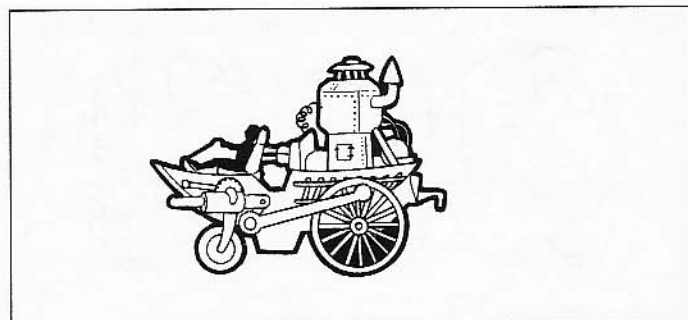
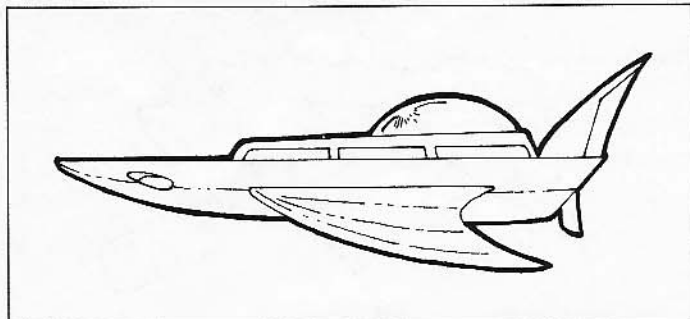

SHIPS OF THE SPELLJAMMER UNIVERSE

Name: Yawl Wagon

Built By: Gnomes

Used Primarily By: Gnomes

Cost: 1,000 gp

Tonnage: 1 ton

Hull Points: 1

Crew: 1/1 (2 gnomes. Commonly found with up to 10 inhabitants at any one time.)

Maneuverability Class: G

Landing—Land: Yes

Landing—Water: No

Armor Rating: 10

Saves As: Thick wood

Power Type: None

Ship's Rating: As per Yawl

Standard Armament:

Generally none. One light weapon of any type (360°) can easily be mounted on the craft.

Cargo Capacity: 2 tons

Keel Length: 10'

Beam Width: 20'

Description: The Yawl Wagon is a basic transport vessel that has no power of its own. The only way it can make it into space is behind the towing bar of a Yawl. These crafts are the primary colonization vessel of the Krynnish gnomes as they search for safer and more prosperous planets to live on.

This is one of the very few craft that, due to its design, has more carrying capacity than it does total tonnage. Tall, fence-like protrusions line the Wagon's exterior wall. This enables the gnomes to pile the Wagon high with cargo. When loaded with cargo, passengers, livestock, or equipment, there is no room to mount a weapon as well.

All Yawl Wagons pulled behind a Yawl share the same atmospheric envelope and gravity plane. This allows the passengers to utilize the air surrounding yawl wagons that carry nothing but cargo. Even though these crafts are usually unarmed, pirates keep their distance. After all, these are gnomes!

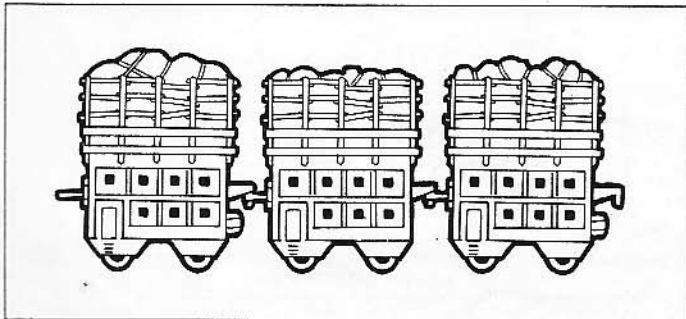

Name: Zoocraft (Ark; Gardenship)

Built By: Arcane

Used Primarily By: Any colonizing race

Cost: 400,000 gp

Tonnage: 200 tons

Hull Points: 200

Crew: 2/300

Maneuverability Class: F

Landing—Land: Yes

Landing—Water: No

Armor Rating: 2

Saves As: Stone

Power Type: Series major helm

Ship's Rating: As per helmsman average

Standard Armament:

None

Cargo Capacity: 100 tons

Keel Length: 500'

Beam Width: 300'

Description: Zoocraft are used primarily by cultures who have found a planet to colonize. The ship's deck, made from actual soil, has plant life, allowing the colonists to take cattle, pets, and wildlife with them on their journeys. The crew maximum is higher than normal because the plants recycle the air, preventing it from becoming fouled. When a Zooship finally makes planetfall, the ship often stays where it lands, never moving again.

Most Gardenships are unarmed, any weapon space being taken up by livestock and colonists. However, the crews of some Zoocraft, after living in space for generations without ever making planetfall, find that they prefer their Ark to any planet and abandon any plans to settle elsewhere. These renegade colonial ships are often armed with up to 20 heavy and medium turreted weapons.

The Zoocraft is manned by a series major helm. Two major helms are aligned so the magical energies from the two helmsman can move the extraordinarily massive ship. The SR for the mages is the average of their individual SR ratings.

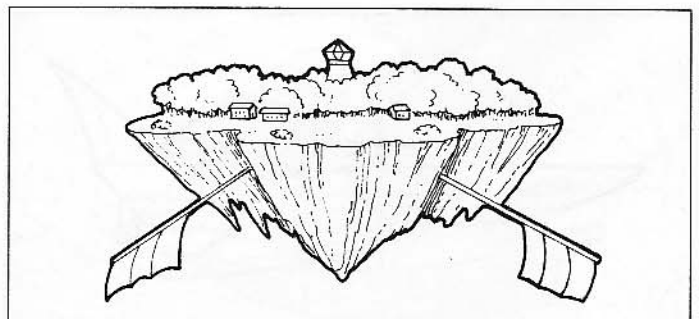

OTHER SHIP CONFIGURATIONS

Bee Class Wasp: This Wasp ship variant is for deep-space use in areas where lizard men colonists have established off-planet bases. All landing gear is removed and replaced with two additional turrets containing 2 or more medium or heavy ballistae. The Bee is capable of landing on water but is usually used only in space.

Black Widow: The Black Widow is a specialized Deathspider used by the neogi for attacks against long-time enemies.

The Black Widow triples the number of ballistae and catapults used on the standard Deathspider and may also add Greek fire projectors and bombards. In addition, the number of neogi, umber hulks, and slave-crew aboard is greatly increased. The overloading such a large crew places on the ship's air does not bother the neogi: those slaves who survive the battle will be eaten on the return trip. The Black Widow is not used for trade but only for retribution and punishment of the recalcitrant.

Bombard Ram: Captains of Great Bombards, the giff's nightmarish vessel of doom, often find themselves without enough smokepowder to fire their huge gun. To counteract this shortcoming, the bow of the Great Bombard is often armor-plated in order to give the ship a blunt ramming attack. This modification raises the AR of the bow to 5 but drops the ship's overall MC to F.

Just to make things more interesting, giffs who *do* have enough smokepowder to fire their gun often pretend they are going to ram, holding off firing until the last minute in order to keep the enemy guessing.

Broodship Lander: The neogi are noted for their fortunate absence from larger planetary bodies. However, there seems to be a neogi movement to invade and settle planets. Broodships are Mindspiders stripped of their helms, weaponry, and crew, filled with neogi eggs, and then set adrift in orbit around some suitable planet. So far none have survive the crash-landing, but the possibility that there may someday soon be groundling neogi is a very real one.

Bumble Bee: In this massive variant of the Bee Class Wasp, the legs are jettisoned altogether and the hull widened and deepened to carry an additional nine tons of cargo. The Bumble Bee's ungainly appearance marks it as a trader's vessel—and an easy target.

To dissuade would-be privateers, Wasp ships are sometimes disguised as Bumble Bees by magic, illusions, or false fronts. This technique is also used by pirates to have their targets come to them, saving considerable time and effort.

Damsselfly, Super-Heavy: In the quest for still more protection, a modified super-heavy Damsselfly has appeared. Its Armor Rating is 3, among the best for ships its size, but its lowered Maneuverability Class, E, makes it hard to manage in a fight.

Domed Deck: This enclosed version of the Mosquito or Gnat has a dome covering the upper deck. It is used by mind flayers (illithids) and other beings sensitive to light. The dome does not change the AR or saving throws of the craft but does provide some protection from attack for those on the upper deck.

Dragonfly, Heavy: Occasionally, more armor is added to the Dragonfly, improving its AR to 7 and reducing the MC to D. Most individuals seeking a better-protected ship look toward the superior Damsselfly class instead of modifying a Dragonfly, but those unable to afford new ships often have to settle for this variant instead.

Dreadnought, Heavy: These armor-plated monstrosities gain an incredible AR of 2 over their unmodified counterparts. However, this extra bulk destroys the vessel's maneuverability, sending it down to MC F. Formidable but clumsy, Heavy Dreadnoughts are commonly armed with four heavy catapults and eight heavy ballistae, double the normal complement.

*"I don't know how he did it,
but he put a load of shot right onto the quarterdeck.
Saw the mess after she struck her colors.
Saved our hides, he did."*

Saive Flayerbane, Halberd Company

OTHER SHIP CONFIGURATIONS

Dreadnought, Pirate: Pirate Dreadnoughts are lighter and more maneuverable than their illithid counterparts. This stripping effectively give the vessel an AR of 6 and an MC of D. Most pirates also increase the firepower by adding 1-6 light ballistae as well.

Firefly: This Dragonfly variant is used by humans in desperate naval actions. The Firefly is nothing more than a large bomb. The ship's light catapult is replaced with either a bombard or a Greek fire projector and stuffed with ammunition. The idea is for the helmsman to drive it into the heart of an enemy fleet and detonate it by crashing into a larger ship. The mage is (sometimes) provided with a Wreckboat or dimensional escape device.

Firewinds: This depowered Flitter has not been used by the elven fleet since the Unhuman Wars. It is a suicide craft, loaded with flammable materials and piloted to crash on enemy decks. When used against wooden ships, each Firewind has the effect of two simultaneous hits from a Greek fire projector. Firewind pilots were trained to bail out if possible. Elves even used charmed orcs and men to fly the ships near the end of the Unhuman Wars.

Flaming Dragons: The Shou Lung who take to space in Dragonships (especially those who have taken to free-booting) have a love for bombards and Greek fire projectors matched only by that of lizard men and the giff. Often all the heavy weapons on board are of this type, with much of the cargo space taken up by shot and shell. As a result of this dangerous tendency, there are significantly fewer Dragonships in space than there might be if their captains favored carrying safer weapons.

Fleet-Footed Wasp: This Wasp configuration is modified for evasion. The ship has lighter armor (AR 8) but increased maneuverability (MC C). In addition, three tons of cargo space in the tail section is occupied by a medium jettison.

Flitter, Depowered: Used as a landing craft and small fighter, these Flitters have their spelljamming helms replaced with more conventional engines. The common engines used for these craft have a tactical SR 2 and are incapable of spelljamming speeds.

Flitter, Wild: There are a number of abandoned Flitters littering the cosmos, the remains of failed missions, undelivered messages, and old battles. Such crafts are seriously overgrown, their wings curled in on themselves like sea shells. A few may have a workable engine inside when found and are MC E and AR 9 until trimmed back. Repair costs are equivalent to refitting half the hull.

Gnat: A stripped version of the Mosquito, the Gnat is one of the most maneuverable ships in space. Its Armor Rating is 8, but its MC is B. Because of its dodging ability, the Gnat is often used as a shuttle or escape boat in high-combat zones.

Hammership, Heavy: Multiple platings of bone, wood, and metal reduce the maneuverability of a Heavy Hammership to that of a groundling vessel in space (MC F) but raise the AR to 4. This modification also improves the saving throw category: Heavy Hammerships save as Metal.

Heavy Hammerships often use multiple turrets and are excellent central-command vehicles for fleets (and, alternately, for fleet-busters). They are often used to plow into and destroy smaller ships. With its poor maneuverability, however, the Heavy Hammership is not usually seen outside large fleet actions.

"I was prisoner on elf Armada, when this tiny Locust screamed into view. It crash into elf ship; blow up like little sun. Elves free me to escape as they run in their Flitters. The Armada exploding is greatest sound I ever hear."

Grravle Ironhand, Goblin Warlord

OTHER SHIP CONFIGURATIONS

Juggernaut: This gnomish warship is a variant of the Sidewheeler with 15 tons of weaponry added. The weapons will vary from ship to ship but will all be of the same type—either all ballistae, all catapults, or all light weapons. There will be far more weapons mounted than the crew can possibly man; the extras are for intimidation and to replace ones damaged in battle. Often all the weapons will be pre-loaded to cut down on reloading time during the crucial first few rounds of ship-to-ship combat. Front and rear rams are also often added.

Juggernauts sometimes (10%) have extra armor plating made from scrap iron golems, improving the AR to 6 while reducing the MC to F.

Killer Whales: These converted Whaleships have portions of the outer hull cut away to reveal batteries of ballistae or, very rarely, bombardiers. Up to six large weapons can be added, but at the great cost of reducing the AR to 6 and the MC to F. Worse of all, these alterations undermine the structural stability of the ship: on any ram against a target of 50 tons or more there is a 50% chance the Killer Whale will break up. The most successful Killer Whales are pirate ships which employ illusionist gnomes to disguise them as ordinary Whaleships.

Man-o-War, Wild: If cast adrift and left to themselves, Men-o-War, like other elven craft, will continue to grow, their crystalline wings curling in on themselves in ornate spirals. If such a ship is found, its MC will be E and its AR 9 (older growths are more brittle). These poor ratings can be corrected by repairs to the ship equal to restoring half of its Hull Points.

Narwhal: This version of the Battle Dolphin has a piercing ram mounted on the forward bridge. This process requires the removal of the windows as well.

Power Whelks: These gnomish Whelks have portions of their shells cut away for greater firing ability and maneuverability. These portions are stored for later use and separated from the hull only if a mis-

sion looks extraordinarily dangerous. Power Whelks carry an additional five light ballistae and have a MC of C. The Armor Rating, however, drops to 8.

Snowflakes: These crafts are Urchins converted into messenger vessels for the Neogi. The craft is painted white and its spikes or spines are capped by metal or ivory sheaths. While sheathed, the ship loses its attack capability—which is, however, quickly restored merely by removing the sheaths.

Speed Clipper: Not a true clipper at all, this version of the gnomish Sidewheeler is little more than a framework with a few level surfaces for the crew. Hammocks and netting hang everywhere to keep the cargo in place. This modification improves the ship's MC to C but drops its Armor Rating to 8. Speed Clippers cannot make any type of safe landing, and all crewmembers are visible and exposed to enemy fire, as there are no "below decks" to take cover in.

Stinger: A variant of the Mosquito which sacrifices the cargo hold for weaponry—a ballista, catapult, or jettison, according to the tastes of the user.

Tradesman, Light Cruiser: A Tradesman variant preferred by pirates and those plagued by pirates. This type of ship has reduced MC (E) but an AR of 4. It carries three medium ballistae or catapults.

Tyrant Rammer: A version of the standard shell with a larger piercing ram modified to fit over the front. Used primarily against non-beholder ships, the rammer makes boarding actions easy.

Tyrant Wrecks: Warring beholders gut the wrecks of defeated rival factions, enslaving any surviving orbi and leaving the derelicts to drift in space as a warning to others. As a result, there are usually a number of Tyrant Wrecks in any system where eye tyrants are common.

HAVE A PROBLEM? NEED REPAIRS??

Visit **Blackdog's Frigate Infirmary**.

We are conveniently located in the *War Captain's Guide*.

Check out our listing on page 38.

Fast work. Good prices. No questions asked.



Name: _____

Built By: _____

Used Primarily By: _____

Cost: _____ gp

Tonnage: _____ tons

Hull Points: _____

Crew: _____ / _____

Maneuverability Class: _____

Landing—Land: _____

Landing—Water: _____

Armor Rating: _____

Saves As: _____

Power Type: _____

Ship's Rating: _____

Standard Armament: _____

Crew: _____

Crew: _____

Crew: _____

Cargo Capacity: _____ tons

Keel Length: _____ feet

Beam Width: _____ feet

Description: _____

Multiple horizontal lines for writing a description.

Name: _____

Built By: _____

Used Primarily By: _____

Cost: _____ gp

Tonnage: _____ tons

Hull Points: _____

Crew: _____ / _____

Maneuverability Class: _____

Landing—Land: _____

Landing—Water: _____

Armor Rating: _____

Saves As: _____

Power Type: _____

Ship's Rating: _____

Standard Armament: _____

Crew: _____

Crew: _____

Crew: _____

Cargo Capacity: _____ tons

Keel Length: _____ feet

Beam Width: _____ feet

Description: _____

Multiple horizontal lines for writing a description.

Ships by Race

Unknown	Tonnage	Halfling	Tonnage	Lizard Man	Tonnage
Spelljammer	1,500,000	Swan Ship	32	Hammership	60
Space Leviathan	400	Shrikeship	30	Bloatfly	48
Any		Human		Turtle Ship	40
Zoocraft	200	Cuttle Command	100	Wasp	18
Battle Dolphin	70	Mammoth	90	Mind Flayer	
Tradesman	25	Whaleship	90	Cuttle Command	100
Dolphin-Shuttle	20	Octopus	70	Dreadnought	90
Smalljammer	20	Quad of Thay	63	Mammoth	90
Mosquito	6	Barge of Ptah	60	Whaleship	90
Aarakocra		Hammership	60	Octopus	70
Eagle Ship	35	Man-o-War	60	Hammership	60
Corbina	5	Batship	45	Triop	45
Beholder		Squid Ship	45	Turtle Ship	40
Tyrant Ship	23	Triop	45	Nautiloid	35
Tyrant Scout Ship	13	Turtle Ship	40	Swan Ship	32
Dohwar		Iambus	35	Cargo Barge	25
Uspo	40	Swan Ship	32	Neogi	
Drow		Quentin's Libraria	30	Deathspider	100
Jade Spider Commandship	100	Shrikeship	30	Mindspider	40
Monarch Class Armada	100	Vipership	29	Cargo Barge	25
Jade Spider	20	Lamprey Ship	26	Leech	20
Dwarf		Cargo Barge	25	Urchin	3
Citadel	300-700	Eel Ship	20	Ogre	
Stoneship	300	Wasp	18	Mammoth	90
Elf		Damselfly	10	Orc	
Armada	100	Dragonfly	10	Scorpion	60
Hammership	60	Yacht	10	Rock Hopper	
Man-o-War	60	Hummingbird	7	Skiff	1/3 - 1/2
Swan Ship	32	Wreckboat	4	Scro	
Shrikeship	30	Catamaran	1	Battlewagon	80
Radiant Ship	25	Human (Aperusa)		Mantis	60
Dragonfly	10	Vagabond	30	Spacesea Giant	
Flitter	1	Human (Groundling)		Spacesea Giant Galleon	60
Giff		Galleon	40	Thri-kreen	
Clipper	65	Cog	20	Leaf-Ship	70
Great Bombard	40	Great Galley	20	Thorn-Ship	3
Swan Ship	32	Dromond	16	Undead	
Gnoll		Xebec	12	Flying Pyramid	90
Triop	45	Caravel	10	Antlership	50-100
Gnome		Coaster	10	Skeleton Ship	1-12
Deathglory	70	Drakkar	10	Wraith	Variable
Whelk	30-40	Longship	4	Vodoni	
Sidewheeler	30	Human (Shou Lung)		Vodoni Diamond	100
Bolaship	25	Dragonship	45	Hunter-Killer	60
Yawl	7(10)	Junk	20	Werewolf	60
Yawl Wagon	1	Human (Wa)		Nightwolf	40
Goblin		Tsunami	200	Xixchil	
Triop	45	Locust	3/4	Scalpel Ship	5
Porcupine Ship	30	Insectare		Xorn	
Blade	2	Klicklikak	20	Stoneship	300
Grav		Kobold			
Argosy	150	Angelship	33		
		Arrow	2		
		K'r'r'r			
		Unity Ship	30		

CREW SUMMARY

Race	HD	AC	THACO	MR	Notes
Argos	10	0	11	16	MC7. Spell abilities ¹ .
Beholder	10	0	11	18	LBk. Spell abilities ¹ .
Bugbear	3	5	17	12	MC1. -1 light penalty.
Dracon	6	5 (3)	15	12	LBk.
Dwarf	1	4	20	13	MC2. Save as 5th level.
Elf	1	5	20	13	MC1. +1 with sword and bow. Spell ability.
Elf, Drow	2	4	20	13	MC2. 50% magic resistance. Spell ability. Light penalty.
Ghoul	2	6	19	12	MC1. Undead. Special vs. human and non-elf demihuman ² .
Giant, Space	14	0	7	16	MC7. Throw boulders for 1-3 Hull Points ² .
Giff	4	2	17	14	LBk.
Gnoll	2	5	19	12	MC1.
Gnome	1	5	20	12	MC1. Save as 5th level.
Goblin	1	6	20	12	MC1. -1 in bright light.
Hadozee	3	6	17	13	MC7. Can fly (board without grappling).
Halfling	1	7	20	12	MC1. +3 to bow/sling fire. Save as 5th level.
Hobgoblin	1	5	19	12	MC1.
Kindori	20	5	3	13	LBk. Gargantuan space whale. Blinding attack.
Kobold	1/2	7	20	12	MC1. Light penalty.
Krajen	18	3	12	13	LBk. Gargantuan space squid.
Lizard Man	2	5	19	13	MC1.
Men, Sailors	1	8	20	12	MC1.
“ Marines	2	4	20	13	MC1.
Mind Flayer	9	5	11	11	MC1. Special abilities ² .
Minotaur	6	6	15	13	MC1.
Neogi	5	3	15	12	LBk. Bite has slowing poison ² .
Ogre	4	5	17	13	MC1.
Ogre Mage	5	4	15	14	MC1. Spell abilities ² .
Orc	1	6	19	12	MC1. -1 in bright light.
Orc, Orog	3	4	17	13	MC1.
Pirate of Gith	7	0	13	16	MC7. Crew split between F, M, and F/M classes.
Rastipede	5	3	15	12	MC7. Mages (up to 4th) can spelljam at 3x level.
Scro	3	4	17	15	MC9. Related to orcs; no light penalty.
Skeleton	1	7	19	*	MC1. Undead. Slashing/piecing weapons do half.
Syllix	3	7	17	13	MC7. Use lt. crossbows, tactically astute.
Thri-kreen	6	5	15	16	MC2. Double attacks.
Troll	7	4	13	14	MC1. Regenerates.
Umber Hulk	9	2	11	13	MC1. Gaze confuses ² .
Vodoni Enforcer	7	4	13	14	SJA4. +1 weapon to hit.
(berserk)	7	8	11	*	2x damage.
Vodoni Breeder	Special	-2	17	16	SJA4. Human fighter/mage 7/12 to 9/16. Spell ability ² .
Wiggle	3	4	17	14	MC7. Fog cloud 1/day.
Xorn	8	-2	13	16	MC2. Phase through stone ² .
Zombie	2	8	19	*	MC1. Undead. Attack last in round.
Zombie, Juju	6	6	2	*	MC2. Undead. +1 weapon needed to hit.

MC = Monstrous Compendium; LBk = *Lorebook of the Void*; all HD rounded to nearest whole.

¹These creatures inflict triple HD damage in boarding actions.

²These creatures inflict double HD damage in boarding actions.



ADVANCED DUNGEONS & DRAGONS is a registered trademark owned by TSR, Inc.
 SPELLJAMMER and the TSR logo are trademarks owned by TSR, Inc.
 ©1992 TSR, Inc. All Rights Reserved

1072XXX1902

Advanced Dungeons & Dragons
2nd Edition

SPELLJAMMER™

Accessory

Combat Among the Stars



War Captain's Companion: Book 3

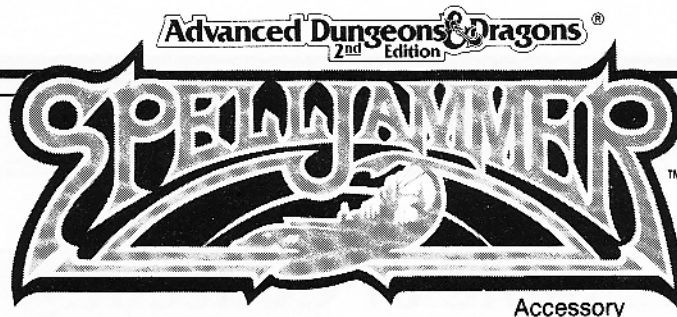

Combat Among the Stars

War Captain's Companion: Book 3

CREDITS

Design: Dale "Slade" Henson.

Editing: Jon Pickens

Cover Painting: Erik Olson

Cartography & Diagrams: Diesel & Dennis Kauth

Typography: Tracey Zamagne

Thanks To: Ann Brown, Timothy B. Brown, David "Zeb" Cook, Newton Ewell, Andria Hayday, Colin McComb, Bruce Nesmith, Jon Pickens, Steven Schend, James M. Ward, Dori Watry, Steve "Old Man" Winter.

Very Special Thanks: Jeff Grubb, James M. Ward.

Play Testers: Sam Adams, The Association of Roleplaying Gamers of Houston, Brian Baker, Rich Baker, Wolfgang Bauer, Bill Beggs, Tom Beggs, Dave Boddorf, Darin Brown, Timothy B. Brown, Paul Conaway, Troy Daniels, Charles Frederick, Alan Grimes, Scott Hala, Jerry Harper, Stirling Hershey, John Hinkle, Jeff Hornberger, Joseph C. Justice, Brian Kraak, Kelli McMillan, Mitchell McPherson, Mark Middleton, Brad Mongar, Brendan O'Brien, Sam Orlando, Mark R. Paxton, Robert Quillen II, John D. Rateliff, Jay Reese, Thomas M. Reid, Kip Romaine, Cameron Shellum, Lloyd Shellum, David Stowe, Michael Walter Sr., Mike Walter Jr., Heath Waugh, Mark Welch, Skip Williams, Todd Wilson, Tommy Wilson, Tracey Wilson, Dan Wood, Darrel Wood, Kim Wood, Kathryn Woods, Paul Yaeger.

ADVANCED DUNGEONS & DRAGONS, AD&D, DRAGONLANCE, FORGOTTEN REALMS, and WORLD OF GREYHAWK are registered trademarks owned by TSR, Inc.

SPELLJAMMER, RAVENLOFT, and the TSR logo are trademarks owned by TSR, Inc.

Copyright ©1992 TSR, Inc. All Right Reserved.

Random House and its affiliate companies have worldwide distribution rights in the book trade for English language products.

Distributed to the book and hobby trade in the United Kingdom by TSR Ltd.

This SPELLJAMMER game accessory is protected under the copyright laws of the United States of America.

Any reproduction or unauthorized use of the material or art work printed herein is prohibited without the express written permission of TSR, Inc.

Printed in the U.S.A.

TSR, Inc.
P.O. Box 756
Lake Geneva
WI 53147
U.S.A.



TSR Ltd.
120 Church End
Cherry Hinton
Cambridge, CB1 3LB
United Kingdom

ISBN 1-56076-343-4

Table of Contents

■ Introduction	3	■ Chapter 7: Ship and Crew Damage	16
■ Chapter 1: Setting Up the Game	4	Crew Damage	16
The Ships	4	Saving Throws	16
The Game Markers	4	Table 7-1: Ship Saving Throws	16
The Ship Record Sheet	4	Critical Hits	16
■ Chapter 2: The Combat Round	5	Table 7-2: Critical Hit Causes	16
The Round Sequence	5	Table 7-3: Critical Hit Effects	17
The Announcement Phase	5	Definition of Critical Hit Effects	17
Initiative	5	Fire	17
Table 2-1: Modifiers to Initiative	5	Breaking Up	17
■ Chapter 3: Ship Movement	6	■ Chapter 8: Magic and Spell Use	18
Moving A Ship	6	■ Chapter 9: Optional Rules	19
Changing Speed	6	Random Game Set-Up	19
Reverse Movement	6	Debris	19
Facing (Changing Direction)	6	The Comet Pieces	19
Table 3-1: Maneuverability	6	Weapon Specialists	19
Stacking	6	Repairs	19
Loss of Maneuverability	6	Towing	19
■ Chapter 4: Ramming	8	Crash Ships	19
Ramming Restrictions	8	Unusual Weapons and Equipment	19
Ramming Damage	8	Non-Standard Ammunition	20
Head-on Ramming	8	■ Chapter 10: Advanced Optional Rules	21
Ramming and Ship Facing	9	Heroes	21
Movement After Ramming	9	Small Ships	21
Ramming Creatures	9	Pitch	21
Shearing Attacks	9	Random Hit Locations	22
Crashing	9	Table 10-1: Ship Locations	22
■ Chapter 5: Missile Fire	11	Convention Games	22
Large Missile Weapons	11	■ Chapter 11: Rules for 3-D Play	23
Fire Arcs	11	Three-Dimensional Movement	23
Table 5-1: Fire Arcs	11	Altitude	23
Weapon Crews	11	Maneuverability Class in 3-D	23
How to Fire	12	Altitude Facing	23
Special Rules for Firing	12	Changing Altitude	23
Small Missile Fire	13	Table 11-1: Altitude Movement	24
Large Missile Movement	13	Three-Dimensional Combat	24
■ Chapter 6: Boarding	14	Fields of Fire	24
Grappling	14	Table 11-2: 3-D Fire Arcs	24
Table 6-1: Grappling Modifiers	14	Table 11-3: Three-Dimensional Distances	25
Degrappling	14	Firing Distances in 3-D	26
Ship Movement while Grappled	14	■ Chapter 12: Definitions	27
Grappling Devices	14	■ Appendices	28
Melee	14	■ Spellcaster Record Sheet	32
Special Monsters	15		
Multi-Ship Melees	15		
Morale	15		
Table 6-2: Morale Checklist	15		
Table 6-3: Morale Modifiers	15		
Poor Morale	15		

INTRODUCTION

Combat in wildspace is much like combat between ships at sea. When an enemy ship is sighted, the stronger, more aggressive force seeks combat, loot, and glory, while the weaker side flees or maneuvers grimly for some tactical advantage.

The action usually begins when an approaching enemy drops out of spelljamming speed. At long range, the lightest large weapons volley, to be joined by ever-heavier pieces as the ships draw near. Vessels armed with rams maneuver to strike the enemy broadside, while those armed with greek fire projectors close to bathe their foes in lethal flame. Formations grow ragged as ships maneuver to dodge the increasing number of large missiles and other debris that begin to fill the field. Huge motherships launch clouds of swarming flitters to harry the enemy with missiles and spells.

Just before contact, short-ranged attacks by individual missile weapons and spellcasters sweep the enemy decks, killing enemy crew and softening up the survivors for the boarding action that is sure to follow. If the attacker has a ram, this phase of the battle can be decisive, ending as the heavy ram strikes home with keel-shattering force. If not, this part of the action may go on for some time, as the ships make firing pass after firing pass against each other.

Then, with wild cries, it's grapple and "boarders away!" as howling attackers clash with desperate defenders in a decisive fight for control of the beleaguered vessel. Flitters land directly on the enemy to add their weight to the assault. If the attackers win, the vessel becomes a spoil of war, to be manned by a prize crew and withdrawn for refitting and repair. If the defenders win, they may well launch a counterattack, boarding the attacker's vessel in turn!

This scene is repeated many times with countless variations as the fleets clash in frenzied combat or exploration squadrons whirl about in deadly skirmishes in the lonely reaches between the worlds.

The booklet you now hold, *Combat Among the Stars*, gives you, the players and DM, a way to fight multi-ship actions in wildspace and the phlogiston. The basic combat game has been simplified from previous works in order to speed play, allowing battles with more ships per side, each possibly commanded by an adventurer. No longer are player characters limited to a single ship: everyone can be a captain!

Before play, the vital statistics of each ship should be recorded (see the all-new Ship Record Sheet in the *War Captain's Guide*, page 93). Combat damage, changes to maneuverability, and crew casualties are marked off as they occur. Standard ship statistics can be found in the *Ship Recognition Manual*. Special modifications to the basic ship designs are covered in the *War Captain's Guide*.

A typical game will have opposing ships meeting each other at a given speed, distance, and angle of approach. The ship combat is played in a series of game turns, or rounds. Combat lasts until one side is destroyed, taken, or fled.

The basic combat game allows the players to fight enemy ships in two dimensions. Optional rules allow movement and combat in three dimensions.

How to Use This Book

Learn the basic combat game before trying immediately to play the 3-D game version. A training game with two opposing ships of about the same weight and maneuverability class armed with rams makes a good start. Ignore artillery, boarding, and missile fire at first if you are unfamiliar with this type of game. Add these rules gradually, and then add more optional rules as you like. For larger games, a neutral referee is recommended to balance the opening situation (the *scenario*), to make any temporary rulings needed, and to keep play moving.

If you need to review the basic concepts of wildspace and the phlogiston, see Chapter 1 in the *War Captain's Guide*, the 96-page booklet.

A general assumption has been made that one player will run one ship. However, experienced players (or DMs) may often find themselves running more than one ship. The game will run much more quickly if multiple ships run by one player have identical statistics.

If a large multi-player game is attempted with inexperienced players, standardizing the opposing sides will be helpful. Ram ships are the simplest to run, then ships that attack with large missile weapons. Ships relying on boarding parties are the next most complicated, while the most complex ships in the game are those that carry large numbers of small craft or wizards and clerics with spell ability. Using spells will have drastic effects on play, and will greatly reduce the importance of small missile weapons and boarding in the game.

How to Read Dice

This game requires a number of polyhedral dice: 20-sided, 12-sided, 10-sided, 8-sided, 6-sided, and 4-sided. Dice notation is given in the form of the number of dice rolled, followed by the type. If a "+" and a number follow, the number is added to the total rolled. Thus, the notation "2d20" means to roll two 20-sided dice, while "1d4+1" means roll one 4-sided die and add one to the result. A 1d100 result is achieved by rolling 1d10 for the "tens" and 1d10 for the "ones"; a roll of "00" is read as "100". A "d3" is generated by rolling 1d6, dividing the result by 2, and rounding up. Numbers smaller than the die can be rolled by assigning die rolls (e.g., for 1d2, roll 1d6: 1,2,3 = 1 and 4,5,6 = 2).

Special Game Conditions

Special game conditions are rules that apply only during one scenario. These are set up before play by mutual agreement or by a neutral referee or game host.

Typical special game conditions might define starting speeds and facings, different helmsman levels, previous ship damage, ammunition limits, special terrain features such as asteroids, reinforcements (number, location, and arrival times), special game victory conditions, optional rules used, and any other temporary rules the players desire.

Players should avoid too many options when first learning the game. After the rules are familiar, the special game conditions will always keep the game interesting.

CHAPTER 1: SETTING UP THE GAME

"The way you begin is to begin."

Sarek the Sage

A game can be set up by following these steps.

1. Decide the number and types of ships to be used.
2. Decide the game's victory conditions. Many games end when one side is destroyed or driven from the board.
3. Record information for each ship on copies of the Ship Record Sheet. Unless otherwise specified, ships should be given *minor helms*.
4. Assign a crew to each ship. The typical helmsman will be 9th level.
5. Note the crew levels at which ship performance will suffer, if that option is used.
6. Both sides roll a die: high roll places his ships first; low roll places his ships 10 + d6 hexes away, facing as desired.
7. Both sides record their starting speeds.
8. Both sides roll initiative for the first round.

Any of the above information can be fixed before play by mutual agreement or by a neutral game judge. For example, a slow large ship with long-ranged weapons might be dodging through an asteroid field toward a safe haven, dogged by a swarm of lighter ships with powerful short-ranged weapons. Starting distance, helms available, helmsman level, crew details, starting facings and speed can all vary as desired.

The Ships

The ships used as playing pieces are printed on cards included in this set. Before play, they should be assembled according to the instructions given in the *Ship Recognition Manual*, page 63.

Game Markers

A number of game markers have been included on a card in this set. This section of the rules defines what they are and how to use them.

To prepare the markers for play, cut them out with a pair of sharp scissors. If desired, the markers can be mounted on heavier cardstock before being cut apart. Before play, sort the markers by type. Using small plastic bags to keep the markers separated between games will speed your set-up.

The Ship Record Sheet

The Ship Record Sheet and how to fill it out are given in the *War Captain's Guide*, pages 91-93. Ship details can be found in the *Ship Recognition Manual*. For the crew, either use the suggested guidelines from the Ship Record Sheet and Crew Summary (on the back cover of the *Manual*), or assign values to create a balanced game.

The Crew Summary lists each type's effective armor class, THACO, hit dice, and morale. Chapter 8, Magic, lists most of the common damaging spells used in combat and describes the effects of each.

4

Numbered Marker: These are altitude markers, used only in advanced play with three-dimensional movement.



Fire Marker: These are used to mark ships that are currently on fire.



Flaming Debris: These are used to mark where burning ships have broken up.



Comet: These are optional markers used to represent celestial bodies.



Helmseeker Marker: This marker is placed on top of a Missile marker if that missile is an optional *helmseeker* type. Note that all *helmseekers* have a range of six.



Dual Ballista Marker: This marker is placed on top of a ballista missile marker if the missile was fired from a dual ballista. The range is the same as the ballista marker.



Wreckboat Marker: These are optional "lifeboat" markers for games in which one or more ships carry these craft.



Debris Marker: These are used to mark the location of debris fields if that optional rule is used.

Missile Marker: These represent various types of large missiles that remain on the board after they have been fired. Each Missile marker has the following elements.

Symbol: Identifies the type of missile: arrow = ballista, rock = catapult.

Class ID: Identifies how heavy the missile is: **H** = Heavy, **M** = Medium, **L** = Light, **B** = Bombard, **GB** = Great Bombard.

Marker ID: This number identifies the marker; each type of missile is numbered from one upward.

Range: This is the number of hexes the missile moves each round.

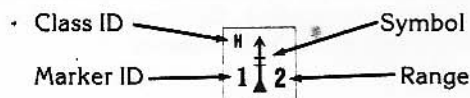

CHAPTER 2: THE COMBAT ROUND

1. Announcement Phase.

- Optional step used with the "Heroic Action" optional rule.

2. Initiative Determination (1d10).

- Initiative winner chooses to move first or last.

3. Ship Movement, Ramming, Missile Fire.

- Ships move in order; ramming, magic, and missile fire are resolved as they happen, in initiative order.

4. Large Missile Movement (and Hit Resolution).

- Move any large missile markers currently on the map in any convenient order. Resolve possible hits as they occur.

5. Boarding Combat.

- Boarding battles are fought in initiative order. (*Boarding battles precede grappling attempts.*)

6. End of Round Phase (Endphase).

- Adjust ship status for fires, crew morale, etc. Turn face-down missile markers face-up.

"The best way to stay alive in wildspace is to know how to maneuver out of the way..."

Captain Icarus, Elven Fleet

Combat is fought in a series of combat rounds, or game turns, until one side has won. A combat round is made up of a series of steps called the *round sequence*.

The Round Sequence

The round sequence for battling in space is similar to that for fighting on land. Initiative order determines when the players attack and roll damage. To reduce confusion, follow the round sequence carefully for each and every combat round. Each step is explained in greater detail later.

The Announcement Phase

This phase is used with the Heroic Action optional rule, and is ignored if that rule is not used. It allows players to commit PCs to certain actions before initiative is rolled.

Initiative

"First strike is only way to win in space. I lose whole fleet when crew failed to attack first..."

Grravle Ironhand, Former Goblin Warlord

The initiative roll determines the order of movement and combat in the round. The ship that wins the initiative roll (that is, rolls lowest) has a distinct advantage. For example, it can position its ships to deftly rake its opponents with fire, to mercilessly ram the exposed flank of an enemy formation, or to simply get a lead on pursuing ships.

Procedure: To determine the initiative order for the round, each ship rolls 1d10. The lowest roll (with modifiers) wins initiative. Tied scores are rerolled. *The player rolling lowest can choose to move first or last in the movement sequence.*

Reroll ties (without modifiers) until a round order is established. Only the single ship rolling highest can choose to move last.

Certain conditions will modify the initiative die roll (see Table 2-1). Note that negative modifiers are beneficial, and positive modifiers are penalties. The lower an initiative roll is, the better.

Thus, if Ship A rolls an adjusted 3 for initiative, and Ship B rolls an adjusted 7, Side A can decide to move first or last. A ship choosing to move last still has the initiative when resolving fire or spellcasting.

Table 2-1: Modifiers to Initiative

Specific Situation	Modifier
Ship MC of A ¹	-3
Ship MC of B ¹	-2
Ship MC of C ¹	-1
Ship MC of D ¹	+0
Ship MC of E ¹	+1
Ship MC of F ¹	+2
Ship MC of G ¹	+3
Crew, Green ²	+1
Crew, Average ²	+0
Crew, Trained ²	-1
Crew, Crack ²	-2
Air Quality, Fresh ³	+0
Air Quality, Foul ³	+2
Air Quality, Poisonous ³	+6
Hasted ⁴	-2
Slowed ⁴	+2

¹Bonus does not apply if ship is grappled.

²See crew quality in Book 1, page 92.

³Air quality can be ignored unless a fire has been started, air-fouling magic is used, or one or more ships have bad air by special game condition.

⁴Special spell modifier that affects creatures only.

How Ships Move

Ships are powered by spelljamming *helms*, which turn the helmsman's magical energy into motive force. Spelljamming ships move either at a constant long-range *interplanetary speed* or at a short-range *tactical speed* that varies for each ship according to its ship's rating (SR).

Interplanetary Speed: Interplanetary travel speed for all ships is a constant 100 million miles per standard day. Most ship-to-ship encounters occur when passing ships drop each other to *tactical speed*. A ship drops to tactical speed when it comes within 24 hexes of a mass of 10 tons or greater (objects with lesser mass have no effect).

Tactical Speed: Tactical speed is a slower speed used close to planets. At tactical speed, a ship can move 500 yards (one hex) for every point of its Ship's Rating (SR). Combat often ends when one side moves 24 hexes away from the other, then using interplanetary speed escape.

CHAPTER 3: SHIP MOVEMENT

"Get us out of here!"

Davidia Wrenthead, *Gnomish Mechanic*

Ships move in the order determined in the Initiative phase. How far a ship can move and how often it can turn is determined by its *ship's rating* (SR), *maneuverability class* (MC), and by its power source (most often a spelljamming *helm*). These details for each ship type can be found in the *Ship Recognition Manual*.

Moving A Ship

A ship moves from hex to hex on the starfield mapsheets. It moves one hex for every point of its ship rating (SR). A ship always begins and ends its move facing a hex side (not an angle).

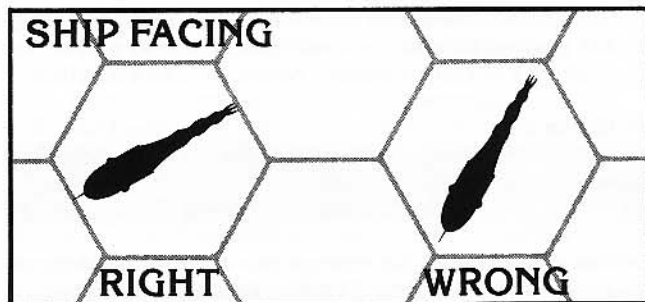

Ships must point toward a hex side.

Changing Speed

The ship can move less than its maximum if desired. It can change speed according to its *maneuverability class* (see the Table 3-1: Maneuverability). Players should keep track of their current SR each round on their Ship Record Sheets.

Reverse Movement

A ship can move straight backwards, subject to the maximum limit on the Maneuverability table. If a ship can change its SR by 2, it can travel backwards from a dead stop at the rate of 2 hexes per round.

Note: A ship with a *major helm* can choose its speed each round, changing by up to its maximum SR. Further, it can freely stop or move directly backwards (within its speed change allowed).

Example: A Galleon, with a minor helm and MC D, is traveling at 5 hexes per round (SR 5). The first round, it can reduce its SR by two (to 3); the next, reduce SR another two (to 1); the third, another two (to -1, a one-hex reverse); and fourth, an additional one (to -2), its maximum reverse speed.

Facing (Changing Direction)

The direction (hex side) toward which a ship's bow points is called its *facing*. Each time a ship changes facing, it uses SR as it turns to a new hex side (except as noted). How often a ship can turn, and how many hex sides it can turn at one time, are given on Table 3-1: Maneuverability. Players should record the appropriate information on their Ship Record Sheets.

Special Rule: A ship can always change its facing by one hex side at the end of its movement for free, in addition to any other facing changes made during its move.

Table 3-1: Maneuverability

MC	Hex Face Change	Speed Change ¹	Initiative Modifier	Reverse Speed	Crash Save Modifier
A	3 ²	3	-3	3	+8
B	2 ³	3	-2	3	+6
C	2 ³	3	-1	3	+4
D	1	2	+0	2	+2
E	1	2	+1	2	0
F	1 ⁴	1	+2	1	-2
G	0 ⁵	1	+3	1	* ⁶

¹A major helm can adjust its current speed up to its maximum SR.

²MC A ships change facing at will to the direction of choice, at no SR cost.

³MC B or MC C ships spend 1 SR to change facing, even for a two hex-side change.

⁴MC F ships must move forward one hex before changing facing.

⁵MC G is possible only as a result of a critical hit: No turns during movement, -3 initiative penalty, must roll 30% chance to change one hex side at the end of movement if a turn is desired.

⁶MC G saves as a 1st level wizard.

Stacking

Any number of ships can be in the same hex at the same time. Ships in the same hex can ram, grapple, board, or engage in missile fire or magic according to the rules in those sections.

Loss of Maneuverability

Any round that less than the minimum crew is available to sail the ship, the MC is lowered by one class (B to C, etc.). "Minimum crew" counts the helmsman, the navigator, and the captain, as well as any officers and sailors assigned to ship-handling duties. Crew engaged in sailing the ship cannot man large weapons, fire small missiles, or cast spells. If the ship is engaged in a boarding action, no crew can count for ship-handling.

Maneuverability can be lost through special damage (see Critical Hits, page 16).

Optional Rule: The degree of MC loss depends on the fraction of the crew lost. The minimum MC possible is F, unless the ship has suffered a maneuverability critical hit that has reduced its MC to G.

Crew Loss	MC Loss
Under minimum but over 1/2	-1
1/2 or less but greater than 1/4	-2
1/4 or less	-3
No crew left	MC F

Thus a ship with MC B requiring 15 sailors would fall to MC C at 14, MC D at 7, MC E at 4, and MC F at 1 (the spelljammer).

EXAMPLE OF MOVEMENT

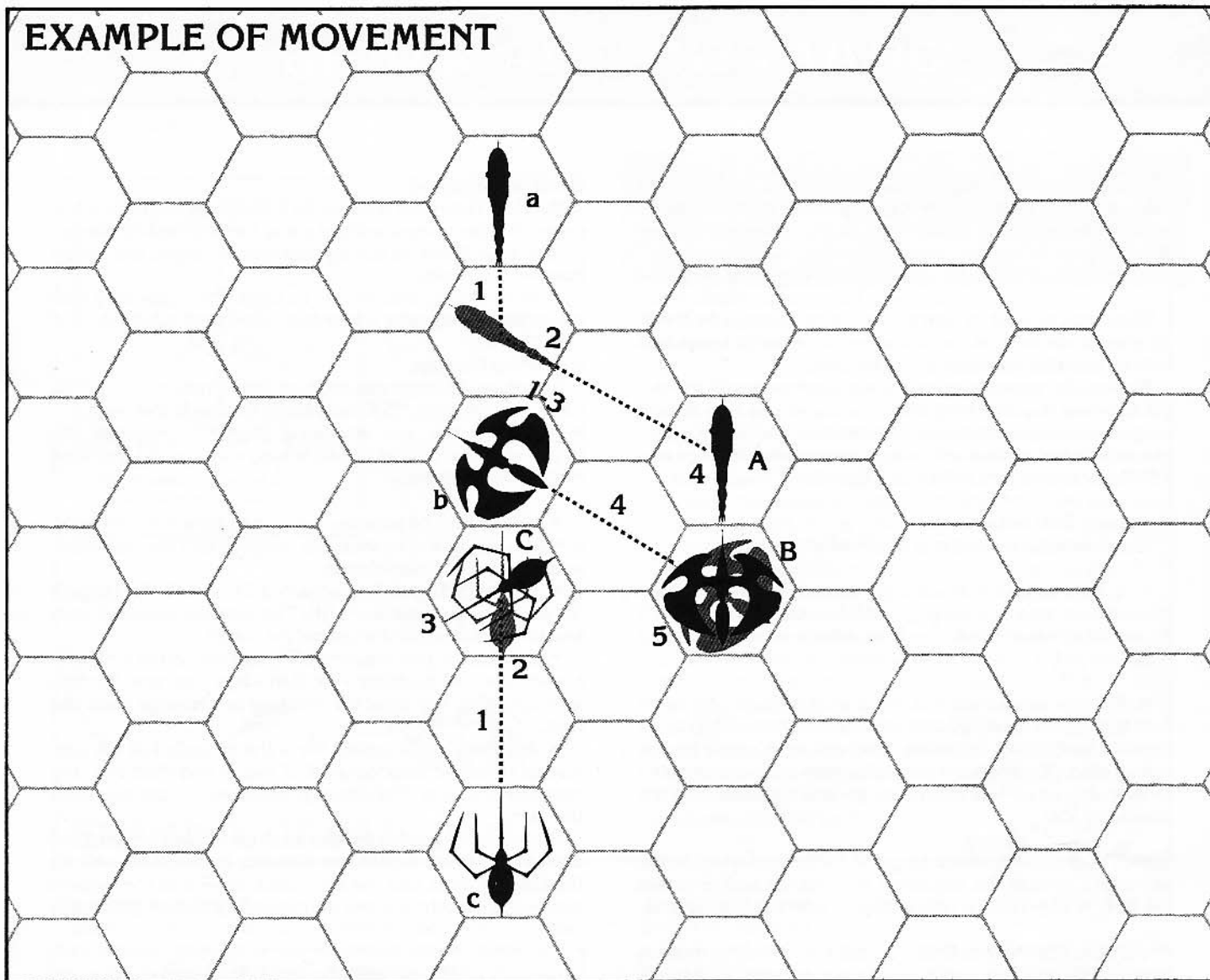

The Ships:

Ship A is a mind flayer Nautiloid (MC D) powered by a *series helm* with four helmsmen (SR 4).

Ship B is an elven Man-O-War (MC C) with a *major helm* and an 11th level wizard (SR 5).

Ship C is a neogi Mindspider (MC C) with a *lifejammer helm* and an umber hulk (SR 3).

The Initiative Roll:

The 1d10 rolls for initiative are 4 (the Nautiloid), 2 (the Man-O-War), and 5 (the Mindspider). After adjusting the initiative for MC, the Nautiloid has a 4, the Man-O-War has a 1, and the Mindspider has a 4. The player with the Man-O-War, having rolled lowest, decides to go first. The other two players roll again to break their tie. Assume the Nautiloid player rolls a 2 and the Mindspider player rolls a 6. The movement order for the round is: Man-O-War, Nautiloid, Mindspider.

Movement:

Man-O-War (Ship B): Assume the Man-O-War's speed from the last round is 3. His maximum possible speed forward is 5 (the wizard's limit; see Table 5-12 in the *War Captain's Guide*). His maximum possible speed backward is 3 (the MC limit; see Table 3-1 in this book). Since his ship has a *major helm*, the player can change his speed by 5, letting him move between 5 hexes forward and 2 hexes in reverse ($3 - 5 = -2$). The player decides to move backward as fast as he can, taking a free facing change at the end of his movement.

Nautiloid (Ship A): Assume the Nautiloid's speed from last round is 3. This round, the player increases its speed to 4. After moving forward one hex (using 1 SR point), the ship turns (using another SR point), and moves forward another two hexes (using its last two SR points for the round). The player then takes his free facing to end his move pointing directly at the Man-O-War.

Mindspider (Ship C): Assume the Mindspider's speed from last round is 3. This round the player moves forward 2 hexes (using 2 SR points). He then changes facing by *two* hexsides (using 1 SR point because the ship is MC C). The player decides to end his move without taking a free facing.

CHAPTER 4: RAMMING

"So, you want to bring yer opponents down, eh? Just slip 'em a good 'n' sharp piercin' ram right inta' that broadside, and watch 'em pitch. Never seen anything so funny in m' life!..."

Trelbeq, Halfling Arms-Sergeant

Ramming is used in space combat to damage or break up enemy ships. It is most successful against ships less than or equal to the attacker's tonnage.

To ram, the attacking ship moves into the hex of the target ship and the attacking player announces a ram attack. Large weapons, small missile weapons, and spellcasters can attack before the ram attack is resolved. A ship can initiate only one ram attack in a round.

Ramming Restrictions

The following restrictions apply when ramming:

- A ship cannot ram a target whose tonnage is more than three times its own (e.g. a 10-ton ship cannot ram a 31-ton or greater ship). Such an attack is resolved as a *crash*.
- A ship cannot ram a target that is 10% or less of its own tonnage (e.g. a 100-ton ship cannot ram a ship of 10 tons or less). Such a ram is resolved as a *crash* by the lighter ship. (*Exception:* A grappling ram can be attempted on any ship of up to three times greater tonnage than the attacking ship.)
- A ship cannot ram a target if both ships start in the same hex, unless the ramming ship leaves and re-enters the hex. A ship cannot ram a ship to which it is grappled.

Procedure (the Attack Roll): Before the ramming move is begun, the attacker must record his current SR for the round. Missiles and spells can be exchanged as he approaches. When the ramming ship has entered the target's hex and all ranged combat has been completed, the ram is resolved.

To resolve the ram, find the attacking helmsman's THACO and subtract the roll of 1d20. If the total is less than or equal to the target's armor rating (AR), then the ram hits and the attacker's current SR is immediately reduced to 0. (If a ship has no one individual at the helm—pool helm, orbis, forge, etc.—use the navigator's THACO at one-half his level or hit dice.)

If the ram hits, it causes damage (see Ramming Damage). If it misses, the attacking ship must finish its move using the rest of its unused SR points. Missile fire or spellcasting can take place as opportunities arise, but no other ram attacks can be attempted.

If a natural "1" is rolled on a ram attempt, the ram not only misses, but the ramming helmsman must save vs. death to avoid shearing rigging from his own ship. The ramming ship's MC modifies this roll (see Table 3-1 on page 6). Failure means the ramming ship loses one MC, to a minimum of MC F. Missiles and spells can be used normally as the ships pass.

Head-on Ramming

Head-on ramming is a special and dangerous case. It exposes the ramming ship to the any ram carried by the opposing ship. If the attacking ship hits its target, the ram is handled normally.

If the ramming ship misses its target, the opposing ship can immediately take a free ram against its attacker.

Ramming Damage

Ramming damage depends on the ramming ship's tonnage, current speed (SR), and angle of attack. Before figuring ram results, the attacking player determines the adjusted speed (SR) of the attacking ship (round fractions of current SR down).

- **Head On:** The adjusted SR is the target's SR *added* to the attacker's SR. The attacker receives half the ram damage inflicted on the defender.
- **Forward Angle:** The adjusted SR is half the target's SR *added* to the attacker's SR. The attacker receives one-fourth the damage inflicted on the target.
- **Aft Angle:** The adjusted SR is half the target's SR *subtracted* from the attacker's SR. If this is less than one, the ram attempt fails. The attacker receives no damage from the ram.
- **Aft On:** The adjusted SR is the target's full SR *subtracted* from the attacker's SR. If this is less than one, the ram attempt fails. The attacker receives no damage from the ram.

A target with a rear ram can attempt a counter-ram if the attack fails (a hit means the attacker impaled himself on the target's ram). Use the difference in SR and the target's tonnage to determine any damage the attacker may take.

$$\text{Ram Damage} = \text{Tonnage}/10 \times \text{SR}$$

Blunt Rams: These inflict one point of hull damage for every 10 tons of the attacking ship (round fractions up) *times* the adjusted SR.

The target ship suffers an immediate "Ship Shaken" critical hit and one other random critical hit rolled by the attacker (see Critical Hits, page 17).

Piercing Rams: These inflict the same damage as a blunt ram. The target ship suffers an immediate "Ship Shaken" and a "Hull Holed" critical hit.

In addition, a surviving target ship of 20 tons or more will be *locked* (treat as grappled) to the attacker. Ships under 20 tons have a 5% chance per ton of being locked. A player can announce a disengagement attempt in the round's Endphase. If his helmsman makes a successful attack roll, then the ship is stationary and disengaged at the end of the round.

Grappling Rams: These inflict no damage. A successful hit means the ships are grappled. If the adjusted SR is less than one, the grapple-ram fails, even if the ships end their moves in the same hex. The grappled ship cannot disengage.

CHAPTER 4: RAMMING

CRASH FACING



A crashing ship uses this diagram to determine its facing. The diagram can also be used to determine a random facing at the start of the game.

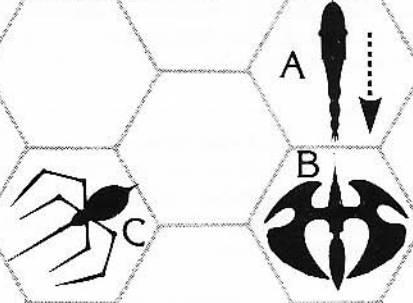

EXAMPLE OF RAMMING

The Situation:

The situation is the round after the movement example. The initiative order for this round is: Nautiloid (Ship A), Man-O-War (Ship B), Mindspider (Ship C). The Mindspider has won overall initiative and chosen to go last.

Nautiloid (Ship A):

Movement: The Nautiloid player decides to ram the Man-O-War. Since the Man-O-War hasn't moved yet, it is assumed to have its course and speed from the previous round (reverse movement at 2 SR). The Nautiloid player decides to move as SR 4, and notes this speed on his Ship Record Sheet.

Ram Attack: The Nautiloid has a 9 hit dice mind flayer as a navigator (remember that ships with *series helms* use half the navigator's level), so the attack has the same THACO as a 4 hit dice monster (17 on 1d20). The player rolls 1d20 and gets a 12, hitting an armor rating of 5 or worse. Since the Man-O-War's AR is 7 (two places worse than 5), the ram hits.

Ram Damage: Since both ships are moving in the same direction, the ram is treated as an "Aft-On" ram. The adjusted SR for the ram is 2 (the Nautiloid's speed of 4 minus the Man-O-War's speed of 2 in the same direction). This "2" is multiplied by 4 (which is 1/10 of the attacker's tonnage, rounded up; 3.5 rounds to 4), for a total of 8 hull points of damage. In addition to this damage, the Man-O-War suffers the "Holed" and "Ship Shaken" critical hits. The attacker takes no damage from an aft-on ram. Finally, the two ships are locked together by the Nautiloid's piercing ram.

Ramming and Ship Facing

Both ships involved in a ramming or crash maintain their current facings. If the ramming ship enters the hex from the target's port side, any ram effects occur on the port side of the target ship. Any ship able to leave the hex will maintain its current facing as it does so.

Always let the situation and the ships' positioning determine the effects of a ramming attack. For example, if a ship moving in reverse is rammed in the bow by a pursuing ship, the damage multiplier for an *Aft-On* ram is used. If the ship moving in reverse has a bow ram, then the attacker will be subject to its attack if his own ram misses.

Movement After Ramming

If the ramming ship misses its target or reduces the opposing ship to zero hull points, the ramming ship continues its movement up to its current SR limit. If the attacker hits its target without destroying it, or is locked or grappled with the target, its movement stops immediately. Ship crews may try to grapple if the conditions are right (see Grappling). A ship continuing to move after a ramming attack cannot try to ram again.

Ramming Creatures

Creatures of less than gargantuan size cannot be rammed by a spelljamming vessel. Against gargantuan creatures, the helmsman must roll a hit using his THACO against the creature's armor class (AC). Gargantuan creatures take 1d6 hit points of damage for every hull point inflicted by the ram (e.g., if a ram inflicts 7 hull points on a

gargantuan space creature, the creature takes 7d6 hit points of damage).

Creatures capable of damaging spelljamming craft inflict 1 hull point of damage for every 10 hit points of damage they cause (round 6 up).

Shearing Attacks

A shearing attack is a close pass near an opponent's ship with the intent to cripple the target's maneuverability by dragging away its rigging, steering equipment, and other maneuvering gear. As with ramming, missile and spell attacks can be made in addition to shearing. Shearing attacks cause no damage to the target's hull.

Procedure: A shearing attack is made just like a ram attack. If a "20" is rolled, the target ship takes an immediate critical hit. A roll of "1" has no effect. If the attack misses, the target can immediately attempt a free shearing attack of its own. Each ship can initiate one shearing attempt per round.

A successful attack reduces the enemy ship's MC by one step to a minimum of MC F. A ship can only have its maneuverability reduced two steps by shearing attacks.

Crashing

A crash usually occurs when a deliberate crash or ram attempt is announced. If a crash attempt fails, the ships pass each other without damage (missile fire and magic are still possible). As with a ram, a crashing ship must record its current speed before moving.

CHAPTER 4: RAMMING

The helmsmen on the target ship must make a saving throw vs. death to avoid the crash. The saving throw is modified by the ship's MC (see Table 3-1). If the save is successful, the crashing ship continues with its movement, just like a missed ram. Magic and missile fire are possible.

A vessel with no one controlling its flight saves as a 1st level wizard (14 or more on 1d20).

Crash Effects: If a crash occurs, the smaller craft (in tonnage) is assumed to crash into the larger regardless of the overall tactical situation or the ships' current hull points.

Two ships of equal size are considered to crash into each other, regardless of their current hull points—each ship suffers damage as though it was the crashing vessel. When a ship crashes, the following results occur:

The crashing ship:

- The crashing ship takes its current SR plus half its original hull points as damage.

Example: A tradesman starting the game with 25 hull points crashes while moving at SR3. It takes 16 hull points damage (3 + 13), even if its current hull point total is less than 25. If this damage reduces the ship's hull points to zero or less, the ship breaks up.

- Each crew member of the crashing ship takes 1 hit die of damage per SR of speed. Those making a saving throw against death take half damage, rounded down. Standard crew saves in groups of 5, while special individuals, including the captain, the helmsman, and any PCs or special creatures, save individually. This damage is taken whether the crashing ship breaks up or not.

- All loading of large weapons on the crashing ship is disrupted and must be restarted from the beginning. The current facing of the crashing ship is realigned by a 1d6 die roll (see diagram).

Example: A ship with a 6 SR causes the crew to take 6 hit dice each of damage. A successful saving throw indicates 3 hit dice each. If the crew was creatures of 1-3 hit dice, they would all be dead regardless of the outcome of the saving throws.

- The crashing ship, if it survives, suffers an immediate "Ship Shaken" critical hit. It may also suffer more critical hit(s) if the damage taken is severe enough.

- If the crashing ship is destroyed, greek fire, smoke powder, and all other flammable materials aboard the target ship immediately detonate if the ship fails a saving throw vs. crushing blow. Ships specially rigged to explode do so on any roll but a 20.

The target ship:

- The target ship takes damage equal to the crashing ship's current SR and *current* hull point total before the crash (e.g. a cog with 4 of its 10 hull points left crashes while moving at SR 3; it inflicts 7 points of hull damage to the target ship).

- The target ship suffers an immediate "Ship Shaken" result. It may also suffer critical hits if the damage taken is severe enough (see the Critical Hits section for more information).

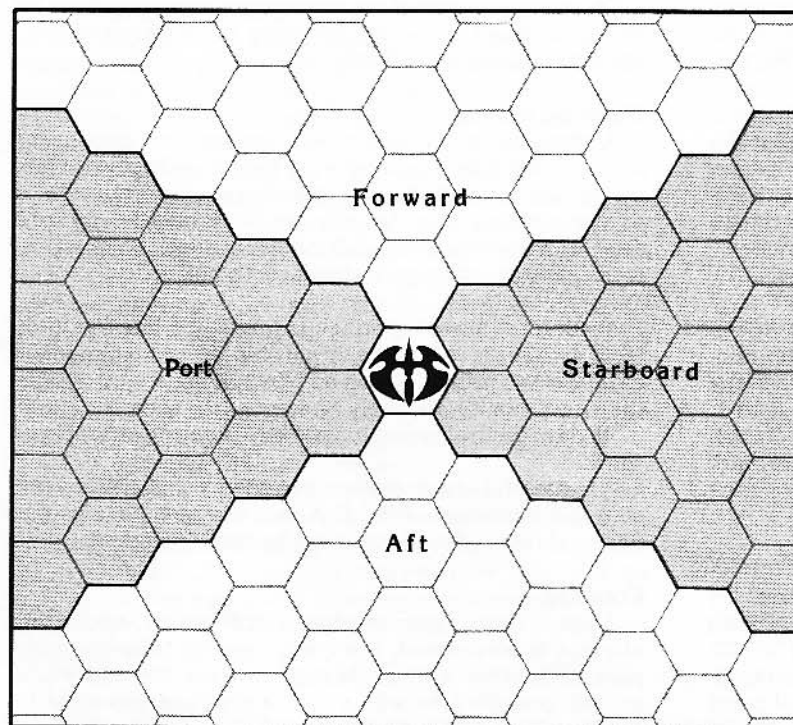

FIRE ARCS

Forward-Port: Includes all the hexes in either the forward or port arcs.

Forward-Starboard: Includes all the hexes in either the forward or starboard arcs.

Aft-Port: Includes all the hexes in either the aft or port arcs.

Aft-Starboard: Includes all the hexes in either the aft or starboard arcs.

Forward-Port-Starboard: Includes all hexes *except* those in the aft arc.

Aft-Port-Starboard: Includes all hexes *except* those in the forward arc.

CHAPTER 5: MISSILE FIRE

Large Missile Weapons

At any time throughout the round any ship can fire its large ship-mounted missile weapons.

Large weapons include ballistae, bombardrs, catapults, greek fire projectors, jettisons, and other large ranged weapons. Game information for large weapons is summarized on the Weapons Table on the back of this book.

Fire Arcs

Shipborne weapon mounts restrict what large weapons can fire at. The group of hexes a weapon can fire into is called its *fire arc*.

Each large weapon has a fire arc: Forward, Port, Starboard, Aft, or a combination of these. Fire arcs are illustrated in figure 5-1. The fire arcs for weapons on specific ship types are given in the *Ship Recognition Manual*.

Fire arcs should be noted on the Ship Record Sheet for each large weapon before play.

Note: When ships are in the same hex, figure fire arcs according to the direction from which the ships entered the hex, and their current movement, if any.

For example, if a ship enters another ship's hex from a head-on angle, then its forward weapons can shoot. If it passes directly through the hex, then its aft weapons can shoot as it leaves the hex.

Turrets: Some weapons are turret-mounted, allowing for full-field, 360° firing. This allows the weapons to fire in any arc. To swing a turret-mounted weapon from one fire arc to another does not cost anything, and the weapon can be redirected while being loading.

"Yass can't hit what yass can't ssee. Turretting the weaponss wass the besst thing I did!"
Slith Darkscale, Lizardman

Table 5-1: Fire Arcs

Arc	Designation
F	Forward Arc.
FPS	Forward-Port-Starboard Arc.
FS	Forward-Starboard Arc.
S	Starboard Arc.
AS	Aft-Starboard Arc.
A	Aft Arc.
APS	Aft-Port-Starboard Arc.
AP	Aft-Port Arc.
P	Port Arc.
FP	Forward-Port Arc.

Weapon Crews

Each large weapon has a crew (called *weaponers*), who man the weapon during battle. A weapon can be loaded and fired as long as a single crewman serves it. The crew required for each weapon is given on the Weapon Table on the back of this book.

Rate of Fire: Large weapons do not fire every turn. Every weapon has a rate of fire. These vary from 1 shot per two rounds to 1 shot per five rounds, depending on the type of weapon. For example, a weapon with a rate of 1/2 can fire, spent a round reloading, then fire again on the third round. Players should record the last round a weapon was fired on the Ship Record Sheet to determine when it can fire again.

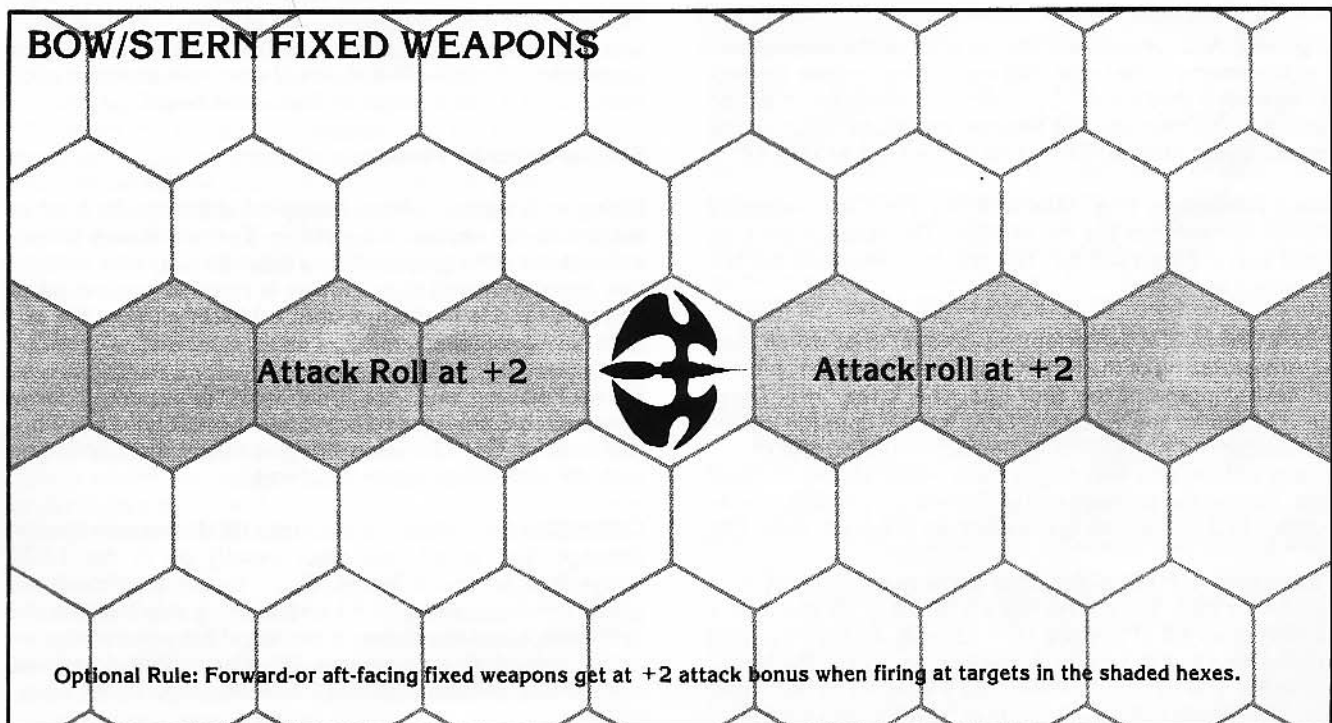

CHAPTER 5: MISSILE FIRE

Reloading: If weaponeers are lost from a weapon while it is reloading, that round doesn't count toward reloading. Certain other events (such as being rammed) may interrupt or even completely disrupt loading.

Option: For every man a weapon crew is short, add 1 round to the reloading time. For example, a weapon manned by three weaponeers with a rate of fire of 1/2 (that is, 1 round to reload) takes 2 rounds to reload two weaponeers, and 3 rounds to reload with only one man.

How to Fire Large Weapons

When to Fire: A ship can announce that it is firing one or more of its weapons at any time during the Movement step, while any player is moving. As a ship moves from hex to hex, the player can interrupt its movement in order to fire its weapons. As an enemy ship moves, any player can interrupt its movement in order to fire at it. If more than one ship fires its weapons in the same hex movement of any single ship, the firing occurs in initiative order. Any damage is applied immediately, possibly disrupting the planned activity of the target ship.

Example: A ship with initiative has chosen to move first so it can ram an enemy ship. As it moves, the enemy ship declares ballista fire at a range of three hexes. The ramming player elects to fire a forward catapult in return. The catapult shot is resolved first, as the ramming ship has the initiative for the round.

If the ramming ship had held its fire, the target ship's shot would have been resolved alone. The ramming ship could take its fire at a range of two hexes or one hex (but not just before the ram, as catapults can't fire at targets in their own hex.)

Targeting: A large weapon can be fired at the enemy hull or at the enemy crew (note that some weapons are ineffective against a ship's hull). Specific individuals (such as the captain or helmsman) and weapon positions (such as the forward light catapult) cannot be picked out as targets.

Firing Procedure (the Attack Roll): Find the weapon's THACO and *subtract* the roll of 1d20. The result is the best armor that the shot will hit. The result depends on the target aimed at.

Firing at the Hull: If this armor hit is equal to or worse than the Armor Rating of the target ship, then the ship is hit and will take damage. If the shot hits, check the "Hull Damage" column of the Weapons Table for the damage inflicted. Roll for the hull points of damage inflicted and check for any critical hits that might have occurred (see Critical Hits). Record the damage on the Ship Record Sheet. A ship reduced to 0 hull points breaks up (see Breakup, page 17).

Example: A Mindspider fires a medium catapult at a Nautiloid's hull. The player has a THACO of 15 and rolls a 12, hitting an AR of 3 (since $15 - 12 = 3$). As the Nautiloid hull has an AR of 4, and AR 4 is worse than AR 3, the Nautiloid is hit. The catapult inflicts 1d3 + 1 points of hull damage. The player rolls a 2, inflicting 3 hull points total.

Firing at the Crew: If shooting at the crew, compare the adjusted roll to the Armor Class of the most numerous crewmen. If there is a tie for most numerous, then fire is resolved against the weakest armor class. If a hit is scored use the "Hull Damage" column to determine how many *hit dice* of crew are affected (the "Personnel Damage" column is used only in role-playing or very small ship actions). Roll 2d6 on the Crew section of the Ship Record Sheet to find which crew have been hit. The following special rules apply:

- A light ballista does 1d2 hit dice of damage to crew.
- Ballistas affect only one individual or crewman. Dual ballistas can affect up to two individuals or crewmen.
- Catapults and jettisons affect *each* crewman in the section. The damage is then combined into kills until at most one wounded crewman remains (see Crew Damage). A hit on an individual (captain, officer, wizard, etc.) inflicts damage on one individual only.

Example: A Mindspider fires a medium catapult at a Nautiloid's crew. Assume the most numerous crew type is AC 4. The player has a THACO of 15 and rolls a 12, hitting an AC of 3 or worse (since $15 - 12 = 3$). This hits the crew.

The catapult inflicts 1d3 + 1 hit dice of crew damage. The player rolls a 2, inflicting a total of 3 hit dice of damage. The attacker then rolls 2d6 to find the type of crew hit. A roll of 7 indicates deck crew, so the shot inflicts 3 × 5, or 15 HD damage. Assume the deck crew is ogres (4 HD). In this case, the shot kills three ogres (12 HD) and wounds a fourth (3HD).

Misses: If the shot misses, place a marker matching the type of shot in the hex (or on a line between two hexes) at the maximum range of the weapon (see the Long Range Missile Movement diagram). The marker is placed face-down to distinguish it from missiles that have been fired on previous rounds. The shot will continue to move each round until it hits a target or leaves the board.

Special Rules for Firing

Firing at Grappled Ships: Grappled ships can be fired at subject to the normal rules of fire. The target ship is considered to be the grappled ship most directly in a straight line from the firing ship. A miss is rerolled against other possible targets in the hex until it hits or all possible targets have been checked.

Fixed Forward and Aft Weapons: Non-turreted large weapons that are fixed to fire forward or aft have a -2 bonus to their THACOs when firing at target directly in line with the ship's facing (see diagram).

Critical Hits: A critical hit is a lucky hit that causes special damage. The attack roll must usually be in the 17-20 range (see Weapons Table). If the target ship carries a greek fire projector, add +1 to the firing ship's attack die roll when checking to see if a critical hit occurs (e.g. an attack roll of 17 becomes an 18). For further details on critical hits, see the Critical Hits section in Chapter 7.

CHAPTER 5: MISSILE FIRE

Small Missile Fire

"And don't use yer wheellocks in the Flow!"

Giff Serjeant

Small missiles include individual ranged weapons such as bows, crossbows, arquebuses, slings, and similar weapons. Small weapons do not inflict damage upon a ship, but only upon enemy crew.

How to Fire Small Missiles

Range of Small Missiles: Small missiles have a range of 0 hexes; that is, the ship must be in the same hex as the enemy ship for small missile fire to be effective. Small missile fire can be declared any time the enemy is in range. As with large missiles, in any exchange of fire, the side with initiative for the round fires first.

Rate of Fire: Small missiles can fire once every move. Fire can be divided between different target ships in range as the firing player wishes. All small missiles on a ship must be fired at the same time.

Target Armor Class (AC): Small missile fire is resolved against the armor class (AC) of most numerous of the enemy crew that are vulnerable to the attack. For example, if the target ship crew has ten enemy crewmen with AC 2 and fifteen enemy crewmen with AC 7, then attacking missile fire is resolved against AC 7.

Firing Procedure: The attacker rolls 1d20 for each group of 5 crewmen firing. Find the firer's THACO and subtract the roll. The result is the best armor class hit.

A successful hit reduces the number of hit dice in the enemy crew by 5. Losses are assigned by random roll: roll 2d6 and check the crew section of the Ship Record Sheet to find what type of crew is hit.

Subtract the hit dice of damage from the crew type hit, marking off the appropriate number of casualties. More information can be found in Crew Damage, p.16.

Understrength Groups: A group of less than 5 crewmen can fire for reduced damage. A successful hit reduces the number of hit dice in the enemy crew by the number of those firing.

Example: The target crew includes 10 crew in AC 2 (3rd level marines) and the 15 crew in AC 7 (1st level deck crew). The attacker has 22 bowmen, giving him four attack rolls with 5 archers and one attack with 2 archers. Assume two full attacks and the partial attack hit. The missile attack has inflicted 12 hit dice of losses. The defender rolls a 6 and a 7, killing three marines (9 HD) and wounding one (1 HD), and killing two deck crew (2 HD).

Optional Rule

First Fire: When a ship first enters a hex containing an enemy ship, any small missiles with a range of 1(1) fire first (longbows, heavy crossbows, arquebuses). If both ships have these weapons, fire is resolved in initiative order, but before range 0 weapons fire.

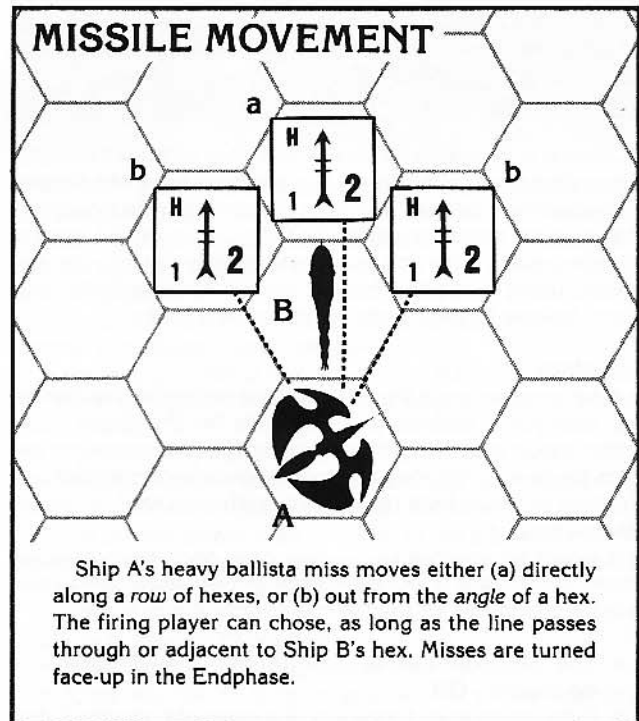

Ship A's heavy ballista miss moves either (a) directly along a row of hexes, or (b) out from the angle of a hex. The firing player can chose, as long as the line passes through or adjacent to Ship B's hex. Misses are turned face-up in the Endphase.

Large Missile Movement

"A friend of mine, a saavy captain, once shot a heavy ballista at a neogi Mindspider and missed. As he swung around for another attack, aiming his ram amidship, that same blasted bolt sliced through the window, instantly killing his helmsman..."

Alcabon Terminnus, Privateer

Procedure (Large Missile Movement): In the Large Missile Movement step, any large missiles currently on the board move. A large missile moves in a straight line to limit of its range (printed on the marker). For example, a medium ballista bolt moves 4 hexes during this step.

Missiles move each round until they hit something or move off the board. (They can be removed early by mutual agreement if it obvious they are out of play.)

If a large missile enters a hex containing a ship, the player who shot the missile rolls an attack. Such attacks are always resolved against the hull.

Important! All large missiles that have an attack roll in this step hit on a roll of 18 or more, and score a critical hit on a roll of 20, regardless of their original THACO.

If the missile hits, it is removed from the board and the ship takes damage normally; otherwise the missile stays on the board.

If the missile enters a hex containing more than one ship, or occupies a line between two hexes containing ships, randomly decide which ship may be hit by die roll. If it misses, other possible targets will be attacked in turn. Friendly ships can be hit in this way, and it is possible that a ship might be hit by its own missile!

CHAPTER 6: BOARDING

"When they strike the colors, you've got to board quick, get what you want and leave. I've seen them take out whole crews with fake surrenders!"

Ande D'Vis, Founder of the Wildfire League

Often it is desirable to take over a ship without inflicting major damage. Many times, the stronger side can simply overwhelm the weaker and take the enemy ship by storm. This type of attack is called *boarding*. In order to start a boarding action, the attacker must usually grapple the defender; using grappling hooks, special ballista bolts, and other devices to secure the ships to each other.

Grappling

A successful grappling attack must occur before boarding. Grappling attacks can be made by the ship's crew (with thrown grappling hooks) or by special grappling devices (such as grappling rams or ballista bolt grapples). A piercing ram can lock the ships together as well (no grapple needed).

A ship can attempt to grapple only once each combat round. Grappling is possible only if both ships are in the same hex and one of the following conditions is met:

- The attacker has a ram-grapple, claw-grapple, or equivalent; OR
- Both ships are stationary (for example, stopped due to a ram or collision); OR
- The relative speed of the ships, comparing their current SR and direction, is 0 or 1 SR.

The basic chance for grappling is a modified roll of 10 or less on 1d20.

If both ship crews wish to grapple, the attempt is automatically successful. (Since grappling attempts are not simultaneous, the first player to try in a round must roll. If he fails and the other player declares a grappling attempt, then that attempt is automatically successful).

Table 6-1: Grappling Modifiers

Green Crew	+1
Average Crew	0
Trained Crew	-1
Crack Crew	-2
Grappler outnumbered Defender 2+:1	-1
Grappler outnumbered by Defender 1:2+	+1

Outnumbering refers to the *number* of crew involved, not their hit dice. Special devices may also affect the roll (see Grappling Devices).

Degrapping

On subsequent rounds, a ship can choose to degrapple from an enemy ship. The degrapping attempt takes the place of normal boarding attacks that round. The degrapping roll is like a grappling roll except it has a -2 penalty. If successful, assume the surviving crews are on their respective ships.

If the ships are locked by grappling devices, the owner of the device can degrapple at will. The other crew has an additional -4 penalty (-6 total).

If the ships are locked by a piercing ram, either helmsman (and they only) can disengage by successfully making a THACO roll against the other ship's AR in the Endphase of a round.

Ship Movement while Grappled

Once two ships are grappled, neither helmsmen can move them if their combined tonnage exceeds his helm capacity. If both ships are otherwise able to move, then the ship with the highest SR can move and the other cannot. If SRs are equal, then neither ship can move.

If movement is possible, then the ship able to move can do so, taking the other ship with it. The maneuverability class of the combined ships is F. The relative facing of the grappled ship does not change.

Melee

"So we jumped over onto their main deck, just as their marines came boiling up out of the hold. 'Twas hot work for awhile."

Alcabon Terminus, Privateer

The boarding action includes hand-to-hand combat and point-blank magic and missile fire. This combat is called a *melee*. The entire crew is assumed to participate; the *melee* is their only action in the round.

Once the ships are grappled, the first exchange of the boarding action is fought during the Boarding Combat phase of the *next* round. The ship that successfully grapples is assumed to be boarding the other ship.

The side making its attacks is called the attacker (even if it is currently defending its ship). *Melee* attacks follow initiative order; the side with initiative attacks first. Losses are removed before the side without initiative attacks.

Grappling Devices: Common grappling devices include:

Grapple Ram: The grapple is successful if a ram attack roll is successful. Some types of grapple-ram may do hull damage in addition to grappling.

Claw (Jaw) Grapple: Like the grapple ram, an attack roll is needed to grapple. If successful, the claws or jaws may inflict additional hull damage.

CHAPTER 6: BOARDING

The boarding action lasts until one ship has no crew, fails a morale check, or successfully degrades.

Player characters (PCs) might affect melees (details are in the Heroic Action section, p.21).

Procedure: Melee attacks are resolved in initiative order, and casualties do *not* make return attacks against their foes.

Attackers are divided as evenly as possible into groups of five crewmen with the same THACO.

Attacks are resolved as THACO rolls against the armor class (AC) of most numerous of the enemy crew that are vulnerable to the attack. For example, if there are 10 enemy crewmen with AC 3 and 15 enemy crewmen with AC 8, the melee attacks are resolved against AC 8. (If there is a tie for most numerous, then melee is resolved against the weakest armor class.)

The Attack Roll: The attacker rolls 1d20 for each group of 5 crewmen. The roll is *subtracted* from the attacker's THACO. The result is the armor class hit.

A successful hit reduces the number of hit dice in the enemy crew by 5. Losses are assigned randomly by rolling 2d6 on the Ship Record Sheet crew table.

Subtract the hit dice of damage from the crew type hit, marking off the number of casualties taken. One partially wounded crewman of each type is allowed, but (except in the case of individuals) wounded types take wounds first until they are killed.

Understrength Groups: A group of less than 5 crewmen can attack for reduced damage. A successful hit reduces the number of hit dice in the enemy crew by the number of those attacking.

Example: A crew with 10 marines (3rd level, AC 3) and 15 deck crew (1st level, AC 7) is attacked by 24 lizard men. The attacker rolls four attacks with 5 lizard men each and one attack with 4 lizard men. If one full attack and the partial attack hit, and the crew type rolls are 6 and 7, the defender loses one marine killed (3 HD) and one wounded (2 HD), and four deck crew killed (4 HD). He returns attacks with the survivors before the next boarding action is resolved.

Special Monsters

Creatures with special attack forms inflict double losses on their opponents. These include: confusion, energy drain, fear, magic use (wizards, clerics), mental blast (mind flayers), paralysis, poison, petrification, and multiple attacks causing 30+ points of damage maximum per round. Other special attacks may be allowed by special game condition.

Beholders and the argos inflict triple damage.

Multi-Ship Melees

Each ship crew attacks the crew of one other ship. If engaged with more than one enemy ship, then the owner chooses which enemy ship to attack.

If a group of very small ships (such as Flitters) attempts to land on and board a larger ship, their crews are combined and considered one crew for boarding purposes.

Morale

"The key to success is the most rudimentary lesson. Keep your crew happy."

Denys of Shiningburg, Paladin

Morale, the crew's willingness to fight, often determines the outcome of a boarding action. If one side fails a morale check, the ship crew surrenders and the ship is taken. Often, a captured ship will be looted of cargo and/or towed back to a base.

Morale is checked at the end of a round of boarding if certain conditions apply (see Table 6-2).

A typical crew has a morale rating (MR) of 12, adjusted for crew quality. Monstrous crews might have higher or lower morale.

Procedure: Find the crew's Morale Rating and adjust it according to the morale modifiers (Table 6-3). Then roll 2d10. If the roll is less than or equal to the adjusted morale number, then the crew continues fighting. If the roll is higher, the ship crew surrenders.

Table 6-2: Morale Checklist

- Crew losses reach 50% or more.
- Crew has taken at least one hit die of damage in a boarding action (even if no crew is killed).
- Crew is fighting a creature no one on board can harm.
- Any officer, including the ship's captain, is slain.

Some situations can affect morale rolls. Table 6-4 shows these modifiers. Add in all that apply.

Table 6-3: Morale Modifiers

Captain is slain ¹	-2
Crew losses are at 50% or more	-4
Crew is outnumbered 3 to 1	-4
Flagship within 6 hexes	+2
Opponents outnumbered 3 to 1	+2
Ship is on fire	-2

¹The first mate becomes captain in the next Endphase if the captain is slain. If both the first mate and the captain are dead, then the modifier applies for the rest of the game.

Once a crew has won a boarding action and spent one round reorganizing, their current crew total will become their new base for morale purposes. Any crew detached to man a captured ship will form an all-new crew for that ship for morale purposes. A prize crew will have an acting captain, but no acting first mate.

Poor Morale

If a crew with poor morale is boarded, they must make an immediate morale check. If they pass, they fight normally. If they fail, they surrender.

A crew with poor morale can try to rally by checking morale with a +2 bonus in the Endphase. If successful, their morale is once again good.

CHAPTER 7: SHIP AND CREW DAMAGE

"I losst only three crewss in 20 yeasss of sspelljamming. Now, I can't find ssailorss to ssave my life. Trusst me. You ssecure a reputation fasst up here!"
Sliith Darkscale, Retired Lizardman Merchant.

Crew Damage

Damage to the crew is taken in terms of hit dice. If a crew type has multiple hit dice, then every time it takes that many hit dice of crew damage, a crewman dies. All hits against crew sections are combined so that a group that shares the same AC, THACO, and HD has at most only one wounded crewman and one partial section.

Assigning Crew Damage: Crew damage is assigned by rolling 2d6 on the "Crew No." column of the Ship Record Sheet. The total rolled on the dice shows the type of crew that has been hit. If the roll matches a type of crew that isn't present or has been killed, then the damage is assigned to the crew according to the crew loss priority.

Note on Weaponers: The number of weaponers lost to a hit on a weaponer section cannot exceed the number manning the largest missile weapon upon which the attack could bear. The difference, if any, is taken from other crewmen according to the crew loss priority.

Crew Loss Priority: Crew; Marines; Sailors; Weaponers; Officers; Specials; PCs; Helmsman (pool or series); First Officer; Captain; Navigator; Helmsman (individual).

Example: A Hammership with no marines has lost all but one of its unassigned crew and all but two of its weaponers. Assume all crew have 1 HD. It takes a crew hit of 5 hit dice on a weaponer section. The first two hits kill the weaponers, the third hit kills the unassigned crewman, and the last two hits kill two sailors.

Damage to Individuals: Some rolls indicate that an individual has been hit (for example, the captain, first officer, helmsman, navigator, or special such as a higher level spellcaster or PC). If more than one individual might have been hit (e.g., a ship has three or four secondary officers) determine which is hit by random roll.

If the attack was by a large missile weapon, the individual takes the indicated amount of damage.

If the attack was by a crew section, the individual hit takes 1-5 hit dice of damage (roll 1d10 and halve result, rounding up).

PCs (only) who would be killed are considered incapacitated and unconscious (1 hit point) instead.

If an officer or captain dies, the crew must immediately check morale (see Morale).

Saving Throws

Ships exposed to special attack forms (fire, magical fire, an ice storm, lightning, etc.) must roll a *saving throw* on 1d20 against the attack. Usually, a successful saving throw reduces damage by half, but sometimes a saving throw results in no damage whatsoever.

Often a ship crew will not have to make a saving throw if the saving throw of the ship is successful. Details for individual magical effects are given in the chapter on Magic.

Crew save in groups of five identical crewmen whenever possible. Most crew will save as Warriors at a level equal to their hit dice. Those with abilities resembling another group can use the most advantageous saving throw.

Non-intelligent monsters have normal saving throws vs. death and poison. They save against other special attacks at a level equal to half their hit dice.

Crew saving throws are on the Player Aid card, or can be used from the AD&D® 2nd Edition *Dungeon Master's Guide*.

Table 7-1: Ship Saving Throws

Material	Cr.			Fall	Mag		Nor.		
	Acid	Blow	Dis.		Fire	Fire	Cold	Light. Elec.	
Bone	11	16	19	6	9	3	2	8	2
Cloth	12	—	19	—	16	13	2	18	2
Crystal	3	17	18	8	3	2	2	14	2
Glass	5	20	19	14	7	4	6	17	2
Ivory	11	16	19	6	9	3	2	8	2
Leather	10	3	19	2	6	4	3	13	2
Metal	13	7	17	3	6	2	2	12	2
Paper	16	7	19	—	19	19	2	19	2
Pottery	4	18	19	11	3	2	4	2	2
Rope	12	2	19	—	10	6	2	9	2
Stone	3	17	18	8	3	2	2	14	2
Wood, thick	8	10	19	2	7	5	2	12	2
Wood, thin	9	13	19	2	11	9	2	10	2

Critical Hits

"...You've never listened to victory until you've heard the sound of a Mindspider's legs snapping in two."

Denys of Shiningburg, Paladin

Critical hits are special damage results that vary in ferocity from ship-and crew-threatening damage to less dangerous outcomes that only impair the performance of the ship. Only large ship-mounted weapons can inflict critical hits outright, but other damage can weaken a ship to the point at which a critical hit occurs.

Table 7-2: Critical Hit Causes

- Ramming and crashes.
- Large weapon attack roll, if high enough (see the Weapons Table).
- Ship damage reaches 50% of its hull points.
- Ship damage reaches 25% of its hull points.
- Ship hits space debris (see Debris rules)
- Special game condition or campaign "house rule."

When a critical hit is called for, roll on Table 7-4 and apply the result. If the result is inapplicable, ("Hah! My Maneuverability is already G") shift down to the next (higher numbered) entry on the list (toward 20).

Note that a critical hit is the *only* way a ship's maneuverability can be reduced to G.

If the target ship has bombards, any critical hit has a 10% chance to ignite the powder magazine, inflicting 2d10×5 hull points of damage.

CHAPTER 7: SHIP AND CREW DAMAGE

Table 7-3: Critical Hit Effects

d20	Result
1	Loss of Five Hull Points
2	Deck Crew Casualty
3	Interior Crew Casualty
4	Ship Shaken
5	Large Weapon Damaged
6	Deck Crew Casualty*
7	Hull Holed
8	Maneuverability Loss
9	Loss of 10 Hull Points
10	Ship Shaken
11	Fire!
12	Loss of one SR Point
13	Deck Crew Casualty*
14	Large Weapon Damaged*
15	Ship Shaken
16	Hull Holed
17	Maneuverability Loss*
18	Loss of 10 Hull Points
19	Loss of one SR Point*
20	Spelljammer Shock!

Definition of Critical Hit Effects

Loss of 5 or 10 hull points: This loss is in addition to the initial damage. The ship loses an equal number of crew members (5 or 10), chosen by the defending player. Such damage might cause another critical hit (and crew loss). All damage is applied immediately, and it is cumulative.

Deck Crew Casualty: 2d4 crew (defender choice) take damage inflicted by the weapon type. If a ram caused the critical hit, the crew members die, regardless of their hit dice.

A "*" result means the crew members die regardless of hit dice. In addition, a random individual (PC, etc.) must roll a save vs. death. Success means the character takes no damage. Failure means death (PC incapacitated with 1 hit point left).

Interior Crew Casualty: As Deck Crew Casualty, but the attacker picks the crew type (sailors, marines, weaponers, or crew). In addition, a randomly selected individual must roll a save versus death as above.

Ship Shaken: The ship rings from the severity of the attack. There is a 40% chance that no weapon, small missile section, or spellcaster can fire or reload in this turn or the next (PCs can roll individually). In addition, the ship must immediately save vs. crushing blow or have its MC is reduced by one step (e.g. B to C).

Large Weapon Damaged: One large ship-mounted weapon (whether light, medium, or heavy), chosen randomly, is knocked out for the rest of the battle.

A "*" result means the weapon is destroyed.

Hull Holed: The attack punches a hole in the ship where there was none before. The ship loses 1d6 randomly determined casualties.

Fire! A fire starts somewhere in or on the ship (see Fire section for effects). A fire from a critical hit does no damage the round it is inflicted, but spreads normally on subsequent rounds. If a fire is impossible (no flammables, etc.), go to the next entry.

Loss of One SR Point: The SR of the ship drops by one for the next 1d10 rounds while the helmsman readjusts his balance and senses to the ship's new damage level. SR losses are cumulative to a minimum of SR 0. If a ship with an SR of 1 receives this result, go to the next entry.

A "*" result means the ship must be repaired during non-combat situations.

Maneuverability Loss: The ship drops one MC category for 1d10 turns. An A class becomes a B, a B class becomes a C, an F class becomes a G, and so on. A class G ship cannot lose any more maneuverability, so the next entry on the critical hit chart is used instead.

A "*" means loss to the MC is permanent until the ship is repaired during non-combat situations.

Spelljammer Shock! The effect depends on the type of spelljamming engine. The spelljamming helmsman must make a saving throw vs. spell or fall immediately into a coma for 1d4 days. A replacement helmsman can operate the helm. All linked helmsmen in series or pool helms must save. These operate at reduced capacity as long as one helmsman survives. Other drives (including the neogi "lifehelm") are rendered nonfunctional for 1d4 days (no save). Ships without functioning drives cannot change their speed, direction, or facing.

Fire

Fires can start on ships as a result of a critical hit, a device such as the greek fire projector, a smokepowder or greek fire laden *helmseeker*, or spells like *fireball*.

Fire Damage: Fire attacks inflict their initial damage on the round they start. On each subsequent round during the Endphase, the fire inflicts one point more than it did on the round before. Fires will grow in ferocity if not put out.

Putting Out a Fire: This requires one person for every point of damage the fire will cause that round. For example, if a fire will cause 3 points of hull damage to the ship this round, then three people are required can extinguish the blaze. If not enough people are available to put out the blaze, they can reduce its severity by their actions. If two people fought the 3-point fire, then the fire would be reduced to a 1-point fire at the end of the round. only to increase to a 2-point fire at the beginning of the next round.

Players need to keep track of the *total* fire damage their ships have taken.

Fire and the Air Envelope: Once total fire damage equals 10% of the ship's tonnage, the ship's air degrades one step. If fire damage reaches 40% of tonnage the air envelope degrades again.

Flaming Debris: A ship reduced to zero hull points by fire is replaced with a Burning Debris marker.

Ships entering the burning debris field must make a saving throw vs. normal fire or suffer a "Fire" critical hit in addition to damage from debris (see Debris section).

Breaking Up

If a ship is reduced to zero hull points, its internal structure is destroyed, and it breaks apart. Survivors usually cling to the pieces in hopes of being picked up after the battle. If the optional Debris rules are being used, place a Debris marker in the hex of any ship that breaks up. This debris move at the ship's last speed until it leaves the tactical map. If a fire caused the breakup, use a Flaming Debris marker on the board instead (see Debris).

CHAPTER 8: MAGIC AND SPELL USE

"The problem with the cursed elves is that they usually have more mages than you'd ever want to see."

Alcabon Terminus, Privateer

Spellcasting can be decisive in ship-to-ship combat. Since spellcasters are special individuals, games involving them will take more time to set up and play. However, certain fleets, like those of the elves, come into their own when they have a full complement of spellcasters.

Spellcasters and Spells

Spells are cast by wizards and priests, each of whom can cast one spell per round if they are doing nothing else. Spells affect targets only in the same hex as the caster. Most spells are used to attack enemy ships or crews, but some, especially clerical spells, give bonuses to the caster's crew.

Each spell has a *name* that gives some clue as to its effect. Each spell has a *level*, the measure of its power and how difficult it is to cast. Each spell has an *area*, which defines what target the spell can be cast at. Each spell has an *effect*, which give other details, such as damage inflicted, effect of saving throws, and so on.

The Spell Appendices introduce spells from the AD&D® game system, simplified and adapted for space combat.

Spell Selection

Spells are selected before play in numbers and levels according to the AD&D® rules, and are crossed off the spellcaster's list when used. For those who wish to play without the full rules, the following "quick" rules can be used.

Each caster has a number of spell slots, one per level. The player uses spells as desired, crossing off the slots as they are used. The highest level spell available is equal to half the caster's level (round up). A caster is allowed up one spell of the highest level (two if an even level), two of the next highest, three of the next, and so on. Thus, a 6th level wizard would have two 3rd level slots, two 2nd, and three 1st level slots to divide his six spells between.

The Announcement Phase

A player must announce in each Announcement phase what his spellcasters are doing. The options are *spell*, *counterspell*, or *pass*. A *spell* is usually an attack, and can be cast at any time during Movement or Large Missile Movement phases. A *counterspell* is a defense, and cast only during the Endphase. A *pass* means that the caster is not doing any spellcasting that round.

Option: Players can make up special markers for *spell*, *counterspell*, and *pass*, for their spellcasters and place them face-down in a convenient place during the Announcement phase. This records the player's intentions for the turn, while keeping his exact spell choices secret until the player chooses to reveal them.

Procedure (Casting Spells): Like missile fire, spells can be cast at any time during the Movement phase. The target must be in the same hex as the caster. The player with the spellcaster can pick any spell available to the caster. The player with an initiative advantage casts his spells

first. A caster taking the *spell* option who takes damage before casting cannot cast a spell that round, and must eliminate one slot from his list (it is assumed to be interrupted during casting). A "Ship Shaken" critical hit will also disrupt casting. Spells cannot be cast out of a melee.

Counterspells

Any caster who declares a counterspell will resolve it during the Endphase. Counterspells are restricted to spells that heal or repair damage, extinguish fires, or dispel other magic. Counterspells are cast even if the caster has taken damage or the ship has taken a "Ship Shaken" critical hit.

Concentration

Some spells require concentration to maintain. Any damage to the caster, or any Ship Shaken result, will end the spell immediately.

Targeting Spells

Basic information is given in the spell lists. *Ship* means that the ship is the primary target. *Crew* means that crew sections are the primary target, but that individuals can be affected if they are randomly determined. *Individual* means that the spell will only affect an individual. *Special* usually means several types of targets can be affected.

Enemy individuals cannot be directly targeted unless specifically stated in the spell effect. Large weapons and their crews can be targeted only if caster has a direct line of sight to the position. Even so, the spell has a 50% chance to affect the ship hull and random crew instead.

If a ship has twice the maximum safe crew, all area effect attacks hit twice as many crew sections.

The Spellcaster Record Sheet

A sample spellcaster record sheet appears on page 32. This sheet has spaces to record the spellcaster's name, class and level, ship, and activity for the round.

Below this line is room to keep track of how many spells remain of each level. Before the game, the excess boxes should be blacked in to indicate spell slots that are unavailable. Then, additional boxes are blacked in during play as caster uses the spells.



CHAPTER 9: OPTIONAL RULES

"One of my favorite tactics, is to drop junk behind me for my pursuers to run into."

Oolph, Neogi Archmage

These rules are optional. Players should first learn the basic movement and combat procedures before playing with these expanded rules.

Random Game Set-Up

Both sides roll 1d10. The high roll side sets up first in the center of the board. The other side rolls for distance and direction of his set-up and may choose any facing he desires. Both sides select their starting speeds.

Distance Roll: 10 + 1d6

Table 9-1: Random Set-Up Roll

Roll	Direction
1	Forward
2	Forward Starboard
3	Aft Starboard
4	Aft
5	Aft Starboard
6	Forward Port

Debris

Debris includes destroyed ships and floating missiles, small asteroids, comets, and other space flotsam that can interfere with the movement of ships. Debris of 10 tons or greater will drop ships moving at spelljamming speeds into tactical speeds until the ship is at least 24 hexes away. Debris from demolished ships greater than 10 tons have this effect, too. Debris is marked with a special counter when it appears. Debris damages ships moving through it too fast.

Procedure: Ships entering a hex containing a Debris marker do so at their own risk. Those moving at SR 1 can do so without damage. Those moving through at speeds greater than one suffer damage according to their current speed.

- The ship takes hull damage equal to its current SR minus one.
- Each time a ship takes damage from debris, roll 1d20. If the number rolled is *less than* the ship's current SR, the ship takes an immediate critical hit.

(Example: If a ship moving at SR 9 enters a hex with a Debris marker, it takes eight hull points damage, and the player must roll 1d20. If this number is 8 or less, the ship suffers a critical hit.)

Moving Debris: Sometimes debris will drift one or more hexes a turn. If moving debris enters a hex with a ship, the ship must check as if it had moved into the hex with the debris, using its current SR.

Burning Debris: If debris is burning, a ship taking a critical hit from moving through it takes the "Fire" critical hit as well. The fire lasts 1d6 + 4 rounds. After that, a normal Debris marker is placed in the hex, (unless the ship was wooden, in which case all significant debris is considered destroyed).

Jettison Debris Fields: A jettison (only) can fire at an empty hex to set up a stationary debris field in the hex. (It is assumed that even a light jettison can be overloaded enough

to create a field that is dangerous to spelljamming ships).

The Comet Pieces

There are several comet pieces, representing celestial bodies, in the marker mix. These can be stationary, drift at a constant speed, or even move randomly according to special game conditions. If a ship crashes onto an asteroid, moonlet, planet, comet, or other sizable object (or vice versa), the astronomical body takes no damage. A ship takes crash damage, while missiles (including helms-seekers) impact without effect.

Weapon Specialists

These special crewmen are be assigned to any large weapon. They give the weapon a +1 attack bonus when firing. If a weapon has a specialist, mark the position on the Ship Record Sheet with an asterisk ("*").

Giff serving as bombard crews often have a +1 bonus.

Repairs

Repairs are beyond the scope of this tactical game. However, poorly repaired or maintained ships can be specified by game condition. This increases large weapon chances for inflicting a critical hits by +1 (an Attack Roll of 17 would be an 18). The Magic and Heroic Action options allow for limited repair. In no case can a ship be repaired for more than 20% of its original hull points in one game.

Towing

Ships can tow other ships in some circumstances. The ship with the greatest SR is considered the towing ship, provided its helm can handle the combined mass. For example, an elven Flitter with an SR of 10 can tow a Hammership with an SR of 9. If both ships have equal helms and identical SRs, they are immobile until one of the spelljamming helms is deactivated (they can be separated if either helmsman makes a successful attack roll). Only the stronger of the two spelljamming helms functions while the ships are connected.

Example: A 75-ton ship with a major helm can only tow a ship weighing 25 tons or less, since major helms can move only 100 tons of mass. Likewise, an elven Flitter (10 tons) with a minor helm can only tow 40 tons or less. Within this limit, it is possible for a ship to tow multiple ships. For example, a Flitter with a major helm could tow nine other Flitters!

Crash Ships

Fireships, explosive ships, and similar craft are allowed only by special game condition. Use of these assumes that the opponents are particularly fanatical or desperate. In tactical play without a neutral judge, use of these is by mutual consent only.

Unusual Weapons and Equipment

Accelerator: This magical device taps spelljamming helm energy to shoot a small (1') item at tremendous speed. The accelerator reduces the ship's SR by 1. The device fires twice a round to a range of 4 hexes. Special magical ammunition may be available by special game condition (see *Mage-shot* in the first book of this set).

CHAPTER 9: OPTIONAL RULES

Bombard: These are not safe in the phlogiston, and may not work in some crystal spheres. Their *smokepowder* makes the ship more vulnerable to critical hits. They can use iron shot. Non-turreted bombards with fore-or aft-only fire arcs may get an attack bonus. If available *smokepowder* stores have not been decided before the game, each bombard has enough for 1d6-2 shots. The great bombard has enough for d3-1 shots.

Dual Ballista: This is like a standard ballista, but fires two bolts at once. It can skewer up to two crew members in one volley.

Grapple, Bridge: This is a boarding ramp or tube that attaches to the enemy deck or hull. One or more of these gives a -1 bonus to grappling attempts. These take a full round to disengage at the end of the boarding action.

Greek Fire Projector: This makes its ship more vulnerable to critical hits (+1 to critical hit range). In addition to the damage it causes, greek fire will automatically start a fire on any normal ship it hits. It can't be used in the phlogiston.

Netting: This keeps boarders from inflicting losses until cut away. A net has 1 hit die per 10 tons of its ship (round down). It absorbs damage until it is cut away, and the remaining damage is applied to the defending crew.

Light catapult shots can't penetrate netting. Ballista and jettison shot are unaffected by it. Medium and heavy catapults and bombards can damage netting. Fire attacks damage netting, and greek fire burns it away in 2 rounds.

Shearing Blades: These are special blades, fitted to a ship in order to augment a shearing attack. A ship equipped with these blades has a +2 bonus to its attack roll when shearing. The blades can be destroyed by a "Large Weapon" critical hit. Include them as a large weapon at risk. If they are affected, they are destroyed.

Spell Reflector, Gnomish: This device might reflect any magic cast on or around the host ship back at the source. Roll 1d6 for each spell or effect; on a roll of 1 the spell is reflected, on a roll of 2 it is dissipated, on a 3-6 it takes effect normally. Those on the host ship are also subject to this effect. If a neutral judge is available, special (strange) results are also possible.

Sweeper, Gnomish: This is a variation of a dual ballista. On a successful attack, this will tie up 5 crewmen for the rest of the round. On a natural roll of "20" it will carry away enough rigging to lower the MC of the target by one class.

Tangle Line Gun, Gnomish: This is a light bolt thrower, normally used to fire lifelines to castaways. In combat it functions as a *ballista grapple*. A hit gives a -1 bonus to the normal grappling roll for that round only (see Grappling).

Water Cannon, Gnomish: An exception to the general rule that weapons are not crewed in boarding actions, this weapon is fired just before the enemy rolls his melee attack. A hit means one section of 5 enemies loses its attack roll. A hit on a fire puts out 2d4 points (see Fire section).

Non-Standard Ammunition

Ballista Grapple: These special ballista bolts can be fired only when in the same space as the target. Each hit adds a -1 bonus to the grapple chance for that round only.

Bombard (Iron) Shot: This is special shot made out of iron. When fired from a bombard at a ship's hull, it gives a +2 bonus to the attack roll.

Flaming Arrows: Flaming arrows can only be used when the ships pass so closely that their air envelopes mix. This occurs with attempted rams, shears, grappling, firing passes, etc. Just being in the same hex is not enough.

Flaming arrows inflict normal crew losses. In addition, if at least 10 hit dice of arrows hit in one volley, the attacked ship must save vs. normal fire. Failure inflicts a "Fire!" critical hit.

Helmseeker: These magical missiles for large weapons lock onto and track other ships. When fired, the missile locks onto the nearest ship in its fire arc with a spelljamming engine. Unlike other missiles, it moves only from hex-to-hex, never along a hex side. It moves like a ship with SR 6 and MC A. When it enters the hex of the target ship, an attack at THACO 16 is rolled. If the missile hits, it inflicts damage and is removed. If it misses, it will move toward the next closest spelljamming engine in its forward arc.

In the Large Missile Movement step, the *helmseeker* will again lock on the nearest spelljamming engine in its forward arc (not necessarily the same ship) and move toward it. It can be stopped harmlessly by a debris field or a *wall of force*.

Helmseeker Example: Horsa targets the Mindspider with the *helmseeker* light ballista. The enemy is two hexes away. Horsa takes aim and fires. According to the example given above, Horsa needs to roll a 12 or better on 1d20 to hit his target, but he rolled a 10 and misses.

Horsa takes a Light Ballista marker, and places it on the board where his ship lies, moving it two hexes toward the Mindspider. Since the range of the light ballista is six, he must move it an additional four hexes to expend the missile's SR, targeting on another ship if one exists in the *helmseeker's* forward arc.

If another ship is behind the target and in range of the missile, an attack should be made on that craft as well, even on friendly ships. Be sure to place the missile marker's arrow pointing in its correct facing. Each round, the missile is moved forward its SR during the Large Missile Movement and Hit Resolution phase.)

Stone Shot: This is a special load for a catapult; many small stones for use against enemy crew. It does not harm a ship, but inflicts crew damage like an equivalent jettison. Stone shot that misses will disperse harmlessly. Stone shot cannot be used to lay a debris fields (see Debris).

Sweeper, Super-: This is special magically-enhanced sweeper shot with a shorter range. In addition to the effects of the sweeper, this will inflict a total of 2 hit dice of damage on a crew section. It will not inflict a critical hit.

CHAPTER 10: ADVANCED OPTIONAL RULES

"Anyone could've done it—rigged a sluice to put out the fires, patched up the hull with a few internal bulkheads—as long as the helmsman dodges the rams, we're in good shape."

Dauida Wrenthead, Gnome Mechanic

Heroes

Although player characters are generally assumed to be ship captains in these rules, player characters can take part as individual crew members as a special game condition. This rule admittedly magnifies the effects of player character actions, but it lets all PCs to take part in play. This option is recommended for games with a small number of ships.

Spellcasters always have the option to cast spells, and this prevents them from taking any other actions in the round, including heroic actions.

If a hero wants to affect the operation of his ship, he must commit himself to the task for the entire round during the Announcement phase (some tasks take longer).

Subject to a *Hero roll* the hero can give his ship a +1 on some function during the round.

Procedure: The Hero roll is a 1d10 roll; the PC must roll his level or less on 1d10 in order to succeed. The roll is made during the Announcement phase, in reverse level order. Note that PCs of 10th level and above do not need to roll.

Unless specifically allowed, only one Hero can succeed at a task in a round.

A helmsman, captain (or first officer/acting captain), navigator, or active spellcaster is too busy to be a Hero.

Typical Hero tasks include:

- **Damage Control:** Negates a critical hit on a d10 roll of 1-3 (the hero can try to negate only one critical hit in a round, at the moment it is received). Different heroes can negate different critical hits.
- **Firefighting:** Act as four crewmen to put out a fire. If the Hero roll is missed, act as one.
- **Guardian Duty:** The hero is assigned to guard a specific individual. Any missile or melee hits that would affect the guarded individual hit the PC instead. Area effect spells are not blocked. The hero cannot initiate attacks, but must defend if the guarded individual is attacked in a "Heroic Duel" If the hero falls, any excess damage affects the guarded individual.
- **Heroic Duel:** Engage enemy individual or special (captain, helmsman, officer, etc.) during boarding action. Both sides roll 1d6 and low character loses difference in hit dice. A PC can make up to three throws per round of boarding at his option. Multiple PCs can fight heroic duels, as long as they all attack different enemy individuals.
- **Inspire Crew:** +1 to crew morale rating for round (bards can do this without a Hero Roll).
- **Lead Boarding Action:** -1 THACO bonus to all crew of own ship that are half the hero's level or less.
- **Repair Crew:** PC can fix hull damage; 1 point on a 1d10 roll of 1-3. Total repairs are limited to 20% of hull points.
- **Sailing Task:** -1 bonus to initiative for that round.
- **Sharpshooting:** The hero must have missile specialization or magical weaponry. The hero fires like a whole crew section. A roll of "20" hits the individual of his choice. That individual can save vs. death to

avoid the hit, and if successful the defender decides which individual is hit. Different heroes can shoot at different individuals.

- **Weapon Crew:** +1 bonus to large weapon critical hit chance. One hero per weapon can add this bonus. A hero with proficiency who crewed the weapon during the entire previous loading period adds a -1 THACO bonus also.
- **Work Rigging:** Increase MC one class this turn on a roll of 1-3 on 1d10.

Small Ships

Ships of less than 3 tons play only a minor role in most multi-ship actions. Such small ships tend to operate in groups from a base or mothership. Examples of this type of ship include the elven Flitter, the oriental Locust, the neogi Urchin, the thri-kreen Thorn, and others.

In this game, these ships operate in groups. One Ship Record sheet is prepared for the group (or possibly for all the groups attached to a mothership or base). One playing piece (Squadron marker) is used for each group. Each group is assumed to be one unit for purposes of movement, fire, melee (attack), and morale. However, each ship is considered separately when defending.

Movement: Unless outfitted with helms or the equivalent, small ships are limited to SR 2.

They do not roll for collision when entering a hex with an enemy ship. An enemy ship entering their hex can try to collide with one of them. The small ship can avoid the crash if its helmsman makes a saving throw vs. death, modified for MC (A = +8, B = +6, C = +4, D = +2, E = 0, F = -2).

Assault: If the small ships can move to the larger ship, they can land on it. No collision or grappling roll is necessary. The crews are treated as one crew for boarding, and can join an existing boarding action as well as initiating one.

If the defending ship has not been grappled, and the assaulting small ships do not add too much mass to the defender, the defending ship can move and fire normally as long as enough crew are assigned to fight the small ship attackers at least one-to-one.

Pitch

Pitch is the angle a ship has rotated around its long axis. A ship can be right side up, upside down, or tilted at some other angle. For ease in play, players are limited to four pitch angles: normal, port roll, upside down, and starboard roll (see diagram). Pitch can be changed only while a ship is actually moving; pitch cannot be changed once movement is complete. Changing pitch is without SR cost.

All ships, except those at MC G, can change pitch during the Movement phase of the round. A ship can change its pitch by one angle for every SR point it possesses. This means that if a ship wishes to turn full circle, it needs at least four SR points to do so. Pitch cannot be altered while changing either hex facing or altitude facing, unless the ship's MC is A.

Changing the pitch of a ship allows a damaged ship to point different weapons toward an enemy. Sometimes the ship can turn all its weapons onto its enemy in this manner. A ship might turn its more heavily armored sections to the enemy as well.

CHAPTER 10: ADVANCED OPTIONAL RULES

Random Hit Locations

"The first catapult shot shattered the foremast, and a hail of splinters took out the compass and our navigator."

Captain Icarus, Elven Fleet

Some players and DMs prefer to add flavor and a bit more realism to their games. The following Random Hit

Location table gives many areas an enemy could hit during the course of a battle. Every time a ship is hit, roll percentile dice against Table 10-1 to determine the hit location. Any non-applicable hit location can be considered a hull hit.

All hits still inflict a loss of hull points.

As this table will slow play considerably, it is recommended for battles with only a few ships per side.

Table 10-1: Ship Locations

Die Roll	Location	Die Roll	Location	Die Roll	Location
01	Anchor	35-36	Stern (Aft)	67	Rudder
02	Anchor Cable	37-38	Upper Hull	68-69	Foresail
03-06	Cargo Stores	39-40	Keel	70	Gaffsail
07-08	Food Stores	41	Ladderway	71-72	Jibsail
09	Water Stores	42	Bowsprit	73-77	Mainsail
10-11	Weapon Stores (Personal)	43-44	Foremast	78-79	Spankersail
12	Compass and Hourglass	45-46	Mainmast	80-81	Staysail
13	Crow's Nest	47-48	Mizzenmast	82	Topsail
14-15	Forecastle Deck	49-50	Mess	83-84	Ship's Boats
16-18	Main Deck	51	Chart Room	85-86	Shot Locker
19	Poop Deck	52	Captain's Quarters	87	Shot Stack (or Rack)
20-21	Quarter Deck	53	Carpenter's Quarters	88	Signal Flag Locker
22-23	Frame	54-57	Crew's Quarters (Random)	89	Colors (Ship's flag)
24	Main Hatchway	58	First Officer's Quarters	90-91	Aft Weapon (Random)
25-26	Bow (Forward)	59	Helmsman's Quarters	92-93	Bow Weapon (Random)
27-28	Lower Hull	60	Navigator's Quarters	94-95	Port Weapon (Random)
29-30	Port Hull	61	Officer's Quarters	96-97	Starboard Weapon (Random)
31-32	Starboard Hull	62-63	Ram	98-99	Underside Weapon (Random)
33-34	Stem	64-66	Rigging (Random)	00	Wheel, Ship's

Convention Games

Games set up for game conventions will have special requirements. First, these games will tend to have more ships in play than private games. Second, many of the players will not be familiar with the rules.

The keys to success with this type of game are: 1) keep it simple, 2) prepare all materials in advance, and most of all 3) keep it simple.

Convention games should be tested for balance before being put on in public.

Ship Squadrons

Convention game movement and combat is by ship *squadron*. Each ship in a squadron must stay within three hexes of at least one other ship in the squadron. The squadron flagship is usually the largest ship in the squadron. If the flagship is disabled or destroyed, the next largest ship takes over.

Each squadron should complete its movement and fire before the next squadron begins.

Play will run more smoothly if the ships in a squadron have the same basic performance: MC and SR.

Turn Sequence

1. The squadron commanders roll initiative for their squadrons. Ignore all initiative roll modifiers.
2. Movement is in order from highest roll to lowest.
3. The first squadron to move does so, and may fire large weapons only.
4. The second squadron to move does so, and may fire large weapons. In addition, he can ram and conduct magic and small missile fire against ships of the first squadron if he wishes.
5. Play continues with each squadron in turn, each able to ram and conduct magic and small missile fire against those who have moved before.

Players without initiative can return magic, small missile, and boarding attacks immediately after being attacked by those with the initiative.

CHAPTER 11: RULES FOR 3-D PLAY

"Orcs think on the flat. If you go up or down, you can usually outmaneuver them."

Captain Icarus, Elven Captain

Three-Dimensional Movement

This optional game system takes the full three dimensions of space combat and movement into account. A series of easy tables and charts are used to simplify 3-D movement. The DM should feel free to add and delete rules as they see fit. Unless otherwise noted, all the rules from the two-dimensional game are carried over into the three-dimensional game.

Note: Tracking missiles is difficult in 3-D, and not recommended for your first 3-D games. Even *helmseekers* should be used sparingly.

Altitude

The three-dimensional game adds *altitude* to play. Picture the mapsheet as a 3-D volume, one hex-width thick. Now picture many layers of such mapsheets, so that they make up a three-dimensional volume of space as tall as the mapsheet is wide. Gaining altitude means moving to a higher level sheet; losing altitude means moving to a lower level sheet.

The Zero Field: The "zero field" is an arbitrarily placed center plane (the two-dimensional map) from which a ship's altitude is figured.

Marking Altitude: Included in the boxed set is a card containing square chits with the numbers -20 through +20 on them. These chits are used to show the ship's relative height above or below the zero field. It is possible to go more than 20 "hexes" above or below the zero field. If this happens, the DM or the players should make up their own blank markers.

Definitions: A few new definitions come into play with the three-dimensional game: climb, dive, and pitch.

Climb is movement to a higher altitude level by pointing the bow up.

Dive is the movement to a lower altitude level by pointing the bow down. (If moving in reverse, the stern points up to climb and down to dive).

Pitch is the roll of a spelljamming ship as it rotates to fly upside down or with its deck turned to either side.

Maneuverability Class in 3-D

As in the two-dimensional game, the MC determines the ship's ability to make hex face changes. A ship may move one space or change its facing direction by one hex at the cost of one SR point. For example, a ship with an SR of three can move one hex, face in a new direction, then move another hex; move three hexes in a straight line; move two hexes, then turn one hex side; etc.

Altitude Facing

The direction a ship points with respect to gaining or losing altitude levels is called its *altitude facing* (also called its *octagonal facing*). In the three-dimensional game the

facing that a ship has in the zero plane is called its *heading*.

A ship can always change its heading or its altitude facing at the end of its movement round by one hex side for free, in addition to any other facing changes, unless the ship's MC is G. When a ship changes direction, it uses one SR for every hex side or octagonal side it turns. The MC of the ship affects when and how often the ship can change facing:

Ships of MC G have only a slight chance (30%) of changing facing (either type) by one hexside at the end of the round. They must move into the hexes they face at the beginning of the round. They change SR by one (ships with major helms can alter their SR as normal).

Ships of MC F always move one hex forward before making any change. They can change heading or altitude facing by one hex side only. The change costs one SR point. The ship cannot change both its 2-D heading and its 3-D altitude facing in the same hex.

Ships of MC D and E can change heading or altitude facing by one hex side (only) per hex moved. Each change costs one SR point. The ship cannot change its 2-D heading and its 3-D altitude facing in the same hex.

Ships of MC B or C can change heading or altitude facing up to two hex sides in a single hex. Each single- or double-hex facing change performed costs one SR point. The ship can change its 2-D heading by two, its 3-D altitude facing by two, or it can change each facing by one.

Ships of MC A can change heading and altitude facing instantly and at will, even 180° backwards. The ship does not expend SR to change facing.

Helpful hint: Organizing all the altitude markers into stacks of the same altitude level before the game will speed play. Counter trays, utility boxes, or a flat box with separate compartments can be bought or constructed for this purpose.

When starting play, place the ships at altitude 0 (zero) to allow maximum maneuver room, unless other special conditions prevail. The altitude chits can be placed near the ships, so everyone can see what level the ships are on.

Changing Altitude

Ships have eight "Altitude" facings. The eight-sided diagram shows these eight movement possibilities. Next to each of these octagonal facings, two numbers (separated by a comma) are given. The first number is the number of hexes the ship moves as in two-dimensional movement when traveling this octagonal facing. The second number is added to or subtracted from the ship's altitude relative to the zero field (altitude zero).

Example: If a ship was moving in altitude direction B, it would move forward one hex and climb one hex for every SR point used in forward motion; a ship moving in direction C moves no hexes forward, and climbs one hex for every SR point; etc.

It is possible for a ship to change facing from A, to B, to

CHAPTER 11: RULES FOR 3-D PLAY

Table 11-1: Altitude Movement

Direction	3-D Movement with 1 SR point
A	Move forward one space, no altitude change.
B	Move forward one space, climb one level.
C	No forward movement, climb one level.
D	Move backward one space climb one level.
E	Move backward one space, no altitude change.
F	Move backward one space, dive one level.
G	No forward movement, dive one level.
H	Move forward one space, dive one level.

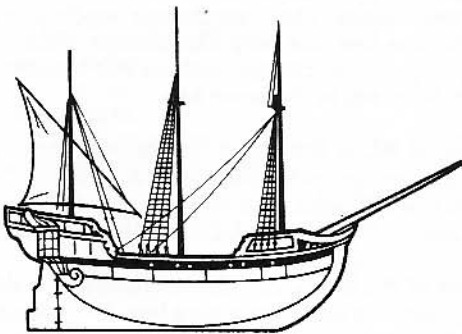

**PITCH
(Aft View)**

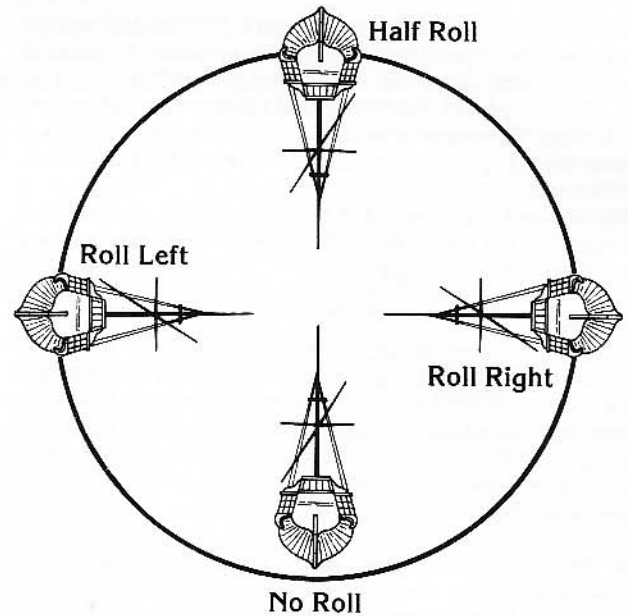

C, to D, and finally to E. This leave the ship traveling in the opposite direction and upside down. While doing this, the ship could change its pitch (see Pitch), to roll right side up. The same ship could, instead, choose to move (vertically) from facing A to E, following an A-to-H-to-G-to-F-to-E path instead; ending up with the same result.

Three-Dimensional Combat

Much like the 2D game, weapons have a limitation to their firing capabilities. These limitations are given as Fire arcs: areas that the weapon can accurately fire into. These arcs should be adhered to closely, as many captains of lesser-armed ships have successfully destroyed greater ships by clinging to the enemy ship's weakly armed sides.

Fields of Fire

The fields of fire in three-dimensional combat are more complex than those for the two-dimensional game. Mounted weapons that allow firing in all directions in 2-D do not necessarily have the same unlimited scope in the 3-D game.

- Fixed, forward-firing weapons mounted on the ship's deck can also fire in the Forward-Top fire arc.
- Fixed, forward-firing weapons mounted on the ship's bottom can also fire in the Forward-Bottom fire arc.
- Fixed, port-facing weapons can only fire in the port fire arc.
- Fixed, starboard-facing weapons can only fire in the starboard fire arc.
- Fixed, aft-firing weapons mounted on the ship's deck

can also fire in the Aft-Top fire arc.

- Fixed, aft-firing weapons mounted on the ship's bottom can also fire in the Aft-Bottom fire arc.
- Turret-mounted deck weapons can fire in all directions along the gravity plane of the ship or in the top arc. They can fire aft, forward, port and starboard, except where obviously blocked by the ship's configuration. The top arc includes all hexes above the ship's gravity plane.
- Turret-mounted weapons on the bottom of the ship can fire in all directions along the gravity plane of the ship or in the bottom arc. They can fire aft, forward, port and starboard except where obviously blocked by the ship's configuration. The bottom arc includes all hexes below the ship's gravity plane.

The possible fire arcs are given on Table 11-2.

Table 11-2: 3-D Fire Arcs

Arc	Designation
A	Aft arc
AT	Aft-Top arc
AB	Aft-Bottom arc
B	Bottom arc
F	Forward arc
FB	Forward-Bottom arc
FT	Forward-Top arc
P	Port arc
S	Starboard arc
T	Top arc

THREE-DIMENSIONAL FIRE ARCS

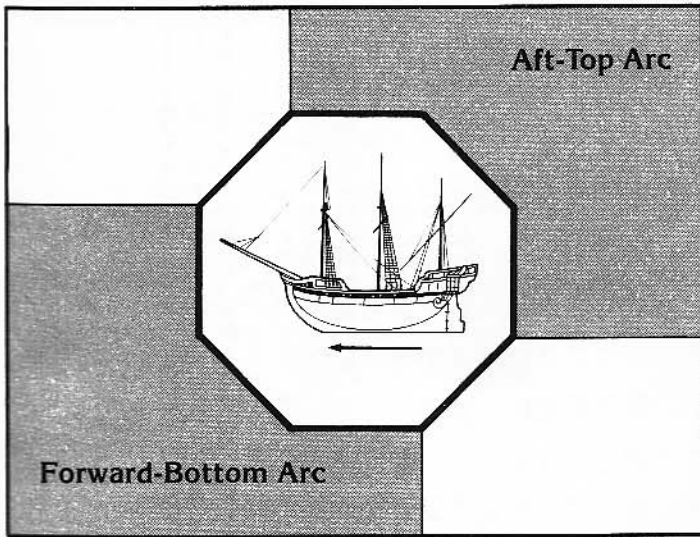

Side View

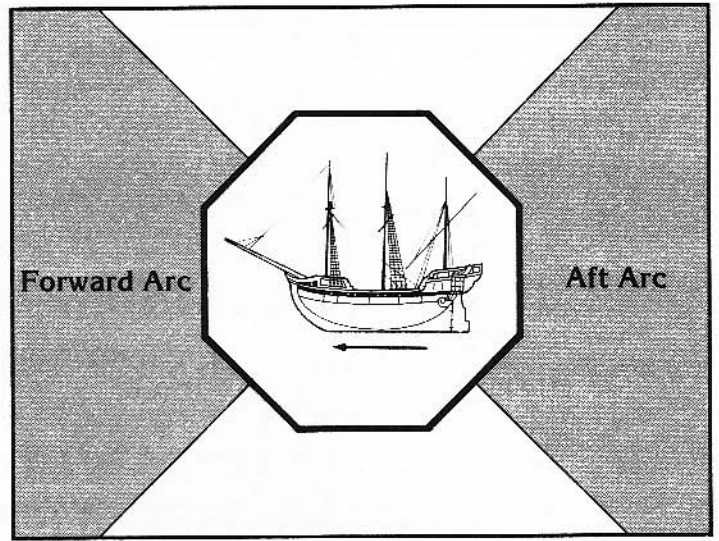

Side View

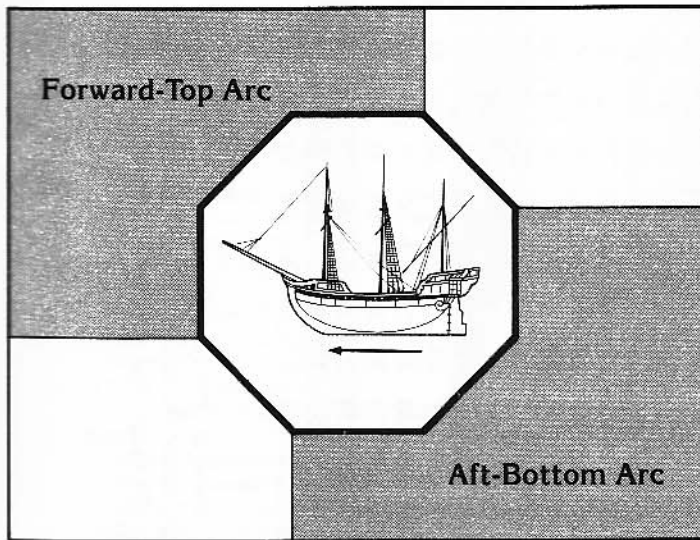

Side View

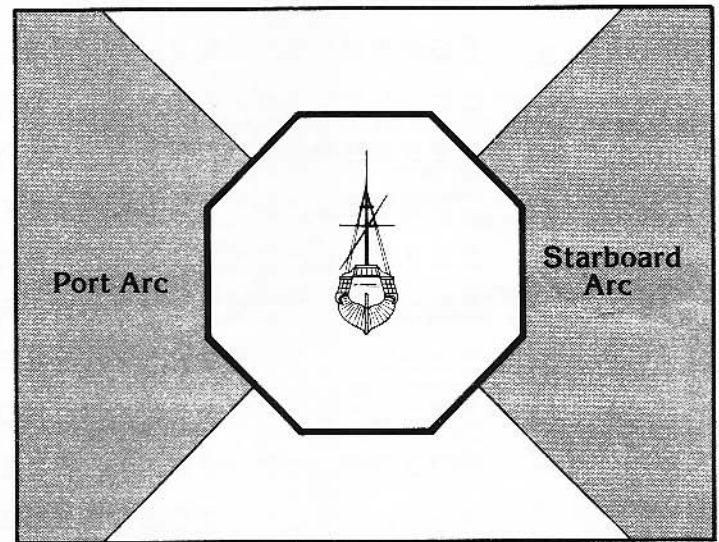

Aft View

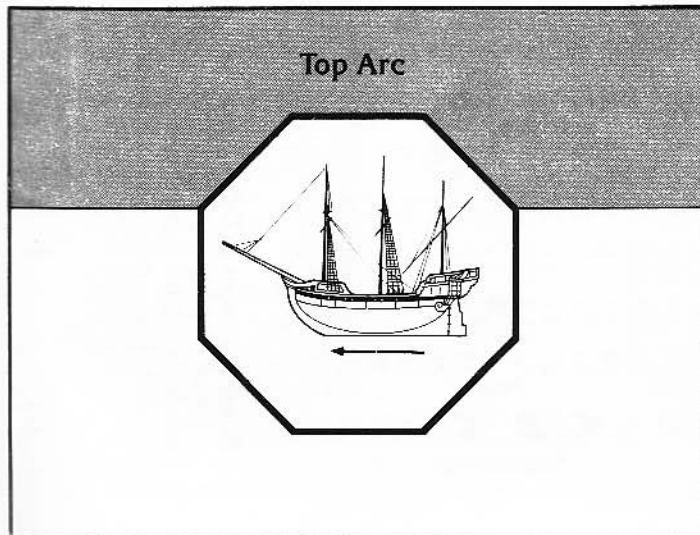

Side View

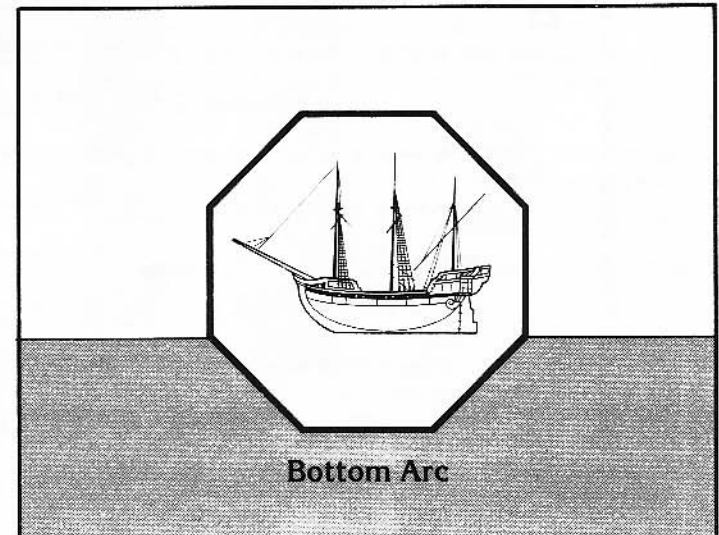

Side View

Table 11-3: Three-Dimensional Distances

DISTANCE ABOVE OR BELOW

D	I	S	T	A	N	C	E	A	W	A	Y																			
0	1	2	3	4	5	6	7	8	9	10	11	12	13	14	15	16	17	18	19	20	21	22	23	24	25	26	27	28	29	30
0	1	2	3	4	5	6	7	8	9	10	11	12	13	14	15	16	17	18	19	20	21	22	23	24	25	26	27	28	29	30
1	2	3	4	5	6	7	8	9	10	11	12	13	14	15	16	17	18	19	20	21	22	23	24	25	26	27	28	29	30	
2	3	4	5	6	7	8	9	10	11	12	13	14	15	16	17	18	19	20	21	22	23	24	25	26	27	28	29	30		
3	4	5	6	7	8	9	10	11	12	13	14	15	16	17	18	19	20	21	22	23	24	25	26	27	28	29	30			
4	5	6	7	8	9	10	11	12	13	14	15	16	17	18	19	20	21	22	23	24	25	26	27	28	29	30				
5	6	7	8	9	10	11	12	13	14	15	16	17	18	19	20	21	22	23	24	25	26	27	28	29	30					
6	7	8	9	10	11	12	13	14	15	16	17	18	19	20	21	22	23	24	25	26	27	28	29	30						
7	8	9	10	11	12	13	14	15	16	17	18	19	20	21	22	23	24	25	26	27	28	29	30							
8	9	10	11	12	13	14	15	16	17	18	19	20	21	22	23	24	25	26	27	28	29	30								
9	10	11	12	13	14	15	16	17	18	19	20	21	22	23	24	25	26	27	28	29	30									
10	11	12	13	14	15	16	17	18	19	20	21	22	23	24	25	26	27	28	29	30										
11	12	13	14	15	16	17	18	19	20	21	22	23	24	25	26	27	28	29	30											
12	13	14	15	16	17	18	19	20	21	22	23	24	25	26	27	28	29	30												
13	14	15	16	17	18	19	20	21	22	23	24	25	26	27	28	29	30													
14	15	16	17	18	19	20	21	22	23	24	25	26	27	28	29	30														
15	16	17	18	19	20	21	22	23	24	25	26	27	28	29	30															
16	17	18	19	20	21	22	23	24	25	26	27	28	29	30																
17	18	19	20	21	22	23	24	25	26	27	28	29	30																	
18	19	20	21	22	23	24	25	26	27	28	29	30																		
19	20	21	22	23	24	25	26	27	28	29	30																			
20	21	22	23	24	25	26	27	28	29	30																				
21	22	23	24	25	26	27	28	29	30																					
22	23	24	25	26	27	28	29	30																						
23	24	25	26	27	28	29	30																							
24	25	26	27	28	29	30																								
25	26	27	28	29	30																									
26	27	28	29	30																										
27	28	29	30																											
28	29	30																												
29	30																													
30																														

Firing Distances in 3-D

Chart 11-3 shows the true distances between ships at different altitudes. To find the exact distance between two ships, count the number of hexes between them on the mapsheet, including the target but not the

firer. Find the difference in their altitudes (e.g., if Ship A is at altitude -12, and Ship B is at altitude -6, their altitude difference is 6). Cross-reference the numbers on Table 8-2 to find the actual distance between the ships.

CHAPTER 12: DEFINITIONS

A is the aft fire arc.
AB is the Aft-Bottom arc used in the 3-D game.
Aft is the back end of a ship.
Air Envelope is the atmosphere that surrounds any object large enough to have a gravity plane (or gravity well if a planetoid). Air envelopes are necessary for air-breathing creatures to live in space.
Altitude Facing determines the ship's height and 3D traveling direction from the playing field. Markers included in the boxed set are used to show the ship's placement.
AP is the Aft and Port fire arc.
APS is the Aft, Port and Starboard fire arc.
AR (Armor Rating) for a ship determines how difficult it is to hit. Lower numbers are better. AR is like Armor Class in the AD&D® game system.
AS is the Aft and Starboard fire arc.
Arcane are a race of blue-skinned giants that first introduced the spelljamming technology to humans and demihumans of the Prime Material Plane.
AT is the Aft-Top fire arc, used in the 3-D game.
B is the bottom fire arc, used in the 3-D game.
Beam is the width of a ship from starboard to port. This measurement is the ship's widest girth.
Bow is the front end of a ship.
Bowsprit is the spar (small mast) extending forward from the bow of the ship. Often sails or ornamentation clings to this spar.
Cargo Space is the amount room a ship has free to carry things (excluding crew members). Cargo space is a volume measured in tons.
Crashing is an unavoidable and uncontrolled descent upon a larger object.
Crow's Nest is a small platform near the top of the mainmast that allows a lookout to see farther than a person on the deck.
Crystal Sphere is the huge, unbreakable shell that surrounds a planetary system. It separates the outer phlogiston from the wildspace within.
F is the Forward fire arc.
FB is the Forward-Bottom arc, see the 3-D game.
Forecastle is the section of the deck that is behind the bowsprit and in front of the foremast.
Foremast is the forward-most mast on a ship that has two or more masts.
Foresail is the main sail carried by the foremast.
FP is the Forward and Port fire arc.
FPS is the Forward, Port, and Starboard fire arc.
FS is the Forward and Starboard fire arc.
Gaff Sails a series of triangular sails set over a gaff (a fore-and-aft spar).
Gravity Plane is the plane of attraction that passes through a ship. In Fantasy Space, gravity usually occurs at the center of the ship and parallel to its keel, or in *the most convenient manner*. The DM or judge has final say on the ship's gravity plane placement if any disagreement arises.
Greyspace is the WORLD OF GREYHAWK® campaign solar system.
Helm is a generic term used to refer to the magical engines that propel spelljamming ships through wildspace and the phlogiston.
Helmseeker is a ballista bolt, bombard shot, etc., that is magically enchanted to seek out and damage the nearest spelljamming ship within its forward arc.
Helmsman is the priest or wizard character who operates the spelljamming helm. The helmsman is the source of the magical energy needed to move the ship.
Hex Side is one of the six line segments that define a hexagonal movement space. Ships always face a hex side.
HP (Hull Points) are a measure of how much damage a spelljamming craft can take. Ships start with hull points equal to their tonnage. In AD&D game terms, one hull point equals roughly 10 hit points.
Initiative in space combat allows a ship to move later in the turn and attack first in combat. These are both substantial advantages.
Jib Sails are triangular sails that stretch from the jibboom (a spar

extending from the bowsprit), connecting the foremast with the bowsprit.

Keel Length is the long dimension of a ship, usually from bow to stern (or aft).

Krynnspace is the DRAGONLANCE® campaign solar system.

Mainmast is the principle, central, and usually the tallest of the ship's masts.

MC (Maneuverability Class) refers to the tactical maneuverability of the craft. This is a factor depending on sails, rigging, crew quantity, and overall design. MC A is the best maneuverability, whereas MC G is the worst.

Mess is the ship's kitchen and often the dining area as well.

Mizzenmast is usually the third, or last, mast on the large sailing craft. Often, it is called the jigger mast as well.

P is the Port fire arc.

Phlogiston is the magical, rainbow-colored ocean of violently unstable currents that surround the crystal spheres.

Pitch is the degree of rotation a spelljamming ship makes about its fore-to-aft axis. The pitches are: normal, rolled port, rolled starboard, and upside down.

Poop Deck is the aft-most deck on the ship, behind the mizzenmast. Often, it is raised slightly, but just as often, it is not.

Port is the left side of a ship.

Quarter Deck is a deck usually reserved for high ranking officers in the stern of the ship.

Realspace is the FORGOTTEN REALMS® campaign solar system.

Rigging is the system of ropes, tackle, (often chains) that supports, controls and holds the sails in place.

Rudder is a vertically-aligned piece of material made from wood, metal, crystal, bone, etc., that helps control the facing of a spelljamming ship. On many groundling ships, the loss of the rudder reduces the MC of the craft by one step.

S is the Starboard fire arc.

Signal Flags is a set of 50 flags, (26 separate flags depicting a letter of the alphabet) used for long-distance signalling.

Spanker Sails are quadrilateral gaff sails that connect the mizzenmast with the lateral aftsprit.

Spelljammer Shock is a critical hit result that causes the spelljamming helmsman to fall into a coma for one to four days.

Spelljamming is the conversion of magical energy into motive force. This is the principle upon which all spelljamming craft are based.

Spelljamming Speed equates to 100 million miles per day. This is the speed by which ships equipped with spelljamming helms move from planet to planet and from one crystal sphere to another.

SR (Ship Rating) is a reflection of the ship's speed and relative power. A ship with a high SR moves faster and farther and a ship with a lower SR.

Starboard is the right side of a ship.

Stay Sails are hoisted between the mainmast and the foremast.

Stem is the upward-curving beam at the bow of the ship to which the hull planking is attached.

T is the Top fire arc, used only in the 3-D game.

Tactical Speed is a slower speed used near planets and other celestial bodies. Tactical speed is determined by the spelljamming engine and the level of the helmsman.

THACO is the lowest roll needed on a 1d20 die throw to hit a target with Armor Class (or Armor Rating) 0.

Top Sails are square sails positioned at the topmost sections of the mainmast, foremast, and mizzenmast.

Towing is a process by which a ship can pull another by using ropes, chains, or cables. Any ship can tow another, as long as the tonnage maximum of the helm used by the tower is not exceeded.

Wildspace is the airless void (known as "space") contained within the crystal spheres.

Zero Field is a term used in the 3D game. It is the plane of movement at Zero Altitude. It is generally placed in a central location; often 10 to 20 "hexes" above the surface of a ship or asteroid base.

APPENDIX: WIZARD SPELLS

Name	Level	Area	Effect
Feather Fall	1st	Special	Eliminates the velocity of one incoming large missile (including jettison shot), removing it from play as ineffective (no attack roll).
Magic Missile	1st	Special	Inflicts 1-5 HD damage (divide caster level by two) to an individual or a crew section. Cannot inflict hull damage.
Mend	1st	Ship	Mage has a 50% chance to restore 1 hull point of wood or ceramic. Not subject to dispel when completed. Total repairs cannot exceed 20% of original hull points.
Phantasmal Force	1st	Crew	Phantasm draws one attack of caster's choice each round until it takes 1 HD damage or caster ceases concentration.
Shield	1st	Caster	Negates enemy <i>magic missiles</i> , adds +1 to saving throws. Reduces missile and melee hits by 1 HD (to minimum of 1).
Wall of Fog	1st	Own Ship	Affects 5 tons, plus 5 tons per caster level. Creates obscurement, all missile fire (both ways, except <i>helmseekers</i>) is at -4 for 2-8 rounds + 1 rnd/level. Freshens air when cast. Partial effect is -2 and one step of freshening.
Continual Light	2nd	Special	Counters <i>darkness</i> . If opponent has a light penalty, this spell has special effects: it can be cast against large weapons to inflict the penalty; in boarding actions it will affect 1-3 enemy crew sections in each round (check each round). Can be dispelled or countered by <i>darkness</i> .
Darkness	2nd	Crew	Crew section of caster's choice is blinded (-4 penalty to attack roll). Countered by <i>continual light</i> .
Fog Cloud	2nd	Own Ship	Affects 10 tons per caster level. Creates obscurement, all missile fire (both ways, except <i>helmseekers</i>) is at -4 for 4 rounds + 1 rnd/level. Freshens air when cast. Partial effect is -2 or one step of freshening.
Imp. Phant. Force	2nd	Crew	Phantasm draws up to two simultaneous attacks of caster's choice each round. Phantasm is destroyed when it takes 2 HD damage. Lasts up to 2 rounds after caster ceases concentration.
Melf's Acid Arrow	2nd	Special	<i>Individual</i> : Inflicts 1 HD + 1 HD damage per 3 caster levels. <i>Hull</i> : Inflicts 1 HP per 3 HD of individual damage (round down, ceramic hulls are immune). A priest casting <i>create water</i> will reduce damage to 1 HD/0 HP.
Mirror Image	2nd	Caster	Creates 2-8 images (1 + 1/3 caster levels, to 8 total). Each image takes 1 HD damage. Caster takes no damage until all images destroyed. Note that an area effect will destroy all images and damage the caster.
Pyrotechnics	2nd	Fire	<i>Blind</i> : 1-3 enemy crew sections save vs. spells or be -4 to hit for 1d4+1 rounds. <i>Extinguish fire</i> : automatic, but air becomes one step fouler, creating obscurement as fog (-4 when firing or being fired at).
Scare	2nd	Crew	Affects 1-3 crew sections. Those under 6 HD lose one round of actions but fight if meleed, and are -1 to hit and saves.
Stinking Cloud	2nd	Crew	Affects 1-2 sections, save vs. spells or incapacitated. Fouls air if ship is 10 tons/caster level or less. Can be dispelled. Lasts 1 rnd/caster level.
Web	2nd	Crew	Affects 1-3 crew, save vs. spells or trapped (burn free for 1 HD damage each or can <i>dispel</i>). Can be used to give -1 bonus to grappling roll.
Dispel Magic	3rd	Special	Counters any magic lasting beyond the round of casting. Own magic can always be dispelled, otherwise roll 11 or better on 1d20 to succeed. Adjust roll by 1 per caster level: up if the dispeller is higher, down if the dispeller is lower. Dispel is useful for clearing fog, magical walls, webs, etc.
Fireball	3rd	Ship	Inflicts 1 HP per 3 caster levels to maximum of 4 HP. If save vs. magical fire is made, one crew section takes 1 HD per caster level to each individual in section (maximum of 10 HD each, save for half). If save failed, 1-3 crew sections are affected and ship is on fire.
Gust of Wind	3rd	Ship	Disperses fog, smoke, and <i>stinking cloud</i> . Does not affect air freshness. Can raise MC by one step (maximum of MC C) for a round.
Haste	3rd	Crew	Affects 1-3 crew sections or equivalent individuals (maximum 1 section per 5 caster levels). Affected crew gains double actions for 3 rounds + 1 rnd/caster level. In campaign situations, this spell will use up air faster and lower crew morale (each use shortens their lifespans).
Hold Person	3rd	Special	Affects one individual or crew section. Works on any human or demihuman, or if both humanoid and under 4 HD. Save vs. spells at -3 or incapacitated 2 rounds/caster level. Can be countered by <i>dispel magic</i> .
Lightning Bolt	3rd	Special	<i>Crew</i> : Against crew section of attacker's choice, it inflicts 1 HD per caster level to each crewman in section (maximum 10 HD each, save vs. spell for half). <i>Hull</i> : Inflicts 1 HP per 3 caster levels. If ship fails a save vs. lightning, 1 random crew section is hit.
M.'s Minute Meteors	3rd	Special	Ship must save vs. magical fire or take a fire critical hit. Also, caster rolls a missile attack against crew section of choice at +2 bonus, a hit inflicts 5 HD damage.
Prot./Norm. Missiles	3rd	Individual	Individual is protected from normal small missiles for game.
Slow	3rd	Crew	Affects 1-3 crew sections. Affected sections can take one action per two rounds if the saving throw vs. spells is failed. Duration is 3 rounds + 1 round/level. A save vs. spells is allowed at -4.

APPENDIX: WIZARD SPELLS

Name	Level	Area	Effect
Spectral Force	3rd	Crew	Phantasm draws up to three simultaneous attacks of caster's choice each round. Phantasm is destroyed when it takes 3 HD damage. Last up to 3 rounds after caster ceases concentration.
Wind Wall	3rd	Own Ship	Protects one hex side per 5 caster levels (round down) from small missile attacks for 1 rnd/level. Arrows and bolts miss, sling stones and bullets are -2 to hit.
Confusion	4th	Crew	Affects 1-3 crew sections. Save vs. spell at -2 for each section to negate. Affected sections incapacitated for 2 rounds + 1 rnd/caster level.
Emotion	4th	Crew	Affects 2 friendly or 2 enemy sections. An enemy save vs. spell negates. <i>Hope</i> : +2 bonus to attack and saves. <i>Courage</i> : Poor morale becomes good (if good add +1 to attack roll, and get 5 HD bonus per section, which is lost before section takes damage). Courageous sections take losses first in boarding. <i>Hopelessness</i> : 50% chance of surrender, 50% chance of no action at all; takes casualties last in boarding.
Fumble	4th	Crew	<i>Weapon Crew</i> : Cannot fire or reload unless save vs. spell. <i>Boarding</i> : 1-3 enemy sections must save each round in order to attack. Friendly crew must also save to attack affected enemy sections. Duration: 1 rnd/level.
Ice Storm	4th	Crew	Affects 1-3 crew sections; take 4 HD damage per crewman, no save.
Mn. Globe of Invuln.	4th	Caster	Confers immunity to 1st-3rd level spells. Can be <i>dispelled</i> . Duration is 1 round/level.
Wall of Ice	4th	Own Ship	This wards one hex side of own ship from missile, spell, and boarding attacks. Small missiles are blocked. Against other attacks, the wall has 1 HD per two caster levels. The crew takes no missile or melee damage from the protected side until the wall is destroyed. Each <i>wall of ice</i> reduces MC by one step. Can be used as <i>icestorm</i> , instead.
Advanced Illusion	5th	Special	Phantasm draws the first three large missile, magic and melee attacks against the caster's ship in the round. Phantasm is destroyed when it takes 5 HD damage. It will last 1 round per caster level otherwise.
Cloudkill	5th	Special	This short range spell can be used only when ramming, shearing, or grappling, and after longer ranged attacks have been resolved. No boarding action is fought. The cloud affects 1d4 + 1 crew sections each round. Crew members under 4 HD die, 4 HD to 6 HD save vs. poison or die, over 6 HD take 1 HD per round damage. Air is rendered foul until entire crew has been affected, at which time it becomes deadly. The poison remains until <i>dispelled</i> .
Fabricate	5th	Own Ship	Caster can restore 1 hull point of wood or ceramic, or 50% chance of restoring 1 point of metal or stone in one round. Requires concentration. Maximum duration is 1 rnd/level. Maximum total repair is 20% of hull points. When completed, this repair is not subject to <i>dispel</i> .
Feeblemind	5th	Individual	Wizard must save vs. spells at -4 or lose all spell abilities. Clerics save at +1. Monsters and multi-class characters save at -2.
Wall of Force	5th	Special	Can be created in caster's hex to stop enemy ships (caster must save vs. spells to position properly). Enemy ship stops if tonnage greater than caster level (current SR becomes 0), otherwise it crashes. Wall lasts 10 rounds + 1 round/level.
Wall of Iron	5th	Own Ship	This can be created in the caster's hex to stop enemy ships (caster must save vs. spells to position it properly). Ships whose tonnage exceed the caster's level stop (current SR reduced to 0), those of lesser tonnage crash. If used to repair a metal ship, ship regains 1 hull point per caster level. Each <i>wall of iron</i> reduces MC by one step. Such repair is temporary and subject to <i>dispel</i> .
Wall of Stone	5th	Own Ship	Useful on stone ships to repair damage, 1 hull point per caster level. Such repair is temporary subject to <i>dispel</i> .
Chain Lightning	6th	Crew	Inflicts 12 HD (total) to a crew section (no save). Save vs. spell or another section is affected, continuing until a save is made or six sections have been hit (hit sections are determined randomly). If all crew are slain without saving, the remaining spell energy attacks the caster's crew.
Death Spell	6th	Crew	Kills 40 HD of crew under 9th level. Low hit dice die first. Creatures of 4-6 HD count 10, those of 7-8 HD count 20. Ignore partial effects. Slain creatures cannot be <i>raised</i> .
Disintegrate	6th	Special	<i>Crew/Individual</i> : One individual must save vs. spell or be destroyed. <i>Large weapon</i> : 50% chance to hit weapon (save vs. disintegrate), otherwise hit the hull. <i>Hull</i> : Save vs. disintegrate or take 1d4 HP and a Ship Holed critical.
Globe of Invuln.	6th	Caster	Confers immunity from 1st-4th level spells for 1 round/caster level.
Delayed Blast F.B.	7th	Ship	Inflicts damage as a <i>fireball</i> , with one additional hull point or 2 HD of damage inflicted.
Finger of Death	7th	Individual	Save vs. spell or die. If save successful, target takes 3 HD damage anyway.
Mass Charm	8th	Crew	Affects 1-3 sections. Must save vs. spell at -2 or become allies of the caster. Hit dice affected cannot exceed twice caster's.
Meteor Swarm	9th	Ship	Inflicts 32 hull points (save vs. magical fire for half). If the save is failed, there are 1-4 fires, and the crew takes 24 HD damage to each individual in 1 crew section, plus 12 HD to each individual in 1-2 other crew sections, plus 6 HD damage to each individual in 2-4 additional crew sections. Each section receives a saving throw vs. spell for half damage.

APPENDIX: PRIEST SPELLS

Name	Level	Target	Effect
Bless	1st	Crew	Raises crew morale by +1. Two crew sections receive +1 to attack rolls and saving throws vs. fear. Noncumulative with other bonuses.
Cure Light Wounds	1st	Crew	Heals 1 HD damage. Can be used to prevent death of a 1 HD crewman.
Create Water	1st	Special	Puts out a fire. Counters <i>Melf's acid arrow</i> .
Endure Cold/Heat	1st	Individual	Pick type of protection when cast. Absorbs up to 3 HD of damage type when protected creature would be affected. Applies after saves. Protection ends when it prevents any damage.
Aid	2nd	Indiv.	Individual is +1 to attack and save. First HD of damage taken after receiving this spell is ignored. Duration 3 rounds + 1 rnd/level.
Chant	2nd	Special	Must chant two rounds, effect starts the third. Crew receives a +1 to attack and save; a boarding enemy crew has a -1 penalty to both. Lasts while caster concentrates. This can be cumulative with <i>prayer</i> .
Hold Person	3rd	Special	Affects one individual or crew section. Works on any human or demihuman, or if both humanoid and under 4 HD. Save vs. spells at -3 or incapacitated 2 rounds/caster level. Can be countered by <i>dispel magic</i> .
Obscurement	2nd	Own Ship	Creates obscurement, all missile fire is at -4. Freshens air completely at 10 tons/caster level; partial coverage freshens air one step.
Resist Fire/Cold	2nd	Individual	Adds +3 to save vs. that type of attack and reduces damage by half.
Silence, 15' radius	2nd	Special	Affects an individual or 1-3 sections. Prevents spellcasting and sound-based attacks.
Warp Wood	2nd	Weapon	Wooden weapons can be disabled by caster level: 1-4 = small, 5-8 = light, 9-12 = medium, 13+ = heavy. Causes no hull damage.
Continual Light	2nd	Special	Counters <i>darkness</i> . If opponent has a light penalty, this spell has special effects: it can be cast against large weapons to inflict the penalty; in boarding actions it will affect 1-3 enemy crew sections in each round (check each round). Can be dispelled or countered by <i>darkness</i> .
Dispel Magic	3rd	Special	Counters any magic lasting beyond the round of casting. Own magic can always be dispelled, otherwise roll 11 or better on 1d20 to succeed. Adjust roll by caster level; up if the dispeller is higher, down if the dispeller is lower. Dispel is useful for clearing fog, magical walls, webs, etc.
Prayer	3rd	Crew	Affects entire crew, +1 to attack rolls and saving throws. Boarding enemies are -1 to both. Duration 1 rnd/caster level. Cumulative with <i>chant</i> by caster of same religion.
Pyrotechnics	3rd	Special	<i>Blind</i> : 1-3 enemy crew sections save vs. spells or be -4 to hit for 1d4+1 rounds. <i>Extinguish fire</i> : successful, but makes air one step fouler, creating obscurement as fog (-4 when firing or being fired at).
Stone Shape	3rd	Ship	Can be used to repair 1 hull point damage to a stone ship only. The maximum possible repair is 20% of original hull points.
Cure Serious Wounds	4th	Crew	Heals 2 HD damage. Can be used to prevent death of a 1-2 HD crewman.
Free Action	4th	Individual	Makes individual immune to <i>hold</i> , <i>web</i> , and <i>slow</i> spells.
Produce Fire	4th	Special	Causes 1 HD + 1 HD per four caster levels to a crew section, ship must save vs. normal fire or catch on fire. <i>Quench</i> : This reversal of the spell puts out a fire automatically.
Protection from Evil, 10' radius	4th	Crew	Keeps out summoned or enchanted monsters; evil opponents have a -2 attack roll penalty. Protected characters have +2 to saves vs. evil attacks.
Control Winds	5th	Own Ship	Gives the caster the ability to increase his ship's MC in the phlogiston by one step on any round the caster performs no other action. For tactical purposes, this ability is permanent until dispelled.
Cure Critical Wounds	5th	Crew	Heals 4 HD damage, as other cures.
Dispel Evil	5th	Caster	Banishes summoned or extraplanar evil creature if caster hits in melee. Subject creatures have -7 penalty to attack rolls against the caster. Lasts 1 rnd/caster level or until expended.
Flame Strike	5th	Crew	Affects 1 crew section, inflicts 8 HD on all crewmen (save for half). The ship takes 3 hull points damage and must save vs. magical fire or catch fire.
Rainbow	5th	Special	<i>Bridge</i> : Creates a grappling bridge (see page 20). Can be dismissed instantly by caster.
Wall of Fire	5th	Crew	Affects 1-2 crew sections for 4 HD damage (save for half); ship must save vs. magical fire or catch fire. Lasts 1 rnd/level.
Blade Barrier	6th	Ship	Creates a stationary hazard for ships of other than stone or metal. If cast in a ship's path the ship takes 2d3 hull points of damage. One crew section must save vs. spells or take 8 HD to each crewman.
Heal	6th	Indiv.	Heals all wounds of one individual.
Turn Wood	6th	Special	This spell is directed out of one hex side to ward off enemy attacks. It affects wooden ships and wooden missiles. It prevents direct missile, ram, and grappling attempts from the warded direction, but does not prevent movement into or through the caster's hex. (Note that if the caster wards his bow, any bow ram he has cannot be used against a wooden ship!)

APPENDIX: PRIEST SPELLS

Name	Level	Target	Effect
Wall of Thorns	6th	Special	<i>On own ship:</i> Covers one hexside angle, preventing boarding or missile fire from that angle. <i>In enemy's path:</i> a ship under 1 ton/caster level stops. Otherwise, ship must save (use save vs. cold with -10 penalty) or lose one step of MC; also failure means thorns will affect 1-3 sections; save vs. spell or take 3 HD damage per crewman.
Confusion	7th	Crew	Affects 1-3 crew sections. Save vs. spell at -2 for each section to negate. Affected sections incapacitated for 2 rounds + 1 rnd/caster level.
Fire Storm	7th	Ship	Ship must save vs. magical fire. If successful, 1-4 crew sections are affected and the ship takes 1-2 hull points damage (wooden ships set afire). Each crewman in an affected section takes 6 HD (half if the section saves vs. spells). If the ship fails, the whole crew is affected, the ship takes 2-5 hull points (1d4 + 1) and is on fire (wooden ships, 1-4 fires).
Sunray	7th	Crew	Affects one crew section per round. Save vs. spell or be blinded for 1-3 rounds (no actions) as directed by caster. Undead take 8 HD damage each (save for half). Duration is 1 + 1d4 rounds.

3-D SET-UP

In the 3D game, the players and the DM can choose to keep track of the non-*helmseeking* missile's movement. Blank chits are included to mark the missile's altitude change per round. However, since space is so vast, the possibility of being hit by a stray missile is so minute, the players may find keeping track of them a waste of time.

If a *helmseeking* missile enters one or more hexes where ships currently lie, the player who shot the missile rolls a standard attack. If the missile hits, it is removed from the board and the ship takes damage. If it misses, it continues to travel until it expends its movement. If the missile enters a hex containing more than one ship, a THACO is rolled from a randomly determined ship, including friendly ships.

Random Set-Up in 3-D

Given the nature of fantasy space, where ships slow to tactical speed upon encountering another gravity plane or well, an opposing ship can suddenly appear out of nowhere. This procedure is generally the same as the optional rule for the two-dimensional game. The opposing ship appears 10 + 1d6 hexes away in a random direction determined by rolling 1d12 on the table.

3-D Random Set-Up

Roll	Direction
1	Directly ahead
2	Ahead and to the starboard
3	Behind and to the starboard
4	Directly behind
5	Behind and to the port side
6	Ahead and to the port side
7	Directly above
8	Above and to the port side
9	Above and to the starboard
10	Directly below
11	Below and to the starboard
12	Below and to the port side

Note: Roll 1d12 for any vertical distance.

SPELLCASTER RECORD SHEET

Ship	Caster's Name	Race	Class/Level	Spellcaster Activity																														
Spells:	<table style="width: 100%; text-align: center;"> <tr> <td style="width: 16.6%;">1st</td> <td style="width: 16.6%;">2nd</td> <td style="width: 16.6%;">3rd</td> <td style="width: 16.6%;">4th</td> <td style="width: 16.6%;">5th</td> <td style="width: 16.6%;">6th</td> <td style="width: 16.6%;">7th</td> <td style="width: 16.6%;">8th</td> <td style="width: 16.6%;">9th</td> </tr> <tr> <td>○○○○○</td> <td>○○○○○</td> <td>○○○○○</td> <td>○○○○○</td> <td>○○○</td> <td>○○○</td> <td>○○○</td> <td>○○○</td> <td>○</td> </tr> <tr> <td>○○○○○</td> <td>○○○○○</td> <td>○○○○○</td> <td>○○○○○</td> <td>○○○</td> <td>○○○</td> <td>○○○</td> <td>○○○</td> <td>○</td> </tr> </table>	1st	2nd	3rd	4th	5th	6th	7th	8th	9th	○○○○○	○○○○○	○○○○○	○○○○○	○○○	○○○	○○○	○○○	○	○○○○○	○○○○○	○○○○○	○○○○○	○○○	○○○	○○○	○○○	○				CAST	COUNTER	PASS
1st	2nd	3rd	4th	5th	6th	7th	8th	9th																										
○○○○○	○○○○○	○○○○○	○○○○○	○○○	○○○	○○○	○○○	○																										
○○○○○	○○○○○	○○○○○	○○○○○	○○○	○○○	○○○	○○○	○																										

Ship	Caster's Name	Race	Class/Level	Spellcaster Activity																														
Spells:	<table style="width: 100%; text-align: center;"> <tr> <td style="width: 16.6%;">1st</td> <td style="width: 16.6%;">2nd</td> <td style="width: 16.6%;">3rd</td> <td style="width: 16.6%;">4th</td> <td style="width: 16.6%;">5th</td> <td style="width: 16.6%;">6th</td> <td style="width: 16.6%;">7th</td> <td style="width: 16.6%;">8th</td> <td style="width: 16.6%;">9th</td> </tr> <tr> <td>○○○○○</td> <td>○○○○○</td> <td>○○○○○</td> <td>○○○○○</td> <td>○○○</td> <td>○○○</td> <td>○○○</td> <td>○○○</td> <td>○</td> </tr> <tr> <td>○○○○○</td> <td>○○○○○</td> <td>○○○○○</td> <td>○○○○○</td> <td>○○○</td> <td>○○○</td> <td>○○○</td> <td>○○○</td> <td>○</td> </tr> </table>	1st	2nd	3rd	4th	5th	6th	7th	8th	9th	○○○○○	○○○○○	○○○○○	○○○○○	○○○	○○○	○○○	○○○	○	○○○○○	○○○○○	○○○○○	○○○○○	○○○	○○○	○○○	○○○	○				CAST	COUNTER	PASS
1st	2nd	3rd	4th	5th	6th	7th	8th	9th																										
○○○○○	○○○○○	○○○○○	○○○○○	○○○	○○○	○○○	○○○	○																										
○○○○○	○○○○○	○○○○○	○○○○○	○○○	○○○	○○○	○○○	○																										

Ship	Caster's Name	Race	Class/Level	Spellcaster Activity																														
Spells:	<table style="width: 100%; text-align: center;"> <tr> <td style="width: 16.6%;">1st</td> <td style="width: 16.6%;">2nd</td> <td style="width: 16.6%;">3rd</td> <td style="width: 16.6%;">4th</td> <td style="width: 16.6%;">5th</td> <td style="width: 16.6%;">6th</td> <td style="width: 16.6%;">7th</td> <td style="width: 16.6%;">8th</td> <td style="width: 16.6%;">9th</td> </tr> <tr> <td>○○○○○</td> <td>○○○○○</td> <td>○○○○○</td> <td>○○○○○</td> <td>○○○</td> <td>○○○</td> <td>○○○</td> <td>○○○</td> <td>○</td> </tr> <tr> <td>○○○○○</td> <td>○○○○○</td> <td>○○○○○</td> <td>○○○○○</td> <td>○○○</td> <td>○○○</td> <td>○○○</td> <td>○○○</td> <td>○</td> </tr> </table>	1st	2nd	3rd	4th	5th	6th	7th	8th	9th	○○○○○	○○○○○	○○○○○	○○○○○	○○○	○○○	○○○	○○○	○	○○○○○	○○○○○	○○○○○	○○○○○	○○○	○○○	○○○	○○○	○				CAST	COUNTER	PASS
1st	2nd	3rd	4th	5th	6th	7th	8th	9th																										
○○○○○	○○○○○	○○○○○	○○○○○	○○○	○○○	○○○	○○○	○																										
○○○○○	○○○○○	○○○○○	○○○○○	○○○	○○○	○○○	○○○	○																										

Ship	Caster's Name	Race	Class/Level	Spellcaster Activity																														
Spells:	<table style="width: 100%; text-align: center;"> <tr> <td style="width: 16.6%;">1st</td> <td style="width: 16.6%;">2nd</td> <td style="width: 16.6%;">3rd</td> <td style="width: 16.6%;">4th</td> <td style="width: 16.6%;">5th</td> <td style="width: 16.6%;">6th</td> <td style="width: 16.6%;">7th</td> <td style="width: 16.6%;">8th</td> <td style="width: 16.6%;">9th</td> </tr> <tr> <td>○○○○○</td> <td>○○○○○</td> <td>○○○○○</td> <td>○○○○○</td> <td>○○○</td> <td>○○○</td> <td>○○○</td> <td>○○○</td> <td>○</td> </tr> <tr> <td>○○○○○</td> <td>○○○○○</td> <td>○○○○○</td> <td>○○○○○</td> <td>○○○</td> <td>○○○</td> <td>○○○</td> <td>○○○</td> <td>○</td> </tr> </table>	1st	2nd	3rd	4th	5th	6th	7th	8th	9th	○○○○○	○○○○○	○○○○○	○○○○○	○○○	○○○	○○○	○○○	○	○○○○○	○○○○○	○○○○○	○○○○○	○○○	○○○	○○○	○○○	○				CAST	COUNTER	PASS
1st	2nd	3rd	4th	5th	6th	7th	8th	9th																										
○○○○○	○○○○○	○○○○○	○○○○○	○○○	○○○	○○○	○○○	○																										
○○○○○	○○○○○	○○○○○	○○○○○	○○○	○○○	○○○	○○○	○																										

Ship	Caster's Name	Race	Class/Level	Spellcaster Activity																														
Spells:	<table style="width: 100%; text-align: center;"> <tr> <td style="width: 16.6%;">1st</td> <td style="width: 16.6%;">2nd</td> <td style="width: 16.6%;">3rd</td> <td style="width: 16.6%;">4th</td> <td style="width: 16.6%;">5th</td> <td style="width: 16.6%;">6th</td> <td style="width: 16.6%;">7th</td> <td style="width: 16.6%;">8th</td> <td style="width: 16.6%;">9th</td> </tr> <tr> <td>○○○○○</td> <td>○○○○○</td> <td>○○○○○</td> <td>○○○○○</td> <td>○○○</td> <td>○○○</td> <td>○○○</td> <td>○○○</td> <td>○</td> </tr> <tr> <td>○○○○○</td> <td>○○○○○</td> <td>○○○○○</td> <td>○○○○○</td> <td>○○○</td> <td>○○○</td> <td>○○○</td> <td>○○○</td> <td>○</td> </tr> </table>	1st	2nd	3rd	4th	5th	6th	7th	8th	9th	○○○○○	○○○○○	○○○○○	○○○○○	○○○	○○○	○○○	○○○	○	○○○○○	○○○○○	○○○○○	○○○○○	○○○	○○○	○○○	○○○	○				CAST	COUNTER	PASS
1st	2nd	3rd	4th	5th	6th	7th	8th	9th																										
○○○○○	○○○○○	○○○○○	○○○○○	○○○	○○○	○○○	○○○	○																										
○○○○○	○○○○○	○○○○○	○○○○○	○○○	○○○	○○○	○○○	○																										

Ship	Caster's Name	Race	Class/Level	Spellcaster Activity																														
Spells:	<table style="width: 100%; text-align: center;"> <tr> <td style="width: 16.6%;">1st</td> <td style="width: 16.6%;">2nd</td> <td style="width: 16.6%;">3rd</td> <td style="width: 16.6%;">4th</td> <td style="width: 16.6%;">5th</td> <td style="width: 16.6%;">6th</td> <td style="width: 16.6%;">7th</td> <td style="width: 16.6%;">8th</td> <td style="width: 16.6%;">9th</td> </tr> <tr> <td>○○○○○</td> <td>○○○○○</td> <td>○○○○○</td> <td>○○○○○</td> <td>○○○</td> <td>○○○</td> <td>○○○</td> <td>○○○</td> <td>○</td> </tr> <tr> <td>○○○○○</td> <td>○○○○○</td> <td>○○○○○</td> <td>○○○○○</td> <td>○○○</td> <td>○○○</td> <td>○○○</td> <td>○○○</td> <td>○</td> </tr> </table>	1st	2nd	3rd	4th	5th	6th	7th	8th	9th	○○○○○	○○○○○	○○○○○	○○○○○	○○○	○○○	○○○	○○○	○	○○○○○	○○○○○	○○○○○	○○○○○	○○○	○○○	○○○	○○○	○				CAST	COUNTER	PASS
1st	2nd	3rd	4th	5th	6th	7th	8th	9th																										
○○○○○	○○○○○	○○○○○	○○○○○	○○○	○○○	○○○	○○○	○																										
○○○○○	○○○○○	○○○○○	○○○○○	○○○	○○○	○○○	○○○	○																										

Ship	Caster's Name	Race	Class/Level	Spellcaster Activity																														
Spells:	<table style="width: 100%; text-align: center;"> <tr> <td style="width: 16.6%;">1st</td> <td style="width: 16.6%;">2nd</td> <td style="width: 16.6%;">3rd</td> <td style="width: 16.6%;">4th</td> <td style="width: 16.6%;">5th</td> <td style="width: 16.6%;">6th</td> <td style="width: 16.6%;">7th</td> <td style="width: 16.6%;">8th</td> <td style="width: 16.6%;">9th</td> </tr> <tr> <td>○○○○○</td> <td>○○○○○</td> <td>○○○○○</td> <td>○○○○○</td> <td>○○○</td> <td>○○○</td> <td>○○○</td> <td>○○○</td> <td>○</td> </tr> <tr> <td>○○○○○</td> <td>○○○○○</td> <td>○○○○○</td> <td>○○○○○</td> <td>○○○</td> <td>○○○</td> <td>○○○</td> <td>○○○</td> <td>○</td> </tr> </table>	1st	2nd	3rd	4th	5th	6th	7th	8th	9th	○○○○○	○○○○○	○○○○○	○○○○○	○○○	○○○	○○○	○○○	○	○○○○○	○○○○○	○○○○○	○○○○○	○○○	○○○	○○○	○○○	○				CAST	COUNTER	PASS
1st	2nd	3rd	4th	5th	6th	7th	8th	9th																										
○○○○○	○○○○○	○○○○○	○○○○○	○○○	○○○	○○○	○○○	○																										
○○○○○	○○○○○	○○○○○	○○○○○	○○○	○○○	○○○	○○○	○																										

Ship	Caster's Name	Race	Class/Level	Spellcaster Activity																														
Spells:	<table style="width: 100%; text-align: center;"> <tr> <td style="width: 16.6%;">1st</td> <td style="width: 16.6%;">2nd</td> <td style="width: 16.6%;">3rd</td> <td style="width: 16.6%;">4th</td> <td style="width: 16.6%;">5th</td> <td style="width: 16.6%;">6th</td> <td style="width: 16.6%;">7th</td> <td style="width: 16.6%;">8th</td> <td style="width: 16.6%;">9th</td> </tr> <tr> <td>○○○○○</td> <td>○○○○○</td> <td>○○○○○</td> <td>○○○○○</td> <td>○○○</td> <td>○○○</td> <td>○○○</td> <td>○○○</td> <td>○</td> </tr> <tr> <td>○○○○○</td> <td>○○○○○</td> <td>○○○○○</td> <td>○○○○○</td> <td>○○○</td> <td>○○○</td> <td>○○○</td> <td>○○○</td> <td>○</td> </tr> </table>	1st	2nd	3rd	4th	5th	6th	7th	8th	9th	○○○○○	○○○○○	○○○○○	○○○○○	○○○	○○○	○○○	○○○	○	○○○○○	○○○○○	○○○○○	○○○○○	○○○	○○○	○○○	○○○	○				CAST	COUNTER	PASS
1st	2nd	3rd	4th	5th	6th	7th	8th	9th																										
○○○○○	○○○○○	○○○○○	○○○○○	○○○	○○○	○○○	○○○	○																										
○○○○○	○○○○○	○○○○○	○○○○○	○○○	○○○	○○○	○○○	○																										

WEAPON TABLE

Large Weapon	Range (SR)	Hull Damage	Personnel Damage	ROF	Crew	THACO	Crit. Hit	Cost
Accelerator	6	1d2	1d10	2/1	1	15	19+	45,000 gp
Ballista, Light	6	0	2d6	1/2	1	12	—	400 gp
Ballista, Medium	4	1d3	3d6	1/3	2	14	20	600 gp
Ballista, Heavy	2	1d4+2	3d10	1/4	4	17	19+	800 gp
Bombard	2	1d6	2d10	1/3	3	17	20	20,000 gp
Bombard, Great	4	3d12	3d10	1/3	5	19	19+	60,000 gp
Catapult, Light	5	1d2	2d10	1/2	1	14	20	500 gp
Catapult, Medium	4	1d3+1	3d10	1/2	3	15	19+	700 gp
Catapult, Heavy	3	2d4	3d10	1/3	5	16	18+	1,000 gp
Dual Ballista, Light	6	1d3	3d6	1/3	2	16	20	800 gp
Dual Ballista, Medium	4	1d4	2d10	1/4	3	14	19	1,200 gp
Dual Ballista, Heavy	2	2d4	4d10	1/5	5	12	18	1,600 gp
Greek Fire Projector	1	1d3	3d10	1/4	3	16	18+	1,000 gp
Jettison, Light	3	0	1d6	1/2	2	14	—	400 gp
Jettison, Medium	2	0	2d6	1/3	3	15	—	600 gp
Jettison, Heavy	1	0	3d6	1/4	4	16	—	800 gp
Sweeper, Gnomish	3	0	1d8 + Special	1/4	3	16	20	800 gp
Sweeper, Super	1(1)	0	2d6 + 2d4	1/4	4	17	—	Special
Small Weapon								
Arquebus	1(1)	0	1d10...	1/3	1	U	—	500 gp
Comp. Long Bow	1(1)	0	1d6	2/1	1	U	—	100 gp
Sheaf Arrow	0	0	1d8	2/1	1	U	—	
Comp. Short Bow	0	0	1d6	2/1	1	U	—	75 gp
Heavy Crossbow	1(1)	0	1d4+1	1/2	1	U	—	50 gp
Hook, Grappling	0	0	1d3	1/2	1	U	—	8 sp
Light Crossbow	0	0	1d4	1	1	U	—	35 gp
Long Bow	1(1)	0	1d6	2/1	1	U	—	75 gp
Sheaf Arrow	0	0	1d8	2/1	1	U	—	
Pistol, Wheel Lock	0	0	1d4...	1/3	1	U	—	700 gp
Short Bow	0	0	1d6	2/1	1	U	—	30 gp
Sling	0	0	1d4	1	1	U	—	5 cp
Bullet	1(1)	0	1d4+1	1	1	U	—	

Note: In the tactical game, all small weapons inflict 1 HD of personal damage.

... = If maximum damage rolled, roll again and add.

U = User's level or hit dice determines chance to hit

1(1) = In role-playing, range is 1 hex, counted as long range.

DEFINITIONS:

Range: A weapon's range is the maximum number of hexes its missile can travel in a round.

Hull Damage: The weapon does this amount of damage to the hull of an opposing ship. A ship reduced to zero or less hull points will break up. This column is also used for crew casualties in the tactical game. Dice notation is defined in Book 3, *Combat Among the Stars*.

Personnel Damage: The weapon inflicts this many hit points of damage to an enemy crew member in a role-playing setting.

ROF: This is how often the weapon can be used. A "1" means the weapon can be used once every round; 2/1 means the weapon can be used twice per round; 1/4 means once every fourth round, etc.

Crew: This is the standard number of crew members needed for the weapon. Fewer crewmen means the weapon takes longer to reload.

THACO: This is the weapon's chance to hit a target, regardless of crew level. When attacking a ship, use the target's Armor Rating, when attacking crew or a creature, use the target's Armor Class.

Crit. Hit (CH): This is the weapon's chance to cause a Critical Hit upon a target ship. When an attack roll is equal to or greater than the CH number, the player rolls for a critical hit as well as normal damage. If the die roll result is less than the CH number, only normal damage is rolled.

LARGE MISSILES: Large missiles that do not hit in the round they are fired have THACO 18, CH 20 (if any chance normally).

HELMSEEKERS: These are magical large missiles that move like ships: SR 6, MC A. After moving three spaces they lock onto the nearest helm in their forward arc. If they miss, they will lock on helms in their forward arc. If none, they move straight.

DEBRIS: Debris inflicts 1 hull point per SR over SR 1 of the ship moving into its space. Also a ship rolling less than its SR on 1d20 takes a critical hit. If debris is burning, ship must save vs. fire or catch on fire.

CLIPPER

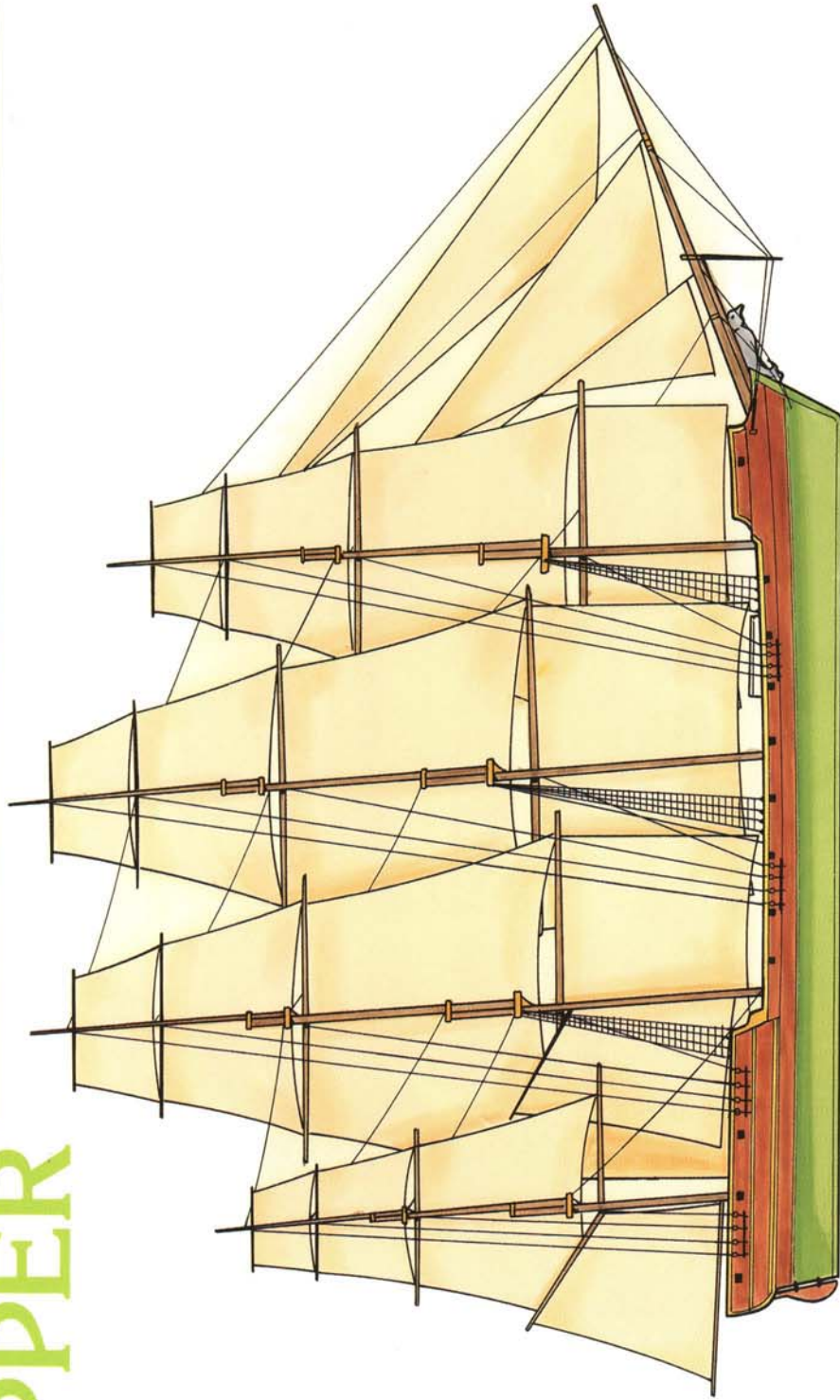

Built By:
Used By:
Tonnage:
Hull Points:
Crew:
Maneuver Class:
Landing—Land:
Landing—Water:
Armor Rating:
Saves As:
Power Type:

Humans
Giff
65 tons
65
18/65
E
No
Yes
4
Metal (hull), Wood (deck)
Major helm

Ship's Rating:
Armament:

As helmsman - 1
26 Bombrads
12 each on starboard and
port side 1 forward, 1 aft
(turret mounted)
Crew: 3 each
23 Tons (Usually used for
smokepowder, helmseekers,
and greek fire.
260'
40'

Cargo Capacity:

Keel Length:
Beam Length:

CLIPPER

One Square = 5 Feet

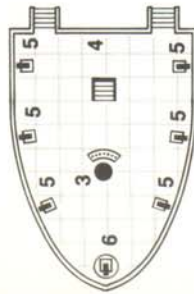
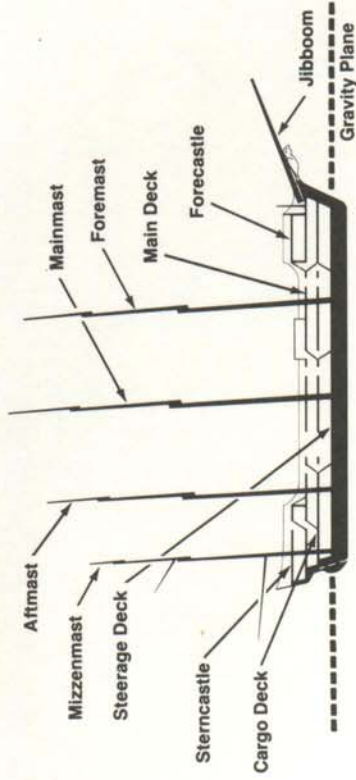

Stern Castle

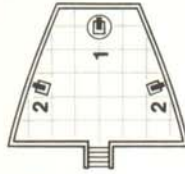

Fore Castle

Main Deck

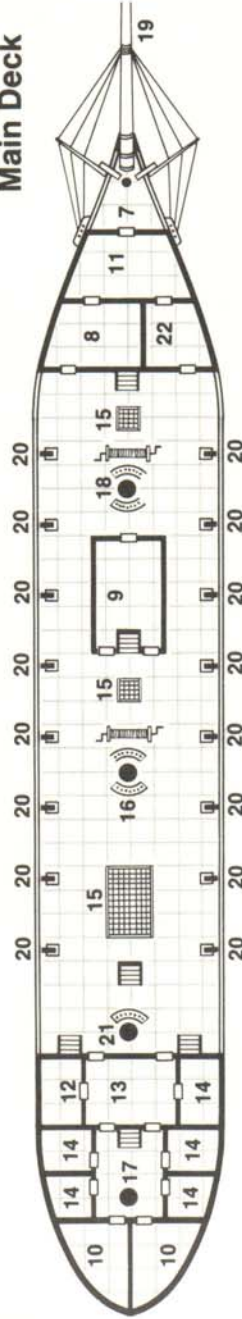

Cargo Deck

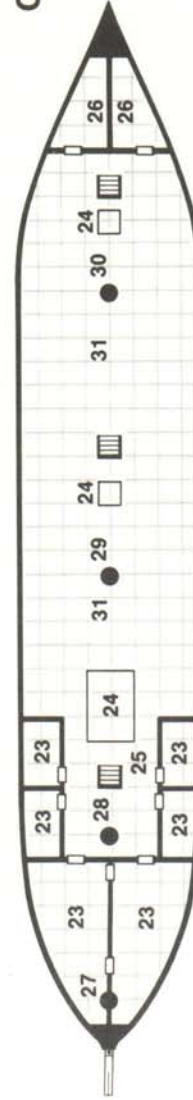

Steerage Deck

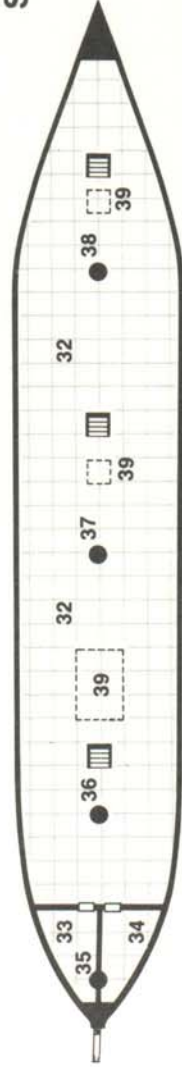

Forecastle

1. Turreted Bombard
2. Bombard

Stern Castle

3. Mizzenmast
4. Captain's Station
5. Bombard
6. Turreted Bombard

Main Deck

7. Rope, Line, and Anchor Storage
8. Forward Stateroom
9. Captain's Cabin
10. Spelljammer Quarters
11. Spelljamming Helm
12. Chart Room
13. Galley
14. Storage/Hold
15. Cargo Doors
16. Mainmast
17. Mizzenmast
18. Foremast
19. Jibboom
20. Bombard
21. Aftmast
22. First Mate's Quarters

Cargo Deck

23. Crew Quarters
24. Cargo Doors
25. Companionway
26. Officers' Quarters
27. Mizzenmast
28. Aftmast
29. Mainmast
30. Foremast
31. Bombard Shot/Greek Fire Cargo Hold

Steerage Deck

32. Cargo Hold
33. Pantry
34. Brig
35. Mizzenmast
36. Aftmast
37. Mainmast
38. Foremast
39. Cargo Hatch

QUAD OF THAY

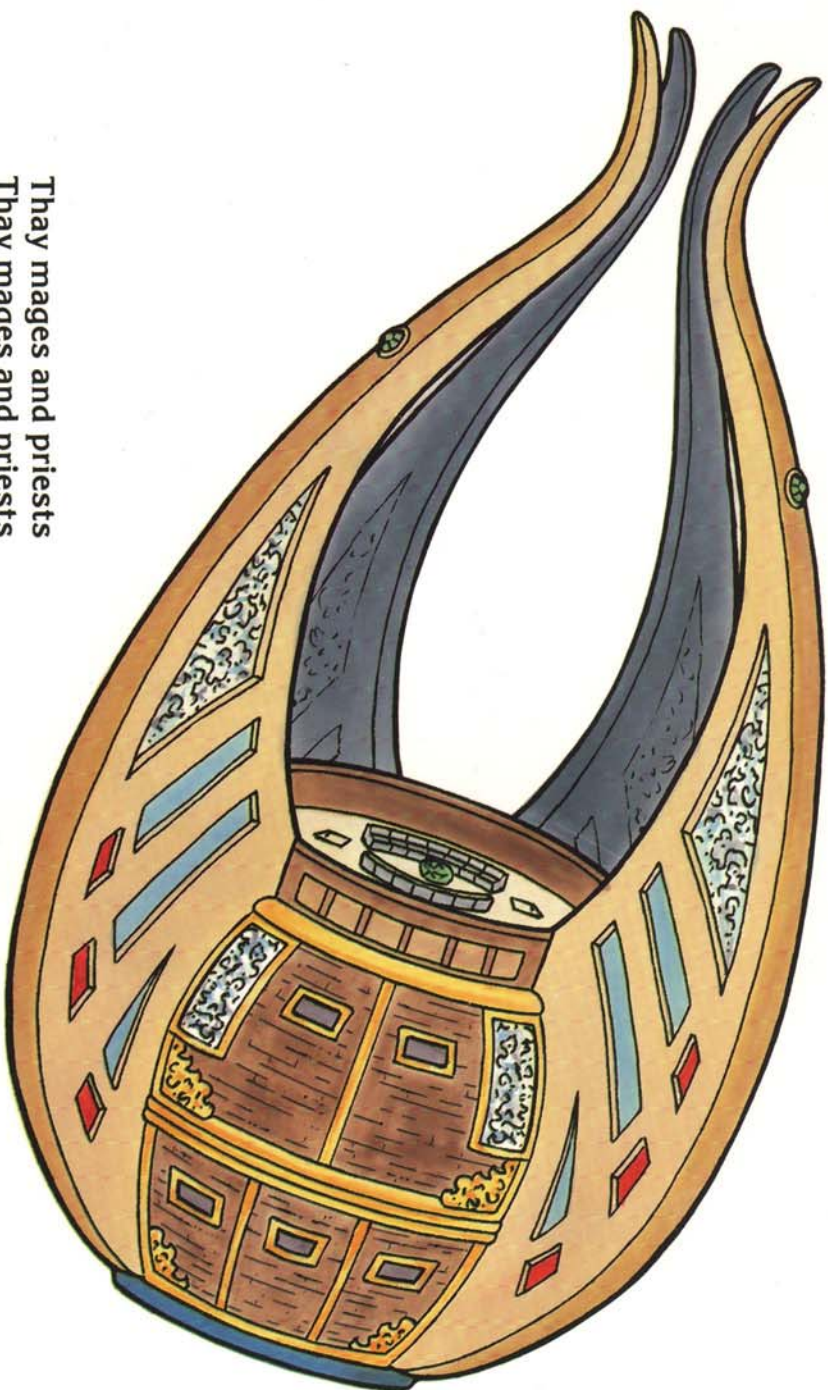

Built By: Thay mages and priests
Used By: Thay mages and priests
Tonnage: 63 tons
Hull Points: 63
Crew: 10/63
Maneuver Class: A
Landing—Land: Yes
Landing—Water: No
Armor Rating: 3 (-1)
Saves As: Best of Metal or Crystal

Power Type: Grand Helm
Ship's Rating: As per helmsmen
Armament: 4 Rams
Cargo Capacity: 31 1/2 tons
Keel Length: 40' (body), 105' (claws)
Beam Length: 55'

QUAD OF THAY

One Square = 5 Feet

- Grand Helm Deck**
 1 Helmsman Positions
 2 Hatch to Primary Deck

- Primary Deck**
 1 Ladders to Grand Helm Deck and Crew Pit
 2 Winch Room and Cargo Hatch
 3 Storeroom
 4 Chart Room
 5 Scrying Room
 6 Library

Note: Location of secret doors approximate. Ships may vary.

- Crew Pit**
 1 Ladder to Primary Deck
 2 Outer Hatch and Folding Staircase
 3 Crew Quarters
 4 Captain's Quarters
 5 First Mate's Quarters
 6 Officers' Quarters
 7 Wizards' and Priests' Quarters
 8 Storage

Grand Helm Deck (open)

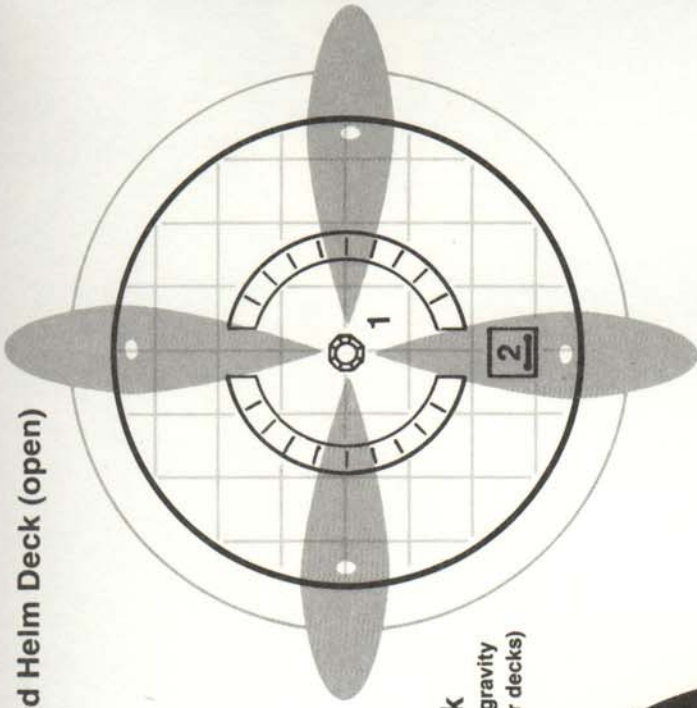

Primary Deck
 (Reverse gravity from upper decks)

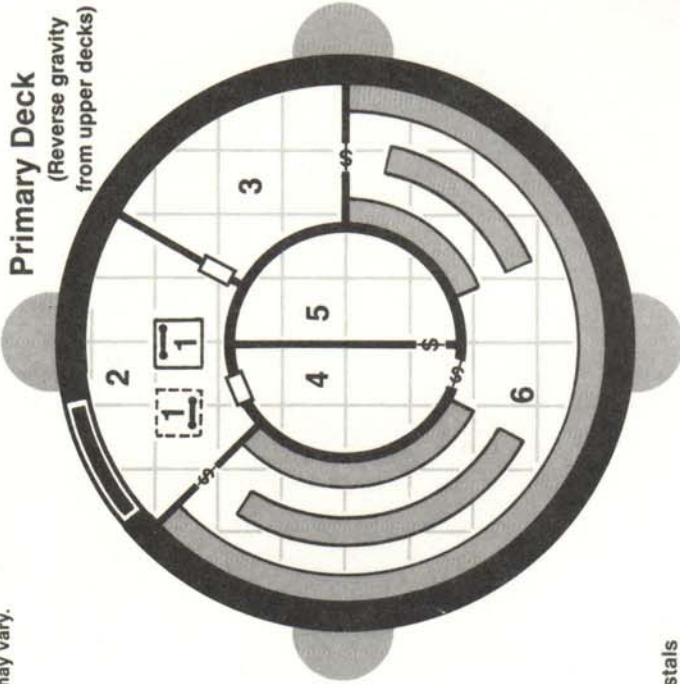

Crew Pit
 (Reverse gravity from upper decks)

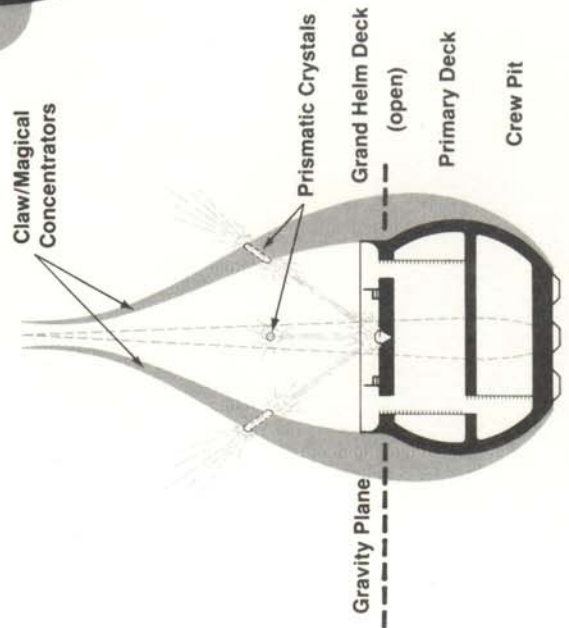
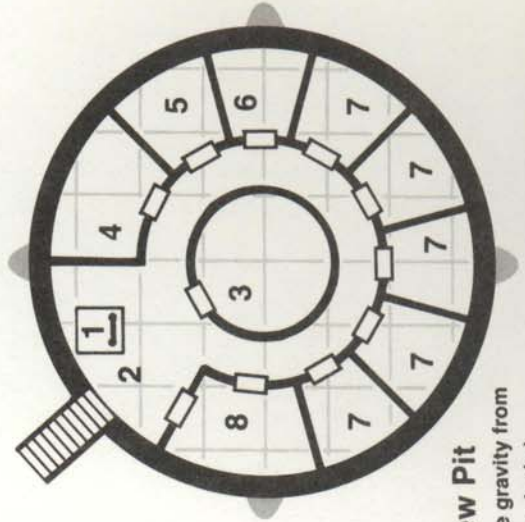

TRIOP

Built By: Arcane
Used By: Gnolls, Goblins, Humans, Illiithids
Tonnage: 45 tons
Hull Points: 45
Crew: 10/45
Maneuver Class: C¹
Landing—Land: Yes
Landing—Water: Yes²
Armor Rating: 1
Saves As: Worst of Bone or Stone
Power Type: Major helm (15%), minor helm (45%), lifejammer (40%)

Ship's Rating: As per helmsman or victim³
Armament: 2 Light ballistae
Crew: 1 each
2 Light catapults
Crew: 1 each
2 Light jettisons
Crew: 2 each
1 Blunt ram

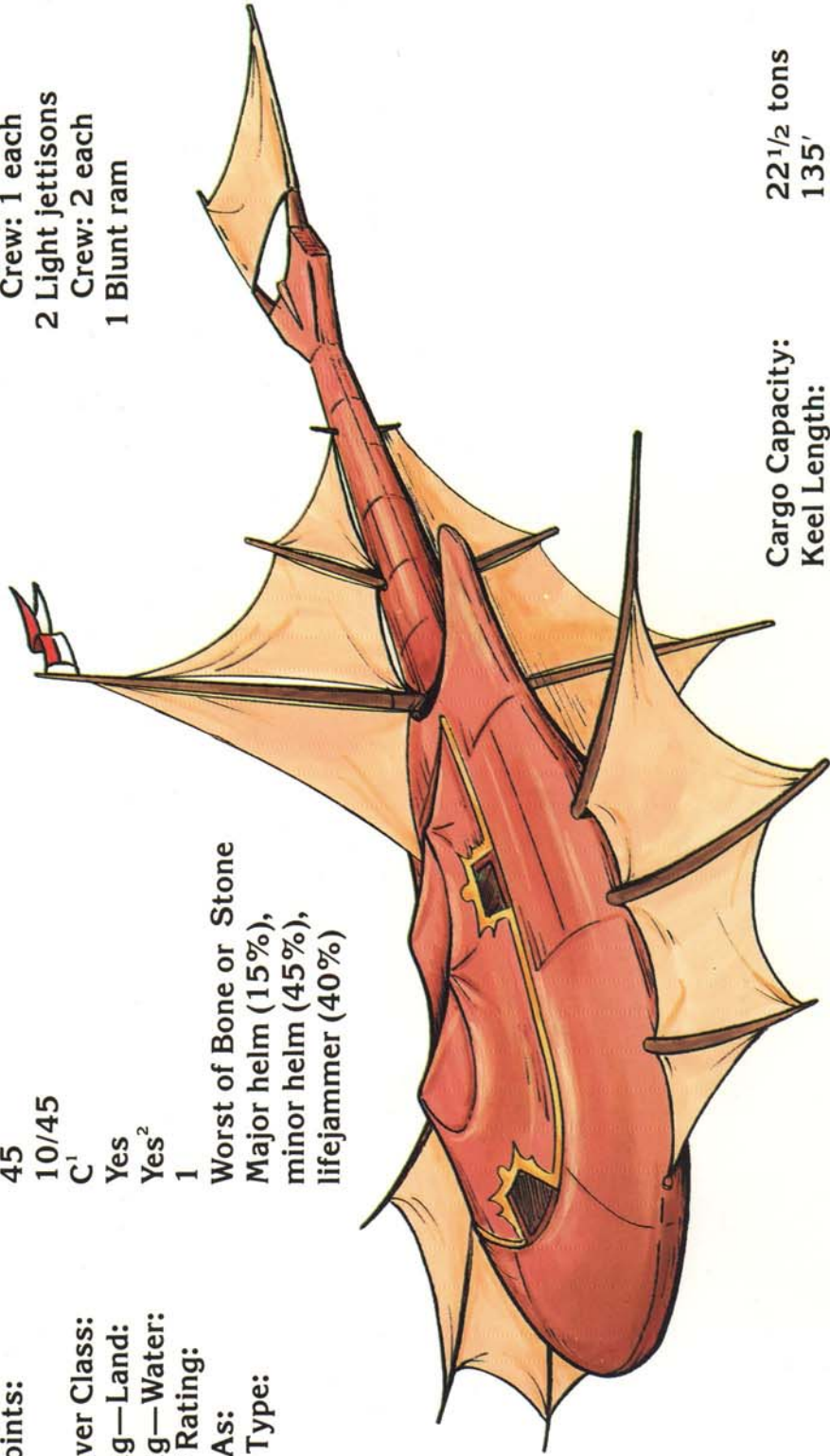

Cargo Capacity: 22½ tons
Keel Length: 135'
Beam Length: 60' (head), 10' (tail)

¹At the beginning or end of its movement in a round, the Triop can spin to face any direction at the cost of 2 SR points.

²The Triop can submerge for 2-8 rounds in a non-acidic fluid before sinking.

³When traveling in a straight line the Triop can suddenly increase or decrease its movement by 2 SR points even if this exceeds its maximum movement or speed change. It can do this once per four rounds.

TRIOP

One Square = 5 feet



- 9 Access to "Underside" Deck
- 10 First Officer's Quarters
- 11 Captain's Quarters
- 12 Helmsman's Quarters
- 13 Officers' Quarters
- 14 Stairs to Upper "Topside" Deck
- 15 Library
- 16 Scribe's Quarters
- 17 Jettison

- Upper "Topside" Deck
 - 1 Light Ballista
 - 2 Crew Quarters
 - 3 Light Catapult
 - 4 Stairs to Main "Topside" Deck
- Main "Topside" Deck
 - 5 Cargo Hold
 - 6 Storage
 - 7 Chartroom
 - 8 Helm

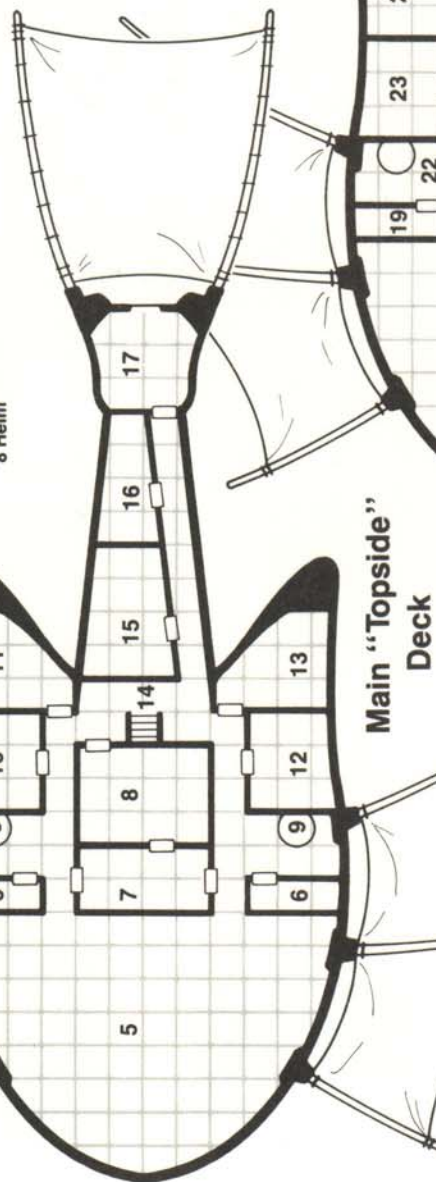

Main "Topside" Deck

- Main "Underside" Deck
- 18 Cargo Hold
- 19 Storage
- 20 Secondary Chartroom
- 21 Secondary Helm
- 22 Access to "Topside" Deck
- 23 Navigator's Quarters
- 24 Officer's Quarters
- 25 Stateroom
- 26 Stairs to Upper "Underside" Deck
- 27 Galley
- 28 Kitchen
- 29 Jettison

- Upper "Underside" Deck
- 30 Light Ballista
- 31 Crew Quarters
- 32 Armory
- 33 Stairs to the Main "Underside" Deck

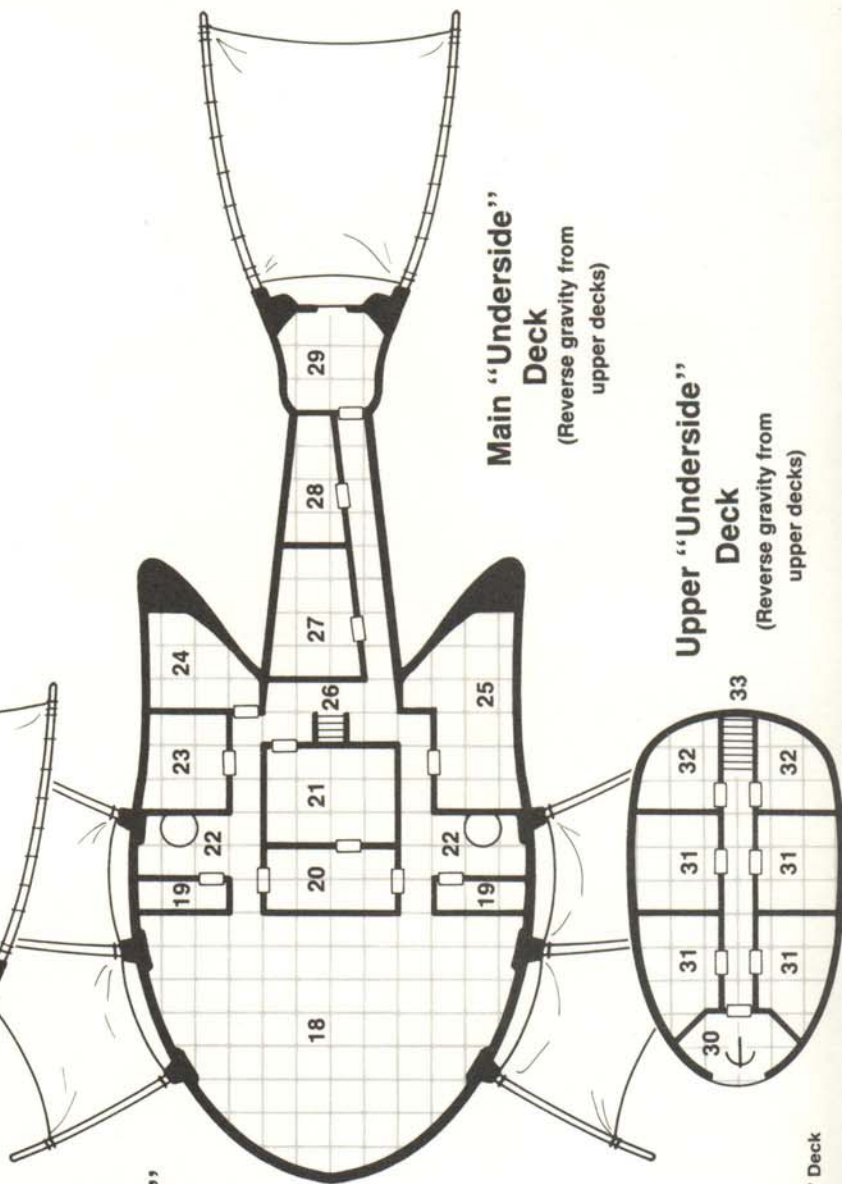

Main "Underside" Deck
(Reverse gravity from upper decks)

Upper "Underside" Deck
(Reverse gravity from upper decks)

1	1	2	2	3	3	4	4	5	5	6	6			
1	1	2	2	3	3	4	4	5	5	6	6			
-1	-1	-2	-2	-3	-3	-4	-4	-5	-5	-6	-6			
-1	-1	-2	-2	-3	-3	-4	-4	-5	-5	-6	-6			
7	7	8	8	9	9	10	10	11	11	12	12			
7	7	8	8	9	9	10	10	11	11	12	12			
-7	-7	-8	-8	-9	-9	-10	-10	-11	-11	-12	-12	0	0	
-7	-7	-8	-8	-9	-9	-10	-10	-11	-11	-12	-12	0	0	

H ↑ 1 2	H ↑ 9 2	M ↑ 1 4	M ↑ 9 4	L ↑ 1 6	H ↑ 1 2	H ↑ 5 2	H ↑ 9 2	L ↑ 1 6	H ↑ 1 3	M ↑ 1 4	L ↑ 1 5	B ↑ 1 2	B ↑ 5 2	B ↑ 9 2
H ↑ 2 2	H ↑ 10 2	M ↑ 2 4	M ↑ 10 4	L ↑ 2 6	H ↑ 2 2	H ↑ 6 2	H ↑ 10 2	L ↑ 2 6	H ↑ 2 3	M ↑ 2 4	L ↑ 2 5	B ↑ 2 2	B ↑ 6 2	B ↑ 10 2
H ↑ 3 2	H ↑ 11 2	M ↑ 3 4	M ↑ 11 4	L ↑ 3 6	H ↑ 3 2	H ↑ 7 2	H ↑ 11 2	L ↑ 3 6	H ↑ 3 3	M ↑ 3 4	L ↑ 3 5	B ↑ 3 2	B ↑ 7 2	GB ↑ 1 4
H ↑ 4 2	H ↑ 12 2	M ↑ 4 4	M ↑ 12 4	L ↑ 4 6	H ↑ 4 2	H ↑ 8 2	H ↑ 12 2	L ↑ 4 6	H ↑ 4 3	M ↑ 4 4	L ↑ 4 5	B ↑ 4 2	B ↑ 8 2	GB ↑ 2 4

H ↑ 5 2	H ↑ 13 2	M ↑ 5 4	M ↑ 13 4	L ↑ 5 6	M ↑ 1 4	M ↑ 5 4	M ↑ 9 4	L ↑ 5 6	H ↑ 5 3	M ↑ 5 4	L ↑ 5 5	Helm Seeker ↑ 6	Helm Seeker ↑ 6	Helm Seeker ↑ 6
H ↑ 6 2	H ↑ 14 2	M ↑ 6 4	M ↑ 14 4	L ↑ 6 6	M ↑ 2 4	M ↑ 6 4	M ↑ 10 4	L ↑ 6 6	H ↑ 6 3	M ↑ 6 4	L ↑ 6 5	Helm Seeker ↑ 6	Helm Seeker ↑ 6	Helm Seeker ↑ 6
H ↑ 7 2	H ↑ 15 2	M ↑ 7 4	M ↑ 15 4	L ↑ 7 6	M ↑ 3 4	M ↑ 7 4	M ↑ 11 4	L ↑ 7 6	H ↑ 7 3	M ↑ 7 4	L ↑ 7 5	Helm Seeker ↑ 6	Helm Seeker ↑ 6	Helm Seeker ↑ 6
H ↑ 8 2	H ↑ 16 2	M ↑ 8 4	M ↑ 16 4	L ↑ 8 6	M ↑ 4 4	M ↑ 8 4	M ↑ 12 4	L ↑ 8 6	H ↑ 8 3	M ↑ 8 4	L ↑ 8 5	Helm Seeker ↑ 6	Helm Seeker ↑ 6	Helm Seeker ↑ 6

														Helm Seeker ↑ 6	Helm Seeker ↑ 6	Helm Seeker ↑ 6
SQUADRON A		SQUADRON B												Dual Ballista	Dual Ballista	Dual Ballista

														Dual Ballista	Dual Ballista	Dual Ballista
SQUADRON A		SQUADRON B												Dual Ballista	Dual Ballista	Dual Ballista

PLAYER AID CARD

Combat Round Sequence

1. Announcement Phase.

- Optional step used with the "Heroic Action" optional rule.

2. Initiative Determination (1d10).

- Initiative winner chooses to move first or last.

3. Ship Movement, Ramming, Missile Fire.

- Ships move in order; ramming, magic, and missile fire are resolved as they happen, in initiative order.

4. Large Missile Movement (and Hit Resolution).

- Move any large missile markers currently on the map in any convenient order. Resolve possible hits as they occur.

5. Boarding Combat.

- Boarding battles are fought in initiative order. (Boarding battles precede grappling attempts.)

6. End of Round Phase.

- Adjust ship status for fires, crew morale, etc. Turn face-down missile markers face-up.

Maneuverability Table

MC	Hex Changes	Face Change	Speed Change ¹	Initiative Modifier	Reverse Speed	Crash Save Modifier
A	3 ²	3	3	-3	3	+8
B	2 ³	3	3	-2	3	+6
C	2 ³	3	3	-1	3	+4
D	1	2	2	+0	2	+2
E	1	2	2	+1	2	0
F	1 ⁴	1	1	+2	1	-2
G	05	1	1	+3	1	* ⁶

¹A major helm can adjust its current speed up to its maximum SR.

²MC A ships change facing at will to the direction of choice, at no SR cost.

³MC B or MC C ships spend 1 SR to change facing, even for a two hex-side change.

⁴MC F ships must move forward one hex before changing facing.

⁵MC G is possible only as a result of a critical hit: No turns during movement, -3 initiative penalty, must roll 30% chance to change one hex side at the end of movement if a turn is desired.

⁶MC G saves as a 1st level wizard.

Critical Hit Table

1d20 Roll	Result
1	Loss of Five Hull Points
2	Deck Crew Casualty
3	Interior Crew Casualty
4	Ship Shaken
5	Large Weapon Damaged
6	Deck Crew Casualty*
7	Hull Holed
8	Maneuverability Loss
9	Loss of 10 Hull Points
10	Ship Shaken
11	Fire!
12	Loss of one SR Point
13	Deck Crew Casualty*
14	Large Weapon Damaged*
15	Ship Shaken
16	Hull Holed
17	Maneuverability Loss*
18	Loss of 10 Hull Points
19	Loss of one SR Point*
20	Spelljammer Shock!

* Special result, see rules.

CALCULATED THACOS

Group	Level																			
Priest	1	2	3	4	5	6	7	8	9	10	11	12	13	14	15	16	17	18	19	20
Rogue	20	20	20	18	18	18	16	16	16	14	14	14	12	12	12	10	10	10	8	8
Warrior	20	20	19	19	18	18	17	17	16	16	15	15	14	14	13	13	12	12	11	11
Wizard	20	20	20	19	19	19	18	18	18	17	17	17	16	16	16	15	15	15	14	14

CREATURE THAC0

1/2 or less	Hit Dice																
20	1-1	1+	2+	3+	4+	5+	6+	7+	8+	9+	10+	11+	12+	13+	14+	15+	16+
	20	19	19	17	17	15	15	13	13	11	11	9	9	7	7	5	5

CHARACTER SAVING THROWS

Attack to be Saved Against

Character Group and Experience Level	Paralyzation, Poison or Death Magic	Rod, Staff, or Wand	Petrification or Polymorph*	Breath Weapon**	Spell***	
Priest	1-3	10	14	13	16	15
	4-6	9	13	12	15	14
	7-9	7	11	10	13	12
	10-12	6	10	9	12	11
	13-15	5	9	8	11	10
	16-18	4	8	7	10	9
	19+	2	6	5	8	7
Rogue	1-4	13	14	12	16	15
	5-8	12	12	11	15	13
	9-12	11	10	10	14	11
	13-16	10	8	9	13	9
	17-20	9	6	8	12	7
	21+	8	7	4	11	5
	19+	2	6	5	8	7
Warrior	0	16	18	17	20	19
	1-2	14	16	15	17	17
	3-4	13	15	14	16	16
	5-6	11	13	12	13	14
	7-8	10	12	11	12	13
	9-10	8	10	9	9	11
	11-12	7	9	8	8	10
13-14	5	7	6	5	8	
15-16	4	6	5	4	7	
19+	3	5	4	4	6	
Wizard	1-5	14	11	13	15	12
	6-10	13	9	11	13	10
	11-15	11	7	9	11	8
	16-20	10	5	7	9	6
	21+	8	3	5	7	4

* Excluding polymorph wand attacks

** Excluding those that cause petrification or polymorph

*** Excluding those for which another saving throw type is specified, such as death, petrification, polymorph, etc.

©1992 TSR, Inc. All Rights Reserved.

ADVANCED DUNGEONS & DRAGONS is a registered trademark owned by TSR, Inc. SPELLJAMMER and the TSR logo are trademarks owned by TSR, Inc.

WEAPON TABLE

Large Weapon	Range (SR)	Hull Damage	Personnel Damage	ROF	Crew	THACO	Crit. Hit	Cost
Accelerator	6	1d2	1d10	2/1	1	15	19+	45,000 gp
Ballista, Light	6	0	2d6	1/2	1	12	—	400 gp
Ballista, Medium	4	1d3	3d6	1/3	2	14	20	600 gp
Ballista, Heavy	2	1d4+2	3d10	1/4	4	17	19+	800 gp
Bombard	2	1d6	2d10	1/3	3	17	20	20,000 gp
Bombard, Great	4	3d12	3d10	1/3	5	19	19+	60,000 gp
Catapult, Light	5	1d2	2d10	1/2	1	14	20	500 gp
Catapult, Medium	4	1d3+1	3d10	1/2	3	15	19+	700 gp
Catapult, Heavy	3	2d4	3d10	1/3	5	16	18+	1,000 gp
Dual Ballista, Light	6	1d3	3d6	1/3	2	16	20	800 gp
Dual Ballista, Medium	4	1d4	2d10	1/4	3	14	19	1,200 gp
Dual Ballista, Heavy	2	2d4	4d10	1/5	5	12	18	1,600 gp
Greek Fire Projector	1	1d3	3d10	1/4	3	16	18+	1,000 gp
Jettison, Light	3	0	1d6	1/2	2	14	—	400 gp
Jettison, Medium	2	0	2d6	1/3	3	15	—	600 gp
Jettison, Heavy	1	0	3d6	1/4	4	16	—	800 gp
Sweeper, Gnomish	3	0	1d8+Special	1/4	3	16	20	800 gp
Sweeper, Super	1(1)	0	2d6+2d4	1/4	4	17	—	Special
Small Weapon								
Arquebus	1(1)	0	1d10...	1/3	1	U	—	500 gp
Comp. Long Bow	1(1)	0	1d6	2/1	1	U	—	100 gp
Sheaf Arrow	0	0	1d8	2/1	1	U	—	
Comp. Short Bow	0	0	1d6	2/1	1	U	—	75 gp
Heavy Crossbow	1(1)	0	1d4+1	1/2	1	U	—	50 gp
Hook, Grappling	0	0	1d3	1/2	1	U	—	8 sp
Light Crossbow	0	0	1d4	1	1	U	—	35 gp
Long Bow	1(1)	0	1d6	2/1	1	U	—	75 gp
Sheaf Arrow	0	0	1d8	2/1	1	U	—	
Pistol, Wheel Lock	0	0	1d4...	1/3	1	U	—	700 gp
Short Bow	0	0	1d6	2/1	1	U	—	30 gp
Sling	0	0	1d4	1	1	U	—	5 cp
Bullet	1(1)	0	1d4+1	1	1	U	—	

Note: In the tactical game, all small weapons inflict 1 HD of personal damage.

U = User's level or hit dice determines chance to hit

1(1) = In role-playing, range is 1 hex, counted as long range.

... = If maximum damage rolled, roll again and add.

DEFINITIONS:

Range: A weapon's range is the maximum number of hexes its missile can travel in a round.

Hull Damage: The weapon does this amount of damage to the hull of an opposing ship. A ship reduced to zero or less hull points will break up. This column is also used for crew casualties in the tactical game. Dice notation is defined in Book 3, *Combat Among the Stars*.

Crew Damage: The weapon inflicts this many hit points of damage to an enemy crew member in a role-playing setting.

ROF: This is how often the weapon can be used. A "1" means the weapon can be used once every round; 2/1 means the weapon can be used twice per round; 1/4 means once every fourth round, etc.

Crew: This is the standard number of crew members needed for the weapon. Fewer crewmen means the weapon takes longer to reload.

THACO: This is the weapon's chance to hit a target, regardless of crew level. When attacking a ship, use the target's Armor Rating, when attacking crew or a creature, use the target's Armor Class.

Crit. Hit (CH): This is the weapon's chance to cause a Critical Hit upon a target ship. When an attack roll is equal to or greater than the CH number, the player rolls for a critical hit as well as normal damage. If the die roll result is less than the CH number, only normal damage is rolled.

LARGE MISSILES: Large missiles that do not hit in the round they are fired have THACO 18, CH 20 (if any chance normally).

HELMSEEKERS: These are magical large missiles that move like ships: SR 6, MC A. After moving three spaces they lock onto the nearest helm in their forward arc. If they miss, they will lock on helms in their forward arc. If none, they move straight.

DEBRIS: Debris inflicts 1 hull point per SR over SR 1 of the ship moving into its space. Also a ship rolling less than its SR on 1d20 takes a critical hit. If debris is burning, ship must save vs. fire or catch on fire.



LEECH
(on Kindori)
©1992
TSR, Inc.
All Rights
Reserved

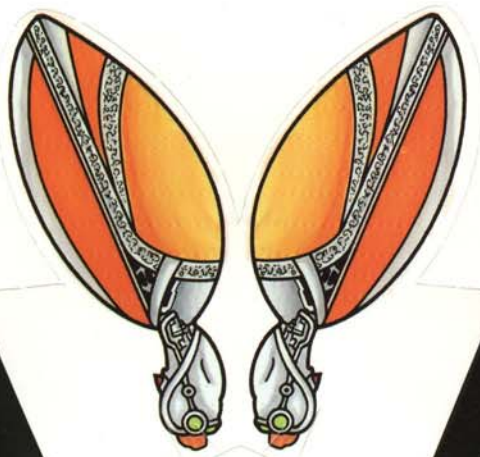

DEATHSPIDER

DEATHSPIDER
©1992
TSR, Inc.
All Rights
Reserved

LEECH
(on Kindori)

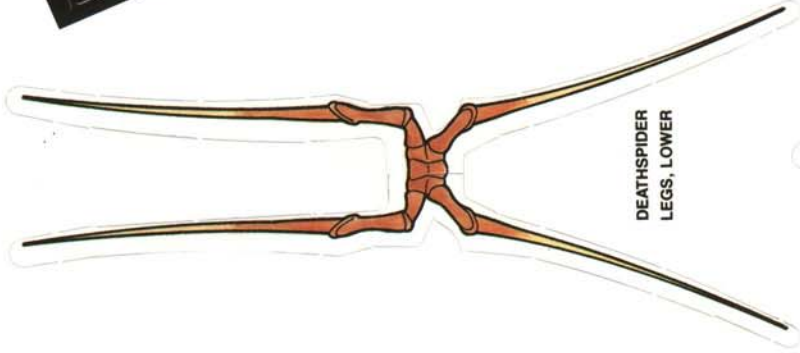

DEATHSPIDER
LEGS, LOWER

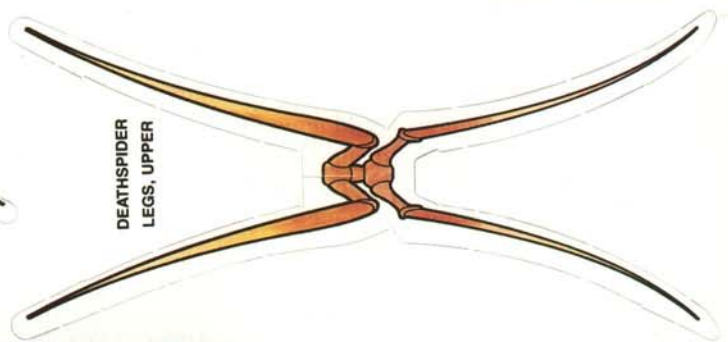

DEATHSPIDER
LEGS, UPPER



MINDSPIDER

MINDSPIDER
©1992
TSR, Inc.
All Rights
Reserved



EEL SHIP



MINDSPIDER

MINDSPIDER
©1992
TSR, Inc.
All Rights
Reserved



MINDSPIDER LEGS

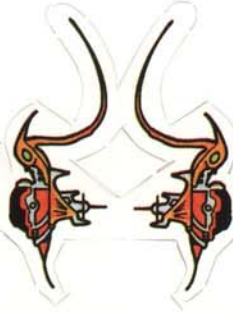
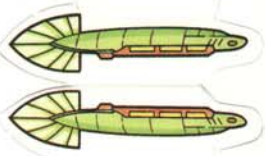

MINDSPIDER

MINDSPIDER
©1992
TSR, Inc.
All Rights
Reserved



EEL SHIP
©1992
TSR, Inc.
All Rights
Reserved



GREAT BOMBARD



GREAT BOMBARD SAIL



GREAT BOMBARD

©1992
TSR, Inc.
All Rights
Reserved

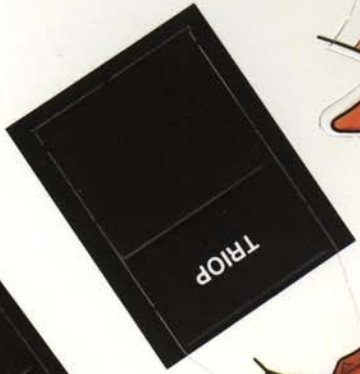

TRIOP

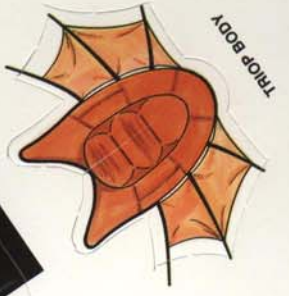

TRIOP BODY



BATSHIP



BATSHIP WINGS

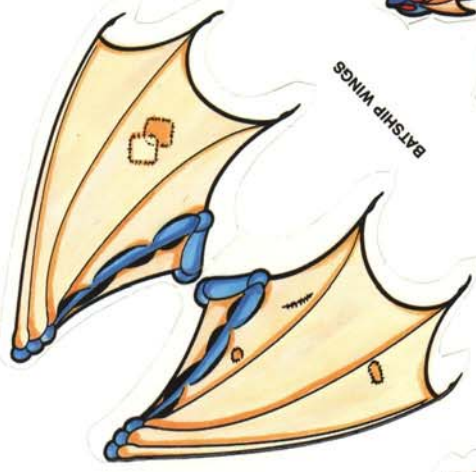

BATSHIP

©1992
TSR, Inc.
All Rights
Reserved



TRIOP

©1992
TSR, Inc.
All Rights
Reserved



TRIOP TAIL



TRIOP

©1992
TSR, Inc.
All Rights
Reserved



BATTLEWAGON DECK



BATTLEWAGON LEGS



BATTLE WAGON

©1992
TSR, Inc.
All Rights
Reserved

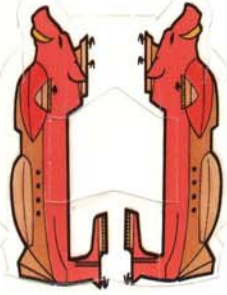

BATTLE WAGON



TRIOP TAIL



TRIOP

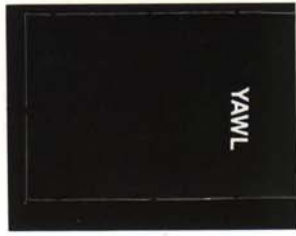

YAWL

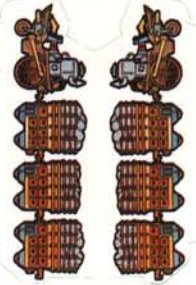

YAWL

©1992
TSR, Inc.
All Rights
Reserved



TRIOP BODY

DOLPHIN SHUTTLE

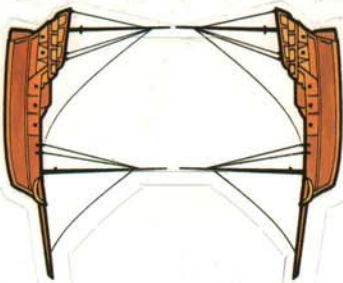

DOLPHIN SHUTTLE
© 1992 TSR, Inc. All Rights Reserved

DOLPHIN

DROMOND

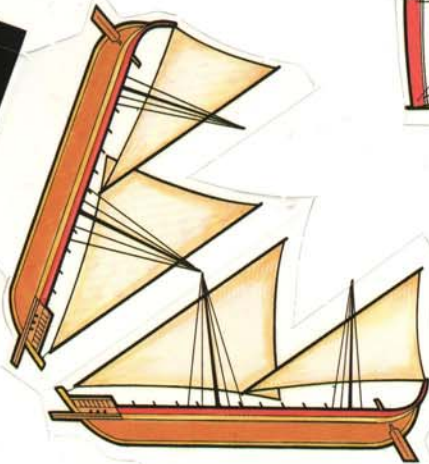

Shuttle Sail (Forward)



DOLPHIN SAIL

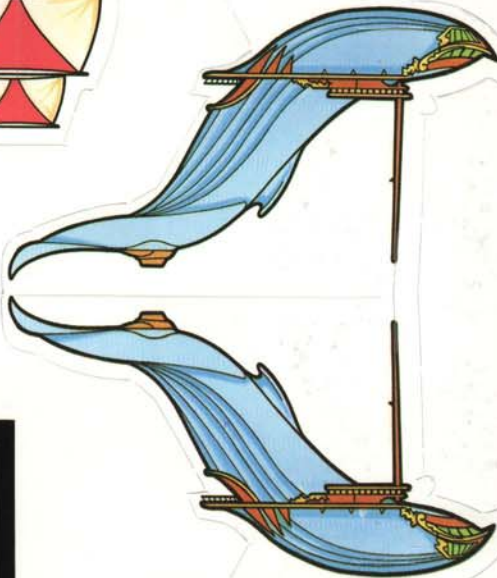

DROMOND OARS



Shuttle Sail (Aft)

MAN-O-WAR

DOLPHIN
© 1992 TSR, Inc. All Rights Reserved

OCTOPUS
© 1992 TSR, Inc. All Rights Reserved

OCTOPUS SAIL 2



OCTOPUS SAIL 1

DROMOND
© 1992 TSR, Inc. All Rights Reserved

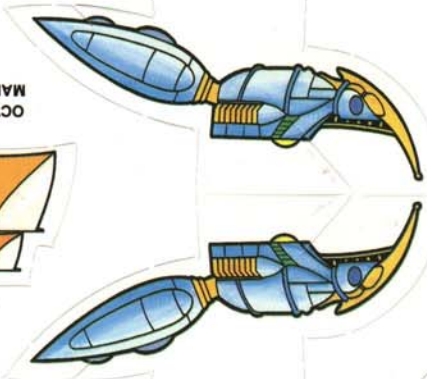

OCTOPUS MAINSAIL



DOLPHIN FLIPPERS



MAN-O-WAR WINGS

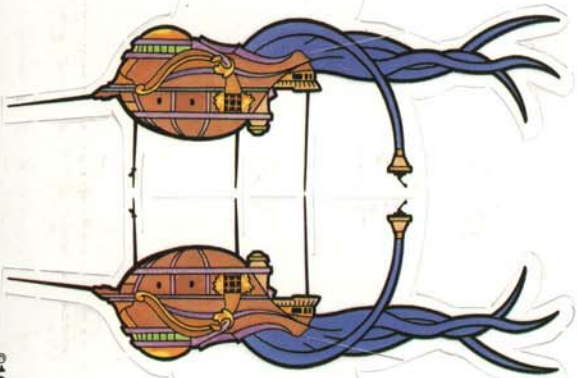
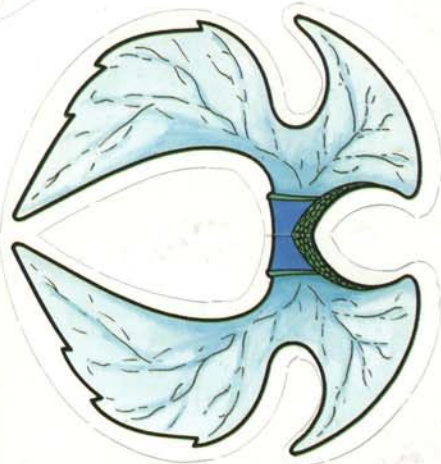

OCTOPUS TENTACLES



OCTOPUS
© 1992 TSR, Inc. All Rights Reserved

MAN-O-WAR
© 1992 TSR, Inc. All Rights Reserved

EEL SHIP
© 1992
TSR, Inc.
All Rights
Reserved

LAMPREY

SMALLJAMMER

SMALLJAMMER
© 1992
TSR, Inc.
All Rights
Reserved

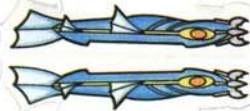
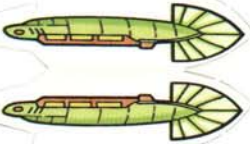

DRAGONSHIP
© 1992
TSR, Inc.
All Rights
Reserved



DRAGONSHIP
SMALLJAMMER
WINGS

EEL SHIP
© 1992
TSR, Inc.
All Rights
Reserved
EEL SHIP

LAMPREY
© 1992
TSR, Inc.
All Rights
Reserved
LAMPREY

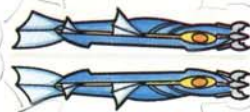
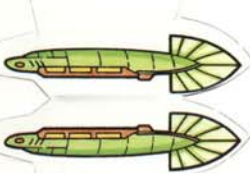
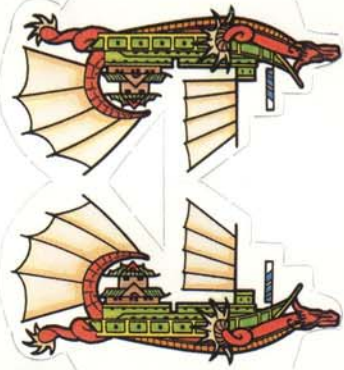
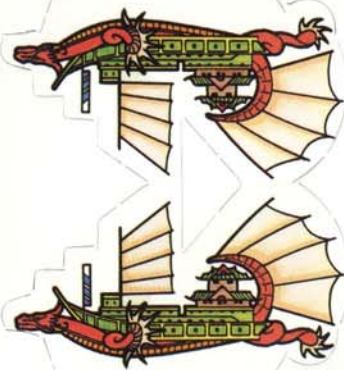

DRAGONSHIP

EEL SHIP
© 1992
TSR, Inc.
All Rights
Reserved

DRAGONSHIP
© 1992
TSR, Inc.
All Rights
Reserved

EEL SHIP

LAMPREY
© 1992
TSR, Inc.
All Rights
Reserved

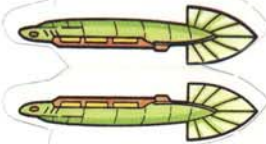

LAMPREY

EEL SHIP

LAMPREY
© 1992
TSR, Inc.
All Rights
Reserved



©1992
TSR, Inc.
All Rights
Reserved

MANTIS

NAUTILOID

©1992
TSR, Inc.
All Rights
Reserved

NAUTILOID

NAUTILOID

MANTIS CLAWS

MANTIS

MANTIS

MANTIS LEGS

MANTIS

MANTIS LEGS

NAUTILOID

©1992
TSR, Inc.
All Rights
Reserved

MANTIS CLAWS

©1992
TSR, Inc.
All Rights
Reserved



ANGELSHIP WINGS

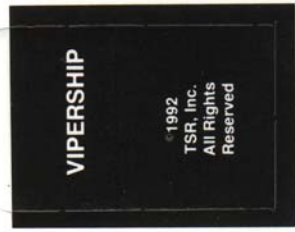
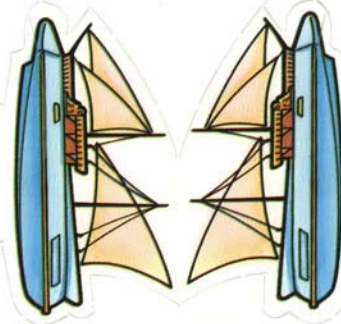
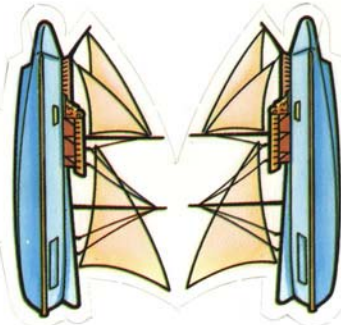

COG SAIL



COG SAIL

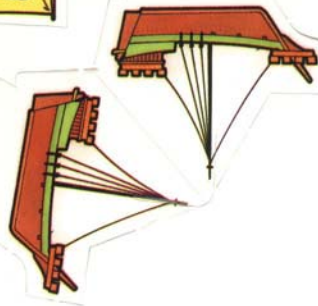
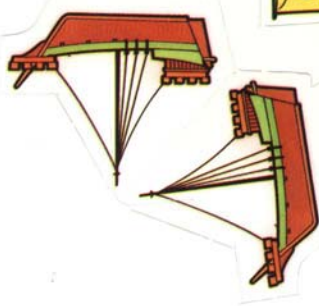



SMALLJAMMER

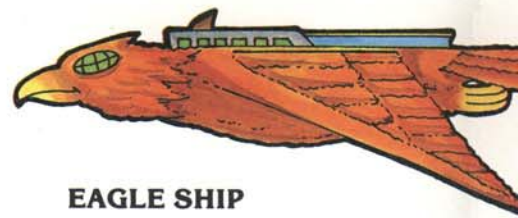

EAGLE SHIP

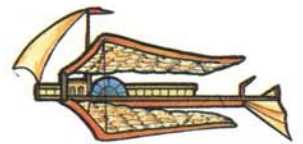

CORBINA

COMPARATIVE SIZES OF

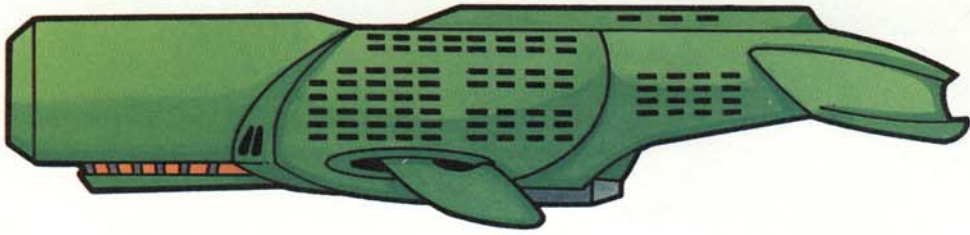

WHALESHIP



DREADNAUGHT



GREAT BOMBARD

SPACEFARING VESSELS

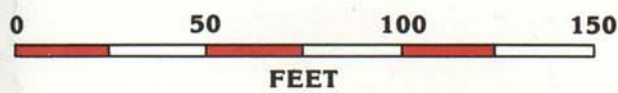

**SPINE-SHIP
(PORCUPINE SHIP)**

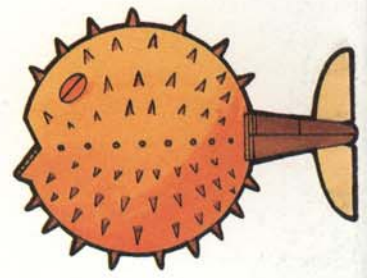

BATSHIP

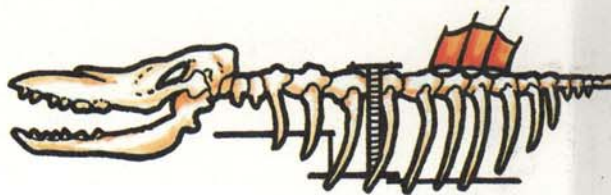
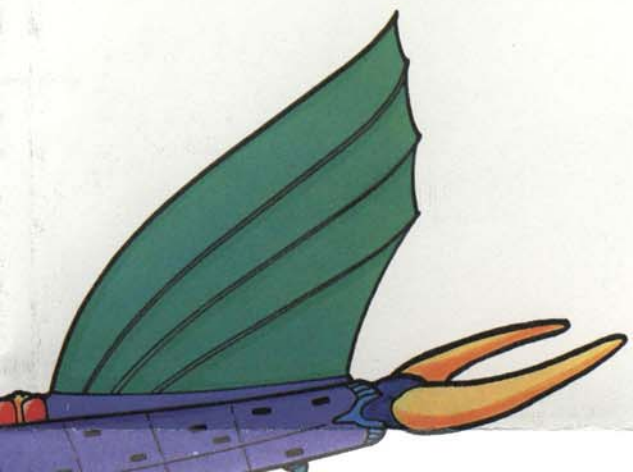
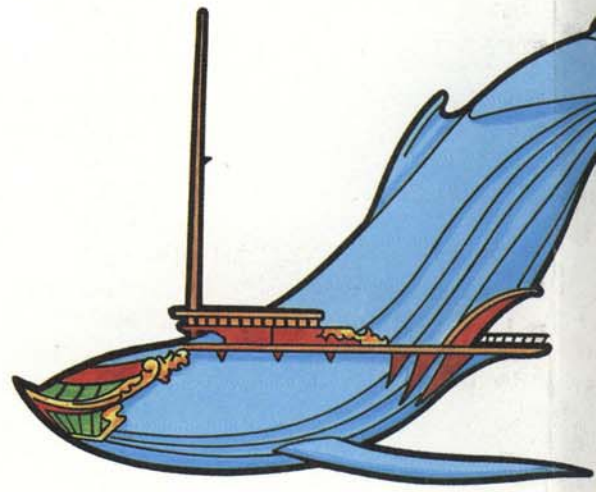

SKELETON SHIP

ELS



ACCESSORY

DOLPHIN SHUTTLE

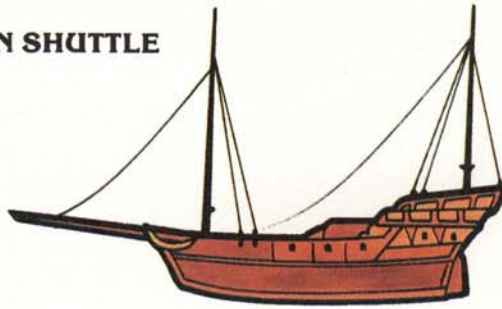

DOLPHIN

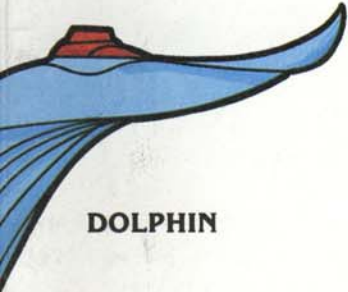

QUENTIN'S LIBRARIA

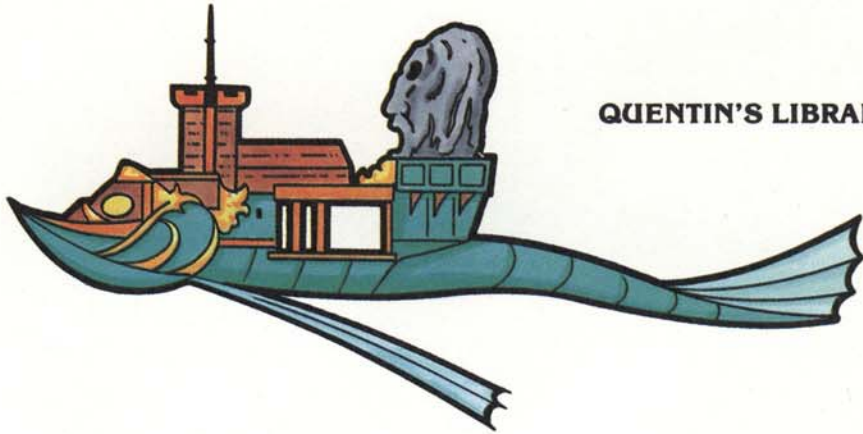



CUTTLE

TSUNAMI

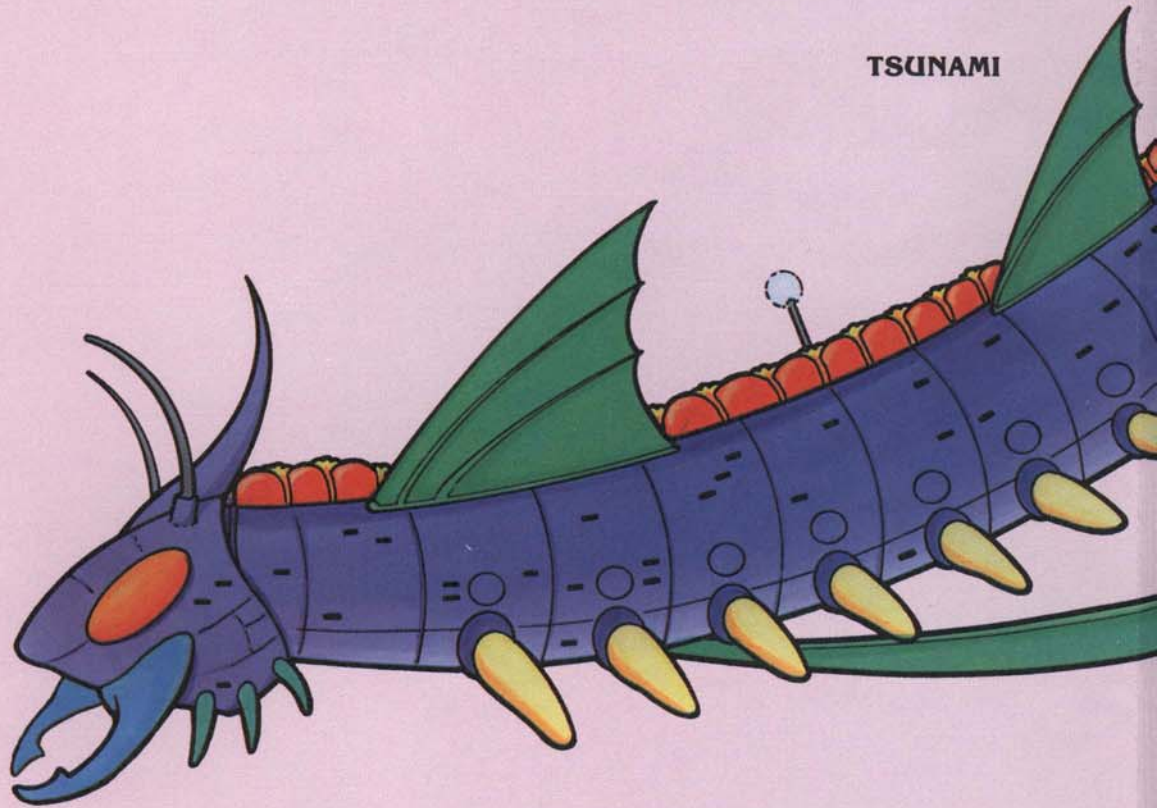

THE SPELLJAM

BATTLE COMMAND

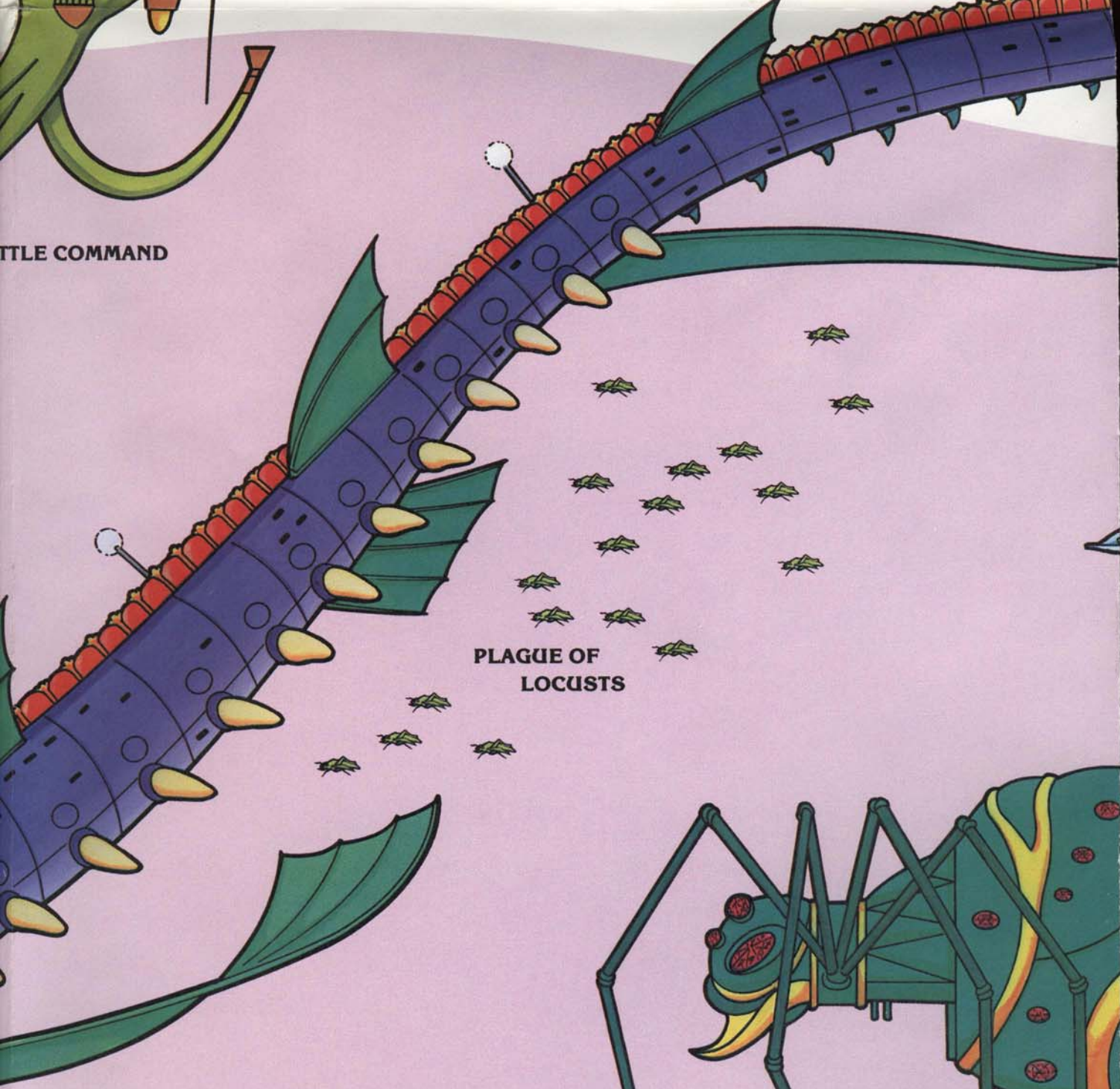

PLAGUE OF
LOCUSTS

JADE SPIDER

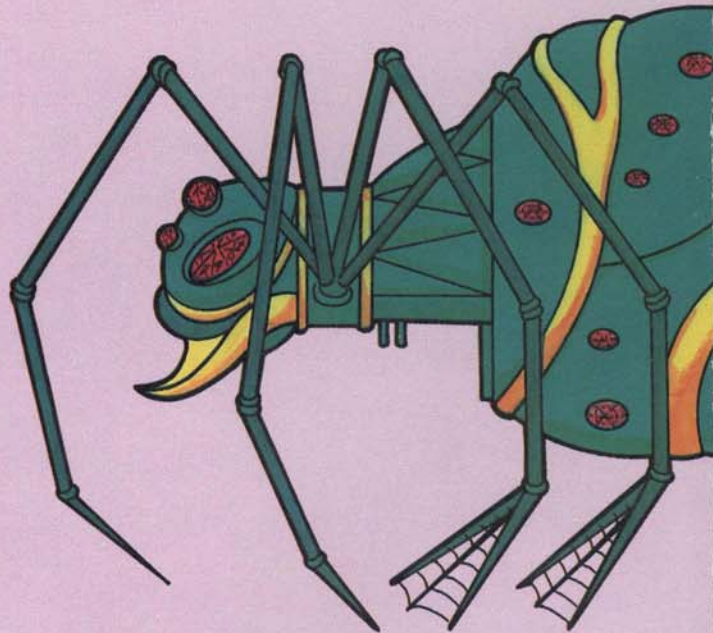

JADE SPIDER COMMANDSHIP

MMER

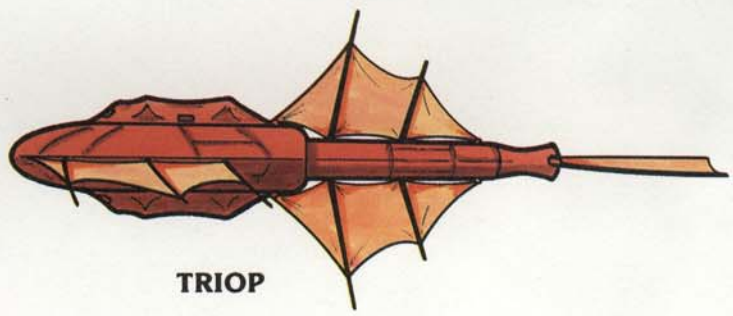

TRIOP



WHELK

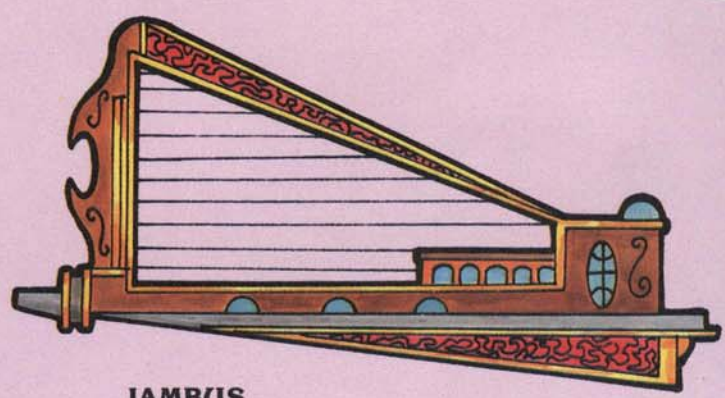
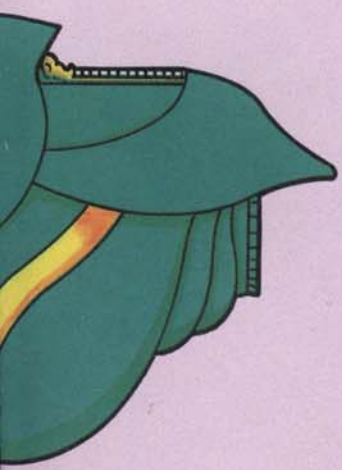

IAMBUS

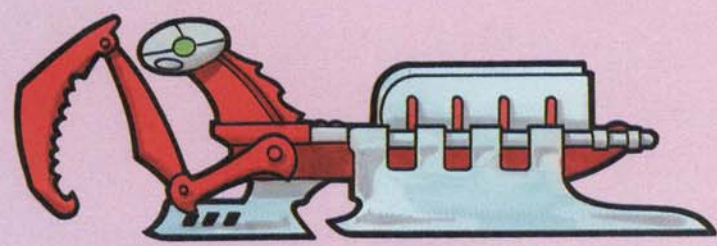

MANTIS

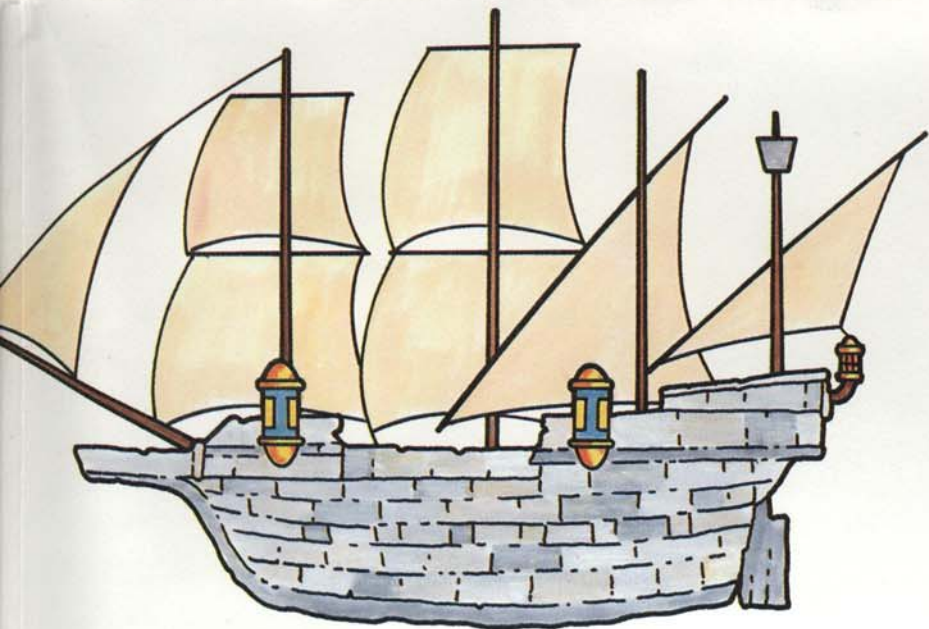

SPACESEA GIANT GALLEON



NIGHTWOLF

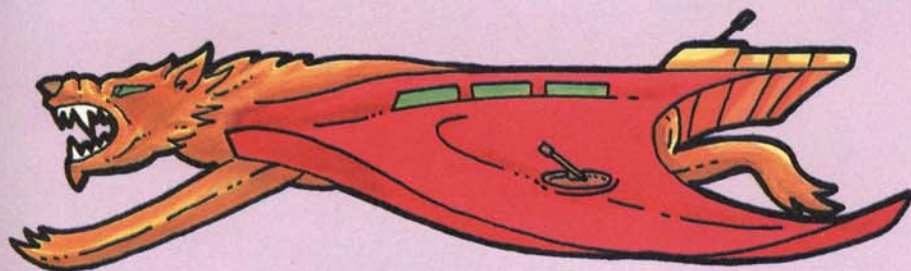

HUNTER-KILLER

DIESEL
'92

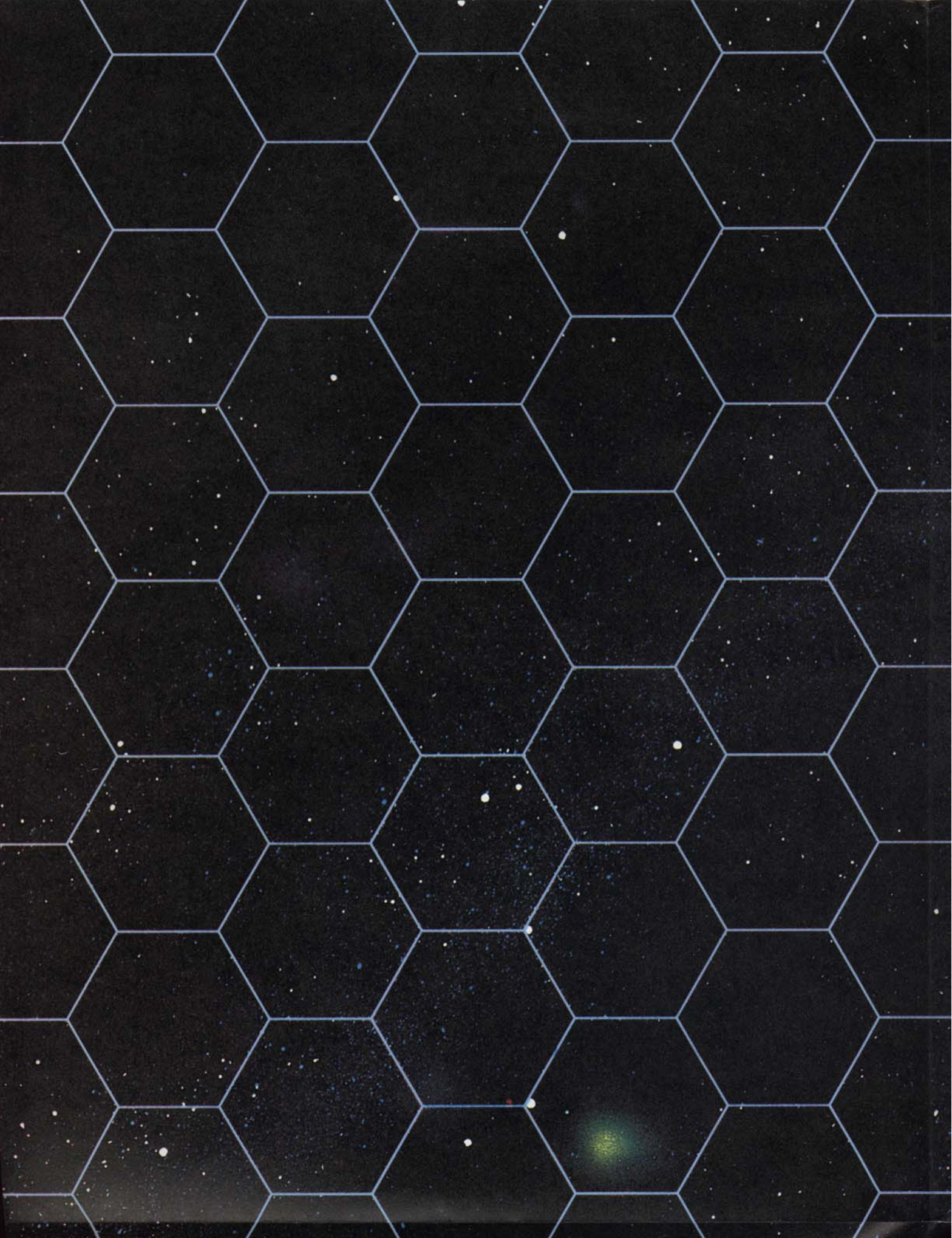







1072XXX0701

©1992 TSR, Inc. All Rights Reserved.
SPELLJAMMER is a trademark owned by TSR, Inc.







Small
SPELLJAMMER



FOR CHARACTERS OF ALL LEVELS

WAR CAPTAIN'S COMPANION

By Dale "Slade" Henson

COMBAT IN FANTASY SPACE!

The worlds of fantasy space are legion. Not all are friendly. The spider-like Neogi slavers, the cold and calculating Mind Players, the savage Scro, and others all build great ships of war to catch the magical currents of space.

Now YOU can face the perils of deadly combat in the depths of the void. This game accessory gives you the chance to storm enemy ships or brave a barrage of wizard spells that could tear your ship apart. This latest boxed set, the *War Captain's Companion* (sequel to the earlier SPELLJAMMER™ boxed set, *Adventures In Space*) contains the following:

- **Ship-to-Ship game:** Tactical ship rules and two 22" × 31" mapsheets with an extra-large hex grid.
- **Additional game cards:** 6 full-sized 8½" × 11" cards: player aid cards, game markers, and three new color ship cards.
- **Three complete books:** Over 190 pages of vital information designed to expand your SPELLJAMMER™ campaign setting.
- **Colorful playing pieces:** 6 sheets of full-color 3-D ship pieces, over 30 ships in all.

War Captain's Guide

96 pages

- New role-playing rules, including new character skills and magical items.
- New section allows creative players to design their own ships.
- War fleet and shipyard bases for our major campaign worlds!

Ship Recognition Manual

64 pages

- Updated and expanded information on all existing ship types.
- Each ship in this book is accompanied by a detailed line illustration.
- Introduces over a dozen ship types for the first time anywhere!

Combat Among the Stars

32 pages

- Easy-to-learn ship-to-ship rules will give hours of enjoyment.
- Includes ramming, boarding actions, magic use, and much more.
- Optional rules feature 3-D movement and advanced weapons and equipment!

TSR, Inc.
POB 756
Lake Geneva,
WI 53147 U.S.A.



TSR Ltd.
120 Church End, Cherry Hinton
Cambridge CB1 3LB
United Kingdom



ADVANCED DUNGEONS & DRAGONS is a registered trademark owned by TSR, Inc.
SPELLJAMMER and the TSR logo are trademarks owned by TSR, Inc.
©1992 TSR Inc. All Rights Reserved. Printed in U.S.A.

ISBN 1-56076-343-4