

# SPINNIN' JAMMER<sup>™</sup>

Official Game Adventure

## Skull & Crossbows

by Nigel Findley



SRUM

# MONARCH ARMADA

One Square = 5 Feet

Side View

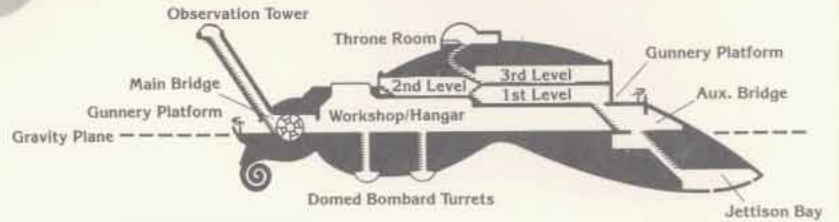

Top View

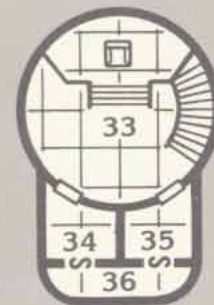
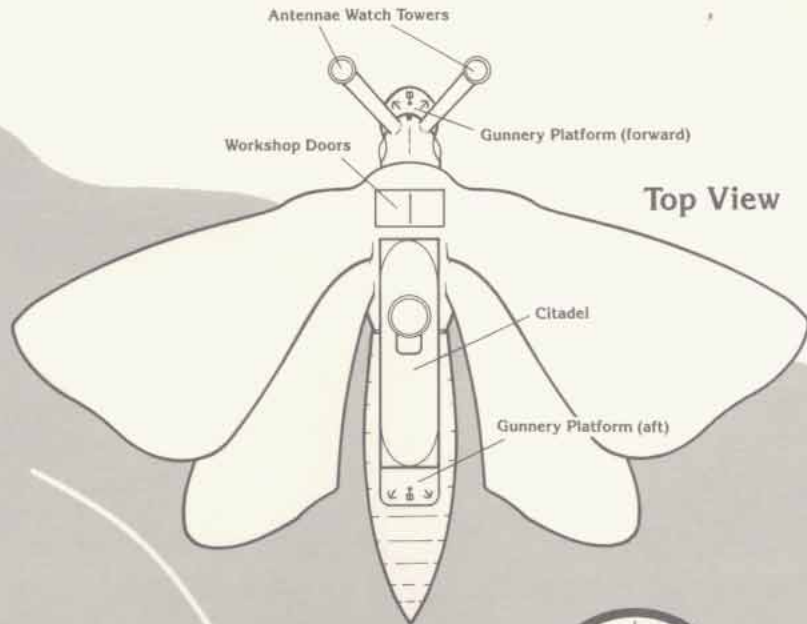

Monarch Citadel



Advanced Dungeons & Dragons  
2nd Edition

# SPELLJAMMER™

Adventure

## Skull & Crossbows

by Nigel D. Findley

### TABLE OF CONTENTS

Introduction .....	2	Void Elves .....	32
Letters of Marque .....	3	Monarch Armada .....	35
Chapter 1: Pirates & Corsairs .....	6	Time Capsule .....	42
Flying Colors .....	6	The Outpost .....	43
Small Package Trade .....	10	Jihad! .....	50
Pirate Wym .....	13	Chapter 4: Monsters of the Void .....	54
Bloody Vikings .....	14	Billy Bones .....	54
Fire & Ice .....	16	Parasite! .....	54
Chapter 2: Relics & Hulks .....	19	Chapter 5: Rewards and Revenge .....	58
Violent Death .....	19	X .....	58
Forgotten But Not Gone .....	24	Cain .....	59
Sojourn Among the Stars .....	27		
Chapter 3: Starfaring Races .....	30	New Monster: Death Shade .....	63
The Brain Trade .....	30	New Monster: Space Drake .....	64

### CREDITS

**Design:** Nigel D. Findley  
**Editing:** Steven Schend, Anne Brown  
**Cover Art:** Brom  
**Interior Art:** Paul Abrams  
**Cartography:** Diesel  
**Graphic Design:** Stephanie Tabat  
**Typography:** Angelika Lokotz

©1990 TSR, Inc. All Rights Reserved. Printed in the U.S.A.

ADVANCED DUNGEONS & DRAGONS, AD&D, SPELLJAMMER, PRODUCTS OF YOUR IMAGINATION, and the TSR logo are trademarks owned by TSR, Inc.

Distributed to the book trade in the United States by Random House, Inc., and in Canada by Random House of Canada, Ltd. Distributed to the toy and hobby trade by regional distributors. Distributed in the United Kingdom by TSR Ltd.

This material is protected under the copyright laws of the United States of America. Any reproduction or other unauthorized use of the material or artwork contained herein is prohibited without the express written permission of TSR, Inc.

TSR, Inc.  
 POB 756  
 Lake Geneva  
 WI 53147  
 U.S.A.



**TSR, Inc.**  
 PRODUCTS OF YOUR IMAGINATION™

TSR Ltd.  
 120 Church End,  
 Cherry Hinton  
 Cambridge CB1 3LB  
 United Kingdom

# INTRODUCTION

Eight bells. The chime sounded clearly in the cabin of Derek Angrislic. *Captain Derek Angrislic.*

The owner of the cabin looked up from the small desk where he'd been filling out the ship's log. A roguish grin spread across his handsome face and reached his twinkling eyes. Eight bells. His ship, *Silent Witness*, should be almost up with the fleeing illithid nautiloid by now.

Derek's smile now grew more predatory than roguish. His eyes still flashed, but no longer with humor. He shouldn't even be involved in this pursuit. The matter should have ended almost as soon as it began. That illusion that gave the illithids time to—almost—escape . . . he should have recognized it for what it was. That's what a captain was supposed to do: make correct decisions, all the time, every time.

At least the initial combat had gone well, and his crew had deported themselves well. As the nautiloid slowed to make its way through the inner debris ring of this oh-so-strange system, the *Silent Witness*—an elven Man-o'-war that Derek had, er, acquired through some rather intricate triple-dealing—slipped out from behind one of the larger planet-fragments, and the fight was on. Derek was operating under letters of marque from his government, so his crew was liberally sprinkled with battle-hardened, government Marines (the joys of working with the authorities for once). The first rounds from his medium catapults had torn holes in the enemy's rigging, and jettison fire had cut down the nautiloid's heavy weapons crews. As the ships drew nearer, Derek's mage, another government appointee, had sent necromantic death across the ether to seek out the illithids' helmsmen.

Just when victory was within reach, the other nautiloids had swung out from behind the planet-fragments: a picture-perfect reverse ambush! Under Derek's command, the *Silent Witness* maneuvered, fired, and moved to engage the new, undamaged attackers. By the time anyone realized that the new attackers were merely illusions, albeit illusions of a somewhat frightening scope, the true nautiloid was underway and attempting to clear

the debris belt so it could go to spelljamming speed.

The nautiloid would not escape—not if Derek could help it. His ship was faster and more maneuverable. The nautiloid had racked up a decent lead, and a stern chase was always slow, but the outcome was simply a matter of time.

Captain Derek Angrislic closed the log and laid his hand against the iridescent ceramic bulkhead. The *Silent Witness* felt charged with power and promise. Its anticipation seemed to match his own . . .

## DM INFORMATION

Welcome back to the SPELLJAMMER™ universe! *Skull & Crossbows* is the second adventure in the SPELLJAMMER game system. It provides adventures and encounters for the SPELLJAMMER universe, highlighting pirates and corsairs, ghost ships, new monsters, and old monsters in a new light.

In general, these adventures are intended for an average party of four to six characters, levels 6-10. They are stand-alone adventures, not tied to any particular campaign universe (Krynn, the Forgotten Realms, or the World of Greyhawk). This ensures that all DMs can find this material equally useful and don't have to do any extra work to align it to the politics of their campaign world.

*Skull & Crossbows* can be used as a continuation of the campaign started in *Wildspace* (SJA1), with the PCs possibly in command of the good ship *Skyrunner*. It can also be played independently from *Wildspace*, but these adventures take place in the Flow, wildspace, and on worlds in as-yet undiscovered spheres, so the PCs must already own or be on board a spelljamming vessel. Pages 7-9 of *Lorebook of the Void* contain many alternate ways for PCs to enter the SPELLJAMMER campaign. For example, the tradition of the press gang has migrated into space, and a ship that has lost crew in a battle will probably be willing to "hire" veteran adventurers regardless of any spacefaring experience.

## Adventure Format

The first adventure in the book, "Letters of Marque," is an introduction to

some interesting NPCs, and a way for the DM to lead the PCs into a career of pirate-hunting. This adventure comes to completion in the final adventure, "Cain."

The majority of *Skull & Crossbows* is a "grab-bag" of adventures in which the PCs bring safety to the space lanes. Many relate directly to the PCs' pirate-hunting, but others are encounters that the DM can use at any time. This provides the DM with the a large amount of flexibility to choose which adventures to use and the order in which they appear. Each chapter contains multiple adventures related to a central topic (Pirates & Corsairs, for example, or Relics & Hulks), giving the DM a variety of encounter types to choose from.

Each adventure has a number of "set-ups:" possible entry points by which the PCs get involved in the action. Most set-ups assume that the PCs command their own vessel, and at least one setup will have plot ties to "Letters of Marque." Each adventure has suggested levels for the PCs involved and details on recommended ship types. After all, there's little sport in sending two PCs in a mosquito ship up against a neogi deathspider!

## Terminology

Most adventures involve ship to ship encounters between spelljamming vessels. For ease in discussing these encounters, several standard terms should be defined:

### Bearing

This refers to the position of another object with respect to the bow or axis of your vessel. It conveys no information about which way the other object is travelling.

Since space combat takes place in three dimensions, the bearing of an object has two components: angle to port or starboard (left or right) of your vessel's bow, and angle above or below your vessel's gravity plane. A complete bearing might be expressed as "Enemy vessel 30° to port and 15° high!" A lookout—usually in something of a hurry—might just call "Enemy vessel high on the port bow."

Figure 1 indicates an object at a bearing of 45° starboard and level with the ship's gravity plane.



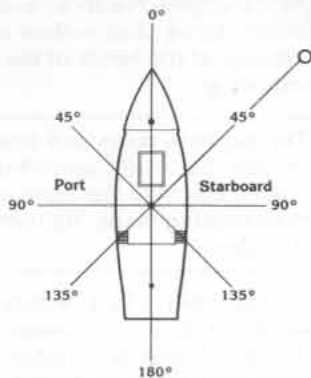

Figure 1:  
Bearing

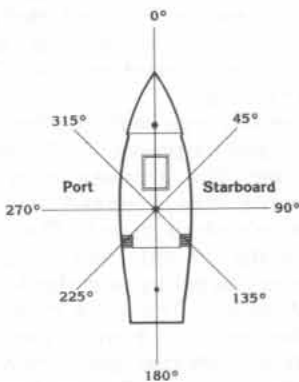

Figure 2:  
Heading Scale

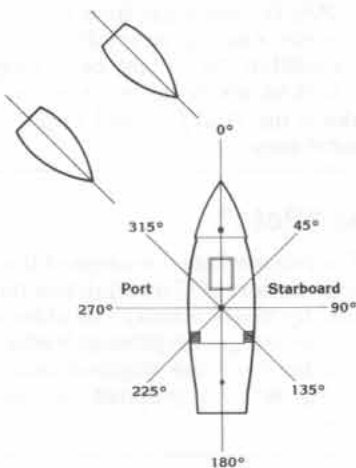

Figure 3:  
Heading Example

## Heading

This is the direction in which a vessel or an object is moving. The most precise way to express the heading of another vessel is in relation to the heading of your own vessel. The convention is to label the direction in which your vessel is travelling as 0°, and to count degrees in a clockwise direction.

Since space is three-dimensional, you again need two components to precisely describe the heading of a ship: one where 90° is directly to starboard (see Figure 2) and one where 90° is directly overhead. Determining and expressing heading is often complex, and, in the heat of battle, shorthand methods are used: "She's heading directly away from us, Captain," or "She's on a collision course!"

Figure 3 illustrates two enemy vessels which both have headings of 135°.

## Letters of Marque

Setting: Rock of Bral  
Party: 4-6 characters; levels 4-10  
Ship: Any

## Setups

- The PCs are spending some time on the Rock of Bral, perhaps recovering from the hardships of the *Wildspace* adventure, or simply looking for a little R&R. They are currently enjoying the diversions of a rough tavern near the landing docks called "The Rockrat." (Perhaps the PCs' tastes already run in this direction, or perhaps they have other reasons for slumming.)

- The PCs are on the Rock of Bral. A messenger delivers an invitation to a business meeting, in which they will learn about a potentially lucrative business opportunity. The meeting is that evening in a tavern called "The Rockrat." Neither the message nor the messenger can give the PCs any hint as to who they'll be meeting or what the opportunity may be, but the messenger is prepared to give the party 1-6 platinum pieces as token of the correspondent's earnest.

The Rockrat. You've never been to this filthy, decaying bar before, but you know it well. You've seen it many times before. It's a portside tavern, plain and simple, and the fact that this

port fronts the depths of wildspace rather than the depths of an ocean makes little difference. It's a place for crews to lose some money, drink yourself blind, and maybe, just maybe, get into a nice, diverting brawl.

You hesitate in the doorway a moment, looking around for any old acquaintances among the patrons. Not a friendly soul to be found. As you enter, a mountain of flesh blocks your way. "Weapons," the obstacle growls. "Check'em or lose'em."

## Grinder

The obstacle is the bouncer, an ogre named Grinder. The Rockrat has a policy: no weapons inside. Everything even remotely offensive must be checked at the door and stored in a small room under the guard of Grinder. It is more than the ogre's job is worth to let anyone get by armed . . . and he values his job.

**Grinder (Ogre):** AC 2; MV 9; F9; hp 80; #AT 3/2; Dmg by weapon (club (1-6), shortsword (1-6)) +6 Str bonus; Str 18(00), Dex 13, Con 18, Int 9, Wis 7, Cha 13; AL N; THAC0 12. Grinder is eight feet tall with gray skin, and the bulges of his muscles have bulges on them. He wears a nicely-tailored uniform that looks totally out of place at The Rockrat. The sleeves of the uniform conceal a pair of ogre-sized *bracers of defense* AC2. He is totally loyal to his employer, and will respond violently to any attempted bribes.

Grinder won't physically search the PCs; he knows that most of the tavern's usual patrons wouldn't put up with that affront. Obviously, he won't let anyone enter with weapons such as swords, but he is unlikely to catch every concealed throwing knife or boot dirk. If the PCs want to smuggle weapons inside, they probably can do it. The idea of this search is to eliminate such major weapons as two-handed swords and wheel lock pistols.

PCs armed with magic or otherwise valuable weapons are unlikely to agree to leaving them in the care of Grinder. That's not the ogre's problem. If they don't want to live by the tavern's rules, which are for their own protection, he will point out that they are free to drink elsewhere.

**Note:** The intention here is not to get the PCs into a confrontation with

# INTRODUCTION

Grinder, but to prevent the PCs from chopping down any of the NPCs they'll meet hereafter. Grinder's charisma is high for an ogre, and this makes it possible for him to help the PCs see reason. If the PCs protest, read them the following:

As you begin to protest the removal of your weapons, a robed figure quietly moves between you and Grinder. "Evening, Grinder," the mage says in a cracking voice. "Take care of Storm-fire for me, will you?"

"Be glad to. Your table's waiting," Grinder says to the mage, taking his staff and letting him pass. "Now, what's your problem with our policy?"

Grinder takes his job very seriously. Just as he won't let anyone in without checking their weapons, he won't let any "friends" make off with weapons that don't belong to them. As an employee of the establishment, he's entitled to be armed: he carries a club and has a short sword sheathed on his belt.

Once the PCs have passed Grinder, read the following:

The Rockrat's ceilings are low, and probably were white once; the kindori-oil lamps and the interesting selection of pipe blends burning around the room have certainly changed that. The floor is covered with a light coating of sawdust to sop up spilled drinks and other fluids. The tables are heavy, the rough wood extensively embellished with initials, names and generally tasteless graffiti.

The patrons match their environment: seedy, rather the worse for wear, and almost humming with an undercurrent of violence, barely repressed. Of the twenty or so pairs of eyes you can see, only two or three aren't dulled with alcohol.

Most customers are run-of-the-mill deck hands, many of them drinking away the bounty money they received for signing on with a new ship. In twelve hours, most will be a-sail and sweating green, with pounding heads. Only the occupants of two tables are different. One table, near the door, is taken by two middle-aged men, dressed in simple, dark, knee-length blue tunics. There are marks on the waists of their tunics where sword belts used to be buckled.

The other table, in a back corner, is much less austere. There are five figures around it, four of whom are approaching the final stages of intoxication. The four are a tough-looking lot: all humans, but big enough to rival Grinder pound for pound. Their outfits are as mismatched as anyone's around the tavern, save the black leather vest that each wears. The fifth occupant of the table is of a different cut entirely. Stone cold sober, he seems, and his eyes are as hard and cold as an arctic icecap. He wears tight fitting black leathers, the only flash of color being a red bandanna at his throat. As you enter, the occupants of the table look you over, most with varying degrees of drunken hostility, but one with cold appraisal.

You make your way to a table toward the center of the bar. A barwench who looks tough enough to offer Grinder a few problems clears her throat noisily. "Well, what'll it be tonight?"

## Gort

As soon as the PCs have entered the bar, and before they can get involved in anything elsewhere, one of the occupants of the far table struggles to his feet and staggers over toward the PCs.

Pig-like eyes—so bloodshot as to resemble red-veined marble—regard you unsteadily. "Well," the figure grunts, alcohol heavy on his breath, "I guess your mothers let you stay out late tonight."

This man is named Gort, and he is drunk enough to want to goad any PC into a fight with him. He will continue his verbal abuse until someone in the PCs' party takes a poke at him. If he can't do that, he'll pick the largest and toughest-looking PC and take a swing at him.

**Gort:** AC 10; MV 12; F7; hp 41; #AT 3/2; Dmg by weapon (knife) +1 Str bonus; Str 17, Dex 11, Con 14, Int 10, Wis 6, Cha 7; AL NE; THAC0 14.

Gort is a big, ugly, bald-headed brute, covered with enough scars to hint at a less than temperate past.

However the fight starts, neither combatant should be armed (at first), so the only option is non-lethal combat; use the

"Punching and Wrestling" table on page 59 of the *Dungeon Master's Guide* for this encounter. Once Gort suffers some minor damage at the hands of the PC, read the following:

The big man roars and pulls away from you. Suddenly, something is in his hand, catching the light: a sharp, wicked-looking blade. He roars again and lunges.

Gort has drawn a knife which was concealed in his boot. The crowd reacts to this breach of rules in the usual manner: they draw back to a safe distance and start placing bets. Before the other PCs can interfere, and before either combatant can kill the other, read the following:

"Gort!" The word sounds like the crack of a whip. The black-clad man at the far table is on his feet, and his flinty eyes are hard and cold. "Gort!" he snaps again.

The big man with the knife hesitates, and is promptly disarmed by Grinder. The drunken men slowly shamle out, coaxed along by Grinder's short sword. The man in black, their captain, you presume, appraises you coldly, and also leaves.

"Animals." The voice comes from behind you. You turn to see the two austere, dark-clad gentlemen standing behind you. "Do you know who they are? Who he is?"

"Cain," his younger partner repeats, and spits on the already much spit-upon floor. "Pirate."

"May I?" the older man asks as he slips into a seat at your table. "I have a proposition that might be of interest to individuals courageous enough to take it up. And I think I might have found some . . ."

## The "Pots"

The two men are members of the Pragmatic Order of Thought (called the "Pots" by its detractors). The older is Jasson, the younger his protege Wallis. If the PCs show even the slightest interest in hearing Jasson's proposition, read the following:

"If you know anything about the Pragmatic Order of Thought," the older man says, "you will know that



one of our central precepts is that travel and trade should be unrestricted. Only through this freedom will we see the universe develop in the unfettered, unbounded way in which we think it must. Unfortunately, this freedom which we see as so essential is being infringed."

The younger man interrupts abruptly, "By them," he snarls, gesturing over his shoulder with a thumb toward where Cain and his crew were sitting. "The pirates."

"My protege is correct," Jasson agrees calmly. "We believe that the pirates who hunt wildspace are the greatest single obstacle to free and efficient trade between the shells. We believe it is our responsibility and our privilege to do our small part to solve this problem. Thus we come to our proposition."

Jasson places a leather dispatch case on the table before you. "In here I have letters of marque," he tells you, "officially notarized by my superior in the Order and by Prince Andru of Bral himself. Do you know what letters of marque are?"

Again the younger man jumps in. "They are official permission to make war on all pirates," he tells you. "Your right to engage them and to deal with them as you will is unchallenged."

"Also," Jasson adds, "these letters also entitle you to quite a substantial bounty whenever you bring in one of these wolves of wildspace . . . either dead or alive. You may also, of course, keep whatever you can take from these reavers. I would ask you to accept these letters . . ."

Jasson holds up a hand to still your response. "But before you do, there is more to our offer. If you currently command a ship, the Order will pay for a complete refit and repair at the Rock's construction docks. If you currently are, shall we say, between ships, I am authorized to tell you that the Order will supply a ship. Will you, now, accept our proposition?"

**Jasson:** AC 5; MV 9; F9; hp 46; #AT 3/2; Dmg by weapon; AL NG; THACO 12.

**Wallis:** AC 5; MV 9; F6; hp 40; #AT 1; Dmg by weapon; AL CG; THACO 15.

Both "Pots" wear chain mail under their tunics. Although unarmed while in-

side the bar, they normally carry long swords.

Jasson and Wallis will answer any questions the PCs care to ask them. They are truly members of the Pots, and can supply complete verification that the letters are authentic. They also supply the PCs with a list of notorious pirates and the bounties on each one, but they can give the PCs no information about where these pirates can be found. The pirates on the Pots' hit list are:

Pirate	Ship	Bounty
Tal	<i>Barracuda</i>	8,000
Gilgalad	(Hammership)	gp
Erik ?	<i>Raven</i>	5,000
	(Groundling ship)	gp
?	<i>Frostfire</i>	7,000
	(Squidship)	gp
Manara	<i>Nex</i>	10,000
	(Galleon)	gp
Cain	<i>Rampage</i>	10,000
	(Hammership)	gp

True to their word, Jasson and Wallis will arrange to pay for repair and refits to the PCs' vessel (should they have one). They will pay for repairs and maintenance, plus resupply. They won't pay for a complete re-arm or for serious modifications such as a new major helm, plating, etc. If the PCs have no vessel, the Order will turn over to them a simple, unmodified Tradesman armed with a light catapult and a light ballista. In neither case will the Order pay for the hiring of additional crew; that is entirely up to the PCs (Note that a Tradesman requires a minimum crew of 10 to run properly, so PCs may need to hire a crew).

## Bon Voyage

When the refit is complete, or when the PCs are about to take possession of their new ship, Jasson meets them for the last time. He has in his possession the letters of marque. Read the following:

Jasson looks considerably more imposing than he did when you first saw him in the port-side bar. He wears a mail coif over his silver hair and a bejewelled long sword at his side. He hands you four sheets of parchment, each covered with fine calligraphy and bearing two elaborate seals: one of the Order and one of Prince Andru himself.

"These are your letters," he tells you. "Four copies, in case you wish to commission other ships to assist you. It is important to stress one thing. These letters entitle you to war on vessels in wildspace or in the Flow. They do not authorize attacks or assassination attempts against anyone when they are not on a vessel underway. Thus, you could not have killed the pirate Cain in the tavern and expected to be covered under letters of marque."

"Er . . ." Jasson clears his throat, and for the first time you see the man hesitate. "There is one small addition to the letters," he says almost apologetically. "Just a trifle, but Prince Andru insisted upon it. These letters also give you full authority and, in fact, urge you to make war on any vessels that you know to belong to the mercenary company the *Tenth Pit*. But," he goes on, suddenly firm again, "be that as it may, may what gods there are look kindly upon your brave mission. Fare you well."

## Concluding the Adventure

In fact, the conclusion of this adventure is the beginning of others. The deal with the Order will remain in force until one side or the other cancels it for good cause. If the PCs wish to claim bounty on a pirate, they must literally bring the person (or persons) in, either dead or alive.

For more information on the Pragmatic Order of Thought and the Tenth Pit mercenary company, consult the *Lorebook of the Void*, pages 51 and 52.

# CHAPTER 14 PIRATES & CORSAIRS

Contrary to common belief, there is a significant difference between a pirate, and a corsair or privateer. By definition, a pirate is anyone who robs or commits illegal violence at sea (or in space). Thus, nearly any unscrupulous person can be a pirate: simply acquire a ship and go plunder the spaceways.

In contrast, a corsair or privateer is defined as one hired or commissioned by a government to attack or harass enemy ships. A privateer, then, is an official instrument of national policy, given authority by documents called "letters of marque" to act as a pirate . . . but only against enemy vessels. (Historically, France, England, Spain and Portugal frequently sent forth corsairs to harass each other's shipping.) A privateer will usually hoist his own country's flag while in action, whereas a pirate may sail under false colors long enough to get close to his target.

Apart from the official niceties, however, there are few differences between pirates and privateers . . . particularly if your ship happens to be their selected prey. Perhaps it's more important to realize that not all pirates are human or even humanoid, and not all pirates need ships . . .

## Flying Colors

Setting: Wildspace

Party: 4-6 characters, levels 6-8

Ship: Any (30 tons + recommended)

## Setups

- The PCs have heard rumors that one of the pirates on their bounty list—Tal Gilgalad—is operating in a certain region of wildspace. They are now investigating that area, travelling at tactical (not spelljamming) speed.

- The PCs are commanding, or serving on, a ship currently in wildspace, and travelling at tactical (not spelljamming) speed.

"Captain!" the lookout yells. "Vessel high on the port bow."

You train your eyes on the area in question, above and to the left of your ship's main axis. Nothing . . .

Yes, there it is, momentarily catching the light of distant suns as it maneuvers toward you. You recognize it

at once: a Hammership. The vessel is painted night-black, making it difficult to spot against the ebony backdrop of wildspace. But there, on the mainmast, is a bright splash of color . . .

Any character with a telescope or enhanced distance vision can see that the flash of color is a flag, and can immediately recognize it. It is the flag of a nearby world (or state) that is considered peaceful. (The DM must choose an appropriate candidate based on current circumstances. Some suggestions are Sembia in the Realms or the Prelacy of Almor in the world of Greyhawk.)

The Hammership is 7,000 yards (14 hexes) distant when first spotted. Its bearing is 30° to the left of the PCs' ship's heading.

The Hammership is on an intercept course with the PCs' vessel, travelling at a speed of 2 hexes per round. No crew are visible on deck, and no major weapons appear to be loaded.

## The Good Ship *Barracuda*

Despite its peaceful approach, the Hammership's intentions are far from peaceful. It is, in fact, the pirate ship *Barracuda*, commanded by a rogue elf named Tal Gilgalad.

The *Barracuda* fits the normal statistics for a Hammership, except a third heavy catapult has been installed just behind the cargo doors. It is mounted on a rotating turret, allowing it to fire in any direction except directly forward (because of the mainmast). This third catapult is always manned and loaded. Except during combat, it is disguised by a *phantasmal force* spell (cast by a gnome illusionist on the crew) as a secondary wheelhouse.

Tal Gilgalad has also equipped the ship with a minor helm, as back-up in case the major helm goes down. This is installed in the first officer's quarters.

## Captain and Crew

**Tal Gilgalad:** AC 6; MV 9; F8/W2; hp 56; #AT 3/2; Dmg by weapon (long sword (1-8), wheel lock pistol (1-4)) or spell; Str 15, Dex 15, Con 12, Int 15, Wis 10, Cha 17; spells: *burning hands*, *affect normal fires*; AL NE; THACO 13. He wears scale

mail and carries a long sword and a pair of wheel lock pistols (these are more for appearance's sake than practicality; Tal knows how undependable the pistols are).

Tal Gilgalad is a young firebrand of an elf, no more than 250 years old. He was raised "dirtside" by parents who believed more in the power of the word than of the sword. They believed so steadfastly that they refused to take up arms when their homeland was invaded by orcs, and died at the hands of the invaders. Tal, a youth of less than a score summers, managed to escape to the mountains, where he eked out an existence for a number of years. The orcish invaders were eventually driven out and Tal could return to elvish civilization, but the damage was already done. The major lesson he learned from his sojourn in the wilderness was that the universe is not a kind place, and the only creatures who get what they want are those who take it.

When the *Barracuda* put down near Tal's home, looking for replacement crewmembers, Tal signed on immediately. He impressed captain and crew alike with his initiative and competence . . . and chilled them with his frightening indifference to taking life. While he wouldn't go out of his way to kill and would spare the lives of those victims who surrendered to him all their valuables, he would not even think twice about slaying anyone who stood between him and his spoils. When the pirate captain was killed in an encounter with a neogi mindspider (which the *Barracuda* survived only through Tal's quick thinking), Tal Gilgalad took over command, with the full support of his crew.

Since then, the *Barracuda* has racked up many scores throughout the spaceways. Tal hits only ships that he believes are full of plunder. If the target strikes its colors and hands over everything of value, Tal lets the emptied ship go. Tal will demand the target's entire cargo, plus anything of value possessed by the crew or passengers, particularly magical items. He normally considers prisoners too much trouble, and will consider changing this policy only under the rarest of circumstances (for example, if he realizes that someone aboard his target can be safely ransomed for a large sum).

If, however, the target decides to fight, Tal will willingly destroy the vessel



and kill all its crew if that's what it takes to acquire its cargo.

Tal Gilgalad's crew is led by four officers—Berwick, Hallan Deepdelf, Lara Mooncrow and Vissq. His spelljamming helmsman is a woman who calls herself Manta. Thirty-four crack crewmembers complete the ship's complement of 40. Most of the crew have sailed with Tal for some time, and all are experts at space-faring maneuvers and mayhem; their morale is 13.

## The Officers

**Berwick:** AC 5; MV 9; F9; hp 71; #AT 3/2; Dmg by weapon (two-handed sword (1-10), hand crossbow (1-3)) +1 Str bonus; Str 17, Dex 11, Con 16, Int 13, Wis 9, Cha 15; AL N; THAC0 12. He wears chain mail and carries a two-handed sword. A hand crossbow always hangs from his belt. He is a good-looking human of middle age, with black hair streaked with

grey. Despite his great strength, he does not appear at all musclebound.

Berwick is a veteran space-going mercenary, and has served Tal for seven years now as first officer. Although well versed in ship-to-ship tactics, his greatest value is in leading boarding parties (boarding party morale +3).

**Hallan Deepdelf:** AC 6; MV 12; T4/W(1)4; hp 19; #AT 1; Dmg by weapon (short sword (1-6), dagger (1-4)) or spell; Str 10, Dex 16, Con 11, Int 16, Wis 11, Cha 14; spells: *change self*, *color spray*, *phantasmal force*, *ventriloquism*; *hypnotic pattern*, *improved phantasmal force*, *mirror image*; thief abilities: PP 50%, OL 50%, F/RT 60%, MS 40%, HS 20%, HN 25%, CW 60%, RL 0%; AL CN; THAC0 19. Hallan the gnome wears leather armor and carries a *short sword +1* and a pair of throwing daggers. He is 310 years old.

Hallan was enjoying a profitable career as a freebooting thief-illusionist, until he

"helped carry that ungrateful old man's excessively heavy purse" in a port town. Things became rather uneasy, and Hallan had to think about making a fast getaway. Fortunately, the *Barracuda* had come into the harbor for reprovisioning. Hallan somehow managed—mainly through lying—to persuade Tal to take him on as a crewmember.

To everyone's surprise, most of all Hallan's, the gnome took to space like a duck to water. He quickly learned how to handle the ship, and showed a natural aptitude for navigation and celestial mechanics. With total disregard for certain jokes popular at the time ("Better a hole in the hull than a gnome at the map table," etc.), Tal promoted Hallan to navigator. Although Hallan retains an aggravatingly happy-go-lucky attitude about everything else, he is deadly serious when it comes to his navigation.

It is Hallan who casts the *phantasmal force* spell that conceals the third catapult.



**Lara Mooncrow:** AC 3; MV 12; W8; hp 18; #AT 1; Dmg by weapon (dagger (1-4), darts (1-3)) or spell; Str 9, Dex 12, Con 8, Int 16, Wis 10, Cha 13; spells: *charm person, friends, sleep, taunt; scare, ray of enfeeblement, Tasha's uncontrollable hideous laughter; hold person, suggestion, wraithform; enchanted weapon, Leomund's secure shelter*; AL LE; THACO 18. Lara is a female human of striking beauty. Her hair is waist-length and golden blonde, and her eyes are a bright and piercing blue. She wears no armor, but depends upon a pair of *bracers of defense*, AC 3. She is armed with a *dagger* +2 and 6 darts. She also wears a *ring of shooting stars*.

Lara Mooncrow's earlier career involved a number of unpleasant activities in a number of different crystal spheres, including assassination. Her luck eventually ran out; she was captured and put aboard a spelljamming vessel which was to take her back to her home planet for trial. As fate would have it, the ship was attacked by the *Barracuda*, and Lara managed to make her escape during the battle, using spells to cover her trail as she stowed away aboard the pirate vessel. Only after the battle was over did she show herself and apply to Tal Gilgalad for a job. He hired her immediately, and never once regretted the decision.

As ship's mage (the highest level wizard other than the helmsman), she advises the captain and helps during battles; her *ring of shooting stars* makes her a creditable addition to the *Barracuda's* firepower. She also takes a shift as helmsman, although her spelljamming ability is considerably less than that of Manta, the regular helmsman. In addition, she has developed great skill in aiming the ship's main weaponry, making her a specialist in both heavy catapults and heavy ballistas.

Lara Mooncrow's manner is cold and withdrawn, speaking only when spoken to, and then in as few words as possible. She has an even more offhand attitude to taking life than does Tal Gilgalad.

**Vissq** (lizard man): AC 5; MV 6; F10; hp 74; #AT 3 or 1; Dmg 1-2/1-2/1-6 (claw/claw/tail) or by weapon (bastard sword (1-8/2-8), throwing axe (1-6)) +1 Str bonus; Str 16, Dex 12, Con 16, Int 10, Wis 8, Cha 9; AL N(E); THACO 10. Vissq is a lizard man, standing seven feet tall. He wears

no armor; instead, his light green scaly skin is decorated with elaborate tattoos and painted-on designs. He carries a bastard sword, and a throwing axe hangs on his belt.

Vissq is Tal's sergeant-at-arms and personal bodyguard. He speaks Common haltingly and with a harsh sibilant accent. Although he shares his race's impatience with warm-blooded creatures in general, he feels grudging respect toward Tal Gilgalad (Vissq finds the elf's attitude toward taking life to be refreshingly cold-blooded). Even if this weren't the case, he'd feel duty-bound to follow Tal: the elf saved him from a neogi lifejammer.

Vissq will sometimes assist Berwick in leading boarding parties. This doesn't always work out too well, since Vissq is unwilling to take orders from anyone except Tal. During boarding actions, Vissq usually holds back and waits, joining the boarding party if the men begin losing.

**"Manta":** AC 10; MV 12; W12; hp 30; #AT 1; Dmg by spell; Str 9, Dex 12, Con 10, Int 17, Wis 11, Cha 8; spells: *cantrip, chill touch, magic missile, wall of fog; darkness 15' radius, spectral hand, stinking cloud, web; feign death, hold undead, lightning bolt, vampiric touch; contagion, enervation, ice storm, Otiluke's resilient sphere; animate dead, magic jar, summon shadow, wall of force; death spell*; AL N; THACO 17. Manta is a middle-aged human female, unattractive and a bit overweight. She always wears black, loose-fitting clothes and keeps her head covered with a cowl. She carries no weapons.

Nobody knows Manta's real name or her true background. Tal first met her on the Rock of Bral, where she was serving Prince Andru. Tal recognized her talent (as well as her ruthlessness) and hired her away from Andru with promises of great plunder. Manta feels no loyalty toward Tal, or to anyone else, and Tal knows it. He fears a confrontation will come, but until then, she's a useful addition to the crew.

Manta is main helmsman for the *Barracuda*, and spends most of her days at or near the major helm. If firepower is more important than spelljamming speed in an expected encounter, Tal Gilgalad will use Lara Mooncrow at the helm, while

Manta is on deck to cast spells.

Manta speaks to no one, not even Tal Gilgalad. She is impatient and touchy, and responds violently to insult, intended or not.

## The Crew

The *Barracuda's* complement of 40 is rounded out by 34 crack crew members. All are armed with broad swords plus a personal sidearm (usually a dagger or hand axe), and wear leather armor. Fifteen also carry heavy crossbows; the balance carry wheel lock pistols. Among the ship's stores are 20 boarding pikes.

A typical crewmember will have the following statistics:

Crewmember: AC 9; MV 12; F1; hp 1-10; #AT 1; Dmg by weapon (broad sword (2-8); heavy crossbow (2-5); or wheel lock pistol (1-4)); AL N; THACO 20.

The crew are all cross-trained. Thus, any crewmember is equally competent working the rigging or operating the heavy weapons. Their level of training is high, as is their morale (13). The respect in which they hold their captain translates to a high level of loyalty toward him. They are very unlikely to consider bribes.

## Battle Tactics

Tal's favorite tactic is to approach under false colors, flying the flag of a convenient and totally unaggressive nation. In keeping with this disguise, the *Barracuda's* major weapons are unloaded and unmanned . . . except for the magically concealed third catapult, which is loaded and ready to fire. The only crew visible on deck are those few required to maneuver the vessel; the others are concealed below decks. These factors, coupled with the *Barracuda's* relatively slow rate of approach, usually lull the target ship into a false sense of security.

Tal Gilgalad will slowly approach the PCs' ship, coming as close as they'll let him. Should the PCs hail him in any manner, he'll reply that he has some information that he's been ordered to pass on to any vessel he meets. "There's a neogi deathspider somewhere in the system, preying on ships," he lies. "I have a chart showing in which areas most of the attacks have occurred." He will continue with this deception as long as he can.



When Tal has closed with the PCs' ship as much as he thinks he's able, he pulls down his ship's false flag and replaces it with a black flag, a scarlet neogi skull on it—the pirates' flag! Simultaneously, the gnome illusionist drops the *phantasmal force* concealing the third heavy catapult, and the weapon crew fires a shot at the PCs' vessel. This shot is aimed at the hull, but is intended to intimidate more than injure. If the PCs' ship is particularly big, Tal will order Lara Mooncrow to fire her *ring of shooting stars* at the vessel. As his crew swarms on deck and begins loading all the heavy weaponry, Tal Gilgalad hails the PCs' ship and demands their surrender.

Should the PCs refuse to strike their colors and surrender, Tal Gilgalad pushes home the attack in the most efficient method. First, he'll order a shearing attack, followed by an attempt to grapple and board. If the PCs' vessel is well-manned, he'll use his catapults and Lara's magic to "sweep the decks" before boarding. He'll ram only as a last resort. He will continue to fight until it's obvious that the fight's going against him—in which case he'll try to escape, using his stern catapult and perhaps Lara's ring (if she hasn't already used all of its powers) to keep the PCs off his tail, or until the PCs have been defeated.

Note: Tal Gilgalad still has much lingering hatred toward orcs. Should the captain of the target ship be an orc or a half-orc (unlikely but possible), Tal will not ask for surrender at all, but will simply press the attack to its conclusion.

Despite his indifference to causing death, he will rescue survivors should the PCs' ship be destroyed. Odds are he'll sell them to the first prospective buyer he can find; Sisk Hal of the *Collector* might be interested in some new slaves for his "Brain Trade" in Chapter 3 . . .

Tal Gilgalad is an intelligent captain. As such, he knows when targets are just too big for him to handle (a tyrant ship, for example). Tal Gilgalad will not attack a ship of more than 50 tons unless it looks seriously undermanned or exhibits evidence of inexperience (clumsy maneuvers, etc.).

## Terms of Surrender

### for PCs

Should the PCs surrender, Tal will demand that they hand over all cargo plus valuable personal possessions. He will send a prize crew aboard to make sure that his orders are carried out (the size of this crew depends on how powerful the PCs look; Tal isn't dumb). After he has his hands on the plunder, he'll order his prize crew to destroy the ship's rigging (decreasing its maneuverability). He will then sail off without any immediate worry of pursuit.

### for the *Barracuda*

If the fight should turn against the *Barracuda* and it can't make its getaway, Tal Gilgalad will not surrender; rather, he'll fight to the death. The same is not necessarily true of the others on board, of course.

As Tal's bodyguard, Vissq will give his life to save his master's . . . but only if Tal isn't fighting a "no-win" situation. If Tal has a chance to save his life by surrendering, but chooses to fight, then Vissq considers that to be suicide, which terminates any obligation he has to the elf. On his own, Vissq will fight until an opportunity arises to honorably save his own life. (Surrendering to an overwhelming force isn't cowardice; it's simply good sense. To be honorable, however, surrender must come only in response to a request from a powerful enemy. Thus, if Vissq is surrounded and a PC asks him to surrender, he can do so honorably.) If no honorable opportunity for surrender presents itself, Vissq will fight to the death.

Berwick and Lara Mooncrow are a little less particular about honor. Both will throw down their weapons if the only alternative is their deaths. Berwick will abide by his surrender, hoping to persuade the victors to take him aboard (that's how he joined the *Barracuda*, after all; it's simply the mercenary's code). Lara Mooncrow, on the other hand, will take any opportunity to slay her captors and escape.

Hallan Deepdelf will fight gamely unless he thinks his beloved star charts might be damaged. In such a case, he'll immediately do whatever it takes to pro-

tect them, including surrender. He has grown to enjoy this life as navigator, and may offer his services to the PCs.

If Manta is fighting from the deck, she asks no quarter and gives none. If she is in the helm, however, she will take no other part in the fray. She will surrender if the *Barracuda* is defeated and she has not been insulted by the PCs. She will do nothing to the PCs as long as they are at least marginally polite to her; should they insult her, however, she will remember the slight at a more opportune time . . .

The crew's behavior can be determined using standard morale rules.

## Concluding the Adventure

The *Barracuda* itself is a good prize, should the PCs manage to capture it. Its holds contain one hundred bolts of fine silk stolen from Tal's last victim; each bolt is worth 500 gold pieces. In addition, there are other small valuables stashed in Tal's cabin: a ruby ring (750 gp value), a platinum circlet (1,000 gp), a pair of gold-chased bracers (non-magical; 300 gp), and a diamond pendant (1,100 gp). Each crewmember also has personal possessions worth 10-60 gp (100-600 gp for officers).

Knowing the risks of space combat, Tal and his crew have taken precautions to protect their booty. Even if their ship is destroyed and they are captured, they can eventually make their way back to where their treasure is stashed and reclaim it. The *Barracuda's* wealth is cached on a number of planets, in a number of legal and illegal places. (One of the crew has bought an interesting tavern with his share of the plunder.)

If the *Barracuda* should win and make off with the PCs' valuables, that's not necessarily the end of the story. The PCs can try to follow the pirates immediately, or try to track them down later for revenge. On the other hand, if the PCs were particularly wealthy, the pirates might decide to follow the PCs' escapades, making another visit when the pickings are good again. As such, Tal Gilgalad can prove to be a convenient nemesis for the PCs in an ongoing campaign.

## Small Package Trade

Setting: The Flow

Party: 4-6 characters, levels 6-8

Ship: Tradesman, Wasp, or equal

### Setups

- The PCs are ashore, casting around for ways to make money, or looking for information necessary for their pirate-hunting careers. They receive a message from the bartender or other intermediary that "the Torgan Betz" wants to have a word with them. He is awaiting them in another tavern nearby, "The Drunken Neogi."

(Note: This adventure is intended for a group of PCs commanding their own small ship.)

Of all the joints in all the port towns of all the worlds you've visited, "The Drunken Neogi" would probably rate as the seediest. And that's certainly saying something.

The air is thick with smoke—an interesting mixture of tobacco and more exotic weeds, with a definite underpinning of burning rubber—and figures on the other side of the narrow barroom are little more than blurred shapes. A couple of lizard men, armed to the teeth, are standing at the bar, carrying on a hissing conversation over a bowl of bar snacks (some kind of weevils, you think). Over in the corner, three disreputable-looking illithids are puffing on a water pipe, adding a new and heady note to the

bouquet of the air. Across the room, a drunk and belligerent human is trying to challenge a bemused dracon to a bout of arm wrestling. And right next to you, a half-orc snarls a wildly improbable speculation about your heritage before planting its forehead firmly against the top of the table and starting to snore loudly.

In the entire bar, there's only one figure who is dressed at all well (apart from you, of course). He is sitting at a table in a back corner of the tavern, as far away from the general ruckus as he can. Tall and slender, with black hair and a well-trimmed black beard, he looks confident and competent . . . and dangerous. Torgan Betz, you assume. Standing behind him at formal parade rest is a giff, dressed to kill in an elaborate uniform that looks too over-done to belong in a comic opera. Both of these worthies fix you with steady dark eyes. Betz beckons you.

**Torgan Betz:** AC 2; MV 12; F9/T7; hp 90; #AT 3/2; Dmg by weapon (short sword (1-6), dagger (1-4), garrotte); Str 13, Dex 16, Con 13, Int 14, Wis 12, Cha 15; thief skills: PP 45%, OL 40%, F/RT 35%, MS 40%, HS 35%, DN 45%, CW 90%, RL 30%; AL N(E); THAC0 12. Betz wears *bracers of defense AC2* and carries a *short sword +2*. Carefully concealed on his person, he carries a *dagger of venom* and a *garrotte*. Betz will kill without compunction. He is brave, but not stupid: surrender (with the future chance of escape and exquisitely-planned revenge) is vastly preferable to death.

## The Contract

"You are looking for a contract?" Betz asks matter-of-factly. "Everyone is. Well, I have something for you. A small package that I wish delivered to another system. No complications, no danger. Just a desire to make sure the package is delivered as soon as possible, with no outside involvement. Fixed price, retainer to be paid up front, balance on delivery. Total contract is worth five thousand gold, your choice of currency. Retainer is fifteen hundred, cash, right now. Two conditions. One: the package is to remain unopened. On penalty of forfeit: remaining payment, your ship, your lives. Two: my associate here"—and he indicates the giff—"goes along with you. Now . . . do we have a deal?"

If the PCs accept the deal (or can haggle their way into a higher payment—a difficult task), Betz will arrange to meet them at a neutral spot early the next morning. He will have with him the package, the charts to their destination, their retainer, and the giff.

## The Deal

This may sound like a straightforward contract, but things are never what they seem when Torgan Betz gets into the act. Betz is famous (or notorious) as a "gray trader": not quite a smuggler or pirate, but one who bends the laws without breaking them. There are often speculations that his business dealings include activities that are out and out criminal, but no one has ever been able to bring forth any evidence. (Trying to do so seems to be an activity fraught with ill luck. Several investigators in the past have perished in freak accidents, including the fellow who tripped and fell backwards onto his own dagger, twice.)

On the surface, however, this particular deal looks as though Betz is playing matters straight. Betz is acting as middleman between two staggeringly rich (and somewhat senile) art collectors. One is selling a particular item to the other for the princely sum of 20,000 gp. Betz's job, for which he will receive a commission, is to make sure that the item gets to its destination. He is responsible for hiring transportation and pro-







tection. To make sure that nothing untoward happens, Betz has even offered to send his giff lieutenant along on the trip. It certainly looks as though Betz is on the up and up.

That's just on the surface, however. Betz definitely has other plans. One of his ships—a Wasp-class vessel—is waiting to ambush the delivery. With the aid of the giff on board, the crew of the delivery vessel will theoretically stand little chance. The hulk and bodies—along with that of a dead giff (not the lieutenant)—will be left to drift the spaceways. Betz's giff lieutenant will hie off with the Wasp and keep out of sight until the heat is off.

Betz will have the item, which he can then ransom back—through intermediaries, of course—to whichever of the collectors will pay the best price. Betz can calmly proclaim his innocence, and point to his actions as proof. Didn't he hire a crew of doughty adventurers to protect the prize? And didn't he send along his loyal lieutenant—killed in action, trying to discharge his duty—to act as special guard? No one can prove Betz guilty of any wrong-doing.

It's a good plan. The PCs are the perfect patsies, and all they have to do is obediently die at the proper time.

### Getting Underway

Betz meets the PCs at the specified time and place. As promised, he has the item—a sealed metal box about 6" on a side—their payment, charts to their destination . . . and the giff. For the first time, Betz formally introduces the PCs' travelling companion:

Betz gestures with his thumb. "And this is my right-hand man. Meet Second Assistant Sub-Colonel Dourm . . ."

"Brevetted," the giff puts in.

Betz nods. "Second Assistant Sub-Colonel (brevetted) Dourm Larbo."

The giff snaps you a picture-perfect salute. "Thank you, sah."

"So much for protocol," Betz says. "Don't you think you'd better be off?"

### The Giff

**Dourm Larbo (giff):** AC 6 (2); MV 6; HD 4; hp 25; #AT 2; Dmg 1-6/1-6 or by weapon +7 Str bonus; SA head butt; AL LE; THAC0 17. Larbo normally wears a ludicrously elaborate uniform; as soon as he's aboard ship, however, he puts on a suit of armor that lowers his AC to 2. He owns a wheel lock pistol with enough smoke powder for 10 shots, and never lets this prized weapon out of his sight.

In most ways, Second Assistant Sub-Colonel (brevetted) Dourm Larbo seems to be a typical giff: he's somewhat superior around the "little races," and a stickler for military correctness. In fact, however, Larbo is that most dangerous (and rare) of creatures: a cunning giff. He plays the part of the buffoon to the hilt, but is really much more intelligent than he lets on. He knows all the details of Betz's plan—in fact, it was Larbo who added some of the refinements—and will do his utmost to allay any suspicions that the PCs may have. (He'll also act the heavy to persuade the PCs not to take off with the loot.)

## Ambush!

The PCs' destination is in a nearby crystal shell. The time it takes to get out of the current shell depends on the system, but once their vessel is into the Flow, the remainder of the voyage takes only 10 days.

Betz has provided good charts, showing clearly a "river" in the Flow that will speed the PCs' journey. He's made sure that the PCs know about this river: that's where the ambush ship is waiting. (Torgan Betz dispatched it the night before the PCs' departure, as soon as he knew what kind of ship they'd be taking.) When the PCs' vessel enters the phlogiston and begins to maneuver toward the river, Betz's Wasp ship will attack.

As soon as the attack is underway, Larbo will do his part to make sure that it succeeds. His first order of business is to immobilize the PCs' ship by killing the helmsman. After that, he'll concentrate his attentions on who he considers to be the most powerful—and hence the most dangerous—PC. It's a giff's nature to follow orders, even unto death, so Larbo will fight to the end. He will only consider surrender if the ambushing Wasp is destroyed or driven off and he doesn't think he can finish off the survivors aboard the PCs' vessel.

## Wasp

The Wasp is "topped out" with additional rigging which improves its Maneuverability Class to C, and has a thickened hull, decreasing its Armor Rating to 5. It is armed with a greek fire projector (crew 3) in addition to its heavy ballista. The ship has an SR of 5. When it attacks, it will do so from an angle that minimizes the PCs' chance of outrunning it.

The Wasp is captained by one of Betz's most trusted lieutenants, a half-elf named Dorin Twostar, and helmed by a human mage named Ord Nellis. Twostar is assisted by his first officer, Harnakh, a flind. Its total crew is 18. The crew's morale (with one notable exception, mentioned below) is 14.

**Dorin Twostar:** AC 4; MV 9; F9; hp 46; #AT 2; Dmg by weapon (long sword (1-8), wheel lock pistol (1-4)); Str 15, Dex 12, Con 14, Int 13, Wis 11, Cha 14; AL LN; THACO 12. He wears splint mail, and is armed with a wheel lock pistol (ammuni-

tion and powder for six shots), a *long sword +1* and a dagger. As one of Betz's lieutenants, Twostar knows the details of the plan.

**Ord Nellis:** AC 10; MV 12; W10; hp 25; #AT 1; Dmg by weapon (*staff of striking*, dagger (1-4)); Str 10, Dex 12, Con 10, Int 15, Wis 12, Cha 12; spells: none; AL N; THACO 17. Nellis wears no armor, and carries a *staff of striking* (45 charges), plus a pair of daggers. She is only a "hired hand" on this operation, paid to operate the Wasp's spelljamming helm. As such, her morale is considerably lower than the other members of the crew (10). If things look bad, she'll definitely try to make her escape or surrender to the PCs. She knows none of the details of the plan, and is unaware of Betz's involvement; it was Twostar who hired her.

**Harnakh** (flind leader): AC 5; MV 12; HD 2+3; hp 25; #AT 2; Dmg 1-6 or 1-4; SA disarm; AL LE; THACO 17. Harnakh is armed with a flindbar (Dmg 1-4). He is quite fastidious for a creature related to gnolls. He is simply following the orders of his commanding officer, and knows nothing about Betz's plan.

**Senior Crewmember** (x6): AC 7; MV 12; F3; hp 11, 16, 17, 19, 19, 22; #AT 1; Dmg by weapon (heavy crossbow (2-5), long sword (1-8), dagger (1-4)); AL N; THACO 18. Senior crewmembers wear ring mail armor, and carry heavy crossbows plus long swords and daggers.

**Crewmember** (x9): AC 7; MV 12; F2; hp 4, 6, 6, 7, 9, 9, 10, 11, 11; #AT 1; Dmg by weapon (long sword (1-8), dagger (1-4)); AL N; THACO 19. Crewmembers wear studded leather armor, and carry long swords and daggers. In addition, each has access to a grappling hook.

## Tactics

Twostar's tactics are simple. By the time his ship is in range, Larbo should have immobilized the PCs' vessel. Twostar will then order his ballista and greek fire projector to quell any resistance aboard the target vessel, before boarding. Once he has his hands on the sealed box containing the item, he'll kill anyone left aboard the PCs' vessel, plant the dead body of a giff (dressed in a uniform similar to Larbo's, of course) that he's brought along in his ship's hold and leave the gutted ship to drift. (A day or so later, another ship owned by Betz will

"happen along" and discover the "tragedy.")

Since this is supposed to be a short "hit and run" mission, there's little of value or interest aboard the Wasp. Twostar has a locked desk in his cabin, however, that contains a portion of his payment for the raid (10 pp) and a letter that reads as follows:

*They will be coming in a [type of PCs' ship], one day after you. You know the plan: dead men tell no tales. Our large friend will help to the best of his considerable abilities.*

TB

## The Item

Curious PCs will probably want to know what all the fuss is about. The box containing the artwork is sealed in thin metal (a precaution against substitution; there's no way to open the box without leaving evidence of the activity). Anyone with Strength greater than 12 will have no difficulty breaking away the seal with a dagger. (If the PCs try this before the ambush, Larbo will definitely do his utmost to stop them.)

Inside the box, resting on a bed of black velvet, is the item. It's a clumsily-crafted cameo, depicting a profile that could just as well be a pig as a human. It has value only to the most ardent of collectors. (It's an early work by someone who later developed into a great artist. Its only significance is as a historical piece.) The PCs might, if they're very lucky, find another collector who might pay them up to 5,000 gp for the item. Alternatively, they might try to ransom the item back to one of the collectors involved in the original deal. In this case, they might be able to negotiate the price as high as 10,000 gp.

## Concluding the Adventure

Depending on the alignments and attitudes of the PCs, they might either keep the item for themselves (and try to ransom it back, perhaps), or see their mission through and deliver it to its rightful owner.

Torgan Betz represents a bit of unfinished business. There is enough indirect evidence to implicate him in the goings-on . . . not enough for legal proceedings, but probably more than enough to tempt

the PCs toward thoughts of revenge. If they come gunning for Betz, however, he has dropped out of sight. Betz is an ideal "nemesis" for the PCs, a "Napoleon of crime" around which many future adventures can be developed. (The final adventure in the book, "Cain," again pits the PCs against Betz.)

## Pirate-Wyrm

Setting: Wildspace  
Party: 4-6 characters, levels 7-9  
Ship: Any (30 tons + recommended)

### Setups

- The PCs have heard tales that a number of ships have gone missing in a certain area of space. They decide, or are asked, to investigate. The area in question is within an asteroid belt.
- The PCs are travelling through an asteroid belt (i.e., the DM can drop this adventure in at any time).

There's something disconcerting about having a chunk of rock as big as a good-sized castle hanging over you. Sure, intellectually you realize it isn't going to fall on you—the thing's in orbit, like all the other asteroids around you—but tell that to your stomach . . .

Your helmsman and navigator don't seem to be enjoying it too much either. There's just too much clutter in space around here for their liking: too many things to run into. And it's obvious that you're limited to tactical speed. Even if the helm let you reach full spelljamming speed, slamming into a city-sized chunk of rock at four million miles per hour isn't a particularly attractive concept.

"Captain!" someone yells. "Over there!"

You look where the crewmember is pointing. There's something large coming out from behind one of the asteroids. Or maybe uncoiling from around it. Something that glitters and shimmers in the starlight as though made of diamonds. Huge, membranous wings extend, and a mouth big enough to swallow ships stretches into what looks uncomfortably like a smile.

"Dragon!" you hear a voice yell, and belatedly realize it's yours. "Battle stations!"

The dragon is 15 hexes from the ship. The space around the ship is dotted with 1-20 asteroids. The DM can locate these randomly, or place them specifically to make the tactical situation interesting. (For example, the asteroids can be set in static orbits which create a slalom course for both ship and dragon. In this case, maneuverability becomes paramount.)

## Starlight Brilliant Glowing Radiance

The creature approaching the ship is a radiant dragon whose short name translates into Common as "Starlight Brilliant Glowing Radiance." The creature's long name is even more overblown, and would take several minutes to recite. She is a rapacious creature who has recently chosen space piracy as the best way to satisfy her greed. Her intention is to "hold up" the PCs' vessel. If they surrender and hand over all of their wealth (plus grovel a bit), she will let them escape with ship and skins intact; otherwise, she will destroy their vessel and pick what she wants out of the wreckage.

The dragon is supposed to be a foe that the PCs can just defeat, but only after a tough fight and only if they show some tactical intelligence. The statistics given below should be used as a starting point; the DM can increase or decrease them to match the particular party.

**Starlight Brilliant Glowing Radiance** (radiant dragon): AC -2; MV 12, Fl 48 (B); HD 15; hp 113; #AT 3 + special; Dmg 2-20/2-20/4-40 (+7); SA breath weapon (14d12+7 damage), spell use; SD 45% magic resistance; AL CE; THAC0 5. She currently possesses the following spells: *light*, *faerie fire*, *command*, *cause fear*, *cause light wounds*, *sanctuary*; *charm person*, *enthrall*, *hold person*, *heat metal*; *continual light*, *starshine*, *glyph of warding*, *pyrotechnics*; *protection from lightning*, *spell immunity*, *produce fire*, *detect lie*; *moonbeam*, *rainbow*; *fire seeds*, *blade barrier*; *sunray*, *fire storm*. In addition, she has the following innate abilities: *restore or corrupt air*, *Bigby's interposing hand*, *Bigby's grasping hand*, and *shapechange*. Details are given in the *Lorebook of the Void*, page 73. The dragon's body is 225 feet long, with a tail 250 feet long.

Starlight is highly intelligent as well as highly evil, and she has an ego bigger than she is. As well as taking everything

they have, she wants something more from the PCs: their grovelling pleas to let them live. Throughout the encounter, she will taunt the PCs and play with them, enjoying their fear. (All in all, she's a highly unpleasant creature.)

If the PCs seriously challenge Starlight (that is, if they manage to inflict 65 or more points of damage and look capable of inflicting more), she will try to escape to her asteroid lair. There she will recuperate and plot out exquisitely vicious plans for revenge against the PCs (Starlight knows this asteroid field, and has been known to tail slap debris at ships to prevent pursuit—count as a giant's boulder throwing ability). If escape is somehow denied her, she will fight until reduced to 30 hit points, then will surrender and try to buy her life with the location of her lair and treasure hoard.

## Dragon's Lair

Starlight's lair is a hollowed-out asteroid some distance from the site of the battle. The PCs can find it only by following the fleeing dragon, by extracting the information from Starlight, or by means of scrying. It is roughly spherical, and about 400' in diameter.

The lair's construction is simple and spartan. There's a cave-like entrance 50 feet in diameter (just big enough for the dragon to enter with her wings folded), which opens into a central cavern. Starlight has hollowed out the entire asteroid to form a single chamber roughly 300' in diameter. (This leaves walls 50' thick.) This cavern is in total darkness; it has a fresh atmosphere.

Starlight has left a few magical surprises for anyone who tries to enter her lair. She has cast a *glyph of warding* on the opening; the first non-draconiform creature that tries to enter triggers the glyph and is the victim of a *cause critical wounds* spell. She has also warded the entry with two *wyvern watch* spells (she set these when she left her lair, 1 hour before her encounter with the PCs). In addition, a permanent *magic mouth* has been cast on the entrance. Any non-draconiform creature trying to enter triggers the *dweomer*, which yells loudly, in the red dragon tongue, "Intruders! Wake up, everybody!" (This is Starlight's idea of psychological warfare. There are no red dragons within, although she'd be quite



glad if any intruders were scared off by the thought that there were.)

## Central Chamber

The chamber is roughly circular. It has gravity on all surfaces, allowing the PCs to use any surface as a floor.

The chamber is home to Starlight's pets, two space drakes (AC 2; MV 12; HD 10, hp 34,50; THACO 11; #AT 2; Dmg 2-16/1-12 (bite/tail); SA breath, magic, constriction; SD 30% magic resistance; AL N(E)). They are trained to attack intruders on sight.

This chamber is where Starlight keeps her rather considerable treasure hoard. This is scattered around the chamber, secured to the walls by gravity. The radiant dragon's hoard consists of four leather sacks containing 25,000 sp each (intended for a dwarven forge, where they would have been melted down); three large chests containing 5,000 gp each (literally a king's ransom); an earthenware jar containing 750 pp ("requisitioned" from a passing nautiloid); a small locked chest containing 25 gems (base value 100 gp); and another locked chest containing a matched set of 12 gem-studded gold drinking goblets, each worth 750 gp.

Aside from all the other treasures, the PCs find the following: a scroll case containing three scrolls (*death fog*; *wizard eye*, *avoidance*, *fabricate*; *phantasmal killer*, *vacancy*); and a small chest containing a *girdle of hill giant strength* and a *hat of stupidity*. Starlight knows that the magical items are of great value even though she can't use them. She's cast a *glyph of warding* on the scroll case and the small chest. Triggering the glyph causes blindness. (A successful saving throw means the victim fights at -2 to hit for the next 2-8 rounds due to blurry vision.)

## Concluding the Adventure

If Starlight Brilliant Glowing Radiance is defeated but escapes, future adventures can develop around her attempts for revenge against the PCs. Likewise, if the PCs are defeated but survive, or if they surrender, they can may later go hunting for the dragon.

Finding the dragon's lair and beating the guardians within isn't the end of the

story, should the PCs defeat the dragon. They must also live to spend their newfound wealth. The dragon might have family or acquaintances in the region.

Advantageous and patient pirates might also be staking out the area. Knowing that where there's a dragon, there's a hoard, they could be waiting to ambush anyone who has their hands on it. Their rationale is: anyone who's been in a fight—even a winning one—with a radiant dragon won't be in the best of shape to resist "sharing" all their prizes with the pirates.

## "Bloody Vikings . . ."

Setting: Wildspace  
Party: 4-6 characters, levels 6-8  
Ship: Any

## Setups

- The PCs have heard that shipping in a certain region has been suffering from the ravages of pirates. Rumors claim that the culprit is "Erik somebody," one of the pirates on the PCs' bounty list.
- The PCs are travelling in wildspace (i.e., the DM can drop this adventure in at any time).

You're starting to think that this adventuring in space isn't all it's cracked up to be. Whatever happened to meeting interesting new people for informative and stimulating conversation? It seems that everyone you've met lately, every ship you've encountered, has wanted to attack you. No "Pleased to meet you, where are you from?" Just "Fire the catapults and board them!"

There's another ship up ahead, and it certainly looks like it's on an interception course. Even at this distance, you can see the sail going up and the ship beginning to accelerate. Just wonderful . . .

There's something about this vessel that looks a little different, though. It's not one of the standard configurations you're used to seeing in wildspace. This one . . . it seems to be an open ship, long, and narrow across the beam. And it's got oars . . . a groundling vessel, for certain.

Groundling vessel or not, it's still

coming at you, and coming fast! Its captain seems to have but on thing on his mind . . . as usual.

"Battle stations!" you yell. "Again . . ." you sigh.

The approaching ship is a viking "Drakkar" or dragon ship (not to be confused with the Shou version from the SPELLJAMMER™ boxed set). This vessel has the following characteristics:

## Drakkar

<b>Built By:</b>	Groundling humans (vikings)
<b>Used Primarily By:</b>	Groundling humans (vikings)
<b>Tonnage:</b>	15 tons
<b>Hull Points:</b>	15
<b>Crew:</b>	8/15
<b>Maneuverability</b>	
<b>Class:</b>	E
<b>Landing—Land:</b>	No
<b>Landing—Water:</b>	Yes
<b>Armor Rating:</b>	9
<b>Saves As:</b>	Thick wood
<b>Power Type:</b>	Major or minor helm
<b>Ship's Rating:</b>	As for helmsman
<b>Standard</b>	
<b>Armament:</b>	1 medium ballista, crew 2
<b>Cargo:</b>	7 tons
<b>Keel Length:</b>	100'
<b>Beam Length:</b>	15'

This particular vessel is equipped with a major helm and has SR 5. It is 8 hexes away from the PCs' vessel, bearing 10° to port.

## Erik Bloodaxe

The world that Erik Bloodaxe came from was supposed to be non-magical. Oh, certainly there were gods; Bloodaxe believed (at least partially) in one named Odin, and sacrificed to him when he remembered. But the gods seemed far removed from the day-to-day affairs of men. The skalds told epic tales of days gone by, when gods still walked the earth and nothing was what it seemed. But those days had long since passed. At least, so thought Erik Bloodaxe.

Imagine his consternation when he found a strangely dressed weakling of a man staggering aimlessly near the

wreckage of some kind of ship. Not that shipwrecks were unusual; the fjords claimed their fair share of unwary vessels each year, particularly when the storms came. But this shipwreck was *twenty miles inland!* The ruined vessel might well have fallen from the sky . . .

And that's exactly what the stranger said had happened, once they got over the problem of common language. In the stranger's world, ships flew through the sky, driven by people such as himself. The stranger then claimed he was a wizard who flew among the stars!

Bloodaxe of course wanted to see some proof of this. But the feebly-built stranger could show him nothing, even when Bloodaxe threatened him with his battle axe. He could only babble something about "spelljammer after-effects," and ask if he could spend some time studying his "spellbook."

Though not terribly civilized, Bloodaxe was by no means unintelligent. Erik quickly realized that—if the stranger was telling the truth—this wizard could be incredibly useful, or incredibly dangerous if he managed to spend any time with this spellbook of his. With almost negligent ease, Bloodaxe took the spellbook away from the wizard, and destroyed it then and there on a fire, while the stranger looked on helplessly and wept.

Bloodaxe took the stranger back home, and slowly extracted the full story. Apparently the stranger had been visiting Bloodaxe's world—one apparently well away from the established spaceways (whatever those were)—and had crashed his ship when it was caught in a storm. Luckily, the "spelljamming helm" was undamaged. Without that, and without another strange item he called a "portal locator," the stranger could never return to his world.

At first, Bloodaxe kept this strange story to himself, and kept the puny wizard out of sight. But then one day, when the Council was meeting to decide the target of the next raid, Bloodaxe stood up and proposed that he command the Drakkar, and that he should take it beyond the sky!

The Council's laughter banishing him from the hall, Bloodaxe swore to prove himself a warrior not to be scoffed at. After the wizard showed him how to mount the "helm" in Erik's Drakkar, Erik picked his crew from the younger, more adven-

turous warriors, and set off to gain fame and fortune beyond the sky. That would show the Council not to laugh at Erik Bloodaxe!

Of course, only the wizard could operate the helm, and Bloodaxe trusted him about as far as he could spit a rat. Never was the wizard out of easy reach, for the great Erik Bloodaxe could not become stranded in space, far from his clan who should sing songs of his glory when he and the *Raven* returned from beyond the sun!

All of this took place several months ago. Erik Bloodaxe and his crew found the pickings in space to be quite easy. Certainly, the other ships they met were more suited to the strange environment, but what his small command lacked in equipment and experience, they more than made up for in ferocity. Through sheer audacity, Bloodaxe won several engagements that he had no chance of even surviving. (One of those defeated ships "donated" the medium ballista he's mounted in the bow.) Bloodaxe and his crew will attack any vessel unlucky enough to cross their path. Now it's the PCs' turn . . .

### The Attack

Bloodaxe has learned much from past encounters, and his ship-to-ship tactics are quite good. He will start off with a few shots from the medium ballista while his vessel is still closing. His crew has prepared the ballista ammunition by wrapping the heads of the bolts in oil-soaked burlap, which are then ignited before firing. As long as the ships are more than one hex apart, the flames go out before the missile hits (Bloodaxe still hasn't figured out the atmosphere envelopes). Once they are in the same hex, however, and their envelopes are contiguous, the bolt will stay alight. Bloodaxe usually gets one final shot in at this range.

Bloodaxe then makes a shearing attack against the target vessel. He's found that his ship isn't as maneuverable as many of his targets, and his intention is to narrow that gap by destroying the target's rigging. Then he attempts to grapple and board. (During the boarding action, the wizard is taken along, since it's too dangerous to leave him behind.)

Bloodaxe takes no prisoners; all enemies are killed, whether they surrender or not ("enemies who surrender are not

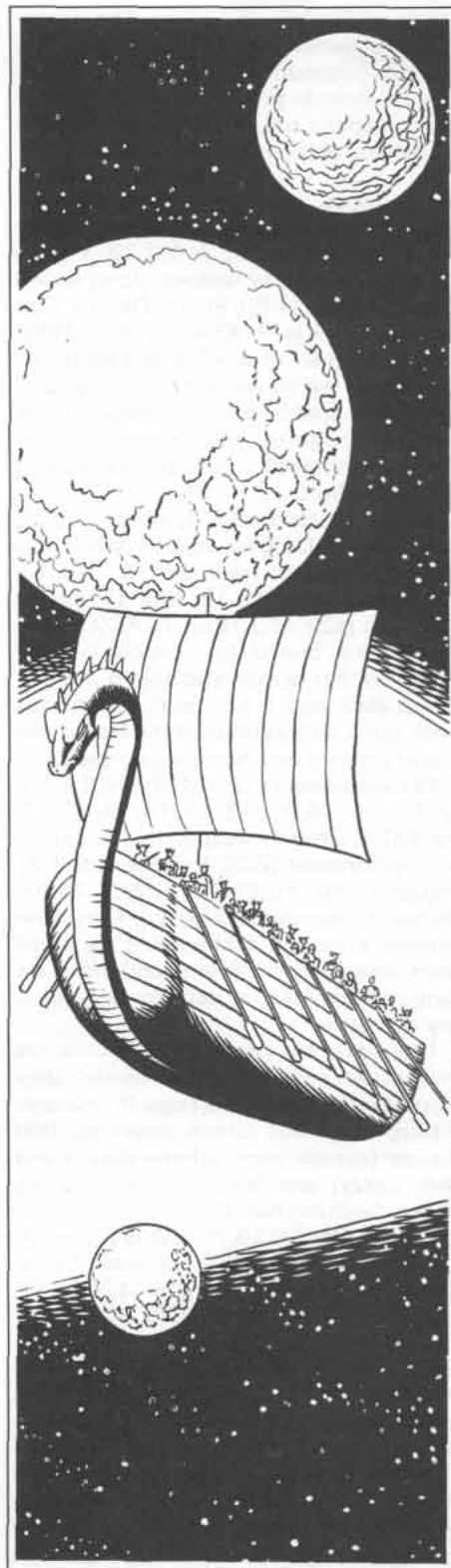

worthy of life, anyway"). Once the enemy ship has been stripped of everything that Bloodaxe recognizes as valuable (which doesn't include most magic items other than weapons or armor), his men torch the enemy ship and set it adrift.

## The Vikings

**Erik Bloodaxe:** AC 7; MV 12; F9; hp 70; #AT 2; Dmg by weapon (long sword (1-8), hand axe (1-6)); Str 15, Dex 13, Con 14, Int 11, Wis 9, Cha 14; AL CN(E); THACO 10 (includes +2 bonus for ferocity). Bloodaxe wears leather armor and shield; he wields a *long sword* +1 (he doesn't recognize that it's magical, just that it's "balanced nice"), and has a hand axe on his belt.

**Sven Onethumb:** AC 7; MV 12; C2/F4; hp 18; #AT 1; Dmg by weapon (staff (1-6), hammer (2-5)) or spell; Str 15, Dex 12, Con 13, Int 11, Wis 12, Cha 13; spells: *shillelagh* (x2); AL CN(E); THACO 15 (includes +2 bonus for ferocity). Sven wears leather armor and shield; he carries a staff and a hammer. Around his neck is the holy symbol of the Norse god Modi (a sword and hammer, crossed).

**Crewmember** (x12): AC 7; MV 12; F3; hp 4, 7, 10, 10, 11, 13, 13, 15, 17, 17, 19; #AT 1; Dmg by weapon (battle axe (1-8), warhammer (2-5), long sword (1-8), dagger (1-4)); AL CN(E); THACO 16 (includes +2 bonus for ferocity). They wear leather armor and shields. Five wield axes, four carry hammers, and three use long swords. All have daggers as secondary weapons.

Bloodaxe, his cleric, and his crew are true berserkers. Before a battle, they work themselves into a rage. In this condition, they will attack anything that moves (except each other—they're not that crazy) and will fight until dead, never checking morale.

**Lareth Eln:** AC 10; MV 12; W10; hp 12; #AT 1; Dmg by weapon or spell; Str 8, Dex 10, Con 9, Int 15, Wis 11, Cha 11; spells: none; AL N; THACO 17. Lareth Eln is the wizard unlucky enough to crash his craft near Bloodaxe's home. He is unarmored and unarmed, and has no spell book. He will do whatever it takes to keep himself alive.

At the DM's option, Lareth may wrest himself from Bloodaxe and defect to the PCs. Lareth may beg for his life in exchange for information about Bloodaxe's

ship and cargo. A journey to return Lareth to the Forgotten Realms or a hunt for spellbooks could open countless adventuring opportunities.

## The Raven

The loot that Bloodaxe has wrested from his victims is piled haphazardly in the hull. (Eventually Bloodaxe intends to take it home, but for now he's having too much fun.) The vikings' hoard comprises 12,000 sp and 7,000 gp (loose, and rattling around in the bilge); a velvet bag hanging from a nail on the mainmast containing 5 diamonds (1,000 gp base value ea.); a matched set of four gold serving dishes (500 gp each); and a mithril *chime of interruption* (Bloodaxe has no idea what it is, but it looks nice). There is also the ship's portal locator (Lareth Eln will claim that this is his and that the PCs shouldn't take it).

## Concluding the Adventure

Until they are all killed, the vikings will continue to terrorize the spaceways. Even if the wizard Lareth Eln is killed or escapes, Sven Onethumb the cleric can serve as spelljammer (although the ship's SR drops to 1, making the *Raven* considerably less threatening). Future adventures can develop around hunting down these bloodthirsty vikings, should they survive.

If the PCs rescue Lareth Eln, he'll obviously be very grateful. He may want to go home, back to Sembia in the Forgotten Realms, where he'll give up the space-faring life and maybe raise chickens or something safe. The only way he can get home, however, is to persuade the PCs to take him . . .

## Fire and Ice

Setting: Wildspace  
Party: 5-6 characters, levels 6-8  
Ship: Any of 20 tons or more

## Setups

- The PCs have learned that shipping in a certain region has been suffering the ravages of pirates. Rumors indicate that the vessel doing the damage is called the *Frostfire* (one of the ships on the PCs' list).
- The PCs are commissioned by the elven Imperial Navy to carry a message

to a man-o'-war that is on a supply mission.

- The PCs are travelling in wildspace (i.e., the DM can drop this adventure in at any time).

Looks like you've blundered right into the middle of something. Up ahead, a semi-crystalline shape catches the light as it maneuvers. An elven Man-o'-war—you'd recognize it anywhere. The wings are rather asymmetrical, though, and scorched. Maybe the thing ran afoul of a radiant dragon. Or maybe the elves just flew the damn thing too near to a sun. (Some elves you've met would be quite capable of doing that, just to get a closer look at an interestingly-shaped sunspot.)

It doesn't look as though the elves' current opponent burned the wings, however; it doesn't seem to be a fire-user. But the other vessel is definitely getting the upper hand in the skirmish.

It's a Squid-ship, painted a glaring red. (Something a little odd about its shape and rigging . . .) It's involved in a stern chase with the Man-o'-war, the elven vessel doing its best to outrun its enemy (interesting!), and not doing a good job of it, either. The Squid-ship is firing a continuous barrage of large boulders, many of them finding their mark. (Gods, what a rate of fire! How many catapults are aboard that thing?)

As you watch, a flitter lifts off from the castle deck of the Man-o'-war. (Readying for a suicide run? How else could it hurt the Squid-ship?) The tiny vessel maneuvers hard, jinking back and forth to make itself a tough target.

The Squid-ship sees it. One boulder misses, then another. But the third strikes it squarely. The flitter disintegrates in a ball of flame. (You were right. Suicide run, packed with greek fire.)

Another two boulders strike the Man-o'-war, smashing off one of the elven vessel's arching wings. The Man-o'-war, totally out of control, starts to tumble as the Squid ship moves in for the kill . . .

If the PCs don't get involved, the Squid-ship will totally destroy the Man-o'-war and kill every remaining member



of its crew. If they want to save the elves, they must defeat the Squid-ship themselves.

The Man-o'-war is 8 hexes directly to port of the PCs' vessel, heading in exactly the same direction. The Squid-ship is two hexes behind, with the same heading. The Man-o'-war is totally incapacitated due to spelljammer shock, and slowing; the Squid-ship has SR 3 and Maneuverability Class E.

The crew of the Squid-ship has spotted the PCs' vessel. If the PCs remain on their present course, the Squid-ship will go ahead with its intention of destroying the Man-o'-war. If the PCs change course and begin approaching, the Squid-ship will gladly change targets and attack them too.

## The Frostfire

The Squid-ship has been extensively modified to meet the needs of its crew: two fire giants and one frost giant. The giants were originally taken into space by an ambitious (but somewhat unwise) neogi, who was soon killed by his oversized slaves. Though unaccustomed to space, the giants "acquired" the Squid-ship, which they called the *Frostfire*, and took up the career of pirates. For the last several years, they've been doing rather well at it.

They are casually brutal about the business of piracy. They use their rock-throwing abilities to counter the maneuverability of their targets. Once the enemy is slowed or immobilized, they grapple and board, using their superior weight and strength to their best advantage. The giants take no prisoners, and usually torch the gutted ship once they're done with it.

**Dav Firestorm** (fire giant): AC -1; MV 12; HD 15+2-5; hp 77; #AT 1; Dmg 1-8 or 2-20+10; SA hurling rocks for 2-20; SD resistant to fire; AL LE; THAC0 5. Dav is the captain of the ship.

**Clira Firestorm** (fire giant): AC -1; MV 12; HD 15+2-5; hp 78; #AT 1; Dmg 1-8 or 2-20+10 or by spell; spells: none; SA hurling rocks for 2-20; SD resistant to fire; AL LE; THAC0 5. Clira is Dav's sister; she is a shaman of 6th level, and is the ship's helmsman. Because of the after-effects of spelljamming, she currently has no spells.

**Hoarfrost Crystalspear** (frost giant): AC 0; MV 12; HD 14+1-4; hp 70; #AT 1;

Dmg 1-8 or 2-16+9 or by spell; spells: *command, cause fear, cause light wounds, enthrall, hold person, spiritual hammer, prayer, pyrotechnics, produce fire, magic missile, chill touch, fog cloud*; SA hurling rocks for 2-20; SD impervious to cold; AL CE; THAC0 5. Hoarfrost is a witch doctor (C7/W3). Although he hates to take orders, he has to admit (grudgingly) that Dav Firestorm is smarter than he is, and that everything's worked out very well with Dav in charge. Hoarfrost keeps his pet aboard—a winter wolf pup he calls Blizzard.

**Blizzard** (winter wolf pup): AC 5; MV 18; HD 4; hp 12; #AT 1; Dmg 2-5; SA frost breath (2-12 points of damage, 5' range); AL NE; THAC0 15. The pup is loyal to Hoarfrost, and follows his orders. It will give its life for its master. He is less than a year old, and is only 5 feet tall.

The rigging of the Squid-ship had to be modified to allow room for a crew of giants (this has dropped the vessel's Maneuverability Class to E). In addition, the entire main deck has been torn out (for extra headroom), as have the bulkheads in the cargo deck. Giant-sized ladders have been installed so the creatures can reach the forecastle and stern castle. The ship's major helm has been moved below to the cargo deck, just forward of the mizzenmast. The helm itself has been modified, too—mainly through tearing away the arms and back—so Clira can squat on it (somewhat precariously). Finally, the catapults and ballistae have been discarded. (The giants each have the range and effect of a light catapult (and considerably better THAC0), and they can throw one boulder per round.)

Blizzard, the winter wolf, lives below on the cargo deck (he's incapable of making it to the upper decks unless one of the giants lifts him).

The cargo deck is also where the fire giants sleep. There are two large sleeping pallets. The frost giant claims that he prefers to sleep under the stars and he usually slings a huge hammock between the mainmast and mizzenmast.

The giants' loot is stashed forward in the cargo deck. They have amassed the following: 6,000 sp and 2,000 gp (in sacks); a small obsidian box (250 gp value) containing an elaborate diamond necklace (5,000 gp); four magnificent carpets of elven manufacture (750 gp

each, currently being used as blankets); and a pair of *winged boots* (MV 24 (D)).

There are 8 boulders stacked on the forecastle and 6 on the stern castle; the others were expended in the battle with the Man-o'-war.

Although Hoarfrost is perhaps too dim to recognize a losing proposition until it's too late, the fire giants won't fight to the death. Instead, they'll surrender . . . and wait for a chance to turn the tables on their diminutive captors.

## Man-o'-war

Depending on alignment and attitude, the PCs may decide to help the elven vessel or finish it off and loot it themselves. The surviving elves aboard the Man-o'-war recognize the two options, so they'll be watching the PCs most carefully if they approach.

The Man-o'-war has been reduced to 12 hull points. Damage to its wings has dropped its Maneuverability Class to E. The last hit from the giant vessel caused a critical hit and spelljammer shock; thus their primary helmsman is in a coma. There is a back-up helmsman who can take over, but it takes 1d8 rounds for the him to get to the helm. As soon as the vessel is under power, it heads away from the battle with a rating of 2. The jettison and the starboard ballista have been put out of commission by boulder hits; the port ballista and the medium catapult are still fully functional. Since the catapult is on a rotating turret, it can keep the PCs' vessel targeted while the Man-o'-war is pulling away.

If the PCs make any hostile moves, or moves that could conceivably be mistaken as hostile, the Man-o'-war opens fire. If the PCs communicate peaceful intent—by matching courses rather than intercepting, or by hailing, etc.—the Man-o'-war will stop and wait for the other vessel to pull alongside. (The elves really need help, and they're in no condition for another battle.)

The crew of the Man-o'-war is down to 12. Many were killed in a run-in with a rogue celestial dragon (perhaps the one from the adventure "Pirate-Wyrm" and it was in this engagement that the vessel's wings were fire-damaged.) Several more were killed in the giants' bombardment. The elves have collected the 32 bodies and laid them out respectfully in the



cargo hold (area 3 on the main deck); their intention is to "bury them in space" with all ceremony as soon as possible.

The vessel, which is named *Sparrowhawk*, is under the command of Captain Adrin Willowleaf of the Imperial Navy. His second in command is Sergeant Berl Mooncrest. The currently comatose helmsman is Pilot/Wizard Marta Mornstar; the back-up helmsman is Pilot/Wizard Tel Astrid.

**Captain Adrin Willowleaf:** AC 1; MV 6; F10; hp 62; #AT 3/2; Dmg by weapon (wheel lock pistol (1-4), dagger (1-4)); Str 13, Dex 12, Con 13, Int 13, Wis 12, Cha 14; AL CG; THACO 11. Captain Willowleaf wears an elaborately ornamented set of full plate armor; he carries a long sword +1, a dagger and a wheel lock pistol (enough ammunition for 6 shots). Willowleaf is a proud commander, and will not allow his vessel or its cargo to fall into non-elven hands. If it looks as though defeat is unavoidable, he will scuttle his ship by detonating the stockpile of greek fire and smoke powder in the cargo bay.

**Sergeant Berl Mooncrest:** AC 4; MV 9; F7; hp 27; #AT 3/2; Dmg by weapon (long sword (1-8), dagger (1-4), light crossbow (1-4)); Str 14, Dex 13, Con 11, Int 12, Wis 12, Cha 13; AL CG; THACO 14. Sergeant Mooncrest wears banded mail; he carries a long sword, dagger and light crossbow.

**Pilot/Wizard Marta Mornstar:** AC 10; MV 12; W12; hp 28; #AT 1; Dmg by weapon or spell; Str 9, Dex 11, Con 11, Int 16, Wis 12, Cha 12; spells: none; AL CG; THACO 17. The pilot/wizard is unarmored and unarmed. She is currently in a coma from spelljammer shock, and will remain so for 1-4 days.

**Pilot/Wizard Tel Astrid:** AC 10; MV 12; W5; hp 8; #AT 1; Dmg by weapon (dagger (1-4), dart (1-4)) or spell; Str 10, Dex 10, Con 11, Int 14, Wis 11, Cha 12; spells: none; AL CG; THACO 19. Astrid wears no armor; he carries a dagger and three darts. Since he is in contact with the spelljamming helm, he has no spells.

**Crewmember (elf; x8):** AC 5; MV 9; F2; hp 4, 5, 5, 7, 9, 9, 12, 15; #AT 1; Dmg by weapon (long sword (1-8), dagger (1-4)); AL CG; THACO 19. The standard crewmembers wear chain mail and carry long swords and daggers. Four also wield short bows. Despite great losses, the

crew's morale is still high (16), though this is due to their sense of duty and discipline, not fighting spirit. They support their captain's intention to scuttle the ship before letting it fall into enemy hands (although they'll certainly do their best to make sure they're not aboard when that happens).

The Man-o'-war's mission was to deliver a supply of greek fire and smoke powder to an elven Armada. The cargo holds are filled with these unstable substances. There is enough greek fire liquid for 100 shots from a standard projector; the liquid is stored in small casks. Large oak barrels contain a total of 200 charges of smoke powder (enough for 20 bombard shots). If detonated, the cargo will cause 3-30 (3d10) points of hull damage to any ship within 1 hex of the *Sparrowhawk's* final position. Anyone on board the *Sparrowhawk* will be killed instantly.

## Concluding the Adventure

If the giant-manned *Frostfire* escapes, it will continue its career of ravaging the spaceways. Future adventures can be developed around hunting it down.

The cargo aboard the *Sparrowhawk* was important enough for the Man-o'-war to be kept under observation via scrying devices. If the PCs assist the crippled elven ship toward its destination (an elven Armada currently tethered to the Royal Docks of the Rock of Bral), the Imperial Navy will know about it, and will send an undamaged Man-o'-war to intercept the PCs. This vessel will convey the official thanks of the Navy and will take over escort duties, allowing the PCs to go on their way. As well as that of the Navy, the PCs will have earned the personal gratitude of Captain Adrin Willowleaf. (Whether this gratitude converts into anything of monetary value is entirely up to the DM.) Now that the PCs are known and respected by the Imperial Fleet, future adventures can certainly develop involving them in the elves' plans.

If, instead, the PCs finish off the elven ship, the Imperial Fleet will also know about it. Descriptions of the PCs and their vessels will be disseminated among the elven Fleet, and the PCs might find themselves the target of unprovoked attacks by elven vessels in the future.

## Violent Death

Setting: Wildspace

Party: 5-6 characters, levels 7-10

Ship: Tradesman or equivalent

### Setups

- The PCs hear rumors that a large pirate vessel is attacking shipping in a certain area. These are second-hand rumors only: no actual victim of one of these attacks is available for comment. (Could this mean that the whole thing is a lie . . . or has no one who's met up with this ship lived?)

- The PCs hear rumors that a ruined ship—a prime target for salvage—is drifting in a certain area of wildspace.

- The PCs are travelling in wildspace and stumble upon an inert ship (i.e., the DM can drop this adventure in at any time).

There's no warning. One moment your ship is sailing along at full spell-jamming speed; the next, you feel the subtle internal shift that means you've dropped to tactical speed. You glance at the helmsman, who's even now conversing with the navigator. Both look at you and shake their heads. None of their doing.

The lookout's call answers the question you'd been about to pose: "Object hard a-port!" You lean over the rail and strain your eyes.

It takes you a moment to spot a Tradesman, topped out with extra rigging for additional maneuverability, but totally inert: no running or navigation beacons, no lanterns, no light spilling through the large "eye" portholes. And no movement. No controlled movement, at least. As you watch it for a moment, you notice that the vessel is tumbling slowly.

The range is extreme for a good look—1,200 yards; any further and you would have blazed by the Tradesman at 4 million miles per hour—but as you strain your eyes you can pick out a few more details. Much of the vessel's extra rigging is torn and splintered, and a spanker fin is almost totally ripped away. And isn't that a hole smashed in the small vessel's hull?

The Tradesman is at a bearing of 90° to port, even along your gravity plane. Since the Tradesman is tumbling slowly

end over end (one revolution every minute), its heading keeps changing. It is not moving relative to your vessel.

### The Sculpin

If the PCs want to investigate, it's an easy matter to bring their ship near to the stationary Tradesman. The only potential problem relates to boarding: the dead vessel's slow tumbling means its gravity plane is moving relative to the PCs' ship. Even this should pose little problem as long as the boarding party carefully synchronizes its entry into the Tradesman's atmosphere envelope. Once the party is aboard the Tradesman, of course, the ship's motion is immaterial.

Use the ship plans from the "Tradesman" card in the SPELLJAMMER™ boxed set. All areas in the following description correspond to the numbered areas on the plans.

The ship is in total darkness. The vessel's air envelope is fouled. Although the DM shouldn't mention it expressly, there is no one aboard the Tradesman, and there are no corpses.

### Main Deck

The deck is littered with debris: shards of rigging, splinters of wood, here and there a broken crossbow bolt or a shattered sword. Small chunks of rock grind underfoot (projectiles from a jettison, perhaps, or maybe fragments of a catapult missile). The hardwood deck is blackened in several places, as though lanterns were dropped or shattered, spreading burning oil over the planks. And in more than half a dozen places are large stains that could only be blood. The catapult in the bow is loaded, and the compartment holding the shot is almost empty. In contrast, the stern-mounted ballista is shattered (it looks as though an over-eager crewman "dry-fired" the weapon without a missile properly loaded, and the stress tore the device apart).

The conclusion is obvious: the Tradesman was fighting for its life and it seems to have lost.

The forward catapult is usable and can be salvaged if the PCs want to invest the time. Five catapult rocks and three ballista missiles remain. Nothing else usable can be salvaged.

The doors to the forward and aft passages have been smashed off their hinges, and the frames show the marks of multiple axe blows.

### Cargo Deck

#### 1. Bridge.

Deck and bulkheads are charred as though a fire burned here for several minutes before going out. The starboard "eye" porthole is shattered. A brass tube lies on the deck, a tube with a massive dent in it, as though somebody used it as a weapon. As the weakened deck shifts under your weight, the tube rolls and you can hear a tinkling sound from within it.

The tube is, of course, a telescope, used in desperation as a weapon by the navigator. There is nothing else of value or interest left on the bridge.

#### 2. Companionway.

A notched battleaxe is imbedded deep into the wood of the mainmast . . . just at neck height, as though the intended recipient of a mighty blow had ducked out of the way just in time. The leather-bound handle bears scratches and striations that could have been made by strangely-designed mail gloves . . . or by claws.

Anyone with a Strength of 16 or more can extract the axe from the mast. The weapon is notched, but still usable. The axe head itself is of an unfamiliar design. (Anyone with the nonweapon proficiency of ancient history or weaponsmithing may roll a proficiency check. A successful roll means that they recognize the design as one common several hundred years ago on a planet in this shell.)

#### 3. Chartroom.

The mactable is shattered, and the charts are strewn everywhere. A dark-bladed dagger lies in the far corner.

The dagger blade is covered with a substance that could be dried blood . . . if blood were black and smelled of putrefaction.



#### 4. Captain's quarters.

A small sleeping pallet has been upended and thrown against the bulkhead. Slashes and hack-marks in its wood imply that somebody tried to use it—unsuccessfully, it would seem—as a shield. Against the far bulkhead is a small desk.

The desk is secured with a simple lock (+15% chance of picking it). If no thief is available, a blow from a blunt weapon that inflicts 3 or more points of damage will smash the desk open.

The desk contains the ship's log, a leather bound book. If the characters spend three or more rounds perusing the log, they'll find that the Tradesman is named the *Sculpin*, and that its captain is a human named Darathon. From records, they can determine that the *Sculpin* is an honest Tradesman, and has never been involved in piracy or smuggling. The log also tells the PCs the *Sculpin's* current destination and last port of call. (The DM must determine these depending on circumstances. For example, a log entry might read "Ten days out of Ginsel in Greyspace, on course for the Tears of Selune in Realm-space.") The ship's cargo is listed as 3 tons of honeywood, a softwood favored for works of art, worth 7,000 gp per ton.

In addition to the log, there is a small, locked wooden box. Inside is a small velvet bag containing 4 gems (base value 500 gp), and a tiny painting framed in gold (10 gp value for the frame). The painting depicts a rather handsome young man with straw-colored hair and beard, and bright green eyes, next to a young woman with very similar features. (It's the captain, Darathon, and his sister, as the PCs might easily guess.)

#### 5 and 6. Locker & Head/Storage.

Both rooms contain the usual bric-a-brac needed to run, maintain and repair a ship: ropes, spikes, belaying pins, etc. There is nothing of value.

#### 7. Cargo Holds.

As you look into the dark space, you expect to find the holds empty. (Of course they'll be empty. The ship was raided and pillaged, wasn't it?)

But no, the holds contain stacks of wood, still secured to the decks with

ropes. Certainly, some of the pieces of wood have come loose. But all in all, the cargo is undisturbed.

What in Hades is going on here?

Both holds are loaded, containing the 3 tons of honeywood described in the ship's log, distributed evenly between the holds to balance the vessel. There's no evidence that anything has been taken.

There is evidence that there's been some trouble below, however. Lying on the deck, against the port hull, is a human-sized helmet that has been staved in by a powerful blow from a mace or hammer.

The port hold has a huge hole torn in the hull, as if by a heavy catapult missile.

#### 8. Sail Locker.

The door hangs from one hinge, and the rolled canvas within is torn and bloodstained.

From the evidence of a struggle within, it appears that a member of the *Sculpin's* crew tried to hide in the sail locker, but was found by the raiders who had boarded the vessel.

#### 9 and 10. Crew quarters.

Hammocks used to hang from hooks on the bulkheads and overhead, but most have been cut down. There is nothing of value remaining in either room.

#### 11. Galley/Kitchen/Pantry.

The floor is covered with food and broken crockery, both of which fell from shelves along the bulkheads when the ship was struck. A table lies smashed and overturned against a cast iron stove set against the hull. A heavy cleaver is buried in the bulkhead next to the door: evidence of a missed throw.

#### 12. Helmsman's quarters.

Unmistakable signs of a pitched battle here, as though the surviving crew chose this place to make their final stand. The door is smashed from its hinges, and a heavy couch—bearing evidence of two score axe-

and sword-strokes—lies directly inside. Crossbow bolts are embedded in the inside of the bulkhead, obviously shot at figures coming through the shattered door. The helm itself—an ornate throne with wide arms and an intricately-carved back—is intact, albeit very blood-stained.

The ship's minor helm is still functional; it is the ship's only power source. Partially concealed behind the helm is a chest containing the personal belongings of the *Sculpin's* helmsman. Along with spell components and a holy symbol to the god Pholtus of Greyspace, there is a small velvet bag and a notebook.

The bag contains a circlet woven from platinum wire with a browpiece of alabaster; its apparent value is approximately 6,000 gp. If *detect magic* is cast on it, it radiates a strong aura of abjuration and necromancy. The circlet allows its wearer to cast *Serten's spell immunity* once per day and *hold undead* three times per day, each at the 16th level of ability. The circlet was created by a wizard/priest who worshipped the god Seker (Egyptian pantheon), to aid his followers to seek out and destroy powerful undead. Its powers are linked to the presence of powerful undead: it only becomes functional when it is within 100 yards of a lich, vampire, or equally powerful undead. Until such a time, it is inert, and its wearer gains no knowledge of its powers. When such a powerful undead draws near, however, the wearer immediately becomes aware of the circlet's powers and history. The circlet was created to deal with one major undead creature only. Once a lich or vampire has been destroyed using the power of the circlet, the item crumbles to non-magical platinum dust (worth 500 gp).

The notebook details how the *Sculpin's* helmsman, a priest named Greybriar, bought the circlet from a mind flayer trader who apparently was unaware that the item was magical. Greybriar's notes go on to explain that he tried to determine its powers and significance, but with little success. All he knows for sure is that it has something to do with death magic. Since such an item might be evil, he has sworn never to experiment with it himself, lest he put his immortal soul in peril.

## Death Ship . . .

Exactly 30 minutes after the PCs encounter the *Sculpin*, the lookout spots another vessel approaching. When first sighted, its bearing is 165° starboard (almost directly astern) and 30° below the gravity plane of the PCs' vessel. It is on an interception course with the PCs' ship, and is travelling at 6 hexes per round.

The approaching vessel is a topped out Galleon with multiple banks of sails set. As the range closes, you can see figures in the rigging, adjusting the canvas to fine-tune the ship's course. There's movement on the decks, and starlight glints off metal.

The ship matches the standard Galleon description in the SPELLJAMMER™ boxed set, except as follows:

The two medium ballistas on the forecastle have been replaced with two heavy catapults, while the light catapult on the stern castle has been joined by two medium ballistas. On each side of the main deck, level with the mainmast, is a heavy ballista and a light ballista. These light ballistas are loaded with grappling hooks, while the heavy ballistas are loaded with standard ballista missiles. Its extra sails improve its maneuverability class from F (one class worse than usual because of its crew) to E; as a consequence, its minimum crew is 30 instead of 20.

The vessel is powered by a major helm and has a SR of 7.

The hull of the ship is painted blood-red above the "waterline" and space-black below. Anyone using a telescope or other vision enhancement device will see the name of the ship painted in black on its bow: *Nex*. A character with a non-weapon proficiency involving languages can make a proficiency roll with a -2 penalty to recognize the derivation of the name: it comes from a largely-forgotten human tongue and means "violent death."

The *Nex* has one intention: to attack the PCs' vessel and slay everyone on board, regardless of cost to itself. Its captain/helmsman is exceptionally intelligent, and the vessel's tactics will reflect this. The *Nex* will use its high speed and considerable firepower to its best advantage, trying to seriously weaken

or incapacitate the PCs' vessel before it undertakes boarding operations. It will use the tactics most appropriate to the vessel it is fighting. Perhaps surprisingly, it will not flee or turn aside even if the PCs' vessel obviously overmatches it. It will even attack a flotilla of vessels.

## . . . And Those Aboard Her

The *Nex* is a "death ship," captained by a lich and manned by 50 undead (it doesn't matter that this is over the ship's standard capacity, because undead need no air). All aboard the vessel will fight until they are totally destroyed.

## Manara the Lich

The captain and helmsman of the *Nex* is a female lich named Manara. A powerful mage and an intrepid explorer of the Flow during her life, she became a little too arrogant for the tastes of several demigods. She intruded on a sphere that these demigods had reserved for their own recreation. When informed of her infraction, she merely laughed and rejected their "pact" in the interests of exploration.

In retribution, the demigods arranged for Manara and her crew to be slain by a shipload of giff which happened along, and then laid a curse on her which turned her into a lich. Her crew they animated as ju-ju zombies. In addition, the demigods agreed among themselves that she could only achieve final oblivion—which Manara would have greatly preferred over undeath—by dying in a glorious battle with another ship. If Manara didn't play along with the rules—if she decided to simply ram an asteroid, for example, or if she didn't employ her best efforts (in the demigods' estimation) during the battle—the divine beings would simply wish her back into existence, still in her lich state. This, they decided, would be good punishment for her arrogance and worth a chuckle as well.

At first, not believing the demigods, she provoked other vessels until they attacked, and then just did nothing until they destroyed her. In each case, however, the demigods wished her back into existence as they promised. When she finally came to believe that her only escape would be to meet the demigods' conditions, she went on a rampage across the spaceways, the likes of which had rarely been seen.

Any ship she encountered she attacked, no quarter asked nor given, using all her intelligence and all her magical power (let the demigods dare to accuse her of not employing best efforts). She never bothered to plunder the vessels she defeated (what value has loot to her?).

At first, she would let survivors go. But as the decades began to weigh upon her, her sanity started to slip and her alignment changed. Where once she had been Chaotic Good, she now grew more and more evil. Her behavior changed, too: instead of sparing survivors, she would slay them all, and the demigods would animate them to fill out her crew (why let others live when she could never again taste life?).

Her hope is to meet up with a vessel she can't possibly destroy: an elven armada, for example, or a neogi deathspider . . . perhaps even the *Spelljammer* itself. But, whether through plain luck or the manipulations of the demigods, the *Nex* never ran into anything it couldn't handle. Until possibly now . . .

(Unknown to Manara, one of the demigods she offended has started to take pity on her. He can't back out of the pact with the others, but he can secretly aid Manara. It was this demigod, in the guise of a mind flyer, who sold Seker's circlet to Greybriar, the *Sculpin's* helmsman, and then guided the *Nex* to the *Sculpin*. His hopes that Greybriar would use the circlet to defeat Manara came to naught. But now the PCs have arrived on the scene, and once more there is hope.)

**Manara the Lich:** AC 0; MV 6; HD 14; hp 60; #AT 1; Dmg 1-10; SA fear, paralysis, spell use; SD spell immunity, +1 or better magical weapon to hit; AL CE; THAC0 7. Manara has retained her human appearance better than most liches. Her long dark hair remains, in patches, and her face and hands are still covered with skin (albeit skin stretched tightly over bones). Sullen red lights glow in her eye sockets. She wears a tattered red robe of a fashion worn three centuries ago by explorers of noble birth. At her hip is a jewel-encrusted dagger (value 750 gp).

Since she is the *Nex's* only occupant able to use the spelljamming helm, when the PCs first encounter her she is incapable of spell use (a side effect of the helm). Should the PCs stay in the vicinity for more than 24 hours, however, Manara



can cast the following spells: *chill touch*, *detect undead*, *burning hands*, *enlarge*, *spider climb*; *spectral hand*, *Melf's acid arrow*, *darkness 15' radius*, *fog cloud*, *shatter*; *feign death*, *hold undead*, *vampiric touch*, *fly*, *wind wall*; *contagion*, *enervation*, *fire shield*, *polymorph other*; *animate dead*, *magic jar*, *summon shadow*, *telekinesis*; *death spell*, *disintegrate*; *finger of death*. In addition to her own magical powers, she wears a *ring of the ram* (32 charges) and carries a *wand of magic missiles* (45 charges), both of which she can employ once away from the helm.

If she thinks that the PCs actually have a chance of defeating her, Manara will fight all the harder, just to make sure that the demigods can't accuse her of "pulling her punches."

As with all liches, Manara's life essence is stored in a phylactery. In her case, however, she has no reason to hide it. Instead, she wears it openly around her neck: a pendant with a cheap glass "gem" (all she considers her existence to be worth). This gem radiates a strong aura of magic, tinged with a hint of Manara's personality.

The *Nex* is manned by 50 ju-ju zombies, animated by Manara or by the demigods who cursed her. The majority are humans and demihumans. Several, however, are different kinds of creatures. Some decades ago, Manara came upon a single neogi with two umber hulk slaves in a damselfly . . . easy prey for the *Nex*. These three unusual zombies are among Manara's crew.

A typical crewmember has the following statistics:

**Ju-ju zombie:** AC 6; MV 9; HD 3+12; hp 15-42; #AT 1; Dmg 3-12 or weapon; AL N(E); THACO 15. The ju-ju zombies are armed with a variety of weapons: the typical range you might find on a pirate ship (swords, axes, etc.). Fifteen are armed with light crossbows (dmg 1-4), and ten carry wheel lock pistols (dmg 1-4). All are competent at handling the rigging and at operating the ship's heavy weapons. Their instructions are to destroy all living beings in any way possible.

Among the zombies is one that the PCs might recognize: a young, handsome man with straw-colored hair and beard, green eyes . . . and a lethal sword-cut to the head. He is, of course, Darathon, captain of the *Sculpin*. (Darathon is no different from the other zombies. He's included here to satisfy the PCs' curiosity about what happened to the *Sculpin*.)

**Umbur hulk zombies (x2):** AC 2; MV 6; HD 9+8; hp 55, 61; #AT 3; Dmg 3-12/3-12/1-10; SA confusion; AL N; THACO 11. Like other zombies, the umber hulks are slow, and always attack last in a round.

**Neogi zombie:** AC 3; MV 6; HD 6; hp 28; #AT 3; Dmg 1-4/1-4/1-8; SA slowing poison; AL N; THACO 15. Although dead and animated as a zombie, the neogi retains some of its race's personality: given the choice, it will always hang back from combat, by preference sheltering behind the protective bulk of the umber hulks.

## Tactics

Under Manara's orders, the *Nex* will use its considerable firepower to damage and cripple the PCs' vessel. The first

shots will be targeted at the ship itself, hoping to damage the rigging and decrease maneuverability, or even cause a critical hit. As the *Nex* closes, the shots will be targeted at crew on deck, concentrating on characters that look particularly "tough" (i.e. figures wearing plate mail and carrying battleaxes rather than unarmored sailors with daggers).

All of the *Nex*'s weapons are fully manned: 5 zombies each for the two heavy catapults, one for the light catapult, 4 each for the two heavy ballistas, 2 each for the two medium ballistas, and 1 each for the two light ballistas, for a total of 25 crew. That means 22 ju-ju zombies plus the umber hulks and neogi are free for other activities. Twenty of these are armed with light crossbows, as mentioned above, and will begin firing when the ships get close enough.

When the ships are in the same hex, the *Nex* will attempt to grapple. The light ballistas will be used to fire grappling hooks, while 10 of the zombie crew will assist by throwing grappling hooks of their own. As soon as the PCs' vessel is successfully grappled, the zombies will leave the heavy weapons, and all of the *Nex*'s crew will try to swarm aboard the enemy vessel.

At this time, since propulsion is no longer needed, Manara will leave the helm and come up on deck. She will not leave the *Nex*, but will use her magic items to maximum effect. Note that her *ring of the ram* will be very effective against characters in the rigging, or fighting near the ship's rails. (Characters who fall overboard will probably be unable to get back into the fray. Should the *Nex* win, Manara will order her crossbowmen to slay any who've fallen overboard.)

## The Nex

Below decks, the ship is in total darkness (Manara and the zombies have no need for light). In general, the parts of the ship not required for maneuvering or fighting are very badly maintained: the decks are scarred and cracked, some of the bulkheads have dry rot, and there is dust everywhere. There is little of value anywhere on the ship (except as specified below).

The numbers in the following descriptions refer to the ship plans from the *Gallean* card in the SPELLJAMMER™ boxed set. Not all areas or rooms are mentioned



in the descriptions, since many of them are empty; if an area is not mentioned, assume that it is empty and unused. (Early on in her "career" as a lich, Manara discarded most inessential items throughout the ship.)

## Main Deck

### 1. Rope, line and anchor storage.

The room contains two rusty anchors and lengths of rotting rope.

### 3. Captain's cabin.

For a moment you can almost imagine that a living person uses this room. There's a small sleeping cot folded down from the bulkhead, and it's covered with a blanket. One bulkhead is covered with shelves, almost groaning with leather-bound books. And in one corner is a small wooden desk.

The sensation of life lasts only a second, however. Then the smell of rot and corruption catches at your throat. Everything here is mouldy, decaying. The cabin is as dead as everything else on board this death ship . . .

Manara was unable to discard everything that meant something to her when she was alive, as this room shows. The books contain records of the great explorers of the past, and even some tales of Manara's own achievements . . . or at least, they used to. The books' pages have rotted, and the process has been helped along by two bookworms (AC 2; MV 12, Br 3; HD 1/4; hp 2,2; #AT nil; Dmg nil; AL N; THACO n/a), which were accidentally brought on board by one of Manara's animated "recruits."

The desk is unlocked and contains a large leather-bound book: the log of the *Nex*.

Out of habit, Manara kept the ship's log for the first year or so after she became a lich, before deciding it was a waste of time. The language she used is a rare dialect of the common tongue, which is difficult to translate. Characters with the ability to read languages (thieves, for example) have double their normal chances to read the log, to a maximum of 95%.

The log contains records of Manara's explorations before her death (which might or might not be of some value or interest to the PCs), and the story of her

run-in with the demigods. The demigods have used their magic to expunge from the log all information that would lead others to their private "entertainment sphere" (such edits are simply blank spaces). The PCs might find the tale interesting, however, as it should answer many of their questions about Manara.

### 5. Spelljammer helm.

Manara will be present here only if the PCs manage to get aboard the *Nex* while it's still maneuvering. If present, she will be seated on the helm.

The *Nex*'s major helm itself is not an elaborate affair: it's simply a wide-armed chair made of dark wood, with no padding or upholstery. An unlocked box stashed beneath the helm contains Manara's spell book, which records the following spells: *chill touch*, *detect undead*, *burning hands*, *enlarge*, *spider climb*; *spectral hand*, *Melf's acid arrow*, *darkness 15' radius*, *fog cloud*, *shatter*; *feign death*, *hold undead*, *vampiric touch*, *fly*, *wind wall*; *contagion*, *enervation*, *fire shield*, *polymorph other*; *animate dead*, *magic jar*, *summon shadow*, *telekinesis*; *death spell*, *disintegrate*; *finger of death*.

### 6. Chart room.

Charts in long rolls are stored in racks on the bulkheads. The map table in the middle of the cabin has a chart laid on it. A pair of dividers and parallel rulers lie discarded, as though the navigator had just finished charting a course. In one corner is a small chair, secured to the deck.

The charts on the walls are so rotted and decayed that even the lightest touch makes them crumble to dust. The chart on the map table is in slightly better condition, and the instruments are fully usable. The DM can decide exactly what area of space the chart depicts (this can either be a useless chart or a treasure map).

The small chair in the corner is actually a minor helm, the *Nex*'s back-up means of propulsion.

## Steerage Deck

### 3. Brig. The door is locked.

As you open the door, something vaguely humanoid flings itself at you from the darkness within the room . . .

The monster is a wight: AC 5; MV 12; HD 4+3; hp 25; #AT 1; Dmg 1-4; SA energy drain; SD hit only by silver or +1 or better magical weapon; AL LE; THACO 15.

Soon after Manara's death, she thought a high-level sage might be able to break her curse. She could hardly walk into a library or university in her condition, so she attacked a ship that was ferrying a well-known sage between planets, and kidnapped the old man. She put her problem to him, but he was either unable or unwilling to help her. In a rage, she locked him in the brig and left him there to die.

The sage's anger at being treated in such a manner was so great that it survived the man's physical death. His spirit has remained bound to this plane and to his mortal remains in the hope that he could finally wreak vengeance on Manara. As soon as the PCs opened the door, the sage's spirit animated his body as an undead creature.

The undead sage has one goal, and one goal alone: to confront Manara and destroy her, or be destroyed himself in the attempt. He has no interest in the PCs, other than as obstacles. Thus, he's not really attacking them when he rushes through the door, just trying to get past them (the PCs probably won't see it that way, of course). If the PCs attack him, he will fight back.

The undead sage will search throughout the *Nex* until he finds Manara, or her body. If he doesn't find her aboard the *Nex*, he will try to board the PCs' vessel to continue his search there. If Manara is nowhere to be found on either vessel, he will assume that the PCs have destroyed her, and his spirit will finally be at rest; his body will crumble to dust. If he finds Manara, however, he will attack her with his bare claws until one or the other of them is destroyed. If the sage manages to best Manara, his vengeance is satisfied, and his body crumbles to dust.

At no time will the undead sage communicate with the PCs, even if they use *speak with dead* or equivalent magic (the sage simply has more important things on his mind). Also, because of his focus on revenge, he is turned as a spectre.

## Concluding the Adventure

A strong party should be able to defeat Manara and her crew, although it will probably be a tough fight. A weaker party should be able to escape.

Once Manara is defeated, the PCs might be disappointed at the lack of treasure aboard the *Nex*. Remember, however, that they have the chance to acquire Manara's spell book and her magic items, plus a major and minor helm—nothing to sneeze at. (They also have the cargo from the *Sculpin*, and various other items as well.) If a PC used the circlet found on the *Sculpin* during the battle, it will crumble into dust immediately on Manara's destruction.

Should Manara survive the encounter—either through defeating the PCs or through not being able to prevent their escape—she will continue to terrorize the spaceways until she finally meets a foe tough enough to defeat her. If the PCs escape, a future adventure can revolve around their quest to destroy the lich-ship once and for all.

## Forgotten But Not Gone

Setting: Wildspace

Party: 3-6 characters, levels 6-8

Ship: Any

### Setups

- The PCs have heard that there is pirate activity in a particular region of wildspace. Rumors indicate that perhaps one of their bounty pirates is responsible.
- The PCs have heard tell that an abandoned hulk was seen floating in a certain area of space. They decide, or are asked, to investigate the possibility of salvage.
- The PCs are travelling in wildspace and stumble upon an inert ship (i.e., the DM can drop this adventure in at any time).

"Nautiloid off the starboard bow!" your lookout cries.

"Battle stations!" you yell, squinting to pick out the illithid vessel against the black velvet of the sky. Not all mind flayers are hostile, but enough are to warrant a few precautions.

There's the vessel, its distinctive spiral hull painted a particularly

nauseating shade of greenish-mauve.

Wait. There's something just not right about the shape. Something different . . .

Of course. The ship's long piercing ram is missing. Broken off, it looks like. And isn't the spiral hull misshapen as well? Slightly flattened at the stern, as if by a heavy impact?

There's something else, too: the ship is tumbling slowly, end over end, completing one revolution in perhaps five minutes. A Nautiloid under command wouldn't be doing that. Could the ship be abandoned?

Or is it some kind of mind flayer trick?

The Nautiloid is 4 hexes away from the PCs' vessel. The ship's tumble is too slow to cause any serious problems with boarding.

### Derelict

Once the proud ship *Void Reaper*, the Nautiloid is, in fact, a drifting hulk. The mind flayers ran afoul of an unknown foe, and were defeated in battle. No mind flayers survived the confrontation.

The vessel itself is a little the worse for wear. The piercing ram and much of the rigging have been torn away. The hull has been staved in at the stern, shattering the aft portion of the scout deck (and incidentally destroying the vessel's series helm). Should the PCs wish to sail this vessel (perhaps under a temporary helm), it has a Maneuverability Class of E, and only 6 hull points remaining until it's had a complete refit. The air within the ship is fouled, and is filled with the stench of decay.

### Command Station

#### 1. Captain's Chair.

Heavy impact has weakened the structural integrity of the walkway supporting the chair. If a character weighing more than 150 pounds (including equipment) walks out to the chair, there is a 50% chance that the walkway will break. The fall to the bridge deck will inflict 2d6 points of damage.

#### 2. Captain's Day Room.

Papers and books are scattered everywhere, flung from shelves, etc. by ramming impact. There is a desk of human design, and in one of its drawers is the

ship's log (written in the illithid tongue, of course). If anyone can read it, it identifies the vessel as the *Void Reaper* under the command of captain "Head Peeler." The last entries indicate that the vessel was involved in slave-trading with a neogi deathspider.

Shoved to the back of the drawer is a small pouch that contains 3 ambers (100 gp base).

### Scout Deck

#### 1. Forward Observer.

The red-tinted window has been smashed. A dead mind flayer, killed by a crushing blow to the head, is crumpled beneath the window.

#### 2. Series Helm.

The hull has been smashed in, leaving a gaping hole. The four small seats that made up the series helm have been destroyed. Crushed mind flayers still sit in two of the chairs.

### Bridge Deck

#### 1. Main Saloon.

The door has been smashed from its hinges. The broken door and the frame show marks of axe blows. The inside of the saloon is a mess. The tapestries have been torn from the walls, the leather hassocks scattered and hacked, the small oil lamps smashed by heavy blows. Two mind flayers lie dead, but apparently took at least one attacker with them: a dwarf-sized helmet, its front discolored and warped by extreme heat, lies on the floor by the door.

All bodies within the *Void Reaper* have been dead for several weeks.

#### 2. Bridge Floor.

Signs of combat everywhere: blood stains (illithid and mammalian), broken arrows, here a riven shield and there a ruined light crossbow. A dead illithid with a crossbow bolt buried in its throat lies crumpled at the bottom of the port stairway.

### 3. Ventral Observers.

The port window has been shattered and its door smashed inward. (Somebody obviously broke in this way.)

### 4. Upper Battle Station.

It must have been some fight! The racks that held ammunition for the medium ballistas are empty. One of the ballistas is smashed and slightly burned. The other two look to be in working order. Crossbow bolts are imbedded everywhere. One of the doors has been blown from its hinges, either by magic or a massive firearm of some kind.

## Battle Deck

### 1 and 2. Officers' Quarters.

Both doors have been broken down, and the interiors of both rooms ransacked. Nothing of value remains.

### 3. Sail Storage.

The canvas is partially burned. (Somebody apparently tried to light a fire here, but it seems to have gone out by itself. Trying to destroy the ship . . . and the evidence of what happened?)

### 4. Chart Room.

A dead illithid is sprawled over the maptable, a crossbow bolt in the back of the head; probably never knew what hit him.

The charts—all in illithid symbology—are untouched. The PCs might find some use for these.

### 5. Cargo Hatch. The hatch is closed.

### 6. Assembly Deck.

Something large and black hangs in the air in the middle of the open space. You spot each other at the same moment. The black creature turns agilely and hurtles at you, mouth agape.

The creature is a night skavver (AC 3; MV 18; HD 6; hp 28; #AT 1; Dmg 1-10; SA swallow; AL N; THACO 15; see *Lorebook of the Void*, page 85) that came aboard to "graze" the ship. It ate everything worth eating in this open area, but was too large to fit through doorways or staircases to search elsewhere.

If seriously challenged and badly wounded, the skavver will flee. The creature's belly contains a short sword, three crossbow bolts, a helmet, a golden bracer (75 gp value), a brass oil lamp, and a *dagger* +1.

## Cargo Deck

### 1. Captain's Cabin.

Both doors have been smashed in by heavy axe blows, and the room within looks as though a whirlwind went through it. Stuff is scattered everywhere (signs of a struggle, you say?) and here and there the walls show scorch-marks that bear mute witness to magic use. A dead illithid lies in a heap against the wall (the captain, you presume). He didn't go down easily: five crossbow bolts protrude from his chest, and his body shows other wounds as well.

A plain gold band encircles one of his fingers.

The ring is a *ring of shooting stars*, but all of its charges have been expended. (Enterprising PCs might be able to get it recharged, however.)

Hiding in a corner of the ceiling (where it has constructed an elaborate web) is the captain's pet, a large spider (AC 8; MV 6, Wb 15; HD 1+1; hp 7; #AT 1; Dmg 1; SA poison; AL N; THACO 19).

If the PCs decide to examine the dead mind flayer, read the following:

There seems to be something in the creature's beak. A coin of some kind . . .

The coin is a copper piece of an unusual octagonal design, unlike any other currency the PCs have seen before.

### 2. Captain's Chart/Treasure Room.

The captain's personal charts remain in their racks. A large chest stands open and empty.

Something moves in the empty room. A rat! Isn't there anywhere those creatures can't be found?

The room is home to three normal rats (AC 7; MV 15; HD 1/4; hp 1, 1, 2; #AT 1; Dmg 1; SA 5% chance of serious disease; AL N(E); THACO 20). They will fight only if cornered and threatened.

### 3. Crew Quarters.

The bulkheads are lined with sleeping racks—wooden structures to prevent levitating illithids from drifting about while they're asleep. Huddled in the bottom of one rack is a mind flayer with a slit throat (killed while asleep?).

### 4. Galley.

The illithids used this room for storage. (Their food supply was down in the slave pens, after all.) The room is full of ropes, belaying pins, spikes, etc.—all the bricabrac necessary for running and maintaining a ship.

### 5. Cargo Bay.

Score-marks on the floor show that, at one time in the past, this ship was carrying some heavy cargo. But now the large area looks empty.

The area is home to a colony of 10 normal rats (AC 7; MV 15; HD 1/4; hp 1, 1, 1, 1, 2, 2, 2, 2, 2, 2; #AT 1; Dmg 1; SA 5% chance of serious disease; AL N(E); THACO 20), which will stay well out of the way of the adventurers if given half a chance.

## Slave Deck

The enemy that attacked the Nautiloid made sure that every last illithid aboard was killed, but—for whatever reason—made no effort to release the human slaves who were locked up below deck. The imprisoned slaves soon died of thirst and hunger, raging in anger and hatred at both the illithids who had captured them and the attackers who had left them to perish. In a number of cases, so great was this hatred and anger that the prisoners' spirits haven't "passed on," but remain behind as various kinds of undead to haunt the ship on which they died.



## CHAPTER 2: RELICS & HULKS

Each turn that the PCs spend on the slave deck, roll 1d6 and consult the following encounter table:

Die Roll	Encounter
1	—
2	—
3	1 wraith
4	1 wraith
5	1 spectre
6	1 ghost

There is only one of each type of undead. If it is defeated, it will not be encountered again.

**Wraith:** AC 4; MV 12, FI 24 (B); HD 5+3; hp 13; #AT 1; Dmg 1-6; SA energy drain; SD hit only by silver or +1 or better magical weapons; AL LE; THACO 15.

**Spectre:** AC 2; MV 15, FI 30 (B); HD 7+3; hp 33; #AT 1; Dmg 1-8; SA energy drain; SD +1 or better weapon to hit; AL LE; THACO 13.

**Ghost:** AC 0 or 8; MV 9; HD 10; hp 32; #AT 1; Dmg age 10-40 years; SA special; AL LE; THACO 11.

Until the PCs enter the slave deck, the undead have not wandered elsewhere in

the ship. Once the PCs have entered this deck, however, the undead are free to pursue them throughout the vessel.

There is one act by which all three of the undead can be laid to rest without combat. If the PCs can identify the attackers who left them to die, and then bring these attackers to justice or otherwise wreak vengeance on them, the undead will simply fade away.

### 1, 2 and 3. Staterooms.

These rooms are untouched (possibly implying that the attackers never came down this far). All three rooms were obviously occupied by illithids. There are sleeping racks on the bulkheads, hassocks and carpets on the deck, and personal effects left lying around (nothing of value, however).

### 4. Passageway.

Four rats are prowling the passageway (AC 7; MV 15; HD 1/4; hp 1, 2, 2, 2; #AT 1; Dmg 1; SA 5% chance of serious disease; AL N(E); THACO 20), and will stay well away from the PCs if given a chance.

### 5. Stateroom.

The furnishings here are a little more opulent than those elsewhere (the passenger in this room was considerably more important). Partially concealed under a pile of carpets and blankets is a small locked chest. The lock is protected by a poison needle trap. (In case the PCs decide to search, none of the dead illithids has a key on its person.)

The chest contains papers (in illithid) that identify the bearer as ambassador plenipotentiary for the mind flayer race when dealing with neogi interests. There is also an elaborate golden medal (175 gp value) and a sash composed of small silver scales (100 gp value).

Another large spider (AC 8; MV 6, Wb 15; HD 1+1; hp 5; #AT 1; Dmg 1; SA poison; AL N; THACO 19) has constructed its web near the door.

### 6. Crew Quarters.

Like room 3 on the cargo deck, the bulkheads are lined with sleeping racks. There is nothing else of value present.



### 7. Slave Quarters.

Each cell contains one or two human corpses. There are marks on the inside of each door showing that the occupants tried everything to break out before they died.

The three cells on the starboard side of the vessel (next to room 8) contained prisoners who were more powerful, one to a cell. The doors are reinforced, indicating that the illithids were taking extra precautions against their escape. These three prisoners have become the undead prowling the slave deck.

Unless the particular undead has already been encountered and defeated elsewhere, as soon as a PC opens the door to one of these cells, the undead will manifest itself inside the cell and attack. The aftmost of the three cabins is home to the ghost; the next is home to the spectre; the most forward of the three is home to the wraith.

### 8 and 9. Guard Post.

Both rooms are empty of life. There are a couple of hassocks thrown around the floors. Hanging from hooks on the bulkhead are sets of manacles (three sets in room 8, two sets in room 9) and keys for them. There is also a scourge hanging from a hook in room 8.

### 10. Jettison and Storage.

The medium jettison is undamaged, but its supply of ammunition is totally expended.

## Concluding the Adventure

Unless the PCs destroy them or unintentionally give them passage off the abandoned ship, the undead will haunt the Nautiloid forever . . . at least, until another ship blunders unwittingly by. If they can, the undead will take over another ship and use it to pursue their vengeance. (Note that the undead know no more than the PCs about exactly who attacked the Nautiloid.)

When they return to civilization, the PCs will probably try to identify the coin they've found. Any sage or collector interested in coins can tell them that it is a coin from a civilization that bloomed and fell centuries ago on a rock among the Tears of Selune in Realmspace. Only certain people—high-ranking law enforcement officials, naval officers, etc.—can tell the PCs its true significance, however. (Jasson, the member of the Pro-

gressive Order of Thought from "Letters of Marque" would be able to tell them.) If the PCs discuss the coin with a suitable contact, read the following:

Your contact shoots you a hard, level look, and says, "Where did you find this coin? No, no, doesn't matter." He sits back and closes his eyes. "Few people know what I'm about to tell you now, and I'd appreciate it if you'd keep it to yourself. No use in spreading fear, you know." He sighs. "Have you heard of Cain? Cain the pirate? Well, Cain has a second career, one sometimes even more lucrative than piracy. Cain is an assassin, and a very good one at that. His arrogance is beyond belief, but there is reason for it. That coin—an 'ocon,' it's called—is Cain's calling card. Don't ask me why he chose it. But he always leaves it behind at the scene of one of his assassinations. The fact that you found it tells me that you stumbled across one—or more—of his victims."

If the PCs dig around a little more, they'll hear rumors that a large and powerful mind flayer faction was cutting a trade deal with certain neogi interests. The mind flayer's chief negotiator, an ambassador plenipotentiary, was being conveyed in the vessel *Void Reaper* to meet with neogi representatives. Certain human groups didn't want this deal to reach fruition, and it's an open secret that a contract was put out on the illithid ambassador. It certainly seems now that Cain had taken up the contract and discharged it admirably.

**Note to the DM:** The PCs might now have a reason, other than financial, to go after Cain the pirate. It is probably advisable to keep them from confronting him until you decide to run the last adventure in this book, "Cain."

PCs with a cunning twist might develop their own adventures based around the ambassador's identification found in room 5 of the slave deck. (Perhaps they can claim to have made the hit themselves, for example.)

## Sojourn Among the Stars

Setting: The Phlogiston  
Party: 2-6 characters, levels 6-10  
Ship: Any

## Setups

- The PCs have heard tales of a small, abandoned ship drifting in the phlogiston. They decide, or are asked, to investigate.
- The PCs are travelling in the Flow and stumble upon an inert ship (i.e., the DM can drop this adventure in at any time).

It's hard to pick out objects in the Flow against that background of chaotic, ever-shifting colors. You strain your eyes . . .

And there it is, just where your lookout spotted it. Small ship. Dragonfly hull, but modified here and there. (Portholes along the cargo hold, for instance.) It's just drifting in the flow, seemingly inert.

No, wait a moment. It's hard to be sure against the chaos of the phlogiston, but isn't there a dim, flickering light showing through those portholes?

The Dragonfly is drifting along with the currents in the Flow, 4 hexes away from the PCs' vessel.

## Terigamar

The Dragonfly has had several modifications in addition to the portholes mentioned earlier. The cargo hatches in the upper deck have been sealed, and the catapult has been removed. The rigging has also been simplified, making it possible for one creature—in addition to the helmsman, of course—to handle the ship. (With this minimum crew, its Maneuverability Class drops to E.)

The vessel is the home and laboratory of a human wizard by the name of Terigamar. Prevented by constant interruptions from making the kind of progress he wanted in his research, he fitted out this ship as a flying workshop and took to the phlogiston. He made landfall only when he needed more supplies or had to recharge his air envelope. His last such visit was perhaps 75 years ago, but Terigamar hasn't noticed the passing of time, being engrossed in his research.

Terigamar was an old man when he first took to space. In the intervening period, he died of old age . . . but didn't notice. So great was his attention to his work that physical death didn't even break his concentration. Unbeknownst

to himself, Terigamar has made the transition from living wizard to undead lich. (He did notice—if only peripherally—that his familiar, Hisst, was acting strangely toward him for a time, but things soon got back to normal.) Terigamar is incredibly absent-minded about everything but his work. He eats when he's hungry, and makes landfall when the air gets foul. It hasn't registered that it's been some decades since either has happened.

Hisst used to remind Terigamar when they needed air, but after Terigamar died, Hisst's air requirements were so small that they have not needed fresh air in decades.

If it is brought to his attention that he's dead, his first reaction will be mild sadness, but his next will be gladness: now he has eternity before him to continue his research. Whether he knows of his own death or not, he will fight with all his considerable powers against any attempt to end his existence.

Terigamar has been conducting research on the very nature of space itself. Thus many of his spells—including one of his own creation, *summon cosmic storm*—are closely tied to the powers of space. He is not jealous of other wizards and will gladly share the results of his research. When it comes to exchanging or passing on spells, however, he will expect fair payment. In his many decades of research, he has never been fortunate enough to learn one spell that he needs: *time stop*. If a PC wizard can teach him the spell, or acquire it on a scroll, he will reciprocate with any two ninth-level spells, plus a magic item of some small power (DM's choice from his hoard).

**Terigamar** (lich): AC 0; MV 6; HD 18; hp 71; #AT 1; Dmg 1-10 or by spell; spells: *cantrip, comprehend languages, detect magic, identify, unseen servant, continual light, invisibility, know alignment, levitate, wizard lock; blink, clairvoyance, illusionary script, Leomund's tiny hut, slow, confusion, dimension door, Evard's black tentacles, Leomund's secure shelter, magic mirror; Bigby's interposing hand, distance distortion, feebelmind, seeming, telekinesis; Bigby's forceful hand, chain lightning, repulsion; duodimension, reverse gravity, shadow walk; demand, symbol; Bigby's crushing hand*; SA paralysis; SD +1 or better magical weapon to hit; AL CN; THACO 10. Terigamar looks like an inadequately-preserved corpse (if there were any

mirrors around the ship—and there aren't, since Terigamar is far from vain—his appearance might give the lich some clue as to his true nature).

**Hisst** (pseudodragon): AC 2; MV 6, Fl 24 (B); HD 2; hp 6; #AT 1; Dmg 1-3 + special; SA poison sting; SD chameleon power; AL N(G); THACO 19. Hisst is a typical pseudodragon, somewhat demanding of his master's attention, but quite devoted. Hisst is very suspicious of visitors, even if they appear friendly, and will use his chameleon powers to observe without being observed. If he sees anything vaguely suspicious or threatening, he immediately reports to Terigamar.

**Dorkin** (homonculous): AC 6; MV 6, Fl 18 (B); HD 2; hp 3; #AT 1; Dmg 1-3; SA bite causes sleep; AL N; THACO 16. Many years ago, Terigamar created Dorkin the homonculous to assist him in his research (Hisst wanted to help, but his lack of real hands limited his effectiveness). Normally, a homonculous has a personality similar to its creator. In the case of Dorkin, something went slightly wrong. The homonculous is an abject coward: it doesn't like sharp objects, it doesn't like flames, and it's terrified to the point of incontinence of coming too near anything magical. Thus it's absolutely useless as a sorcerer's apprentice. Rather than being angry at this failure, Terigamar's heart was touched by the little creature. Now he dotes on the small beast (at first Hisst was jealous, but now he, too, feels affection for the cowardly creature). When the PCs enter the ship, Dorkin will immediately hide, coming out only when Terigamar has convinced him it's safe . . . and then only cautiously. The homonculous has a morale of 4.

## Meeting the Wizard

Terigamar will feel his ship move if anybody boards her. He will break off whatever research he's involved in—somewhat peevishly—and go to investigate. His appearance and his irritated manner—"Well? What in Hades do you want?"—might prompt the PCs to ill-considered action. If attacked, Terigamar will defend himself to the best of his (considerable) abilities against the "pirates of the Flow" who are obviously trying to capture his ship. (Thus PCs who leap into combat without scoping out the situation first will probably find they've made a fatal mistake.)

## Wizard's Vessel

### Upper Deck

The entire upper deck is covered with a patina of space dust, and looks as though nobody's set foot on it in years. (True; Terigamar rarely leaves his lab.) Here and there the deck is scorched. (These marks were made by a couple of Terigamar's experiments that went slightly wrong.) The hatch leading to the companionway to the lower deck is stiff, but not locked.

### Lower Deck

The entire lower deck is well-lit. The wizard has cast *continual light* on objects throughout the vessel: here a lamp bracket, there a portion of the overhead.

#### 1. Bridge.

The ship's minor helm—a plain, unornamented chair built from heavy, dark wood—is mounted forward of the mainmast, directly between the ship's "eyes." Set in the bow is the chart table. The charts and navigational instruments are covered with dust (Terigamar has had no need of them for 75 years).

#### 2. Captain's Cabin.

This is where Terigamar slept, back in those days when he needed to sleep. There is a comfortable bed (unmade), and a plush armchair. The bulkheads are lined with bookshelves full of books and scrolls in a dozen languages. Most deal with magic and the history of magic, although some are less scholarly, putting forward some really off-the-wall theories concerning space and time. Although the lich doesn't need to sleep, Hisst and Dorkin do, and they put the bed to good use. Dorkin hides in the bed until assured of his safety.

#### 3. Crew Cabin.

Terigamar has converted this cabin into a storeroom and "overflow" library. The bulkheads are lined with shelves and cupboards, filled to bursting with spell components and various oddities (a kind of "lodestone" that doesn't attract iron but attracts certain other rare metals; a small sliver of metal floating in the air an inch above a dish of mercury; a candle whose flame burns bright white and never flickers; a stiletto balanced on its point on the table, rotating about its axis



slowly and never falling over; and a disk of metal half an inch across and a tenth of that thick that turns itself over every several seconds).

#### 4. Cargo Hold.

The hold has been refitted to make a comfortable, well laid-out laboratory. Three small portholes down each side give a view of the phlogiston. There are tables and workbenches, all covered with unfinished experiments of one kind or another. Here a foul-smelling liquid bubbles over an alcohol burner; there a rock glows with a cold white light while a strange device next to it ticks sporadically. Most of these experiments are incomprehensible to anyone except Terigamar. Should the PCs befriend him, he will proudly give them detailed (interminable and unintelligible) explanations of what he's attempting to do and what he's learned.

In addition to his experiments, Terigamar keeps his spell book and certain interesting magical items in this room. No details of items are given; DMs can give Terigamar whatever items they see fit. The spell book contains all spells of levels 1-3. For higher levels, it contains the spells he currently has memorized, plus the following: *charm monster*, *detect scrying*, *enchanted weapon*, *extension I*, *illusionary wall*, *Rary's mnemonic enhancer*, *vacancy*; *chaos*, *contact other plane*, *distance distortion*, *false vision*, *Leomund's secret chest*, *sending*, *teleport*, *wall of force*; *contingency*, *invisible stalker*, *true seeing*; *forcecage*, *teleport without error*; *astral spell*, *summon cosmic storm*. This last spell was created by Terigamar, and has the following characteristics:

### Summon Cosmic Storm

(Evocation) Wizard 9th level

Range: Special

Components: V, S, M

Duration: Special

Casting Time: 9

Area of Effect: Special

Saving Throw: None

This spell calls into existence that strange phenomenon known as the "cosmic storm." Some sages theorize that the cosmic storm is actually one end of a "wormhole" in space, and anything sucked in at one end is ejected through the other somewhere (or even some-

when) else.

It can only be cast in wildspace, more than 100 miles from the nearest planet-sized object. The storm appears in 1-10 turns, at a distance of 1-20 hexes from the spellcaster's current position, in a random direction. Once it has been summoned, the storm cannot be controlled by the caster or by anyone else. Each turn, the storm moves 1-6 hexes in a random direction. At the beginning of each turn, before they make their own movement, all ships within 20 hexes of the storm are moved 4 hexes directly toward it. This movement does not change the ships' headings. Any ship that manages to move more than 20 hexes away from the storm is free of its influence. Any ship that enters the same hex as the storm has been engulfed by it. The cosmic storm is a gateway to other parts of the space-time continuum; any ship absorbed by the storm can be deposited anywhere in the universe. The storm remains in existence until the distance between it and the spellcaster exceeds 20 hexes, or until the spellcaster is absorbed by the storm.

The material components for the spell are a piece of lodestone and a piece of mithril, both of which are consumed in the casting.

### Concluding the Adventure

If the PCs can control their impulse to get into a scrap with Terigamar, the lich can prove a great resource for them. He can also be a convenient tool for the DM with which to lead the PCs into other adventures. For example, what if Terigamar needs something special for his research—the brain of a radiant dragon, for instance—and wants the PCs to acquire it for him? He certainly has enough clout to add weight to such a request . . . particularly if he backs it with a *demand* spell.

Should the PCs ever seem to be abusing Terigamar's hospitality, the DM can simply have the lich move his ship to another locale. All meetings between the lich and the PCs should be at the lich's whim, not that of the players.

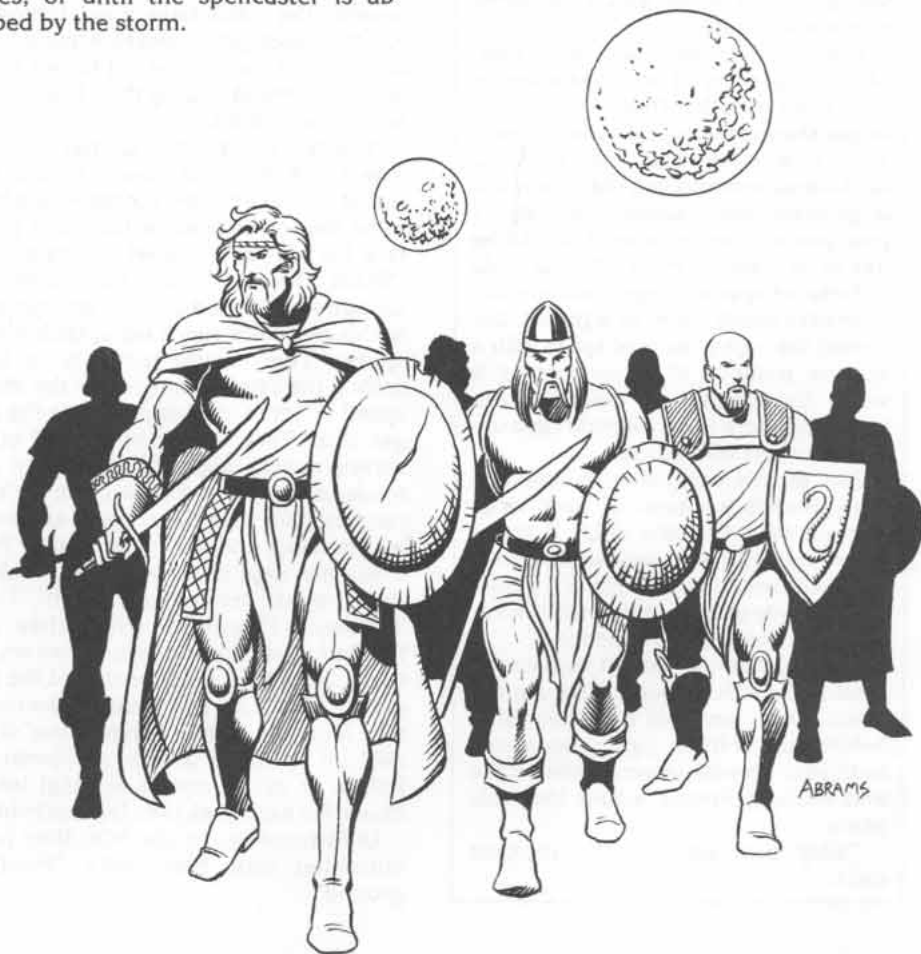

## The Brain Trade

Setting: Wildspace

Party: 4-6 characters, levels 6-8

Ship: Any of 25-50 tonnage

### Setups

- The PCs have heard rumors that pirates seem to be very active in a certain area of space. (If they dig a little deeper, however, they'll hear something a little strange about these rumors: sometimes items of value have been left behind, and never has a body been found aboard one of the plundered vessels.) The rumors hint that the culprit might be one of their bounty pirates.

- The PCs are asked or hired to find out what's happened to a certain ship that's some days overdue.

- The PCs are travelling in wildspace when, without warning, their ship drops to tactical speed.

You look in the prescribed direction. A ship is pulling out from behind a mountain-sized chunk of rock. As you watch, it accelerates toward you.

Couldn't you be wrong for once...?

The ship is 10 hexes away, 30° to port and astern, level with your gravity plane. It is on an interception course, with SR 4.

### Procurers

It is well known that mind flayers feed on the brains of other creatures. It is also known that they much prefer to let others do the dirty work for them. Thus, a rather unpleasant trade arrangement has grown up between the mind flayers and the neogi. Rapacious and nasty, certain neogi are quite willing to capture slaves and hand them over to the mind flayers as food. In return, the mind flayers act as intermediaries between the "small masters" and the Arcane (who won't deal directly with the neogi). All three races benefit: the mind flayers get brains to eat, the neogi get access to Arcane technology, and the Arcane get to sell more product without soiling their (somewhat situational) ethics.

A certain neogi, Sisk Hal, has cut such a deal with the mind flayers. He and the rest of the Sisk tribe—accompanied by a mind flayer whose name (or, more properly, his telepathic "label") translates to "Skull Toucher" in the common tongue—have been preying on shipping in this region of space using their Mindspider. Their usual tactic is to lurk among the asteroids, then use the ship's speed to catch, ram and grapple the target ship. Then umber hulks and other slaves swarm aboard. All efforts are made to capture the crew alive; if that's not possible, then the corpses are eaten by the neogi and the umber hulks. Prisoners are kept alive until the Mindspider's next rendezvous with Skull Toucher's Nautiloid, when they are handed over to the mind flayers. If there's anything of value aboard the target ship that's easy to carry off, the neogi take it as part of their "finder's fee." If it's difficult to move (like a spelljamming helm), or of no use to a neogi (elven boots, for example), they leave it behind.

Unfortunately for the PCs, they have stumbled into Sisk Hal's "hunting ground."

## Mindspider

Sisk Hal's ship is christened *Collector* (in the neogi tongue, of course). It matches the statistics for a Mindspider given in the SPELLJAMMER™ boxed set, with a single modification: a small gunnery platform has been mounted directly above the bridge (area 1 on the primary deck), on which is mounted a forward-firing light ballista (crew 1). Since this is very close to the grappling ram (in fact, the ballista fires between two "legs" of the ram), it's rather a precarious position. When the ship rams, there is a 60% chance that the gunner will be thrown overboard by the impact (not important to the neogi, somewhat more so to the gunner). The Mindspider has SR 4.

Sisk Hal is owner and undisputed master of the ship. There are four other neogi aboard, all from the same brood: Sisk Ar, Sisk Ceth, Sisk Jor and Sisk Urd. Each neogi has a single umber hulk slave. Skull Toucher the mind flayer has come on board alone. There are also 10 charmed slaves, who operate the weapons (all humans). Finally there are the captives: two elven fighters, an elven mage, and the "power source" inside the lifejammer.

**Neogi** (x5): AC 3; MV 6; HD 5; hp 28, 26, 24, 23, 19; #AT 3; Dmg 1-3/1-3/1-6; SA slowing poison; AL LE; THACO 15. (Sisk Hal is the neogi with 28 hp.) Like all neogi, the Sisk tribe will do whatever it takes to preserve their lives. They will explain about the deal with Skull Toucher, trying to put all the blame on him ("We were just following orders"), and will tell the PCs the exact location of Skull Toucher's Nautiloid, should the PCs wish to go and destroy it (they might even tell the truth). If defeated or captured, the neogi will always be looking for the most efficient way of turning the tables. Around Sisk Hal's neck is a set of keys. These open the shackles in area 2 of the secondary deck.

**Umbur hulk** (x5): AC 2; MV 6; HD 8+8; hp 43, 45, 47, 50, 52; #AT 3; Dmg 3-12/3-12/1-10; SA confusion; AL CE; THACO 11. The umber hulks are loyal to their neogi masters, and will fight to the death to protect them.

**Skull Toucher** (mind flayer): AC 5; MV 12; HD 8+4; hp 38; #AT 4; Dmg special; SA mind blast; SD 90% magic resistance; AL LE; THACO 11. The mind flayer can use the following powers, one per round, as a 7th level mage: *suggestion*,

Interesting area of space, you tell yourself, not what you'd consider prime real estate.

Around your vessel are great tumbling mountains of rock, ranging in size from smaller than a house to larger than some islands you've seen. Your charts showed this asteroid field—and also told you that it was too large to be easily skirted—but it didn't give you an idea of what it would be like to be inside it. Most asteroid fields or belts are sparse things: total amount of matter about equal to a planet, but spread through a torus of space with a volume millions of times that of a world. Frequently you wouldn't even know you were in an asteroid field unless the chart told you so.

Not in this case. Everywhere you look, there's a chunk of rock large enough to hole your ship. If those sages are right who believe that asteroid belts are the remnants of a planet that disintegrated, this must have been one monster of a planet.

With all this mass about you, you're limited to tactical speed. What a great place for an ambush! Hide your ship behind one of those flying mountains until your prey blunders by, then close and destroy. Pirates would love this place...

"Ship port astern!" the lookout calls.

*charm monster/person, ESP, levitate, astral projection, and plane shift.* The mind flayer hides its natural arrogance in the presence of the neogi (it doesn't pay to alienate a useful supplier, even if that supplier is of an inferior race), but will certainly not do so when it comes to PCs. Perhaps surprisingly, Skull Toucher will surrender if the only alternative is death. (Even though the thought of surrendering to lesser creatures is distasteful, more unbearable is the thought that—the creature should die now—it's brain will never become part of its group's elder-brain.) It will certainly take advantage of any opportunity for escape, however.

**Charmed human slaves** (x10): AC 8; MV 12; F1; hp 2, 3, 3, 4, 6, 6, 6, 8, 9, 10; #AT 1; Dmg by weapon; AL N; THACO 20. The slaves once formed the crew of a ship unlucky enough to cross Sisk Hal's path. They all wear leather armor and carry short swords (Dmg 1-6) and daggers (Dmg 1-4). In their charmed state, they are loyal to the neogi, who they believe to be their protectors against "pirates" like the PCs; their morale is fanatical (18).

## Tactics

Once the Mindspider has rammed and grappled, the *charmed* crew, accompanied by three of the umber hulks, will board and try to take as many prisoners as possible. Sisk Hal will await the outcome in his quarters (primary deck area 4), accompanied by his umber hulk. The other neogi will wait in area 3, guarded by the other umber hulk. Skull Toucher will watch the proceedings from the bridge; if it appears that the mind flayer can affect the outcome, it will climb from the bridge to the ballista platform and use its mind blast or magical abilities from there. Should the fight go against the neogi's slaves, Skull Toucher will return to the bridge and make a last stand there.

## Primary Deck

### 1. Bridge and Helm.

In the reddish light coming in through the Mindspider's "eyes," everything looks wet with blood—an unpleasant image, but not wholly inappropriate. The room is dominated

by an ornately-carved wooden box, similar in shape and size to a large coffin. Its lid is secured by heavy latches. Just forward of the coffin is a strangely-shaped low stool, something designed to accommodate the neogi form, you assume, and carved from the same piece of dark wood as the coffin.

What's that? A dull thudding noise. Coming from within the coffin . . . ?

The coffin and stool arrangement is the Mindspider's lifejammer helm. The victim is locked within the coffin, while the neogi captain "sits" on the stool and controls the craft.

The lid of the coffin is latched but not locked. If the PCs open the coffin, read the following:

You release the second latch. Suddenly the coffin lid is slammed open from within, and a pale figure lunges at you . . .

The victim inside the lifejammer is an elven poet/explorer named Elowynn Silvermoon. She has felt the lifejammer draining the life from her body, and has decided that it is much better to die fighting for her freedom than to perish in this unholy contraption. Thus, she's decided to attack the first neogi or neogi slave that opens the lifejammer.

Elowynn Silvermoon is totally unarmed, but she will attack with all her might until she is killed, incapacitated, or somehow persuaded that the PCs aren't neogi slaves.

**Elowynn Silvermoon:** AC 10; MV 12; F7/C5; hp 4; #AT 3/2; Dmg by weapon or spell; Str 13, Dex 11, Con 16, Int 13, Wis 14, Cha 13; spells: none; AL CG; THACO 14. Elowynn normally has 33 hit points, but the lifejammer has drained all but 4. She is unarmed and unarmored. Due to her contact with the lifejammer, she is unable to cast spells for 24 hours. Elowynn is a typical elven explorer: she roams the universe simply because she burns to learn and see new things, not for any thought of practicality. She and her crew—more friends or family now than employees—have sailed her dragonfly, the *Outward Bound*, through more crystal shells than she can remember and seen enough wonders to (almost) satisfy an elf's curiosity.

### 2. Chart Room.

Neogi don't seem to be too good at housekeeping. Charts are strewn everywhere, and navigational instruments are scattered across the mappable, on chart racks and on the floor.

The charts are all in neogi symbology. A character with a proficiency in modern languages or navigation can make a proficiency roll (with a -4 penalty) to decipher them. Even when deciphered, there's nothing of any value or interest on the charts.

### 3. UMBER HULK AND NEOGI QUARTERS.

The four lesser neogi and one umber hulk will probably be present. The room contains nothing but four of the low hassock-like pillows on which neogi sleep.

Note that the open hatch to the lower decks poses a significant threat to people fighting in this room. The neogi and umber hulks know it, too, and will try to push characters into the shaft (the fall to the secondary deck inflicts 1d6 points of damage).

### 4. SISK HAL'S QUARTERS.

Sisk Hal and his umber hulk will probably be present. If they are, the door is secured from the inside. There's no keyhole on the outside, so the PCs will have to break it down.

As master of the ship, Hal's quarters are fairly opulent (by neogi standards). As well as the standard neogi sleeping hassock and a pallet for his umber hulk, the floor is covered in a profusion of rugs, all in bright and clashing colors. The walls, too, are hung with cloth of garish hue. Pieces of jewelry hang from hooks on the walls (neogi can't wear human-style jewelry, but they do like the way it sparkles and can appreciate its value): a garnet necklace (350 gp value), a pair of jade earrings (125 gp each), a diamond bracelet (750 gp), a heavy gold chain bracelet (50 gp), and a platinum tiara studded with moonstones (1,000 gp). A chest in the far aft of the room contains sacks of coins: 1,000 sp, 250 gp and 30 pp. Hidden among the silver coins is a *dagger +1* (Hal can't use it, but figured he could sell it to someone eventually).



## Secondary Deck

### 1. Jettison Bay.

The ship's aft-firing medium jettison is mounted here. Barrels contain the small rocks and scrap metal with which it's loaded.

### 2. Prisoner Area.

This is where the neogi keep the prisoners taken from the last ship they ambushed (it was Elowynn Silvermoon's *Outward Bound*). The three captives are all elves of young to middle age: Darla Leafsong, Talis Mornstar and Vray Mornstar. They are shackled hand and foot (Sisk Hal has the keys). The elves know the fate in store for them—meals for the mind flayers—and are extremely grateful to their rescuers.

**Darla Leafsong:** AC 10; MV 12; W4; hp 9; #AT 1; Dmg by weapon or spell; Str 9, Dex 12, Con 12, Int 14, Wis 12, Cha 12; spells: none; AL CG; THAC0 19. Darla used all her spells trying to fight off the Mindspider's attack, and has (obviously) been unable to memorize any more since her capture.

**Talis and Vray Mornstar:** AC 10; MV 12; F3; hp 19, 19; #AT 1; Dmg by weapon; Str 14, Dex 12, Con 13, Int 12, Wis 10, Cha 12; AL CG; THAC0 18. Talis and Vray are identical twins (very rare among elves).

All three elves are unarmored. Their equipment is piled in a corner: two sets of studded leather armor, two long swords, three daggers, two short bows plus 13 arrows, and Darla's spellbook (*cantrip, detect magic, detect undead, identify, read magic, detect evil, detect invisibility, ESP*).

## Weapons Pit

Here are mounted the ship's two medium catapults, protected by a retractable dome. The catapults fire aft, designed to discourage pursuit. In addition to the weapons themselves, there are stockpiles of appropriately-sized missiles.

## Concluding the Adventure

Despite the powerful opponents, a strong party should be able to defeat the neogi and allies and take over the ship. (Of course, plying space in a neogi Mindspider is a blatant invitation to any right-minded race to attack immediately.)

Once the neogi are all killed, the surviving human slaves are freed of their *charm*. All are simple sailors and want to continue with what they do best. Perhaps the PCs have some positions to fill aboard their ship . . . ?

Elowynn and the other elves want to get back about their explorations. They are grateful to the PCs, of course, and will assist them in any way possible; unfortunately, they have no money. The elves would like a lift to the nearest elven outpost, where they can go about raising the money needed to acquire another ship. That is, unless the PCs wish to join them in their epic adventuring . . . ?

Should the PCs escape or be defeated, Sisk Hal will continue his brain trade with the mind flayers.

## Void Elves

Setting: Wildspace

Party: 4-6 characters; levels 7-9

Ship: Any

## Setups

- The PCs hear vague rumors that an elven Armada of rather strange design has been sighted in a certain region of space. They are hired by a representative of the elven Imperial Navy to check it out. Since the system in the area is somewhat touchy about incursions by elven task forces, an unofficial survey is more politically expedient. (This request could come as a result of the PCs' involvement with the Imperial Navy in the adventure "Fire and Ice.") On their way to the region in question, the PCs' ship suddenly drops to tactical speed.

- The PCs are travelling in wildspace when, without warning, their ship drops to tactical speed.

"Unidentified vessels high on starboard bow!" the lookout cries.

You sigh. You certainly seem to be running into a lot of "unidentified vessels" lately. You scan the heavens in the indicated direction and find it: a Wasp ship painted night black (not a particularly auspicious sign), about 15° to starboard and 10° above your gravity plane. Its heading seems to be almost parallel to yours, perhaps a few degrees to port, and it's some 1,200 yards away. The Wasp is flanked by three smaller ships—elven Flitters and a Mosquito by the looks of them.

As you watch, the angular-looking Wasp maneuvers, coming about to an interception course with your vessel.

Once more you sigh. Here we go again . . .

Characters with telescopes or likewise enhanced vision will notice that the Wasp is modified. The forward station, normally open, is covered by a canopy, as is the weapons deck. The weapons deck canopy has been moved back to give the heavy ballista a free field of fire.

The Wasp is at a range of 3 hexes. It has an SR of 5.

The Wasp ship is manned by 10 drow, under the command of Larth Darkcloud and helmed by his sister, Selene. Also aboard are a neogi negotiator, Serta Ulm and his two umber hulk slaves, plus Serta Jerro, another neogi "loyal" to Ulm, and his umber hulk.

Serta Ulm is currently negotiating a treaty with Larth Darkcloud's superior, and this task force was assigned to bring him to a meeting with the drow forces. For more information, see "DM Notes" after this adventure.

When the Wasp encounters the PCs' vessel, Ulm's immediate reaction is "more slaves!" and he orders Larth Darkcloud to immediately attack them. Larth, of course, disagrees—he has his duty, and getting in a scrap with random adventurers isn't part of it—but it's hard for even a drow to argue with two neogi and three umber hulks. When outright veto of the neogi's orders doesn't work, Larth tries reason instead: he tries to persuade Ulm that sometimes business must take precedence over pleasure. Eventually his logical arguments convince the neogi, but not before the Wasp ship has



started its attack run at the PCs' vessel and fired one round from its heavy ballista.

The PCs don't know this, of course. All they know is that the Wasp—conspicuously without its escort's participation—turns to an intercept course and closes with an SR of 5. When it is in range, it fires one shot from its heavy ballista. Regardless of the PCs' actions in this round, the ship turns sharply and tries to make its escape. As soon as it turns away, the Flitters again take up station to escort it, while the stinger-configuration Mosquito fights a delaying action against the PCs' vessel, hoping to give the Wasp time to make its getaway.

## The Task Force

The Flitters are both SR 1, are equipped with minor helms, and have no armaments at all. Each is manned by a 3rd-level drow mage.

The Mosquito is SR 3, is equipped with a major helm, and is armed with a greek fire projector. Its captain/helmsman is a female drow cleric of 6th level, and has three 2nd level drow warriors operating the greek fire projector (max. of 3 shots). The Mosquito's open deck is covered with a translucent crystal dome.

Apart from the above details, all four vessels in the task force match the statistics given in the *Lorebook of the Void*.

**Flitter captains** (drow) (x2): AC 5; MV 12; W3; hp 8, 9; #AT 1; Dmg by weapon; spells: none (see below); AL CE; THAC0 19. They wear chain mail, and are armed with daggers (Dmg 1-4).

**Mosquito helmsman** (drow): AC 5; MV 15; C6; hp 22; #AT 1; Dmg by weapon; spells: none (see below); AL CE; THAC0 15. She wears chain mail, and is armed with a footman's mace (Dmg 2-7).

**Mosquito crew** (drow) (x3): AC 5; MV 12; F2; hp 11, 13, 14; #AT 1; Dmg by weapon; AL CE; THAC0 19. They wear chain mail, and are armed with long swords (Dmg 1-8).

All drow have the same innate magical abilities, usable once per day: *dancing lights*, *faerie fire*, and *darkness*. In addition, the Mosquito helmsman has the following abilities, usable once per day: *clairvoyance*, *detect lie*, *detect magic*, *dispel magic*, *know alignment*, *levitate* and *suggestion*. The Flitter captains and Mosquito helmsman can use no normal spells because they have used spell-

jammer helms in the last 12 hours. This does not affect their innate drow abilities, however.

**Note:** Drow armor loses its effectiveness when exposed to direct sunlight, therefore limiting any crewmen to normal armor while on deck or at the weapons. The drow armor and weapons are kept for use on board the Monarch armada (see "Monarch Armada" for more information). The drow armor is rarely used except by the security forces within the Monarch; most drow simply store their special armor in personal lockers.

The drow in the lesser ships will fight to the death to defend the Wasp ship. (The only way the Flitters can influence the outcome is to draw fire, or to ram the PCs' vessel.) There is nothing of value aboard these lesser vessels.

## The Wasp

Once it's made its abortive attack, the Wasp will do its best to make its escape. If escape is obviously impossible, it will turn and fight. (Consider the crew of the Wasp to have a morale of 18 when determining the chances of surrender, etc.)

**Larth Darkcloud** (drow): AC 3; MV 12; F7/W5; hp 60; #AT 3/2; Dmg by weapon (long sword (1-8), drow crossbow (1-3)) or spell; Str 13, Dex 13, Con 11, Int 15, Wis 12, Cha 10; spells: *chill touch* (x2), *magic missile* (x2); *web*, *stinking cloud*; *vampiric touch*; AL CE; THAC0 13. Larth wears *chain mail* +2 and he is armed with a long sword and a drow hand crossbow (5 bolts with sleep poison).

**Selene Darkcloud** (drow): AC 3; MV 15; C10; hp 37; #AT 1; Dmg by weapon (mace (2-7)); Str 13, Dex 11, Con 12, Int 10, Wis 14, Cha 10; spells: none; AL CE; THAC0 14. Selene wears *chain mail* +2 and is armed with a horseman's mace. Since she has used a helm in the last 12 hours, she can cast no normal spells. This does not affect her innate drow abilities, however.

Both Larth and Selene have the following innate abilities, usable once per day: *dancing lights*, *faerie fire*, *darkness*, *clairvoyance*, *detect lie*, *detect magic*, *dispel magic*, *know alignment*, *levitate* and *suggestion*.

**Drow crew** (x10): AC 5; MV 12; F2; hp 3, 5, 5, 5, 8, 11, 11, 15, 15, 16; #AT 1; Dmg by weapon; AL CE; THAC0 19. The crew wear chain armor, and all wield long swords (Dmg 1-8). Five are also equipped with drow hand crossbows. All crew-

members have the same innate magical abilities, usable once per day: *dancing lights*, *faerie fire*, and *darkness*. Four of the drow are busy manning the heavy ballista.

**Neogi** (Serta Ulm, Serta Jerro): AC 3; MV 6; HD 5; hp 32 (Ulm), 25 (Jerro); #AT 3; Dmg 1-3/1-3/1-6; SA slowing poison; AL LE; THAC0 15. Once battle is joined, neither neogi wish to be personally involved. Instead, they shelter in the Wasp's cargo bay (area 4), depending on the drow and their umber hulks to defend them.

**Umbur hulk** (x3): AC 2; MV 6; HD 8+8; hp 43, 47, 50; #AT 3; Dmg 3-12/3-12/1-10; SA confusion; AL CE; THAC0 11. The umber hulks are loyal to their neogi masters, and will fight to the death to protect them.

## Aboard Ship

If the Wasp ship is forced into combat, six of the drow crew will fight on-deck, led by Larth Darkcloud; the remainder man the ballista. Selene will remain at the helm, trying to maneuver the ship out of range, until someone enters the bridge. Then she will use her innate abilities to try and escape, or fight. If things look bad, the neogi will send two of their umber hulks up on deck to help out, but will always keep one (the largest) as their personal bodyguard.

Refer to the plans of the modified Wasp on the four-color map sheet. All areas in the following descriptions correspond to the numbered areas on the plans.

## Foredeck

### 1. Bridge.

If there remains a chance that the Wasp can make an escape, Selene Darkcloud will remain seated at the ship's major helm; otherwise, she will have taken up a defensive position somewhere in this area (preferably where she can ambush anyone who's coming in). Depending on the tactical situation, she might be hiding in the forward station on the main deck.

In addition to the helm, the bridge contains a mappable covered with charts in drow language and symbology. A character with a proficiency in modern languages or navigation can make a proficiency roll at a penalty of -2 to decipher them. These charts show the loca-

tion of both Serta Ulm's fleet and Teela Darkcloud's Monarch Armada.

Underneath the mactable is a locked chest. This contains Larth Darkcloud's spellbook and Selene's holy symbol (a spider cast from adamantite; 1,000 gp value). There are also two hammocks folded up next to the chest; Larth and Selene sleep in respective corners of the bridge.

## Main Deck

### 1. Forward Station.

In most Wasp ships, this area is open to space; on this vessel, it is covered with a smoke-colored crystal dome. There is nothing of value or interest present (unless Selene Darkcloud is hiding here).

### 2. Crew Quarters.

There are sleeping stations (pallets or hammocks) for the ten crewmen. Since this is a short journey, none of the crewmembers has brought any valuables or personal effects on board.

### 3. Galley.

A smell catches in your nostrils and makes your eyes water and your throat constrict. It takes you a moment to realize that this is just the aroma of drow cooking . . .

Apart from a rather unspeakable casserole bubbling on the stove, there's nothing here of interest.

### 4. Cargo Bay.

As the most central area of the ship, this is where Serta Ulm and Jerro have chosen to hide. Depending on the tactical situation, they might have one or all three of their umber hulks with them as personal guards.

If combat is joined in this area, the morale for both neogi is 12. Should they surrender, they are likely to trade details on Teela Darkcloud's plans and her location, for their lives. (Of course, being neogi, they'll probably lie, and will certainly look for opportunities to slay or enslave the PCs.)

### 5. Additional Cargo Bay.

Unless some drow from the weapons deck have made a fighting withdrawal to this area, the room is empty.

## Concluding the Adventure

Should the Wasp ship escape, it will immediately head for the drow Armada. Any surviving PCs may decide to pursue it. If the PCs can decipher the drow's charts, or if they've managed to somehow extract the truth from the neogi or from captured drow, they'll know the location of Teela Darkcloud's Armada. (Unless the PCs are quick in finding it, Teela will realize that something has happened to her task force, especially if one of the Flitters somehow escaped and returned to tell her, and she will quickly move on.) They'll also know that the drow are cutting some kind of deal with the neogi, although they might not know the exact details.

This kind of information would be of great interest to the Council of Admirals of the elven Imperial Navy, and they'd possibly reward anyone (quite handsomely, too!) who brought it to their attention—as long as some proof was provided.

Of course, wouldn't it be much more heroic for the PCs to try to do something about Teela Darkcloud themselves . . . ?

## DM NOTES:

### Drow in Space

Contrary to conventional wisdom, the drow do have a presence in space—not extensive (yet), but enough to cause concern. They have at least two Armadas which they have heavily modified, and numerous other vessels. Many are of elven design: ships whose crews were slain or were abandoned during the Unhuman Wars, later found and refitted by the drow. But the drow fleet also includes vessels of other configurations, mainly acquired through ongoing space piracy.

The phrase "drow fleet" is actually a misnomer, carrying the connotation of a centrally organized endeavor. Instead, the drow presence in space consists of a number of "nations"—groups of varying sizes, based around a single matriarchal clan. Each space-going nation typically has its own goals and agenda. Sometimes these align, but more often they are totally independent from (even actively inimical to) the efforts of other drow nations. Most nations have fairly limited goals: to set up an isolated outpost in a small crystal sphere, for example, commanded by the drow but with all

the manual labor performed by slave races; or to remain forever in space, plundering the shipping lanes for their requirements while living comfortably aboard a stolen or drow-designed Armada.

Space-faring drow have a philosophy quite different from that of their groundling brethren. Rather than seeing themselves as a hunted race that must survive and prosper through stealth, and then only against overwhelming odds, space drow—or "void elves" as they call themselves—believe that they have a destiny toward which they are inexorably moving. Each nation has a different view of this destiny.

## The Nation of Eternal Twilight

One drow nation has somewhat more extensive and aggressive plans than the others. This group, the "Nation of Eternal Twilight," has ambitions that extend beyond the boundaries of a single crystal shell. What they see as their destiny is to be the core of a monolithic Matriarchal Fleet—similar to the Imperial Navy of the non-drow elven nations—with the same universe-spanning effectiveness and power.

The Nation of Eternal Twilight is small—a total of only 100 drow—but what they lack in numbers they more than make up for in focus and aggression. The matriarch is a venerable drow named Teela Darkcloud, a high priestess of Lolth, queen of spiders. Teela is well aware that her clan is nowhere near powerful enough to achieve her goal. Since she believes fully in her destiny to be the Ultimate Matriarch of a unified drow fleet, she knows that she needs powerful friends. Her knowledge of the races of space is wide and deep, so it was no great difficulty for her to pick out the best ally: the neogi.

Teela knows fully that an alliance with the neogi is fraught with risk. There are many more neogi than there are of her people, and the "small lords" would gladly break any promise to enslave the drow. Nevertheless, she feels that she can offer the neogi enough of value in the form of magic and drow-weapons and armor so that, in the short term, at least, the small lords will hold to their side of any bargain. In the long term, she knows that the neogi will turn against her, but by that time she believes her na-



tion will be strong enough to stand on their own and fight off the encroachment of the neogi. (In this, she might be right. The neogi's attitude of "own or be owned" makes it difficult for the creatures to work together in a coordinated manner. She and the rest of her nation, however, are expert at working in concert, particularly when backed by the power of an entire planet—or shell—of slave species.)

To further her goal, Teela has carried out preliminary discussions with a certain powerful neogi named Serta Ulm, overmaster of the Serta fleet (one Mindspider and three Deathspiders). The next step in negotiations is a face-to-face meeting between Serta Ulm and Teela Darkcloud. For political reasons relating to "home turf," Teela has insisted that the meeting be on her Armada. Ulm (somewhat surprisingly, perhaps) has agreed to this. Teela has sent a Wasp, escorted by two helm-equipped Flitters and a stinger-configuration Mosquito, to pick up the neogi and bring him back to the Armada for the meeting. It is this small task force that the PCs have been unlucky (or lucky, depending on your outlook) enough to encounter.

## Monarch Armada

Setting: Wildspace  
Party: 4-8 characters, levels 7-9  
Ship: Any

## Setups

(Note: This is designed to follow the previous adventure "Void Elves"; however, it can be used as a stand-alone adventure.)

- The PCs hear rumors that drow-manned vessels have been preying on shipping in a certain region of space.
- The PCs hear vague rumors that an Armada of unusual design has been sighted in a certain region of space. Perhaps they are hired by a representative of the elven Imperial Navy to check it out. (Since the system in the area is somewhat touchy about incursions by elven task forces, an unofficial survey is more politically expedient.)

If the PCs have just completed "Void Elves," they'll know the location of Teela Darkcloud's Armada, and so will (hopefully) be able to sneak up on it. (If they're

smart, they might do it in the captured Wasp ship.)

In the distance you can see something frighteningly large occulting the distant stars. It looks like a hideously enlarged butterfly, its wingspan maybe 600 feet, two times the length of the butterfly's "body." And there are smaller ships moving near it—elven Flitters, you assume—absolutely dwarfed by their monstrous mother ship.

This gigantic vessel is the drow's Armada. Teela Darkcloud has acquired and modified a very rare form of Armada indeed: the Monarch-class Armada. Only half a dozen were built by the elves just before the Unhuman Wars, and then the design was abandoned. The configuration of the Armada is quite different from that of the more common class of vessel described on page 45 of the *Lorebook of the Void*. The citadel is carved from the length of the ship's body, and the upper surfaces of the wings are the landing flats for smaller vessels. In addition, parts of the citadel are enclosed within domes of smoke-colored crystal that filters out those frequencies of light that are harmful to drow.

The dimensions of the Monarch are similar to those of the Elven Armadas. The body of the Armada is 300 feet long, with a beam of 50 feet. The "wings" are considerably larger than this—as in the common Armada—but they add very little to the tonnage of the vessel. The Monarch Armada has the following statistics:

### Monarch-class Armada

**Built by:** Elves (obsolete design)  
**Used Primarily By:** Elves, Drow  
**Tonnage:** 100 tons  
**Hull Points:** 100  
**Crew:** 40/100  
**Maneuverability Class:** D  
**Landing—Land:** No  
**Landing—Water:** No  
**Armor Rating:** 4  
**Saves As:** Ceramic  
**Power Type:** Major helm  
**Ship's Rating:** As for helmsman

**Standard Armament:**  
2 heavy catapults  
Crew: 5 each

4 heavy ballistas  
Crew: 4 each  
2 heavy jettisons  
Crew: 4 each  
2 bombards  
Crew: 3 each  
**Cargo:** 50 tons  
**Keel Length:** 300'  
**Beam Length:** 50'

## Boarding the Armada

This is the home of the drow Nation of Eternal Twilight from "Void Elves." Unlike normal elven Armadas, this Monarch has only sixteen smaller vessels associated with it: a Wasp, four stinger-configuration Mosquitos, a Damsel fly, and ten Flitters (four of them equipped with spelljamming helms). Of this number, the PCs have already encountered two Flitters, one Mosquito and the Wasp. These might or might not be present aboard the Monarch, depending on the outcome of the previous adventure. The previous adventure will also determine whether the two neogi, their slaves, and Larth and Selene Darkcloud are aboard the vessel.

If the PCs are approaching in the captured Wasp, two Flitters (no helms) will leave the landing flats and escort the vessel in for a landing (standard procedure). Should the PCs be using another vessel and be detected in their approach, however, the Monarch will mobilize all its spaceborne defences—the remaining Mosquitos and Flitters, plus the Damsel fly—to engage the vessel and destroy it before it can pose a threat to the Monarch.

The PCs can gain access to the Monarch through the workshop doors or either of the gunnery platforms.

The Monarch's SR depends on who is operating the helm. Usually this is Tessa Darkcloud, Teela's eldest daughter. Under her control, the Monarch has SR of 5.

All directions on or within the Monarch are given in terms of for'ard, aft, port (left when facing for'ard) and starboard.

## Levels of Readiness

Encounters within the Monarch will depend on whether the PCs have gained entry through stealth or by speeding in, bombards blazing. If the former, then conditions within the Monarch are "normal"; if the latter, then the drow are



“alerted.” All areas and encounter tables for this adventure reflect these two levels of readiness.

The drow will become alerted if the PCs draw attention to themselves. If any drow spot the PCs and escape to spread the word, the Monarch will become alerted in 2-8 rounds. Also, for each consecutive round of combat, there is a cumulative 5% chance that the drow will become alerted, regardless of whether drow escape or not. Thus, in the first round, the chance is 5%, 10% in the second consecutive round, 15% in the third, etc. After one particular melee is over, assuming that no drow have escaped to spread the word, then the chance drops back to 5% for the first round of the next melee.

Note that the drow are highly intelligent. If a group of them encounters the PCs, then some will fight a holding action while others are dispatched to raise the alarm.

The entire crew, except the command crew, will have the following designations and statistics:

“Typical” drow (39): AC 4; MV 12; F2; hp 2-20; #AT 1; Dmg by weapon; AL CE; THAC0 19. All wear drow armor and carry daggers (Dmg 1-4).

Drow warriors (24): AC 4; MV 12; F3; hp 3-30; #AT 1; Dmg by weapon; AL CE; THAC0 18. All wear drow armor and carry long swords (Dmg 1-8) and daggers (Dmg 1-4).

Drow officers (8): AC 3; MV 12; F5; hp 5-50; #AT 1; Dmg by weapon (long sword (1-8), or halberd (1-10)); AL CE; THAC0 16. They have *long swords* +1 at their belts.

All drow aboard the Monarch have the same innate magical abilities, usable once per day: *dancing lights*, *faerie fire* and *darkness*. Those of fifth level or greater have the following innate abilities, usable once per day: *dancing lights*, *faerie fire*, *darkness*, *clairvoyance*, *detect lie*, *detect magic*, *dispel magic*, *know alignment*, *levitate* and *suggestion*.

Note: If the drow in question are on any part of the ship exposed to starlight, they will wear ordinary chain mail, AC 5.

## Monarch Body

The body of the Monarch is grown from the organic crystal comprising most elven craft, and much of it is actually air space. Unlike the standard-

configuration Armada, only a few areas within the body of the Monarch are usable, the rest being a labyrinthine honeycomb of crystal. Some areas have been hollowed out—those used for the two bridges, the jettison bay and the workshop areas—but the majority must be left intact to maintain the ship’s structural integrity. The crystal—and hence the entire Monarch—ranges from light mauve to deep purple, displaying complex streaks and whorls of color.

The areas inside the body are dimly lit, with light provided by luminescent organisms that form inclusions in the crystal walls (holes were excavated for the “lights,” then the crystal was allowed to grow back around and over the glowing organisms). The level of illumination is about equal to starlight.

## Main Bridge.

Normal: The captain and helmsmen—Delak and Tessa Darkcloud, respectively—are present with their standard bridge crew of four drow (typical drow; hp 3, 6, 6, 6).

Alerted: Delak, Tessa and the bridge crew are guarded by a detachment of five warriors (hp 8, 9, 12, 15, 16).

The bridge has one companionway leading to a door in the forward wall, giving access to the weapons. There are also spiral stairs leading into the antennae (watch towers). The “eye” windows on the bridge are made of the same smoked-crystal material as the dome on the back of the Monarch. This crystal filters out the wavelengths of light painful to drow. The room is dominated by the major helm, a large and ornate throne grown from bright green crystal. Alongside are the maptable and chart racks. A small cabinet contains assorted navigation instruments.

Delak Darkcloud (drow): AC 1; MV 12; C13; hp 48; #AT 1; Dmg by weapon (hammer (2-5)) or spell; Str 13, Dex 9, Con 10, Int 13, Wis 16, Cha 11; spells: *protection from good*, *darkness*, *detect good*, *detect magic*, *command*, *cause light wounds*; *enthrall*, *hold person*, *spiritual hammer*, *flame blade*, *heat metal*, *aid*; *protection from fire*, *animate dead*, *feign death*, *prayer*, *cause blindness*, *cause disease*; *tongues*, *cause serious wounds*, *protection from lightning*, *spell immunity*; *raise dead*, *plane shift*; *blade barrier* (x2); AL CE; THAC0 12. She wears *banded armor* +2 and has a hammer hilted at her waist. Note that if the Monarch is alerted, Delak

will probably have had time to cast some of her more relevant spells on herself.

**Tessa Darkcloud** (drow): AC 2; MV 15; C10; hp 45; #AT 1; Dmg by weapon; Str 12, Dex 13, Con 12, Int 11, Wis 14, Cha 11; spells: none; AL CE; THACO 14. She wears *splint mail* +2, but is unarmed.

#### Antennae Watch Towers.

The towers reach 40' above the bridge and the hangar. The top chamber is ringed with crystal windows, each covered by a movable shutter.

Normal: One typical drow (hp 8) is on watch duty in each tower. He is armed with a hand crossbow and a long sword.

Alerted: One drow warrior (hp 13) is on watch duty in each tower. He is armed with a hand crossbow and a long sword.

#### Gunnery Platforms.

There are two platforms, one by each bridge.

Normal: The forward platform has a skeleton crew of 9 typical drow (hp 5, 6, 7, 8, 8, 9, 9, 10, 11).

Alerted: Each platform is fully manned by 18 typical drow (hp 5, 5, 6, 6, 7, 7, 8, 8, 8, 8, 9, 9, 10, 11, 12, 13, 14).

Each platform is equipped with two heavy ballistas and one heavy catapult. Each weapon is mounted on a rotating turret. Unlike the bombard positions, there are no domes over these platforms (too complicated when multiple weapons might be engaging multiple targets). In bright light, the effectiveness of the weapon crews goes down; the rate of fire decreases by one (to 1/4 rounds for the catapults and 1/5 rounds for the ballistas), and the weapon's THACO increases by 1 (to 19 for the catapult and 13 for the ballistas).

#### Hangar/Workshop Area.

Normal or alerted: Deserted.

This huge empty area was designed to give workmen a chance to repair *Flitters* in an enclosed area. Currently, no vessels are in for work. The roof is supported by gnarled "trunks" of crystal distributed every 40 feet. Set into the roof are two large hatches through which small vessels can be brought into and out of the workshop. Stashed in the stern end of the area are two large cabinets that contain the tools of the elven shipwright (hammers, clamps, trimming knives, fine binding wire, small weights, etc.)

#### Auxiliary Bridge.

Normal: The area is usually deserted (25% chance of one typical drow present; hp 7).

Alerted: The bridge is guarded by a detachment of five drow warriors (hp 15, 17, 20, 22, 23).

Unlike the forward bridge, this area has no window to the outside. The room is dominated by the back-up major helm, a large and ornate throne grown from bright green crystal. Alongside are a maptable and chart racks, containing a duplicate set of charts. A small cabinet contains assorted navigation instruments. Note that only one helm can be in use at a time in the same vessel.

#### Jettison Bay.

Normal: Only one jettison crew (four typical drow; hp 6, 8, 8, 12) is on duty. Alerted: Both jettison crews (eight typical drow; hp 6, 7, 8, 8, 9, 12, 13, 18) are on duty, accompanied by three drow warriors (hp 14, 15, 18).

Mounted in this huge area are two heavy jettisons. The rear area of the bay is closed by large articulated doors that are so well counter-weighted that they can be operated by one drow. The jettisons are capable of firing at aft targets; they are intended to "discourage" ships with the temerity to pursue the *Monarch*.

#### Bombard Turrets.

Normal: Deserted.

Alerted: In 2-12 rounds after the alarm is raised, three typical drow are present in each of the two turrets to crew the bombards.

Each rotating turret is covered by a crystal dome, with an opening in it to allow the bombard to fire out (think of an observatory dome). Along with the bombard, each turret stockpiles 10 bombard projectiles and enough smoke powder for 10 rounds. The turrets are so arranged that the bombards cannot fire at the *Monarch* itself (either by accident or through malign intent).

The bombards are located on the underside of the *Monarch* on purpose. This way, if they happen to misfire or if the powder is detonated by enemy action, the damage to the "battle surface" of the *Monarch* will be minimized.

## Monarch Citadel

The long, narrow configuration of the *Monarch's* body puts severe constraints on the design of the citadel. The citadel's structure has a length of some 125 feet, but at no point is it wider than 35 feet.

The interior, of the structure is lit by the same luminous inclusions as the *Monarch* body. In no area is the illumination brighter than starlight. Unless otherwise stated, all ceilings are 10 feet high. Of course, there are no windows (consider the race involved).

### 1. Exit to Flight Deck.

These double doors lead out onto the wings of the *Monarch*, allowing access to the *Flitters* as well as being a general entrance for any guests brought in on other ships.

Normal: One ceremonial guard—a drow warrior carrying a halberd in addition to his normal arms—stands in front of each door (hp 15, 21).

Alerted: Four drow warriors—two armed with halberds, two with hand crossbows—guard each door (hp 12, 13, 13, 14, 15, 19, 23, 25).

### 2. Aft Exit to Gunnery Platform.

This door allows access to the rear weapons platform.

### 3. Guardroom.

The room is furnished with hard wooden chairs and a table. A dartboard—painted like a non-drow elf's head—is mounted on a wall. (Dart holes are clustered around the eyes and the throat.) A rack on another wall holds two drow hand crossbows and 24 bolts.

Normal: Four drow warriors (hp 9, 11, 15, 21) are lounging around, playing cards (+1 to chance for surprise).

Alerted: The room is empty (the guards are on patrol).

### 4 and 5. Storage Room.

A repository for all kinds of trash and knickknacks: brooms, ropes, old buckets, floor soap, bundled up cloths, a mop or two, etc.

### 6 and 7. Pilots' Quarters.

Even though the pilots of the *Flitters* and other vessels are the elite among warriors, their quarters are nothing if not spartan. Each room sleeps six in curtained-off alcoves. An alcove contains a hard sleeping pallet and perhaps a



small foot locker. In some alcoves, the walls are decorated with drow art—to human eyes, only slightly less repellent than garbage hung on the wall. A complete search of each room will turn up the following loot: 3-30 pp, 1-4 gems (100 gp base), 1-2 sets of drow armor, and 1-4 spell books belonging to the pilot/mages (see below).

There are two types of drow who operate the smaller vessels: male pilot/mages and female pilot/priestesses. Typical statistics are as follows:

**Pilot/mage:** AC 4; MV 12; W4; hp 4-16; #AT 1; Dmg by weapon (dagger (1-4)) or spell; AL CE; THAC0 19. Pilot/mages carry only daggers. Their spellbooks are locked in foot lockers.

**Pilot/priestess:** AC 4; MV 15; C4; hp 4-24; #AT 1; Dmg by weapon (club (1-6)) or spell; AL CE; THAC0 18. Pilot/priestesses have small clubs hanging on their belts.

The DM should determine what spells each NPC knows. This will determine the spells found in captured spellbooks.

**Normal:** In each room, there are 0-2 (1d3-1) each of pilot/mages and pilot/priestesses present, napping or sitting around chatting.

**Alerted:** In each room, there are 0-1 (1d2-1) each of pilot/mages and pilot/priestesses. None will be napping. The others are on duty elsewhere.

## 8. Pantry/Larder.

The food storage room for the Monarch. A permanent *cone of cold* keeps one corner of the room cold. Here are hung sides of meat (the nature of the beasts they were taken from is best left unimagined). Baskets of vegetables and strange fruits, plus sacks of grain take up the rest of the room. (Most of this food was stolen from ships with the bad fortune to encounter the drow Monarch.)

## 9. Kitchen.

The smells issuing from this room are too horrible for most humans or demihumans to contemplate (lizard men or neogi would probably feel sudden pangs of hunger, however). Along the port wall corner is a large wood-fired iron stove. In the oven a large haunch of something is baking, while a huge cauldron best left unexamined bubbles away on top. Racks on the wall contain cooking tools, including a selection of eight rather nasty knives and cleavers (treat as knives or daggers).

**Normal:** 1d3 typical drow (hp 5, 8, 11) are present, whipping up the food. They are unarmed, but if a scrap starts, they can quickly snatch knives from the rack.

**Alerted:** Only one typical drow (hp 11) is present, making sure the food doesn't burn. He already has a large knife (treat as a dagger) stuck down his belt just in case trouble starts.

## 10. "Wine Cellar."

This is where the Monarch keeps its potables. The door is usually kept locked (+10% chance to pick). The room contains tuns of beer, casks of brandy and barrels and ewers of wine. There are also four small earthenware jugs containing a patently nasty and incredibly potent drow spirit distilled from fermented fungus. (Any non-drow taking more than a sip is immediately moderately intoxicated: +2 to morale, -3 to Intelligence, -4 to Wisdom, -2 to Dexterity, -1 to Charisma, -1 to hit, but +1 to hit points. The effect lasts 20-40 rounds.) Each jug of spirit is worth 300 gp to anyone stupid enough to want to drink the stuff (lizard men and some dwarves come to mind).

The majority of the room is taken up with huge barrels of drinking water.

## 11. Warriors' Bunkroom.

The room sleeps 20 drow warriors, but not very comfortably. Two-level wooden bunks line all walls, and sleeping pallets cover most of the floor. Many bunks have foot lockers beside them. A complete search of the room will turn up the following loot: 1-12 sets of drow armor, 20-60 pp and 2-8 gems (100 gp base), in addition to the usual paraphernalia soldiers keep in their foot lockers (playing cards, useless mementos, good luck charms, etc.).

**Normal:** 2-12 drow warriors are present (hp 9, 12, 15, 15, 18, 18, 19, 19, 20, 20, 20, 22); 75% are asleep.

**Alerted:** The room is empty.

## 12. Armory.

Weapon racks are everywhere, mounted on the walls and free-standing on the floor. The total contents of the room are 10 halberds; 5 drow hand crossbows + 60 bolts; 10 javelins; 5 long swords; 8 short swords; and 20 daggers.

## 13. Guards' Messroom.

Long wooden tables and hard benches dominate the room.

**Normal:** 2-4 off-duty drow warriors—fully armored but packing only daggers—are sitting around chatting (hp 5, 9, 17, 17).

**Alerted:** The room is empty.

## 14. Storage Room.

Contains more bricabrac: tools, broken wooden furniture, discarded artwork, etc.

## 15. Library.

The walls are lined with shelves groaning with books. All are in the drow language, and none contain much of interest to non-drow. Most are interminable histories of the drow race, genealogies of the Nation of the Eternal Twilight, texts on drow philosophy, etc.

**Normal:** There is one typical drow present (hp 7), doing some research.

**Alerted:** The room is empty.

## 16. Workers' Quarters.

This room sleeps 20 typical drow. As in room 11, there are several foot lockers around. A complete search of the room will turn up the following loot: 1-8 suits of drow armor, 10-30 pp and 1-6 gems (100 gp base).

**Normal:** 2-8 typical drow (hp 4, 6, 6, 8, 9, 9, 11, 12) are present; 75% are asleep.

**Alerted:** 1-3 typical drow (hp 6, 8, 9) are present. They're off duty, but not asleep.

## 17. Officers' Quarters.

This room, slightly more luxurious, is home to two drow officers. The sleeping pallets are more comfortable, and there are tapestries—depicting drow involved in a favorite sport (hunting humans through caverns)—on the walls. A complete search of the room will turn up 20 pp and a 500 gp diamond.

**Normal:** 1-2 drow officers are present. They are armed with *long swords* +1. There is a 50% chance that each is asleep.

**Alerted:** The room is empty.

## 18. Priestesses' Quarters.

Even more luxurious than room 17, this room is home to two drow priestesses. The tapestries on the wall depict sacrifices to the goddess Lolth. A complete search of the room will turn up the following loot: 25 pp and a diamond-encrusted spider symbol (1,200 gp value).

**Normal:** 1-2 drow priestesses are present (AC 4; MV 15; C4; hp 18, 19; #AT

1; Dmg by weapon (hammer (2-5)) or spell; spells: *bless*, *command*, *cause fear*; *hold person*, *spiritual hammer*; AL CE; THACO 18). They are armed with hammers. There is a 25% chance that each is asleep.

Alerted: One priestess is present (hp 18). She is deep in prayer (+1 to chance of surprise).

### 19. Chapel.

At the aft end of the room is an altar formed from a single block of obsidian. Mounted on the wall above the altar is a silver representation of Lolth. This symbol is 4' across, weighs 75 pounds, and is worth 250 gp.

Normal: A service is in progress. A drow priestess (AC 4; MV 15; C4; hp 16; #AT 1; Dmg by weapon or spell; spells: *bless* (x2), *cause fear*; *hold person*, *spiritual hammer*; AL CE; THACO 18) is conducting the service, while three typical drow (hp 5, 5, 12) and two drow warriors (hp 12, 13) kneel in prayer. The drow priestess wears a voluminous black robe, with a hood pulled forward to cover her head and shadow her face. This is the typical vestment used by priestesses of the Nation when conducting services (priestesses usually don't wear these robes anywhere else but in this chapel or the family chapel upstairs, but if the Monarch is alerted, other drow will—probably—be too busy to question anyone wearing such a robe). She is unarmed.

Alerted: A drow warrior (hp 10) kneels before the altar, praying for strength and courage in the current troubles.

### 20. Robing Room.

Wardrobes along the wall contain eight full-length black robes with hoods. The door to the corridor is locked; all priestesses have keys.

### 21. High Priestess's Room.

One of Teela Darkcloud's lesser daughters, Landa Darkcloud, makes her home here. As befits her temperament, it is spartan, with nothing of value to enliven the dark, black-draped room. (Landa is truly devout, and keeps nothing of value.)

Normal: There is a 25% chance that Landa Darkcloud is present, deep in meditation (+2 on surprise).

Landa Darkcloud: AC 3; MV 15; C7; hp 19; #AT 1; Dmg by weapon or spell; Str 12, Dex 11, Con 9, Int 12, Wis 16, Cha 10;

spells: *bless* (x2), *detect magic*; *augury*, *enthrall* (x2); *pyrotechnics*, *cause disease*; *cause serious wounds*; AL CE; THACO 16. Landa is unarmed. Around her neck she wears an adamantine spider symbol (1,000 gp value).

Alerted: There is a 75% chance that Landa is present, casting *augury* (using her holy symbol as the material component) to determine what her role should be in the present troubles.

### 22. Reliquary.

This room contains a number of holy items of great significance to the drow Nation. They are displayed in great honor in crystal-fronted cabinets. These cabinets are locked (-15% chance to pick), but they can be smashed in by bludgeoning weapons (each of the four cabinets can withstand 6 hit points of damage). The four cabinets contain:

1. A gold-plated skull (one of Teela's ancestors; 350 gp value) and a platinum ceremonial dagger (500 gp; useless as a weapon, since the blade is so soft).

2. An adamantine circlet with a ruby set in the browpiece (1,000 gp value) and a matching choker (850 gp value).

3. A copy of the "Book of the Spider" (a sacred writing in the worship of Lolth). Its binding is made from the scales of a celestial dragon. The binding is worth 2,000 gp; the book itself is of value only to certain sages (and even then, not worth too much).

4. The cloven skull of a drow hero of centuries gone by. The skull emits an aura of necromancy. The skull is worthless (although the PCs probably won't realize that . . .).

Normal: There is one typical drow (hp 12) present, engaged in meditation.

Alerted: The room is empty.

### 23. Trophy Room.

Mounted on the walls are the heads of many beasts slain by the drow in hunting expeditions, including a small celestial dragon and more than a couple of dwarves and elves. Other trophies on the wall include a cloven ogre-sized shield, a riven helmet, and two cracked two-handed swords. In the middle of the room stands an enormous suit of plate mail, fully 9' tall and more slender (proportionately) than a human. The design is totally unfamiliar: it is built to accommodate a creature with three legs and three arms, showing trilateral symmetry. From the shape of the suit, it's obvious

that this couldn't fit any of the well-known three-limbed races like xorns or tiraphegs; the conformation of the creature must be unlike any currently recognized in the known worlds. No one aboard the Monarch knows the history of this trophy (in fact, a drow expedition of long ago found it in an abandoned asteroid base). The room is deserted.

### 24. Official Meeting Room.

This is set up like a large boardroom, with a 30' long obsidian-topped table down the center of the room, with 20 chairs positioned around it. This is where Teela Darkcloud and her immediate family conduct official business with other parties that they must treat as equals (this is where the meeting with the neogi is scheduled to take place). Other audiences, where Teela is dealing from an obvious position of power, take place in the throne room.

Normal: If the neogi escaped from the PCs aboard the Wasp ship (see "Void Elves"), there is a meeting in progress here when the PCs arrive. This is also the case if this adventure is being played stand-alone. Serta Ulm and Serta Jerro are present, with their umber hulk slaves, as are Larth and Selene Darkcloud. (If any of these worthies were killed in the previous adventure, then obviously they are unable to attend the meeting.) Their statistics are repeated here for convenience:

Larth Darkcloud (drow): AC 3; MV 12; F7/W5; hp 60; #AT 3/2; Dmg by weapon (long sword (1-8), drow crossbow (1-3)) or spell; spells: *chill touch*(x2), *magic missile* (x2); *web*, *stinking cloud*; *vampiric touch*; AL CE; THACO 13.

Larth now wears drow armor that is effectively +2 (although non-magical). He is armed with a long sword and a drow hand crossbow.

Selene Darkcloud (drow): AC 3; MV 15; C10; hp 37; #AT 1; Dmg by weapon (footman's mace (2-7)); spells: none (see below); AL CE; THACO 14. Selene now wears drow armor that is effectively +2 (although non-magical). She is armed with a footman's mace. Since she has used a helm in the last 12 hours, she can cast no normal spells. This does not affect her innate drow abilities, however.

Neogi (Serta Ulm, Serta Jerro): AC 3; MV 6; HD 5; hp 32 (Ulm), 25 (Jerro); #AT 3; Dmg 1-3/1-3/1-6; SA slowing poison; AL LE; THACO 15.

**Umbur hulk (x3):** AC 2; MV 6; HD 8 + 8; hp 43, 47, 50; #AT 3; Dmg 3-12/3-12/1-10; SA confusion; AL CE; THAC0 11. The umbur hulks are loyal to their neogi masters, and will fight to the death to protect them.

In addition, Teela Darkcloud is present.

**Teela Darkcloud** (drow matriarch): AC 1; MV 15; C15; hp 72; #AT 1; Dmg by weapon or spell; Str 13, Dex 11, Con 12, Int 13, Wis 16, Cha 13; spells: *bless*, *curse (x2)*, *cause light wounds (x2)*, *darkness (x2)*, *sanctuary*; *charm person (x2)*, *enthrall (x2)*, *heat metal*, *hold person (x2)*, *spiritual hammer*; *animate dead*, *continual darkness*, *cause blindness*, *cause deafness*, *cause disease*, *protection from fire*; *abjure*, *cause serious wounds (x3)*, *protection from good 10' radius (x2)*; *cause critical wounds (x2)*, *slay living (x2)*; reversed version of *raise dead*; *blade barrier*, *word of recall* (to her private chapel); *destruction* (reversed *resurrection*); AL CE; THAC0 12.

Teela is armed with a *mace +2*. Around her neck she wears a mithril spider symbol encrusted with diamonds (2,500 gp value). Although vicious and aggressive, Teela is not stupid. If a fight looks as though it's going against her, she immediately seeks escape, probably using her *word of recall*. She will not surrender to "inferior races," preferring to die nobly in battle. If there is no alternative to death, she will have no qualms about taking anyone or anything down with her to destruction.

As discussed in "Void Elves," the neogi will do whatever it takes to save their lives . . . even (maybe) tell the truth about their purposes here.

A drow officer carrying a halberd stands guard inside each door.

Alerted: Teela, Larth and Selene are in Teela's throne room (assuming the latter two survived the previous adventure). If the neogi and umbur hulks survived to reach the Monarch, they have been left here, with four drow officers (hp 25, 27, 28, 30) as additional bodyguards, until the present crisis is over.

### 25. Teela's Office.

Running a drow Nation is more than glory and power; unfortunately, it also involves management and paperwork. This is where Teela performs the more mundane duties of her position. There are bookshelves along the walls, contain-

ing several centuries' worth of family records. Against the starboard wall is a large desk, inundated with papers. Everything here is very prosaic, nothing to interest intrepid adventurers.

### 26. Private Study.

The door is locked; only Teela has a key. Bookshelves line the walls, most of them the drow equivalent of trashy romances and potboilers. The only other furniture is a comfortable armchair. This is where Teela comes to relax and get away from everything.

### 27. Teela's Quarters.

Opulent is hardly a strong enough word for this room. Priceless carpets and tapestries are everywhere (unfortunately for greedy adventurers, all are too large to move without much effort). The huge canopied bed is draped in cloth-of-gold. The furniture itself is all antique and valuable, pillaged from ships and outposts of a dozen different worlds. Teela's dressing table is littered with jewelry: a platinum tiara (900 gp), three rings (500 gp each), a pair of emerald earrings (300 gp each), an electrum brooch (250 gp), and a necklace of priceless, glowing "fire diamonds" from a distant shell (15,000 gp). The drawers of the dresser contain the drow equivalent of lingerie (spider-silk undergarments and the like) plus a few other drow fancies (a dagger or two, etc.).

Normal: There is one very young drow priestess (AC 4; MV 15; C1; hp 3; #AT 1; Dmg by weapon or spell; spells: *cause light wounds*; AL CE; THAC0 20) present. She is Teela's maid, and is cleaning. Although young and weak, she's cunning and nasty: she'll fake terror of any intruders, hoping they'll feel sorry for such a young slip of a thing . . . and then do her best to kill them at the first opportunity. She is currently unarmed.

Alerted: The room is empty.

### 28. Family Chapel.

Against the aft wall is an altar of obsidian. Inlaid into the wall above it is a representation of Lolth. Black hangings drape the walls. On the altar is an adamantite symbol of Lolth (value 1,000 gp). This has been cursed so that, when any non-drow touches it, it gains the powers of a *jewel of attacks*. The room is empty.

### 29. Selene's Room.

This room, with its single large bed, is used by Selene. A wardrobe against the aft wall contains both male and female drow formal garb (both are black robes, albeit differently tailored). The wardrobe also contains a long sword and a drow hand crossbow (no bolts, though). There is a dressing table, but there's nothing on top of it. The drawers contain similar items to the one in Teela's room, plus a choker studded with garnets (350 gp value).

### 30. Boras Darkcloud's Room.

Boras is (or was) Teela's husband. Some century or two ago, they had a slight marital tiff, and Teela killed him. Although there could be no repercussions from this, Teela being the ultimate ruler and sole law-giver of the Nation, it was a slight breach of etiquette. She disposed of the body and told the rest of the family that Boras had "gone off alone hunting space beasts" (how he managed this when all of the Nation's vessels were still on the landing flats was somewhat of a mystery). Even two hundred years later, the family still maintains the fiction that Boras will be back someday, and his room is kept ready for that eventuality (Larth uses the room until his return).

Although less opulently furnished than Teela's room, this is obviously the room of a powerful lord. A wardrobe beside the bed contains the robes of state he wore as Teela's consort (black robes, of course). Another cabinet contains his hunting gear (another hint that something is amiss): two javelins, a long sword, three daggers, a hand crossbow with 12 bolts, and a heavy crossbow with 12 bolts. A spear stands in the corner. The main attention-getter in the room, however, is a huge stuffed yeth hound, against the aft wall. (This was Boras's favorite hunting companion. When it died, in a moment of sentimentality Boras had it stuffed so he could keep his old friend with him.)

### 31. Guest Room.

Although the drow Monarch has guests very rarely, one room has been set aside for them. This room is furnished comfortably if not flashily, with two beds, a couple of tables, and a handful of chairs. (This furniture is, of course, totally useless to the drow's current guests.)



**32. Guest Study.**

This quiet room has two armchairs for private conversation or reading. The walls are lined with the drow's idea of light reading. (Some of it is even in tongues other than drow.) There is nothing of value here.

**33. Throne Room.**

The walls are hung with drapes of silk in black and the hue of dried blood. At the forward end of the room, upon a raised dais, is Teela Darkcloud's throne, carved from a single chunk of obsidian. Next to it on the dais is a space where a smaller chair obviously once sat. (Perhaps it will be replaced when Boras finally returns from his hunting trip.)

The throne room has a smoky crystal dome above the rest of the Armada's structure. From here, Teela oversees "her future territories . . ."

Normal: The room is empty (Teela and the others are downstairs, meeting with the neogi.)

Alerted: Teela, Larth and Selene (assuming they survived) are present, discussing strategy. Teela is on her throne, the others are standing before her. Teela's throne is flanked by four drow officers. They have *long swords* +1 sheathed at their hips.

**34. Teela's Robing Room.**

Wardrobes against the walls hold Teela's robes of office—black velvet garments worn only on occasions of the highest solemnity—and a simple black priestess's robe. A locked chest, trapped with a poison needle (save vs. poison at -4 or die; the poison inflicts 2-24 pts. of damage even if the save is made), contains the *Coronet of the Nation*: an elaborate adamantine crown worth 5,000 gp. It emits an aura of alteration magic. When worn by a female drow—and only a female drow—it limns the wearer with a faint glowing aura, similar to a very subdued version of *faerie fire*; this aura is so faint that it cannot be seen in conditions brighter than moonlight.

Anyone who comes in contact with the wearer suffers the effect of a *shocking grasp* spell cast at the 12th level of ability. This effect is continuous while the wearer is alive and keeps the crown on her head; there is no limit to the number of shocks the item can inflict.

Teela will try to retrieve the crown and put it on should trouble start.

**35. Private Chapel.**

As high priestess of the Nation, this chapel is reserved for Teela's sole use. Against the starboard wall is a small altar. Resting upon it is a symbol of a spider shaped from some form of ceramic. It emits an aura of evocation magic. If the item is shattered—as it will be if thrown against a hard surface—it blossoms into a mini-fireball, 5' in radius. Although small, the fireball is incredibly hot, inflicting 10d6 points of damage to anyone within the blast radius and having a 50% chance of igniting anything inflammable within 40' of its center point.

This is the sanctuary to which Teela's *word of recall* takes her.

**36. "Bolt-hole."**

With secret doors on each end, this is an ideal place for Teela to hide until the heat is off. There is enough food and water for 3 days.

**Encounter Tables**

The number and nature of encounters will depend on whether or not the Monarch has been alerted. Each turn that the PCs spend aboard the Monarch, roll 1d10 and consult the following tables:

Normal	
1	—
2	—
3	—
4	1 typical drow
5	1-3 typical drow
6	1-3 drow warriors + 1-3 typical drow
7	1 drow mage*
8	1 drow priestess**
9	1 drow priestess** + 1-3 typical drow
10	1 drow mage* + 1 drow priestess** + 1-3 typical drow
Alerted	
1	—
2	—
3	1 drow warrior
4	1-3 drow warriors
5	1 drow officer + 1-3 drow warriors
6	1 drow officer + 1-6 drow warriors
7	1 drow mage*
8	1 drow priestess**
9	1 drow priestess** + 1-4 drow warriors
10	1 drow mage* + 1 drow priestess** + 1-4 drow warriors

\*Mage (3): AC 4; MV 12; W3 (hp 3-12); #AT 1; Dmg by weapon (dagger: 1-4) or spell; spells: *burning hands*, *magic missile*, *scare*; AL CE; THACO 20. Armed with a dagger.

\*\*Priestess (6): AC 4; MV 15; P4 (hp 4-24); #AT 1; Dmg by weapon (footman's mace: 2-7) or spell; spells: *curse*, *cause light wounds*, *darkness*; *heat metal*, *silence 15' radius*; AL CE; THACO 18. Armed with a footman's mace.

**Concluding the Adventure**

Possibly the smartest thing that the PCs could do would be to infiltrate the Monarch, find out what's going on, and then make a quick getaway. As discussed in "Void Elves," information about the drow-neogi dealings would be of great interest to the Council of Admirals of the elven Imperial Navy, and they'd probably handsomely reward anyone who brought it to their attention . . . as long as some proof was provided.

Conceivably, a party of fired-up PCs might be able to totally defeat the drow and take over the Monarch. This might not be such a good idea. If any drow escapes death—by stealing a Flitter, perhaps (and this is really quite likely)—then other drow Nations will definitely hear about what happened. Even if there's no real allegiance between Nations, there is certainly some racial pride. The other space drow won't let "inferior races" tromp some of their kind without some kind of vengeance. (Also, from a pragmatic point of view, there's a perfectly good Monarch out there, probably underdefended by a motley crew of adventurers and ripe for the taking.)

As for the neogi, they won't know the details, but they will know that Serta Ulm and Serta Jerro haven't come back. The loss means nothing on the personal level, but it does seem to imply that drow aren't above tricking and killing neogi ambassadors. The word will certainly go out that "the drow in the Monarch" are enemies. And everyone knows how the neogi treat enemies!

The elves are very hard-nosed about making sure no non-elves get their mitts on a Monarch. Any "unauthorized" Armada—particularly of the Monarch configuration—will be attacked on sight by any elven vessel that encounters it.

Other races have probably heard enough "space dust" tales about Monarchs to recognize one if they see it. Any-

one spotting the Monarch will immediately assume that it's manned by drow . . . a race hated and feared by most non-Evil societies.

The bottom line is, if the PCs decide to sail around in the Monarch, practically everyone's hand will be turned against them. (It's not quite as bad as trying to use a Deathspider for a pleasure craft . . . but almost.) After the fifth unprovoked attack, the PCs might realize that the best move is to ditch or scuttle the Monarch.

Should the PCs not break up the meeting between the drow and the neogi, then an alliance—rather a shaky one, but an alliance nonetheless—will result between the two races. Drow officers may rarely be seen aboard neogi ships, and the drow Monarch will frequently be accompanied by at least one Deathspider when it's on a raid. Both races know that the alliance is for the short term only—one will betray the other, probably sooner than later—but for the next several months or years, the drows' growing area of influence will not be a healthy place to be . . . (Future adventures can be developed around attempts to break up this unholy alliance before the drow grow too strong.)

## Time Capsule

Setting: The Flow

Party: 4-6 characters, levels 6-8

Ship: Any

## Setup

• The PCs are travelling through the Flow between two crystal shells. For some reason, they are travelling at tactical speed (perhaps they are too close to a crystal shell to travel at full speed).

### Thud!

Not a loud sound, but enough to catch your attention. Particularly out here in the Flow, where there should be nothing to "thud" against.

"We've struck something," one of your crew sings out.

"No kidding," you want to answer, but hold your tongue. You join the observant crewmember by the rail and look down.

Yes, you certainly did strike something. Something interesting. Resting against your hull, right on the gravity

plane, it looks like a statue, a six foot high statue with six limbs. Definitely insectoid, but something about it makes it seem disconcertingly manlike.

Several other crewmembers have gathered around to look at the curiosity as well. "What should we do with it?" one of them asks, somewhat plaintively.

Good question . . .

The object is directly on the ship's gravity plane and drifting slowly away from the hull. It is surprisingly light for its size and appearance, weighing only about 180 pounds (rather than the 500 pounds or more that a stone statue would weigh), and therefore easy enough to hoist on board.

## Thri-Kreen

Any PC who has seen a thri-kreen before will immediately recognize that this is a mantis warrior. PCs who have a proficiency in animal lore can make a proficiency check to see if they recognize it.

The thri-kreen may look like a statue, and its grey surface seems to be as hard as stone, but appearances can be deceiving. This is actually a living thri-kreen marooned in the phlogiston, and kept in a state of suspended animation by that strange medium.

About 4,000 years ago, a mantis warrior fell overboard while its ship was in combat with another vessel in the Flow. By the time the combat was ended, the thri-kreen vessel was unable to find its lost crewmember. For the next 40 centuries, the thri-kreen drifted, inert. Until now.

Exposed to the air aboard the PCs' vessel, the "statue" begins to change. Within five minutes its color begins to shade from dull grey toward a brilliant light green. Its surface, while still hard, becomes less stone-like and more like that of a fingernail. This transition takes one hour. At the end of that period, the thri-kreen twitches suddenly, looks around and stands up.

With quick, darting motions of its head, the "statue" looks around you, the strange colors of the Flow reflecting in its multi-faceted eyes. The creature makes a high-pitched whirring, rasping sound, then is silent for a mo-

ment, as if waiting for a reply. When it realizes one is not forthcoming, it speaks haltingly in the Common tongue, its voice harsh and gritty, with a strange accent.

"For my life, I thank you."

**Tiktitik** (thri-kreen): AC 5; MV 18; HD 6+3; hp 24; #AT 5 or 3; Dmg 1-4(x4)/2-5 or by weapon; SA paralysis; SD dodge missiles on roll of 9 or better; AL CN; THACO 15. Tiktitik has lost his polearm, but still has six of his "throwing wedges" (Dmg 3-8) sheathed in his harness.

## The Mantis's Tale

The thri-kreen—who is named Tiktitik—is a male warrior, and a member of a space-going band that called itself the People of the Celestial Mantis. This group were devout members of what was, 40 centuries ago, the dominant sect in the race's religion. (This religion remains multi-faceted and largely incomprehensible—except to thri-kreen, however, who seem able to understand its intricacies and apparent contradictions with no trouble, and conduct interminable philosophical discussions about them.)

The tenets of this group's belief included an injunction to "spread the word" among the spheres, and to convert every living being to the worship of the Mantis God of the Eternal Lotus. Understandably, this put the thri-kreen into conflict with various other races who were quite happy with their own religions, thank you. This refusal to accept the inevitable didn't sit well with the thri-kreen, who brought the full forces of their spacefaring fleet to bear against these "infidels." They did this without any animosity, and would have been surprised to learn that their victims took matters somewhat more personally.

At the time, the thri-kreen's rather pre-teen religion viewed time as a fixed and immutable thing. The past is unchangeable, and the future is fixed. In fact, the words "past" and "future" are misleading, since time is rather like an intricate tapestry of infinite extent. Nothing changes in time, as nothing changes on a tapestry. The fact that time seems to flow and things seem to change is simply because creatures are able to view only one portion of the tapestry at a time.

This rather specious argument may seem nonsensical, but it was of great im-

portance to the thri-kreen. They saw their destiny as fixed—to spread “the truth” throughout the universe—and hence could feel no animosity, and offer no mercy, to those obstacles that stood in their way.

The ship that Tiktitik was aboard was given the task of “converting” a human outpost. On the way there, however, the ship was ambushed by a human vessel. It was during this battle that Tiktitik went overboard.

The mantis warrior is intelligent, and has immediately concluded two things. The first is that he has been in stasis in the Flow, and thus much time might have passed since his misfortune. The second—based on the fact that the ship isn’t commanded by his people, and that the banner of the Mantis God of the Eternal Lotus doesn’t fly from the mast-top—is that something has gone somewhat wrong with his race’s “manifest destiny” idea. While both realizations are profoundly disturbing to him, he is strong-willed enough to take them in stride.

With the philosophical underpinnings of his life suddenly removed, Tiktitik has one wish: to be reunited with his people. Whether they are in space or on a planet, he wishes to be surrounded by others of his kind so he can try to come to terms with everything that has happened. He will beg the PCs for their help. (Unfortunately, his Common was never that good, and the language has changed considerably since he was last conscious. This provides the DM with a good chance to role-play, with lots of possibilities for misunderstandings on both sides.)

If the PCs have played the adventure “The Outpost,” they might ask Tiktitik for information on the Elders. Unfortunately, he knows little. He’s heard of them, certainly—trilaterally symmetrical beings that his race called “The Lost Gods”—but he’d always assumed that they were simply tales for the young, intended to frighten thri-kreen fresh out of the pupa. He can tell the PCs nothing concrete.

### Hatred from the Past

Tiktitik isn’t the only “relic” from that ancient battle that still drifts in the Flow. Many humans aboard the ambushing ship were slain, and five of them have remained in the phlogiston as ephemerals. These undead have one central goal: to

possess the bodies of living creatures so that they can escape the Flow and return to a crystal shell. Along the way, however, they would relish a chance at revenge against the race that slew them and their fellows. The surviving thri-kreen soon left the phlogiston, so they could do nothing to them. But here, drifting in the Flow with them, was one of the hated mantis warriors. Perhaps they could eventually get their revenge . . .

Within 2-12 turns of Tiktitik’s return to consciousness, the five ephemerals attack the ship. They will concentrate on the PCs and crew; none will try to attack the thri-kreen.

**Ephemeral** (x5): AC 2; MV 18; HD 5; hp 16, 18, 19, 22, 26; #AT 1; Dmg 1-4; SA drain Intelligence; SD hit by +1 or better magical weapons, regeneration; AL NE; THACO 15.

If any of the ephemerals manage to possess their victims, they will use their new-found bodies to attack the thri-kreen. They will attack this target in preference to all others, even if it means that their possessed body gets cut down. If they are able to slay the thri-kreen, they will then turn their attentions toward getting back into a crystal shell.

If the PCs are able to drive off the ephemerals, the monsters will follow the ship at a distance until they’ve regenerated fully, then attack again. The PCs can be rid of them only by destroying them totally or by leaving the Flow.

### Concluding the Adventure

Assuming he survives, Tiktitik is a loose end that the PCs must tie up one way or another. If the thri-kreen has his way, the PCs will ship him off somewhere where he can be with others of his kind. He’ll understand, however, if the PCs refuse; in this case he’ll ask to be dropped off at the nearest port where spelljamming vessels often dock, in hopes of finding his people.

Enterprising PCs might try to persuade the thri-kreen to throw in his lot with them. This will be a tough sell, as Tiktitik will need a lot of reasons to give up his quest for other thri-kreen. Bribery and promises of treasure and adventure won’t do it; the PCs must sway him with philosophical arguments appropriate to his nature and outlook.

If Tiktitik rejoins his race, he will become a leader of a new religious movement, encouraging the thri-kreen to

move into space. Tiktitik returns in the adventure “Jihad.”

### The Outpost

Setting: The Flow, wildspace  
Party: 4-6 characters, levels 6-8  
Ship: Any

### Setup

- The PCs have put in to an outpost, spaceport or groundling port (perhaps even the Rock) for repairs and/or resupply. It is the day of their intended departure, and they’re having one last farewell drink in a port tavern.

“Ere.”

You look up from your drink to see a burly man leaning over you.

“Ere,” he says again, “there’s er, somebody over there what wants to talk wif you.”

You look at him quizzically.

He answers your unspoken question. “You’ll recognize’m, no mistake. Just look for the place what people don’t want to go near.” And with that masterpiece of mangled grammar, he moves away.

If the PCs decide to investigate, read the following:

The burly fellow was right. You have no trouble spotting the “place what people don’t want to go near.” In the otherwise-crowded tavern, there’s an area totally empty of patrons except for one. The patron is sitting alone at a table, with what looks like a kobold squatting placidly under the table. The patron raises its head as you approach. White eyes without pupils catch the light, and glistening purple skin ripples as four facial tentacles move in a complex pattern.



"I greet you." The words sound cool and sharp in your brain. The mind flayer gestures with a three-fingered hand at nearby chairs. "Will you join me? I have a proposition that should interest you."

The PCs have the choice to withdraw. If they decide to hear the mind flayer out, read the following:

Words again form in your brain. "Translated into symbols your mind can recognize, my name is 'Thought Taker.' You feel a touch of something that could be humor—albeit cold and detached. "It is not as bad as it sounds. I am a philosopher, a student of the universe. I learn from others, borrow from their wisdom and learning. Thus 'Thought Taker.' You see?"

"As I mentioned," the mind flayer continues silently, "I have a proposition for you. There is a . . ."—it hesitates—"a place I wish to go. My research indicates that there is something there that I wish to possess. I wish for you to take me to this place. I will take the item I want. As payment, you may have anything else you find at the place. I would estimate that this share will be highly valuable. On all this I give my oath."

Again that touch of cold humor. "I understand, however, that your races do not hold the oath as highly as does mine. You wish something tangible to bind us to the contract. Will this suffice?"

The mind flayer reaches inside its voluminous robe and extracts a fiery red opal almost the size of its fist, which it lays on the table before you. The opal is worth 2500 gp. (For the first time, the buzz of puzzled conversation from the curious onlookers falls silent.)

The mind flayer stands, as does its kobold companion (pet?), eager and trusting as a puppy. (Charmed, you imagine.) "If our compact is sealed," the mind flayer's "voice" rings in your head, "I wish to leave immediately. Where is your ship?"

No matter how often the PCs ask, Thought Taker won't tell them where this "place" is that it wishes to go, other than that it is in a different crystal shell. The creature will show them the charts when

they are in space and not before. "I fear others will come to know through you," he explains. If the PCs promise or swear not to divulge the information, Thought Taker says sharply, "I do not ask your oath, and so do not accept it, not on this."

## Thought Taker

Perhaps surprisingly, considering the reputation that mind flayers have on most worlds, everything that Thought Taker has told the PCs is true. Measured by their own, admittedly alien yardsticks, mind flayers are by and large highly ethical and moral creatures. Problems arise only where their ideas of ethics and morals diverge from those of other races . . .

Thought Taker's research indicates the location of an asteroid base used by an ancient race that no longer seems to exist in this universe. Whether this race died out, was destroyed, or moved on to other planes of existence is unknown, as is almost everything else about it. Thought Taker has spent years going through the epic poetry of wide-voyaging species such as the thri-kreen for details of this race, which the illithid has come to label as "the Elders." It was in a particularly abstract thri-kreen lyric poem that the creature found what seems to be enough information to find what could only be a deserted Ancient outpost.

The "item" that Thought Taker wishes to acquire is any single object that will prove, beyond a shadow of a doubt, that the place is an Elder outpost. (The fact that this was not made clear to the PCs can be put down to mismatches of mental symbology between the mind flayer's and PCs' thought processes.)

**Thought Taker** (mind flayer): AC 5; MV 12; HD 8 + 4; hp 40; #AT 4; Dmg special; SA mind blast; SD 90% magic resistance; AL LE; THAC0 11. The mind flayer can use the following powers, one per round, as a 7th-level mage: *suggestion*, *charm monster/person*, *ESP*, *levitate*, *astral projection*, and *plane shift*. Thought Taker has chosen to class the PCs as equals, at least for the duration of the voyage; thus the notorious mind flayer arrogance will be under tight check when around them. (The same can't be said for the PCs' crew, however.)

**Kobold**: AC 7; MV 6; HD 1/2; hp 2; #AT 1; Dmg 1-4 or by weapon; AL LE; THAC0 20. The kobold—whose name is Ja-Te-

Jak—is unarmed and unarmored. As the PCs might suspect, he has been charmed, and considers Thought Taker to be his mentor and protector. The mind flayer certainly intends to take the kobold on board ship with him. If the PCs ask why, the illithid explains, "It is my food. When I hunger, I will eat its brain." (Should the PCs take exception to this, the illithid looks at them sharply and shoots back, "Better that I should eat yours?")

## The Voyage

Once everyone is on board and the PCs' ship is underway, Thought Taker brings out charts showing their destination. (These use illithid symbology, which is totally alien and can only be deciphered while the mind flayer is looking at the charts and relaying the information directly to the PCs' brains.) The voyage involves a trip through the Flow; reaching the destination shell will take 25 days. During this time, the DM should feel free to throw at the PCs any encounters that may seem appropriate (perhaps a wandering radiant dragon, a distant sighting of the *Spelljammer*, or one of the other adventures in this book).

## Potential Troubles

About eight days out, one of the PCs spots Thought Taker tossing a rather bulky sack overboard. The sack contains the brainless husk of the kobold. Thought Taker feels no remorse or embarrassment; the only reason he is disposing of the remains with even the slightest semblance of secrecy is to spare the feelings of the PCs and the crew, who apparently have different attitudes toward the care and tending of food.

For the next 10 days, Thought Taker's appetite is sated. After that, however, the illithid's movements become a little quicker and jerkier, and it keeps throwing long looks at members of the crew. If asked, the creature will admit its hunger, but gives an oath that it will touch no member of the crew.

This hardly sets worries to rest among the crew, of course: they strongly doubt that anything with tentacles instead of a face would think twice about breaking its oath. This doubt and tension has an effect on the crew's morale, at least as far as Thought Taker is concerned. The

crew's morale drops by three points, and, every day starting on the eighteenth day out of port, the crew must make a morale check. Failure of this check means that one or more crewmembers decide to "do something about" the mind flayer.

Exactly what they decide to do depends on how badly they fail the morale check. A marginal failure means that a delegation of crew goes to the captain, asking that the mind flayer be banished from the ship immediately. A bad failure means that at least one crewmember decides to take matters into his own hands. (Out-and-out mutiny is the worst result, of course. A DM with a nasty streak might decide that the crew is dissatisfied enough to do something desperate.)

### Assassination

On a badly failed morale check, one of the crewmembers decides to kill the mind flayer, solving the problem once and for all. If the crew is well-developed, the DM should pick the NPC who would most reasonably be expected to make such a decision. If the crew is composed of typical "walk-ons," the DM can use the character below:

**Tinker:** AC 8(?); MV 12; F3/T1; hp 16; #AT 1; Dmg by weapon; Str 14, Dex 14, Con 13, Int 11, Wis 8, Cha 9; thief skills: PP 15%, OL 10%, F/RT 5%, MS 40%, HS 35%, DN 15%, CW 60%, RL 0%; AL CN; THACO 18. Tinker is a large, robust human who moves with a silence and grace that belies his size. He wears leather armor (or whatever other type is prevalent among the crew); he carries a dagger plus whatever other weapon is typical among the crew.

Thought Taker's sleeping habits are somewhat unusual. The illithid needs to sleep only two or three hours in each twenty-four, and takes it in a handful of cat-naps, none lasting over an hour. The creature makes an effort to match its activity cycle to that of the ship, however; during shipboard "night," it remains in its cabin or bunk, in silent thought. When it does sleep, it first levitates itself to hang in the air a foot or so off the deck or bunk. In this comfortable position, it naps. It always wakes within an hour, at least ten minutes before its *levitate* spell runs out.

The disaffected crewmember waits until shipboard night, then does his or her level best to sneak up on the mind flayer and kill it as it sleeps. Unless the PCs

stand watch over the mind flayer's cabin, they won't know what's going on until they see the aftermath.

This aftermath is disturbing. A very troubled Thought Taker approaches the PCs and asks to speak to them privately, in the hold. There the illithid shows them the body of the crewmember. Read the following:

The liquid syllables of mental "speech" form in your head. "He came to me last night," the illithid explains, "with this." He holds out to you a notched dagger. "He wished to slay me because I represented a threat to him and his colleagues. He did not say this in so many words, but he did not have to. I give you my oath that I did not wish to kill him. But he would not give his surrender. My only other option was that I die myself, and my time is not yet. I hid his body here to give you time to decide how to handle this matter."

The ultimate results will depend on the PCs' actions. The crew, of course, will notice that Tinker is missing, and rumors will already have started. If the PCs try to tell the crew the truth, they will not be believed; the crew will think that the "inhuman monster" killed the crewman for food. If the PCs try to hide the body, however, there's a good chance that a crewmember will find it, precipitating the same result. The third option is to dispose of the body in some way. Again, unless the PCs are very cunning about it, there is a good chance that the crew will come to learn of their actions. In this case, the crew will think that the PCs are somehow in league with Thought Taker, and the chance of mutiny will increase.

In any case, there will be no further unilateral actions against Thought Taker, but the crew's overall morale suffers a -3 penalty (-5 if the crew believes the PCs to be in league with the illithid). (Note: The previous drop in morale only affected the special daily morale checks caused by the illithid's presence. This new penalty is factored into all morale checks until Thought Taker is permanently off the ship. Even then, morale will return to normal slowly, increasing by one point per day until it reaches its original level. If a 20 is rolled for a morale check at any time that the illithid is on board, the crew mutinies.)



## Thought Taker's Story

Now that they are underway, the illithid is quite willing to talk about its goals and to share what little it knows about the Elders . . . but only if the PCs ask specifically. It is too polite (by its own standards) to force an unwanted story on them. Should the PCs ask, read the following:

Your brain tingles as the illithid's words insinuate themselves into your mind.

"I know little about the Elders, as I call them," the illithid explains. "Little apart from the fact that they are indescribably ancient. Perhaps the thri-kreen knew them, millennia ago, when the People of the Celestial Mantles had a significant presence in space."

The mind flayer must feel your surprise, because it fixes its white, featureless eyes on you. "Yes," it answers your unspoken question, "the thri-kreen preceded your race—and mine—into the greater universe, perhaps by millions of years. They talk little of it now, even those who still dwell in the void. But they remember the glory. They remember it very well."

You feel the mental equivalent of a sigh. "But as for the Elders . . . a mighty race, they were worshipped as gods by many worlds, many peoples now extinct. I have seen representations of them carved on many ruins and painted on the walls of many caves. Their form is unmistakable, even when transformed through the eyes of misguided faith. And their symbol, the three-petalled flower, or the three-pointed star, finds its way into the symbology of many races.

"While your races and mine were barely taking our first steps away from our cosmic cradles, the Elders were already disappearing from this universe. Whether it was by choice or by misfortune, I know not. I do know, from ancient thri-kreen poetry I have translated, that they left behind at least one outpost. Deserted, without a doubt. But there I should be able to find what I need: proof of my theories, proof that the Elders did exist. I should find it there." A red-tinged finger stabs at a point on the chart. Your destination.

## The Dead Shell

Thought Taker's ultimate destination is within a crystal shell that none of the PCs have visited before. (In fact, none of them know of its existence.)

The system within the shell is a standard system, but with a few differences. The system's primary is a black hole several miles across, but with the mass of a sun several times bigger than Realmspace's sun. Because the primary gives no light or heat, the sphere is dark and cold. The only illumination comes from a few stars, tiny lights sparsely scattered across the inside surface of the shell, and from a ring of gas surrounding the central black hole that glows with a sullen, reddish light.

Orbiting around the black hole are two planets and something else. Both are Size G Earth-type worlds, circled by rings of ice. They are voidworlds, devoid of air, water and life. They are so old that, over the millions of millennia, mountains have collapsed under their own weight. Their surfaces are flat and featureless, and killingly cold. One planet is on inner orbital track #5, the other on outer orbital track #2. Both planets revolve clockwise around the primary. Use the Planetary Display map found in the SPELLJAMMER™ boxed set to determine the system's layout.

The third body is an irregular nickel-iron asteroid on outer orbital track #12, revolving counterclockwise (retrograde motion) around the primary. It is so small and so far distant from the primary that it would be almost impossible to find without the information on Thought Taker's charts. This tiny third body is the illithid's destination.

## The Outpost

The nickel-iron body that Thought Taker insists on referring to as "the Outpost" is roughly ovoid, about 250' along its major axis and 200' along its minor axis. Thus, it is of the same scale as dwarven citadels. It has no atmosphere.

Chambers have been excavated within the asteroid—an impressive achievement considering the density and hardness of the material—which can be accessed by one opening to the outside (Thought Taker calls it "The Portal"). The chambers are roughly spherical, with cylindrical tubes connecting them.

Perhaps because of the nature of this sphere, or the nature of its masters, the Outpost has no gravity whatsoever within it. Outside it has a perfectly normal gravity plane, as would a ship. As soon as characters pass inside, however, they are totally weightless. This is obviously not a recent development, since arrangements within the Outpost show no up-down orientation. The place was obviously built with zero-G in mind.

Movement inside the Outpost abides by the familiar laws of physics. A moving object will remain in motion until another force is applied, or until it hits an obstacle. A drifting character can move (slowly) by throwing equipment in the opposite direction (maximum speed 3). Non-natives of space have a +6 penalty on their initiative rolls and a -2 penalty on all attack rolls. (Proficiency in Weightless Combat negates these penalties, of course.)

The Outpost is totally dark inside. Illumination must be brought in by the PCs.

## Air

Air—or rather, lack of it—might hinder exploration of the Outpost unless PCs can solve the problem. Characters can depend on their personal air envelopes, but this seriously limits the time they can spend within the Outpost. The clerical spell *create air* would obviously be of use.

Enterprising characters with a large ship might try to maneuver their vessel so that the Portal into the Outpost is within the ship's atmosphere envelope. When this occurs, some of the ship's air will flow into the Outpost. Unless the adventurers' ship is almost the size of a Deathspider, however, this is a suicidal move, since the hollowed-out regions within the Outpost have a volume of 100 tons. According to the rules for exchanging air on pages 12-13 of the *Concordance of Arcane Space*, unless the adventurers' ship is at least 66 tons, the Outpost will drain away all of the ship's air without making any difference to the interior, leaving both the ship and the Outpost in vacuum. (To use these rules, assume that the Outpost has Deadly Air.)

If the PCs aren't ingenious enough to figure out a solution by themselves, Thought Taker can provide a solution. He has a one-shot magical device, in the form of a fragile crystal, which will provide up to 10,000 cubic yards (100 tons)



of air for a period of 2-8 hours. After this time, the air dissipates. To use the item, someone must smash the crystal inside the area to be provided with atmosphere (by throwing it hard through the Portal, for example).

(Note: The figure of 100 tons refers only to the hollowed-out volume of the Outpost. The total volume of the complete asteroid is more than four times that.)

### The Surface and the Portal

The surface of the Outpost is rough and rugged, with many outcroppings and chasms, and lots of small craters that imply this system was not always as peaceful as it now appears. At first glance the Portal resembles an over-large crater: roughly round, and about 20' across. Only from directly above is it apparent that this is more than a simple crater: it is a tunnel bored into the heart of the asteroid.

If characters try to enter the Portal, they will feel a slight resistance against inward movement. This increases to a maximum 5 feet inside the threshold. Even at its maximum, the resistance is barely noticeable, and doesn't impede movement at all. Once within the Outpost, the same resistance is felt against outward movement. (The occupants of the Outpost set up a force field across the Portal, perhaps to make sure that their atmosphere didn't escape. Over the millennia the force field has weakened to its current meager level.) The tunnel narrows until it is 10 feet in diameter.

### The Chambers

The chambers in the Outpost are arranged three-dimensionally so that the four outer chambers form the vertexes of a regular tetrahedron; the central chamber is connected to each outer chamber by a single tunnel. Chamber 1 is the only one connected to the outside (via the Portal). As mentioned before, the chambers are roughly spherical. There is no up-down orientation among their features; they were obviously designed for zero gravity.

#### 1. Entry Chamber.

As you drift slowly down the tunnel you can feel something that you've never felt before: age, pressing in on

you. This outpost has been around longer than you'd even care to think about. Although you have no real basis for the belief, you're convinced that this thing has been deserted for longer than many crystal shells have been in existence.

A patch of deeper darkness up ahead tells you you're coming to the end of the tunnel. You drift forward, and the walls open up around you into a roughly spherical space some 30' in diameter.

The walls of the chamber are coated with dust deposited over the millennia. But, through the patina, you can see strange murals on the walls of totally alien landscapes. There's something about the colors and the perspective that looks slightly "off," as though the paintings were intended to be viewed through very different optical equipment. The detail is intricate, however, and the workmanship incredible. These are not your average cave paintings . . .

Thought Taker points to a symbol on one of the murals: a three-pointed star. His words ring in your head: "The Elders."

There are several strange artifacts scattered around the room, mounted on the walls. Some of these have interesting properties and are of significant value. The PCs should find this out only through experimentation, however.

One such artifact is a thin sheet of dull metal, three feet high by two feet wide, mounted in a metal frame.

You can see that the sheet is vibrating rapidly. Through your atmosphere envelope and the tiny amount of air in the chamber, you can hear a high-pitched tone. As the light shifts—perhaps someone's shadow fell across the metal plate—the tone changes in pitch and drops in volume.

The metal plate converts light into vibrational energy, and hence, sound. There is no mechanism or magic that accomplishes this conversion: it's simply a property of the metal sheet. This sheet might be sold to a sage for 1,000 gp, or the PCs might put it to use themselves (as a light-activated burglar alarm, perhaps).

There is a square plaque mounted on one wall that can only be a piece of art. About 2 feet square, it displays an intricate geometric pattern made from thin strips of metal mounted on edge. You reach out in wonder to touch it, but some instinct stops you. You look closer: the strips of metal have edges as keen as any razor. They'd have shredded your hand if you'd touched them.

The "knife art" can be sold to a collector for up to 1,000 gp. In a pinch, it can also be used as a weapon, inflicting 2-8 points of damage. Its speed factor is 10; no one can be proficient in its use, so non-proficiency penalties apply.

#### 2. Central Chamber.

Your light glints off something metallic ahead of you. It's a large three-pointed star, perhaps six feet across, hanging unsupported in the center of the chamber.

Thought Taker pushes past you in his rush toward the star. "The Elders." His words in your head are triumphant. As the mind flayer moves forward, you see something you hadn't noticed before. There's a tiny object hanging in space just beyond each tip of the three-pointed star. The tiny object is another three-pointed star, a perfect duplicate of the larger symbol but no larger than your palm.

"Look." It's Thought Taker's mental "voice." The illithid is pointing to one of these smaller "sub-stars." "Look closely."

Hanging in space just beyond each of the three points is a tiny, glinting speck of metal. A sense of wonder grows within you. If your eyesight were acute enough, would you be able to pick out the trilateral symmetry of that tiny metal speck? And—if you could see things that infinitesimally small—would you be able to see the minuscule stars that frame that tiny object? And the stars around each one of those . . . ?

If *detect magic* is cast on the star, it radiates a strong aura of enchantment, with nuances of dweomers that are very reminiscent of a major helm. (In fact, this construction is a helm, but based on a principle different to that used by the Ar-

cane. No existing race can control the helm, however; only the Elders have the correct mental architecture. The most any creature can do is activate the helm enough to make the Outpost surge, and to trigger other effects . . .

"The helm." Thought Taker's mental voice is filled with awe. "I wonder . . ." The creature reaches out and delicately touches the central star. It closes its white eyes, and for a split instant you can feel its concentration.

Light! Light, blossoming all around you. The rock walls glow with a cold, harsh light. The Outpost surges around you with a sudden jolt.

Thought Taker has triggered the helm. The jolt is enough to disorient and to cause minor damage. All characters within the Outpost must make a Dexterity check on 1d20 or be bounced against the walls for 1-4 points of damage. Characters who fail this roll are also stunned for 1-3 rounds. The mind flayer is unaffected, since it is in contact with the helm.

The jolting stops, but the light continues. With a hissing squeal, Thought Taker snatches its hand away from the star and covers its eyes.

The illumination comes from no distinct source—the entire wall surface of all five chambers glows—and is equal to full daylight.

Sound! A sharp roaring, and a sudden increase in air pressure. Something hurtles out of one of the tunnels . . .

The Outpost has become home to a creature known as a space drake, a close relative of the radiant dragon, that entered this shell with one of its larger brethren but was left behind. The creature is wingless, with a body like a moray eel. It is 50' long and about 5' in diameter at its thickest point, but it is so supple that it can maneuver effectively in any area at least 20' in diameter.

**Space Drake:** AC 2; MV 12, FL 30 (C); HD 10; hp 65; #AT 2; Dmg 2-16/1-12 (bite/tail); SA breath weapon (Dmg 6d6); SD 30% magic resistance; AL N(E); THACO 11.

The space drake is exceptionally hungry—no wonder; it's had nothing to eat but asteroid for quite a while—and will attack ferociously. Perhaps because it looks different from the others, or perhaps because it is closest to the center of the chamber, the space drake makes its first attack against Thought Taker.

The sinuous form lunges toward Thought Taker. The illithid gives a whistling scream of terror. Almost too fast for the eye to follow, the mind flayer reaches out and snatches one of the hand-sized stars . . . and vanishes. Instantly, you are plunged into darkness.

Thought Taker has got what it wanted—concrete proof that the Elders were once aboard the Outpost—and has used its *plane shift* ability to escape (although the PCs might assume that it was destroyed by the "star-helm"). The creature will not return. As far as it is concerned, it has discharged its side of the bargain it struck with the PCs. They are welcome to anything they find within the Outpost—particularly the space drake.

For its part, the drake will use its maneuverability and powers to their best effect in trying to kill and eat the PCs. It is unhindered by the darkness that fell when Thought Taker deactivated the helm (and hence the lighting system). If *seriously injured*, the creature will try to make its escape.

Apart from the central star-helm—which Thought Taker rendered completely inert by taking the smaller star—there are a few other items of interest that the space drake hasn't eaten.

There is a large cabinet that resembles a metal wardrobe some ten feet tall. It contains an enormous suit of plate mail, fully 9' tall. The design is totally unfamiliar: it is built to accommodate a creature with three legs and three arms, showing trilateral symmetry. The size and configuration makes it apparent that the armor could never fit a creature like a xorn or a tirapheg; this armor was worn by no creature ever reported in known space. Engraved on the triple breastplates are intricate patterns made up of the three-pointed star motif. The cabinet also contains three broad-bladed swords (treat as two-handed swords). The hilts of the weapons are ridged and channelled, as if fitted to manipulative organs only distantly related to humanoid hands. (Un-

less the weapons are re-hilted by a weaponsmith, they can be used but at a -1 penalty to hit because of the strange nature of the grip.) The weapons emit a faint aura of evocation magic. They have no bonus or penalty to hit, and they have no other powers. (They used to be highly enchanted, but the dweomer has faded almost to nothing over the millennia.)

Another metal cabinet, this one only 4' tall, contains what must be charts. Rather than parchment or paper, the charts are scribed onto sheets of a flexible, metallicized material (like metallicized mylar). The symbology is totally alien, making them almost impossible to decipher. Without magical assistance (such as a *wish*), deciphering the charts will take 2-6 weeks of study by someone with skills in that area. When the charts are deciphered, they show crystal shells and planets of wondrous nature totally unknown to the PCs. Unfortunately, the charts were drawn up several millennia ago, and the crystal shells have drifted so far since then that the charts are useless.

There is another rack on the wall that contains three delicately tapered wands made of silvery metal. Two are totally inert; the third has an aura of evocation. This is a form of *wand of magic missiles*, with 100 charges remaining. It can fire up to 5 missiles per round, each missile costing one charge and inflicting 2d4 + 1 points of damage. The missiles take the form of tiny, silver three-pointed stars. To trigger the wand, the user must picture a certain geometrical form in his or her mind—the Elders' equivalent of a word of command. (Finding out exactly how to trigger the wand might motivate quite a quest . . .)

There is a recessed drawer alongside the rack of wands. Inside is a book made of leaf-like crystals. The book can be translated as the "Lyric of the Eternal Lotus," an ancient apocrypha to thri-kreen holy writings. Unlike other later copies of the "Lyric," this book makes no mention of the mantis warriors' "manifest destiny" in space that permeates much of their writing. For this reason, it might be of interest to certain collectors. (If the DM plans to run the adventure "Jihad!" the PCs should be unable to find a buyer for the manuscript.)

Under their patina of space dust, the walls bear murals. These depict scenes from space, showing some very alien planets (disc worlds, torus worlds, flat worlds, etc.). Nowhere is any representa-

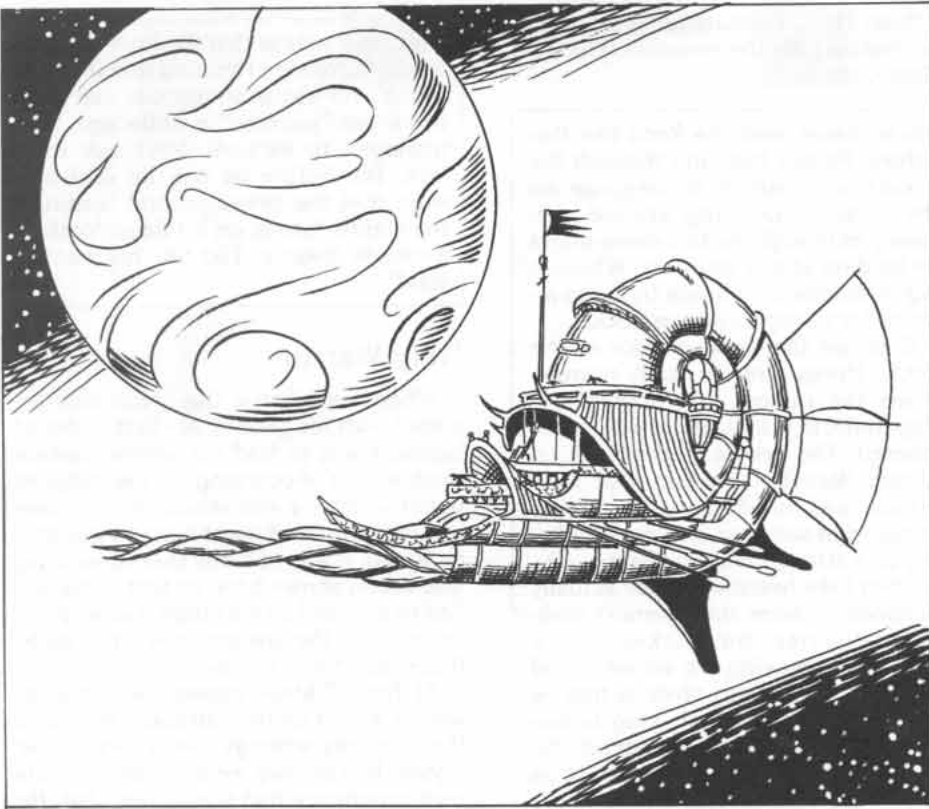

tion of the creature that might once have worn the strange suit of armor.

### 3. Space Drake Lair.

The drake has made this as comfortable for itself as it can. Unfortunately for historians, this remodelling involved eating everything in the chamber.

Even though the large drake has (presumably) been killed or driven off, this chamber is not deserted. The drake was taking care of its single offspring, a blind "space newt." This creature is barely 10' long, and its eyes have not opened yet; otherwise it resembles its parent in all particulars.

**Space Newt:** AC5; MV 8, FI 24 (B); HD 3; hp 11; #AT 1; Dmg 1-8 (bite); SA breath weapon: SD 30% magic resistance; AL N(E); THACO 17. The newt can breathe a single energy pulse per round, inflicting 2d4 points of damage. However, since the creature is currently blind, all saving throws are made at +8. Any bite attack by the creature is at -4.

When the PCs enter the chamber, the space newt sets up a high-pitched keening cry, and moves tentatively toward them. (It wants to be fed.) If the PCs attack, it will fight to the death (being too

stupid to think of any alternative). If, however, the PCs feed it (anything will do; a rock, a dagger), it will settle down. The creature is very impressionable, and will "imprint" on anything that feeds it when it's hungry. This presents an opportunity for the PCs to acquire an interesting pet. During its blind state (which lasts 6 months), the newt will follow anything that feeds it on a regular basis. When its eyes open, it will firmly imprint on the first creature to feed it. From then on, it will be loyal to that creature. Space drakes take five years to mature, and live for up to 1,000 years.

The adult space drake used this chamber as lair and consumed all but a few small items in this room. Most of these are worthless (dented shields or metal hull plates, etc.), but a few have some significant value: a golden chalice studded with moonstones (550 gp value), a silver-plated helmet with a huge emerald set in the brow (1,200 gp), a length of heavy gold chain (350 gp), and a bloodstone the size of a human fist (1,000 gp). There is also a small box made from beaten gold (250 gp). Inside the box, resting on red velvet, is a *ring of truth*.

### 4. "Planetarium."

This chamber is perfectly spherical, with smooth, metal-surfaced walls. Hanging in the geometric center of the chamber is a strangely-shaped "saddle." (PCs can make a check vs. Intelligence to realize that this saddle is the only reasonable design for a seat to accommodate a three-limbed creature.) Although there are no visible supports, the saddle is immovable.

As soon as any living creature touches the saddle, the walls of the chamber turn black and appear to be studded with stars. The illusion of suddenly being suspended in space is almost perfect.

This is a planetarium of sorts. Through thought alone, any creature touching the saddle can "navigate" through space at almost infinite rates of speed, passing easily into and out of crystal shells, and moving as easily through the Flow as through wildspace. (This is all a simulation, of course.) The effect ends, and the chamber walls return to normal, as soon as contact with the saddle is broken.

### 5. Records Room.

The walls are lined with racks containing hundreds of tiny scrolls, each made of the same flexible material as the charts. The scrolls are contained in metal tubes. Mounted on the wall opposite the tunnel is a box-like device with a square piece of milky-white crystal set into its front. Below this crystal is a circular hole exactly the right size to accept one of the metal scroll containers. If a scroll, still in its container, is inserted into this hole, the crystal glows and symbols appear on it. If a character touches the device, he or she can move the symbols around. (This is similar in effect to a mind-directed microfiche reader crossed with a word processor.) Again, the symbology is totally alien, requiring magical assistance or extensive cryptographic analysis. The "microfiche" contains further information on the shells and worlds depicted on the charts from chamber 2. There are also day-to-day records of life in the Outpost. Unfortunately for the PCs, these are almost totally incomprehensible, even when translated. (It's a common misconception that you can understand anything as long as the words are translated. In fact, the words can be next to useless if you don't share the background information and mental outlook that those words depend on.)



If the PCs try to dismount the device from the wall, it becomes totally inert, and can never be made to work again.

The PCs aren't the only creatures to have stumbled upon the Outpost. Some centuries ago, another exploratory mission explored these caverns. One of their number was slain—perhaps by the space drake—in this very chamber. This explorer was named Divad, a human from the Forgotten Realms. As he died, Divad's final wish was to return to his home. So strong was this desire that Divad's spirit has remained in this place as a haunt. The haunt will attack the first PC to enter the chamber. If the haunt succeeds, it will try to force the other PCs to take it back to Realmspace. As soon as the haunt enters the shell that was its home, it will release the possessed character and vanish forever.

**Haunt:** AC 0/victim's AC; MV 6/as possessed victim; HD 5; hp 24/victim's hp; #AT 1; Dmg special/by weapon; AL CN; THACO 15.

## Concluding the Adventure

Although there may seem to be little "treasure" within the Outpost, many of the relics and artifacts can be sold to collectors, sages, etc. for significant sums of money ("all the market will bear"). The PCs should be left to figure this out for themselves, of course.

Thought Taker happily returns to his home, and will never trouble the PCs again.

Future adventures can revolve around searches for other relics of the Elders, or encounters with their wondrous creations. (Perhaps the *Spelljammer* itself was created by the Elders, and perhaps they are still aboard her . . .)

## Jihad!

Setting: Rock of Bral  
Party: 4-6 characters, levels 7-10  
Ship: Any

## Setups

- The PCs are on the Rock of Bral. They hear rumors that a space-faring flotilla of thri-kreen ships is cutting a swath across the universe, trying to spread the word of a new religion. Other rumors—slightly more hysterical, this time—claim that the flotilla is heading directly toward the Rock . . .

(Note: This adventure takes place several months after the events described in "Time Capsule.")

You've never seen the Rock like this before. People hurrying through the streets with parcels or baggage on their backs. Looking around nervously as though the thri-kreen might be landing at any moment. Whispering in shadows, no doubt trying to arrange for transport off the Rock.

Even on the lower surface of the Rock, things are far from normal. When the rumors first started, the ship traffic to Prince Andru's docks increased. The people of the Rock rejoiced. Wasn't it obvious that their prince was reinforcing the Rock, bringing in weapons and men, building up a strong defensive fleet . . . ?

Then they heard what was actually happening: those ships weren't making deliveries, but pick-ups. The prince was moving his valuables off the Rock, and it was obvious that he planned to follow them long before the thri-kreen flotilla arrived. So much for defense. The Rock was to be left to its fate.

The DM should manipulate matters so that the PCs find out some of the details concerning the thri-kreen ship. Curious players will probably try to find out themselves; others might have to be "prodded" into it. In any case, when the PCs encounter an appropriate source for information, read the following:

"People have got it all wrong," your contact tells you flatly. "They think the insects will just come in and exterminate everyone on the Rock. That's just not the way it happens. They don't necessarily want to kill. They'll come in with their ships and ask for surrender. They'll demand that we accept their new religion and that we forswear all other gods. As long as we do that, and don't do anything against their laws, they'll let us live."

Your contact snorts. "But look around you. Are these people going to surrender totally? Isn't there going to be someone who tries to do something to the thri-kreen? And when they do, everyone on the Rock will be dead. The only alternative to total surrender is death, and if anyone fights

back, that means that the Rock didn't totally surrender. I learned that from a friend who was at an outpost that the thri-kreen "pacified" a while ago. He managed to escape, don't ask me how. But before he did, he said he even met the priest-general leading the mantis forces, on his flagship, the Message Bearer. Tiktitik, his name was."

## Holy Warrior

When Tiktitik the thri-kreen was reunited with his people, his first order of business was to find out where matters went wrong. According to the religion under which he was raised, the success and dominance of the thri-kreen was preordained. It was obvious that something was wrong somewhere, or that someone lied to him and all his fellow warriors. He returned to the ancient holy writings to find where the error lay.

At first, Tiktitik approached this research with a cynical attitude. He knew that the holy writings weren't worth the crystal leaves they were scribed on; his own experience had shown him that. He was simply searching for the details of their fallacy. But, as he continued his research, he began to feel the sweeping power of those works all over again. And then, in a little-known apocrypha called the "Lyric of the Eternal Lotus," he found his answer.

There was no fallacy in the holy writings. Everything was preordained after all. The error had been made by those who passed on the teachings of the writings. There it was, plain as day, the prophesy that the thri-kreen's spread through the stars would be stopped and reversed. But then, under a new holy leader, the People of the Celestial Mantis would spread once more to the stars under the banner of the Mantis God of the Eternal Lotus. The leader, so the prophesy said, was to be "a warrior from the past."

Tiktitik was stunned. It seemed obvious that the prophesy was referring to him. He was a "warrior from the past," and it seemed his duty was obvious.

His rise to pre-eminence among the religious leaders of the thri-kreen would seem meteoric in any other race. But the thri-kreen were used to rapid changes in their religion. There was very little opposition to Tiktitik's views; the holy writ-

ings certainly seemed to support everything he said. Within a matter of 4 months, the fleet was assembled and on its holy mission: to spread the True Word to the rest of the universe.

As the PCs' contact explained, the thri-kreen have no real desire to kill anyone. If their foes surrender and agree to abide by the precepts of the Eternal Lotus, they are left alive. The thri-kreen look on surrender as an all-or-nothing affair, however. If a group—an outpost, a ship or even a planet—gives its surrender and then one person in that group transgresses the bounds of that surrender, then the entire group is considered to have defaulted, and will be put to death immediately.

So far, Tiktitik's fleet has been victorious. Now he has ordered most of his ships to await him in the Flow while he takes a small force to deal with the Rock of Bral. The Rock is of great strategic importance, and he figures it would be better to deal with it now than wait until it can be reinforced.

**Note:** The thri-kreen have an interesting way of handling parley and negotiation in confrontations. This is common knowledge throughout the universe, so the PCs will know it as well. If a single thri-kreen or a small group approaches an enemy that massively outnumbers them, then this individual or group is to be considered as ambassadors, and should not be killed. When the negotiation is complete, the ambassadors should be allowed to return to their force without hindrance. Killing an ambassador is one of the worst crimes known to the thri-kreen. No surrender will be asked for or accepted from the group that committed the crime. The same works in reverse, of course. If a small ship—obviously too weak to be considered an effective attack—were to approach the thri-kreen fleet, no mantis warrior would fire on it, because it is obviously a party coming to parley. A ship large enough to be a threat to any vessel in the fleet, however, would be considered to be attacking, and would be destroyed.

## Ambassadors

The detachment of the thri-kreen fleet led by Tiktitik arrives several days earlier than anticipated, before Prince Andru makes his escape from the Rock. The three Leaf-ships that make up the de-

tachment can be seen hanging in space near the rock. The thri-kreen fire no shots at the Rock. Conversely, none of the vessels moored to the docks of Bral are ready for immediate reaction. The two forces are facing each other, but the hostilities have yet to begin.

A small thri-kreen vessel, called a Thorn-ship, leaves the fleet and lands at Prince Andru's palace. It contains three thri-kreen ambassadors asking for the Rock's surrender. As the PCs will hear quickly through the grape-vine, the prince stalls for time, telling the mantis warriors that he must reach consensus with his advisors before he can give an answer. The thri-kreen accept this and leave, telling him that they will return in twelve hours for his final answer.

While this is going on, the PCs are down at the docks. The trajectory of the departing ambassadors' Thorn-ship will take the small vessel directly over the dock at an altitude of about 300 feet. As the Thorn-ship starts its departure, the PCs notice movement on a Squid-ship moored nearby. There are two humans on deck, and they've just finished loading the Squid-ship's heavy ballista. Now they're training the weapon on the departing thri-kreen Thorn-ship.

The PCs have a choice to make. If they don't interfere, the men will fire the ballista, damaging the ambassadors' vessel. The time for negotiation will be over, and the thri-kreen fleet will attack. The Rock's only hope for survival will be to defeat the thri-kreen in battle. (This is one of the reasons why it's important for the PCs to understand about the thri-kreen's ideas about ambassadors.)

Alternatively, the PCs can try to stop the men from firing the ballista. The two men, named Garth and Turgeon, are crewmembers of the Squid-ship. The heavy ballista is on the forecastle, and is 100 feet away from where the PCs are currently standing. The PCs have three rounds in which to do something; otherwise, Garth and Turgeon will fire.

**Garth:** AC 10; MV 12; F3; hp 18; #AT 1; Dmg by weapon (short sword (1-6), dagger (1-4)); Str 14, Dex 13, Con 13, Int 8, Wis 8, Cha 11; AL CN(E); THAC0 18.

**Turgeon:** AC 10; MV 12; F2; hp 10; #AT 1; Dmg by weapon (short sword (1-6), dagger (1-4)); Str 12, Dex 12, Con 14, Int 8, Wis 9, Cha 9; AL CN(E); THAC0 18.

Neither wears armor. They each carry a short sword and a dagger. They are determined to blow the thri-kreen ship out

of the sky, and won't be persuaded otherwise by anything other than overwhelming force. As their Intelligence scores show, neither is overly bright; they simply don't know and won't believe the thri-kreen's attitude toward ambassadors.

## Warfare

If the PCs don't stop Garth and Turgeon from killing the thri-kreen ambassadors, then the war is on. The thri-kreen will immediately begin to bombard the Rock, beginning with the prince's castle, but soon "walking" their fire toward the docks. Any ships attempting to leave the docks will be immediately engaged.

The thri-kreen task force comprises three Leaf-ships, each with a full complement of four Thorn-ships. Details on the task force are given below and are also present on the mapsheet.

## Thri-Kreen Vessels

### Leaf-Ship

<b>Built by:</b>	Thri-kreen
<b>Used Primarily by:</b>	Thri-kreen
<b>Tonnage:</b>	70 tons
<b>Hull Points:</b>	70
<b>Crew:</b>	20/65
<b>Maneuverability</b>	
<b>Class:</b>	D
<b>Landing—Land:</b>	No
<b>Landing—Water:</b>	Yes
<b>Armor Rating:</b>	6
<b>Saves As:</b>	Ceramic
<b>Power Type:</b>	Crystal throne (see below)
<b>Ship's Rating:</b>	4
<b>Standard Armament:</b>	
	1 heavy catapult
	Crew: 5
	4 heavy ballistas
	Crew: 4
	Piercing ram
<b>Cargo:</b>	30 tons
<b>Keel Length:</b>	250'
<b>Beam Length:</b>	40'

**Description:** As its name implies, the thri-kreen Leaf-ship resembles a long leaf. There are stations around the hull at which up to four Thorn-ships can be docked. The vessels are grown from living crystal, in a manner similar to elven ships. Their color is usually a delicate, translucent green or yellow. The Leaf-ships are very resilient.

Their source of power is a device that the thri-kreen call the "crystal throne." It is

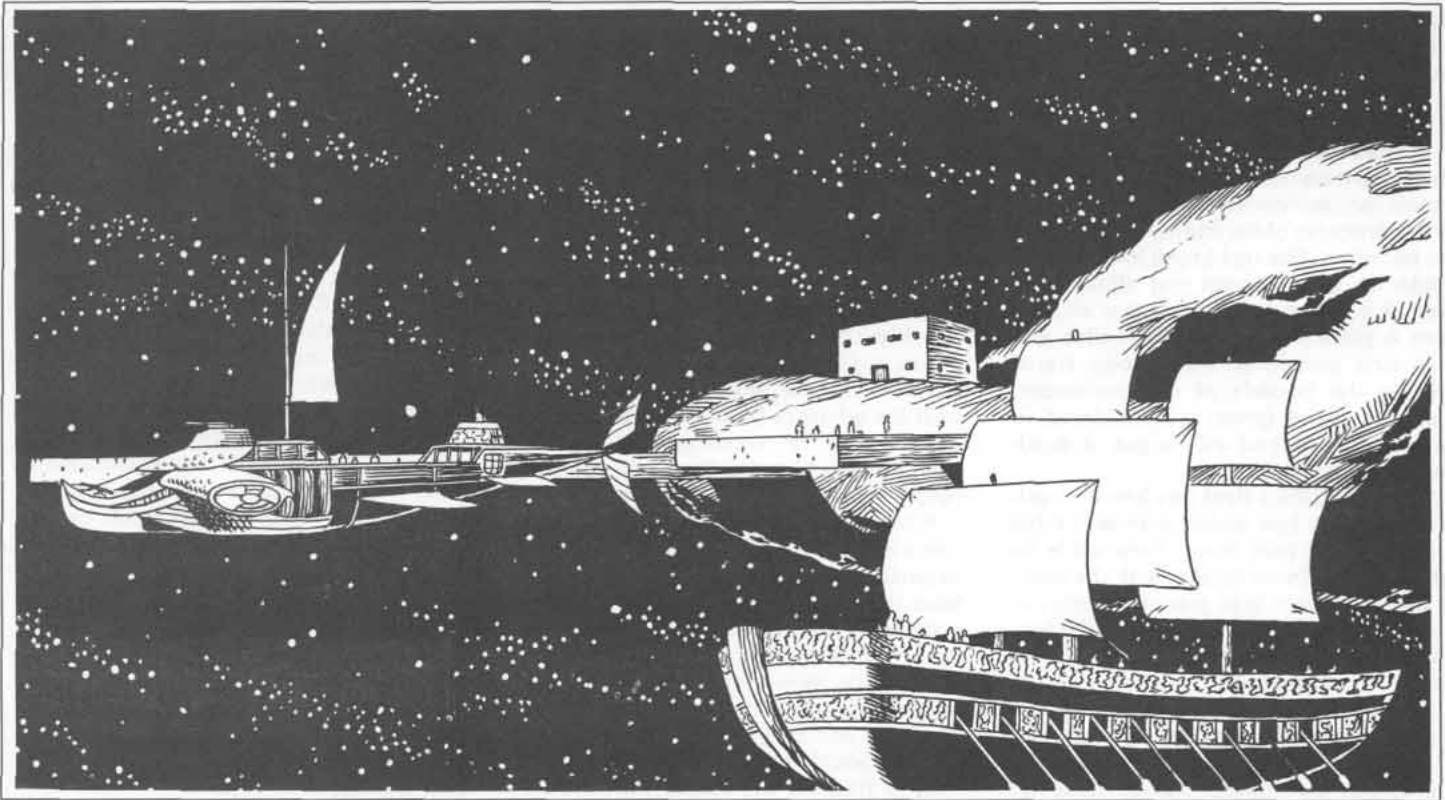

a huge, multifaceted crystal, about 8' high and 4' wide, formed roughly in the shape of a wide-armed throne. When a thri-kreen sits in the throne, it glows with a pale inner light, and operates as a spelljamming helm. The exact nature of its effect is unknown; it is definitely different from any other known helm, and might have come from a source other than the Arcane. Any thri-kreen can operate the crystal throne; no spellcasting power is required. The SR of the ship is determined by the construction of the throne, not by any attributes of the individual using it. There are no spelljamming after-effects. No race other than the thri-kreen can use a crystal throne because they don't have the correct mental architecture.

The design of the interior is slightly rounded. There are no 90° corners, and no completely flat planes. Thri-kreen doors are articulated affairs rather similar to multi-leaved folding doors. Illumination comes from the walls, where light-producing organisms live within the crystal structure.

### Thorn-Ship

<b>Built by:</b>	Thri-kreen
<b>Used Primarily by:</b>	Thri-kreen
<b>Tonnage:</b>	3 tons
<b>Hull Points:</b>	3
<b>Crew:</b>	1/6
<b>Maneuverability</b>	
<b>Class:</b>	B
<b>Landing—Land:</b>	Yes
<b>Landing—Water:</b>	Yes
<b>Armor Rating:</b>	7
<b>Saves As:</b>	Ceramic
<b>Power Type:</b>	Crystal throne
<b>Ship's Rating:</b>	3
<b>Standard Armament:</b>	
	1 light ballista
	Crew: 1
	1 Greek fire projector
	Crew: 3
<b>Cargo:</b>	2 tons
<b>Keel Length:</b>	50'
<b>Beam Length:</b>	10'

**Description:** The Thorn-ship is a tiny open ship that acts as a screen vessel and fighter for a thri-kreen task force. It is very maneuverable, which partially makes up for its lack of resilience.

Thorn-ships carry 1-10 charges of

Greek fire. Thorn-ships will frequently make suicide runs against powerful enemy vessels, detonating their Greek fire cache on or just before impact.

There are a number of ships docked at the Rock, all of which will become involved in the fray: one Squid-ship (SR 3), two Wasps (SR 2 and 4), three Tradesmen (SR 1, 2 and 2), two Damselflies (SR 2 and 3), and a stinger-class Mosquito (SR 2). In addition, the prince has three Tradesmen (SR 1, 1 and 2) and a bumble-bee-class Wasp-ship (SR 2) moored at his private docks. Finally, there is (presumably) the PCs' vessel, whatever it may be.

These vessels will all engage the thri-kreen task force, but in a very haphazard and disorganized way. Here is an opportunity for the PCs to affect the outcome of the battle. If they can persuade the other ship captains to listen to them, they might be able to coordinate the defensive action a little better. (This is a good opportunity for role-playing.)

In any case, the defense of the Rock gives the PCs a chance to get involved in a large-scale naval engagement. The DM should control all the thri-kreen vessels and any other ships that haven't put them-



selves under the command of the PCs.

## Parley

If they managed to prevent Garth and Turgeon from destroying the ambassadors' vessel, the PCs have some time to figure out an alternative to out-and-out war. Escape isn't the best option: the thri-kreen will attack any vessel trying to leave the Rock. If the PCs recall their fairly friendly relationship with Tiktitik, they might try to parley.

The thri-kreen's attitude toward ambassadors will ensure that the PCs will not be attacked if they approach the task force . . . but only if their ship and behavior appear to be non-threatening. For example, the ship must be 40 tons or smaller, with heavy weapons unloaded and unmanned, and the approach must be slow. As the PCs' vessel approaches, two Thorn-ships will detach from the flagship *Message Bearer* and escort the "ambassadorial" vessel into the midst of the task force. The crews of the Thorn-ships will then offer to ferry up to six "ambassadors" to their leader.

## Tiktitik Again

Tiktitik and his officers will listen politely to almost anything the PCs may wish to say. They draw the line at overtly threatening rhetoric and anything that can be interpreted as derogatory toward the thri-kreen religion. Tiktitik is a lot more liberal in that regard than his officers, however. Should the PCs get onto a touchy subject, he will recommend that they continue the conversation in the privacy of his quarters. As leader, Tiktitik is normally escorted by two warrior bodyguards; in this case, he will order that they stand guard outside his door.

Because they saved him from the Flow, Tiktitik will patiently explain to the PCs the background behind his current actions. He honestly wants them to understand and agree with the necessity. He will listen to any arguments the PCs can muster against the jihad, but it will be almost impossible to sway him. As Tiktitik keeps stressing, the "Lyric of the Eternal Lotus" is incontrovertible, and it tells him that what he is doing is correct.

This should remind the PCs of something they found during the adventure "The Outpost": a very early rendering of the "Lyric of the Eternal Lotus." If they show it to Tiktitik, he confirms that it is

truly ancient; the language and writing style proves it. Unlike later versions of the Lyric, this copy includes no mention of the thri-kreen's manifest destiny in space, or any hint at a preordained domination of the universe. It is obvious that any such facets were inserted by later copyists or "editors;" as such, these facets are neither revealed as truth nor holy law, and should be ignored.

Although it is hard for Tiktitik to accept this, he is a strong-willed character (as was proven in "Time Capsule"). He will quickly come to the conclusion that his actions are wrong. He will immediately cancel the assault on the Rock. If the PCs are unable to convince Tiktitik, out of friendship he will give the PCs the option of leaving the region before his assault on the Rock begins.

**Note:** This entire confrontation is a great opportunity for role-playing, both by the players and by the DM. If the PCs don't think of their copy of the Lyric, the DM might subtly remind them, maybe by something Tiktitik says (for example, "I am guided by holy writings. If other holy writings directed otherwise, my path would be different. But no. What other holy writings are there that I have not read?").

PCs whose minds run more toward confrontation than role-playing might try to assassinate or kidnap Tiktitik. This will do them no good and considerable harm. The task force will not be dissuaded from its goal by Tiktitik's death. Thri-kreen do not bargain with kidnapers, and do not pay ransoms. As soon as it becomes apparent that Tiktitik is a hostage, the other thri-kreen will attack the PCs and try to kill them all. They will try not to kill Tiktitik, but if he dies in the assault then so be it. To thri-kreen minds, the life of the hostage is secondary to expunging the insult to the entire thri-kreen race. Tiktitik agrees totally with this philosophy, and would be disgusted if his warriors let the kidnapers escape just to save Tiktitik's life. Either assassination or kidnapping will immediately trigger the attack on the Rock.

## Concluding the Adventure

If the PCs convince Tiktitik of the error of his ways, he will leave the Rock and return home. The thri-kreen will remain a force in space, but a peaceable one, interested more in exploration than in conquest. The thri-kreen threat is over.

The PCs may be able to convince Prince Andru that it was their actions that saved the Rock from bombardment. Andru will, of course, be highly skeptical; also, he will definitely not want to part with a large reward. The PCs might be able to finagle some money out of him, however.

To the populace at large, the PCs will be heroes. Although hero-worship doesn't fill the coinpurse, it does wonders for the ego. The PCs should be seven-day wonders around the Rock. As well as benefits (free drinks, etc.), this fame has disadvantages. The PCs are now known, and will probably become the targets of pickpockets, confidence men, etc. In addition, their whereabouts are known—if only for a short time—and will be communicated to any recurring "nemesis" that might be gunning for the PCs.

If the PCs are unable to convince Tiktitik to call off his attack, the battle will take place. The PCs have the option of joining in or not. If they decide to wait it out, then the thri-kreen will crush the resistance and take over the Rock—this will happen "off-stage."

**Note:** If the thri-kreen take over the Rock, many of its populace will be considered "cattle" by the thri-kreen. Resistance will grow and the PCs could become part of a resistance movement to restore Prince Andru's rule.

## Billy Bones

Setting: Wildspace  
Party: 4-6 characters, levels 6-8  
Ship: Any

### Setup

• The PCs are approaching a system that was heavily involved in the Unhuman Wars. (Perhaps it was one of the few ground-based elven outposts that the goblinoid fleets managed to destroy.) The PCs may or may not know the history of the system.

No matter how many times you may see it, a sunset from space still has the power to touch the wellspring of your spirit. As you draw nearer to the world ahead of you and pass into its shadow, the system's star is refracted for a moment by the planet's atmosphere. Red and orange flare, followed by a split second of brilliant emerald green. Then the planet occults the star as your ship sails into darkness.

Thud! Something falls to the deck. A hard, jagged ball of some white substance, a little more than two feet across. It must have been swept up in your atmosphere envelope. Crack! Another bounces off your mast before landing on the stern castle. Two more strike the rigging; one falls to the deck, the other remains caught in the ropes.

As other balls fall around you the first begins to move. You watch in horror as it unfolds and stands up. A human skeleton faces you, a shining blade in its hand and a sullen red glow in its empty eye sockets . . .

As described on pages 62 and 63 of the *Lorebook of the Void*, during the Unhuman Wars, a standard defensive tactic used by necromancers was to fold animated skeletons into small bony balls and scatter them through space, usually around their homeworld. These monsters acted like undead "space mines": any ship trying to reach the world had a chance of running into a number of skeletons. On falling into the gravity plane of a ship, the skeletons' orders were to board and attack the vessel. The PCs are unlucky enough to sail through a

forgotten cluster of these "delayed action undead."

There are 12 skeletons in the cluster and they are fairly evenly distributed over the ship. Six are scattered on deck, three are in the rigging, and three more impact on the underside of the ship's hull. These latter three will clamber along the hull and enter the ship through any open porthole; in the absence of portholes, they will climb over the rail and join the fighting on deck in 2-8 rounds. The skeletons will fight until destroyed.

**Skeleton (x12):** AC 7; MV 12; HD 1; hp 2, 3, 3, 4, 4, 5, 5, 6, 6, 6, 8, 8; #AT 1; Dmg 1-6; SD edged/piercing weapons inflict half damage; AL N; THAC0 19.

### Concluding the Adventure

This is more of a "nuisance encounter" than anything else (although it can be used to foreshadow the PCs' involvement with a world that was central to the Unhuman Wars).

If the adventurers defeat the skeletons (which is entirely likely), there are no consequences. The monsters have no treasure or anything else of value. Should the skeletons defeat the PCs and their crew, the monsters are unable to handle the vessel. Depending on circumstances, the skeleton-infested ship will either drift aimlessly through the system, or spiral down toward a planet as its orbit decays until it burns up or crashes.

### Parasite!

Setting: Wildspace  
Party: Any  
Ship: Any

### Setups

• The PCs hear from port authorities that a certain ship—the Dragonfly *Freebooter*—is several days late. There are rumors of pirate activity in the region, so port authorities fear the worst. The PCs are told the *Freebooter's* course, and are asked or hired to find out what happened to the vessel.

• The PCs have an arrangement to meet a half-elf trader—Eril Leafsong, captain of the *Freebooter*—at a particular port, base or outpost. Leafsong misses the meeting, however, and the PCs hear that the *Freebooter* is long overdue.

• While travelling in wildspace, the PCs stumble upon a Dragonfly drifting in the void.

The vessel hanging in space ahead of you is a Dragonfly. At least, it used to be a Dragonfly.

Now? Several of its legs are missing, the mainmast is shattered, and one wing is twisted and torn. Obviously the small ship ran afoul of something. You examine the vessel again. Yes, you think it should still be usable. No lights show anywhere aboard her.

If the PCs know about Eril Leafsong, they will recognize this vessel as the *Freebooter* by its distinctive paint. Otherwise, they can read its name off its bow.

As the PCs draw closer, they can see more details of the damage to the Dragonfly. In addition to the rigging damage—obviously caused by one or more impacts from a large creature or object—there are a number of burn marks on the hull. These look as though they might have been caused by larger versions of *magic missiles*.

### Eril Leafsong and Crew

Eril Leafsong is a half-elf well known for his success in the "small packet trade" (i.e., smuggling). Apart from his mild penchant toward defrauding the authorities, he is a scrupulously honest operator: hire him to carry something, and you can be sure it will get there. For this, he is well respected in many circles, even among the authorities (sometimes governments, too, need services that are outside normal channels).

Eril's wife is a young elven mage named Rowena Leafsong (following the customs of her society, Eril took her last name when they married). She acted as spelljamming mage for the *Freebooter*.

The rest of the vessel's crew of seven was filled out with hirelings—but only those hirelings who Eril was sure he could trust.

The final crewmember of the *Freebooter* was Rowena's pet, a tiny capuchin monkey she named Flowerbud. While many domesticated creatures, even cats, have difficulty adapting to spacefaring life, Flowerbud has taken to the alien environment with no trouble at all.

**The Freebooter**

The *Freebooter* is smaller than the vessels preferred by some smugglers, but it suits Eiril's needs admirably. He has modified the vessel for more maneuverability, both by increasing the ship's rigging and by stripping away inessential weight. The *Freebooter* thus has MC B and AR 10 (Eiril Leafsong believes the old saying about "he who turns and runs away lives to fight another day"). Leafsong is not a total pacifist, however: the *Freebooter* is armed with a turret-mounted light ballista on the upper deck.

Apart from these changes, the *Freebooter* matches the statistics given for the *Dragonfly* in the SPELLJAMMER™ boxed set. Use the ship plans on the back of the "Dragonfly" card. All areas in the following description correspond to the numbered areas on the plans. The ship is in total darkness. The vessel's air envelope is fresh.

**Upper Deck**

Whatever scrape the good ship *Freebooter* was in, it made it through in barely one piece. Here the railing is smashed; there, the deck has a hole burned in it. (Dropped lantern? Tiny fireball?) And in several places there are blood stains. Some look human, some most definitely do not. In general, the mess has been partially cleaned up, and minor repairs have been made. But in most cases the damage is enough to require a refit, or repairs that can't be made while underway.

What was that? Something shiny caught your eye, over there, imbedded in that broken piece of railing. You pull it free from the wood and turn it over and over in your hand. It's a tooth, a sharp tooth that might have come from the mouth of a shark . . .

The tooth is from a skavver that attacked the ship (details on the battle will

come later). A character with a proficiency in animal lore can make a proficiency check to recognize it.

The rack used to hold ballista bolts is empty.

**Lower Deck**

**1. Bridge.**

Death! The smell is instantly recognizable as it catches in the back of your throat. Blood, and a hint of corruption.

Just ahead of the mainmast is a large chair that could only be the vessel's minor helm. And draped across it are two male figures. Both are dead, there's no doubt about it. The larger one has his fingers still sunk into the throat of the other, while a knife—still clutched in the smaller man's dead hand—protrudes from his back, just below the left shoulder blade.

The two men have been dead a couple of days—about the length of time that

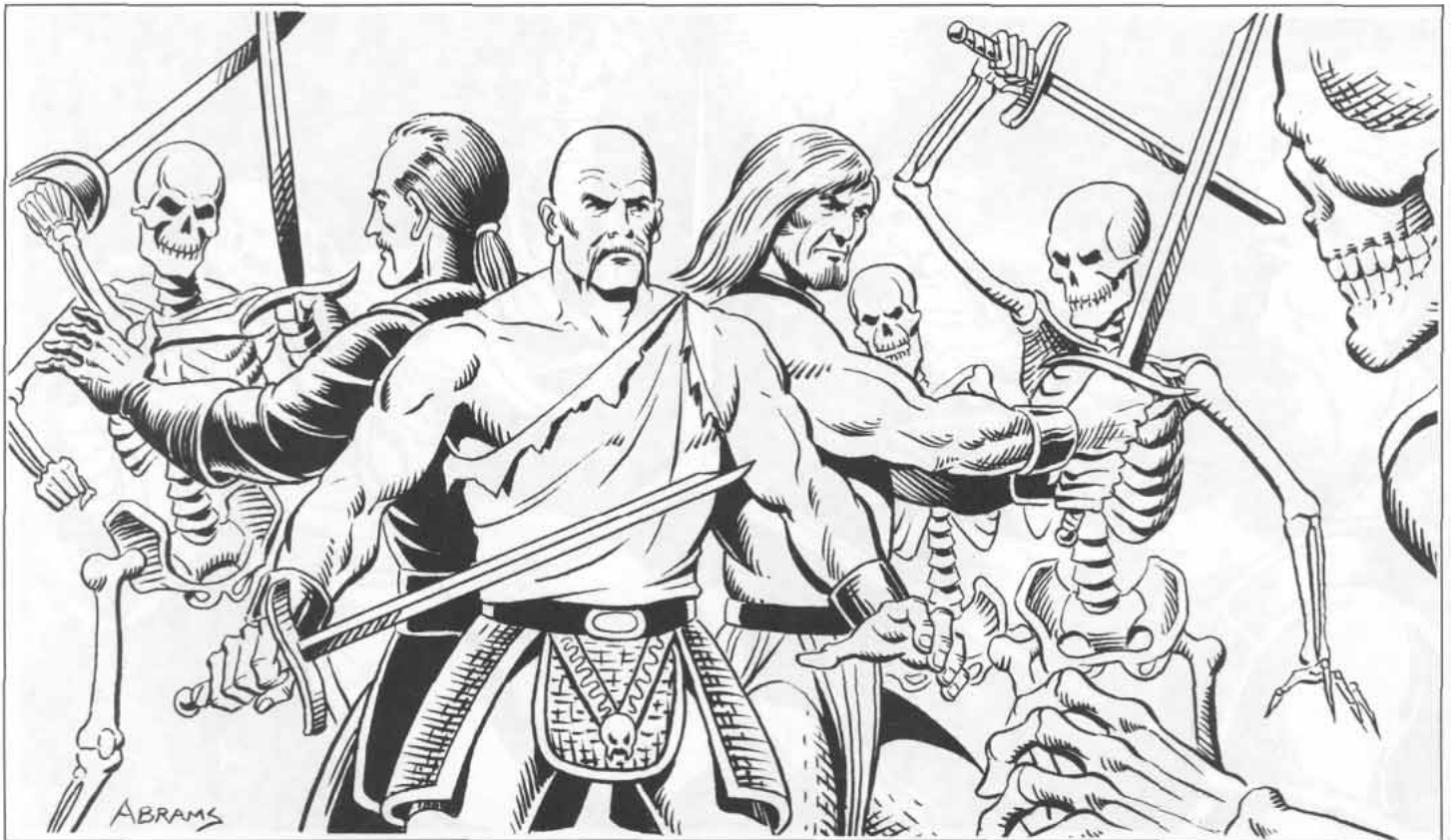



## CHAPTER 4: MONSTERS OF THE VOID

the *Freebooter* has been overdue. Neither has anything of value or interest on his person. From their clothes, these two can be identified as two of Eril Leafsong's crewmen.

### 2. Captain's Cabin.

More bodies. Two of them, one on the cot, the other slumped over the small desk. Both dead.

The figure on the bed is an elven woman, beautiful even in death. She's been laid out neatly, with hands crossed on her breast, and her clothes arranged to conceal the fatal wound in her chest.

The man sitting at the desk has fallen forward, face down on the wooden surface. And no wonder: a crossbow bolt protrudes from the base of his skull.

The man at the desk is Eril Leafsong, the woman Rowena. PCs who've heard about Eril before will recognize him from his description; others can infer his iden-

tity from other facts.

Rowena Leafsong has nothing of value on her body. Eril has a short sword on his belt; from the blood remaining on the blade, it's apparent that it was he who slew his wife.

Eril was killed while making out the ship's log. The leather-bound book is blood-stained, but still legible. Most of the entries deal with the day-to-day matters of navigating a ship in wildspace. Only the last three are of interest:

*"Day 16: I've never seen or heard the like of this before. The ship was attacked by creatures that don't normally attack: six skavvers—not the void variety, either, but the cowardly gray—and a young radiant dragon barely fifteen feet long. They came in with no warning and literally began to tear the ship apart. I tried yelling to the dragon—they often talk if addressed—but it acted as though it didn't hear or care. We fought them off, of course, but we had to slay every last one of them to do it. And it cost us Davitt: the dragon snatched him from the deck,*

*took him outside the ship's air envelope, and killed him. We fired every ballista bolt we had—the dragon took five—and then we were down to crossbows and hand weapons. Thank the gods I decided to hire Kerin after all. That child is a dead shot with a crossbow. Lane and Willik had to finish off the last skavver with daggers as it lay thrashing on the decks. I still can't understand it. Skavvers and dragons do not act that way.*

*Day 18: Repairs underway. But I'm troubled. Ever since the battle, Rowena has been looking at me strangely. Looks full of scorn. Oh, she tries to act normally. And when I yell at her she denies it and cries the prettiest fake tears. Of all the mistakes I've made in a life full of mistakes, she must be the worst.*

*Day 19: I have remedied the mistake. I did as my conscience urged me, as the voice in my head told me, and I killed her. How beautiful she looks now, lying on my bed. And how silent. Noise outside the door. Perhaps Lane and the others should be so silent. Perh—*



A small chest under the cot contains some of Eril's and Rowena's valuables: a velvet bag containing 45 pp (various types of currency), another bag containing five small but brilliant diamonds (500 gp base value), a gold ring encrusted with tiny garnets (250 gp), and a small diamond pendant (750 gp). A rack on the bulkhead contains another short sword, two daggers, a heavy crossbow and a dozen bolts.

### 3. Crew Cabin.

As you pull the door open, something slumps out and collapses at your feet. Or, rather, someone. From his dress you recognize him as another member of the crew. A big, burly man, very strong and resistant to punishment.

He had to be. He took two bolts from a heavy crossbow—both still project from his back—and he still managed to drag himself across the room, sword in hand, before he finally collapsed.

The cabin has hooks for five hammocks, most of which have been cut down with wild sword-cuts.

From the stains on the floor, the PCs can tell that the big crewman was hit the first time when he was at the far end of the cabin. The bowman was probably standing in the doorway.

There is nothing of value in the cabin, other than the long sword in the dead man's hand.

If it seems as though the PCs might leave the ship without exploring the cargo hold, read the following:

Sound! A light scrabbling noise coming from the hold. Somebody moving around but trying to be quiet about it? Somebody with a heavy crossbow, perhaps?

### 4. Cargo Hold.

Carefully, you open the door . . . And something small and grey hurtles at your face.

The creature that is attacking the PCs is Rowena Leafsong's pet capuchin monkey, Flowerbud. As soon as the door is open, it attacks the nearest PC. The creature will not check morale, and fights un-

til slain. It also gets a bonus of +1 to hit and to damage due to ferocity (these have already been factored into the statistics below).

**Capuchin Monkey:** AC 8; MV 9; HD 1 + 1; hp 3; #AT 1; Dmg 2; AL N; THACO 19.

Eril Leafsong's cargo for this trip was information, which he kept in his head. Thus the cargo hold is empty except for a body huddled in a dark corner. The body is that of a youth, no older than 16—it's Kerin, the one Eril praised in the log—and he still cradles his heavy crossbow, cocked and loaded, in his lap. A quiver on his belt holds eight more bolts. The youth has a deep wound in his side that was caused by a slashing weapon.

### The *Freebooter* and the Parasites

The madness that broke out aboard the *Freebooter* was caused by the same things that made the skavvers and the radiant dragon act in such atypical manner: parasites known as Death Shades.

Unfortunately for Eril Leafsong—and, indirectly, for the PCs—a few death shades made it to this shell. An exploration vessel from an infested shell entered this sphere, bringing contagion with it: 11 members of the crew were hosts to death shades. As the death shades were hungry, they triggered rages in their hosts, and a full-scale fight broke out. In the melee, somebody dropped a lantern into the powder locker—where the smoke powder for the bombards was stored—and blew up the ship, killing the entire crew instantly.

During the 5 minutes in which the death shades could survive without a host, a number of skavvers—which had been following the ship hoping for scraps, etc.—came nosing through the wreckage. Some of the death shades were able to transfer to skavvers. Later, these skavvers attacked a young radiant dragon, at great detriment to themselves. The dragon killed many of the skavvers, but was itself infected by a death shade.

It was at this time that the *Freebooter* happened along. The remaining skavvers and the dragon all attacked the ship, and death shades infected Eril Leafsong and his crew as their hosts were killed. Only Rowena Leafsong escaped infection (but it did her little good).

In a rage, two crewmembers killed each other on the bridge. Eril slew his wife, and was in turn slain by Kerin, the crossbow-wielding youth. Kerin put two bolts into the remaining crewman, but his victim was resilient enough to strike the youth with his long sword before collapsing. Mortally wounded, the youth retreated to the cargo hold, where he subsequently died.

Throughout all this ruckus, Flowerbud the capuchin monkey had been hiding out in the hold. When Kerin died, "his" death shade—the last surviving one of the creatures—transferred to the monkey. Thus infected, the monkey will attack any living creature that comes near it—in particular, the PCs. When Flowerbud is killed, the death shade will transfer to the nearest (and most powerful) PC.

### Concluding the Adventure

This is a particularly nasty little adventure to throw at overconfident PCs. Players who are good at problem-solving might make a good guess at what happened on board the *Freebooter*—at least as far as suspecting some kind of contagious insanity—and might consider the possibility that some of them might have become infected as well. Less thoughtful players might never figure matters out. (In this case, a kindly DM might introduce the PCs to a sage who's "heard of matters such as this, in other shells," and point them in the right direction.)

Unless the PCs do something about it, their infected comrade will continue to fly into homicidal rages. Once he's managed to kill 40 hit dice or levels of creatures, the shade will reproduce by binary fission, and the new shade will infest another victim. Theoretically, the PCs could spread contagion to a whole world or shell. If a *wish* spell is cast on the infected PC before that time, however, the entire shell is saved.

(Note to the DM: Choose the PC to be infected with some care. By preference, choose a PC run by the player who is best at role playing. Some players might not enjoy having a character who suffers recurring fits of madness.)

# CHAPTER 5. REWARDS AND REVENGE

The following two adventures, "X" and "Cain" are designed to tie up the "Letters of Marque" story which initiated the PCs' pirate hunt. The PCs can continue their hunt for pirates, of course. They will be doing so without official sponsorship and their rewards will be only the pirates' goods.

These two adventures should be played in order. The first is a simple space engagement; the second is more intricate, involving some elements of intrigue.

## X

Setting: Wildspace

Party: 4-6 characters, levels 8+

Ship: Any

## Setups

- The PCs receive a message from Jasson, the "Pots" member they met in "Letters of Marque." The man wants to arrange a meeting.

- Upon meeting with Wallis to collect rewards for your efforts, he stalls in paying you. He stammers that he can't pay until you meet with Jasson at a pre-arranged time and place. You set the meeting up, anxious to remedy this delayed payment.

Jasson looks older than he did when you first met him . . . or at least more tired. His eyes are sunken, and his face is grey. But his voice is still strong when he speaks to you.

"I knew it would happen," he says, "it was just a matter of time. Do you remember your letters of marque urged you to make war on ships belonging to the Tenth Pit? This was 'kindly requested' by Prince Andru, and he has now exhausted all his patience in dealing with the Tenth Pit. Now he has a target for you. To set your minds at rest, I have checked: the ship truly does belong to the Tenth Pit."

He passes you a sheet of parchment. "Here is the information about the ship. It is a Tradesman, the *Night Passage*, and here is its course information. You are to engage the *Night Passage*, scuttle her, and bring back her cargo. The prince instructs me to tell you"—and here the old man's face crinkles in disgust—"there is no need to burden yourself with prisoners."

Jasson's parchment shows the projected course of the *Night Passage*, complete with times and waypoints. (This course takes the ship through the Rock of Bral's crystal shell, but not too close to the Rock itself.) It also indicates an ideal spot for you to engage the ship, a region well off frequented spaceways. The prince will pay you a bounty of 1,000 gp for the destruction of the *Night Passage*, with an additional 2,000 gp to be paid for its cargo. Jasson makes it clear that to disregard this "request" from Prince Andru will immediately terminate their letters of marque, and probably mark them for "unofficial" persecution at a later date.

## The Night Passage

As Jasson explains, the *Night Passage* is an unmodified Tradesman equipped with a minor helm (refer to the ship plans on the card in the SPELLJAMMER™ boxed set). The vessel is armed with one light catapult and one medium ballista. It is captained by a half-elven initiate of the Tenth Pit named Leratan, an individual wanted for murder and assault on a number of worlds. His crew is a band of half-orc "war brothers." They have sworn an oath to each other and to Leratan; although they are not official members of the Tenth Pit, they are sympathetic to its ends and totally loyal to Leratan.

Leratan's helmsman is a half-orc cleric named Gornat. With him in the helm, the *Night Passage* has an SR of 3.

**Leratan:** AC 2; MV 12; F7; hp 33; #AT 3/2; Dmg by weapon (long sword (1-8), wheel lock pistol (1-4)); Str 13, Dex 12, Con 14, Int 13, Wis 10, Cha 15; AL LE; THACO 14. Leratan wears *bracers of defense AC2*, and is armed with a long sword and wheel lock pistol (enough ammunition for 6 shots).

**Gornat:** AC 8; MV 12; P7; hp 32; #AT 1; Dmg by weapon (mace (1-6)); Str 13, Dex 11, Con 11, Int 10, Wis 13, Cha 10; AL N(E); THACO 16. Gornat wears leather armor and carries a horseman's mace. Because he has been operating the helm, he has no spells.

**Crewmen** (half-orcs; x6): AC 8; MV 12; F1; hp 3, 3, 4, 6, 8, 9; #AT 1; Dmg by weapon (short sword (1-6)); AL NE; THACO 20. All wear leather armor and are armed with short swords.

The *Night Passage* is not expecting serious trouble. The very fact that its captain is affiliated with the Tenth Pit usually

protects it: very few people want to risk the vengeance of the Tenth Pit.

Its current mission is to carry a supply of smoke powder to one of the Pit's outposts on a distant world. Unfortunately, Prince Andru doesn't know this. His information source informed him that the ship would be carrying a powerful magic item that he wants for himself. The plans were changed at the last moment; another ship took charge of the item, while Leratan was ordered to deliver the smoke powder.

## Tactics

The *Night Passage* isn't equipped to engage a larger ship, and it is sailing with barely the minimum crew. Thus it will choose flight over combat if the option is given. Leratan and his crewmembers know that a rather grim form of justice awaits them if they're captured, and they don't like the prospect. They would rather die cleanly in battle than suffer for months in jail before dying in an execution pit. Thus, they won't surrender, and will fight to the death.

If it's obvious that the *Night Passage* is going to be taken, either Leratan or a member of his crew will go down to the hold. There he will strike a light with his tinderbox and detonate the smoke powder. The hold contains 200 charges of smoke powder, enough for 20 bombard rounds. This is more than enough to destroy the Tradesman and kill all aboard her. (The explosion will inflict 200d2 points of damage, which equates to 20d2 points of hull damage to the Tradesman.) The fireball will also inflict 1-10 hull points on any vessel sharing the same air envelope (save for half damage). Any character exposed to the fireball but not aboard the *Night Passage* receives 4d6 points of damage (save for half damage).

## Concluding the Adventure

The prince will be irked by the fact that he didn't get his magic item. Although he'll pay the bounty for the Tradesman's destruction, he'll always harbor nagging suspicions that the PCs are lying to him about the item that he wanted. (This will more than counterbalance any goodwill the PCs earned from the prince in "Jihad!")

More to the point, however, the Tenth Pit will learn through sources that it was the PCs who destroyed their vessel. The



Tenth Pit has a reputation to uphold, and letting a bunch of two-bit adventurers get away with such a slight would seriously tarnish their reputation. To ensure retribution, the Tenth Pit decides to turn to . . .

## Cain

Setting: Wildspace  
Party: 4-6 characters, levels 8+  
Ship: Galleon or larger

## Setup

This adventure is designed to follow directly from "X." The PCs have returned to the Rock of Bral to collect their bounty, and perhaps to repair their ship and rest.

## Vengeance

Through channels, officers of the Tenth Pit have discovered that the PCs are responsible for the recent loss of the *Night Passage*. Punishment of a rather drastic nature is obviously required. Rather than handle it themselves, however, the Tenth Pit has decided to call in an outside expert: Cain.

As well as being a pirate, Cain is an accomplished assassin and leader of assassins. In fact, he makes more money through the brokerage of death than he does through direct piracy. Cain has accepted the contract against the PCs.

He's decided to bring about their demise in an indirect manner, at the same time perhaps destroying someone who he has always considered an enemy and a threat: Torgan Betz (introduced in "Small Package Trade").

For his first move against the PCs, Cain has hired four rough dockside "alleybashers" who sometimes handle various "muscle" assignments. He doubts very much that they'll be tough enough to take out the PCs. If they do, all well and good; if not, there's always step two.

"Alleybashers" (x4): AC 8; MV 12; F3/T4; hp 23, 25, 27, 31; #AT 1; Dmg by weapon (short sword (1-6), dagger (1-4)); thief skills: PP 15%, OL 40%, F/RT 15%, MS 60%, HS 35%, DN 15%, CW 90%, RL 0%; AL NE; THACO 18. The alleybashers are armed with short swords and daggers, and wear leather armor concealed under normal clothing. They are a rough and belligerent lot, tending toward bullying behavior, but dangerous all the same.

Through Cain, the alleybashers know where the PCs are staying on the Rock, and when they're planning to leave. They will then choose the best time to try to assassinate the PCs. (This will probably involve sneaking on board their ship or into their boarding house room at night.) The alleybashers are hired blades only, and have no personal animosity against the PCs. Thus they'll certainly surrender if it seems that the fight is going against them. Under even the slightest pressure, they'll babble everything they know about the person who hired them.

The problem is, they don't know who hired them, although they think they do. Cain did the hiring through intermediaries. During one of the meets, one of these intermediaries "accidentally" let slip the name Betz. The alleybashers know of Torgan Betz, and assume that it was he who hired them.

## Torgan Betz

Cain isn't the only person with far-reaching sources of information, of course. As soon as he hears about what happened, Betz makes his move.

The PCs receive a message delivered by an urchin. The urchin "don't know nuffin" about who gave him the message, just that he received one copper piece and would receive another after delivery.

The message is written in a hand the PCs have seen before. It reads:

*"Believe me when I tell you I have no quarrel with you. You may hold bad feelings toward me, but I assure you they are not reciprocated. Ours was purely a*

*business arrangement, with no personal animosity involved. Now it appears that someone tries to manipulate us all. I would have that stopped. If you are of like mind, meet me at midnight in the graveyard overlooking Lake Bral, where I will have some important insights for you. I will come alone to prove my good earnest.*

*Torgan Betz"*

If the PCs ignore this letter, Betz will send two more similar missives, urging them to meet him at the same place. If they ignore the third letter, Betz will leave them to their fate.

Throughout all this, Cain will send the occasional assassination team after the PCs. These will be similar to the one described earlier, and all will be similarly "programmed" to implicate Betz. One of these teams may eventually succeed; alternatively, Betz might eventually be forced to kill the PCs to protect himself. In either case, Cain will be satisfied.

If the PCs continue to search for him, Betz will continue to send them messages like the first letter, trying to convince them to lay off and leave him alone. Each letter will be less subtle, until he tells the PCs outright that Cain is involved. (This gives the DM a way of "debugging" the adventure if the PCs just aren't going after Cain.)

## The Meet

Despite his claim in the letter, Betz has no intention of wandering alone into what could be a killing ground. He has selected two back-ups from his multitudinous contacts, and gets them into posi-



tion several hours before the time of the meet. The back-ups are a brother/sister team named Waldrin and Melana.

**Waldrin:** AC 7; MV 12; F6; hp 35; #AT 1; Dmg by weapon (light crossbow (1-4), short sword (1-6)); Str 13, Dex 15, Con 13, Int 12, Wis 10, Cha 11; AL N; THACO 15. He wears studded leather armor and is equipped with light crossbow (12 bolts) and short sword. Waldrin is specialized with the light crossbow, and so fires once per round.

**Melana:** AC 7; MV 12; F7; hp 44; #AT 3/2; Dmg by weapon (heavy crossbow (2-5), short sword (1-6)); Str 14, Dex 12, Con 12, Int 13, Wis 10, Cha 13; AL N; THACO 14. She wears studded leather armor and is equipped with heavy crossbow and short sword. Melana is specialized with the heavy crossbow, and so fires once per round.

Betz has issued these two a *potion of invisibility* each, and has ordered them to hide on one of the ledges overlooking Lake Bral (these can be reached by stairways leading down from the graveyard). Invisibly, the two archers are to sneak back up the stairway at midnight and take up positions to cover Betz when he arrives. They have orders not to kill the PCs unless there's no other option. Their duty is simply to disrupt any ambush that the PCs might be laying, and to give Betz a chance to escape. (If the PCs capture either Bowman, they'll be able to learn details of this order. This should set their minds to rest that no ambush was intended.)

Betz plans to arrive several minutes late for the meet. He expects the PCs to have the gates to the graveyard covered, so he enters the area by another route: over the southeast wall where it stops at the cliff over Lake Bral. As an additional precaution, Betz uses a *ring of invisibility* to cover his movements. When he locates the PCs, he removes the ring and greets them. Should the meet be a trap, Betz will don his ring and escape while his "hired bows" cover him.

When Betz has announced himself to the PCs, he will quickly tell them what's going on.

Betz talks quickly, but you hear a ring of truth in his words. "The assassins did not come from me," he tells you. "As I said in the letter, I have no animosity toward you. The business with the package was just that: busi-

ness. Where is my profit in hunting you down now? This is the truth."

If the PCs ask who sent the killers, read the following:

"Of course I know who sent them," Betz snorts. "It was Cain. You know the name? Cain the pirate, Cain the assassin. I believe you recently destroyed a ship belonging to the Tenth Pit, correct? The Pit hired Cain to eliminate you. And Cain, cunning one that he is, decided to eliminate me as well, through you. That is the extent of my involvement in all of this."

Betz has said all he wants to say, and now tries to leave. If the PCs try to detain him by force, he dons his ring and calls for covering fire from his bowmen. If the PCs ask him where they can find Cain, however, read the following:

"Cain?" Betz says over his shoulder. "You can find him at the Barre Sinister. Where else? Ask at the docks. Someone will tell you."

And with that Betz takes his leave.

The PCs have never heard of the Barre Sinister before, but others have. Through judicious questioning of the dock's low-life scum and the distribution of hard cash, the PCs can find out some details. (This is a great opportunity for role-playing.)

The Barre Sinister is a "pirates' bar": an establishment that caters almost exclusively to the "wolves of the spaceways." It is located on a tiny asteroid in an out-of-the-way system, and is a good place to hire a crack crew of seasoned sailors, if you think you can trust them. It's also a very good place to get killed if your motives aren't what you say they are. The PCs can confirm that Cain is a frequent patron of the Barre Sinister.

The existence of the bar is well-known to law enforcement agencies in many shells. There's nothing against the law about running a bar, but its clientele demand the attentions of the law. A full-scale raid would lead to too much bloodshed, much of it on the side of the law enforcement agencies. Also, if the bar were shut down, the pirates would find another haunt, maybe one that the law enforcement agencies knew nothing

about. At least now they can keep an eye on the comings and goings of some pirates. For these reasons, the Barre Sinister is left to its own devices.

## The Barre Sinister

The Barre Sinister is a small, two-story building located on a tiny asteroid no more than 300 feet in diameter. The building is ugly, built from rough-dressed blocks of asteroid stone. It has no windows and only two doors. A *continual light* spell illuminates a sign on its roof that reads "Barre Sinister." Docks extend from the asteroid along the gravity plane, to which 1-4 ships are tied. When the PCs approach the Barre Sinister, Cain's black-painted Hammership—the *Rampage*—is moored here. His crew is all aboard; only Cain is ashore, negotiating with a representative of the Long Fangs. The *Rampage* is ready to get underway at a moment's notice.

The building is lit throughout by small disks of metal mounted in the ceiling, *continual light* cast on each. The ceilings are 10 feet high unless otherwise stated. Refer to the map on the inside cover.

## First Floor

### 1. Barroom.

The room is surprisingly clean. The tables bear the usual carved initials, but the long bar itself is unmarked. To either side of the large double doors are enclosed booths for more private conversation. The curtains that close these booths are backed with light chain mail (only the best for the Barre Sinister's customers). This gives the occupants a -4 bonus to AC against any swords thrust or projectiles shot through the curtains.

Behind the bar stands the co-owner/operator of the Barre Sinister. No one knows his real name; everyone just calls him "Raven."

**Raven:** AC 6; MV 12; F8/W5; hp 51; #AT 3/2; Dmg by weapon (club (1-6)) or spell; Str 15, Dex 13, Con 13, Int 16, Wis 11, Cha 12; spells: *cantrip*, *magic missile*, *shield*, *wall of fog*; *web* (x2); *Melf's minute meteors*; AL N(E); THACO 13. He is a tall, well-muscled half-elf with a wicked scar down one cheek. He wears a *ring of protection* +4 and a *ring of human influence*, and he carries a *wand of magic missiles* (32 charges). Beneath the bar is a club. Raven won't put up with any trouble in his bar, and he'll be quite willing to kill if

that's the best way to stop it. Everyone knows this, and so there are no brawls in the Barre Sinister. (The docks and the rest of the asteroid are another matter altogether.)

Cain and a half-orc named Barabas are in discussion at a table near the bar.

**Cain:** AC 2; MV 12; F13; hp 95; #AT 2; Dmg by weapon (long sword (1-8), wheel lock pistol (1-4)); Str 14, Dex 12, Con 16, Int 13, Wis 13, Cha 15; AL NE; THAC0 8. Cain is a tall, slender man who always dresses in tight-fitting black leathers, usually with a red bandanna at his throat. His most memorable features are his cold grey eyes. He wears *bracers of defense* AC2 and carries a *long sword* +2 and two wheel lock pistols (ammunition for a total of 8 shots).

**Barabas:** AC 7; MV 12; F6; hp 31; #AT 3/2; Dmg by weapon (bastard sword (1-8/2-8)) +1 Str bonus; Str 17, Dex 12, Con 16, Int 12, Wis 10, Cha 10; AL NE; THAC0 14. Barabas is a powerfully-built half-orc wearing studded leather armor and packing a bastard sword, with which he has specialization.

Unless they are well disguised, Cain will recognize the PCs immediately when they enter the barroom. He will yell "Cover me!" to Barabas and make a break for the door. Barabas will do his best to cover his escape, but won't give his life for Cain. Cain knows the fate awaiting him if he's captured; if he can't escape, he'll fight to the death.

Although Raven doesn't care one way or another what happens to Cain, he'll certainly get in the act if it looks as though a fight is going to break out. Although there are no other members of Cain's crew present, there are a number of other sailors in the bar, and they definitely know who Cain is. If they think that they can overpower the PCs, the other sailors will get into the fray; if the PCs look too tough, they'll just stay put and watch.

There are 12 other sailors in the barroom. Four of them are officers, while eight are crew.

**Officer (x4):** AC 10; MV 12; F4; hp 20, 23, 29, 30; #AT 1; Dmg by weapon (short sword (1-6), dagger (1-4)); AL N(E); THAC0 17.

**Crew (x8):** AC 10; MV 12; F2; hp 6, 6, 7, 7, 9, 12, 14, 15; #AT 1; Dmg by weapon (short sword, dagger); AL N(E); THAC0 19.

It's likely that the PCs have entered the bar alone, without the rest of their

crew. If they do bring along the crew, however, then the whole thing looks like a raid and everyone will react as such. Each of the 1-4 nondescript ships moored at the docks will be manned by 3 officers and 7 crew, who will have the statistics above. When they see the raid, they will leave their ships and engage the PCs' crew.

Cain's ship, the *Rampage* is also moored at the docks. His crew is described in detail in the section "The *Rampage*." They too will join the fray. (If this happens, the PCs will probably be in serious trouble.)

## 2. Storage Room.

There are boxes of earthenware plates and mugs stacked under the staircase. Some ropes hang on the wall.

## 3. Kitchen.

Links of disreputable-looking sausages and ropes of spices hang from the ceiling. A rancid-smelling stew bubbles in a cauldron over the fire. The room is occupied by a young cook. Although her clothes are dirty and her hair matted, she is very beautiful.

**Cook:** AC 10; MV 12; 0-level; hp 3; #AT 1; Dmg by weapon (knife (1-3)); AL N; THAC0 20. The girl will be terrified of anyone who bursts in . . . but not too terrified to snatch up a kitchen knife and defend herself if necessary.

## 4. Pantry.

This is where the bar's food stocks and beer supplies are stored. There are three large tuns of ale, plus boxes and sacks of foodstuffs.

## Second Floor

### 5. Cook's Room.

The room contains a cot and a wardrobe. The clothes in the wardrobe are of poor quality. The room looks as though it hasn't been used much recently. The room is unoccupied.

### 6. Meeting Room.

Occasionally, Raven must meet with important representatives of various concerns. It is partially the results of these meetings that have let him stay in business. The room contains a large table and six straight-backed chairs. Against one wall is a sideboard containing 10 crystal glasses (each worth 25 gp). Atop it is a decanter of fine brandy; the

decanter is worth 50 gp, the brandy 150 gp. The room is unoccupied.

### 7. Raven's Study.

The walls are lined with bookshelves. There is a locked desk in one corner, on which Raven has cast the spell *alarm*. The upper locked drawer contains bar records. The lower drawer's lock is protected by a poison needle trap (3-30 points of damage; save vs. poison for half damage). Inside are some of Raven's bar receipts (the rest are stashed off the asteroid): 27 pp, 250 gp. The drawer also contains Raven's spell book (*alarm*, *cantrip*, *magic missile*, *shield*, *Tenser's floating disc*, *wall of fog*; *flaming sphere*, *stinking cloud*, *web (x2)*; *Melf's minute meteors*). The room is unoccupied.

### 8. Dressing Room/Antechamber.

One wall is totally taken up by a large mirror. The other walls are taken up by wardrobes. The clothes inside are of fine quality. The room is unoccupied.

### 9. Raven's Room.

The decor is surprisingly opulent, considering the locale. There are fine carpets on the floor and the dark stone walls are covered with tapestries. The bed is large and very comfortable. There are hints of feminine presence (pots of makeup on the dresser and a silk nightgown on the bed). The room is unoccupied.

## Escape!

Cain knows his way around the Barre Sinister, and will use that knowledge to escape from the PCs. His goal is to get out of the building and back to his ship. If Cain gets back to his ship, he immediately casts off and tries to put some distance between him and the PCs. Should they follow in their ship, he will estimate their strength. If their vessel is too powerful, he'll continue his flight; otherwise, he'll turn and attack.

## The Rampage

The *Rampage* is a standard-configuration Hammership. No modifications have been made to the deck plans, the hull or the rigging. Cain has added some additional weaponry, however. The *Rampage's* total firepower comprises the standard weaponry for a Hammership but includes two bombards



(crew 3), each placed on opposite sides of the main deck. The ship has 60 hull points, and an SR of 5. It is equipped with a major helm. The magazine contains enough powder and shot for 20 bombard rounds. For deck plans, refer to the "Hammership" card found in the SPELLJAMMER™ boxed set.

## The Crew

Cain's second-in-command is a huge powerful human named Tront, while his spelljamming mage is a female half-elf named Elana. His crew of 45 is filled out by 42 crack human sailors.

**Tront:** AC 5; MV 9; F9; hp 66; #AT 3/2; Dmg by weapon (two-handed sword (1-10), dagger (1-4)) +6 Str bonus; Str 18(00), Dex 12, Con 17, Int 12, Wis 8, Cha 13; AL N(E); THAC0 9. He wears chain mail and carries a two-handed sword.

**Elana:** AC 10; MV 12; W10; hp 23; #AT 1; Dmg by weapon (dagger (1-4)); Str 10, Dex 11, Con 9, Int 16, Wis 12, Cha 12; spells: none; AL N(E); THAC0 17. Elana wears no armor and carries only a dagger. Because of spelljamming after-effects, she has no spells. She will not leave the helm unless she's forced to.

**Crew (x42):** AC 8; MV 12; F2; hp 2-20; #AT 1; Dmg by weapon (long sword (1-8), wheel lock pistol (1-4) or light crossbow (1-4), dagger (1-4)); AL LN(E); THAC0 19. The crewmen all wear studded leather armor. Ten are armed with wheel lock pistols (4 shots each) and daggers; fifteen are armed with light crossbows and daggers; the rest carry long swords and daggers.

## Tactics

Cain is a skilled and experienced captain, so he will use his ship and weapons with top efficiency. He trusts his crew's abilities when it comes to boarding actions, so he will definitely ram, grapple, and board a smaller ship. If the PCs have a larger vessel, he will use his ranged weapons to attempt to cripple them before boarding. If the fight looks as though it's going against him, he'll cut and run.

Cain's crew have a morale of 14. They are loyal to their captain, but won't die for him. Cain knows this and accepts it. He also knows that capture will lead to imprisonment (definitely) and execution (eventually), neither of which particu-

larly entice him. For himself, then, he prefers death to capture.

If his ship has been boarded and it looks as though all is lost, Cain will go to the magazine and strike a light, detonating the powder. In addition to killing him, this will inflict 2d10 hull points of damage to the *Rampage*. Anyone within 20' of the magazine in the cargo hold must save vs. magic or suffer 2-20 points of damage from concussion and heat.

Since Cain was "between engagements," the *Rampage* has little booty aboard it. Cain's personal treasure, locked in a poison-needle trapped chest in his cabin, comprises 20 pp, 250 gp, five rubies (1,000 gp value each), a diamond-studded circlet (3,500 gp), a scroll (*restore air*), a bag containing 55 copper "octons," and a map. This map is a "wild-card," pointing the PCs in the direction of anything the DM wants them to find.



In addition to Cain's private stash, Elana's spell book is cached beneath the ship's helm. It contains all spells of first and second level, plus the following spells: *blink*, *clairaudience*, *clairvoyance*, *fireball*, *haste*, *hold person*, *illusionary script*, *item*, *lightning bolt*, *monster summoning I*, *slow*; *detect scrying*, *enervation*, *fear*, *fumble*, *minor creation*, *polymorph self*, *rainbow pattern*, *shout*, *wizard eye*; *animate dead*, *dismissal*, *fabricate*, *monster summoning III*, *teleport*.

## Concluding the Adventure

If Cain manages to escape, he will be an implacable adversary for the PCs. Whenever the opportunity arises, vengeance against the PCs will be his highest priority. (Thus Cain can become a good ongoing nemesis.)

If the PCs are victorious, they can collect the bounty for Cain's destruction from the Pots. (At this time, Prince Andru—still irked with the PCs for their actions in "X"—will revoke their letters of marque.)

They might consider Torgan Betz to be unfinished business, but he has dropped out of sight. (He can certainly return in later adventures either as an adversary or an ally.)

The Tenth Pit will certainly hear of the PCs' success, and will put some plans in motion to remove them from the scene. These plans can be the basis for many future adventures.

The Barre Sinister can provide an interesting environment for the PCs to pick up information and generate adventures.

If Cain defeats the PCs, he won't kill them immediately. Although that was his original intention, now he's thought of something better. He secures them in the hold, and sets sail for a nearby outpost owned by the Tenth Pit. The fate that awaits the PCs there is best not dwelt upon. The voyage and the eventual disembarking represent chances for the PCs to escape. (If this unfortunate turn of events should happen, the DM can opt to create a longer adventure dealing with the Tenth Pit and Cain. If a conclusion is needed, the PCs can be rescued from Cain by another ship recruited by the "Pots." Regardless of the course of action, this signals the end of the PCs' careers as bounty hunters.)

# Space Drake

Climate/Terrain:	Any space
Frequency:	Very rare
Organization:	Solitary or pack
Active Cycle:	Any
Diet:	Omnivore
Intelligence:	Semi (2-4)
Treasure:	I
Alignment:	N(E)

No. Appearing:	1 (2-5)
Armor Class:	2
Movement:	12, Fl 30 (C)
Hit Dice:	10
THACO:	11
No. of Attacks:	2 + special
Damage/Attacks:	2-16/1-12 (bite/tail)
Special Attacks:	Breath weapon, magic use, constriction
Special Defenses:	Nil
Magic Resistance:	30%
Size:	G (50')
Morale:	Champion (16)
XP Value:	8,000

The space drake resembles the radiant dragon, but without wings. It has the same glittering pearl-like scales, and the same serpentine body, albeit on a smaller scale. The space drake has a dorsal fin which extends along its head and neck.

All common dragon attributes outlined in the *Monstrous Compendium* apply to space drakes as well. Modifications to the general description that apply specifically to fantasy space are listed below.

**Combat:** Physical attacks comprise a bite and a smash from the drake's sinuous tail. If the tail smash hits, the drake can constrict the target, inflicting 1-10 points on each subsequent round (no 'to hit' roll required). The drake will maintain the constriction until the victim is dead, or until the space drake receives 10 or more points of damage in a single round from another character. When this happens, it decides that the other character is more dangerous, releases the constriction victim, and tries for a tail smash against the new target on the next round. While being constricted, a character's attacks are at -3 and no spellcasting is possible. The space drake is so flexible that it can bite and tail-smash the same target on the same round.

In addition to its physical attacks, the space drake has a breath weapon similar to that of the radiant dragon: glowing pulses of force similar to *magic missiles*. It can breathe a single pulse that inflicts 6d6 points of damage, or up to six smaller pulses in the same round. (Thus they can breathe two pulses, each inflicting 3d6 points, or six, each inflicting 1d6.) Each pulse can strike a separate target. These pulses are unerring, and will hit unless the victim makes a saving throw vs. breath weapon. If the victim fails its saving throw, it is struck for the appropriate amount of damage. If the victim makes its saving throw, it has dodged that pulse, which then evaporates. The space drake can use its breath weapon on physical

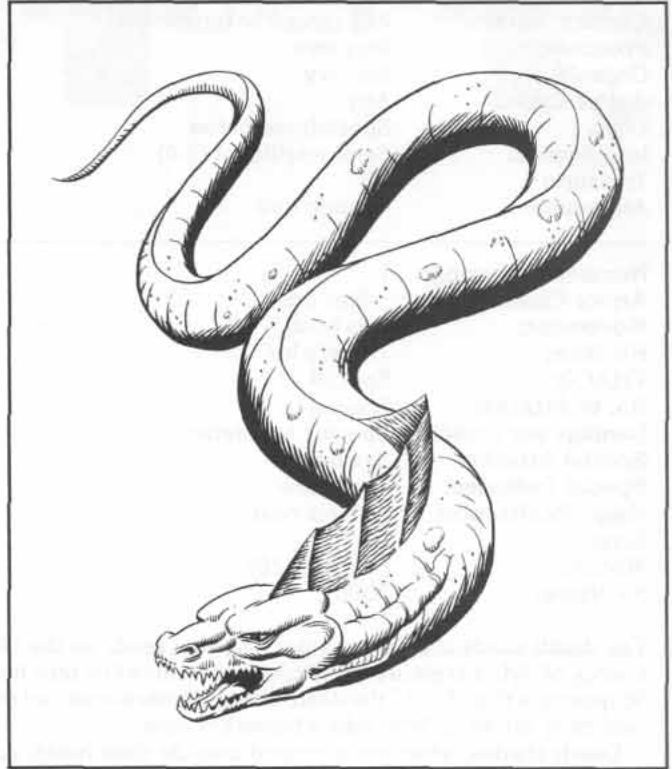

objects (such as a ship) as well, inflicting 1 hull point of damage for every 10 hit points of damage its breath weapon causes. Other physical objects must save vs. spell to survive being hit by a pulse.

Space drakes also have some innate magical powers. They can use the following spell-like abilities twice per day, one per round, at the 10th level of ability: *restore air*, *detect portal*, *light*.

Despite their lack of wings, space drakes fly using a natural flight/spelljamming ability. In combat, space drakes prefer to be in flight; on ground, they are limited to bite and breath weapons.

**Habitat/Society:** Space drakes are totally spaceborne. Like radiant dragons, they are normally solitary and very territorial about their "turf," which is often the space surrounding a hollowed-out asteroid or deserted dwarven citadel. When they are found in numbers, they are usually a family group, and make their lair in abandoned hulks, etc. In general, their society is an unintelligent echo of their brethren, the radiant dragon.

**Ecology:** Space drakes are omnivorous in the truest sense of the word: they will eat anything. This includes plant matter, rocks and space dust, although they do seem to prefer meat (and meat that's still kicking, at that).

Although space drakes are capable of living in the phlogiston, they don't seem to enjoy it, and are rarely found there.

# Death Shade

Climate/Terrain:	Any (space or terrestrial)
Frequency:	Very rare
Organization:	Solitary
Active Cycle:	Any
Diet:	Special; see below
Intelligence:	Semi-intelligent (2-4)
Treasure:	Nil
Alignment:	Chaotic Evil

Number Appearing:	1
Armor Class:	-8/as host
Movement:	9/as host
Hit Dice:	7/host's hp
THACO:	Special
No. of Attacks:	Special
Damage per Attack:	Special; Infestation
Special Attacks:	See below
Special Defenses:	See below
Magic Resistance:	75%/as host
Size:	n/a
Morale:	Fearless (20)
XP Value:	2000

The death shade is an energy parasite that feeds on the life energy of dying creatures (any creature reduced to zero hp). To generate this "food," the death shade infests a host and periodically drives its host into a berserker rage.

Death shades, when encountered outside their hosts, appear as small, shifting wisps of smoke with vague outlines of avian eyes. When infesting a host, the death shade is invisible, having entered another body. Persons and objects capable of viewing invisible creatures see the death shade as a gray mist which centers on the host's eyes. Under alignment detection, the death shade appears as a black "blight" on the host's alignment.

**Combat:** The death shade absorbs 1 energy level for every hit die of an opponent killed within a 10' radius, and can store up to 40 energy levels at one time. The death shade consumes these energy levels at a rate of 1 per day. For every stored energy level less than 40, there is a 3% cumulative chance per day that the death shade will cause its host to go berserk, killing the first available target. If numerous targets are presented, the death shade directs its host to pursue and attack the target which offers the least potential harm to its host. The host's rage ends after 40 energy levels have been absorbed by the death shade or no victims remain.

Death shades are rarely encountered without a host. Death shades prefer hosts which provide the greatest amount of food for it, i.e. a strong host like a fighter or a large carnivore, but will accept any host for its own survival. Death shades do not leave a host unless the host has been killed. If a PC becomes infested with a death shade, only a *wish* or *limited wish* can remove it from the PC's body. *Amulets of Life Protection* are the only items which prevent death shade infestation.

If the creature's current host is killed, it transfers out of the host body, infesting the strongest creature within 20 feet, and this creature becomes its new host. If it's unable to make such a transfer within 5 rounds of its host's death, the death shade dies. During this time of transfer, it can be attacked with normal weapons or spells.

The death shade and its host become catatonic when stored energy levels are at zero. The host and shade may remain catatonic for as many days as the host has Con points;

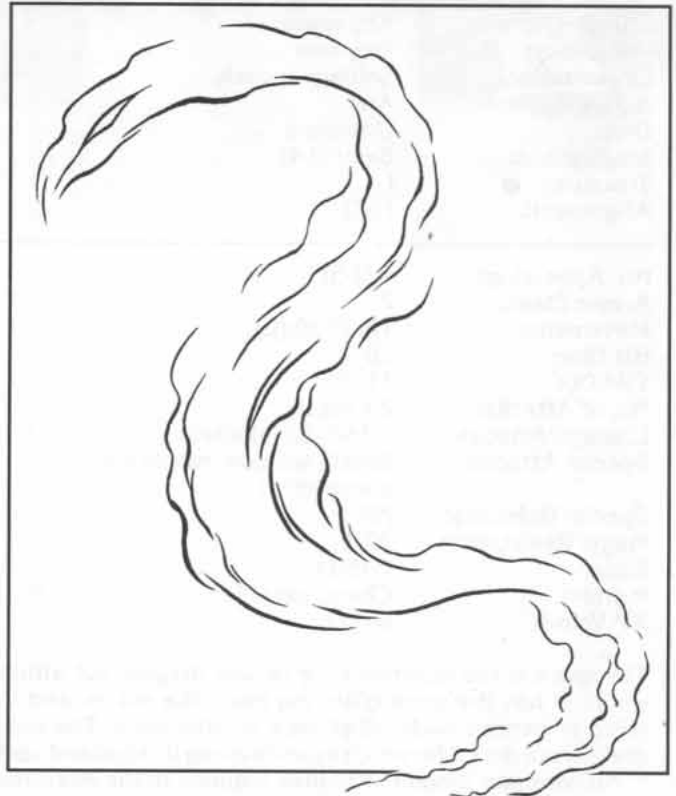

after that, both host and shade die. If a lifeform comes within 10 feet of a catatonic host, the death shade rouses the host in 1d3 rounds in a berserk rage to kill the creature for its energy. After the rage subsides, the host must make a save vs. paralyzation or have permanent brain damage (subtract 1d3 points from the host's Intelligence).

**Habitat/Society:** Death shades can infest any corporeal, carbon-based life form, from small rodents to humans or demihumans, all the way up to celestial dragons. Creatures based of another elemental structure (storopers or magmen, for example) are immune to death shade infestation. Death shades can generate berserker rage no matter what the species of their host (therefore they can turn even the most timid creature into a raging killer).

**Ecology:** The death shade prefers to dwell where there are large concentrations of potential hosts and victims: among large herds of animals, or in the crowds of a city. Some sages believe that many of the senseless murders endemic to the inner city are caused by death shades.

Death shades reproduce as a by-product of feeding. After a death shade has absorbed life force from the death of 40 hit dice or levels of creatures within a 24-hour period, it splits into two death shades with 20 energy levels each. The second shade immediately transfers to any creature within 20'. If it can't make the transfer within 5 rounds, the second death shade dies.

Death shades have a basic telepathy which can only identify the presence of one death shade to another. Thus, death shades can detect each other's presence in a 20 foot radius and, if given a choice of targets during "feeding," will attack an uninfested creature before an infested host body.



# HAMMERSHIP

## The Barracuda

One Square = 5 feet

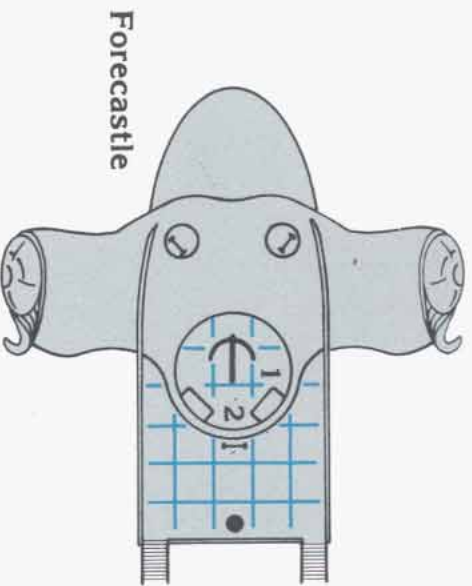

Forecastle



Stern Castle

- Forecastle  
 1 Forward Ballista  
 2 Ballista Shot Storage

- Stern Castle  
 1 Aft Catapult  
 2 Catapult Shot Storage

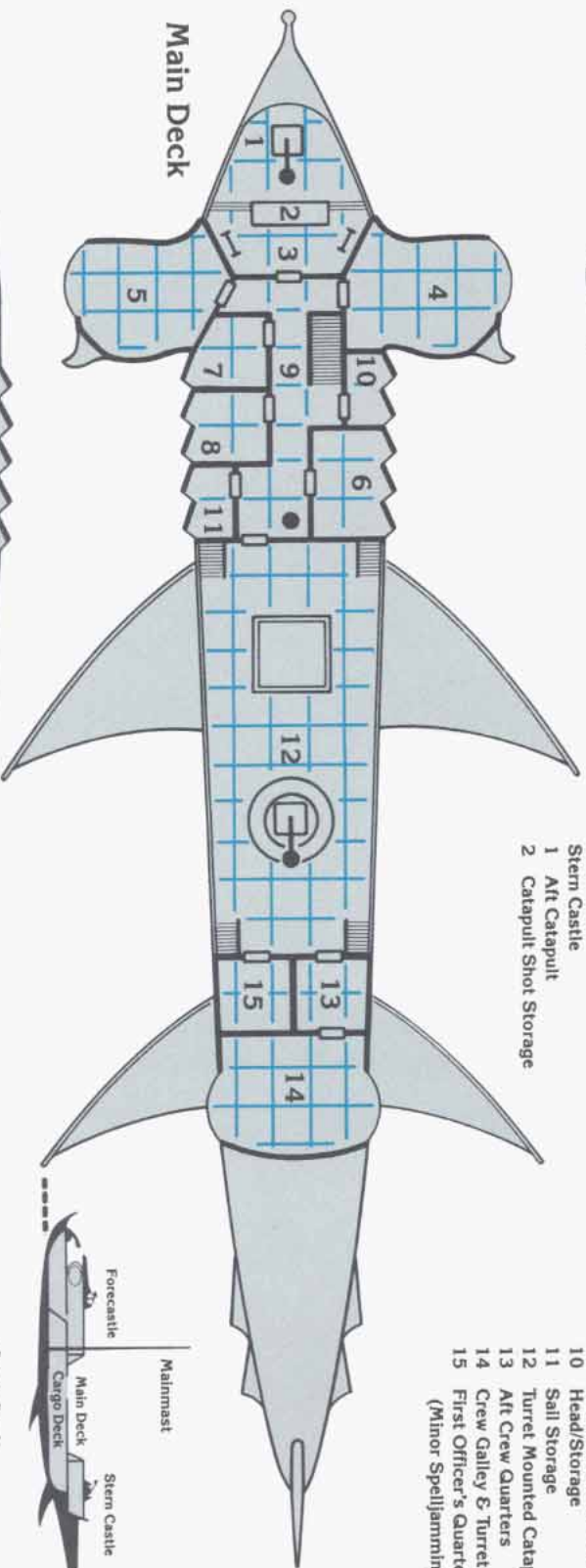

Main Deck

- Main Deck  
 1 Forward Castle  
 2 Catapult Shot Container  
 3 Forward Bridge  
 4 Officers' Saloon  
 5 Galley  
 6 Captain's Cabin  
 7 Officers' Quarters  
 8 Officers' Quarters  
 9 Companionway & Turret Control  
 10 Head/Storage  
 11 Sail Storage  
 12 Turret Mounted Catapult  
 13 Aft Crew Quarters  
 14 Crew Galley & Turret Control  
 15 First Officer's Quarters  
 (Minor Spelljamming Helm)

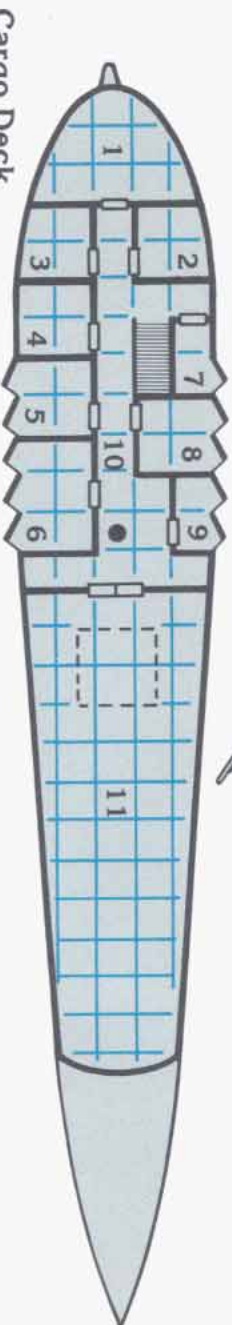

Cargo Deck

- Cargo Deck  
 1 Lower Bridge, Helm, & Chart Room  
 2 Spelljammer Quarters  
 3 Kitchen (Dumbwaiter to Galley above)  
 4 Pantry  
 5 Crew Quarters  
 6 Stateroom  
 7 Head/Storage  
 8 Stateroom  
 9 Bosun's Locker  
 10 Companionway  
 11 Cargo Hold

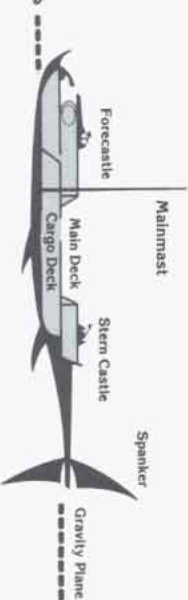

Gravity Plane

# SQUID SHIP

Frostfire

One Square = 5 Feet

- Forecastle
- 1 Mainmast
- Stern Castle
- 1 Mizzenmast
- Cargo Deck
- 1 Spelljamming Helm



Forecastle



Stern Castle

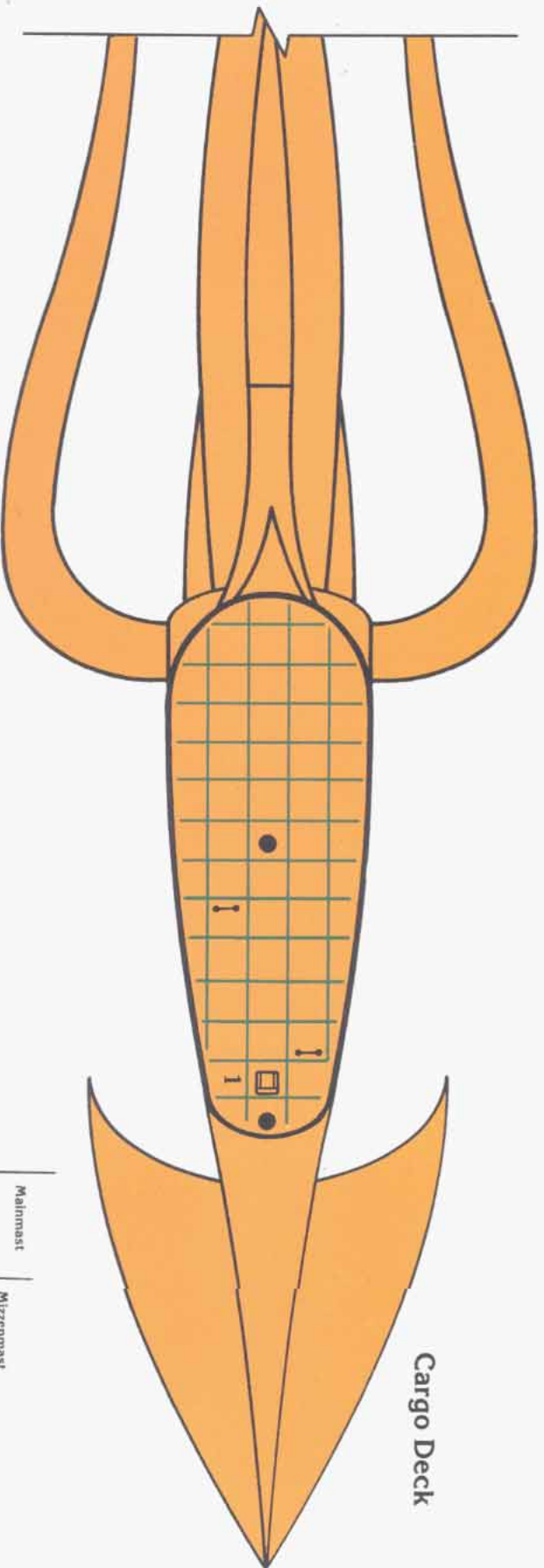

Cargo Deck

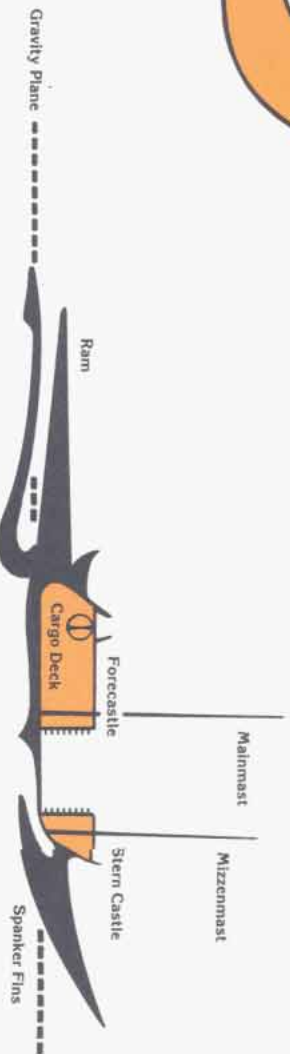

Ran

Forecastle

Mainmast

Mizzenmast

Stern Castle

Spanker Fins

# DRAGONFLY

Terigamar's Research Vessel  
One Square = 5 Feet

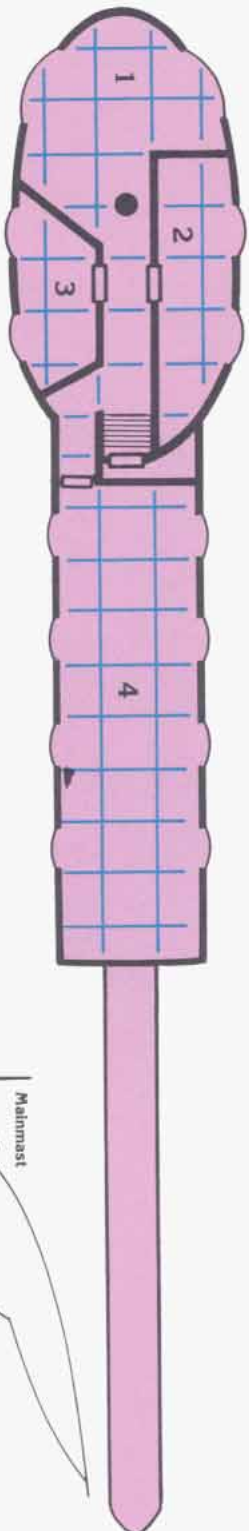
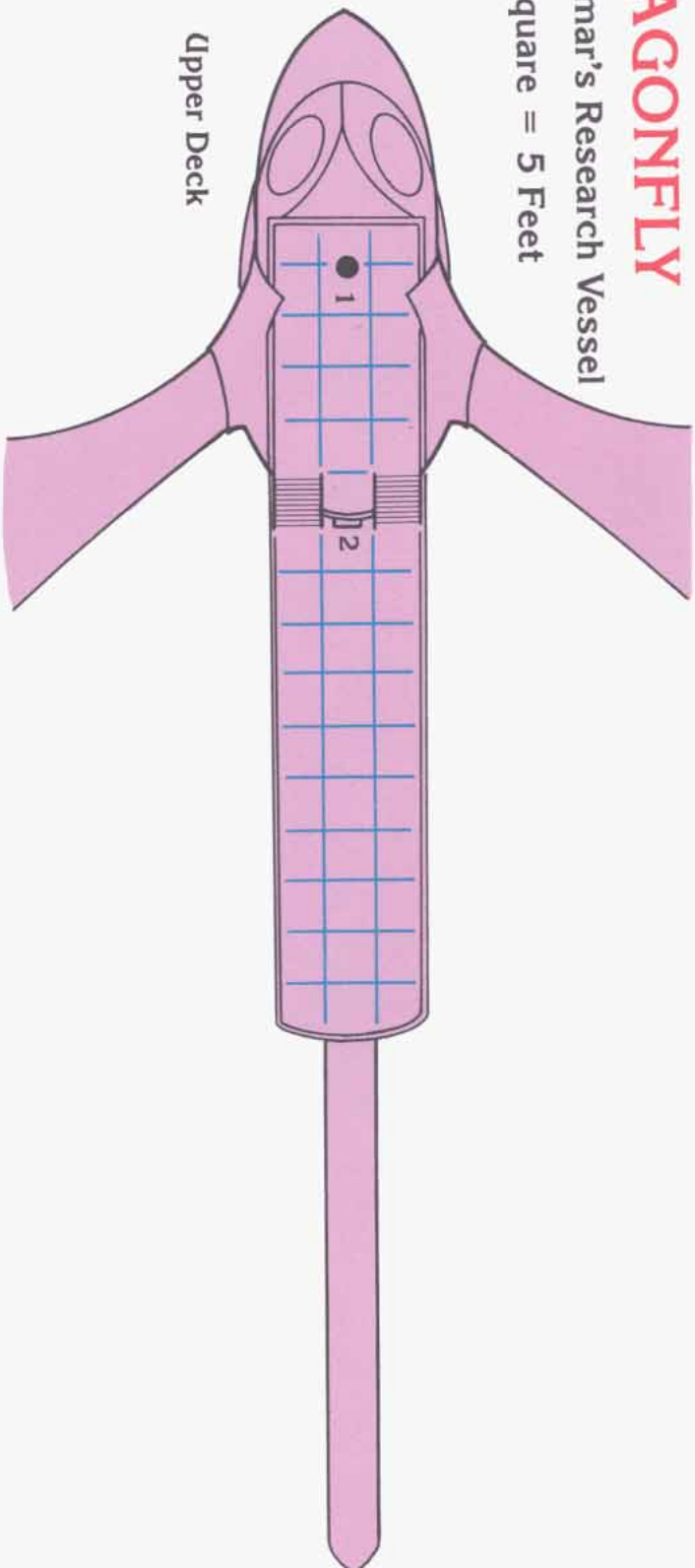

- Upper Deck
- 1 Malmast
  - 2 Door to Lower Deck

- Lower Deck
- 1 Bridge & Spelljamming Helm
  - 2 Captain's Cabin
  - 3 Crew Cabin
  - 4 Laboratory

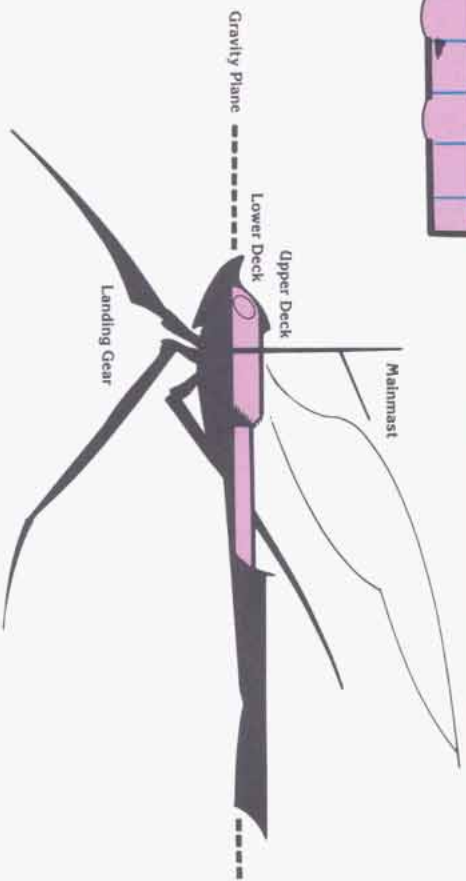



# WASP

## Drow Modified Ship

One Square = 5 Feet

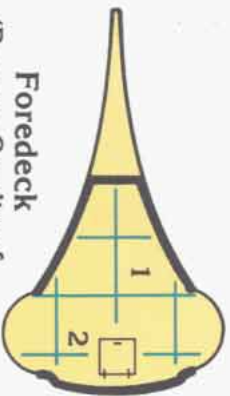
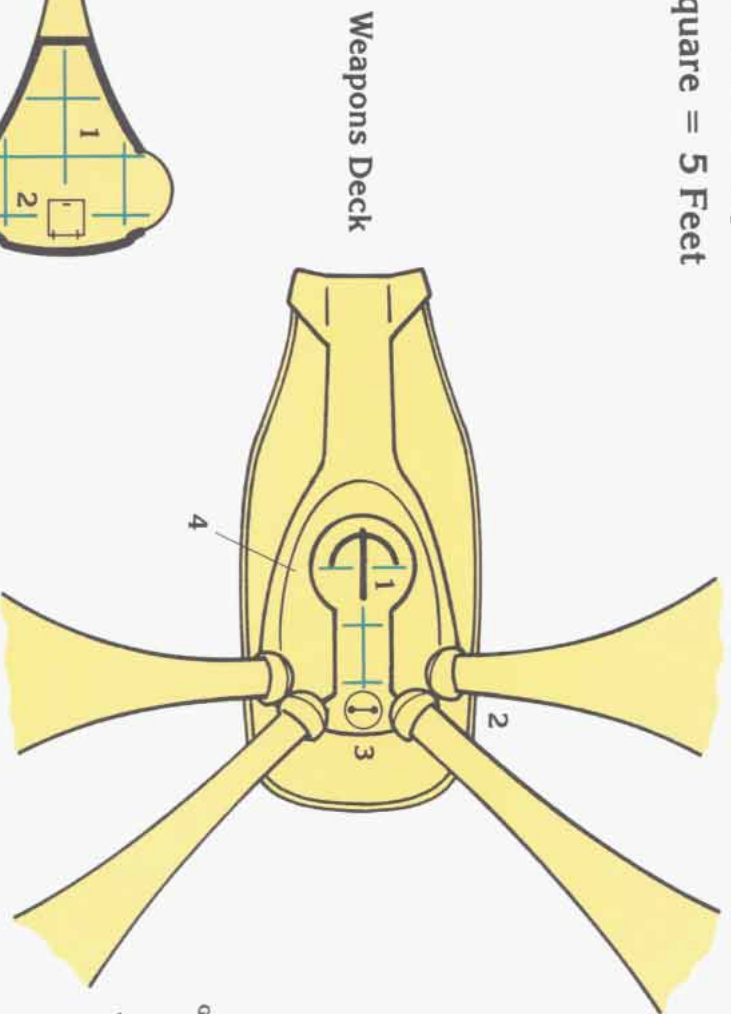

Foredeck  
(Reverse Gravity of  
Upper Decks)

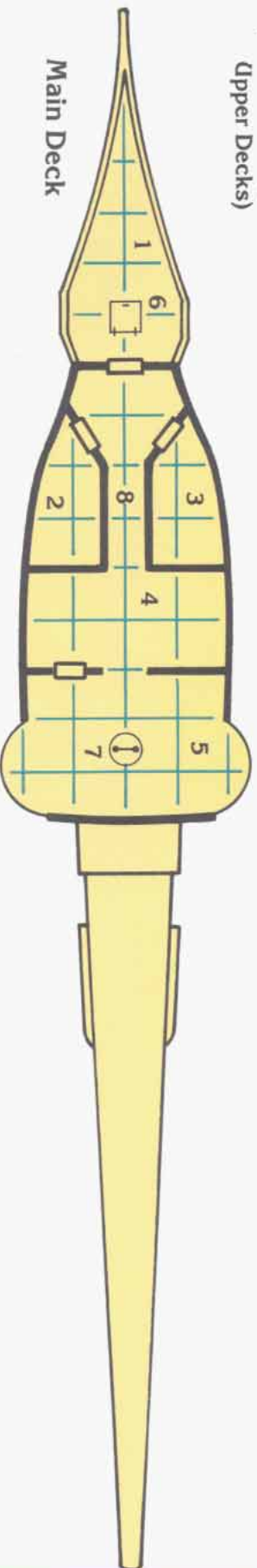

Main Deck

### Weapons Deck

- 1 Ballista
- 2 Wing Stations & Pivots
- 3 Hatch to Main Deck
- 4 Retractable Dome

### Foredeck

- 1 Bridge & Helm
- 2 Hatch to Forward Station

### Main Deck

- 1 Forward Station (Dome Overhead)
- 2 Crew Quarters
- 3 Galley
- 4 Cargo
- 5 Additional Cargo
- 6 Hatch to Foredeck
- 7 Hatch to Weapons Deck
- 8 Companionway

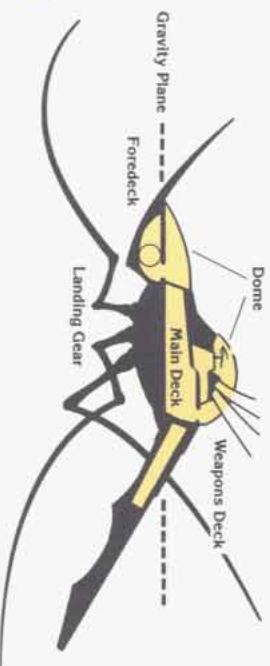

# MINDSPIDER

Collector

One Square = 5 Feet

- Primary Deck
- 1 Spelljamming Helm
  - 2 Chart Room
  - 3 Umber Hulk & Lower Neogi Quarters
  - 4 Captain/Owner's Quarters
  - 5 Open Port to Secondary Deck
  - 6 Ladder to Gunner Platform

- Gunner Platform
- 1 Light Ballista
  - 2 Ladder to Chart Room

- Secondary Deck
- 1 Jettison
  - 2 Prisoners & Cargo Area
  - 3 Hatch to Weapons Pit
  - 4 Open Port to Primary Deck

- Weapons Pit
- 1 Catapults
  - 2 Hatch to Secondary Deck
  - 3 Retractable Dome

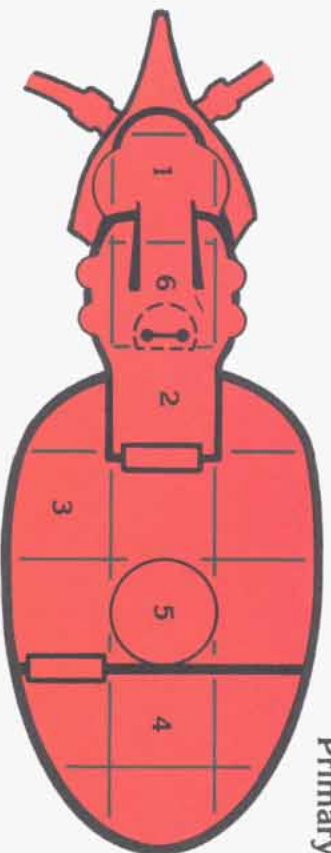

Primary Deck

## Gunner Platform

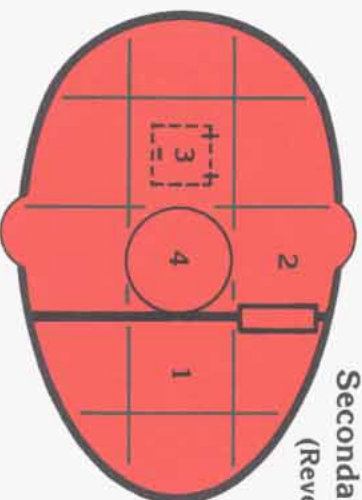

Secondary Deck  
(Reverse Gravity of Upper Decks)

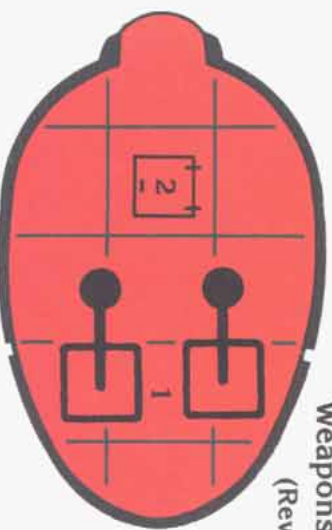

Weapons Pit  
(Reverse Gravity of Upper Decks)

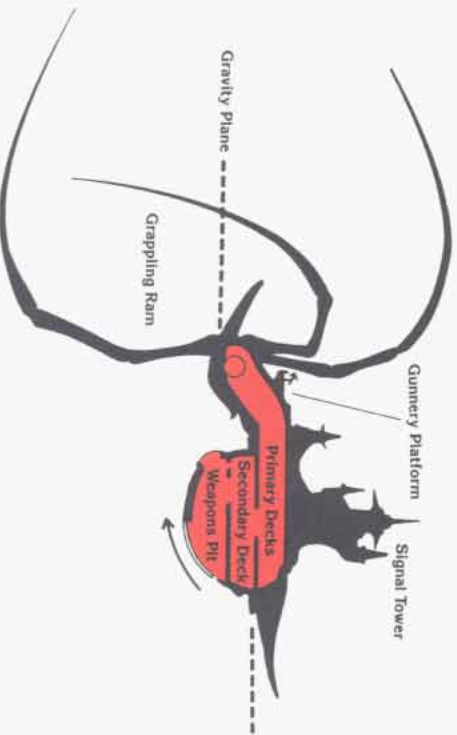

# NAUTILOID

One Square = 5 Feet

Void Reaper

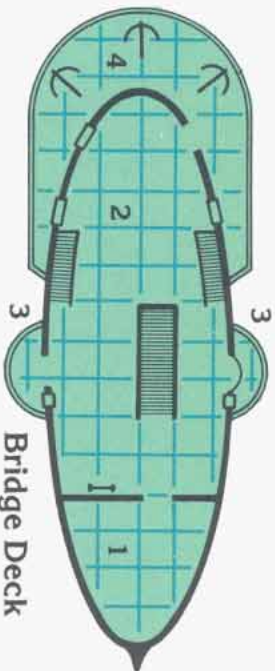

Bridge Deck

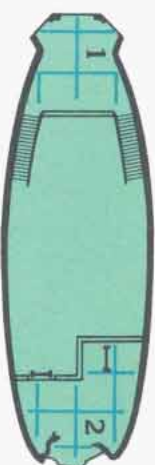

Scout Deck

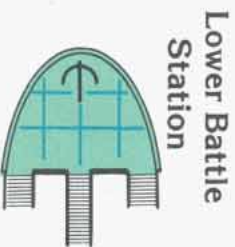

Lower Battle Station

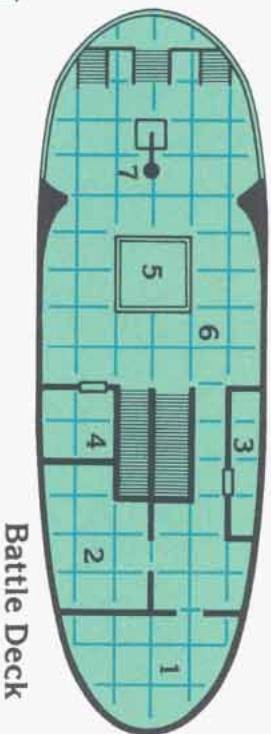

Battle Deck

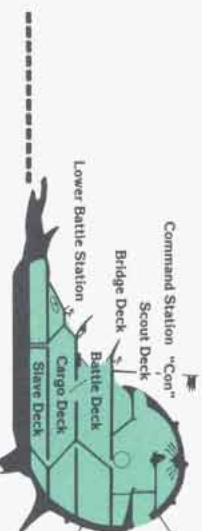

Command Station "Com"



Cargo Deck

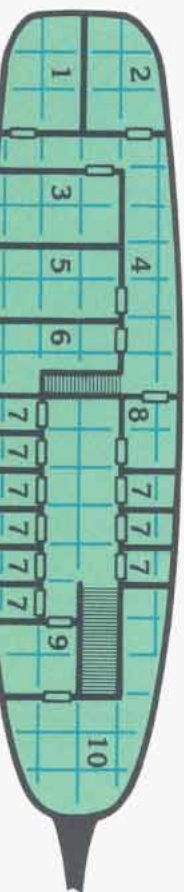

Slave Deck

- Cargo Deck**
- 1 Captain's Cabin
  - 2 Captain's Chart & Treasure Room
  - 3 Crew Quarters
  - 4 Galley
  - 5 Cargo

- Command Station**
- 1 Captain's Chair
  - 2 Captain's Day Room
- Scout Deck**
- 1 Forward Observer
  - 2 Rubble/Hull Breach
- Bridge Deck**
- 1 Main Saloon
  - 2 Bridge Floor
  - 3 Ventral Observers
  - 4 Upper Battle Station

**Slave Deck**

- 1 Stateroom
- 2 Stateroom
- 3 Stateroom
- 4 Passageway
- 5 Stateroom
- 6 Crew Quarters
- 7 Slave Quarters
- 8 Guard Post
- 9 Jettison & Storage
- 10 Jettison & Storage

- Battle Deck**
- 1 Officers' Quarters
  - 2 Sail Storage
  - 3 Chart Room
  - 4 Cargo Bay
  - 5 Assembly Deck
  - 6 Middle Battle Station
  - 7 Middle Battle Station



# DRAKKAR

Raven

One Square = 5 Feet

- Main Deck
- 1 Medium Ballista
  - 2 Mainmast
  - 3 Spelljamming Helm

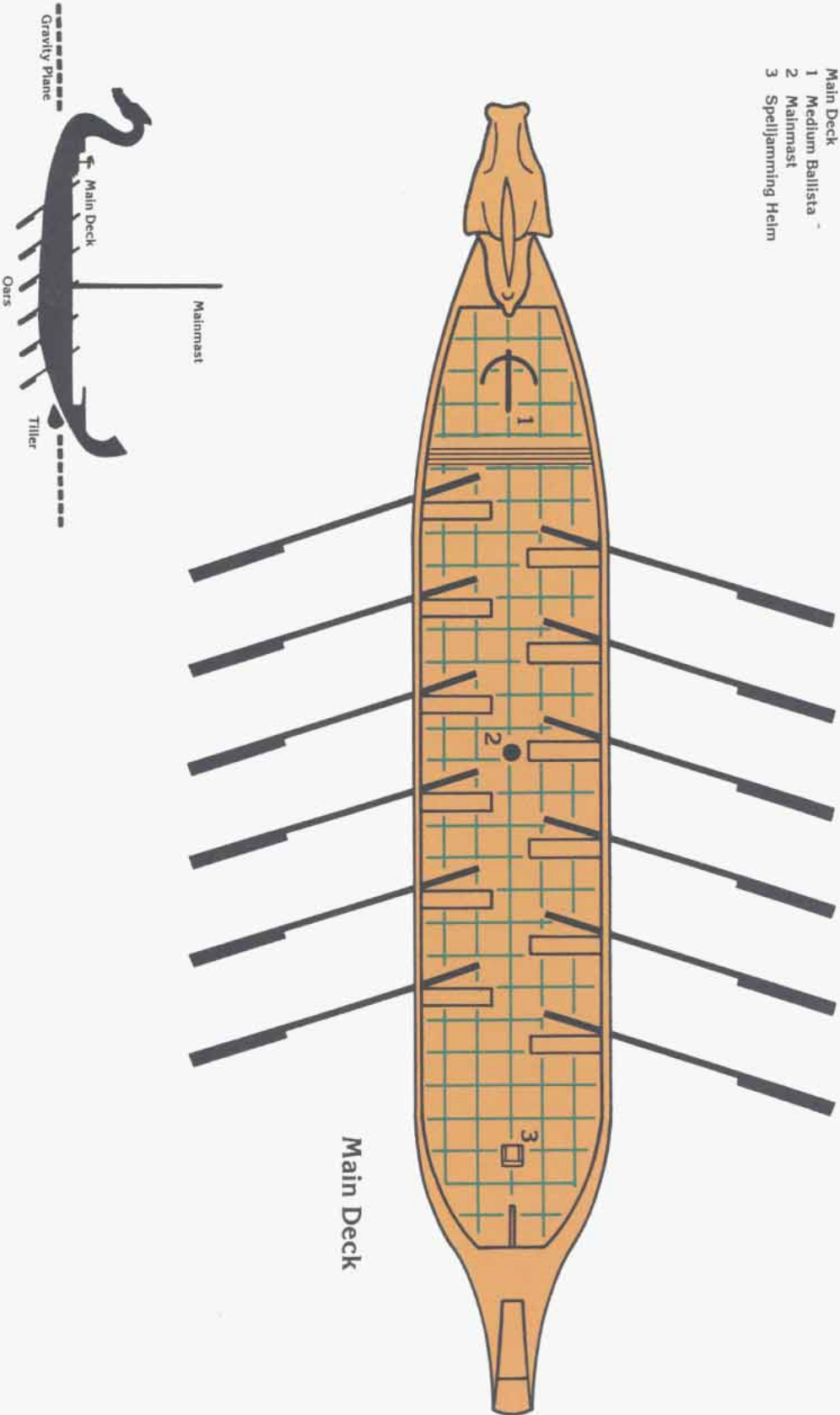

# LEAF SHIP & THORN SHIP

One Square = 5 Feet

Castle Deck 1



Castle Deck  
1 Heavy Catapult/Turret  
2 Catapult Shot Container

- Battle Deck
- 1 Thorn Ship Moorings
  - 2 Forward Ballista Positions (heavy ballistas)
  - 3 To Main Deck
  - 4 Castle Deck Support
  - 5 Stern Ballista Positions (heavy ballista)

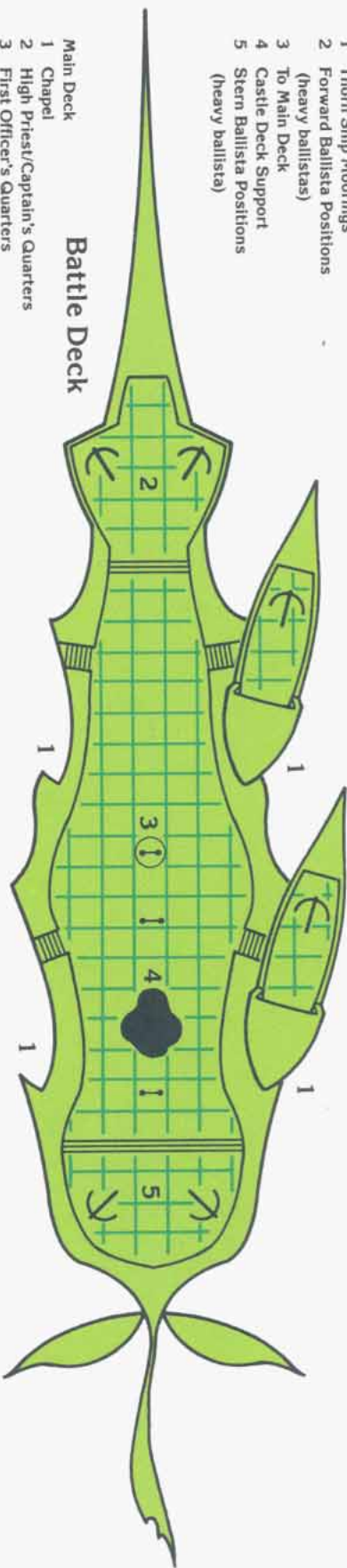

Battle Deck

- Main Deck
- 1 Chapel
  - 2 High Priest/Captain's Quarters
  - 3 First Officer's Quarters
  - 4 Crew Quarters
  - 5 Armory
  - 6 Kitchen
  - 7 Storage/Larder
  - 8 Chart Room
  - 9 Spelljammer's Quarters  
Crystal Throne



Main Deck  
(Reverse Gravity of Upper Decks)



- Thorn Ship
- 1 Light Ballista
  - 2 Crystal Throne
  - 3 Greek Fire Projector

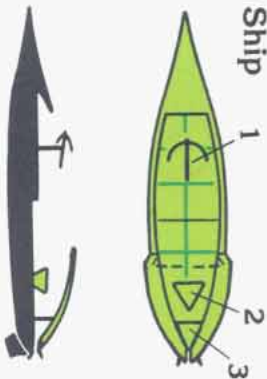

Thorn Ship



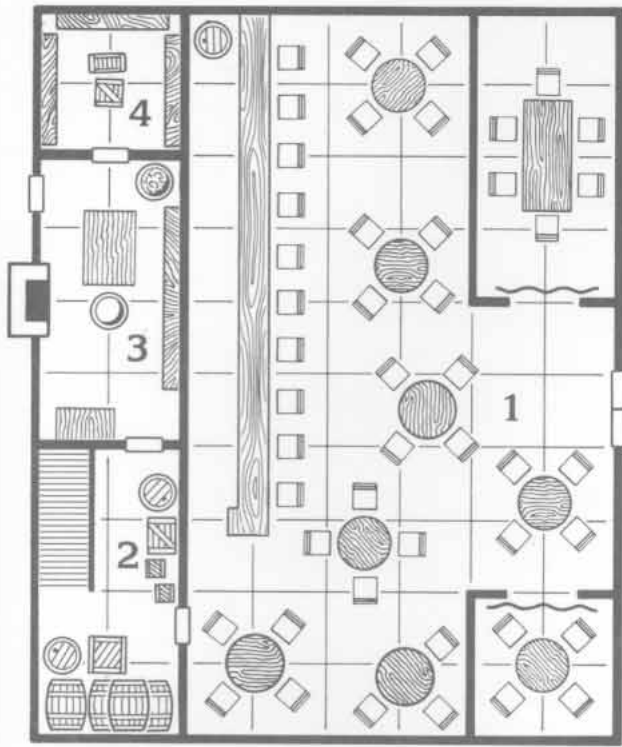

Ground Floor

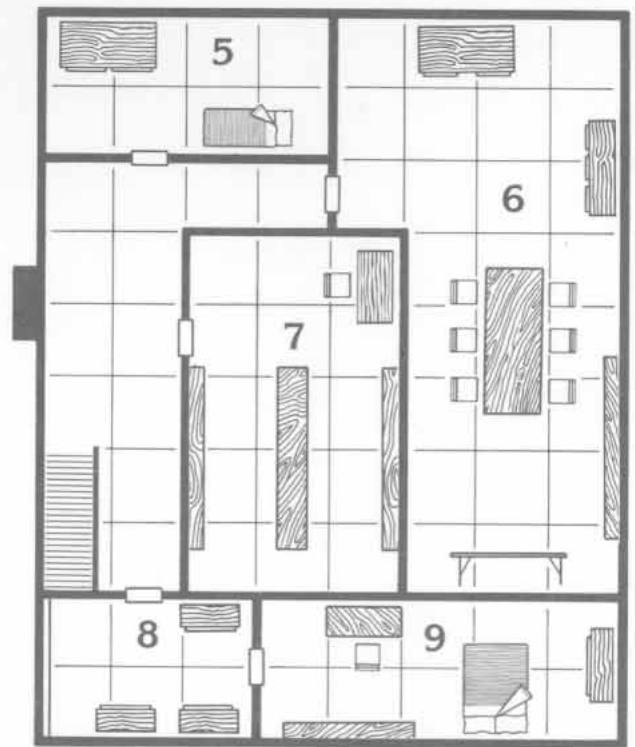

Second Floor

# THE BARRE SINISTER

One Square = 5 Feet

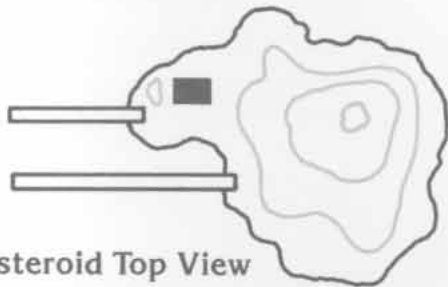

Asteroid Top View



Asteroid Side View

# THE OUTPOST

250'x200'

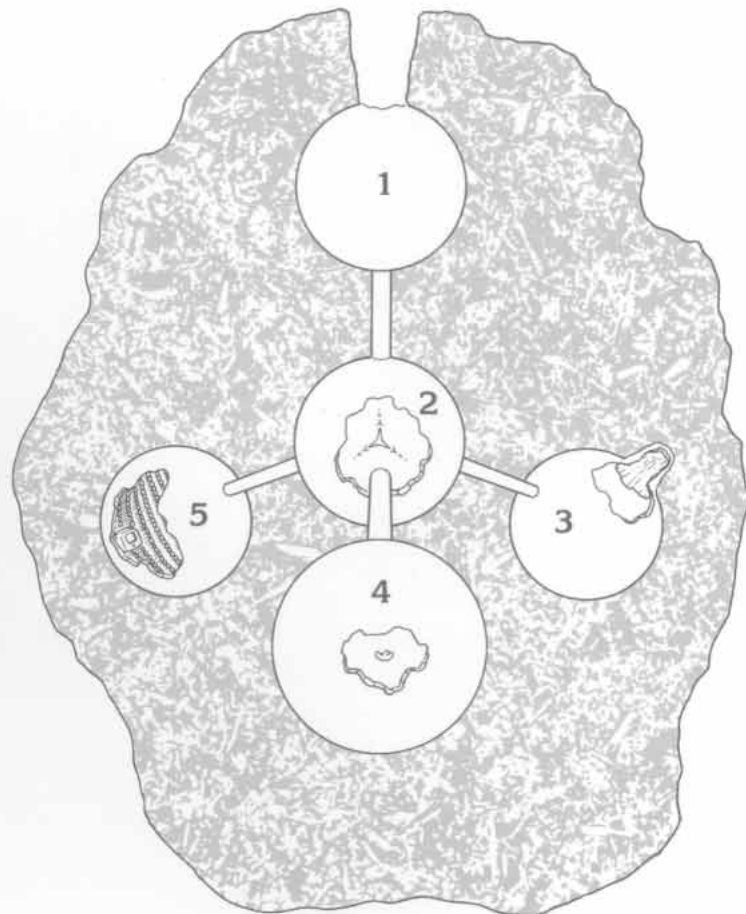



# NPC Summary Table

Name	AC	C/L	hp	Str	Dex	Con	Int	Wis	Cha	THACO	Remarks
Adrin Willowleaf	1	F10	62	13	12	13	13	12	14	11	AL CG; wheel lock pistol, dagger
Barabas	7	F6	31	17	12	16	12	10	10	14	AL NE; bastard sword
Berl Mooncrest	4	F7	27	14	13	11	12	12	13	14	AL CG; long sword, dagger, light crossbow
Berwick	5	F9	71	17	11	16	13	9	15	12	AL N; two-handed sword, hand crossbow
Cain	2	F13	95	14	12	16	13	13	15	8	AL NE; wheel lock pistol, long sword +2
Darla Leafsong	10	W4	9	9	12	12	14	12	12	19	AL LG
Delak Darkcloud	2	P13	48	13	9	10	13	16	11	12	AL CE; hammer
Dorin Twostar	4	F9	46	15	12	14	13	11	14	12	AL LN; wheel lock pistol, long sword +1, dagger
Dourm Larbo	6(2)	HD 4	25	19	10	18	13	9	11	17	AL LE; wheel lock pistol
Elana	10	W10	23	10	11	9	16	12	12	17	AL N(E); dagger
Elowynn Silvermoon	10	F7/C5	4(33)	13	11	16	13	14	13	14	AL LG
Erik Bloodaxe	7	F9	70	15	13	14	11	9	14	10	AL CN(E); hand axe, long sword +1
Garth	10	F3	18	14	13	13	10	8	11	18	AL CN(E); short sword, dagger
Gornat	8	P7	32	13	11	11	10	13	10	16	AL N(E); horseman's mace
Gort	10	F7	41	17	11	14	10	6	7	14	AL NE; knife
Grinder	2	F9	80	18(00)	13	18	9	7	13	12	AL N; club, short sword
Hallan Deepdelf	6	T4/W(I)4	19	10	16	11	16	11	14	19	AL CN; short sword +1
Harnakh (flind)	5	HD 3+3	25	16	11	15	10	8	8	17	AL LE; flindbar
Jasson	5	F9	46	15	12	13	11	14	14	12	AL NG; long sword
Landa Darkcloud	3	P7	19	12	11	9	12	16	10	16	AL CE
Lara Mooncrow	3	W8	18	9	12	8	16	10	13	18	AL LE; dagger +2, darts
Lareth Eln	10	W110	12	8	10	9	15	11	11	17	AL N
Larth Darkcloud	2	F7/W5	60	13	13	11	15	12	10	13	AL CE; long sword, drow crossbow
Leratan	2	F7	33	13	12	14	13	10	15	14	AL LE; long sword, wheel lock pistol
Manta	10	W12	30	9	12	10	17	11	8	17	AL N
Marta Mornstar	10	W12	28	9	11	11	16	12	12	17	AL CG
Melana	7	F7	44	14	12	12	13	10	13	14	AL N; heavy crossbow, short sword
Ord Nellis	10	W10	25	10	12	10	15	12	12	17	AL N; staff of striking, dagger
Raven	6	F8/W5	51	15	13	13	16	11	12	13	AL N(E); wand of magic missiles, club
Selene Darkcloud	2	P10	37	13	11	12	10	14	10	14	AL CE; mace
Sven Onethumb	7	P2/F4	18	15	12	13	11	12	13	15	AL CN(E); staff, hammer
Tal Gilgalad	6	F8/W2	56	15	15	12	15	10	17	13	AL NE; long sword, wheel lock pistol
Talis Mornstar	10	F3	19	14	12	13	12	10	12	18	AL CG
Teela Darkcloud	1	P15	72	13	11	12	13	16	13	12	AL CE; mace +2
Tel Astrid	8	W5	8	10	10	11	14	11	12	19	AL CG; dagger, darts
Tessa Darkcloud	3	P10	45	12	13	12	11	14	11	14	AL CE
Tinker	8	F3/T1	16	14	14	13	11	8	9	18	AL CN
Torgan Betz	2	F9/T7	90	13	16	13	14	12	15	12	AL N(E); short sword +2, dagger of venom, garrotte
Tront	5	F9	66	18(00)	12	17	12	8	3	9	AL N(E); two-handed sword
Turgeon	10	F2	10	12	12	14	10	9	9	18	AL CN(E); short sword, dagger
Vissq	5	F10	74	16	12	16	10	8	9	10	AL N(E); bastard sword, throwing axe
Vray Mornstar	10	F3	19	14	12	13	12	10	12	18	AL CG
Waldrin	7	F6	35	13	15	13	12	10	11	15	AL N; light crossbow, short sword
Wallis	5	F6	40	14	13	14	12	11	12	15	AL CG; long sword

# MONSTER SUMMARY TABLE

This table presents the vital statistics for some of the monsters featured in this adventure. Use it for handy reference during play, and refer to the *Monstrous Compendium* volumes and to the *Lorebook of the Void* for details.

Name	AC	HD	THACO	#AT	Dmg	MV	Remarks
Bookworm	2	1/4	20	nil	nil	12 Br 3	AL N
Capuchin Monkey	7	1+1	19	1	2	9	AL N
Celestial Dragon	-2	18	5	3+	2-20/2-20/ 4-40	12 FI 48	AL CE; breath weapon, magic use, 45% MR
Death Shade	-8/host's	7/host's	Special	1	Special	9/as host	AL CE; infestation
Ephemeral	2	5	15	1	1-4	18	AL NE; drain Intelligence, +1 or better weapon to hit, regeneration
Fire Giant	-1	15+2-5	5	1	1-8 or 2-20+10	12	AL LE; hurl rocks for 2-20, resistant to fire
Frost Giant	0	14+1-4	5	1	1-8 or 2-16+9	12	AL CE; hurl rocks for 2-20, impervious to cold
Ghost	0 or 8	10	11	1	special	9	AL LE; age 10-40 years, <i>magic jar</i>
Haunt	0/victim	5/victim	15	1	special/by weapon	6/victim	AL CN; possession
Homonculus	6	2	16	1	1-3	6 FI 18	AL N; bite causes sleep
Krajen (immature)	9	1/2	20	1	1-3	3	AL N; paralysis
Lich	0	11+	10	1	1-10	6	AL any; fear, paralysis, spell use, spell immunity, +1 or better magical weapon to hit
Mind Flayer	5	8+4	11	4	special	12	AL LE, mind blast, 90% magic resistance
Neogi	3	5	15	3	1-3/1-3/1-6	6	AL LE; slowing poison
Pseudodragon	2	2	19	1	1-3+Special	6 FI 24	AL N(G); poison sting, chameleon power
Rat	7	1/4	20	1	1	15	AL N(E); 5% chance of serious disease
Skavver, Night	3	6	15	1	1-10	18	AL N; swallow
Space Drake	2	10	11	2	2-16/1-12	12 FI 48	AL N(E); breath weapon, magic use, constriction, 30% magic resistance
Space Newt	5	3	17	1	1-8	8 FI 24	AL NE; breath weapon, 30% magic resistance
Spectre	2	7+3	13	1	1-8	15 FI 30	AL LE; energy drain, +1 or better weapon to hit
Spider, Large	8	1+1	19	1	1	6 Wb 15	AL N; poison
Thri-Kreen	5	6+3	13	5 or 3	1-4(x4)/2-5, weapon	18	AL CN; paralysis; dodge missiles on roll of 9+
Umber Hulk	2	8+8	11	3	3-12/3-12/ 1-10	6	AL CE; confusion
Wight	5	4+3	15	1	1-4	12	AL LE; energy drain, hit only by silver or +1 or better magical weapon
Wraith	4	5+3	15	1	1-6	12 FI 24	AL LE; energy drain, hit only by silver or +1 or better magical weapon
Winter Wolf	5	4	15	1	2-5	18	AL NE; frost breath for 2-12 (5' range)
Zombie (human)	8	2	19	1	1-8	6	AL N
Zombie (neogi)	3	6	15	3	1-4/1-4/1-8	4	AL N
Zombie (umber hulk)	2	9+8	11	3	3-12/3-12/ 1-20	4	AL N



Advanced Dungeons & Dragons®  
2nd Edition



# Skull & Crossbows

by Nigel Findley

Different worlds have different laws. But everywhere you go, you're going to find people who bend and break those laws and turn a healthy profit doing it. Whether sailing the high seas or the Flow, they are called pirates.

It's these pirates that you've been hired to hunt. With letters of marque in your mapcase, your job is to track down and capture, alive or dead, some of the most dangerous characters in the known (and unknown) spheres.

Of course, not everyone in space is a pirate. You'll also meet Torgan Betz (a man famous for bending the laws, rarely breaking them), Tiktitik, the

Thri-kreen crusader, "Thought Taker," the illithid, and the feared Drow commander Teela Darkcloud. Even so, they all have their personal agendas, and it's often hard to tell enemies from friends.

*Skull & Crossbows* is an anthology of adventures for the SPELLJAMMER™ campaign setting. This 64-page anthology easily follows *Wildspace*, but can be used in any existing AD&D® SPELLJAMMER campaign.

This adventure is designed for a party of four to six characters, levels 6 to 10.

TSR, Inc.  
POB 756  
Lake Geneva  
WI 53147  
U.S.A.



TSR, Inc.

TSR Ltd.  
120 Church End,  
Cherry Hinton  
Cambridge CB1 3LB  
United Kingdom

ISBN 0-88038-845-5



9286XXX1401

\$8.95 U.S.