

Advanced Dungeons & Dragons
2nd Edition

SPELLJAMMER™

THE LEGEND OF
SPELLJAMMER

Accessory



Advanced Dungeons & Dragons[®]
2nd Edition

SPELLJAMMER[™]



Accessory

THE LEGEND OF SPELLJAMMER



Legends and More

Advanced Dungeons & Dragons[®]
2nd Edition

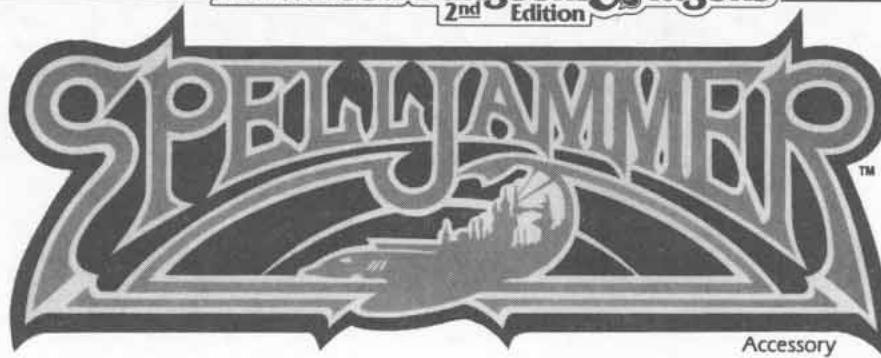

Legends and More

by Jeff Grubb

Design: Jeff Grubb
Editing: Dori "the Barbarian" Watry & Steve "Old Man" Winter
More Spiritual Guidance: James M. Ward
Cover Paintings: Jeff Easley
Illustrations: Tom Baxa
Ship Concepts & Illustrations: Jim Holloway
Ship Coloring: Les Dorscheid
Cartography: Diesel
Graphic Design: Stephanie Tabat
Production: Sarah Feggstad
Art Coordinator: Peggy Cooper
Typography: Gaye O'Keefe & Angelika Lokotz

TSR, Inc.
POB 756
Lake Geneva,
WI 53147 USA



TSR Ltd.
120 Church End, Cherry Hinton
Cambridge CB1 3LB
United Kingdom

TABLE OF CONTENTS

A Word If I May	3
Tales from Wildspace	4
The Truth Behind the Legends	11
The Great Ship in Combat	16
Moving the <i>Spelljammer</i>	16
Long-Range Movement	16
Tactical Movement	18
Combat with the <i>Spelljammer</i>	19
The Wake of the <i>Spelljammer</i>	20
Ramming	21
Critical Hits	21
Morale and the <i>Spelljammer</i>	21
Magic Against the <i>Spelljammer</i>	21
The <i>Spelljammer</i> and Repair	23
The <i>Spelljammer's</i> Awareness	23
The Life Cycle of the <i>Spelljammer</i>	24
Basic Necessities	24
Construction of Little <i>Spelljammers</i>	24
The Smalljammers	25
Ultimate Helms	26
Captains	30
Shivaks	32

A WORD IF I MAY

It is the mightiest ship of space, overshadowing even the majestic elven armadas and the hulking dwarven citadels, larger than many groundling cities. It moves at speeds seemingly impossible for so huge a vessel, yet it maneuvers with the grace of ships one-tenth its size. It is overgrown with legends and the memories of a thousand races, and in its wake are the lives of entire planets.

It is the great ship *Spelljammer*. The Queen of Wildspace. The Holy Grail of the Phlogiston. *Spelljammer* with a capital "S."

The books and maps in this boxed set peel away the cloak of secrecy from this great ship—revealing for the first time all its secrets and history and showing in detail its structures, abilities, and inhabitants. The material presented here also explains why the *Spelljammer* is as it is, why it acts in its own fashion. You will learn the nature of those who seek the one and only *Spelljammer*, of those who want to master its helm, and of those who wish for the power, the prestige, and the knowledge held within this ship.

This 32-page *Legends and More* book will regale you with legends of the *Spelljammer* and will also give you an overview of the ship. *The Grand Tour* book, 64 pages in all, is exactly that: a guided tour of the citadels and towers that dot the back of the *Spelljammer* and all their secrets. This book also gives you new monsters and a section describing many of the personalities of those whose fates are tied to the *Spelljammer*. The 96-page *Ships and Captains* book gives details about new ships and about the captaincy of the *Spelljammer*. You will find information ranging from the inhabitants of the great ship to the adventurers who ply the spaceways in search of it. Lastly, this book will bring player characters directly into contact with the *Spelljammer* and

with those who seek her.

The enclosed maps unfold the mysteries and majesties of the *Spelljammer* and the bulk of the great city that is an inherent part of the ship. And the enclosed cards provide new ships for use not only in this adventure, but for all spelljamming campaigns in general.

The Legend of Spelljammer boxed set is intended for use by the DM, though many of its components, such as the maps and new ships, may be distributed to players who are interested. The DM has the right to modify as much or as little of the information within for a personal SPELLJAMMER™ campaign—the actual secrets of the *Spelljammer* are up to the DM and can be tailored to his or her personal universe.

If particular races or individuals do not fit in with the needs of the DM's campaign, they should be changed or modified. Lastly, there are some mysteries that are better left alone, and they can remain that way or be determined by the DM if necessary. (An example would be determining what the current "master helm" looks like.)

There is but one adult spelljammer at any one time—it is a singular creature, and it is unique. This product aims to be equally unique, whether the DM introduces the great ship *Spelljammer* into his or her campaign or merely uses the characters, ships, and monsters within this boxed set for individual campaign settings.

Whatever its ultimate use, may the spirit of the *Spelljammer*, of exploration and adventure, be with you and your players as you enjoy these books.

—Jeff Grubb, January 1991

TALES FROM WILDSpace

The legends of the *Spelljammer* have flung far and wide throughout wildspace. Here now are just a few of the oft-told tales of *Spelljammer*, just a glimpse of its mysterious past.

From the last entry to *The Book of Skulls*
by Jonas Ironmong,
home planet of Rollthunder

A great bat-winged creature has obstructed the moon this evening, pitching the entire nation of Casanda into fear and panic. Fires have been set throughout the region to ward off this creature, but reports have come in from riders that entire provinces are alight, so great is the fear that this creature creates.

The recordings held by the Priests of Kes show that this creature has invaded our skies a number of times. Each time its appearance heralded the demise of the great empires and foretold a period of warfare and death. The mighty tyranny of the immortal General Koth, who once held half the globe in his hand, ended with the tyrant's death on one of the nights that the creature appeared. And the Sovereignty of Hindar was smashed asunder by barbarian raids that began on another such night. It is written also that the Royal Family disappeared without note one morning as the bat-winged craft passed before the rising sun.

And now it comes again. The countryside is lit with the burning of thatched houses, and the air is filled with fevered prayers and the cries of wild abandon. Reports have come that masked riders—each bearing the symbol of the creature—have set libraries ablaze, saying that the creature has been sent to punish those who know too much. I fear if this madness spreads to the capital, I shall have to flee myself.

The Regent and Casanda Council call for calm, but their mortal words have no effect on the masses, for the people fear the creature more than any pronouncement or armed force.

I have searched the stacks and records of Kes, and in almost every case the calamity upon us is called "The Creature" or—in the more romantic times of

the Royal Family—"The Herald of Doom." I have found one reference, different from the others, that calls this monster simply "The Spelljammer." Moreover, it refers to it as a ship.

What folly! Such a simple term for such a force of nature! As if it were a merchant's cog or a trader's wagon instead of the harbinger of the fall of empires. Every man and woman who has ascended the Regent's Chair since its last appearance has dreaded its return.

And now it has, indeed, returned. And our lands once more teeter on the edge of oblivion. What cruel god has sent this beast, this monstrous creature, whose very appearance drives men mad and signals the end of all?

The request of Dolphinlaugh,
a Sea Elf of the Realms,
to his liege-lord Greysa

I saw the most wondrous thing the last time I was on the surface of our world. A great ray, like those ridden by the locathah, sailed through the sky above me, as if it had leapt from the ocean of one world to the skies of another. It spiraled by me as it sailed, and I had a close look at it.

It was gargantuan, obvious from the mannish city that was built on its back. Its belly was white, and the back the violet of a coral bank. Great amber stripes laced its dorsal wings.

I was amazed by its size and its grace, which I alone saw from my watery hiding place. What sea spawned this leviathan, and what manner of elves tamed such a creature, I cannot know but wish to find out. I wish to pass into the waterless lands to discover how to commune with such a creature. . . .

A captain's tale
as recorded by Serval Voidwood,
Rock of Bral

I've heard the tales about her, the *Spelljammer*—the mistress of wildspace. There are those who say she serves the dark powers herself, that she carries

The Sovereignty of Hindar was smashed asunder by
barbarian raids that very night.
And now IT has come again.

—Jonas Ironmong

TALES FROM WILDSpace

evil gods and tanar'ri from one world to another. I say that is codswallop, and I say this because she saved my life. And my crew, whom you could ask if you could find them.

We were running the gauntlet around Theia in a tradesman. Wildspace save me from such a clunking craft, but it was all we had, and we were being paid a goodly amount just to deliver a small package there. You can call it smuggling or you can call it freedom fighting, but I call it a good day's work and leave it at that.

In any case, the gig was up from the start. Nautiloids from the Theia home fleet were on top of us before we got past its moon. A dozen of them at the least, as if we had sent out invitations for a rendezvous. They were loaded for bear and ready to take us on. Not being fools, we ran, of course—but they followed and, with their blasted pool-helms, they quickly outpaced us.

Then SHE appeared.

Radiant as an archon, diving into the pack of nautiloids, the *Spelljammer* scattered them like a pack of minnows by a whale. Of course I'm sure it was her. There's nothing bigger in known space than the *Spelljammer* herself.

The 'nauts headed for the ten corners of space, and one or two were unfortunate enough to be caught in her gravity plane and were unable to escape. One left a nasty divot along the left wing; the other piled into one of the towers. The tower flashed, as though there was an explosion, but there appeared to be no other damage.

OK, a fluke of fate? I'd buy that idea so far, but after she passed she *turned around* and made a *second pass* at the 'nauts.

By this time the mind flayers had been convinced as to the error of their ways, and they were fleeing at flank speed. I think—no, I am sure—she overtook a few of them. But it wasn't like we were hanging around to find out.

The *Spelljammer* is no hellspawn, but a wonderful ship, and I'd like to buy her captain a drink if he ever comes to the Rock of Bral. Me and my mates have a lot to thank him for.

The Epistle of St. Janeti, the Order of the Spelljammer

All things are part of a greater cycle. A human grows and begets more humans, who will in time take his place after his death. A halfling bears more halflings, to carry on beyond her own ending.

So to with the gods. Many have passed through the spheres, been worshiped, and then perished for one reason or another. It is strange to think they might have their own children, too.

The *Spelljammer* is no god, but it is the child of a god, the seed of a god, and it will one day spring forth full-blown to take its rightful place as the new Ptah or Thor or Cyric.

We will be there as its acolytes.

An eyewitness account by Judd Oskoshtormirange, gnome of Ansalon

I've seen the *Spelljammer* and it's gone. I mean, I saw it destroyed so it doesn't exist any more and so it's gone. Dead. The spider-creatures—the neogi—did it, with half a hundred ships, most of which were wiped out. I know, I was a slave on one of them. The *Jammer* crippled the ship I was on, and most of the spiders died but I lived to tell the tale.

The spiders raked it with fire again and again until *Jammer* finally exploded, leaving nothing but fragments in space, taking out most of the rest of the neogi. This was about a hundred years ago, and this is why the neogi aren't nearly as powerful as they once were. Whoever sat at the *Spelljammer's* helm thought that death was preferable to surrendering to the neogi.

Anyway, it's destroyed, but no one believes me because I'm a gnome. Their loss. But I saw it.

From the Scrolls of Lu Pi, scribe to his Celestial Highness, the Court of Shou Lung

... And it is recorded on this day, the 32nd year of

The spiders raked the *Spelljammer* with fire again and again until the great ship finally exploded, leaving nothing but fragments in space.

—Judd Oskoshtormirange

TALES FROM WILDSPACE

the Master's rule, that a great beast or perhaps a ship appeared in the sky with the morning sun. At first we thought it a dragon, but it was shaped more like a manta-fish than a drake, and as it neared, we saw that it carried a mighty city on its back, much like an elephant carries a howdah.

His Celestial Highness was enchanted by the appearance of this good omen, and he has directed me and my servants to set about procuring such a creature for his own private use.

I have the feeling this may take a little time. . . .

From the journals of the mystic Abee MacHelm

The *Spelljammer* is a ship and nothing more. It is commanded by a great captain, whose very force of will is strong enough to send the ship through space.

I have met this commander, if only in a dream. He cannot leave his ship, and as such, only through his dream self can he search out the powerful and the wise for advice.

The commander is as tall as an arcane, but his flesh is fair and his hair dark. His features are almost elvish, but he has a rough beard, like that of a dwarf. His clothing is human style, but his feet are bare and covered with light fur. He wears a great cloak about his shoulders, with the hood thrown back. His eyes glow red when he is angry.

In the dream he spoke to me and gave a warning that I now give to all who will listen in this city. There are interlopers, creatures from beyond our world and star, who covet our magic, our crops, our homes. Soon they will drop from the sky in great seeds, and they will try to wrest this world away from us.

We must prepare for them. We must fight them. We must *survive*.

The commander told me of these spies among us, several of whom have been here for years, and one or two even sit upon the Council. Now is the time for us to take action! We must throw out these invaders now, before it is too late!

So the captain of the *Spelljammer* has told me. So I tell you. He would not lie, and neither would I.

The sworn testimony of Black Razor, pirate of the Stellar Main

Spelljammer? Pwah! We call her the *Siren*, the most deadly wench in wildspace, and she lures men to their destruction.

I've seen her. All too close. We were near the Bander Cluster when she appeared. Being right-thinking explorers, we closed in. Being careful, we decided not to land on her until we surveyed the situation.

She was beautiful, we all agreed that, but our luck ran sour as soon as we touched her air envelope. Our own 'jammer, a wizard named Kalivox, got excited, babbling about how wonderful it all was. Then he took us in for a landing.

Our captain was on top of things in an instant, bellying like an owlbear and ripping the helm from Kalivox. At that point we were in freefall, just like a brick falling toward the ship. The captain slapped the helm on Kalivox's assistant, we stabilized with just feet to spare, and we left that cursed ship at the fastest speed possible.

Kalivox recovered, but he couldn't say why he countermanded the captain's order. The captain left Kalivox at the next port.

Something affected the wizard, that much I'm sure of. If we had landed, we probably all would be dead by now. That's why I call her the *Siren*, and I warn any ship that wanders into her way to clear the decks.

Paladin vow from the planet Sydia

I hereby swear . . .

I hereby swear
To uphold the right
To uphold the right
Of justice and law
Of justice and law
And to fight
And to fight
For the equality of all
For the equality of all
Until *Spelljammer* returns
Until *Spelljammer* returns . . .

We call the great ship the *Siren*, the most deadly ship in wildspace, and with good reason. She lures men to their destruction—and I've seen her do it.

—Black Razor

TALES FROM WILDSpace

Testimony of H'Carth, the Mad Beholder of Greyhawk

Of course it's a weapon! Something that large, that fast, that powerful? What else could it be? Why would anyone build something that big if it *wasn't* a weapon?

I've heard tales from my own crèche that, back in the dawns of the depths, our people built the ship you call *Spelljammer*. It was to be the crowning glory of our people, a complete lair in which we could dominate all others. At her heart were to be a thousand of our kind, stripped of our chitinous shells and held naked and quivering as little more than a huge engine for the ship.

But then it was sabotaged. The tale says an abomination of another beholder race placed the evil within, but I look at the rise of humans in space and I wonder, oh yes, I wonder. . . . So a flaw was introduced that spread from brother to brother throughout the engine until all were mad. Then the ship broke free of its bounds and began running, leaving destruction in its wake. And it has been running for a long time now.

I don't know if the tale is true, but if it is, then the *Spelljammer* is ours by right. And I intend to take it back.

A dissenting opinion heard in a bar

"Huh! The *Spelljammer* wuz built by gnomes. It used up all their smarts just to build her, which is why nothing's ever worked for them since."

From the log of the *Reliable*, Elvish Imperial Navy, Julian Catheria, reporting, 43rd day of cruise

We spotted the *Spelljammer* this day, in tight orbit around one of the moons of Greyhawk. We have had contact with the ship before and, like before, the *Spelljammer* has made no hostile moves or even recognized our presence. The ship was accompanied by

a pod of space whales, the kindori, who matched it in orbit. Whether the kindori see the *Spelljammer* as one of their kind or are merely benefiting from the ship's presence is as yet unknown.

At the request of several members of the *Reliable's* crew, an expedition was mounted to explore the *Spelljammer*, using three of the ship's flitters. As has been recorded before, contact was lost with the flitters when they entered the gravity field of the larger ship. Visual data confirms that the flitters landed safely on the ship, near one of the large centrally located towers.

The crew apparently entered one of these towers and disappeared. There was no contact. Five hours later, the *Spelljammer* left moon, kindori, and ourselves behind and headed for the crystal shell of greyspace.

The volunteers are believed dead. Services have been held. . . .

Theories regarding spelljamming by Quistus J. Handleprank, Q.S., Imperial Academy of Thought

I believe there is a strong tie between the great ship *Spelljammer* and the various spelljamming helms used throughout known space. The helms should not possess sufficient power in and of themselves to power a ship, nor should the wizards who supposedly control them. However, if each helm is tied to the great ship *Spelljammer* itself, then that mystery can be resolved—it is the power of the *Spelljammer* providing the magical energy for all the helms in the Known Spheres!

The process works backward as well, such that the *Spelljammer* can "bleed" off all the excess energy once it passes through both the helm and the mage, and the ship can then use this energy for its own power.

This is an obvious verity, but nevertheless one that is hard to prove. The only way to sufficiently prove it is to stop all the helms operating in the spheres and see if the *Spelljammer* itself stops. We have not yet done this because persons unknown, who seek to

The *Spelljammer*? It's a weapon. Something that large, that fast, that powerful? Of course it's a weapon. What else could it be?

—H'Carth

TALES FROM WILDSPACE

prevent our full understanding, have sabotaged all attempts to pose a moratorium on spelljamming use. These persons are most likely members of the Secret Circle, who actually control the *Spelljammer* in its flight across space.

Stranger at the docks, Rock of Bral

So I see him, long and thin and gaunt, standing at the edge of the Rock, looking out into space. And I ask him what he's looking at, and he says, tears in his eyes, "I'm looking at the end of everything. It's gone."

And I ask what and he says the *Spelljammer* and I think, "Oi, I've got a hot one here." But he starts describing it and telling about all the races that live on it in harmony; the wise captain who steers the ship by song; the great jungles that grow within, hidden from the suns but illuminated from within; and how he has transgressed and been expelled. And now he is lost.

And I tell him I am sorry and press a coin into his hand. He just wanders off to tell someone else the tale, and I never see him again. And I think he was just drunk, or drugged, or mad.

But what if he was right?

Thoughts from Fat Otto, proprietor, Fat Otto's Peaceable Inn

I've heard it all over the years. The wild-eyed kids who're in space for the first time, the scheming merchants, the fleeing tyrants, the would-be masters of the world. All with their tales of the *Spelljammer*, and all different.

Here's whart I think: It's all a hoax.

I never saw this thing. Me missus, she's never saw it. The idea that there's something that big in space that I never saw is impossible. I've seen everything. But not this.

So I think it's a plan by the arcane. Who knows what those blue-skins are up to, anyway? They've always got an angle, always got an in. They figger that

people will want to go through space only if there's something to go to. Another world? Not enough. I say, let's say there's a big treasure house out there, and let's let them go at it!

Bang! Boom! Everybody wants to go out in space, and the arcane sweep up, selling ships and helms! It's a nasty little racket, but I wish I'da thoughta it myself, I do.

So they put out the story. Sweet Belling Hells, they get a couple wizzerds to put up a few illusions of it and now look at it! But I never seen it. So it can't be there.

The Catechism of Hyr, from the Flatworld of Troulos

What is the world?

The world is Hyr's Anvil.

What is the *Spelljammer*?

Spelljammer is Hyr's Hammer.

What are we?

We are steel beaten and

strengthened between

Spelljammer and World,

between Hammer and Anvil.

Why is this?

It is the will of Hyr.

The view of a forgemaster, Master Ironfoot Goloth, dwarf of the citadel *Tiber*

That there is such confusion is a human thing. Not a dwarf thing. We dwarves understand this, but do not normally speak of it. We do not wish to spoil your ideas.

Everyone talks about how the *Spelljammer* is larger than any ship made in the spheres. This is because you think nobody knows how to move a ship bigger than 100 tons.

Nobody except the dwarves, that is. We aren't that fast, but a team of dwarven craftsmen can move one of our citadels at a pretty fine clip, thank you.

That's the mystery solved. *Spelljammer* is a dwarf

The *Spelljammer*? It's all a hoax.

—Fat Otto

TALES FROM WILDSpace

ship. You can tell by the buildings. It must have taken centuries just to get it into the basic shape, but it's still a dwarf ship. It's been carved to look like a living thing, and that's what throws all you humans off. You just can't imagine anything that big run by us dwarves.

Proof? Well, I don't know any of the craftsmen personally or anything, but I think it's obvious. Dwarves. It's got to be dwarves.

From *The Tale of Torin*, Part XVI, recounted by the bard Cholin

And so it came to pass that Torin was defeated, and his body left lifeless on the starmountain. Yet his spirit would not abandon his body, and he sat by his lifeless form, and he wept crystalline tears.

And there was a roar and the rush of wings above him, and he looked up and saw a mighty ship. Its sails stood out from its sides, and a huge citadel rose from its crest. It moved like a hurricane crossing the land.

Torin could see the decks of this great ship, and they were crammed with people as powerful, as invisible, as *dead* as he. Brave Boroc and Lady Hisat, who perished in fire. Mighty Daria, slain by the werelion, and the puissant Moriedor, wizard of a hundred lands. All dead but all there on the ship. They beckoned to him to come join them on their everlasting journey.

Torin leapt up and found that he could reach the ship in a single bound, unfettered by his human body. They clasped him to their breasts and welcomed him, for only the unliving could walk along the halls of this great ship.

And leaving his body behind, Torin and the Ship of Heroes turned course for other lands, and neither he nor his spirit were ever seen again.

Thoughts on the subject by Kali Makabuck, the Realms

They tell me that the greatest storehouses of gold may be found on the *Spelljammer*. I believe them.

They tell me that the mightiest libraries, containing the knowledge of half a hundred worlds, are stored within. I believe that, too.

But they also tell me that those who walk the decks of the *Spelljammer* are never seen by the eyes of mortal men. And I believe that. And until I hear otherwise on the last point, I don't want to be checking out the first two.

An excerpt from the Joz Manuscript

"The other tales are lies. This is the truth.

"When a world is about to die, its magic drained and its soil rendered lifeless by its inhabitants, it gives out a great cry. That cry flies through the rainbow ocean until it reaches the deathbringer, which men foolishly call the *Spelljammer*. The *Spelljammer* is a servant of Joz, the greatest god of the dead.

"When it receives the call, the *Spelljammer* flies to the wounded world like a bird responding to the cry of its mate. The *Spelljammer* keeps the world company through the last of its death throes, through all of its convulsions, until the last being on the planet draws its final breath. While the *Spelljammer* remains, it draws out all the history of that world, all the songs, all the memories, and it stores this knowledge within itself.

"The *Spelljammer* is a creature of memory, made of the solidified thoughts of all who passed before. Each planet that dies, each death the *Spelljammer* witnesses, increases its size one mote, as if a layer of paint were added to its surface.

"When all the worlds of all the spheres have passed from this place, the *Spelljammer* will have absorbed all knowledge, and it will contain the entire universe within itself.

"Then, having swallowed all that there is to know, it will explode and the cycle will begin again.

"This is the truth. All else is lies."

Lord Chaunt's vow

"I don't care what it is or who owns it. I want it, and I want it NOW!"

I don't care what it is or who owns it! I want it, and I want it NOW!

—Lord Chaunt

TALES FROM WILDSpace



THE TRUTH BEHIND THE LEGENDS

The legends, the myths, the mysteries: Which are true? Which are real? It is said that all legends are true, at least to the people who believe them.

The least that can be said about the *Spelljammer* is that it is an enigma, a mystery lurking in wildspace. Its very name is connected intimately with the act of moving through space. But though there are many ships that spelljam between the crystalline spheres, there is only one *Spelljammer*.

The ship is a mammoth entity, one-third of a mile from stem to stern and two-thirds of a mile across. Under the laws of magical space, there is no known way that something this large should be able to move and maneuver at spelljamming speeds. Yet this ship does and does so with surprising grace.

Some say it is a living thing, similar to the space whales or the organic ships of the elves. They point to the ship's general shape, a cross between a manta ray and a scorpion. Others say it is a construct of one of the many space races or of some unknown or unknowable entity, and they point to the towers that crowd the *Spelljammer's* back. Some say it has a single captain, others say it is piloted by many races, both known and unknown.

With the dearth of hard information, legend and myth step in to fill the place of fact. The *Spelljammer* has been accused of being both a servant of higher powers and of being a god in its own right. It has also been accused of being both good and evil by different beings of a single planet, and its appearance in the sky has been considered a good omen by some and a harbinger of doom by others.

Even those who live in wildspace and disdain the superstitious groundlings on their mudball planets are unsure about the *Spelljammer* and its place in the universe. Many have sought her out, and some have explored her. But only a very few have returned to tell the tale, and they themselves have become wrapped in the mystery surrounding the ship.

The DM may freely pass out any of the tales on the previous pages to the players as "the truth" about the *Spelljammer*. They are equally right and wrong.

The truth behind the *Spelljammer* is this: The *Spelljammer* is a living, sentient ship, unique in the

universe. Other ships may have living components, but none have true sentience—even the reigar's loyal pet ships, the esthetics, do not match the intellect of the great ship *Spelljammer*. Yet the intelligence of the *Spelljammer* is alien, different from that of any other creature—be it man or beholder or neogi. The how and why of the *Spelljammer* thus remain a mystery.

It is the *Spelljammer's* intellect that allows it to move at spelljamming speed, something ordinarily impossible. It can convert its thoughts to energy in much the same way that the spelljamming helms allow mages and priests to convert spell ability to motive force. Because its intellect encompasses the entire craft (in much the same way a wizard "feels" the ship as an extension of him- or herself when spelljamming), it can move itself through space. In addition, it can cross from the phlogiston to wildspace at will, leaving behind permanent portals into the crystal spheres that can be used by any ship.

The *Spelljammer* does not require a captain or crew in the traditional sense. It can guide itself through space without outside aid. However, it does need a captain (race and sex are irrelevant) to replicate itself. It also needs a crew to help maintain its body at its best form and to repel invaders.

The following information in this section details some of the specifics of the great ship.

Name: *Spelljammer*

The name *Spelljammer* is as old as travel in space itself. In the most ancient surviving relics of the past, the *Spelljammer* is described as it is today, still carrying the same name then as it does now. Despite this seeming connection, there is no direct link between the great ship *Spelljammer* and the various spelljamming helms used by priests and wizards throughout known space.

Built by: *Self-created*

The present *Spelljammer* is a descendent of the original craft, whose own origins are lost in time and mythology. It may be that, like the crystal spheres and the phlogiston, there have always been spelljammers.

The *Spelljammer* is no god, but it is a child of a god, the seed of a god. It will one day spring forth as a full-blown god, and we will be there to worship it.

—St. Janeti

THE TRUTH BEHIND THE LEGENDS

Tonnage: 1.5 million (est.)

Hull points: 1.5 million

Keel length: 1,575 feet (.3 mile)

Beam length: 3,100 feet (.59 mile)

Cargo: .75 million tons (est.)

Tonnage and cargo listings are estimates because no one has accurate numbers on a ship this large. (Also, such a large craft is usually not used as a cargo hauler.) In very real terms, the *Spelljammer* is immune to any conventional attacks a single opponent can deliver.

Crew: 1 (?)/5,000+

The *Spelljammer* has no living crew in the traditional sense. The ship takes care of its own maneuvering and power, either directly or through the use of servitor constructs called shivaks. These shivaks take care of the detail and grunt work and can be considered "monsters" unique to the *Spelljammer*.

The ship carries over 5,000 living individuals who, in general, have little effect over the control of the ship. They are more akin to passengers than crew, but they are tied to the ship as well and will fight to defend it. These individuals come from all races and are separated into communities throughout the ship, with the various towers each being dominated by a single racial group. These racial groups fight among themselves, but this is permitted as long as these wars do not interfere with the ship.

The *Spelljammer* continually releases magical scents and fragrances into its air envelope. These fragrances entrap the will of others and control the races that make the ship their home. Although these scents function in a very subtle fashion, they have the effect of a *charm* spell. Those living on the *Spelljammer* are positively disposed toward the ship, will fight to preserve the ship, and will otherwise act in a manner beneficial to the ship. This disposition is the reason why those who join the *Spelljammer* rarely leave.

When an individual first enters the air envelope of the *Spelljammer*, he or she must make a saving throw versus spells. All modifications for race and level apply, but magic resistance is ignored. The elves' nor-

mal resistance to charm spells and their other immunities are also ignored for the purpose of this roll. Creatures that do not need to breathe (such as golems, the undead, or clockwork horrors) are not subjected to making a saving throw.

If the initial saving throw is successful, additional saving throws must be made for every 12 hours spent on the ship. Each is at -1 to succeed and is cumulative (after two days, the saving throw is made at -4). Failure of any of these saving throws indicates the individual has been ensorcelled by the ship. Those leaving the ship before being so enchanted and then returning begin the saving throws as if approaching the ship for the first time.

Those magically charmed are unaffected in their normal actions. They may move and fight normally, even if they attack the inhabitants of the ship or the shivaks created by the *Spelljammer*. However, the following rules do apply to ensorcelled characters:

- Charmed individuals will not directly harm the *Spelljammer*; they will not fire missiles at or use spells against the ship. Nor will they engage in acts known to harm the *Spelljammer*, such as using fire in the phlogiston.

- Charmed individuals will not seek to leave the *Spelljammer*. The individual can be carried off or knocked unconscious and dragged off the ship, but he will not leave of his own volition.

- If the individual is charmed by the *Spelljammer* while still in the ship's air envelope before he has landed on the ship itself, he can be carried away from the envelope without ill effect (the fragrances within the mixed air diminish over time). The exception to this rule occurs when spelljamming mages or priests are charmed by the ship. If such is the case, they will immediately attempt to land to become part of the *Spelljammer's* crew. The remainder of the other crew must get another, unaffected wizard or cleric into the helm to make good an escape.

The charmed individuals are not otherwise affected. It is not that they are forced to perform or not perform certain actions, it is simply that these actions never even enter the thoughts of those so affected. They will not prevent their friends and allies

I saw the great ship loom before us, and all I could think about was landing, despite Captain's orders. I tried to take us in, but Captain ripped off my helm, and that's the last I remember. Now I'm on this planet. . . .

—Kalivox

THE TRUTH BEHIND THE LEGENDS

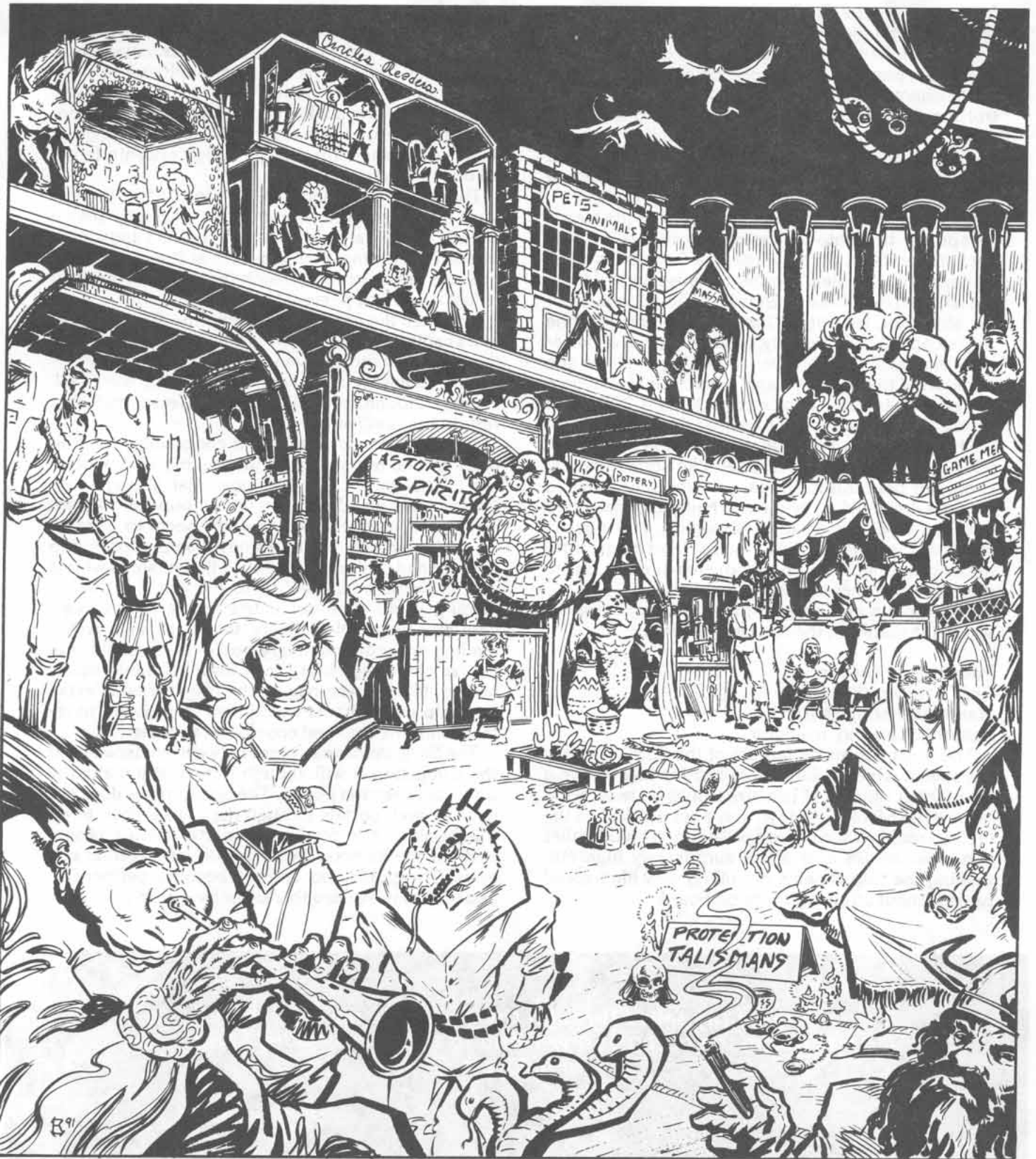

THE TRUTH BEHIND THE LEGENDS

from harming the *Spelljammer*, but they will attack their potential foes who try to harm the ship.

These individuals will retain their original drives and goals, provided those goals do not directly harm the *Spelljammer*. If an individual once desired to control the *Spelljammer*, he will continue to strive toward that desire, but he will be limited to only nondestructive means. In fact, he will be so wrapped up in attempting to control the great ship that he will never want to leave it.

Removing the charmed individual from the air envelope of the ship negates the effects of this enchantment—in other words, the fragrances must be constantly inhaled in order to cause any effect. If the affected individual spends 2–12 hours away from the ship's air, he will no longer be affected by the ship's control. Additionally, an *antimagic* or a *wall of force* spell will hold off the magic-tinged air for the duration of the spell. A *dispel magic* will also negate the effects, but the ship is considered a 20th level wizard for the purpose of breaking this spell.

The fragrances in the air are invisible, and their odor is faint. Usually they smell like something desirable or peaceful to the target—roses or pines to humans, fresh-baked biscuits to halflings, and rotted flesh to neogi. The air itself is magical, and a *detect magic* will reveal a swirling cloud of faint magic from the Enchantment/Charm school area of effect, in addition to any other magical effects.

The captain and crew of the *Spelljammer* are described throughout the rest of this book.

Power type: *Unique*

Ship's rating (SR): 8

Maneuver rating (MR): B

Landing: *Land no, water no*

The most surprising feature of the *Spelljammer* is her speed, which is incredibly fast for so massive a ship. Other objects of this size would be reduced to (at best) an SR of 1—able to move but one hex on the tactical map per turn. The *Spelljammer*, on the other hand, has an SR of 8 and a surprisingly high MR, making the ship capable of pulling very high speed turns without affecting those on board.

The *Spelljammer* lacks a command center per se—the ship's consciousness permeates the entire ship. There is no "brain" to the creature in the usual sense, no location that can be struck or exploited to seize control of the entire body. Much like how the consciousness of the spelljamming mage seems to encompass an entire ship, so too the spirit of the great ship is everywhere through its body, concentrated in no one location.

There is a "command bridge" located in the forward quarters of the ship, but this is usually sealed off and only available when the correct individual bearing the ultimate helm arrives at the ship. These quarters are tailored to match the needs of the individual's race and personal tastes.

It is when the great ship is under the direct control of its captain that the ship is most vulnerable in that the captain is mortal even if the ship seems immortal. No other helms operate to control the *Spelljammer*, though they will operate on lesser craft that rest on the *Spelljammer*.

The *Spelljammer* itself could conceivably land on both ground and water without taking severe damage. (It is known, for instance, that young spelljammers can and do land on both ground and water.) The ship's flattened bottom would seem to be ideal for such landings, but it has never been reported to have landed. This may be due to the personal whims of the *Spelljammer* itself or to the fact that such a landing could wipe out entire towns unless exact care was taken. Most likely, the great ship avoids landing on larger planetary bodies because its protective charming ability over its inhabitants would be lost. (Such areas negate the fragrances' effects.) The ship's inhabitants would lose their desire to remain with the ship and could seek to harm it.

The *Spelljammer* can cross between wildspace and the phlogiston at will, though it must still make the travel between the points. The *Spelljammer* does not need to seek portals through the crystal shell to do this because it forms its own portal when crossing between the Rainbow Ocean to the various solar systems. The portals so created become permanent, and they may be used thereafter by any ship that can

A great ray sailed through the sky above me, as if it had leapt from the ocean of one world to the skies of ours. I wish to follow it.

—Dolphinlaugh

THE TRUTH BEHIND THE LEGENDS

reach them. Other forces may also create permanent portals, but only the *Spelljammer* has been seen creating these long-standing gates.

Armor rating: 5

Saves as: 20th level wizard

Magic resistance: 50%

Whereas most ships—whether the unliving, gnome ship of steel or the polished, living crystal of the elven armada—have a saving throw as per an item, the *Spelljammer* saves as a 20th level wizard. All forms of attack that do not fit under standard saving throws are determined as a save versus spells.

In addition, the *Spelljammer's* body has an innate magic resistance of 50%, such that its walls will often not be affected by fireballs or other fell magics. The *Spelljammer* is also immune to the effects of all enchantment/charm spells directed against it, including the effects of magical items and artifacts.

Armament: 30 large catapults

15 medium catapults

15 small catapults

40 large ballistas

30 medium ballistas

20 small ballistas

Tail sting

The *Spelljammer's* complement of weapons is large and is controlled by the various races that inhabit the ship. The large catapults and ballistas are in the hands of those who live in the major towers, while the smaller weapons are controlled by those in less powerful positions or are used to support the major weapons. Interestingly enough, the chief opponents of these weapons are other towers and races rather than invaders from space. Only in the face of a concentrated raid will the numerous towers combine forces against invaders.

Contrary to previous reports, the *Spelljammer* packs no jettisons. (Earlier reports had confused a flurry of catapult shots with jettisons in action.)

The previous reports of bombardments aboard the *Spelljammer* are also partially false. In fact, there are never more than 10 bombardments on the *Spelljammer* at

any one time. Any additional bombardments that fall into the *Spelljammer's* hands are usually fought over by the giff, who place an ancestral claim on all large guns. These fights most often result in the destruction of the gun or in the giff acquiring the gun (and then firing it until it blows up). It is not known why the giff, who make their home on the *Spelljammer*, are so excited by this destruction, but it may be a side effect of the *charm* spell that the ship casts on them. The net result is that there are essentially no bombardments on the ship (outside of those briefly under the control of the giff).

The *Spelljammer* does have an additional weapon stored in its tail. The tail assembly can create a sphere of annihilation and can independently fire the sphere at targets. The sphere appears as utter blackness surrounded by a corona of bright, crystalline-white light, easily visible when fired.

The sphere can move six hexes per round and can follow its intended target. It is 10 feet across and powerful enough to suck in any ship of 100 tons or less. The sphere strikes with the THACO of a 20th level wizard to hit against the ship armor rating. If the sphere misses, it will complete its movement for that turn in a straight line, then circle around to strike again until it either hits or the target reaches spelljamming speeds and outruns the sphere.

The sphere can be affected like any other sphere of annihilation, but it cannot be used against the *Spelljammer* itself—if it reenters the *Spelljammer's* air envelope, the sphere fizzles into nothing.

If the sphere falls into the gravity plane of an item larger than 100 tons other than that of the *Spelljammer*, it will fragment into 2–12 smaller spheres of annihilation and scatter across the larger body. Control is lost over these items, and they are treated as normal spheres of annihilation.

The *Spelljammer* only uses the sting weapon when it has a captain on board; in other words, when operating on its own, the ship will not use the spheres in combat. Only the captain can order the spheres to fire. This is one reason why many of the more recent tales of the *Spelljammer* neglect to mention this particular feature.

I have heard this monster deemed by others to be a ship called the *Spelljammer*. What folly! Such a simple term for what we know and fear as "The Herald of Doom."

—Jonas Ironmong

THE GREAT SHIP IN COMBAT

The *Spelljammer* moves and fights much like any other ship in wildspace. If under the control of a captain, the captain's will is instantly converted to the power of the ship itself, and it moves and fights as per the captain's will. If not under the control of any particular character, the *Spelljammer* moves and fights under its own power and is controlled by either the needs of the DM or in a random fashion determined by the roll of a die.

This section covers the *Spelljammer's* movement (both long-range and tactical), using the ship in combat (including types of attacks the ship can make), magical attacks against the ship, repairing the ship, and, lastly, the ship's awareness.

Moving the Spelljammer

The *Spelljammer* is a large ship, represented in the *Adventures in Space SPELLJAMMER™* boxed set by a multi-hex figure. The bow of the ship is considered the location from which the ship turns and moves. The bow will face one of the six hexsides of the forward hex it occupies.

The *Spelljammer* can move a determined number of hexes only if that movement falls within the restrictions for long-range movement. It will not charge a sun, for example, or fly into the maw of a gargantuan spacefaring monster. It will pass through or over other ships, such that a charge at one random ship can carry the *Spelljammer* through that ship's hex and beyond.

When turning the great ship, the wings and stern hexes will pass through a number of other hexes in making the turn before lining up in their correct position. All hexes that the ship passes through while making such a turn are affected by the wake of the *Spelljammer* (see the subsection below for further information).

Sudden turns have no effect on the crew because crew members are totally within their own gravity plane. However, to an outside observer, such a huge craft making a 120-degree spin and then charging would be unsettling, to say the least.

Long-Range Movement

If the *Spelljammer* is under the control of a captain (whether represented by a PC or an NPC under control of the Dungeon Master), its long-range goals are determined by the person controlling the character acting as captain. What spheres and planets to visit; what actions to take; and who to contact, fight, or take on board are all up to the individual. The *Spelljammer* will respond immediately.

This is not to say that the ship will continually engage in foolish or suicidal actions at the request of its captain. The *Spelljammer* has a mind and a will of its own, and while it will usually submit that will to its captain, it will protest if necessary.

The nature of this protest will not be an actual command against the action, but rather a "second thought" to the captain himself. If the PC acting as captain suggests that they land the *Spelljammer* on water (something the ship would not do on its own), the DM should merely say, "You don't think that's a good idea." If the player presses, the *Spelljammer* will perform the requested action, but the override is nevertheless noted. (See *Ultimate Helms* in "The Life Cycle of the *Spelljammer*," below, for the effects of overriding the ship once too often.)

The *Spelljammer's* general restrictions for movement are to:

- *Never land on planets.* This extends to any solar body larger than itself that may or may not have an atmosphere. Entering such an area causes the magical scents that control the populace to be diminished or eliminated. Passing through the air envelope of a larger body is permissible, provided the contact is no more than two turns (the time it would take some of the enchanted inhabitants to come out of their spell).
- *Never act to harm the inhabitants of the ship.* This includes trying to bleed off the atmosphere entirely, taking on a hundred beholder ships in a fight, and the like. This restriction also includes attempts to remove one particular life form or another from the ship, with the exception of the undead. Whether the captain likes neogi or not, their establishment will remain on the ship.

The *Spelljammer* has a mind and a will of its own. Captains who have a death wish and who guide the *Spelljammer* toward a flaming sun will be "removed."

THE GREAT SHIP IN COMBAT

In addition to the *Spelljammer's* particular restrictions, the ship prefers its captains to observe the following ones as well, including to:

- *Never use fire in the phlogiston.* A commonsense restriction, since the flammable vapors would otherwise combine with those in the *Spelljammer's* air envelope. Even the giff will not fire in the flow.

- *Never try to destroy the Spelljammer.* Patently obvious suicidal actions such as plunging the *Spelljammer* into a fire body will be strongly discouraged.

- *Never attempt to leave.* Once a captain is installed, the ship will want him or her (or it, for that matter) to remain. This restriction will be invoked instantly. If a captain still attempts to leave, the *Spelljammer* will try to stop him or her. (For further information, see *Ultimate Helms* in "The Life Cycle of the *Spelljammer*," below.)

- *Never let any other inhabitant leave.* This regulation is less heavily enforced than the other ones, but the *Spelljammer* likes to maintain its myth and mystique as a protective shield against others, and thus it doesn't like inhabitants (who will certainly divulge whatever secrets they have learned) to escape. There are those who do succeed in escaping the *Spelljammer*, but they are few and far between.



If the ship is not under the control of any one individual, its actions become more erratic. The DM can determine the *Spelljammer's* actions on his or her own, according to the needs of the campaign. (If, for instance, it is necessary for the current adventure's plot to have the *Spelljammer* stay in orbit around Greyhawk for a few days, then so be it—do not let the dice blindly control your campaign!)

For general movement of the *Spelljammer*, roll on the table below. Make one roll every six hours.

Table 1: Random *Spelljammer* Long-Range Movement

d100 roll	Result
01-40	<i>Spelljammer</i> continues last action
41-50	<i>Spelljammer</i> moves to a chosen location in wildspace and stops there
51-60	<i>Spelljammer</i> moves to the next nearest solar body and orbits
61-70	<i>Spelljammer</i> moves toward the central point of the sphere, orbiting any body found there
71-80	<i>Spelljammer</i> moves toward the crystal shell of the sphere, but does not leave the sphere
81-00	<i>Spelljammer</i> moves toward the crystal shell of the sphere, leaves the sphere, and heads for a random crystal sphere (roll or choose direction and time); upon reaching that crystal sphere, the <i>Spelljammer</i> will enter (no need to roll again until the crystal sphere is reached)

In addition, there will be situations where survival of the *Spelljammer* will obviously override any die rolls. The appearance of a large fleet of hostile ships (40 or more—any fewer will be ignored) will cause the *Spelljammer* to move off in another direction, attaining spelljamming speeds as soon as possible. Further, stellar events such as exploding planets and stars as well as huge monsters (for example, a rogue moon or murderoid) will cause the *Spelljammer* to leave the area quickly.

Once installed aboard the ship, a captain may never leave the *Spelljammer*. Even if he decides to relinquish command of the great ship, the captain will remain aboard until his death. . . .

THE GREAT SHIP IN COMBAT

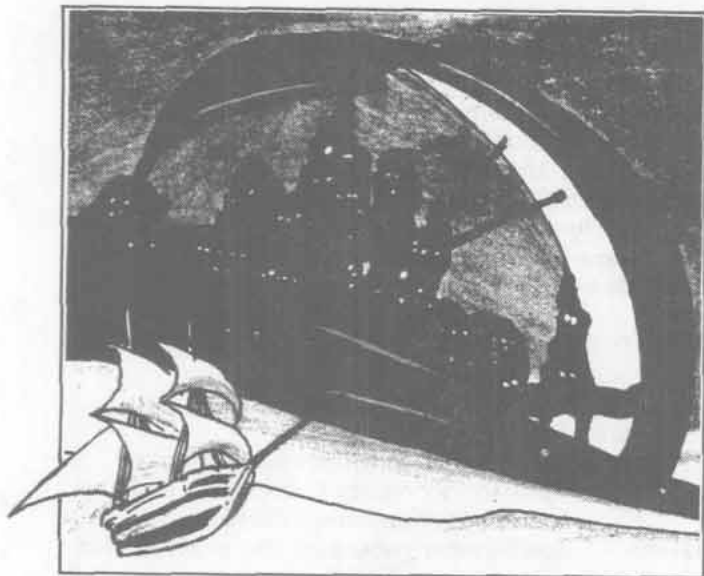

Tactical Movement

Like any other ship in space, the *Spelljammer* moves at spelljamming speeds as long as it is not in contact with other large bodies (10+ tons). For example, the presence of an elvish flitter can prevent the *Spelljammer* from attaining its high speeds. When reduced to tactical movement (on the hexgrid provided in the original SPELLJAMMER™ set), the *Spelljammer's* SR of 8 makes it an incredibly fast and dangerous opponent.

Again, ships under the control of a captain (whether a player character or a nonplayer character under the control of the DM) move and fight according to the desires of the captain. The rules regarding the *Spelljammer's* influence apply to tactical as well as to long-range movement. In other words, the ship will seek to avoid entering large gravity fields or engaging overwhelming enemies.

For ship actions when not under the control of a captain, the DM can determine the ship's movements according to his own needs, or he can roll on the following table, checking every 1-6 rounds or at his preference.

Table 2: Random *Spelljammer* Tactical Movement

d100 roll	Result
01-20	<i>Spelljammer</i> moves straight ahead (roll on Table 3)
21-30	<i>Spelljammer</i> turns right one hex and moves (roll on Table 3)
31-40	<i>Spelljammer</i> turns left one hex and moves (roll on Table 3)
41-50	<i>Spelljammer</i> turns right two hexes and moves (roll on Table 3)
51-60	<i>Spelljammer</i> turns left two hexes and moves (roll on Table 3)
61-70	<i>Spelljammer</i> moves directly toward one random ship, if possible (roll on Table 3); if not possible, no movement
71-80	<i>Spelljammer</i> moves directly away from one random ship, if possible (roll on Table 3); if not possible, no movement
81-90	<i>Spelljammer</i> does not move
91-00	<i>Spelljammer</i> repeats action from the previous turn

For the distance moved in Table 2, roll a 10-sided die and check the following table.

Table 3: Random *Spelljammer* Distance Movement

d10 roll	Result
1	1 hex
2	2 hexes
3	3 hexes
4	4 hexes
5	5 hexes
6	6 hexes
7	7 hexes
8	8 hexes
9	0 hexes (though still may turn)
10	Roll twice on this table; after the first tactical movement and distance rolls are made, roll again for a new direction and speed (remember that regardless of die rolls, the <i>Spelljammer</i> cannot move more than eight hexes in any one turn)

Even when reduced to tactical movement, the *Spelljammer's* SR of 8 nevertheless makes it a formidable opponent.

THE GREAT SHIP IN COMBAT

The DM can override these tables any time (even after the roll), if it suits his or her purpose. These tables are included as guidelines only. Keep in mind that this method of random movement will produce a "drunkard's walk" for the *Spelljammer*—a series of unrelated movements, but this can be explained as the unpredictable nature of the craft.

Combat with the Spelljammer

The *Spelljammer* is not by its nature an offensive weapon. Its very size is protection against all but the largest of creatures in wildspace; where its size does not protect it, its speed and dexterity more than make up for its lack of offensive weapons.

However, the *Spelljammer* does have three main attacks: the wake of its gravity field, its sting, and that of its inhabitants.

The wake attack is usually used to discourage rather than defeat opponents (primarily other ships). The sight of a nearly quarter square mile of real estate moving in at spelljamming speeds tends to turn away all but the most determined attackers. (See below for further information on the wake attack.)

The sting of the *Spelljammer* (previously described in the armament information given in "The Truth Behind the Legends," above) will only function when it has a captain in residence. It may be that the ship only uses the spheres of annihilation to protect its captain when he or she is on board. The use of the sting is the captain's prerogative, and the captain will know of its existence once he or she communes with the *Spelljammer* using the ultimate helm.

The sting of the *Spelljammer* is mounted in the curved tail section of the craft; as such, it can only fire at targets that are initially in the "front" of the ship. Thus, only those who are in front of the forward three hexes of the *Spelljammer* may be fired at. However, the spheres do track their opponents and, once fired, the *Spelljammer* may change course and ignore its prey. Any number of spheres may be fired, but only one may be fired per turn.

Lastly, the inhabitants of the *Spelljammer* have a variety of weapons available to them—catapult, ballista, and the very rare bombard. As stated under the armament information in "The Truth Behind the Legends," above, these weapons are used primarily to attack each other, but they can also be aimed at outside targets.

There is a base 10% chance that any ship that enters the *Spelljammer's* air envelope will be attacked by a large weapon. In cases where there are numerous ships in the area, the chance of being shot at increases dramatically. The 10% chance is modified by the following:

- A +20% if the ship is one that normally belongs to a racial enemy of one of the races on board.
- A +30% if the ship has previously fired at the *Spelljammer*.
- A +50% if one to three opposing ships are near the *Spelljammer*.
- A +70% if more than three opposing ships are in the area.

The percentages are cumulative, with a maximum of +90%. If a ship takes one shot from the *Spelljammer*, roll again at the same odds to see if it is fired upon again that round; continue to roll until the attack fails when greater than the required percentage is rolled. For cases of large-scale combat with a combined fleet attacking the *Spelljammer*, the DM may set a maximum number of attacks at 10 shots per round.

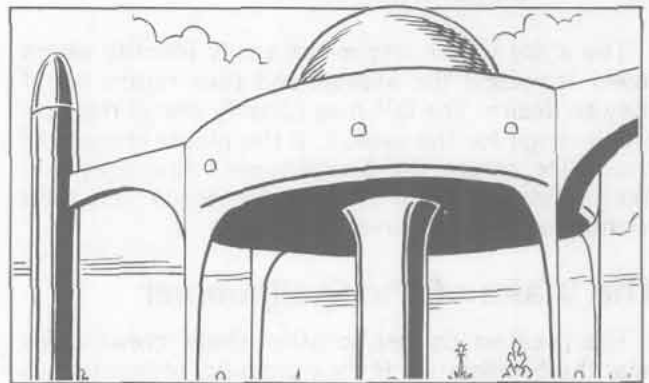

The *Spelljammer* has three attacks: a sting attack, a wake attack, and the attack launched by its inhabitants. The sting attack is the most spectacular—spheres of annihilation spew forth from the tail assembly.

THE GREAT SHIP IN COMBAT

Example: Pirates in a neogi mindspider attempt to land on the *Spelljammer*. They have not opened fire, and they are alone. There is a 30% chance they will be fired upon (10% for entering the *Spelljammer*'s air envelope plus 20% because the neogi are racial enemies of those on board)—the DM rolls a 29. This roll succeeds, and a second roll is made, with a result of 65, so only one shot is fired at the mindspider. The mindspider crew returns fire that round, so the next round the chance for the *Spelljammer* attacking rises to 60% (an additional 30% is applied to the modifications above for being fired upon). A 55 is rolled, followed by a 43 and a 67. Therefore two more shots are fired at the mindspider from the towers.

Determine the type of attack using the following table. The DM may also use weapons belonging to disparate factions within the *Spelljammer*.

Table 4: Weapon Determination

d10 roll	Weapon
1-2	Large catapult
3	Medium catapult
4	Small catapult
5-6	Large ballista
7-8	Medium ballista
9	Small ballista
10	Bombard (giff only)

The ships under attack can easily identify which tower launched the assault and thus return fire if they so desire. The DM may identify one of the towers in range for the assault. If the player characters choose to return the *Spelljammer*'s fire, they will likely find the inhabitants of that tower less than friendly once they arrive.

The Wake of the Spelljammer

The greatest danger to other ships' crews when near the *Spelljammer* is the possibility of falling into

the great ship's gravity plane as it passes. The fact that the *Spelljammer* can turn and maneuver very swiftly makes it all the more dangerous in the far reaches of space.

When the *Spelljammer* enters a hex occupied by another ship, that ship's spelljamming character must make a Dexterity check to remain on the same gravity plane and to resist any damage. The spelljamming mage or priest receives a bonus or penalty to his die roll according to the maneuver rating of his ship as in the following table.

Table 5: Dexterity Check Modification

MR	Modifier
A	-8
B	-6
C	-4
D	-2
E	0
F	+2

Failure to succeed on this check results in the same effects as being on a ship without a spelljamming helm. Ships without standard spelljamming helms (including the illithid pools and the beholder orbs) as well as those with helms whose spelljamming wizard has failed the Dexterity check will immediately suffer 1-10 points of hull damage and take a critical hit.

Those on board must make an additional Dexterity check or fall toward the *Spelljammer* (quite likely from a high of 20-120 feet) unless caught or otherwise restrained. A saving throw against death by the helmsman (regardless of the type of helm) will prevent the ship from crashing onto the deck of the *Spelljammer*. (Crashes are handled as per page 65 of the *Concordance of Arcane Space* in the original SPELLJAMMER™ boxed set.)

The required checks and saving throws can be eliminated in part by always approaching the *Spelljammer* (or any large object in space, for that matter) along its gravity plane. This should protect the craft from sudden changes in course. The exception is when the

Piloting the great ship close to other ships results in a wake attack. Those on board these ships must make their Dexterity check or tumble toward the *Spelljammer*.

THE GREAT SHIP IN COMBAT

Spelljammer makes a 120-degree (two hexside) turn in one round, in which case a new check must be made for craft affected during that round.

Most veteran captains are aware of this maneuvering procedure, but many new to space are not, and they must learn this procedure through trial and error—and quickly!

Ramming

There are very few things in the universe that the *Spelljammer* could actually ram. Most ships are of such small size that they would either be swept aside (in the wake attack) or be forced to land on the *Spelljammer* itself in order to weather the “storm.” Items much larger than the *Spelljammer* will retain large air envelopes, and the *Spelljammer* will avoid assaulting them closely.

However, if the captain of the *Spelljammer* decides to ram a large object or creature, the chitinous lobes at the bow of the *Spelljammer* are considered blunt rams for ships of less than 100 tons and as piercing rams for those of 100 tons or more (including citadels and armadas).

Furthermore, the *Spelljammer* will inflict a random number of hull points due to its great size, making an exact strike difficult. Roll d100. The attack will deliver 1–100 hull points of damage times the *Spelljammer*'s current speed, and it will automatically inflict a number of critical hits to the ship equal to the *Spelljammer*'s current speed. At the option of the captain, the ship can deliver only the critical hits and not the hull point damage.

The *Spelljammer* will not ram unless ordered to by its captain. Its passing through another hex that contains other ships should be considered a wake attack and not ramming.

Critical Hits

The *Spelljammer* is so large that it does not suffer critical hits. Its towers, however, can still be destroyed, and a critical hit directed against a tower can remove a large weapon.

Morale and the Spelljammer

Although the *Spelljammer* has no real “crew” with which to engage in combat, the races that live in the towers on its deck would be more than happy to fight the ship's opponents. Each of the creatures in the towers has a morale as stated in its entry, which is used for determining both melee combat and the effects of being attacked. When figuring modifiers for combat between ships and the various towers, the tower weapons may be considered as a separate crew of the ship for purposes of determining morale.

Magic Against the Spelljammer

The *Spelljammer* is a living thing, and it has high magic resistance, high saving throws, and outright immunity to a number of spells.

For instance, the *Spelljammer* is immune to all enchantment/charm magics and cannot be commanded, charmed, or otherwise affected by spells from that school or spells that make use of components from that school. In addition, the *Spelljammer* cannot be fooled by illusions of any type, for it functions as a gem of true seeing for detecting objects around it. Both of these abilities are passed on to its captain through possession of the ultimate helm. (Note that this makes the captain immune to the *Spelljammer*'s own enchanted air envelope, but the link between captain and ship compensates for this. The *Spelljammer* prefers its captains to have free wills.)

Spells directed against the ship can inflict damage, provided they overcome the ship's magic resistance and the ship fails its saving throw. Parts of the ship protected by this high resistance include all the towers and the hull of the ship. This magical protection continues only as long as the ship is intact—pieces of the ship that are broken off do not retain any magic resistance.

Certain spells that affect only one creature may be used against the *Spelljammer*. However, the range of

Spells directed against the ship can inflict damage, but they must first overcome the ship's magic resistance and the ship must fail its saving throw [as a 20th level wizard, no less].

THE GREAT SHIP IN COMBAT



THE GREAT SHIP IN COMBAT

these spells must take the entire *Spelljammer* into account in order to affect it. Therefore, a *temporal stasis* would function only if the entire ship could fit into the spellcaster's range.

Gates, *teleports*, *dimension doors*, and other long-distance motion spells do not function inside the air envelope because of a side effect produced by the magic that tinges the air. Crystal balls and scrying spells cannot pierce the ship's air envelope either, and their attempts reveal only a shining blue fog.

Wishes and limited wishes, as well as related magic obtained from the direct involvement of the gods (including *commune* and *contact other plane*), will not function if used directly against the *Spelljammer*. Characters cannot wish the ship away: the gods will not listen. Characters can use such magics on the *Spelljammer* for other uses (such as to wish up a magic item to save one's hide in a situation), however, but they cannot use them against the ship.

All spells function normally on the *Spelljammer* given the restrictions outlined above. For instance, *detect magic*, in addition to functioning normally will reveal a light blue, shining fog swirling throughout the ship—the magical fragrances that influence the inhabitants of the *Spelljammer*.

The Spelljammer and Repair

It is unlikely that the *Spelljammer* will be severely damaged by anyone or anything, but in the world of adventurers and heroes, the unlikely often becomes a sure thing. Thus the *Spelljammer* is able to heal itself in times of need.

The *Spelljammer* is made of two types of material, the first being the resilient, leathery material of its main hull and the second being the more brittle, chitinous material of its upper towers and ram. Damage done to the towers and ram is akin to damaging the hair or nails of a living thing—a bother but inflicting no permanent damage. (On an additional note, the inhabitants of the towers often break through the walls in order to put in new doors or to expand their domains, with no harm to the *Spelljammer*.)

However, the hull itself can be damaged; it has an armor rating of 5. This leathery material can heal naturally at a fairly slow rate of 1–10 points per day. In cases of severe damage (more than 10% or a similar amount delivered to a single location), the shivaks are mobilized. (For more information on shivaks, see "The Life Cycle of the *Spelljammer*," below.) Necromantic spells that heal (or harm) the *Spelljammer* have no effect on the ship because of its innate magic resistance, but the spells can affect the ship's captain.

The Spelljammer's Awareness

As stated previously, the *Spelljammer* is a sentient being, but its awareness is completely alien when compared with the myriad races of known space.

The *Spelljammer* has no "eyes" in the standard sense, but it can nevertheless detect life (as per the spell). This detection ability functions throughout whichever crystal sphere the *Spelljammer* is at when it is at rest, and the ability is always in operation concerning the ship's internal life.

The *Spelljammer's* ability to detect life can key on certain particular life-forms, so that it (and its captain) can know where an individual is at all times. The captain must ask the *Spelljammer* for this information as the *Spelljammer* will not volunteer it. While the location of an individual can be determined by this ability, the ship cannot detect what that individual is doing without the use of the shivaks. The shivaks, in effect, act as the "eyes" of the *Spelljammer*.

The detect life ability has a drawback in that it cannot detect undead or other unliving creatures, including clockwork horrors and golems. The shivaks also cannot detect or even fight these creatures. It is believed that this inability is the reason why the *Spelljammer* maintains a large community of living beings on board, who will fight depredations from such unliving creatures in the ship's stead.

The *Spelljammer* can detect life and can, in fact, track individuals as well. It knows where its captain is at all times.

THE LIFE CYCLE OF THE SPELLJAMMER

The true origins of the first *Spelljammer* are unknown. It could be that this great, interstellar beast is a creation of the gods, an oddity that arose on some distant sphere, or the crowning achievement of a now-dead civilization. Or it could be something totally beyond our thoughts to even comprehend.

The only truths we know are that it is a singular, unique creature of known space and that it has existed in space for as long as any race has records. Indeed, often a race's first steps into wildspace are sparked by an interest at the appearance of this great, manta-winged craft in the evening sky.

The *Spelljammer* is a living thing as well as an environment for other races and creatures. This section deals primarily with the *Spelljammer* itself. The lives and times of its inhabitants are touched on briefly in the pages that follow, but they are covered in more detail in *The Grand Tour* book, which is included in this boxed set.

Basic Necessities

The *Spelljammer* has no need to eat, drink, or sleep. Some sages believe this indicates that the *Spelljammer* cannot be a living thing at all, but rather a magically empowered being similar to a golem that is operating under its own magical energies or at the whim of some alien god.

The *Spelljammer* absorbs some energy from sunlight, much like plants do, along the dorsal side of its mantalike body. When found at rest around a body of fire, it will normally have its whitened belly exposed to the sun. The energy absorbed is used for growing, producing shivaks, and maintaining life on board.

The *Spelljammer* also maintains an air envelope that is continually renewing. The air is produced in a large internal area of the ship known as the gardens.

The gardens occupy the central bow of the *Spelljammer*, directly beneath the ram, along the area marked by the creature's "gills" and the two huge membranes that resemble gates. These gardens are a verdant, lush jungle within the ship, basking in the heat obtained from fiery solar bodies and directed

and stored within the ship. These gardens provide both air and food for most of the ship's inhabitants; they are tended by highly intelligent lizard men, the "scaled priests" of the *Spelljammer*. The gardens are also necessary for the production of new spelljammers, as detailed below.

Construction of Little Spelljammers

The *Spelljammer* is a living thing in that it can produce others of its kind—small versions of the *Spelljammer* that resemble its "parent" in appearance, if not in power. The parent spelljammer can only produce smalljammers (as little spelljammers are called) when a captain is on board.

The need for two individuals for reproduction is common to many races, but it would be wrong to immediately assume that the captain is used for some form of physical reproduction. No actual material is needed from the *Spelljammer's* captain (genetic or otherwise). The captain's presence apparently provides the control necessary for the *Spelljammer* to marshal its chaotic forces into producing smalljammers. The captain, as such, is more of a missing cog in the machinery of reproduction rather than a mate or life-partner. However, the truth of the captain's function certainly hasn't stopped many from romantically idealizing the union of captain and spelljammer.

The captain may be of any sex, race, or even species. The requirements of captaincy are determined by the *Spelljammer*, and they seem to vary with time. The would-be captain must fulfill at least the following minimum criteria:

- The captain must fulfill the *Spelljammer's* needs and have sufficient prowess to protect the ship and its inhabitants in combat. The captain must also be a living, sentient, organic creature. Golems, undead, clockwork horrors, and oozes need not apply.
- The captain must show a dedication to his or her beliefs. Strong-willed beings seem to make good captains. However, this does not limit the captaincy to merely paladins, priests, and others who have a

The origins of the great ship are clouded in mystery. Could this huge interstellar beast be a creation of the gods? A mutation from some unknown sphere? Or is it something beyond our ability to comprehend?

THE LIFE CYCLE OF THE SPELLJAMMER

strong belief in their deities. This requirement can include anyone who believes strongly in a given ethos, be it exploration, moneymaking, or individual rights.

- The captain must possess the ultimate helm. (See Ultimate Helms, below, for more information.)

- The captain must make his way to the command deck and defeat any and all creatures present.

With a captain on board, the *Spelljammer* will begin creating its smalljammers in the gardens. During construction/gestation of smalljammers, the gardens are sealed off, and the inhabitants must forage from stored goods or from each other until the new ships are completed. Food riots and battles frequently erupt.

There are also assassination attempts on the captain's life during this time, because if the captain is killed, the ship will cease reproduction, the nascent smalljammers will die, and the gardens will open again for the inhabitants' use.

These times are called various names by the different races, but they are generally known as the "dark times" or "dusk" since they take place directly before the "dawn" of the new time.

The construction/gestation period of the smalljammers is 18 weeks from the time the captain takes control of the *Spelljammer*. During this 18-week period, the gardens also produce and develop the "seeds" that will become new ultimate helms. During the entire reproduction process, the captain remains in complete command of the vessel. The ship can perform all tasks normally, within the restrictions listed above.

Following the successful development and release of the smalljammers, the captain can choose to remain in command of the ship for the rest of his or her life. The *Spelljammer* will not produce more smalljammers unless a new captain comes to the fore and replaces the old. In other words, the production of smalljammers is a once-in-a-lifetime event for the captain.

In any event, the captain will remain on board the *Spelljammer*, even if he or she should relinquish command.

The Smalljammers

About a hundred smalljammers are produced in the gardens with every new captaincy, and a similar number of ultimate helm seeds are also produced. The release of the smalljammers, known as the Flight, causes the gates on either side of the gardens to roll back, and both smalljammers and seeds are released. This usually occurs in the phlogiston, which helps guarantee a spread of ships and seeds to all corners of the myriad crystal spheres.

The large numbers of seeds and smalljammers that are released parallel that of many sea creatures in that huge numbers are produced with the hope of one or two living to maturity. Of the hundred smalljammers released, only a handful survive their first decade, and only one in several spawnings will grow to become a full spelljammer.

The smalljammers are defined as individual ships, but it should be noted that there are some basic differences between them and their parent. For instance, the smalljammers do not need an ultimate helm for control—any spelljamming helm will provide sufficient contact and control for them. The smalljammers also operate on a more empathic level than does the full-sized parent, so emotions (fear, affection, pain, etc.) are felt by the captain of a smalljammer. The little spelljammers will often act on their own, much like a pet or an animal companion. The smalljammers also do not possess the sting weapon, nor do they receive the benefits that come with their parent's size.

The smalljammers do, however, have an illusion ability that is not possessed by the parent; this ability allows them to appear as other spatial objects, including small solar bodies, creatures of wildspace, or other ships. The ability is limited to imitating ships of no more than 50 tons.

There is only one adult spelljammer at any given time. If the *Spelljammer* is destroyed, a cry rises from it at the time of its death, as if the spirit of the *Spelljammer* were a ghost or phantom fleeing the mortal planes. This cry will pass through the ethereal plane to other crystal shells until the nearest small-

The smalljammers are "baby ships" produced after the arrival of a new captain—but only one in many generations will survive to take the great ship's place.

THE LIFE CYCLE OF THE SPELLJAMMER

jammer receives it. This smalljammer will then become the next *Spelljammer*, growing to full size within a year's time.

If the smalljammer is currently under the control of a mage or priest using a regular spelljamming helm, then that individual will become the next captain of the *Spelljammer*. The new captain (and his or her crew) are placed in a state of temporal stasis for the next year while the smalljammer hides in the phlogiston and grows to its final size.

Ultimate Helms

Produced and developed at the same time as the smalljammers, the seeds are kernels of magical energy that can endow items with the ability to become devices for controlling the *Spelljammer*. (These are the ultimate helms hinted at in the original SPELLJAMMER™ boxed set.)

The seeds themselves are invisible and almost impossible to destroy. At the time of the Flight of the Smalljammers, they too are released, and they find their way over time to any number of planets and asteroids.

The seed ignores living organic material, but it stops upon striking a suitable inanimate object, investing that object with the power to become an ultimate helm. As a general guideline, the item that becomes an ultimate helm should be fairly common and usable by most adventurers (for instance, a 20-ton stone idol that becomes an ultimate helm would be amusing, but it would certainly pose serious problems to the adventurer trying to carry it into space to find the *Spelljammer*).

The item will radiate magic and may gain magical abilities according to its type (a sword might become +1, or a set of previously ordinary boots might become *boots of striding and leaping*). In addition, the item grants its user 1–10 additional spell-like abilities at the level or hit die of the user. These spell-like abilities may be chosen from standard spell listings or rolled randomly. Such additional abilities are not revealed to the user, but instead are discovered

through trial and error. The appearance of the item and the abilities it gains are left to the DM, or they may be rolled on Table 6, which is found on pages 28 and 29.

The item that becomes an ultimate helm radiates a strong, pure magical field, easily detected and such that it overwhelms nearby detectable magic. For instance, the holder of the helm (in the form of a sword) can have a cloak of protection, but the cloak will not register as magic because it is overwhelmed by the sword's magical field. The range of this domination of nearby magic is 10 feet.

Regardless of its other powers, the ultimate helm provides a +1 to initiative to *only* the user or wearer. Any allies or partners do not gain this ability.

The helm does not have any sentience per se; the helms operate on their own agenda much like the *Spelljammer* itself. Strange fortunes tend to envelope the holder of a helm, and sudden incidences occur that cause the helm bearer to travel into space—either willingly or unwillingly. As "strange fortunes" are the bread and butter of most adventurers, player characters may not even notice this change. The DM may want to pitch particular events in the players' way to indicate that the enchanted item is more than it seems and that its fate is tied to the *Spelljammer's* own.

The downside of the ultimate helm is that, once grasped, worn, or carried, it cannot be removed. Much like a cursed item, the user cannot discard it—if attempts are made, the character will find that it is bound to the chosen user. A *remove curse* will *not* remove the item, for it is not truly a curse in that it has more positive benefits than negative. A *dispel magic* will work, but the attempt to dispel the enchantment must be made at twice the holder's level or hit die. A successful dispel will cause the helm to merely drop away, and it will wait for another candidate. A *wish* or *limited wish* spell used to remove the ultimate helm will destroy it. Finally, of course, killing the user will also allow the ultimate helm to be removed.

The ultimate helm does not need to be of the same generation as the *Spelljammer*, and, in fact, it could have been lying in wait for tens of generations before joining with the *Spelljammer*.

Any suitable inorganic item can become the host to an ultimate helm seed. By "suitable" we do not mean a 20-ton stone idol, but rather a weapon, a piece of jewelry, or an item of clothing.

THE LIFE CYCLE OF THE SPELLJAMMER



THE LIFE CYCLE OF THE SPELLJAMMER

Table 6: Random Ultimate Helm Generation

DMs are encouraged to flex their creativity in regard to the ultimate helms, but as a source of ideas (and for those experiencing a sense of despair), this table can be used to generate items for use as ultimate helms.

The listing here includes 20 "typical" items that may be used as ultimate helms. By no means is it a complete list of items that can be used, but it is a starting place. Adjacent to each item is the typical "base power" that the enchanted item will have.

d20 roll	Item	Base power
1	Slippers	Slippers of Spider Climbing
2	Boots	Boots of Elvenkind
3	Hat	Hat of Disguise
4	Gloves	Gloves of Missile Snaring
5	Cloak	Cloak of Displacement
6	Jewelry	Brooch of Shielding
7	Ring	Ring of Protection +1
8	Wand	Wand of Metal Detection
9	Staff	Serpent Staff
10	Stone	Luckstone
11	Statuette	Figurine of Wonderful Power
12	Eye Cusps	Eyes of the Eagle
13	Wings	Wings of Flying
14	Dagger	Dagger +3
15	Sword	Sword +1
16	War Hammer	War Hammer +2
17	Armor	Leather Armor +1
18	Armor	Plate Mail +1
19	Armor	Elven Chain Mail
20	Helm	Helm of Comprehending Language and Reading Magic

As you can see, the item used as an ultimate helm is *never* a "charged" device that must be recharged when all its powers have been drained. Keep this in mind when developing your own ultimate helms.

In addition to the listed (and detectable) powers above, the ultimate helm can have up to 1–10 extra powers. These are not readily detectable initially, but they will appear over time—frequently during a crisis situation. (In fact, the DM can choose to have the extra powers appear to save a character's hide.) The first usually appears 2–20 days after initial bonding, and each extra power 2–20 days after that.

Roll a d10 to determine the number of additional powers, then roll on the subtable on the following page. Roll a d10 for each power, *adding* the previous sum of all numbers rolled. That is, if three powers are called for and the first roll is a 5, the second a 6, and the third a 10, the item would have powers 5, 11 (5+6), and 21 (11+10). The more powerful abilities are at the high end of the scale and thus are only available to those helms that have a number of abilities.

If their normal spell equivalents are lost upon entering the *Spelljammer* (no summoning earth elementals there, for example), then those powers that the ultimate helm has are lost as well. Remember, the ultimate helm is destroyed when the player using it finally bonds with the *Spelljammer*.

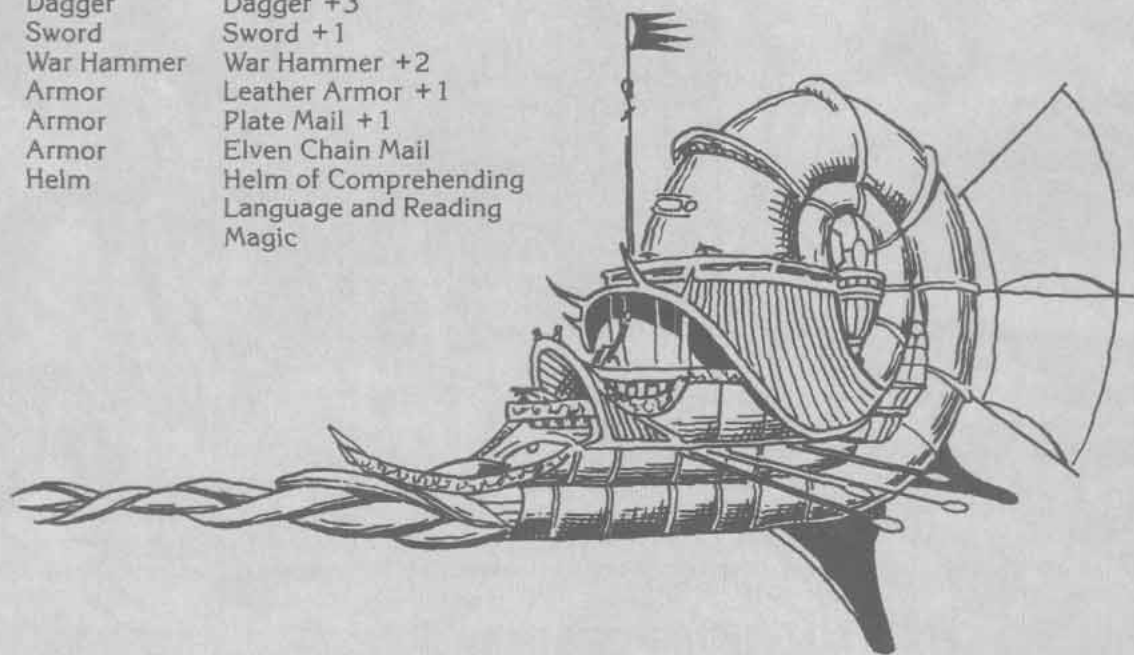

THE LIFE CYCLE OF THE SPELLJAMMER

Number	Additional power	Number	Additional power
1	Affect Normal Fires (2/day)	51	Dimension Door (1/day)
2	Burning Hands (2/day)	52	Fear (1/day)
3	Change Self (3/day)	53	Fire Shield (1/day)
4	Charm Person (1/day)	54	Fumble (2/day)
5	Chill Touch (2/day)	55	Ice Storm (1/day)
6	Detect Magic (3/day)	56	Improved Invisibility (1/day)
7	Feather Fall (2/day)	57	Minor Globe of Invulnerability (1/day)
8	Friends (2/day)	58	Polymorph Self (1/day)
9	Gaze Reflection (2/day)	59	Rainbow Pattern (1/day)
10	Hold Portal (2/day)	60	Shout (1/day)
11	Jump (2/day)	61	Solid Fog (1/day)
12	Light (3/day)	62	Stoneskin (1/day)
13	Magic Missile (1/day)	63	Wall of Fire (1/day)
14	<i>Protection from Evil</i> (1/day)	64	Wall of Ice (1/day)
15	Read Magic (3/day)	65	Wizard Eye (1/day)
16	Shield (2/day)	66	Airy Water (2/day)
17	Spider Climb (2/day)	67	Animate Dead (1/day)
18	Sleep (1/day)	68	Cloudkill (1/day)
19	Wall of Fog (1/day)	69	Cone of Cold (1/day)
20	Alter Self (1/day)	70	Conjure Elemental (1/day)
21	Blindness (1/day)	71	Fabricate (2/day)
22	Detect Invisibility (3/day)	72	Feeblemind (1/day)
23	Flaming Sphere (1/day)	73	Hold Monster (1/day)
24	Invisibility (1/day)	74	Passwall (1/day)
25	Knock (3/day)	75	Stone Shape (1/day)
26	Mirror Image (2/day)	76	Wall of Iron (1/day)
27	Misdirection (2/day)	77	Wall of Stone (1/day)
28	Scare (1/day)	78	Antimagic Shell (1/week)
29	Shatter (1/day)	79	Conjure Animals (1/week)
30	Strength (2/day)	80	Death Spell (1/week)
31	Web (1/day)	81	Disintegrate (1/week)
32	Whispering Wind (2/day)	82	Globe of Invulnerability (1/day)
33	Wizard Lock (2/day)	83	Invisible Stalker (1/day)
34	Blink (1/day)	84	Move Earth (1/day)
35	Delude (1/day)	85	Part Water (1/day)
36	Feign Death (1/day)	86	<i>Stone to Flesh</i> (1/day)
37	Fireball (1/day)	87	Charm Plants (1/day)
38	Fly (1/day)	88	Delayed Blast Fireball (1/day)
39	Gust of Wind (2/day)	89	Duo-Dimension (1/day)
40	Haste (1/day)	90	Phase Door (1/day)
41	Infravision (3/day)	91	Power Word, Stun (1/day)
42	Lightning Bolt (1/day)	92	Reverse Gravity (1/week)
43	Nondetection (1/day)	93	Statue (1/week)
44	<i>Protection from Normal Missiles</i> (1/day)	94	Teleport Without Error (1/week)
45	Slow (1/day)	95	Vanish (1/week)
46	Tongues (2/day)	96	Antipathy/Sympathy (1/week)
47	<i>Water Breathing</i> (2/day)	97	Maze (1/week)
48	Wraithform (1/day)	98	Prismatic Wall (1/week)
49	Confusion (1/day)	99	Symbol (1/week)
50	Detect Scrying (2/day)	100	Power Word, Kill (1/day)

(Also send out for pizza to celebrate, because you have just rolled 11 tens on a 10-sided die in a row. You might want to check out that die. . . .)

Italic items are reversible.

THE LIFE CYCLE OF THE SPELLJAMMER

The ultimate helm (with whatever aid the DM chooses to marshal) will attempt to get the helm bearer to the *Spelljammer* in the hopes that its candidate will become the next captain. Should it succeed, the helm will then disintegrate and become part of the *Spelljammer*, its own semisentience going back into the smalljammers that will be produced with the new captaincy. (The new captain will no longer need the helm to control the ship because he or she will have bonded with the ship by the time the helm disintegrates.)

The ultimate helm tests the candidate's worthiness in the passage to the *Spelljammer*. If the path appears too easy, misfortunes will set back the helm bearer. The ultimate helm recognizes that the more powerful the candidate, the better the chance of the bearer's success.

With a large number of ultimate helms in the universe, the odds are good that the would-be captain will arrive at the ship to find another captain in control. If this occurs, the two will be forced to do battle for control of the *Spelljammer*. The contenders may use any and all means at their disposal. The current captain, however, gains the abilities as noted above, but the challenger can still use his or her ultimate helm.

Note that the constant possibility of a challenger tends to make current captains very nervous. Also note that attacking the captain is not considered harmful to the *Spelljammer* (indeed, a new captain would mean a new Flight of Smalljammers), so that even those who come to challenge but are affected by the enchanted air of the *Spelljammer* will still be able to attack the captain.

The protection that the *Spelljammer* has with regard to the gods does not apply to its ultimate helms. As a result, other individuals may come looking for an ultimate helm, which accounts for the sudden increase in activity in the helm bearer's life (and possibly the shortness thereof).

The item that turns into the ultimate helm becomes stronger, and it gains a +4 to all saving throws. It can still be destroyed, however, at which point the energies of the helm are also destroyed.

(This destruction results in a blast of cold fire in a 20-foot radius for 4–24 points of damage.)

Captains

The captain gains particular powers when he or she first uses the ultimate helm. The following powers are permanent as long as the captain remains on board the *Spelljammer* (in effect, for the rest of his or her life):

- The captain is immune to the effect of all enchantment/charm spells.
- He is immune to all illusions and can witness things as if he had true sight (as per the spell).
- He loses the ultimate helm but without the usual attendant explosion (the helm merely dissolves).
- The captain can steer the ship as he sees fit.
- He can activate the sting of the *Spelljammer* at will.
- The captain can gather information from the ship via its detect life ability and the shivaks.
- He can order the shivaks to perform certain tasks.
- The captain remains captain until he is removed by the ship, is killed, or dies of old age. The *Spelljammer* will not allow the captain to leave the ship even after his captaincy has ended.

A number of edicts from the ship have been listed in this book. These are the basic rules by which the ship judges its captain. If the captain chooses to ignore these rules, the ship can and will remove him or her. Very few captains, if any, have ever survived this removal.

In summary, these rules are to:

- Never land the *Spelljammer* on a planet.
- Never harm the inhabitants of the *Spelljammer*.
- Never use fire in the phlogiston.
- Never act to destroy or intentionally harm the *Spelljammer*.
- Never attempt to leave.
- Never let any inhabitants leave.

There is some leeway in these rules in that the captain can harm the inhabitants of the ship if it is in self-defense.

The ultimate helm tests the worthiness of a would-be captain, who may suddenly find himself in the middle of some rather peculiar situations. . . .

THE LIFE CYCLE OF THE SPELLJAMMER



50X91

THE LIFE CYCLE OF THE SPELLJAMMER

As noted earlier, when a captain attempts to override the will of the *Spelljammer*, the DM should merely note that "You do not think this is a good idea." Do not force the captain to change his or her mind. If the player running the captain persists, secretly make a saving throw for the *Spelljammer* versus death magic. Modify this roll by +1 for every level or hit die the captain has above 15, with a "1" always failing.

If the *Spelljammer* makes the saving throw, nothing happens. If the saving throw fails, the *Spelljammer* will countermand the order and have the captain removed from the command bridge. The *Spelljammer* will leave that particular area immediately, and the link between captain and ship will be broken. The captain must make a saving throw versus death magic or perish. If he survives the throw, he will be unconscious for 1–10 hours, during which time the shivaks will carry the former captain to a cell in the highest tower, where he will be cared for the rest of his natural life. Companions and those aiding the former captain will be killed or imprisoned as well.

Once a captain is dead or removed, he is forgotten by the ship (though not by the inhabitants, should a player think to ask). There may well be two or three former captains on board, forgotten by the ship but still tended by servants. Inquiries into such areas are not discouraged, but few will think to ask about them.

To date, no former captain has survived his or her incarceration and lived to tell the outside world about it. This does not imply that such a feat is impossible, merely that it has not yet been successful.

Shivaks

The shivaks are the constructed helpers of the *Spelljammer*; they act as its eyes, ears, and hands for delicate work. The shivaks are omnipresent and generally nonviolent. They appear in a number of forms, most of which parallel the basic body designs of sentient races of known space: humanoid, centaurian, beholderian, neogian, serpentine, and one that

doesn't match up with currently known sentient creatures.

The shivaks are made of the same material as the skin of the *Spelljammer*, and they have a leathery, well-worn look. They do not communicate to the inhabitants or to outsiders, but merely perform their tasks.

The shivaks are solid, without detectable body organs except at their centers. There they will always have a portion of a spelljamming helm of some type. The spelljamming helms apparently provide these creatures with their motile power and abilities.

The shivaks are charged with healing the ship when it is damaged as well as dealing with dangerous invaders (including former captains). They share the detect life abilities of the great ship, but like the ship they cannot spot unliving or undead threats.

Many of the inhabitants give the shivaks a wide berth, mostly because attacking a shivak or preventing one from completing its duties will draw more shivaks to the location.

Shivaks are described in full in the new monsters section of the *The Grand Tour* book.



Shivaks appear in a number of forms, including humanoid, centaurian, beholderian, neogian, serpentine, and one other—a variation not readily identifiable.

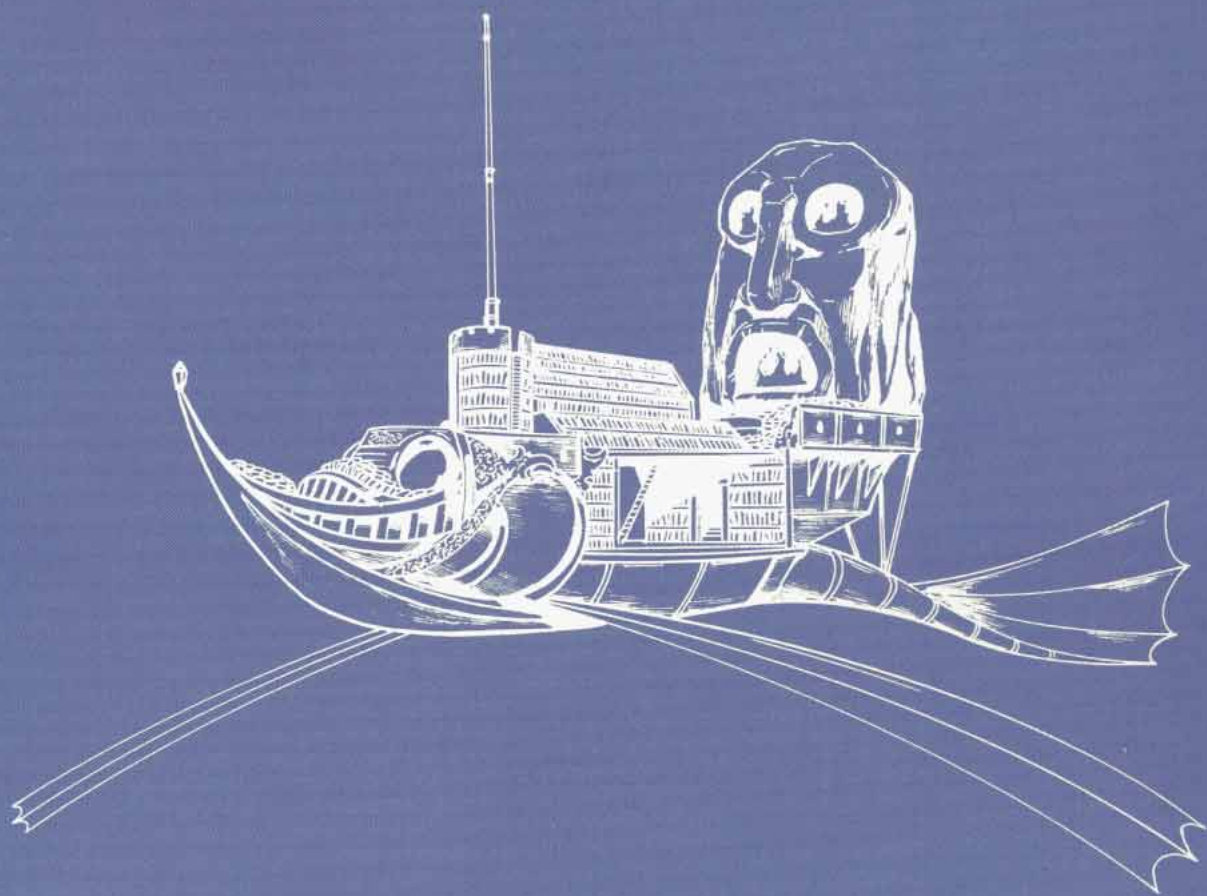

1065XXX1901

ADVANCED DUNGEONS & DRAGONS is a registered trademark owned by TSR, Inc.
SPELLJAMMER, and the TSR logo are trademarks owned by TSR, Inc. ©1991 TSR, Inc. All Rights
Reserved. Printed in the U.S.A.



Advanced Dungeons & Dragons[®]
2nd Edition

SPELLJAMMER[™]



Accessory

THE LEGEND OF SPELLJAMMER

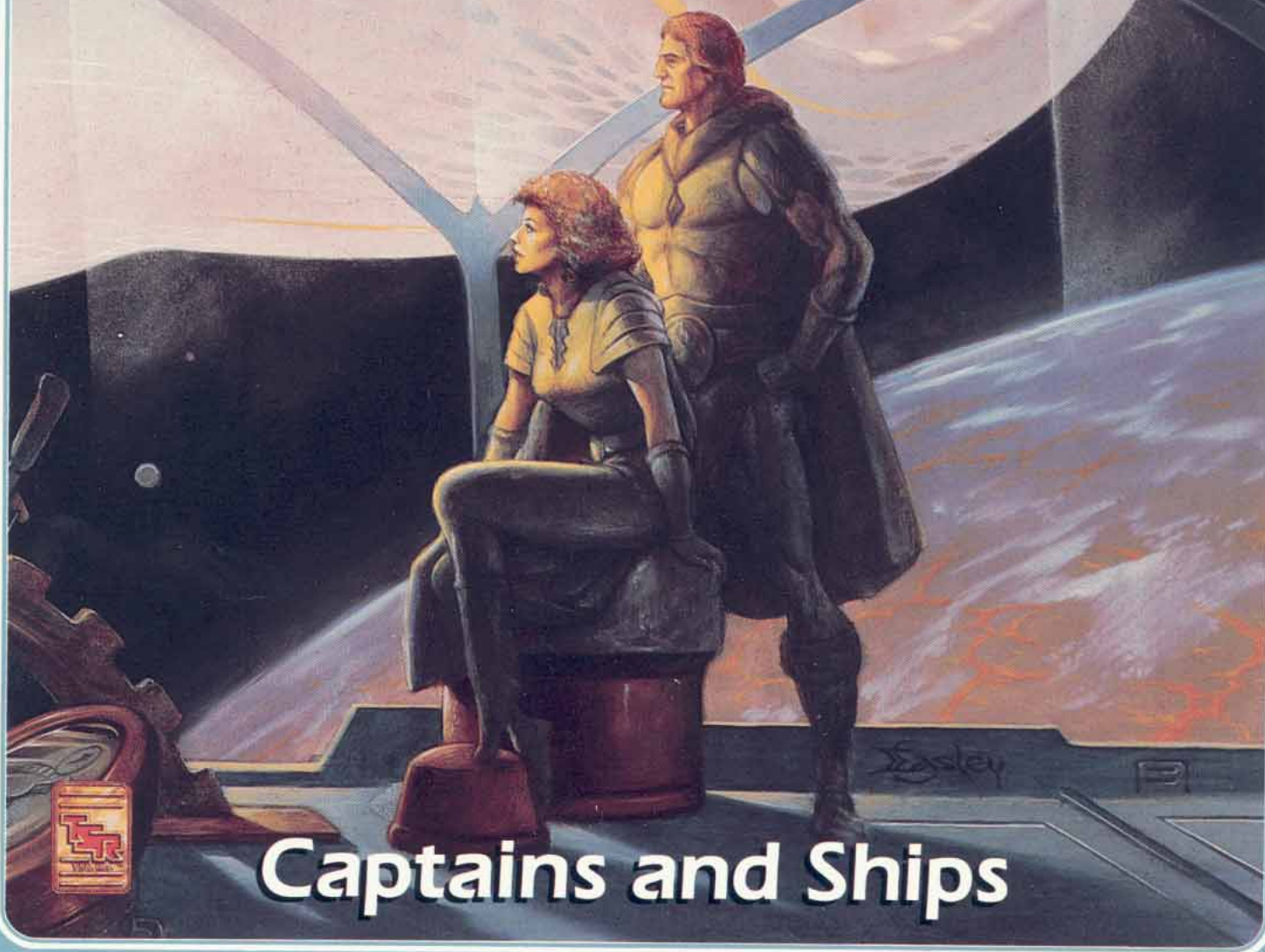

Captains and Ships



SPELLJAMMER[™]

Accessory

Ships and Captains

by Jeff Grubb

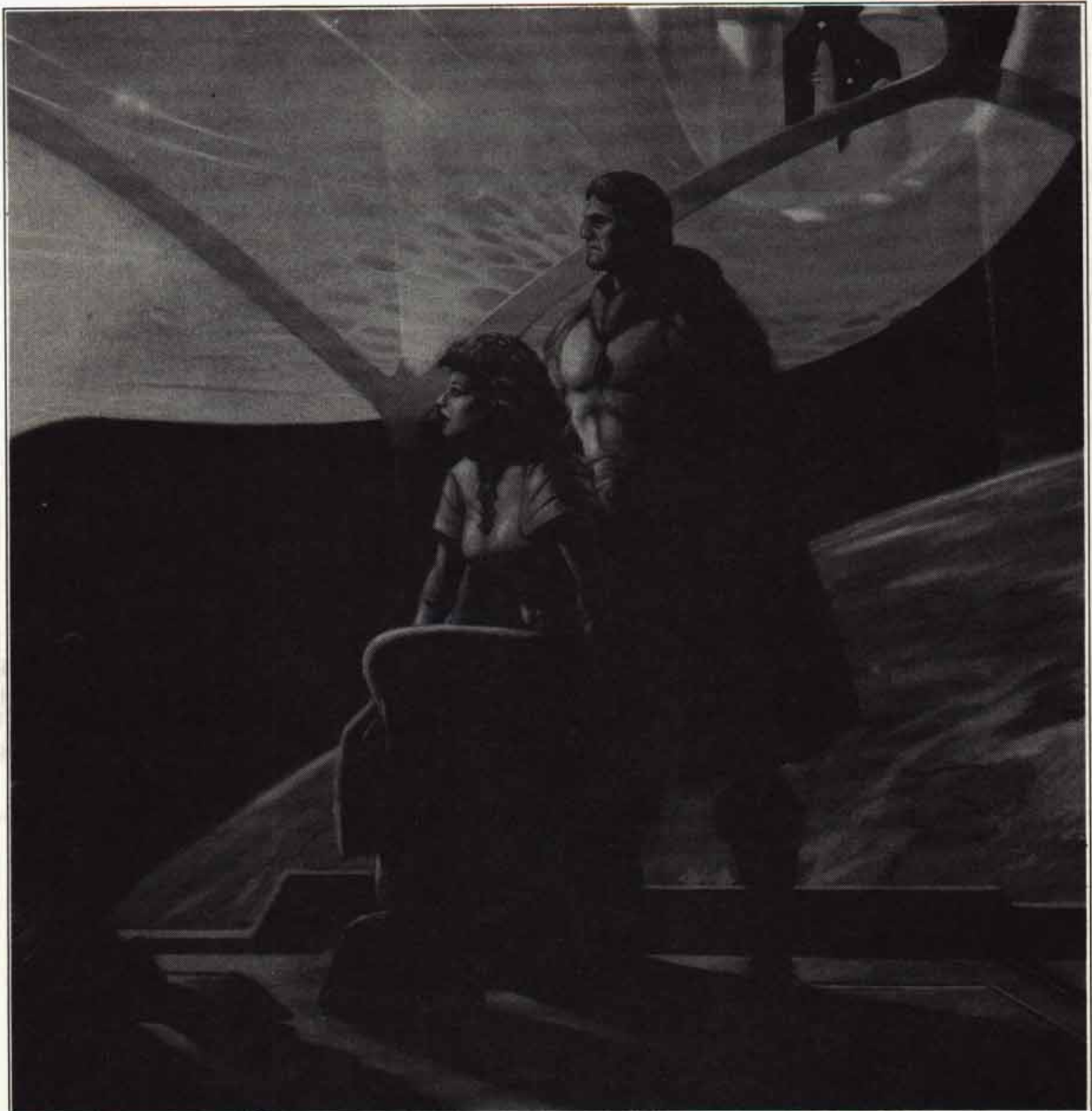

I have seen starry archipelagoes! and islands
Whose raving skies are opened to the voyager:
Is it in these bottomless nights that you sleep, in exile,
A million golden birds, O future Vigor?

—Arthur Rimbaud, *Le Bateau Ivre*, 1871

Design: Jeff Grubb
Editing: Steve "Old Man" Winter & Dori "the Barbarian" Watry
More Spiritual Guidance: James M. Ward
Cover Paintings: Jeff Easley
Ship Concepts & Illustrations: Jim Holloway
Ship Coloring: Les Dorscheid
Cartography: Diesel
Graphic Design: Stephanie Tabat
Production: Sarah Feggestad
Art Coordinator: Peggy Cooper
Typography: Gaye O'Keefe & Angelika Lokotz

TSR, Inc.
POB 756
Lake Geneva,
WI 53147 USA



TSR Ltd.
120 Church End, Cherry Hinton
Cambridge CB1 3LB
United Kingdom

ADVANCED DUNGEONS & DRAGONS, and AD&D are registered trademarks owned by TSR, Inc. SPELLJAMMER and the TSR logo are trademarks owned by TSR, Inc.
Printed in the U.S.A. Copyright © 1991 TSR, Inc. All Rights Reserved.

TABLE OF CONTENTS

The Shipyard	4	Kristobar	56
Terms	4	Leoster	57
Smalljammer	5	Miark the Blind	59
Unity Ships of the K'r'r'r	8	Mostias	60
Battle Dolphin	9	Nagasimi	60
Cuttle Command	11	Ollister	62
Great Bombard	13	Orik	62
Illithid Dreadnought	15	Selura	64
Octopus	17	ShiCaga	65
Quentin's <i>Libraria</i>	19	Si Loo	66
Gnomish Whelk	21	Stardawn	67
Leech	22	Suza the Brass	68
Urchin	24	Taja	70
Whaleship	26	Theorx	71
		Trebek	72
Personalities of the <i>Spelljammer</i>	28	Campaigning With the <i>Spelljammer</i>	74
Arcane	28	The Owl of the Mystics	74
Argargon	29	I. The Halfling's Package	74
Arvanon	29	II. Charity	75
Astor	32	III. Quentin	75
Breakox	33	IV. Leeches	76
Brother Burke	34	V. Arrival	76
CassaRoc	35	VI. Investigation	77
Chaladar	36	VII. Things in Passing	78
Chila	37	VIII. The Tower of Neridox	79
Coh	38	IX. Getting Off the Ship	79
Demets	39	X. Endgame	80
"Diamondtip"	41	The <i>Spelljammer</i> Campaign	82
Father Goat	41	I. Discovery	82
Firespitter	43	II. The Pursuit—H'Carth's Boys	83
The Fool	44	III. Pursuit Part 2—H'Carth's Ship	85
Gray Eye	47	IV. Search for the <i>Spelljammer</i>	86
Hancherback	48	V. Arrival	86
Highstar	49	VI. The Control Room	89
Hobgoblin Prophet	50	VII. Setting Up Shop	90
Hooded Soldier	52	VIII. The Dark Time	92
Jokarin	53	IX. Picking Up the Pieces, Further Adventures	94
Kaba Danel	54	X. Retirement and Moving On	95
Korvok	55		
Kova	55		

THE SHIPYARD

The ships in this section are tied in with the *Spelljammer* itself, from the lesser smalljammers which are its "young" to the ships that hunt it across the void. Many are unique, others are part of greater fleets.

Terms

Name: Common name of the ship type.

Built By: The race or entity which usually constructs this ship hull.

Used Primarily By: The race which generally uses this type of ship. This is usually (but not always) the building race.

Tonnage: Tonnage is a measure of the ship's volume, with one spatial ton equal to 100 cubic yards of air (a cube approximately 14 feet on a side). Tonnage determines hull points for the ship and the number of crew and passengers that may be safely carried.

Hull Points: The amount of damage the ship can take before breaking up.

Crew: The crew entry is represented by two numbers. The number before the slash is the number of crew members required to operate the ship at maximum maneuverability. The number following the slash is the maximum number of passengers the ship can carry without overtaxing the ship's atmospheric envelope. If only one number is present, this means that the ship generally cannot carry passengers, but only crew.

Maneuver Class: The rating of a ship's ability to turn and dodge. A is the highest maneuver rating, F is the worst.

Landing: Whether the ship can land on air or water without risking a crash. This feature does not affect ships using space docks.

Armor Rating: The resistance of the ship's hull to damage, similar to armor class for characters.

Saves As: Material the hull saves as for purposes of saving throws. Refer to page 25 of the *Concordance of Arcane Space* in the original SPELLJAMMER™ game.

Power Type: The usual spelljamming engine found with this ship type. Others are possible, but the ship is generally fitted with this type of engine.

Ship's Rating: The speed of the ship in tactical combat. Those ships that use major or minor spelljamming helms are noted as being variable according to the helmsman using that particular spelljamming helm.

Standard Armament: This is the typical weaponry of the ship. Armament varies radically from ship to ship, but this gives an idea of what might typically be carried.

Cargo: Amount of space available for cargo and other sundries, not including crew quarters, weapons, and maneuverability equipment. Cargo space can be dedicated to carrying cargo, more passengers (up to the stated limit), or additional weapons.

Keel Length: Length of the ship from front to back.

Beam Length: Maximum width of the ship from side to side.

Description: The general appearance of the ship.

The ships in this section are tied in with the *Spelljammer* itself, from the lesser smalljammers that are its "young" to the ships that hunt it across the void.

THE SHIPYARD

Crew: A section listing the various positions usually occupied by the crew, including chain of command. The usual location of the bridge and helm is also noted here.

Ship Uses: Most ships in this section are tailored to particular tasks, and those tasks are described in this section. While any ship can be used for almost any particular mission, certain ships are best suited to particular types of action.

Other Configurations: This last section represents common variants of the ships (except for the unique vessels). Various races make modifications to the ships for their own uses and these are also noted here.

Smalljammer

BUILT BY:	<i>Spelljammer</i>
USED BY:	Any race or none
TONNAGE:	20 tons
HULL POINTS:	20
CREW:	1/20
MANEUVER CLASS:	B
LANDING—LAND:	Yes
LANDING—WATER:	Yes
ARMOR RATING:	6
SAVES AS:	Leather
POWER TYPE:	Major or minor helm
SHIP'S RATING:	As helmsman
ARMAMENT:	None
CARGO:	15 tons
KEEL LENGTH:	60 ft.
BEAM LENGTH:	70 ft. (wingspan) 25 ft. (hull beam)

Description:

The smalljammer is a miniature version of the *Spelljammer* itself. It retains the basic manta shape with its upswept tail, but where the citadels would be on the larger ship the smalljammer has

enclosed crew quarters. Instead of a landing platform the bow quarters have a small outer deck as well as the command deck.

While this is the smalljammer's "true" appearance, very few see the ship as such from the outside world. A smalljammer can project an illusion around itself, usually of an asteroid, space creature, or some type of ship, up to a maximum of 50 tons. The illusion is perfect and undetectable until the atmospheric envelope is breached. The smalljammer does not gain the abilities of the ship it imitates but keeps its own abilities, which may provide sharp observers with clues as to its true nature (such as a surprisingly mobile asteroid, or a clumsy galleon turning at MC B).

Crew:

Only the helmsman is needed to operate the smalljammer. All others aboard are effectively passengers. As a result, the ship suffers no loss of maneuverability as long as the helmsman is in contact with the ship.

The smalljammer moves at spelljammer speeds without a helm only once in its life, on its initial flight. The flight lasts until it reaches a crystal sphere. The smalljammer enters wildspace and begins to drift, floating at "normal" speeds until found. The smalljammer, like the *Spelljammer*, has the ability to open portals in crystal spheres, but these portals do not remain permanently open.

Only major and minor helms operate with the smalljammer. Other helm types, including pool helms, will not function onboard the smalljammer. A lifejammer helm will kill the ship (saving throw vs. lightning applies, check every day the helm is used). Failing that saving throw turns the smalljammer into a lifeless hulk that will decay in 1-10 days. Although it will still move at spelljamming speeds, at the end of the noted time, it will break up.

The relationship between the smalljammer and

A smalljammer can project an illusion around itself, usually of an asteroid, a space creature, or some type of ship.

THE SHIPYARD

the helmsman is similar to the relationship between the great ship *Spelljammer* and its captain. However, the smalljammer does not have the finesse of its parent craft, so it reacts more strongly. If the helmsman acts in a fashion that the smalljammer does not approve of (such as placing it in danger), the helmsman must make a saving throw vs. spells or suffer intense pain and take 1-6 points of damage. In addition, in dangerous situations the helmsman must make a saving throw vs. spells or the ship will immediately flee at top speed for 1-6 turns.

The smalljammer recognizes one helmsman, much like the *Spelljammer* has but one captain. Usually this is the first person who uses the helm. Others are repulsed, and must make a saving throw vs. spells to avoid 1-6 points of damage. Once bonded, the smalljammer will answer only to its helmsman until death, or until the smalljammer rejects its helmsman. Each time the helmsman performs an action which causes the smalljammer to rebel, make a second saving throw for the helmsman vs. staves. If this saving throw is failed, the smalljammer rejects its helmsman and the next person to attempt to control the smalljammer becomes its new master.

Things which cause a smalljammer to rebel include leaving it alone for extended periods of time, crowding it with other ships or potentially hostile individuals, inflicting damage on its hull or interior, and exposing it to constant danger. The smalljammer cannot keep its helmsman on the ship, but does exert a psychic bond up to 10 miles away, calling for the helmsman to return. The smalljammer is responsive to its captain and passenger, such that it will form doorways, seal passengers, and otherwise create furnishing from its living hull.

Ship Uses:

The smalljammers are excellent exploration vessels, as they prefer the emptiness of space to

the potential strangers and dangers of civilized space. Their lack of armament, small need for crew, and high maneuverability make them ideal ships for solitary wizards, lone-wolf adventurers, and other individuals who prefer the quiet of space without a lot of other human activity. It is not a warship in any degree, but smalljammers have been used for smuggling in cases where the helmsman has ultimate trust with the ship.

Other Configurations:

There are no other configurations for the smalljammer other than what is noted here. The smalljammer cannot (or rather, will not) carry any weapon larger than a small catapult or ballista, and never carries bombards or smoke powder. If a larger weapon is placed on a smalljammer, the vessel simply retracts its leathery supports from around the weapon and lets it topple over the side (bolting it to the smalljammer would damage the creature).

Each smalljammer considers itself unique in the universe, and feels no family loyalty to either the *Spelljammer* or other smalljammers. The vastness of the Known Spheres and the fact that most smalljammers do not operate above an empathic level with their masters ensure that few ever meet after their initial flight. The result of such a meeting is unknown as one has never been observed.



Each smalljammer considers itself unique in the universe and feels no family loyalty to either the *Spelljammer* or other smalljammers.

THE SHIPYARD

Smalljammer

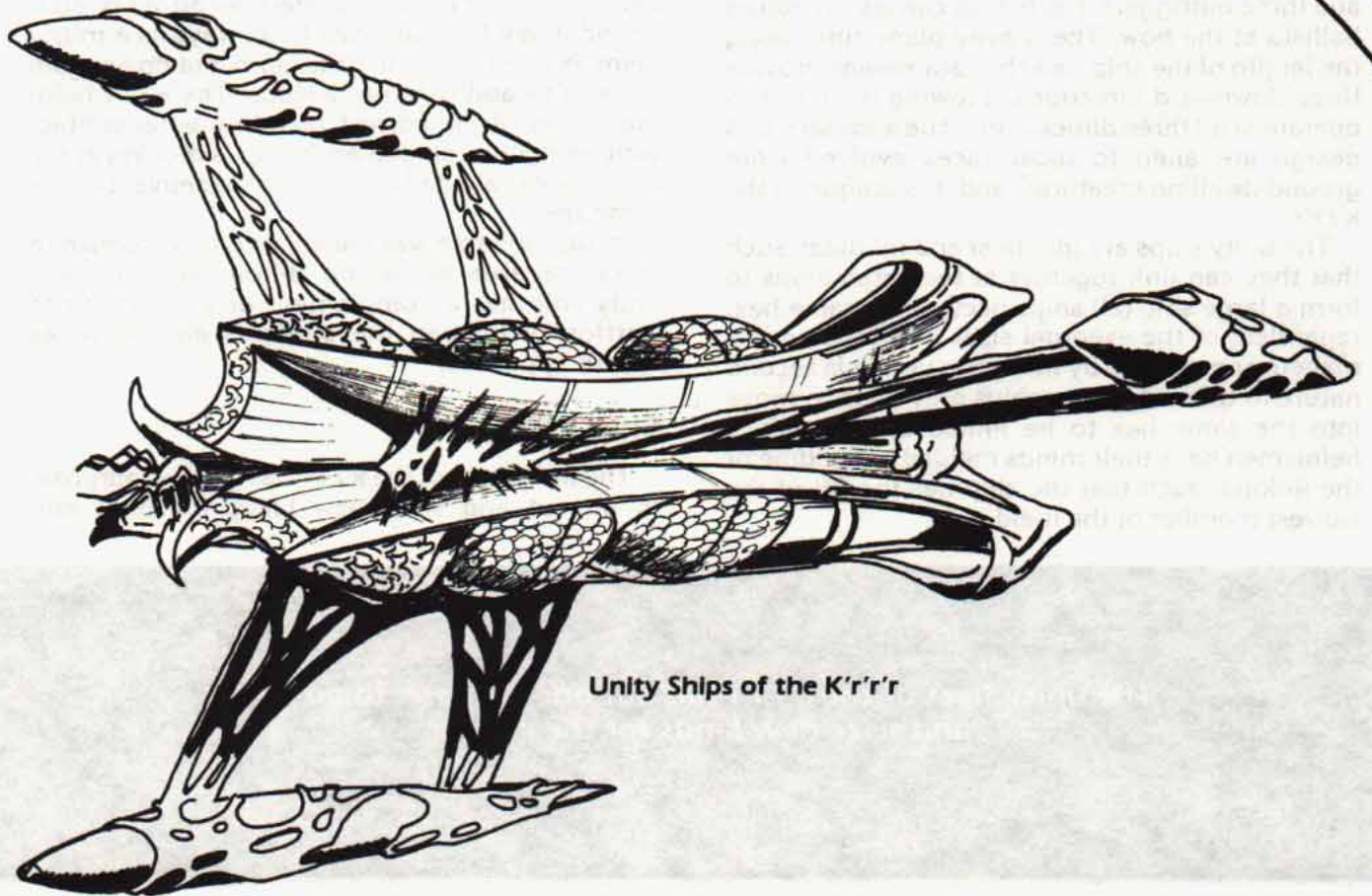
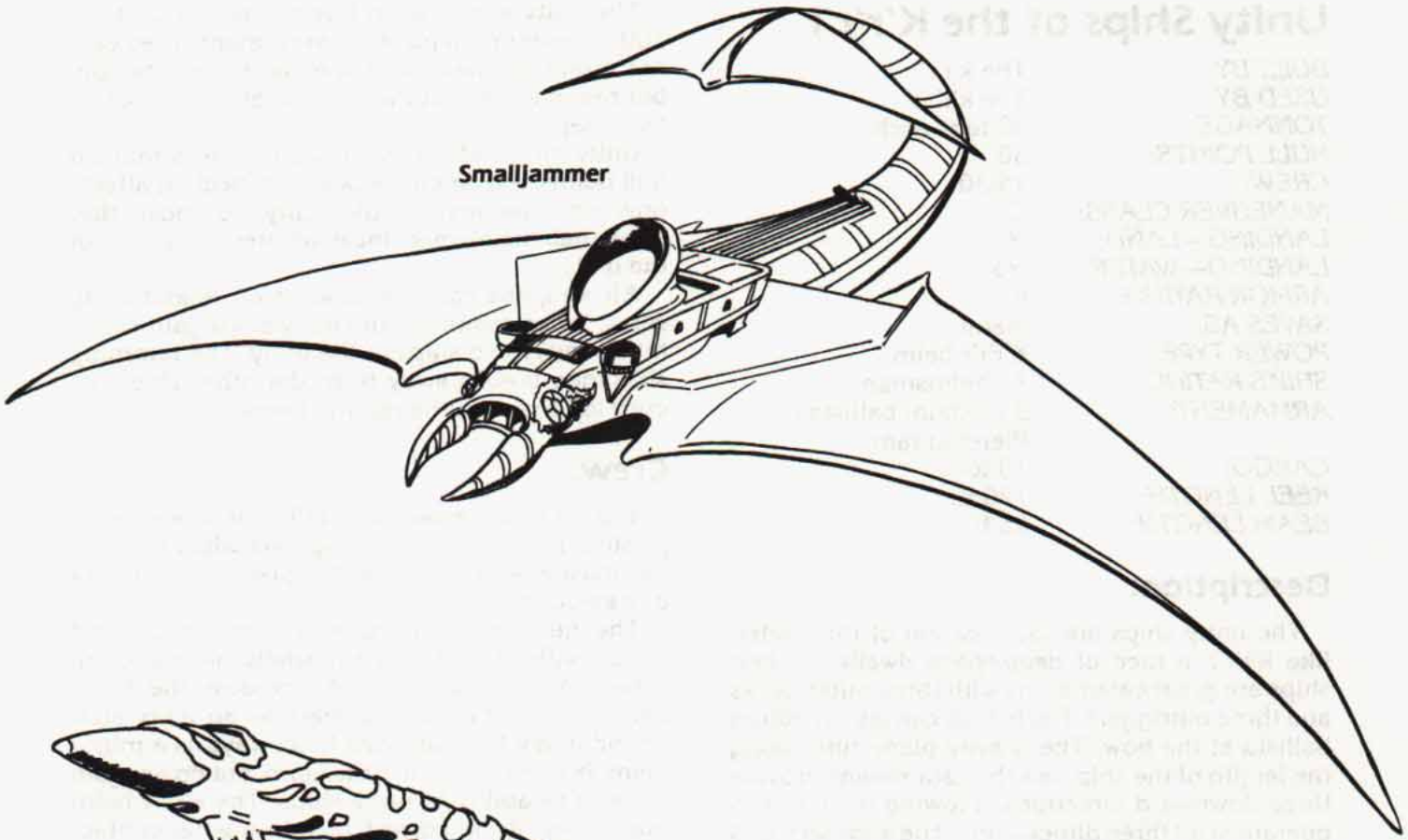

Unity Ships of the K'r'r'r

THE SHIPYARD

Unity Ships of the K'r'r'r

BUILT BY:	The k'r'r'r
USED BY:	The k'r'r'r
TONNAGE:	30 tons each
HULL POINTS:	30
CREW:	15/30
MANEUVER CLASS:	C
LANDING—LAND:	No
LANDING—WATER:	No
ARMOR RATING:	8
SAVES AS:	Metal
POWER TYPE:	K'r'r'r helm
SHIP'S RATING:	As helmsman
ARMAMENT:	3 medium ballistas Piercing ram
CARGO:	10 tons
KEEL LENGTH:	120 ft.
BEAM LENGTH:	25 ft.

Description:

The unity ships are the creation of the spider-like k'r'r'r, a race of deep-space dwellers. Their ships are great catamarans with three outer decks and three outriggers. Each deck carries a medium ballista at the bow. The gravity plane runs along the length of the ship, but the catamarans provide three downward directions, allowing the k'r'r'r to operate in all three dimensions. The approach and design are alien to most races evolved from ground-dwelling creatures, and it is unique to the k'r'r'r.

The unity ships are identical and modular, such that they can link together at the catamarans to form a large ship (all ships occupy the same hex, regardless of the eventual size). The binding is a maneuver practiced by the crews until it is second nature to them. The two ships only need to move into the same hex to be linked up. The k'r'r'r helmsmen have their minds melded at the time of the linking, such that the ship has the SR of the slowest member of the meld.

The unity ships can in this manner exceed the 100 ton maximum for most movement. They cannot attain spelljamming speeds in this fashion, but can maneuver at their ship's rating on the tactical map.

Unity ships which are linked have combined hull points and air envelopes. A critical hit affects only one member of the unity, so those that have their helmsmen incapacitated drop out of the unity.

All weapons can fire forward on linked unity ships. When ramming, the unity ships gain +1 to hit for every two ships in the unity. The ramming ship then breaks away from the other ships, its crew left to board the rammed vessel.

Crew:

The k'r'r'r are a race of intelligent space-faring pirates. They are fanatical fighters when led by a war master, who acts as both captain and leader of any assaults.

The helmsmen of the k'r'r'r are specialized priests with limited access to spells (all, guardian, protection, sun spheres). All possess the k'r'r'r helm. The k'r'r'r helm appears as an ivory staff bound in gold. It functions in all ways as a minor helm. Non-k'r'r'r can use the helm, but do not gain the k'r'r'r's ability to unite ships. The k'r'r'r helm puts users of the correct race in mental contact with each other, so that each ship is moving at the exact same rate and carries out maneuvers at the same speed.

In addition to a war master and two helmsmen (each capable of taking 8-hour shifts), each unity ship has a complement of a dozen k'r'r'r warriors who man the ballistas and serve as boarding parties.

Ship Uses:

The unity fleet of the k'r'r'r has but one purpose: to go out and seize new lands for their em-

The unity fleet of the k'r'r'r has but one purpose: to go out and seize new lands for the empire.

THE SHIPYARD

pire. The k'r'r'r have a preference for gas worlds, dwarven citadels, and asteroid bases, but any spacial body up to size A is a potential target. Such targets must be cleansed of non-k'r'r'r life, after which the new owners can settle down to establishing their colony and building more unity ships.

The individual vessels of the k'r'r'r unity fleet are launched in a straight line, far enough apart to prevent each one's gravity field from interfering with the others. When a unity fleet is encountered, a new unity ship appears each round, from the same direction and on the same vector as the previous ship, until the entire fleet is assembled. There are usually 4-24 (4d6) ships in a k'r'r'r unity fleet.

The best (possibly the only) tactic for surviving a k'r'r'r attack is to hit them hard as they slow to tactical speed, before they can unite. A unity of several ships forms a mobile fortress that can knock most other ships out of the sky. Yet individual vessels are weak enough that the k'r'r'r's opponents may make short work of them.

Other Configurations:

K'r'r'r ships are rarely used by other races because of their triaxial design. K'r'r'r helms are fairly common, as the helms also make beautiful walking canes.

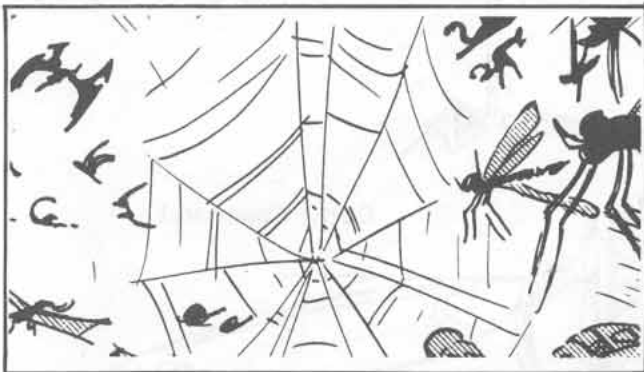

Battle Dolphin

<i>BUILT BY:</i>	Humans
<i>USED BY:</i>	Any race
<i>TONNAGE:</i>	70 tons
<i>HULL POINTS:</i>	70
<i>CREW:</i>	12/70
<i>MANEUVER CLASS:</i>	D
<i>LANDING—LAND:</i>	No
<i>LANDING—WATER:</i>	No
<i>ARMOR RATING:</i>	5
<i>SAVES AS:</i>	Wood
<i>POWER TYPE:</i>	Major or minor helm
<i>SHIP'S RATING:</i>	As helmsman
<i>ARMAMENT:</i>	2 medium catapults
<i>CARGO:</i>	35 tons
<i>KEEL LENGTH:</i>	250 ft.
<i>BEAM LENGTH:</i>	30 ft.

Dolphin-Shuttle

<i>BUILT BY:</i>	Humans
<i>USED BY:</i>	Any race
<i>TONNAGE:</i>	20 tons
<i>HULL POINTS:</i>	20
<i>CREW:</i>	4/20
<i>MANEUVER CLASS:</i>	C
<i>LANDING—LAND:</i>	No
<i>LANDING—WATER:</i>	Yes
<i>ARMOR RATING:</i>	6
<i>SAVES AS:</i>	Wood
<i>POWER TYPE:</i>	Major or minor helm
<i>SHIP'S RATING:</i>	As helmsman
<i>ARMAMENT:</i>	None
<i>CARGO:</i>	15 tons
<i>KEEL LENGTH:</i>	40 ft.
<i>BEAM LENGTH:</i>	15 ft.

Description:

The graceful battle dolphin is the latest human ship to appear in any quantity in the void. It combines a number of design features necessary to

The graceful battle dolphin is the latest human ship to appear in any quantity in the void. It combines a number of design features necessary to human travel and commerce in space.

THE SHIPYARD

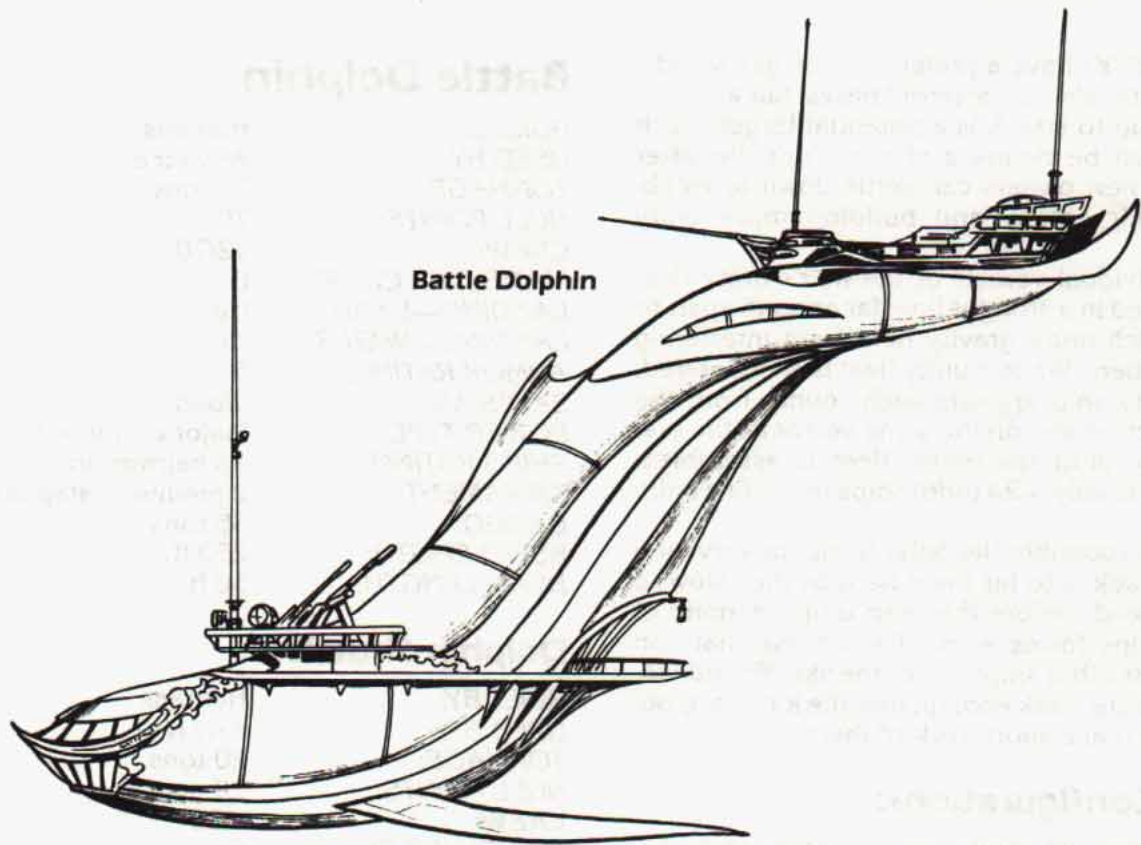

Battle Dolphin

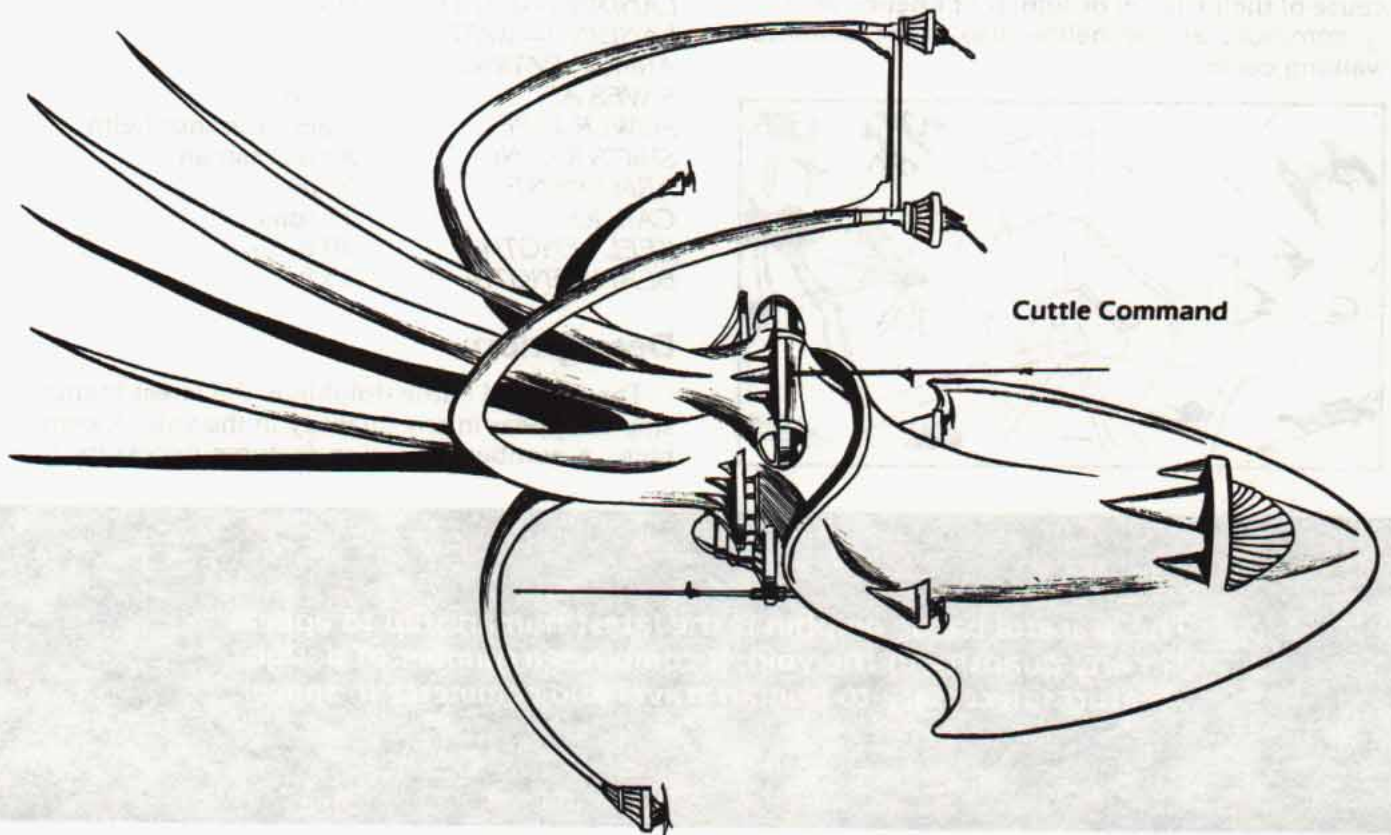

Cuttle Command

THE SHIPYARD

human travel and commerce in space. Like the hard-shelled nautiloids, the bulk of the battle dolphin is enclosed. It maintains an upper "surveillance" level which places it above the decks of opposing ships. Most importantly, the galleonlike portion of the upper deck can separate from the main ship and make planetary landings. The small galleon is less likely to attract attention in the port of Waterdeep and similar venues than a fully-armed hammership.

Crew:

The headquarters of a battle dolphin may be located either in the forward bridge or in the detachable upper deck. Which one is used depends on the number of helms available and their common use. If two helms are available, then one will be mounted on either deck. If one helm is used, then it is mounted on the upper deck, unless the "lander" has other magical means of propulsion.

The remainder of the crew is needed for the combined sails (one lateen-rigged above the forward bridge, two other square rigs on the lander) and to man the medium catapults (mounted directly behind the bridge).

Ship Uses:

The battle dolphin, sometimes just called the dolphin, is quickly becoming a popular ship for adventurers and other small parties, in particular those which need to make planetfall on large worlds filled with groundlings. The lander unit allows access to most worlds without arousing attention, while the main body of the ship is laid out to meet the challenges of wildspace.

The greatest flaw in the design is the placement of the helms, particularly when only one helm is available. Either the adventurers must keep the helm with the lander, making it the center of operations, or forego the advantage of the lander to make the forward bridge the location of the helm. Further, once the lander is away from the main

ship, the ship is helpless if the only helm is aboard the lander. As a result, either mobile helms (like the crown of stars), or two helms (one of which is kept off line) are sought by adventurers using the battle dolphin. The Arcane, who market such helms, are overjoyed by the additional need for these items that this ship design provides.

Battle dolphins are being constructed in shipyards throughout the known spheres, as the ship becomes more popular. Whether it is a long-lasting design (like the hammerships) or one more attempt to be later abandoned remains to be seen.

Other Configurations:

The battle dolphin is a new ship, and as a result, very few modifications have been seen yet. Most modifications involve a change of weaponry, to ballistas or (in one noted case) bombards. Several shipyards do mount a piercing ram on the forward bridge, removing the windows in the process. This variant is called the narwhal.

Cuttle Command

<i>BUILT BY:</i>	Humans, mind flayers
<i>USED BY:</i>	None
<i>TONNAGE:</i>	100 tons
<i>HULL POINTS:</i>	100
<i>CREW:</i>	30/100
<i>MANEUVER CLASS:</i>	E
<i>LANDING—LAND:</i>	Yes
<i>LANDING—WATER:</i>	No
<i>ARMOR RATING:</i>	8
<i>SAVES AS:</i>	Wood
<i>POWER TYPE:</i>	Major or minor helm
<i>SHIP'S RATING:</i>	As helmsman
<i>ARMAMENT:</i>	4 heavy ballistas 2 heavy catapults 1 heavy jettison
<i>CARGO:</i>	50 tons
<i>KEEL LENGTH:</i>	120 ft. (high)
<i>BEAM LENGTH:</i>	Variable

Battle dolphins are being constructed in shipyards throughout the Known Spheres as the ship becomes more popular. Whether it is a long-lasting design (like the hammerships) or one more attempt to be later abandoned remains to be seen.

THE SHIPYARD

Description:

The cuttle command is a ten-story-tall tower in space. It is even taller than it is wide along its hull. It maintains its gravity plane by having large weapons mounted on four of the eight tentacles. These tentacles extend far enough horizontally to change the orientation of the gravity plane to a horizontal axis running through the eyes of the cuttle. As a result, the cuttle is much bulkier and nowhere near as maneuverable as a ship built along normal lines.

Crew:

The cuttle was set up as a command ship and information center, with the "brains" hidden within the protective shell. The ship's functions, including the spelljamming helm, were installed behind the ship's eyes, where they would be out of the way. The cuttle could support a full command staff, and included about half its number in heavily-armed raiders and defenders. Cuttles were historically well-armed with magic as well.

Ship Uses:

The cuttle was originally built for the Unhuman Wars as a mobile command base. It was primarily designed and used by humans, though it used many of the same design techniques as the octopus. The cuttle appealed to human wizards in particular. Despite the natural laws of space survival, wizards felt "safer" in a towerlike setup.

The outer tentacles of the cuttle are usually fixed in place, but can be pulled in close to the ship. This was only done in emergencies, because while it increases maneuverability to MC C, it also shifts the gravity plane to the vertical axis, which has a dramatic effect on anything that is not bolted, strapped, or nailed down.

Only about 20 cuttles were originally built, though the plans were handed off from mage to

mage through half a hundred worlds as a curiosity. The cuttle was to be the answer to the Elven Armada, proof that an organized human community could create great ships to destroy the raiding goblins. Unfortunately, the human organization proved to be less cohesive than the elven navy, and in the one great battle they fought in, cuttles appeared on both sides of the fight—turncoat mercenaries seized one ship and turned it against human builders.

Vintage cuttles are now mostly abandoned, torn apart or parked out on some asteroid to quietly fall apart. When in use, they often serve as towers for spaceborne wizards who do not wish to be disturbed.

However, the plans for the cuttles were relayed from world to world by an "old mage" network, so occasionally a new vessel appears, usually scratch-built jobs piloted by the same wizard who built it. On a number of worlds, cuttles were begun for protection (or out of curiosity), and later abandoned. In one case a town grew up around an abandoned cuttle, and the ship is the major feature of the skyline.

Other Configurations:

The cuttle's precarious gravity plane simultaneously cries out for modification at the same time that it makes modification extremely difficult. Adding or subtracting armor tends to unbalance the ship with tragic results. This is a reason that many cuttles have been abandoned or unfinished; they have limited potential for personal changes.

Most cuttles have the armament listed, but there are occasional all-catapult or all-ballista versions. There was a greek fire projection cuttle, *Ultimate Victory*, but it was destroyed in a mutiny when the mutineers captured one of the weapon platforms and turned it against the ship. The burned remains are said to be abandoned somewhere in the Sea of Dust on Oerth.

The outer tentacles of the cuttle can be pulled in close to the ship to increase maneuverability, but this also shifts the gravity plane to the vertical axis, which has a dramatic effect on anything that is not bolted, strapped, or nailed down.

THE SHIPYARD

Great Bombard

<i>BUILT BY:</i>	Giff
<i>USED BY:</i>	Giff
<i>TONNAGE:</i>	40 tons
<i>HULL POINTS:</i>	40
<i>CREW:</i>	20/40 (10 giffs)
<i>MANEUVER CLASS:</i>	E
<i>LANDING—LAND:</i>	No
<i>LANDING—WATER:</i>	Yes
<i>ARMOR RATING:</i>	6
<i>SAVES AS:</i>	Thick wood
<i>POWER TYPE:</i>	Major or minor helm
<i>SHIP'S RATING:</i>	As helmsman
<i>ARMAMENT:</i>	1 great bombard 2 light ballistas Blunt ram
<i>CARGO:</i>	20 tons
<i>KEEL LENGTH:</i>	140 ft.
<i>BEAM LENGTH:</i>	20 ft.

Description:

The great bombard resembles a single-decked groundling bireme, and indeed such craft were initially used as the frames for early versions of this vessel. Its rowing banks are planked over and its prow removed, replaced with a huge bombard of cold iron banded with steel rings, which runs half the length of the ship.

The great bombard is dominated by its gun, which has the following stats:

Cost: 60,000 gp (when available at all)
Range: 4 hexes (2,000 yards)
Damage: 3d10 hit points
2d12 hull points

Crew: 5
Rate of Fire: 1/3
THACO: 16
Critical Hit on 19

The bombard may also be capped with a great brass blunt ram, usually sculpted in the shape of a giff's head.

Great Bombard

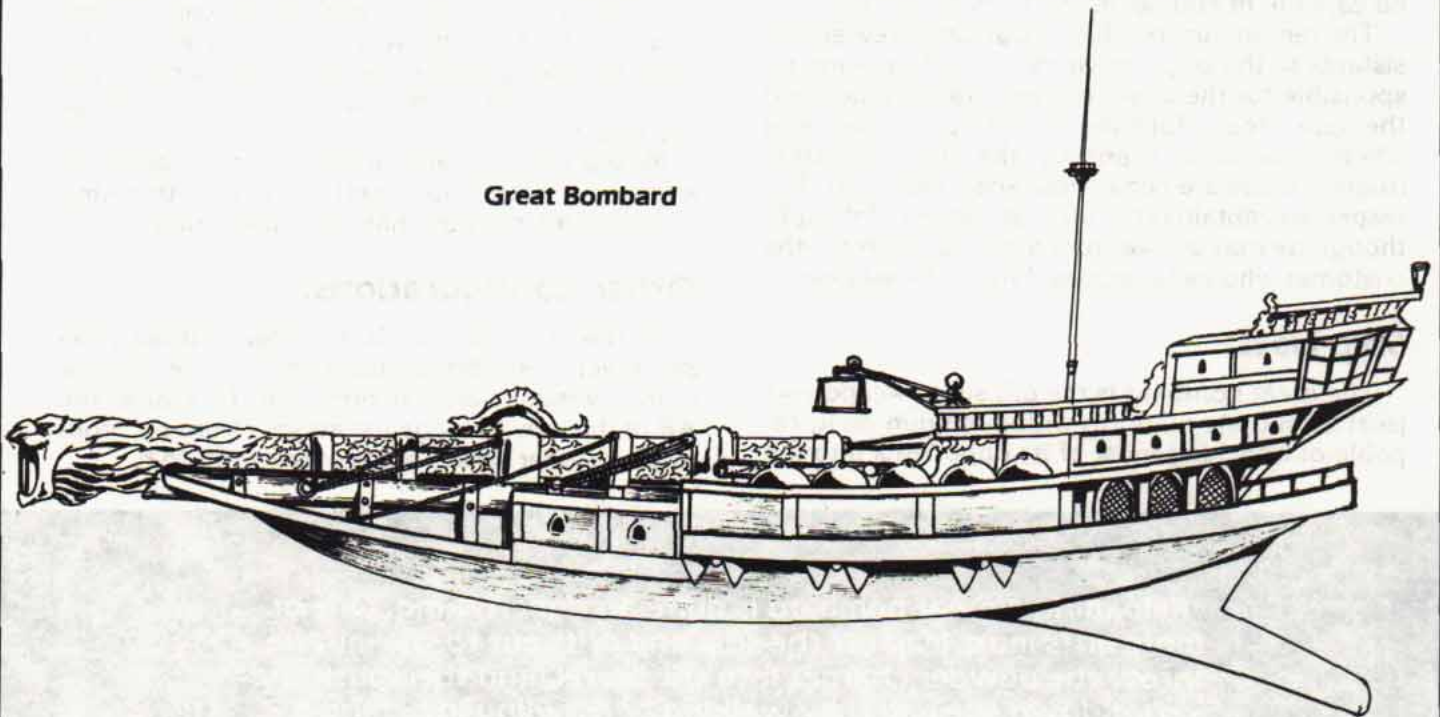

THE SHIPYARD

The great bombard fires stone shot, and uses 20 charges of smoke powder to loft the ball. These charges are usually kept in pre-measured tin drums onboard ship. Any critical hit against a great bombard has a 10% chance of igniting the powder room, inflicting 3d10 x 5 points of hull damage (this is greater than normal because in addition to the great bombard's powder, there will be considerable additional smoke powder belonging to the crew).

The bombard can only fire in the direction the ship is moving. In game terms, this means that the bombard will only fire along a straight row of hexes, which the ship is facing. The bombard may fire at the beginning or the end of its turn, at the captain's order.

Crew:

The four chief officers of a great bombard are the respected captain, the noble helmsman, the puissant crafter, and the master gunsman. The master gunsman is responsible for firing the bombard. The puissant crafter is responsible for maintenance. The noble helmsman operates the helm (or more usually is in charge of the human or other individual operating the helm), and the respected captain, of course, gives the order to fire.

The remaining six giff of a standard crew are assistants to the ship's masters, as well as being responsible for the ship's maneuverability, keeping the gun clean, forming boarding parties, and when necessary, manning the light ballistas (though these are considered sissy weapons). The respected captain is the ultimate leader of the giff, though he may answer to a higher authority—the customer who has purchased the giff's services.

Ship Uses:

The great bombard is the giff super-weapon—a (sort of) mobile platform with a big gun on it, capable of knocking most of its opponents into the

next crystal sphere. However, as it is dominated by its gun, the captain and crew of the great bombard are continually in service, seeking to earn enough smoke powder to be able to fire the weapon.

As a result, great bombards are usually out for hire, mercenaries in the line for other organizations. They are preferred by small factions and races who do not have their own fleets, as the bombard is often more effective as a threat than as an actual weapon. In action, it is almost as great a danger to foe as it is to friend.

The greatest danger to someone facing a great bombard is whether the bombard truly has enough powder to fire or not. Often a canny giff will wait until the ship is within ramming distance before firing off the gun, simply to raise the level of tension among the enemy crew.

Reloading a great bombard is quite an undertaking, considering that the muzzle usually projects beyond the ship's deck. One or more giffs must leap off the ship and drift out to the muzzle, throw the powder charges down the barrel, and then push the shot down the barrel by walking or crawling in behind it. To the giff, of course, this is great fun.

There are about two dozen great bombards in Known Space, which form a loose brotherhood of giff known as the Cult of the Gun. All captains are cult members by the very act of possessing the great bombard, and an unspoken rule is not to fire on another great bombard, as it might damage the weapon.

Most great bombards are mercenary vessels but a few have gone pirate, getting more with a kind word and a large gun than with just a kind word.

Other Configurations:

As the great bombards are often without powder, several sensible captains armor-plate the bow of their vessel to aid it in ramming. This raises the AR of the bow to 5 against attacks from the front (such as other rams), but drops the MC to F.

Reloading a great bombard is quite an undertaking. One or more giffs must leap off the ship and drift out to the muzzle, throw the powder charges into the barrel, and then push the shot down the barrel by walking or crawling in behind it.

THE SHIPYARD

When possible (and smoke powder is available), the giff will replace the light catapults with typical bombards. These will be mounted on heavy, swiveling bases, giving them a THACO of 19, but the giff are more comfortable with them.

Illithid Dreadnought

BUILT BY:	Mind flayers
USED BY:	Mind flayers
TONNAGE:	90 tons
HULL POINTS:	90
CREW:	20/90 (usual maximum of 25 mind flayers)
MANEUVER CLASS:	E
LANDING—LAND:	No
LANDING—WATER:	Yes
ARMOR RATING:	4
SAVES AS:	Thick wood
POWER TYPE:	Pool helm
SHIP'S RATING:	5
ARMAMENT:	2 large catapults 4 medium ballistas 1 large jettison Piercing ram
CARGO:	45 tons
KEEL LENGTH:	100 ft.
BEAM LENGTH:	90 ft.

Description:

The newest and largest ship in the mind flayer fleets, the dreadnought represents the full exploitation of the pool helm to produce ships above 50 tons (but still beneath the apparent 100 ton maximum).

The dreadnought looks like a great snail-shell laid on its side, resting on two hulls. The hulls are similar to the forward halves of the standard nautiloid, the workhorse of the illithid fleets. One of the hulls is known as the command hull, and contains the officers' quarters, while the other is the battle hull, and is used for ramming. Both hulls mount

catapults for assaults.

The interior of the shell is a single great vault, similar to the interior of the nautiloids. Walkways around the perimeter provide access to the ballista stations and the various officer's posts. The vault is lit with red hues and dominated by the glowing pool that provides the motive force for spelljamming. The captain's post is on a catwalk over the pool.

Crew:

One mind flayer is deadly. Twenty-five of them, the maximum number to be found on a dreadnought, are a disaster waiting to happen. Early reports about the abilities of the pool helms seem to have been inflated, and the pools are as limited as the other forms of standard spelljamming drives—they are held to the 100 ton limit.

The size restraint on crew for the mind flayers seems to be a doctrinal restriction by the race rather than any physical requirement. On most illithid ships, advancement is by assassination, and captains prefer to place their best, brightest, and most dangerous officers in positions of authority and danger, in the hopes that they will be either kept busy or killed before the officers get the idea of killing the captain.

On a dreadnought the leaders consist of the captain and four staff officers. Titles run along the lines of maintenance, weapons, navigation, and morale, but in duties all are interchangeable. Each staff officer maintains his own group of followers among the other mind flayers of the ship. Wise captains play one side off another to retain control, as no officer would place the ship in danger just to advance his own career (at least, not if he could get caught doing it).

The remainder of the crew consists of slaves. The bulk of the slaves are humans, gnomes, and other races captured from enemy ships and impressed into service. In addition, each officer and the captain maintains a personal slave who is not

On most illithid ships, advancement is by assassination, and captains prefer to place their best, brightest, and most dangerous officers in positions of authority and danger.

THE SHIPYARD

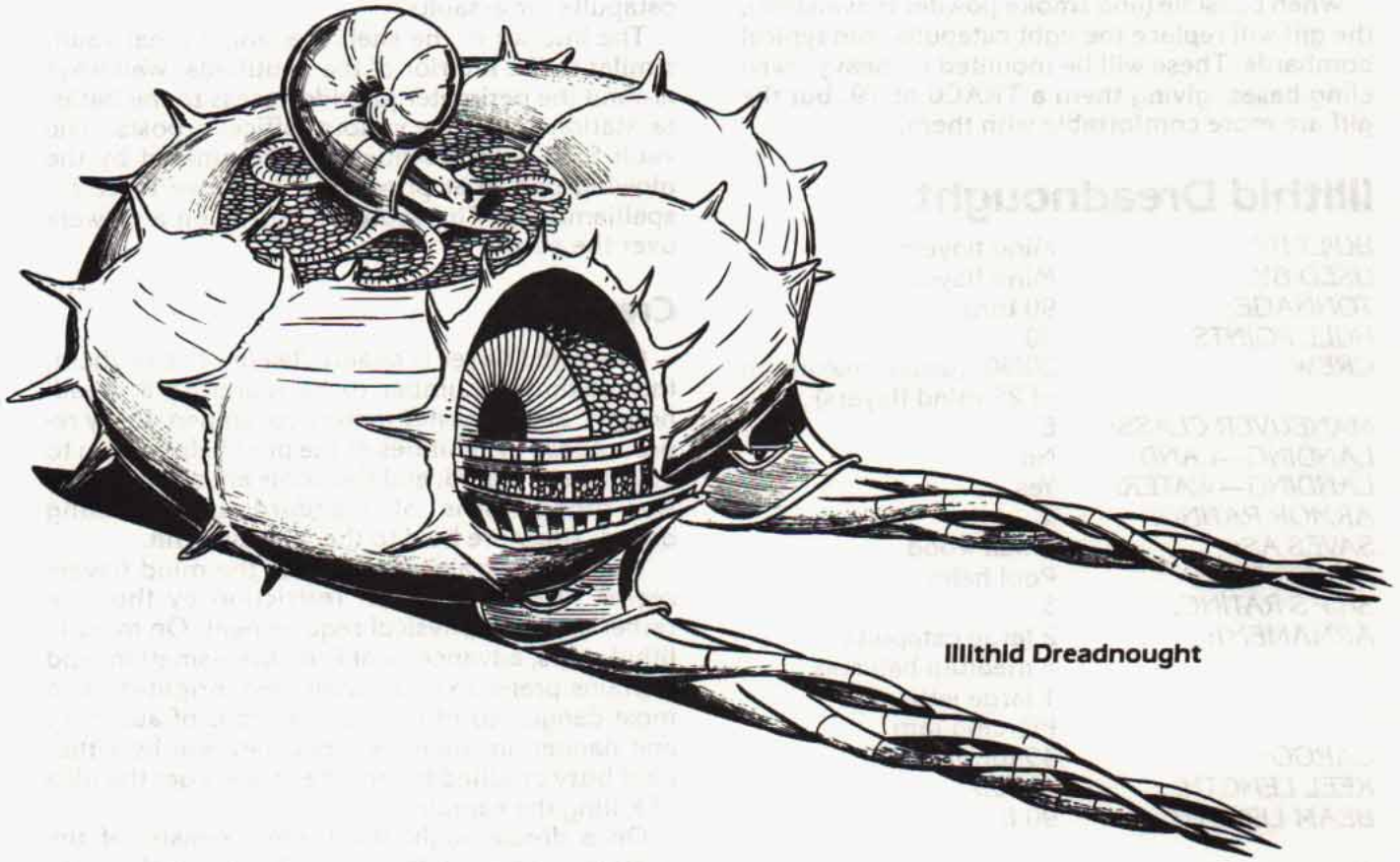

Illithid Dreadnought

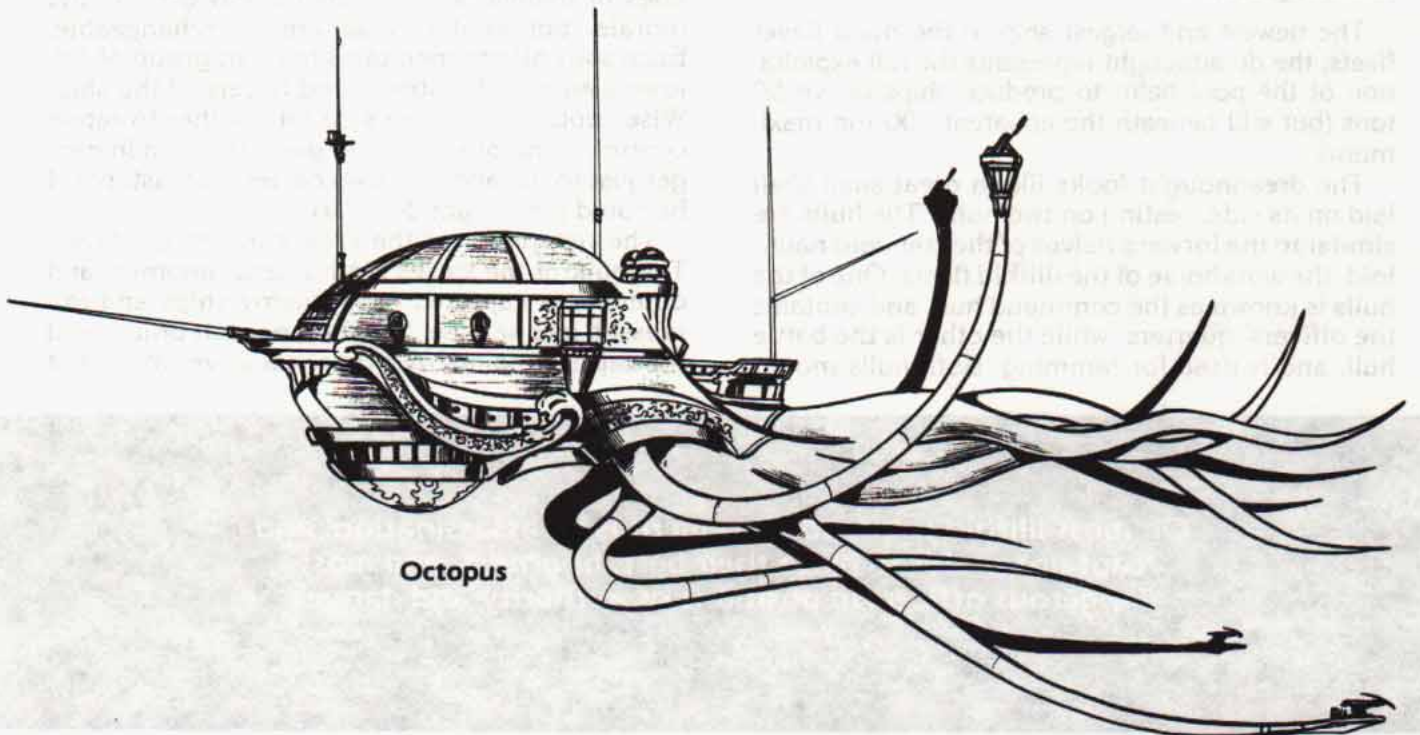

Octopus

THE SHIPYARD

bound by shackles (though they may be charmed or otherwise ensorcelled to serve the illithid loyally). The personal servants are treated as loyal pets, and are counted on to pass on any information they get from other slaves as to the ship's political climate, in addition to performing all odd jobs for their masters. These servants are treated better than the standard illithid slave, but run the risk of having their brain sucked out if their master has a bad day.

Ship Uses:

The dreadnoughts have only appeared within the last year, and are still relatively rare. They usually appear in large-scale mind flayer activity, in particular in cases where the mind flayers wish to drive a particular point home. Usually in such "diplomatic" missions, the dreadnoughts are escorted by two to four nautiloids.

Lone dreadnoughts are now being used as exploration craft, particularly in areas known to have active spelljamming races. A large, powerful ship, manned by mind flayers, tends to make a good impression on newcomers to the spelljamming community.

Other Configurations:

Given any new invention, there will be those seeking to get hold of it. The first dreadnoughts encountered in many spheres have not been accredited representatives of the illithids, but various rogues, outlaws, and pirates who can use a great ship in their raids. Apparently the various shipyards building the dreadnoughts had no problem "losing" a ship or two, which found its way into other hands.

Pirate dreadnoughts are lighter and slightly more maneuverable, given maneuver class D while having an armor rating of 6. They also tend to have additional breeches in the main shell, behind which are mounted light ballistas (up to six maximum).

There are stories of a heavy dreadnought with an armor rating of 2 and a maneuver class of F, but armed with four heavy catapults and eight heavy ballistas. This, like the earlier promises as to the effectiveness of the pool helm, should be seen before it is believed.

Octopus

<i>BUILT BY:</i>	Humans, mind flayers
<i>USED BY:</i>	Humans, mind flayers
<i>TONNAGE:</i>	70 tons
<i>HULL POINTS:</i>	70
<i>CREW:</i>	13/70
<i>MANEUVER CLASS:</i>	D
<i>LANDING—LAND:</i>	Yes
<i>LANDING—WATER:</i>	No
<i>ARMOR RATING:</i>	7
<i>SAVES AS:</i>	Wood
<i>POWER TYPE:</i>	Major/minor helm, pool helm
<i>SHIP'S RATING:</i>	As helmsman
<i>ARMAMENT:</i>	2 heavy catapults 2 heavy ballistas
<i>CARGO:</i>	35 tons
<i>KEEL LENGTH:</i>	100 ft. (not including tentacles)
<i>BEAM LENGTH:</i>	60 ft.

Description:

A huge ship reminiscent of the earthly cephalopod of the same name, the octopus moves through the void in a manner similar to those creatures, its bulbous end first, trailing its armed tentacles. Originally designed as a convoy protector during the Unhuman Wars, its weapon layout earned it the nickname "tailgunner" (although, as noted below, the vessel actually has very good all-round fields of fire).

There are stories of an improved dreadnought with heavier armor and daunting weaponry, but like early rumors about the effectiveness of the pool helm, this should be seen before it is believed.

THE SHIPYARD

Crew:

The octopus was originally designed for a human crew, supplemented by mind flayers as "heavy assistance" in boarding actions. The captain and helmsman are located within the protected "head" of the octopus.

Four of the eight arms of the octopus have some limited movement, controlled by great winches within the main body. These winches are used to pull the weapons into position. As a result, the ship can fire in all directions equally well.

Ship Uses:

The octopus is a relic of another time and place. It appeared at the height of the Unhuman Wars, during an unlikely alliance between neutral humans and mind flayers. The resulting hybrid has many illithid characteristics but was piloted by human wizards and used primarily to guard caravans and convoys from goblin depredations. With the destruction of the goblins, the need for large groups of ships traveling convoy-style diminished, the human/illithid alliance broke up, and the ships were retired, their equipment scavenged for other, more maneuverable ships.

Until recently, that is. An enterprising illithid has reportedly discovered a forgotten depot with several octopus ships and has been refitting and reselling them to anyone who can afford them, no questions asked. The depot was likely a secret fleet base or an abandoned illithid outpost which collapsed because of mind flayer infighting. The refitting consists of repainting and changing enough detail work so that the original owners do not come looking for the new salesman.

The octopuses are being used in a variety of ways, as adventurers' crafts (they avoid the open-deck problem of the hammerships) and as a pirate vessel. Pirates are beginning to take the edge in number of ships in use, so that strange octopus ships are best approached cautiously.

Other Configurations:

The octopuses from the illithid cache are typical of their type, and the new owner's refitting has done little to modify their standard appearance and/or armament. Some buyers have stripped the upper catapults and replaced them with heavy ballistas instead.

Those octopuses which have been sold to other mind flayer houses are outfitted with pool helms as opposed to major helms. As a result, only the more powerful families have been able to afford the octopus, and it is currently primarily a human craft.

There is a legendary octopus with fittings of gold and tentacles of silvery steel. This *Gold Octopus* was reputed to be owned by the Corsair, a legendary pirate. The Corsair boasted of being part Shou, part Solamnic Knight, and all-round helion. The *Gold Octopus's* tentacles were apparently animated by magic, giving it the equivalent of a grappling ram.

The *Gold Octopus* was a terror of the spaceways for a generation, then it disappeared as mysteriously as it appeared. Before his disappearance, the Corsair boasted of being able to raid any ship and set off to take on the *Spelljammer* itself. If this is true, the *Gold Octopus* now resides within the great ship's armory, and the Corsair is either dead or has taken on another identity aboard the ship.



There is a legendary octopus with fittings of gold and tentacles of silvery steel. This *Gold Octopus* was owned by an infamous pirate, the Corsair, who disappeared after announcing he would seek out and capture the *Spelljammer*.

THE SHIPYARD

Quentin's *Libraria*

BUILT BY:	Human (Quentin Axan)
USED BY:	Human (Quentin Axan)
TONNAGE:	30
HULL POINTS:	30
CREW:	5/30
MANEUVER CLASS:	E (Variable)
LANDING—LAND:	Yes
LANDING—WATER:	No
ARMOR RATING:	7
SAVES AS:	Thick wood
POWER TYPE:	Major helm
SHIP'S RATING:	As helmsman (10 for Quentin Axan)
ARMAMENT:	1 light ballista Piercing ram
CARGO:	15 tons
KEEL LENGTH:	120 ft.
BEAM LENGTH:	25 ft.

Description:

The *Libraria* is a unique ship created by Quentin Axan in the pursuit of the *Spelljammer*. It appears to be a synthesis of a standard tradesman with a great stone idol with flaming eyes and mouth. The remainder of the ship is packed with books and bookshelves—Axan's reading library and power source.

The idol which dominates the stern of the ship is a variant of the major spelljammer helm. It functions as a spelljamming helm in all manners, but in addition it can attain greater maneuverability classes through offerings burned in its mouth, primarily paper and books.

The normal maneuver class of the ship is MC E. Depending on the types of knowledge fed into the flaming mouth, the MC can be improved.

Normal paper, including nonmagical books and scrolls, increase the maneuver class to MC D. This increased maneuverability lasts for one round for every book or scroll fed into the idol.

For every clerical or magical scroll fed into the maw of the idol, maneuver class increases to MC C for four rounds. The number of spells on the scroll does not matter for the purposes of powering the ship, only that a magical or clerical scroll is fed to the flames.

For every spell book fed into the maw of the idol, maneuver class increases to MC B for six rounds.

For every magical book (such as a *Libram of Silver Magic*) fed into the maw, the maneuver class increases to MC A for the next 10 rounds.

All books and scrolls fed to the idol are utterly consumed by the flames.

The idol is a harsh master, and is constantly roaring, demanding to be fed. Failure to feed the idol will result in louder and louder imploring, then the idol's maw will belch forth billows of poisonous gas, causing the atmosphere to become tainted in five rounds and forcing all aboard to save vs. poison or perish. In addition, the idol has the power to cast one flaming sphere per turn, but cannot use its spelljamming abilities when doing so. This power is used as a defense when on the ground. Quentin Axan is always seeking more texts, in particular magical texts, to feed to his ship.

Crew:

The *Libraria* is crewed entirely by Quentin Axan and his assistants. Quentin serves as captain and navigator. He is aided by four halfling priests who take turns as helmsmen directing the ship's course. Those not on duty are busy cataloguing, copying, and reorganizing the files, and of course feeding the idol. Quentin will occasionally carry passengers, though always at the price of magical texts. Scribes may "work their passage" creating texts to be consumed while they sail.

The idol is a harsh master, constantly roaring, demanding to be fed. Failure to feed the idol leads to louder imploring, then the idol's maw belches forth billows of poisonous gas, tainting the atmosphere of the ship.

THE SHIPYARD

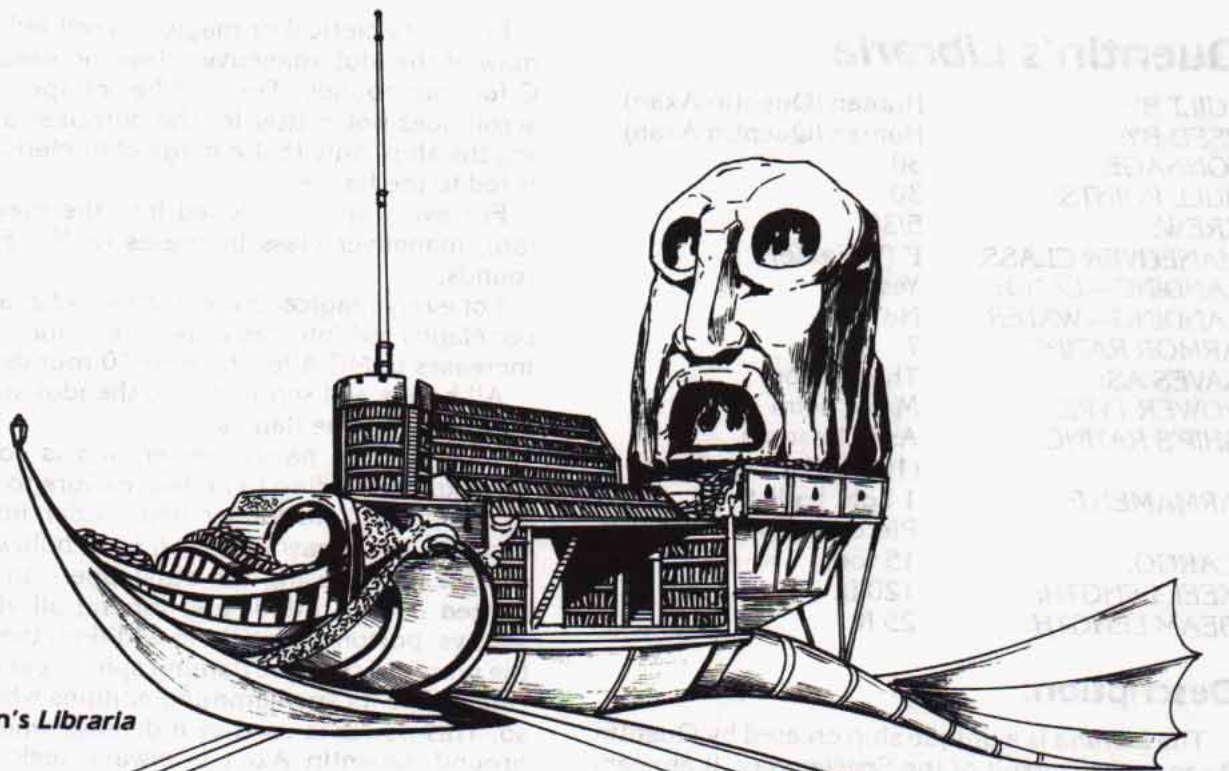

Quentin's Libraria

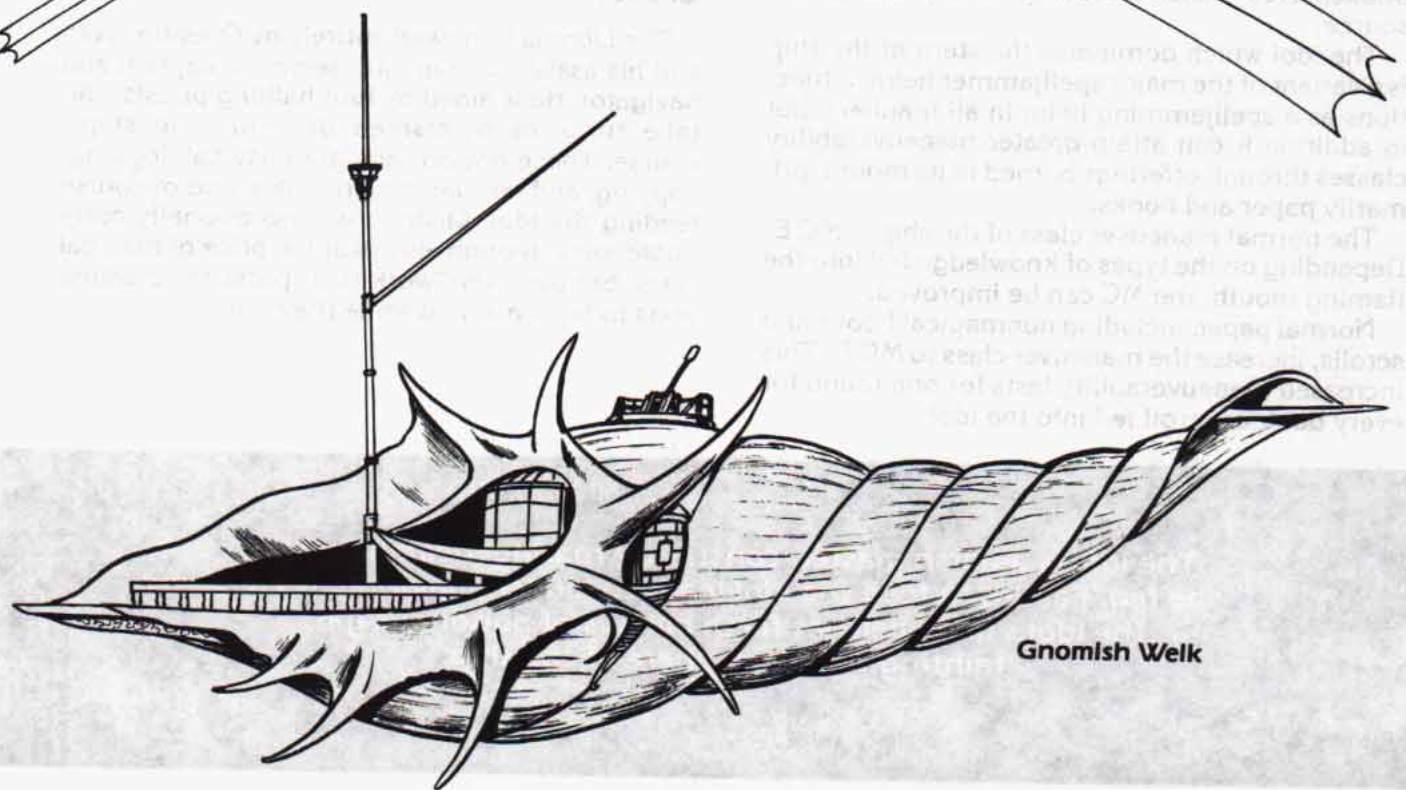

Gnomish Welk

THE SHIPYARD

Ship Uses:

The *Libraria* was cobbled together by Quentin Axan from the ruins of his crashed tradesman and a mystic idol from the planet he was forced down upon. The sole purpose of the idol was the consumption of knowledge, which correlated closely with Quentin's acquisition of knowledge. The idol gained the reach of space thanks to Quentin, while the scholar gained a powerful spelljamming artifact.

The *Libraria* is currently hunting the *Spelljammer* for the supposed great libraries therein. Quentin Axan's theory is that the *Spelljammer* is powered in much the same way as his own ship, and he might be able to use his idol to gain control of the great ship, and with it all the knowledge and legends held by the *Spelljammer*.

Quentin Axan is a 9th level wizard with the following abilities: Int High; AL N; AC 8 (Dexterity bonus); MV 12; HD 9; hp 27; THAC0 18; #AT 1; Dmg 1-4 (dagger); SA Spell Use; SZ M; ML 12 (18 on board the *Libraria*); Spells: 4 (1st), 3 (2nd), 3 (3rd), 2 (4th), 1 (5th).

Other Configurations:

The *Libraria* is a unique vessel under the command of Quentin Axan. It is possible, should Quentin ever fail his idol, that the idol will slay him and his crew. Travelers encountering the ship thereafter would find only a wreck with a tainted atmosphere, books decaying from the heat but not fed to the idol, and a very, very hungry idol.



Gnomish Whelk

BUILT BY:	Illusionist gnomes
USED BY:	Illusionist gnomes
TONNAGE:	30 tons
HULL POINTS:	30
CREW:	20/30
MANEUVER CLASS:	D
LANDING—LAND:	Yes
LANDING—WATER:	Yes
ARMOR RATING:	6
SAVES AS:	Ceramic
POWER TYPE:	Major or minor helm
SHIP'S RATING:	As helmsman
ARMAMENT:	1 medium catapult 1 medium jettison Piercing ram
CARGO:	15 tons
KEEL LENGTH:	120 ft.
BEAM LENGTH:	25 ft.

Description:

The whelk is a grown ship, much like the elven flitters and armadas. It appears as a spiralled sea shell dotted by sharp spikes along the whorls, traveling large-end first through the void. The jettison is mounted on the trailing edge, while the catapult is laid in at the highest point of the shell.

Crew:

The whelk is a gnomish ship, which takes most spacefarers by surprise, as most gnomish ships are hodgepodes of different ships and naval architectural styles, as if the designer was changing his mind as he built it (which is often the case). The gnomes who crew the whelk, however, are illusionists by trade and following, and do not care for their more technological cousins, whom they consider to be failures at the gnomes' "true calling"—illusion magic.

Most gnomish ships are hodgepodes of different ships and naval architectural styles, as if the designer was changing his mind as he built it (which is often the case).

THE SHIPYARD

The crew of a whelk is almost exclusively gnomish, and no allowance is made for larger creatures—the quarters and passage-ways are gnome-sized, and larger creatures must make do or sleep on the outer deck.

The command staff of a whelk are all gnome illusionists—captain, helmsman, chief mage, and weapons officer—of levels 2-12. In addition, there will be 1-4 additional gnome illusionists of levels 1-6 among the rest of the crew. The command staff uses its spells to increase the apparent dangerous nature of the ship (large monsters on deck, or flaming projectiles in the catapult—an effective deterrent to attackers in the phlogiston). Those of sufficient level may use *hallucinatory terrain* to mask the appearance of the ship, making it appear as a star field (though movement spoils this illusion).

In addition to the crew, the whelk will be home to either a family of normal badgers or 1-2 giant badgers, who are used as watchdogs, pets, and spies throughout the vessel.

Ship Uses:

The whelk is an excellent warship. With a powerful crew it can be a deadly ambush weapon or an effective exploration craft. As a result, many illusionist gnome crews have become mercenaries, selling their unique services to the highest bidder. They will work for anyone except the neogi, and have even participated in various illithid raids and beholder civil conflicts.

Whelk crews will work with their technological cousins, though this is distasteful to them. They feel that tinker gnomes have made fools of themselves and are the laughing stock of wildspace with their ramshackle ships and dubious inventions. The illusionist gnomes tend to overcompensate as a result, such that they are deadly serious in their dealings with other races. Those who ridicule the wrong type of gnome in space should be wary. Illusionist gnomes have long

memories, and those in space have a tendency to wait for revenge. They are not above ambushing someone to make a point.

Other Configurations:

The most powerful of the gnomish whelks have portions of their shells cut away for greater firing ability and maneuverability. These portions are stored for later use, and separated from the hull only if a mission looks particularly dangerous. These whelks can carry an additional five light ballistas, and have a maneuver class of C. Their armor rating, however, drops to 8.

Leech

BUILT BY:	Neogi
USED BY:	Neogi
TONNAGE:	20-100
HULL POINTS:	20
CREW:	2/20
MANEUVER CLASS:	B (alone) D (when mounted)
LANDING—LAND:	No
LANDING—WATER:	No
ARMOR RATING:	9
SAVES AS:	Metal
POWER TYPE:	Lifejammer
SHIP'S RATING:	As victim
ARMAMENT:	1 light catapult
CARGO:	10 tons
KEEL LENGTH:	50 ft.
BEAM LENGTH:	30 ft.

Description:

The leech is little more than a lifejammer drive mounted within a small dome. The dome is supported by eight grappling legs, which gives the entire structure the appearance of a headless spider. It can be operated by a single neogi with his umber hulk slave.

Anyone who ridicules the wrong type of gnome in space should be wary. Illusionist gnomes have long memories and wait patiently for revenge.

THE SHIPYARD

The leech is designed to fit onto the back of another living creature, which may or may not have space-faring abilities of its own, and turn the tandem device and being into a spelljamming ship. The process of using the lifejammer drive kills the harnessed creature, so the neogi can only use it in situations where time is of importance or where replacement creatures can be found.

The leech has maneuver class B and an SR of 2 on the tactical level. This is attained by bleeding off part of the neogi's personal slave to attain the power to move. The slave will be -1 to all die rolls (including hit dice) until healed. Prolonged exposure will kill the slave. Despite the ship's rating, the leech cannot attain spelljamming speeds without a host.

Any gargantuan-sized creature between 60 and 120 feet long can be mounted with the leech and turned into a captive of the neogi ship. This includes such space creatures as krajen and kindori, as well as large groundling dragons and small celestial dragons.

The neogi do not need the creature's intelligence, only its life-force, so the grapples of the leech are tipped with a paralyzing venom. The neogi must make an attack roll to hit (as for ramming a gargantuan creature), and if it strikes, the target must save vs. poison or be paralyzed. After initial paralyzation there are no additional saving throws. Creatures which can naturally attain spelljamming speeds (such as kindori) may add +4 to the roll and try to shake off the leech (a successful attack roll throws off the leech, but only if the creature was not paralyzed first). Failure to dislodge the leech indicates that the ship remains anchored to the victim's flesh and another save will be required the next turn.

Ship Uses:

The leech was used primarily for running dispatches between neogi outposts until about a hundred years ago, when a concentrated assault by

the elven fleets caused them to abandon the practice. The leeches still exist, however, and are sometimes used by rebels, rogue neogi, and other unscrupulous individuals who need to get somewhere quickly but don't want to take a ship.

Now it appears that new leeches are appearing in the Known Spheres, and that neogi and other evil creatures are using the leeches both for communication and for smuggling. Neogi diplomats of a half-dozen spheres claim that they are not responsible, though their less-moral brothers might be tempted. Elven attempts to track down those responsible have so far proved fruitless. These new leeches are nearly identical to the older models, but carry improved lifejammers and new fittings. The Arcane, who dislike the neogi use of lifejammers (as it competes with their own near-monopoly on spelljamming helms), have a standing reward of a custom-built hammership to anyone who tracks down the being or beings responsible.

Other Configurations:

Of greater concern to the elves and the Arcane is the growing use of leeches and kindori or other creatures as weapons of terror. Leeches loaded with greek fire or other flammables are loaded and rammed into civilized areas. Usually the dead pilot is found to be a neogi, but charred human and dwarf remains have been dragged from the resulting firestorm.

Bases in areas where this tactic have occurred are on constant alert, and craft approaching from odd directions, or living beings behaving unusually or unnaturally, are investigated quickly and hopefully dispatched before they can endanger the base.

Anyone caught within 30 yards of such a crash is affected as if he himself had crashed, and must make an additional saving throw vs. death or perish in the resulting firestorm. In the phlogiston, the save is at -4 because of the volatility of the region.

It appears that new leeches are appearing in the Known Spheres and that neogi and other evil creatures are using them both for communication and for smuggling. The arcane have a standing reward of a custom-built hammership to anyone who tracks down the beings responsible.

THE SHIPYARD

Urchin

BUILT BY:	Neogi
USED BY:	Neogi
TONNAGE:	3 tons
HULL POINTS:	3
CREW:	3
MANEUVER CLASS:	C
LANDING—LAND:	Yes
LANDING—WATER:	Yes
ARMOR RATING:	9
SAVES AS:	Thin wood
POWER TYPE:	Lifejammer
SHIP'S RATING:	As victim
ARMAMENT:	Piercing ram
CARGO:	1.5 tons
BEAM LENGTH:	5 ft. radius, 20 ft. counting spikes.

Description:

The urchin is the neogi response to the elven flitter: a light, inexpensive craft which can be used either at the tactical level for support or as an emergency vehicle. It can be fitted with spelljamming drives if need be. An urchin with a lifejammer moves according to the hit dice of the victim. An urchin equipped with more conventional, non-spelljamming drives has a tactical movement of 1.

The urchin looks like the sea creature of its namesake, with 8-foot spikes jutting out of a spherical body. The neogi (without his umber hulk slave) sits in a separate central sphere encased in the spike sphere, weighted at the bottom so that the pilot will remain upright regardless of how the ball moves or rolls. The spikes are sharpened so that they can be used as rams against small ships or, more importantly, as antipersonnel weapons.

If the urchin is on the ground, it can be used to attack enemies like a monster, rolling at its opponents and spiking them. The urchin on the ground has a movement rate of 12 and is very maneuverable. The central sphere is vulnerable (and has, ef-

fectively, 30 hit points), but the attacker must first survive 1-4 attacks by spikes, each inflicting 10 points of damage as a pole arm, before making his own attack. The spikes themselves are AC 9, and are destroyed by five points of damage. Destroying five spikes reduces the urchin's movement rate to 6 and allows the attacker to get at the urchin without risking assault. Destroying 10 spikes immobilizes the urchin.

Crew:

The urchin is primarily intended as a one-being vehicle, though two medium-sized figures can fit into it. Usually a lone neogi is its sole crew. Those that carry spelljamming helms will always be lifejammers, and the second "passenger" will always be some unwilling victim (likely one of the size S races, since space is at a premium).

Ship Uses:

The urchin is used primarily as a close-assault vehicle. Up to 20 urchins can be carried inside a deathspider and strewn like mines in front of other ships, much in the same manner as stones launched by a jettison. The urchins are most effective against the elven flitter, but larger ships have to avoid them as well else they end up rolling up the deck, skewering deck hands as they pass. Open ships such as the hammership are the most vulnerable, while illithid ships like the nautiloid are nearly invulnerable to this assault.

Other Configurations:

The urchin has a number of other uses as well. The primary one is as a messenger ship. Such urchins are painted white, their spikes capped by bulbous metal or ivory sheaths (which can be removed if need be). While the spikes are sheathed, the ships lose their attack capability and are referred to as "snowflakes" by the neogi.

Unmanned urchins, packed with greek fire, are called "Thrig'ki's lovers" (an obscure historical reference understood only by neogi) or simply "gobs."

THE SHIPYARD

Leech

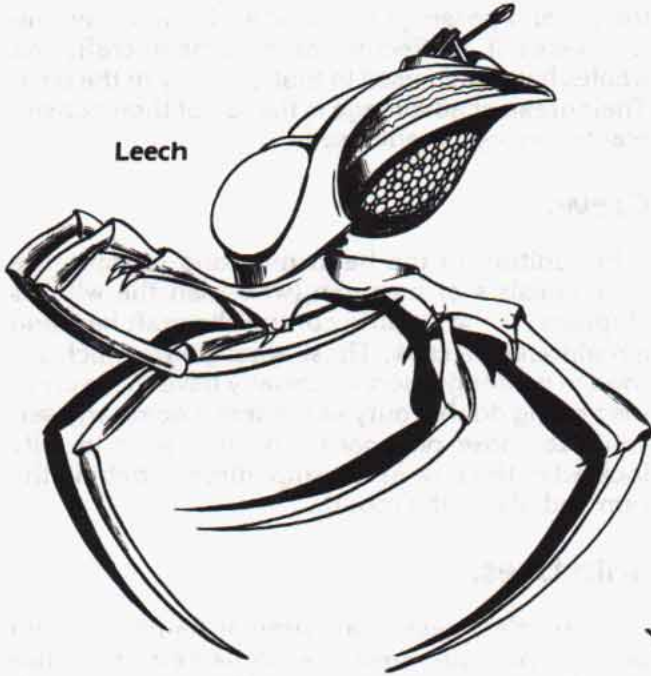

Urchin

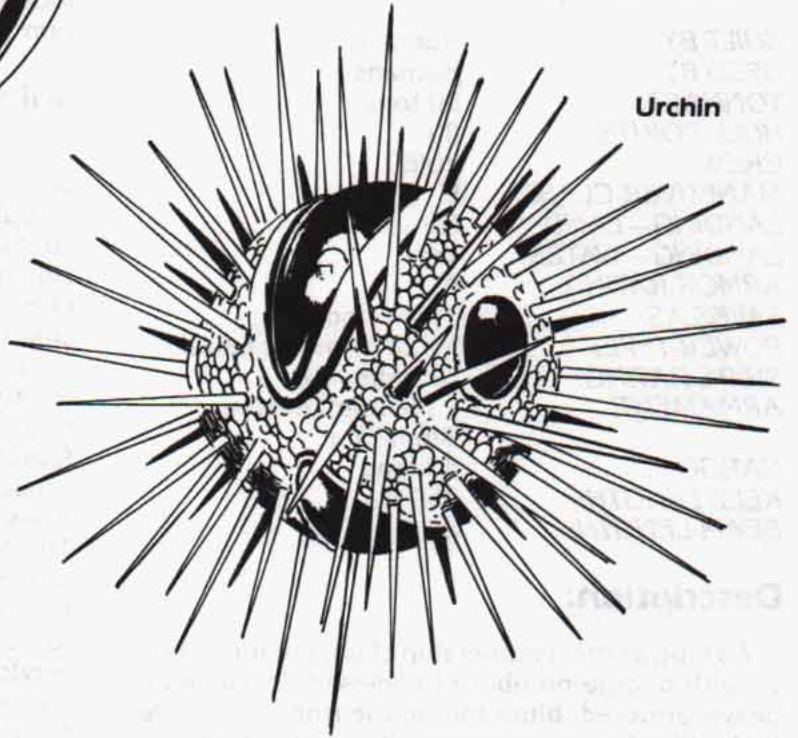

Whaleship

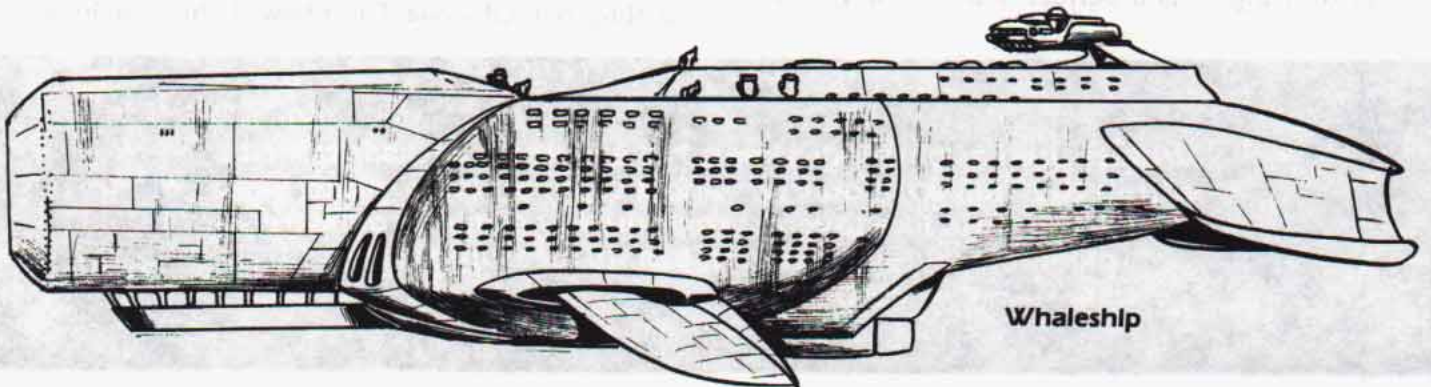

THE SHIPYARD

Unmanned urchins are also sometimes used as mines in battle with other ships. They are deployed like normal urchins but do not move. Instead they are packed with greek fire. Once in an enemy's gravity field they fall onto the vessel, crack open, and ignite. Such craft are called "Thrig'ki's lovers" (an obscure historical reference understood only by neogi) or simply "gobs," by the neogi. They pose nearly as great a danger to the deathspider carrying them as to their potential targets—a critical hit might set them aflame in the ship. Only a neogi captain who has offended his superiors will be ordered to carry gobs.

Whaleship

BUILT BY:	Humans
USED BY:	Humans
TONNAGE:	80 tons
HULL POINTS:	80
CREW:	20/80
MANEUVER CLASS:	E
LANDING—LAND:	No
LANDING—WATER:	Yes
ARMOR RATING:	4
SAVES AS:	Thick wood
POWER TYPE:	Major or minor helm
SHIP'S RATING:	As helmsman
ARMAMENT:	1 medium jettison Blunt ram
CARGO:	40 tons
KEEL LENGTH:	250 ft.
BEAM LENGTH:	25 ft.

Description:

As long as the hammership class, but much taller, with a large number of enclosed decks and a heavy, armored, blunt ram in the front, the whale looks like the sea mammal it is named after, a huge sperm whale. It is not known for being graceful, only big. It is a perfect hauler of large bulk

freight and passengers. Its lack of maneuverability makes it ineffective as a combat craft, but whales have been used in that capacity in the past. Their greatest advantage is that all of their considerable tonnage is enclosed.

Crew:

In addition to the helmsman and captain, the crew consists of oarsmen (who man the whale's "flippers" for what little control the craft has) and a maintenance crew. Those whaleships which are used in passenger service usually have these crewman doing double duty as pursers, cooks, and servants to those on board. The bridge is usually located at the bow of the ship, directly behind the ram and above the mouth.

Ship Uses:

Whale-class vessels are used as haulers of both people and equipment. Cargo haulers specialize in bulk goods, like grain, cloth, or other foodstuffs. Some whaleships are modified so that one side of the hull can be detached for easy loading. Otherwise, all materials are loaded through the ship's "mouth."

Those whales used as passenger liners have multiple decks installed within the hull, with quarters and a common room, much like any tavern found planetside. Like taverns, the quality of whaleship liners ranges from barely palatable dives to opulent, ornate pleasure palaces in space. The former cram as many folk into the hold as possible, while the latter serve only a fraction of the people they could handle, but charge them 10 to 20 times the normal price of a trip for luxury service. There are a number of different firms using whaleships throughout the known spheres, ranging from one-ship operations to massive lines. One of the most successful is the Pandros Line out of Theiaspace, which is run by a female halfling named Calia Thornbow. Others include

Whales used as passenger liners have multiple decks installed within the hull, with quarters and a common room, much like any tavern. Also like taverns, their quality ranges from barely palatable dives to opulent, ornate pleasure palaces.

THE SHIPYARD

Brilliant Night Tours, Fraldathiagn Haulers, and Meer, Dostrol, Hampstad, and Klatchkapper, Ltd.

The whaleship's only defenses are a small jettison in the stern of the craft, and its ram (though some would argue with calling a ram a defensive weapon). The entire bow of the ship is plated in armor. Its normal method of dealing with assailants is to plow right through, leaving only debris in its wake. Being rammed by a whale will finish off many small ships. Once a whaleship is stopped, however, it is easy prey for boarding parties.

Trade whaleships are usually unpainted or at best given a starry background that might help hide the craft from potential attackers. Passenger whaleships are usually sprayed with gaudy colors and swirls on the outer hull, depending instead on the talents of capable and high-priced helmsmen to keep them out of harm's way.

Other Configurations:

The whaleship is not an effective combat vessel, though it can absorb a great deal of punishment before breaking up. Its lack of weaponry and sluggish maneuverability makes it an easy target in combat. In large-scale human combats, whaleships are used primarily as cargo transports and troop carriers.

Attempts have been made to turn whaleships into flying space fortresses. This usually involves cutting parts of the outer hull away to reveal batteries of ballistas, or very rarely bombardiers. These type of craft may gain up to six large weapons in this fashion, but at great cost. Armor rating drops to 6, maneuverability falls to MC F (little better than a groundling ship), and the ram is less effective. If a "killer whale" rams a target of 50 tons or greater, the helmsman must check to see if his own ship breaks up from the impact.

There are reports of a killer whale which is manned by a mixed human/illusionist gnome crew. This whale has illusions of solid walls in

front of the weapons, concealing them from potential victims. This human/gnome band operates as pirates, and apparently has a great hatred for the tinker-gnomes which are very common in space. They are said to attack and burn tinker-gnome ships wherever they find them.

The whaleship is also a popular ship with the illithids, in particular in areas where the standard mind flayer design is likely to invite attack. The enclosed whaleship provides the cool darkness mind flayers prefer. These whaleships use the newer pool helms (in fact, these pool helms were first encountered powering whales, before the dreadnoughts came into use).

A last variant that is just beginning to appear is the glass whale. The armor plating at the bow of this type is made clear using *glassteel* spells to provide a "window on wildspace" for the passengers. The Arnazdo Operation (Milo Arnazdo, proprietor) uses glass whales as the symbol of his passenger service, and backs up the apparently fragile (but actually quite sturdy) ships by stationing powerful wizards on board.



The whale's normal method of dealing with assailants is to plow right through, leaving only debris in its wake. Being rammed by a whale will finish off many small ships.

Once a whaleship is stopped, however, it is easy prey for boarding parties.

PERSONALITIES OF THE SPELLJAMMER

Arcane

The Mad Arcane

HEADQUARTERS:	Arcane's tower (area #31)
ARMOR CLASS:	3
MOVE:	12
HIT POINTS:	75
NO. OF ATTACKS:	1
DAMAGE/ATTACK:	1-10 (two-handed broadsword wielded in one hand)
SPECIAL ATTACKS:	Nil
SPECIAL DEFENSES:	Invisibility, dimension door
MAGIC RESISTANCE:	40%
SIZE:	L (12 ft.)
ALIGNMENT:	CE
PSIONIC ABILITY:	Nil

Arcane of the *Spelljammer* is a mad creature, his mind twisted by life on the *Spelljammer* and broken entirely by the great ship's rejection of his attempt to become captain.

Arcane (he has no other name) appears as a normal individual of his race—blue-skinned giant dressed in robes, calm, implacable, and willing to deal for any available item. However, unlike the rest of his race, he is prone to murderous fits of rage, will lie to buyers (though lie intelligently), and seek to destroy anyone or anything that gets in his way.

Arcane has figured out the entire picture, and that has granted him his cunning insanity. He knows about the ultimate helms, how they are created, and where they go. He knows about the cause of the dark times, the growing of the smalljammers and first flight. He knows why no one thinks of leaving the *Spelljammer* once they arrive, something that no one else considers. He knows about the Lost Captains locked in their brigs, and about the Fool gnawing at the heart of the *Spelljammer*.

In his madness, he knows all of this, but he speaks very little, and then only once a high price is met. The elven warrior Stardawn stole the master seed of an elven ship for him, while the lizard priest Demets sacrificed his own sister for part of the solution. He has given each bits of the puzzle, but has told no one why they cannot leave the great ship, and mixes lies with his truth to prevent anyone from gaining the upper hand on him.

Arcane fears and hates the Fool, whom he knows is acting to destroy the ship. He cannot stop the Fool, nor can he escape, and that feeds his madness even more. Arcane's actions are often to foil what he sees as one plot or another by the Fool, and every newcomer is checked out to see if he is secretly an agent of the undead lord.

Arcane's madness regarding the Fool has extended to dressing up the body of his murdered brother arcane in motley, with a hat-of-bells on his head, so as to better understand his foe. The Fool would dearly love to add that dead arcane to his network of spies, so that he may know Arcane's plan as well.

Arcane has an ultimate plan—to escape the *Spelljammer*, sell the information that he has, use the money to raise a great space fleet, and then return to destroy the *Spelljammer* before the Fool can take control, and destroy both Fool and ship. To that end, he is using the master seed of the elven ship to grow a new vessel in an area of the citadel far from prying eyes. He has sacrificed the soul of Arvanon's granddaughter to gain the knowledge of creating such a ship, and now seeks a helm (or helms) to pilot himself away.

He has plans within plans. He has ordered his gnomes to build a great catapult, for if he cannot find a helm, he will use it to push himself out of the air envelope, possibly in the phlogiston, where his body will solidify into a preserving stone until rescued.

However, he cannot accomplish this as long as he feels compelled to remain, and so he has ordered the gnomes to build a great suit for him to

Arcane is a mad creature, his mind twisted by life on the *Spelljammer* and broken entirely by the great ship's rejection of his attempt to become captain. He is prone not only to lying, but to murderous fits of rage as well.

PERSONALITIES OF THE SPELLJAMMER

explore underwater. At the same time, he provides useful information in exchange for air—air within bottles or other containers, which have not been poisoned by the *Spelljammer* itself. Lastly, he lusts after the *ioun stones* that the Gray Eye possesses. His plan, once he has gained enough air, is to dress in the great suit, make arrangements for launch, catapult his ship into space, where, should he find a helm he can use, he will move away, and if he should not, use the *ioun stones* to survive to reach civilization.

If he finds a helm, he needs to take with him someone who can operate it. The elven ship, a raty, twisted version of a true flitter, is now complete, and Arcane has a few bottles of precious air already. He needs the stones, and the gnomes to finish their work, for him to escape.

Argargon

The Late King Argargon of the Gnolls
Undead Gnoll Chieftain

HEADQUARTERS: The warrens (area #42)
ARMOR CLASS: 3
MOVE: 9
HIT POINTS: 32
NO. OF ATTACKS: 1
DAMAGE/ATTACK: 4-16 (+3)
SPECIAL ATTACKS: Nil
SPECIAL DEFENSES: Immune to *sleep*, *charm*, *hold*, *death-magics*, *poison*, and *cold*
MAGIC RESISTANCE: Nil
SIZE: L (7 ft. 7 in.)
ALIGNMENT: N
PSIONIC ABILITY: Nil
Str 17 Dex 12 Con 17 Int 10 Wis 10 Cha 2

Argargon was once the leader of the gnolls (area #21). Once the allies of the beholders, they were slaughtered by their former allies during the Blinding Rot that destroyed the eye tyrants. Those

that survived the massacre by the beholders found that other races, primarily the giff, were more than willing to finish the job.

Argargon and his clan leaders formed up a rear guard during the giff assaults and retreated deep into the passages of the warrens, figuring that from these cavelike regions they could return and destroy their foes. Instead, the gnolls were ambushed by forces of the Fool (*q.v.*), the undead lord who controls the depths of the *Spelljammer*. Argargon and his companions were slain and turned into zombies. Argargon, armed with a huge axe, now serves as the Fool's personal servant and bodyguard. Argargon speaks not, but only reacts to his master's wishes. The Fool can see and hear all that Argargon sees and hears.

Arvanon

Arvanon the Lizard Priest
Lizard King/13th Level Priest

HEADQUARTERS: The gardens (area #2)
ARMOR CLASS: 3
MOVE: 9, Sw 15
HIT POINTS: 65
NO. OF ATTACKS: 1 or 2
DAMAGE/ATTACK: 5-20 (+1) (+1 *trident*) or 1-3/1-3 (bare hands)
SPECIAL ATTACKS: Skewer
SPECIAL DEFENSES: Nil
PRIEST SPELLS: 1st:8, 2nd:8, 3rd:7, 4th:5, 5th:2, 6th:2
PRIEST SPHERES: creation, divination, guardian, protection, sun, necromantic, weather
MAGIC RESISTANCE: Nil
SIZE: L (9 ft.)
ALIGNMENT: NG
PSIONIC ABILITY: Nil
Str 15 Dex 13 Con 12 Int 16 Wis 18 Cha 12

Armed with a huge axe, Argargon now serves as the Fool's personal servant and bodyguard. He never speaks, but only reacts to his master's wishes. The Fool sees and hears everything Argargon sees and hears.

PERSONALITIES OF THE SPELLJAMMER

Arvanon is a native of the *Spelljammer*. He was raised in the gardens and his superior abilities are a direct result of the effects of increased sun and heat on lizard man eggs. As a result, Arvanon is larger, more powerful, and more intelligent than his groundling equivalents. He also lacks the general savagery, cunning, and nasty dining habits of the rest of the race (he does not demand living flesh from his followers).

Arvanon is a huge, hulking lizard king, towering above his companions and acolytes. He still bears an ornate trident as the symbol of his office, which he may use to skewer opponents, if he so wishes. Such skewering is optional, and Arvanon uses the ability if there is great need.

Arvanon has ruled the gardens and led the lizard men through many captains, and is deeply committed to the nature of the cycle—the arrival and proving of a new captain, the closing of the gardens, the growth and first flight of the small-jammers, and the recovery of the civilization out-

side the gardens following these dark times. He is aware of the potential harm the dark times bring to the citadels, and as a result strongly advises the various factions to store supplies, as well as develop their own resources to tide them until the gardens are reopened. Despite this realization, he will not stand in the way of potential captains, as that would interrupt the cycle and do a disservice to the *Spelljammer*, his lord. He will still order non-lizard friends and allies ejected from the gardens when the time comes.

Arvanon and his people view the *Spelljammer* as a quasideity, a representation of nature found within all the spheres. While the *Spelljammer* is not a deity, this veneration of nature results in his being granted spells in any sphere where nature-based deities are venerated (which is the bulk of known spheres). In the phlogiston, Arvanon and his other priests gain none of their spell abilities, and as a result tend to stay within their gardens during this time.



PERSONALITIES OF THE SPELLJAMMER

Arvanon usually appears in public with a handful of lizard men and one to three acolytes, including his grandson Demets. Arvanon dotes on his grandson, and sees the lad as his eventual replacement when Arvanon must return his body and spirit to the great cycle. Demets already represents Arvanon in the council and commands the respect of many of the other lizard men.

Arvanon sees himself as evenhanded and fair to all races, from human to neogi, and sees it as the lizard men's duty by nature and the *Spelljammer* to feed all these people while the gardens are open. Only attacks against him or his people will bring him to anger. If members of a particular citadel are the offenders, he will cut off food deliveries until the offender is turned over for punishment. If the offender belongs to no particular citadel, then the council appoints a particular citadel to bring in the offender.

Despite his civilized manner, Arvanon is brutal in justice. Lesser crimes such as theft are punished by working in the gardens, but killing a lizard man is punishable by death at Arvanon's hands (this is an execution, not a fair fight). Once the offender is slain, Arvanon will sometimes raise the offender back to life to "learn from his experience," particularly if there were mitigating circumstances. In one particular case, when his granddaughter was slain, Arvanon executed the offender, raised him, and executed him again, showing a savage streak that is still remarked upon by the natives of the great ship.

Arvanon has a small hoard of clerical items in his garden hut. This includes five *potions of extra-healing*, three jars of *Keoghtom's ointment*, a *staff of command* and two(!) *staves of curing*. He will distribute these as need arises, either using them himself or allowing his acolytes to use them in his name and the name of the *Spelljammer*.

If Arvanon has a particular confidant onboard the ship, it is Suza, the brass dragon inhabiting the dracon tower (area #40). Suza is a wonderful gossip and informs Arvanon of all matters that

she hears of. In turn, Arvanon shares all of his knowledge with Suza, outside of that forbidden by holy writ.

Arvanon is ancient in terms of lizard men, and very wise. He is also very reserved in his dealings with individuals from outside the gardens, in particular newcomers who seek the captaincy. He feels that encouraging or discouraging a particular individual to captaincy would upset the natural cycle of the great ship. Further, the ascendancy of a new captain will bring on a closing of the gardens, which would hurt many of his nonlizard allies. As a result, he is extremely neutral toward newcomers, offering neither aid nor hindrance in their tasks.

If an individual manages to befriend or aid Arvanon, he will lay out the general cycle of captaincy as he knows it: The captain takes command, and the gardens close for a few months, leaving the citadels to fend for themselves. He defends this as the natural order of his world, one that he has lived through several times. He will not mention the smalljammers, nor the fact that they are grown in the gardens, as that verges on holy matters, which he is prevented from speaking of. He does not know of the fate of the lost captains nor does he know the exact role the captain plays in the creation of the smalljammers, only that a new captain results in a new crop of the small ships.

Arvanon is still a powerful lizard king, his broad shoulders only slightly slumped from age, and a red tinge only now appearing at the edges of his scales. He is normally dressed in flowing robes and an ornate, golden headpiece that accentuates his already imposing height. Other than the headpiece (set with diamonds and worth 10,000 gp, should a thief escape the *Spelljammer* alive), and his ornate *trident +1*, he carries nothing of value on his person.

Arvanon sees himself as evenhanded and fair to all races, from human to neogi. But despite his civilized manner, Arvanon is brutal in justice.

PERSONALITIES OF THE SPELLJAMMER

Astor

Old Astor
Partially Blinded Beholder

HEADQUARTERS:	The market and general stores (area #6)
ARMOR CLASS:	0/2/7
MOVE:	FI 3 (B)
HIT POINTS:	60
NO. OF ATTACKS:	1
DAMAGE/ATTACK:	2-8
SPECIAL ATTACKS:	Magic
SPECIAL DEFENSES:	Anti-magic ray
MAGIC RESISTANCE:	Special
SIZE:	M (4 ft. diameter)
ALIGNMENT:	LN
PSIONIC ABILITY:	Nil

Astor was once one of the beholders of area #24, one of the ruling elite of that group before the blinding rot struck that race. Unlike most of his race who were affected by the rot, he survived, but suffered partial loss of his eye-stalk abilities as well as gaining a gray, mossy patina on his outer shell. This gray material gives him the nickname "the Old." In reality, he is middle-aged (by beholder standards) and remembers when the last dark time occurred, with its starvation and inter-city battles.

Astor fled from the beholders but received help from an unlikely quarter—the halflings of the Open Air Public House. Charged with finding a new steward for the stores, the halflings chose Astor chiefly for his potential magical abilities and firepower, and secondly to give a balance to the beholder nation.

Astor has remained with the halflings as the steward for the ship, and has proved to be accurate, exact, and honest in his managing of surplus ship material. He is adopted as a mascot by the halflings, who refer to him as a favorite old uncle. This galls the beholder to an extreme degree—

that these nonbeholders should feel any affection toward him at all—but it serves his purposes (and saves his hide) in order to keep them happy. Should all the other beholders of the great ship disappear, a goodly number of the remaining halflings will as well, as Astor takes revenge for years of kidding.

Common (but quiet) speculation in the Open Air is the state of Old Astor's eyes—namely, which ones are functional? It is accepted that his anti-magic eye (the central one) and telekinetic eye work—all have seen them in operation. The remainder are stuff of speculation.

The truth is this: All eyes function except for the Fear, Charm Monster, and Slow eyes. Astor does not use the other eyes save in secret or in times of deep need, and would rather take damage than reveal his secret. He feels (and rightly so) that if he were to show his power, Gray Eye and the other beholders would hunt him down.

Astor is polite, even endearing in his approach to other races, a break from the standard xenophobic beholder. It appears that spending time with the halflings has softened him, such that he will tolerate other races. In reality, he is recording every slight and insult for the eventual day of retribution against both his former comrades and all other nonbeholder races.

Astor keeps in his memory a complete listing of the common stores, though he will be loath to pass on that information for common use. He pulls in all the gossip picked up by Brewdoc (*q.v.*) and his peers, but passes nothing on for his own. He is looking for potential captains.

Astor fears two things—one is the retribution of his former comrades, such that he will never be in the market if other beholders are present. The second fear is that a new captain will appear. A new captain means a dark time, when the gardens shut and the stores (HIS stores) are stormed. Astor will seek out as much information as possible on those asking about captains, and if he fears that they are capable of attaining captaincy, he will

It appears that spending time with the halflings has softened Astor, but in reality he is recording every slight and insult for the eventual day of retribution against both his former comrades and all other nonbeholders.

PERSONALITIES OF THE SPELLJAMMER

have them killed. This has happened once in the past, and Astor ambushed the indiscreet would-be captain, disintegrating him. It was assumed that another beholder did the deed, since no one has seen Astor use his disintegration eye.

A would-be captain who comes storming into the Open Air declaring his intentions will likely attract Astor as a foe (as well as several other characters in the *Spelljammer's* citadels). One that is more cautious can take command before Astor realizes what is happening.

Breakox

Hammerstun Breakox
Hill Giant Minotaur Elder

HEADQUARTERS:	The minotaur tower (area #22)
ARMOR CLASS:	6
MOVE:	12
HIT POINTS:	86
NO. OF ATTACKS:	2
DAMAGE/ATTACK:	2-8/2-8 (+7), or 1-4/2-12 (+7)
SPECIAL ATTACKS:	Grapple, charge
SPECIAL DEFENSES:	+2 to surprise
MAGIC RESISTANCE:	Nil
SIZE:	H (16 ft.)
ALIGNMENT:	CE
PSIONIC ABILITY:	Nil
Str 19 Dex 10 Con 18 Int 12 Wis 12 Cha 6	

Breakox is a hill giant originally from a cluster of planetoids, who was cursed with minotaurhood for "crimes against the natural order." The nature of these crimes has not been revealed, and no one wants to ask the hill giant minotaur for further elaboration. Breakox became a pirate leader for a brief time, eventually choosing to raid the *Spelljammer* herself. On arrival, he found a small community of minotaurs (from a number of plan-

ets), promptly turned on (and reportedly ate) his former crew-mates, and settled in as the master of the minotaur tower.

Breakox is huge, twice the size of his companion minotaurs. He rules them with an iron hand, and Breakox's declarations are followed to the letter.

Breakox is short-tempered, obstinate, and violent. He is rarely dressed in more than a padded kilt, and carries a giant version of the minotaur great axe.

The minotaurs are the target of the mind flayers, beholders, and neogi, all of whom see the bull-headed men as a potential slave race. Breakox is no being's slave, and as such tries to play one force off against another. He has succeeded only in irritating all three factions.

On the other hand, Breakox maintains good relationships with Father Goat's church (which is a potential sanctuary), and with ShiCaga and her ogres. Rumors regularly float about him and ShiCaga as being romantically entwined. Actually, such rumors only surface when one of the two is threatened by outside forces, as a reminder that to attack one may bring in the other. Breakox actually finds ShiCaga a ruined old hag of an ogre, but is at least wise enough not to voice that theory out loud.

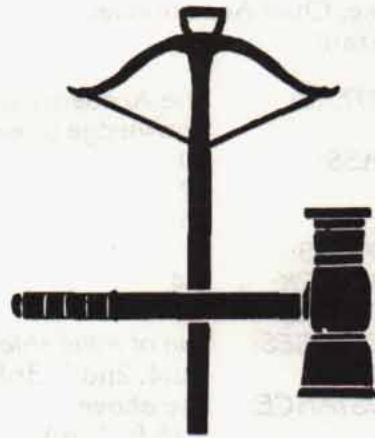

Breakox is short-tempered, obstinate, and violent, and he rules his minotaur companions with an iron hand. His declarations are followed to the letter.

Astor, Breakox, Brother Burke



Brother Burke

Brother Burke, Chief Academician
7th Level Wizard

HEADQUARTERS: The Academy of Human Knowledge (area #34)
ARMOR CLASS: 10
MOVE: 12
HIT POINTS: 15
NO. OF ATTACKS: 1
DAMAGE/ATTACK: 1-4
SPECIAL ATTACKS: Nil
SPECIAL DEFENSES: *ring of mind shielding*
WIZARD SPELLS: 1st:4, 2nd:3, 3rd:2, 4th:1
MAGIC RESISTANCE: See above
SIZE: M (5 ft. 1 in.)

ALIGNMENT: LE
PSIONIC ABILITY: Nil
Str 12 Dex 12 Con 9 Int 16 Wis 13 Cha 12

Brother Burke is the "front man" for the Xenos, a secret society dedicated to the elimination and/or subjugation of all other races to humanity. In his guise as the Chief Academician, Brother Burke is the contact man for all those seeking knowledge at the academy, and is literally the only one that newcomers can talk to (the others have taken a vow of silence).

Brother Burke is a simple, typical monk, dressed in simple brown robes. He does not have his head shaved, but instead has the thick stock of black hair sprouting in all directions. He has a friendly, easy demeanor, is happy to see visitors to

As the chief academician at the Academy of Human Knowledge, Brother Burke is the contact man for everyone seeking information at the academy. He is also the front man for the human-supremacist group called the Xenos.

PERSONALITIES OF THE SPELLJAMMER

his small library, and interested (but not to a forceful degree) in hearing newcomers' tales.

Brother Burke maintains this guise by a *ring of mind shielding*, turned invisible and worn on the left hand. Further, he has voluntarily accepted a geas from the other Xenos (as have his staff) to NEVER reveal anything of the Xenos or their plans to questioners. Attempts to pry out that information will result in pain for Brother Burke, and, if he is forced (by magic or threat) to reveal the information without removing the geas, it will kill him. (At this point the player characters should begin worrying how to explain the fact they killed one of the few apparently nice people on the ship.)

Brother Burke and his comrades take their orders from the Hooded Soldier, but are unaware of his true identity. They believe the Hooded Soldier is Si Loo, but this is untrue.

CassaRoc

CassaRoc the Mighty
15th Level Fighter

HEADQUARTERS:	The tower of thought (area #11)
ARMOR CLASS:	-3 (full plate, shield +3)
MOVE:	6
HIT POINTS:	130
NO. OF ATTACKS:	2
DAMAGE/ATTACK:	1-8 +3 (bastard sword +2, Str bonus)
SPECIAL ATTACKS:	None
SPECIAL DEFENSES:	ring of fire resistance
MAGIC RESISTANCE:	Nil
SIZE:	M (5 ft. 10 in.)
ALIGNMENT:	NG
PSIONIC ABILITY:	Nil
Str 17 Dex 14 Con 12 Int 14 Wis 12 Cha 10	

CassaRoc worked himself up the ranks as a wildspace mercenary from an early beginning,

leaving behind the comforts of a world now long-forgotten after many battles (and even more mead). In his travels, CassaRoc picked up three things—the nickname “the Mighty,” the talents of a skilled swordsman, and a wealth of brewing experience from half a hundred worlds. All three have proved to be invaluable in his further dealings aboard the *Spelljammer*.

CassaRoc rules the tower of thought, and has collected a group of like-minded warriors about him to aid in his general aims—to have a good time, beat up a few forces of evil, and prevent said forces from overrunning the ship, seizing entire control, and generally making a mess of things.

CassaRoc is a hale, good-tempered, massive individual, shorter than Chaladar the Paladin, but broader, and as such appearing to be larger. It should be noted that his nonmagical armor has been let out a few times and new plates hammered in by the dwarves of Kova.

Human characters of any significant rank or power (level 10 or higher) should expect to receive an invitation to dine with CassaRoc. This should occur soon after they make their abilities known, either through combat or through general boasting (Kristobar Brewdoc, master of the Open Air Public House and incredible gossip, is a frequent visitor to the tower). CassaRoc will size up the newcomers as far as potential threats to himself, and then either offer admission to his little group (usually involving some deed or heroics, ranging from simple pranks to outright provocation of an evil race), or just pull as much information as possible.

CassaRoc believes the Fool exists, but that he is not an evil creature—in reality he IS the secret captain of the *Spelljammer*. Since nothing bad has happened to him and his group (other than the standard battle casualties and the like), he feels quite positive that he has solved the mystery of the *Spelljammer*. The fact he has no proof to his claim has totally eluded him.

CassaRoc rules the tower of thought and has collected a group of like-minded warriors about him to have a good time, beat up a few forces of evil, and prevent them from overrunning the ship.

PERSONALITIES OF THE SPELLJAMMER

Chaladar

Grand Knight Chaladar
19th Level Paladin

HEADQUARTERS: The chalice tower
(area #10)
ARMOR CLASS: -4 (+2 shield, +4 plate)
MOVE: 6
HIT POINTS: 120
NO. OF ATTACKS: 2
DAMAGE/ATTACK: 1-8+1/1-8+1
SPECIAL ATTACKS: Paladin abilities, *long sword of sharpness*
SPECIAL DEFENSES: Paladin abilities
PRIEST SPELLS: 1st:3, 2nd:3, 3rd:3, 4th:2
PRIEST SPHERES: combat, divination, healing, protection
MAGIC RESISTANCE: Nil
SIZE: M (6 ft.)

ALIGNMENT: LG
PSIONIC ABILITY: Nil
Str 13 Dex 10 Con 14 Int 12 Wis 14 Cha 18

Chaladar is a native of Krynn, a veteran of the Wars of the Lance. In the course of his repelling an evil horde of draconians in the last days of that war, Chaladar discovered a magical boat, which allowed him to journey between the stars. Seeing that the war was left in the good hands of strong allies, he set out for the stars to find new injustice to fight. The boat, now lost, brought him to the *Spelljammer*, where the forces of good and evil are once more clearly marked, and he may use his sword and those of his fellow companions of the chalice, to repel the forces of evil and save the free peoples of the *Spelljammer*.

At least that's the tale that Chaladar tells about the fire. The truth of the matter was that Chaladar forsook Krynn at the start of the war, was being pursued by the draconians as opposed to vice ver-

CassaRoc, Chila, Chaladar

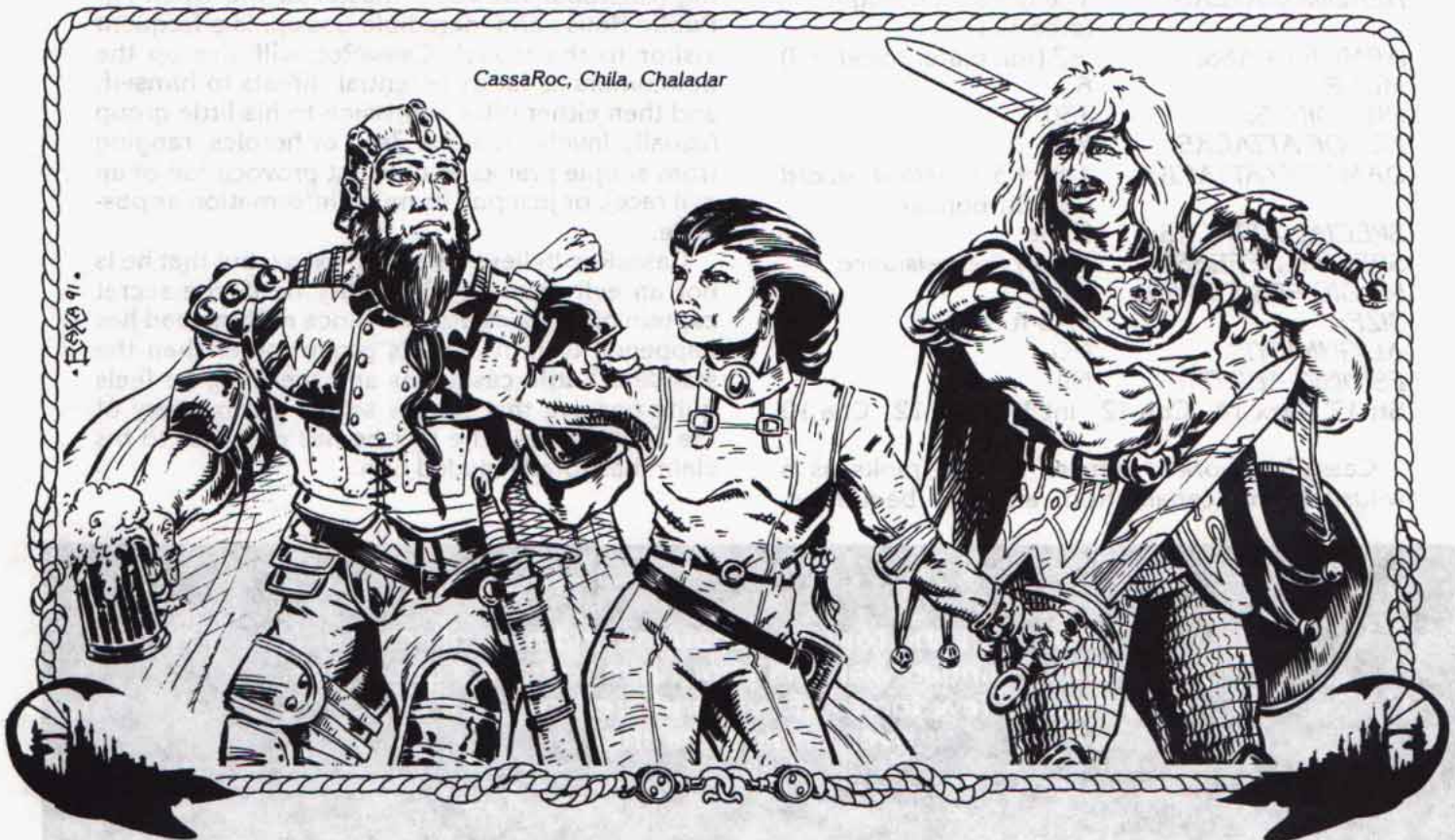

PERSONALITIES OF THE SPELLJAMMER

sa, and accidentally activated the "magical boat" which took him to the stars. He was 9th level at the time, and has risen to 19th through various adventures since then. His love of the *Spelljammer* and its people is heartfelt, however, and he would dearly love to wipe the evil races and individuals from the ship, if only he could do so without turning all the neutral parties (including the powerful but deluded lizard men and their gardens) against his own forces.

Chaladar has ruled the chalice tower for only four years, and has proved a capable leader, flexible in doctrine if inflexible in argument. He is bull-headed and impossible to convince of any view but his own. He follows the narrow path of paladinhood—something is right or it is wrong, black or white, up or down. There is no middle ground.

Moderating that viewpoint are the facts of life on the *Spelljammer*—that the majority of the races on board are neutral, and do not like to have any one force, regardless of how well intentioned, upsetting the balance. Chaladar bridles at the restrictions and works in small ways, cleaning up the ship of evil where he can.

Chaladar is tall, reddish-blond, with a neatly-trimmed moustache. His armor is of the Krynnish style, with ornate shoulder epaulets, but his shield carries a smiling sunburst—a later acquisition. He has named his sword of sharpness Scaleslicer, a move which has done little to endear the paladin to either Suza the Brass or the lizard men.

Chaladar is stiff-necked and no-nonsense. He does not believe in fussing about, nor in rumors unsupported by fact. He believes (firmly) that the tales of the Fool are the creations of the Long Fangs and the Tenth Pit, to disguise their own criminal doings. While he admits that something bad happens with the ascendancy of a new captain, he does not believe that it is so serious that it will threaten him or his people; in fact, in times of crisis, men and women rally around the forces of good, and so he welcomes a new captain. Provid-

ed, of course, that the new captain is both lawful and good.

Chaladar has no tolerance for evil, or even most neutrals (who he believes to be misguided but harmful in that they do not convert to the true path of law and goodness). He will not dine with, nor acknowledge known thieves, and such individuals will be banned from the chalice tower. He is used to not getting any arguments from others in this matter.

Despite all this, Chaladar is a loyal ally, and if he gives his word to other good lawful individuals, he will keep it. The best way to court his favor is to slay an evil creature on the ship, and offer proof of that killing to him.

Chila

Chila Irontooth
18th Level Fighter

HEADQUARTERS: The tower of trade (area #12)
ARMOR CLASS: -2 (leather armor +2, Dex bonus +4, ring of protection +4)
MOVE: 12
HIT POINTS: 150
NO. OF ATTACKS: 2
DAMAGE/ATTACK: 1-10 (two-handed sword)
SPECIAL ATTACKS: Nil
SPECIAL DEFENSES: Nil
MAGIC RESISTANCE: +4 to all saving throws
SIZE: M (5 ft.)
ALIGNMENT: N
PSIONIC ABILITY: Nil
Str 15 Dex 18 Con 17 Int 15 Wis 12 Cha 15

Chila Irontooth was a spaceborne warrior from the Land of Kasros in the sphere of Homespace. Early in her career she had the "canine" teeth in her mouth replaced with ones of cold iron, both giving her present surname and allowing her to

Chaladar has ruled the chalice tower for only four years but has proved a capable leader. He is a loyal ally, and if he gives his word to other lawful individuals, he will keep it.

PERSONALITIES OF THE SPELLJAMMER

win a pitched battle with a jackalwere. Chila has ruled her little operation for years now, watching self-important fools such as Chaladar and blustering bombardiers like CassaRoc come and go with the tides of space.

Chila Irontooth arrived during the last dark times, and seized control of the tower of trade, saving a large number of humans as well. She has remained a favorite of the various human communities, despite her selling her group's services to other races, because she distributes the wealth to nonadventuring humans (and in turn uses them as protection from reprisals).

Chila is a black-haired, middle-aged woman in excellent fighting condition, her dark hair streaked with grey and pulled into a tight braid down the back. She likes to move fast and inflict damage, as reflected by her armor and weapon choice. One eventual goal she has is to further increase her offensive power with a magical two-handed broadsword, and anyone possessing one will receive an offer for purchase.

Unlike CassaRoc, Chila does not go looking for new recruits. If fighters are interested, they will come to her. She makes it clear that her personal code is to furnish the best warriors available to the best side that pays. If an individual has problems with fighting alongside neogi or illithids, he should find another group to hang out with, such as CassaRoc's drunken louts.

Chila believes that there is a Fool, a universal force of evil on the ship, and that there are secret captains, similar forces of good. The fact that neither have contacted her makes her feel fairly comfortable in the fact that she is doing her job well.

Coh

Master Coh
Leader of the Neogi

HEADQUARTERS:	The neogi tower (area #27)
ARMOR CLASS:	5
MOVE:	6
HIT POINTS:	40
NO. OF ATTACKS:	3
DAMAGE/ATTACK:	1-3/1-3/1-6
SPECIAL ATTACKS:	Slowing poison
SPECIAL DEFENSES:	Nil
WIZARD SPELLS:	1st:4, 2nd:4, 3rd:4, 4th:2
MAGIC RESISTANCE:	Nil
SIZE:	S (3 ft.)
ALIGNMENT:	LE
PSIONIC ABILITY:	Nil

Coh is the most recent of the leaders of the neogi of the *Spelljammer*. His predecessor had been reduced to the status of a Great Old Master, the breeder of future neogi, as a result of his failures (namely a continuing war with the beholders). Master Coh intends to avoid that same fate, if he can help it, by increasing the number of slaves owned by the neogi, replenishing their numbers, and finishing the war with the eye tyrants.

He is hampered in all these matters by the fact that practically every other race on the ship has a rabid hatred of the neogi, and that none will come to his aid. There have been several neogi colonies on the ship through the years, and all of them have been wiped out in battle with other races.

Coh is actively searching for both allies and new slaves. A potential ally is the Fool. Coh has discovered that the Fool exists, and communicates with him through a zombified head kept in a box in his quarters. Coh asks for advice, and if the Fool chooses to respond, a message is found at the gates of the complex, left by either a zombie or one of the Xenos. Coh believes that the Fool is

Coh is the leader of the neogi aboard the *Spelljammer*. He aims to increase the number of slaves owned by the neogi, replenish neogi casualties, and finish off the eye tyrants.

PERSONALITIES OF THE SPELLJAMMER

secretly a necromancer, and the creator of the *Spelljammer*. Further, the Fool considers the other living races trespassers, caring not what Coh will do with them. The neogi does not understand that the Fool desires nothing more or less than the destruction of the *Spelljammer* and all who live on it, including the neogi.

Coh has magical ability, and has discerned that a future captain must be a magician of some type. He further believes that the Fool makes the choosing, and if he plays his cards right, he will become the next captain of the *Spelljammer*. Coh believes the Fool is challenging him to bring his own race to dominate the others, then he will be provided with the reward. At that point the Fool will be slain, and Coh will turn the *Spelljammer* into a master slaver's craft, reducing entire planets' populations to slavery.

Coh is a typical neogi, marked with a number of body tattoos, the most prominent being a set of interlocked circles on his forehead. His hissing form of speech and inverted grammar (he scrambles verbs, such as "Die you will screaming," instead of "you will die screaming") make him an unpopular individual among the other races. Still, backed up by his slave umber hulk Orik, Coh is avoided as opposed to confronted.

Demets

Demets the Chosen
Lizard King/9th Level Priest

HEADQUARTERS:	The gardens (area #2)
ARMOR CLASS:	3
MOVE:	9, Sw 15
HIT POINTS:	54
NO. OF ATTACKS:	1 or 2
DAMAGE/ATTACK:	3-18 or 1-3/1-3
SPECIAL ATTACKS:	Nil
SPECIAL DEFENSES:	Nil
WIZARD SPELLS:	1st:5, 2nd:4, 3rd:3, 4th:2, 5th:1

MAGIC RESISTANCE: Nil
SIZE: L (8 ft.)
ALIGNMENT: CN
PSIONIC ABILITY: Nil
Str 17 Dex 14 Con 15 Int 13 Wis 13 Cha 13

Demets is the favorite grandson of Arvanon, the only other lizard king in the population of the gardens, and the heir apparent of Arvanon (*q.v.*). However, he is much less than his sire, being incubated and hatched at a time when the *Spelljammer* was far from life-giving (and intelligence-inspiring) stars. As a result, Demets is more savage and more cunning than his grandsire.

Demets sees himself as the future lord of the gardens, and is intent on operating it in a more efficient manner, in effect using the supply of food on board to ultimately control all actions by all other races on the ship. Demets sees Arvanon's encouragement of self-sufficiency as self-defeating: the lizard men should be encouraging the opposite—a complete reliance on the gardens.

Demets has not lived through any of the dark times, and fancies that through control of the food, he can control the allegiance of any future captain, making himself the master of the game. To that end, he has entered into an alliance with the mad Arcane, in exchange for information on the nature of the captaincy. Demets is aware that a future captain must bring a particular item to the ship, but believes it to be some powerful and unique item, such as the *Hand of Vecna* or the *Cup of Crimson Wonder*. The price Demets paid was the sacrifice of his own sister, paying another to slay her. The direct murderer was caught and slain repeatedly by Arvanon. Arvanon is unaware of Demets's complicity in the crime, nor is he aware of Demets's dealing with Arcane.

Demets represents the gardens and its lizard men tenders in the council, replacing his grandfather in the task. Demets sees the council as a method of further enforcing control over the na-

Demets is the grandson of Arvanon and the only other lizard king living in the gardens, but he is much less than his grandsire—less intelligent, less civilized, and less principled.

PERSONALITIES OF THE SPELLJAMMER

tives of the *Spelljammer*. In the past he has cut special deals for particular members of the council. Arvanon has discovered such deals in the past, but has made no move other than to negate them when they are discovered.

Demets, as all lizard men, believes in the place of the lizard men as the guardians of the gardens for the *Spelljammer*, and for nature in general, and would never act in a fashion to harm the gardens. His devotion, however, ends at the edge of the gardens, and all other races are left to fend for themselves.

Demets is smooth, oily, and openly disdainful of other races, but is more accessible than his reclusive (but wiser) grandfather. He will be interested in anything that smacks of a deal, particularly one that can advance his own goals and those of his people. He would very much like to be the next captain, to the point of slaying (or having slain) individuals with powerful artifacts in the hopes of taking control. Failing this, he would

seek to use food as a weapon to control other factions.

The DM should portray Demets to the players as a friendly shark, savage and brutal, but capable of hiding behind his grandfather's power if he needs to. He is an untrustworthy ally and a deadly foe, such that those who cross him may end up "accidentally" offending the lizard men of the gardens, and finding themselves without allies among the various citadels.

Demets lacks the trident of his grandfather—in theory that would be part of his heritage in the event of Arvanon's passing. So far Arvanon's popularity and protection for Demets has prevented the young lizard king from seeking to attain that goal early, but if his grandfather's position weakens, he will think nothing of taking advantage, removing both the trident and mantle of command from Arvanon's dead body.



PERSONALITIES OF THE SPELLJAMMER

"Diamondtip"

Lord High Gunsman Rexan "Diamondtip" Hojson
Giff Commander (8 HD)

HEADQUARTERS: The building of the giff
(area #18)
ARMOR CLASS: 6 (2)
MOVE: 6
HIT POINTS: 64
NO. OF ATTACKS: 2 or 1
DAMAGE/ATTACK: 1-6 +7 or
1-6 (starwheel pistol)
SPECIAL ATTACKS: Head butt
SPECIAL DEFENSES: Nil
MAGIC RESISTANCE: 10%
SIZE: L (10 ft.)
ALIGNMENT: LN
PSIONIC ABILITY: Nil
Str 19 Dex 13 Con 17 Int 14 Wis 12 Cha 10

"Diamondtip" is a large and powerful giff who takes his name from a jewel-studded plate that he has bolted to his snout. The plate covers an old sword-wound from Argargon the gnoll-king himself. Hojson had the plate made of steel, overlaid with ivory, and studded with white gems, giving him his nickname. The plate is worth 40,000 gp, but likely cannot be sold on the ship, since it will take slaying "Diamondtip" to remove it.

"Diamondtip" is equally proud of his custom-made bone-and-ivory suit of armor, called affectionately "The White Suit," which he wears only into combat. The suit is enchanted with a *protection from normal missiles* spell, and carries a *brooch of shielding* over the heart. "Diamondtip" in his white suit is cause for concern in that it means a major battle is imminent (and that means a lot of smoke powder and destruction).

When not in combat, "Diamondtip" prefers a white military jacket (with medals from previous campaigns over the pocket), ruffled shirt, and black slacks tucked into knee-high leather boots

made of beholder-flesh (the beholders once stiffed the giff after hiring them).

"Diamondtip" is organized and precise. He wants to know as much as possible about his battlefield before going into it, and as a result has an excellent collection of maps in his command quarters. He has maps of all the human quarters, the dwarf citadels (but not those of the elves or gnomes), the common buildings (such as the council), the centaur and dragon outposts, and the beholder and gnoll ruins. He does not have any maps to the territory of the mind flayers or neogi, or any of the ship's regions. He has a partial map of the warrens, showing a few entrances, but does not have the manpower (or giff-power) to fully explore that area.

Other than his mania with maps, "Diamondtip" is a typical giff—loyal to his comrades and devoted to the acquisition and detonation of smoke powder. "Diamondtip" is getting on in years, and those that know him are worried that he may soon take on the giff traits of their aging number—namely acting recklessly to prove his youthfulness.

Father Goat

Austinus Corbundium
Satyr

HEADQUARTERS: Communal Church
(area #19)
ARMOR CLASS: 5
MOVE: 18
HIT POINTS: 40
NO. OF ATTACKS: 1 head butt
DAMAGE/ATTACK: 2-8
SPECIAL ATTACKS: Charm, cause fear, sleep
(all through use of pipes)
SPECIAL DEFENSES: +2 on his surprise rolls
MAGIC RESISTANCE: 50%
SIZE: M (5 ft.)
ALIGNMENT: N
PSIONIC ABILITY: Nil
Str 14 Dex 14 Con 15 Int 12 Wis 14 Cha 16

"Diamondtip" takes his name from a steel plate, overlaid with ivory and studded with jewels, that is bolted to his snout.

It covers an old sword-wound he received from Argargon, the gnoll-king.

PERSONALITIES OF THE SPELLJAMMER

Father Goat was originally a satyr name Austinius, and was a native of the Elven Court, that woods in the Forgotten Realms just north of Cormyr. He was calmly minding his own affairs (affairs of the heart, they were), when he was suddenly wrapped up by a monster summoning spell and forced into aiding a group of adventurers in combat. Said adventurers made their escape from battle by means of a dragonfly-class spelljamming ship, taking the Satyr in tow. The battles and adventures that followed are a blur for Austinius, given that he suffered from a bad case of motion sickness. His few brief excursions on relatively solid ground (such as the Rock of Bral) ended in his capture either for disturbing the peace or as a curiosity in space. Eventually, he made his way to the *Spelljammer*.

The *Spelljammer* delighted Austinius, as the ship was large enough to avoid giving him the queasy feeling of hanging in space. He quickly saw the great ship as a literal savior. This sudden case of "getting religion" resulted in Austinius taking on a new name, Father Goat, and dedicating himself to helping the other outcasts who, through no fault of their own, end up trapped in wildspace. In this regard, he has become the founder of the Communal Church of Wildspace.

Father Goat has no priestly powers, and worships no extra-planar deity. He sees his small church as a sanctuary for those creatures who have no home elsewhere, whether because of race, belief, or nasty personal habits. As a result, a mixed bag of creatures make the church their home. The church is also the headquarters for a collection of petty thieves, cheats, and grifters. Father Goat tolerates such activities, indeed, he remembers when he was young(er) and wild(er). At worst he recommends discretion and wisdom in thefts and cons, so as to avoid retribution.

Father Goat maintains good relationships with both the human communities and the illithids, and is often called upon to act as mediator in disagreements between the two communities. Goat

has many humans and halflings in his flock, such that often other citadels hold back on reprisals in fear that the other human groups might rally to Goat's side. Goat has proved to be even-handed in his mediation.

Actually, Father Goat has been charmed by Trebek, the leader of the mind flayers (*q.v.*). Trebek visits twice weekly with alms for the poor, and reinforces his charm, continually conquering the Satyr's magic resistance purely through massive repetition. Trebek uses his influence over Father Goat sparingly, however, so as not to reveal the fact that he has the satyr under his control. Father Goat is positively disposed toward the illithid, but most other natives understand that, since Trebek contributes to the church.

Father Goat wears a black floor-length robe and clerical dog-collar, but retains a great deal of his natural tendencies, even now that he has taken the cloth. He seems to be continually smiling, amused by some inside joke, and always advocating compromise and discussion over pitched battle. He believes that the Fool is the incarnation of interracial evil in the world of the *Spelljammer*, created by all the hatred that has passed above. Only when all fighting ceases will the ship's karma be cleansed and the Fool be defeated. A local legend says that Father Goat contested the Fool for the lands of the church and beat him. This is untrue, but Father Goat will not deny it.

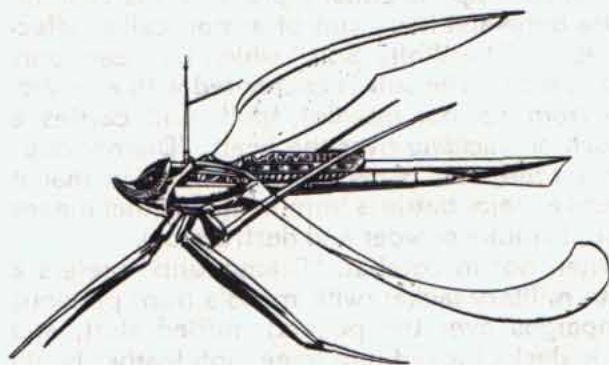

Father Goat maintains good relationships with both the human communities and the illithids, and he is often called upon to act as mediator in disagreements between the two factions. He has a reputation for evenhandedness.



Firespitter

Vagner Firespitter of the Free Dwarves
10th Level Dwarven Fighter

HEADQUARTERS: The free dwarves' citadel
(area #23)

ARMOR CLASS: -1 (*bracers of defense*)
AC 2, Dex bonus)

MOVE: 9

HIT POINTS: 100

NO. OF ATTACKS: 2/1

DAMAGE/ATTACK: 1-4 +2 (*warhammer* +2),
1-3 +paralysis venom
(hand crossbow)

SPECIAL ATTACKS: +1 vs orcs, half-orcs,
goblins, hobgoblins;

SPECIAL DEFENSES: -4 to be hit by giants,
trolls, ogre mages, titans
+5 on saves vs. spells,
wands, rods, staves, and
poisons

MAGIC RESISTANCE: See above

SIZE: S (4 ft.)

ALIGNMENT: CN

PSIONIC ABILITY: Nil

Str 13 Dex 17 Con 18 Int 15 Wis 14 Cha 15

Firespitter is the leader of those dwarves who chafe under the restrictive, hidebound, and bureaucratic leadership of the Kova family, and seek to experiment in new ways in craft, art, and metalwork. He and his followers are more free-wheeling, creative, temperamental, and generally

Firespitter and his dwarf followers are more freewheeling, creative, temperamental, and generally dangerous than their restrictive, hidebound, and bureaucratic companions in the Kova citadel.

PERSONALITIES OF THE SPELLJAMMER

dangerous than their companions in the Kova citadel.

Firespitter is a scarlet-haired dwarf with a multi-colored beard, about 4 feet high and 3 feet wide at the shoulders. His rainbow beard is the product of numerous fashion statements, several dye-jobs, and a few failed experiments. He keeps the beard braided with gold laces, tipped with rubies (500 gp value). He disdains armor, and usually wears a wide variety of colorful (and usually clashing) cloaks, shirts, and slacks. His followers usually maintain the look in rebellion of Kovan mores, so that a collection of them look like a living prismatic sphere.

Firespitter is incredibly talented and equally temperamental. As noted in the entry for the Free Dwarves' citadel, Firespitter will often hold up one of his own works for criticism, not revealing that he is the creator. He makes a few disparaging remarks about the piece—its crude technique or poor choice of material. If the listener joins in and adds his criticism, Firespitter will turn angrily on the critic, suddenly defending the inner beauty of the piece, which the critic has (obviously) missed as a result of his ill-bred upbringing and total lack of artistic talent. Firespitter will launch into a five-minute tirade about heathens and critics. If the would-be critic was seeking a favor, he has now found himself at the bottom of Firespitter's "to-do" list.

If the individual meeting Firespitter defends the craft of the persecuted piece, the dwarf will welcome him as a true artistic spirit, and will be willing to help (such help usually extends to providing equipment, but not manpower). Firespitter is relatively loyal, and if he gives a promise, he will keep it, unless he has forgotten in the meantime.

Firespitter is fond of argument and bluster. If matters look like they are getting out of hand, he can protect himself with a hand crossbow, its quarrels tipped with neogi slowing poison. Firespitter claims to fetch the poison himself, defeating the neogi in the process.

Firespitter believes that the *Spelljammer* is moved through space by the creative input of the Dwarves, their regular fashioning and refashioning of weapons and jewelry. The ship was originally created by the dwarven gods, and operates according to their whims. The Fool is a creation of the Kovans, and a clumsy, unthinking creation at that—only those bureaucratic metal-heads would think of scaring someone with a boogiemán living in the heart of shivak territory.

The Fool

Romar the Fool
Master Lich

HEADQUARTERS:	The warrens (area #42)
ARMOR CLASS:	-2
MOVE:	6, Fl 12 (C)
HIT POINTS:	80
NO. OF ATTACKS:	2
DAMAGE/ATTACK:	3-18
SPECIAL ATTACKS:	Paralysis
SPECIAL DEFENSES:	Immune to enchantment and necromantic magic, polymorph, poison, cold, insanity, electricity; <i>amulet of protection against detection and location</i>
WIZARD SPELLS:	1st:5, 2nd:5, 3rd:5, 4th:4, 5th:4, 6th:2
MAGIC RESISTANCE:	20%
SIZE:	M (5 ft. 5 in.)
ALIGNMENT:	CE
PSIONIC ABILITY:	Nil
	Str 13 Dex 17 Con 15 Int 18 Wis 17 Cha 5

The creature known as the Fool was once a human captain of the *Spelljammer* named Romar. Romar was a serious, intense young human, driven to conquer any obstacle. However, with the amount of power the *Spelljammer* possessed, his direct-line approach meant reaching for the ship's

The Fool was once human and a captain of the *Spelljammer*. But the great ship's power drove him to less and less subtle methods, until eventually he proved too dangerous and was removed.

PERSONALITIES OF THE SPELLJAMMER

"sting" regularly, and Romar left the debris of dwarven citadels and asteroid ports behind him in the wake of his decisions. As with other dangerous captains, *Spelljammer* sought to remove and imprison him.

But Romar's drive, determination, and intelligence short-circuited that attempt. He has discovered the fate of those who passed before him, and made alternate arrangements, including deals with various dark forces of other planes. When the shivaks finally broke into the control room, Romar took his own life, intent on his dark allies to rescue him.

However, Romar did not take into account the fact that most extra-planar beings have nothing to do with the *Spelljammer*, and avoid it where possible. In slaying himself, Romar called into play his old dealings with these beings, but they could not or would not respond by pulling him from the great ship. He was trapped, and his form given an undying life of lichdom.

Romar suddenly dropped from sight, as the *Spelljammer* could no longer see his undead energy. He fled from the control room into the warrens, where he hid from the various natives of the citadels above.

In the process, Romar's body and mind twisted into their present shape, and he went mad. His name was recorded as a former captain, but he became the entity known only as the Fool.

The Fool is a master lich, a new form of undead (see new monsters section). He is unaffected by the atmosphere of the *Spelljammer*, but cannot leave it as his spirit would then be collected by his dark allies. Therefore he remains, working diligently toward a new goal—destruction of the *Spelljammer*, so that he may take the great ship with him in his passing.

The Fool is pictured by the populace of the *Spelljammer* as dressed in ripped, rotted finery, his face a mask of dried skin tightened over the skull. His distinctive trademark is a cap of bells that he wears on his head, and the jangling sound of ap-

proaching bells often warns of his presence (for the same reason, he has been known to give a zombie or undead servant the bells in order to move silently himself).

In reality, the Fool is a powerful individual, his skin translucent and tight over his skeletal frame. He wears a hooded cloak of star black, trimmed with gold around the sleeves and hood. His eyes glow with a golden resonance, such that with the hood up all that can be seen are the twin lamps of his eyes. The Fool allows the grim jester image to persist, if only because that allows the natives something else to worry about.

In addition to his normal abilities, the Fool possesses an angle-bladed *long sword of lifestealing*. This weapon functions like the item in the DMG, but in addition, creatures which are drained of their life energy become zombies under the Fool's control. Also, the Fool carries a *wand of conjuration*, topped by a stuffed doll's head representing the Fool himself. The Fool uses the *wand of conjuration* for its *unseen servant*, *prismatic wall*, and *curtain of blackness* functions, but cannot access its monster summoning abilities.

The Fool knows the full story of the *Spelljammer*, having once been linked to it. He knows how one becomes captain, the closing of the gardens, the creation of the smalljammers, and the final fate of the captains. He guards that information most carefully, in that he wishes no others to benefit from it.

The Fool controls an undead army of about 160 common zombies and 40 monster zombies, the latter being both umber hulks and gnolls which have been taken under the control of the undead lord, including the former gnoll lord Argargon. The Fool's control allows him to see through their eyes, along with the eyes of the zombie rats. The Fool has practically eliminated the vermin problem on the ship by reducing most of the rodents to unliving status, where they serve as his eyes and ears throughout the ship.

Also under the control of the Fool are a group

In fact, the Fool is a master lich who controls an undead army of zombies, monster zombies, ghouls, spectres, and even a banshee. This army serves as his eyes and ears throughout the warrens and the ship.

PERSONALITIES OF THE SPELLJAMMER

of 20 ghouls, three spectres, and a banshee. These creatures are under the command of the Fool, but do not provide him with direct information like the zombies do. Instead, they have some form of free will, and occasionally act on their own. The ghouls are a colony rescued by the Fool from elimination at the hands of human adventurers, the three spectres are former humans, and the banshee is an undead elf which the Fool had tricked into destroying part of the elven complex.

The Fool wishes to divide the various factions of the ship with an eye to eventually destroying all life on board, turning the ship into a great ghost-ship, which he will then attempt to kill. To that end he has an agent deceiving the Xenos as the Hooded Soldier, urging them on to further terror. In addition, he has made his presence known to Master Coh of the neogi and the mad Arcane. Coh considers the Fool to be a potential ally, while the Arcane considers the Undead Lord a rival for control. In turn, the Fool considers both to be useful tools in further upsetting the balance on board the *Spelljammer*. Any contact between others and the Fool is through intermediates, usually zombies, which can be destroyed with little loss to the Fool's armies.

Most of the rest of the ship's natives consider the Fool to be little more than a bogey-man, or at worst a monster that may be lurking in dark quadrants of the ship, evading the shivaks only through brute cunning. Charms against his influence and effects are sold in the market, but all which do not have specific power against the undead are useless. None of the *Spelljammer* natives have seen the Fool; those who have usually have soon after joined his zombie legion.

The Fool travels light, and is wealthy in his number of followers. He maintains a number of small niches and hiding holes throughout the ship's warrens, and will move quickly from one to another, using his zombies and zombie rats to warn him of attackers. Only if individuals are able to move invisibly or destroy all undead before

they are seen will it be possible to sneak up on the Fool

Newcomers, and even long-term residents, will be unlikely to encounter the Fool face to face. He sees his hidden nature as the reason for his current survival, and has no desire to change it. If the heroes seek out the Fool to destroy him, they will find traps and undead ambushes waiting for them. If the heroes seek out the Fool to deal with him, they will be attacked a few times, then an undead emissary will appear with a note from the Fool to pass on to the heroes.

The Fool should appear to have almost godlike knowledge in his home territory of the warrens, much less so in the citadel areas of the ship, and none at all in the ship's regions. This is solely as a result of using the zombies and zombie rats as an advance warning system. The Fool will occasionally send his undead rats into the citadels to spy on potential rivals (Coh is unaware of this effect, but the Arcane does know, and forbids all vermin from his tower). If the heroes can somehow "blind" these undead creatures, the Fool will not know what they are up to. Those he finds truly dangerous he may attack with a team of agents (from the Xenos), hoping to dispatch the enemy before they get too far.

The Fool will fight only if he has no other escape, and will first attempt to escape, tempting the heroes with knowledge in exchange for avoiding damage. His voice is the rattling, hissing speech of such undead, and he seems deathly serious. The name Fool does not apply to him so much as to the fact that by his craftiness he has fooled others.



Most of the ship's inhabitants consider the Fool to be little more than a boogiemanager, or at worst a monster that may be lurking in dark quadrants of the ship, evading the shivaks only through animal cunning. No living creature aboard the *Spelljammer* has seen the Fool.

PERSONALITIES OF THE SPELLJAMMER

Gray Eye

Leader of the Beholder Citadel

HEADQUARTERS:	The beholder citadel (area #24)
ARMOR CLASS:	-1/1/6
MOVE:	Fl 3 (B)
HIT POINTS:	75
NO. OF ATTACKS:	1
DAMAGE/ATTACK:	2-8
SPECIAL ATTACKS:	Magic
SPECIAL DEFENSES:	Anti-magic ray, +1 on saving throws, <i>ioun stones</i> , <i>brooch of shielding</i>
MAGIC RESISTANCE:	Special
SIZE:	M (6 ft. diameter)
ALIGNMENT:	LE
PSIONIC ABILITY:	Nil

Gray Eye is an ancient beholder who has led his people through good times and bad and through more dark times than he wishes to remember. He is the oldest known beholder on the ship; though Miark the Blind, a former captain, is older, his presence is not known on the ship.

Miark came to captaincy at the same time as Gray Eye attained power, and with the beholder-captain's aid, Gray Eye learned how to best survive the dark times—through a combination of raiding, storage, cannibalization of slave races, and, if need be, sacrifice of eggs and junior members of the community so that the elders could survive. This policy has served Gray Eye well, and few other beholders survive who remember the last of the dark times.

The eye tyrants have been further reduced by a disease that spread through their group, the blinding rot, which robbed the beholders of their magical eyes and debilitated their minds and bodies. The blinding rot turned a healthy, powerful beholder community into a dozen creatures, hang-

ing on for survival. One beholder apparently survived his bout with the rot and recovered, and now lives outside the citadel, as steward of the ship (see Astor).

Gray Eye has let the ship's natives assume that the rotted beholders were dead and burned, but in reality, their embalmed bodies were kept alive in the heart of the ruins. As a result, the beholders still receive food from the Shivaks for numbers larger than are currently active. This food is being stored for the next dark time.

Gray Eye is aware of the Fool, and knows that he moves his base around in the warrens, but is unaware that the Fool was once a captain. Gray Eye's beholder mummies, while undead, are not under the control of the Fool.

Gray Eye is currently engaged in a small war with the nearby neogi, and as such often directs short airborne raids against the spider-creatures. Normally the war is conducted directly between the two towers, and while the beholders have the power, the neogi have the numbers.

Gray Eye is selfish and brutal, perfectly willing to sacrifice another's life for his own ends. He is even more willing to sacrifice another race's life for his own ends, and beholder hirings are common for raids against the neogi. Their food surplus and wealth of treasure left behind by their former comrades give them the money to hire mercenaries. They must hire in person, as their gnoll slaves were destroyed in the blinding rot plague as well. On Gray Eye's dictum, beholders outside the tower appear in threes.

Gray Eye takes his name from the milky orb in the center of his body. It grows whiter and whiter with each passing year, a symbol of his age (as opposed to Old Astor, who is thought to be old because of his gray scales, but that is the result of the rot). Gray Eye wears a *broach of shielding* attached to one of his eyes. When in his lair (which is most of the time), he also has orbiting him four *ioun stones* (their orbits carry them away from firing eyes). These stones are a clear spindle (allows

Gray Eye has led the ship's inhabitants to assume that the corpses of those beholders killed by the Blinding Rot were burned, but in reality their mummified bodies are kept alive in the heart of the ruins.

PERSONALITIES OF THE SPELLJAMMER

Gray Eye to survive without food and water), an iridescent spindle (allows Gray Eye to survive without air), a pearly white spindle (allows Gray Eye to regenerate 1 hit point per turn), and a dusty rose prism (provides +1 protection—noted on AC above).

Hancherback

Hancherback Scuttlebay, Lord Mayor of Halflings
10th Level Thief

HEADQUARTERS: The halfling citadel (area #14), or the Open Air Public House in the market (area #6)

ARMOR CLASS: 7 (with Dex bonus)

MOVE: 6 (9)

HIT POINTS: 40

NO. OF ATTACKS: 1

DAMAGE/ATTACK: 1-4

SPECIAL ATTACKS: Nil
SPECIAL DEFENSES: Nil
MAGIC RESISTANCE: Nil
SIZE: S (3 ft.)

ALIGNMENT: N

PSIONIC ABILITY: Nil

Str 12 Dex 17 Con 16 Int 14 Wis 11 Cha 14

Hancherback is the political leader of the halflings, though their economic and spiritual leader is Kristobar Brewdoc (*q.v.*). Hancherback is a tubby, waddling halfling with sand-colored hair, dressed in halfling finery—usually leather leggings, a white blouse, and a black vest inscribed with runes and other designs. He is good-natured and always glad to see strangers, in particular human strangers.

Hancherback was born on the *Spelljammer* and knows no other life. He is less interested in the tales of the outer world, but is intensely interested in serving the needs of newcomers to the ship:



Gray Eye, Hancherback, Highstar

PERSONALITIES OF THE SPELLJAMMER

making sure they get comfortably settled among others of similar race and creed, and that needed supplies are provided (or at least directions given as to how to gain them). He and his halflings expect to be rewarded for these services, and accept payment both in gold coin and in barter (Hancherback readily accepts alcohol in all its forms).

Hancherback believes firmly in the Fool. He believes the Fool to be a creature from the lower planes who inhabits the dark passages of the ship, boring through them like a worm through an apple. He also believes that one of the requirements for captaincy should be humanity, and knows of no halfling captains in the (incomplete) history of the *Spelljammer*. He does not personally believe in the rumors of "secret captains" running the ship, but if there is a profit in it, he will point those interested to the guild and an audience with Leoster IV, Regent of All Humanity.

Hancherback's quarters are 10% living space, 90% treasure vault for all the extra material he has acquired over time, including gold (10-100 thousand), alcohol (20-80 barrels) and magical items and weapons (one of each major type, and five random miscellaneous magical items). Hancherback never uses magic himself, and refrains from using any weapons. He relies instead on his standing within the community to call upon a group of halflings and humans to rescue him should trouble arise.

Hancherback can usually be found in the Open Air Public House in the market district, working with Kristobar on helping newcomers with their problems. If not there, he is dealing with his duties as lord mayor of the halflings.

Highstar

Admiral Drova Highstar
8th Level Fighter/ 7th Level Wizard

HEADQUARTERS:	The elven high command (area #36)
ARMOR CLASS:	1 (elven chain plus Dex bonus)
MOVE:	12
HIT POINTS:	54
NO. OF ATTACKS:	3/2
DAMAGE/ATTACK:	1-8 (long sword +1/+4 vs. giants)
SPECIAL ATTACKS:	Nil
SPECIAL DEFENSES:	90% immune to sleep and charm spells
WIZARD SPELLS:	1st:4, 2nd:3, 3rd:2, 4th:1
MAGIC RESISTANCE:	See above
SIZE:	M (5 ft.)
ALIGNMENT:	LN
PSIONIC ABILITY:	Nil
	Str 13 Dex 18 Con 12 Int 16 Wis 14 Cha 17

The commander of all elven forces aboard the *Spelljammer* is Admiral Drova Highstar, late of the elven armada *Triumph* (now dismantled and retired from active service). Highstar has served in this position for 15 years now, and is the epitome of the elven naval academy.

That is to say, he is stiff-necked, obstinate, hidebound, book-bashing, and racist to all others besides elves. He is condescending to other humanoid races such as humans, dwarves, and halflings, relentless in his persecution of goblins and their ilk, hostile toward the declared evil races of illithids, beholders, and neogi, and intolerant of anyone, elf or otherwise, who thinks differently. He operates his tower in a stiff, precise, military fashion, with crisp salutes, well-pressed uniforms, and clipped speech being the order of the day. Any sentient creature with more than just the merest mote of creative imagination finds the ad-

Admiral Highstar is stiff-necked, obstinate, hidebound, book-bashing, racist, condescending, relentless, and intolerant. Fortunately, he has talented advisers.

PERSONALITIES OF THE SPELLJAMMER

miral to be a juggernaut of boredom, and spending five minutes in his presence to be a lifetime of punishment.

Highstar's conversation centers on three main topics: how to protect the *Spelljammer* from the forces of evil, how to deal with the goblin problem, and how all the other races of the universe are non-elven (and therefore not up to snuff in his eyes). Once these subjects are exhausted, he might move off into past campaigns, what with their goblin problems and non-elves mucking things up, but only the most die-hard elf fan (or enlisted elf unable to escape) will put up with this.

The admiral is beautiful along middle-aged elven lines: sharp features and graceful lines. His flaxen hair spills neatly over his broad shoulders, cut at the precise military length. He is often in his dress uniform, with the lightweight elven chain worn directly beneath his robes, and his sleek pants tucked neatly into his boots.

The admiral is no fool, but he does tend to be single-minded, chiefly because the weight of elven civilization, and even the survival of all good beings aboard the *Spelljammer*, seems to rest upon his shoulders. He and his staff must be ever-vigilant, never letting their guard down, lest the forces of evil make a cowardly attack, such as the one that destroyed the elven academy. Highstar is continually checking security, changing patrols, warning their supposed allies of potential dangers, and preparing for that inevitable attack. Goblin attacks, even with the goblins under the thumb of the mind flayers, are common enough that a few squads must strike out, killing the offending vermin, else the entire great ship would be awash in elven blood.

Highstar neither likes nor trusts Trebek, the goblins' supposed leader, who seeks to advance the goblin cause by crying to the council every time the elves take their vengeance, but is silent when good elves are slain by goblin assassins. The rest of the leadership either is too evil to care or too foolish to pay sufficient attention to the dangers.

Highstar knows of the coming of various captains over the years (it's in the log, after all), but evil has survived, and in some cases thrived, in the wake of such captains, so there is little that this apparent being can do to affect day-to-day life. The Fool is obviously a tool of the goblins, either a goblin himself, or something more deadly, perhaps a barghest or similar being. The Hobgoblin Priest is similarly the Fool's minion, trying to divide the rest of the great ship with tales of illithid atrocities, when it is very clear (at least to the admiral) that the two races are thick as thieves.

And so Admiral Highstar plows along, head up, eye bright, as completely oblivious to the "real world" as Si Loo is in the Shou tower. Should a danger present itself, it is fortunate that his advisers and commanders have sufficient flexibility to keep the elves from going down in defeat.

Hobgoblin Prophet

Hobgoblin Shaman

HEADQUARTERS:	The ogre wizard citadel (area #23)
ARMOR CLASS:	2
MOVE:	9
HIT POINTS:	22
NO. OF ATTACKS:	1
DAMAGE/ATTACK:	1-6 +4
SPECIAL ATTACKS:	Nil
SPECIAL DEFENSES:	Nil
PRIEST SPELLS:	1st:5, 2nd:4, 3rd:1
PRIEST SPHERES:	combat, divination, elemental
MAGIC RESISTANCE:	Nil
SIZE:	M (6 ft. 6 in.)
ALIGNMENT:	LE
PSIONIC ABILITY:	Nil
Str 18/01 Dex 15 Con 18 Int 13 Wis 15 Cha 18	

Highstar's conversation centers on three topics: protecting the *Spelljammer* against the forces of evil, combating the goblin problem, and reflecting on the inferiority of all non-elf races.

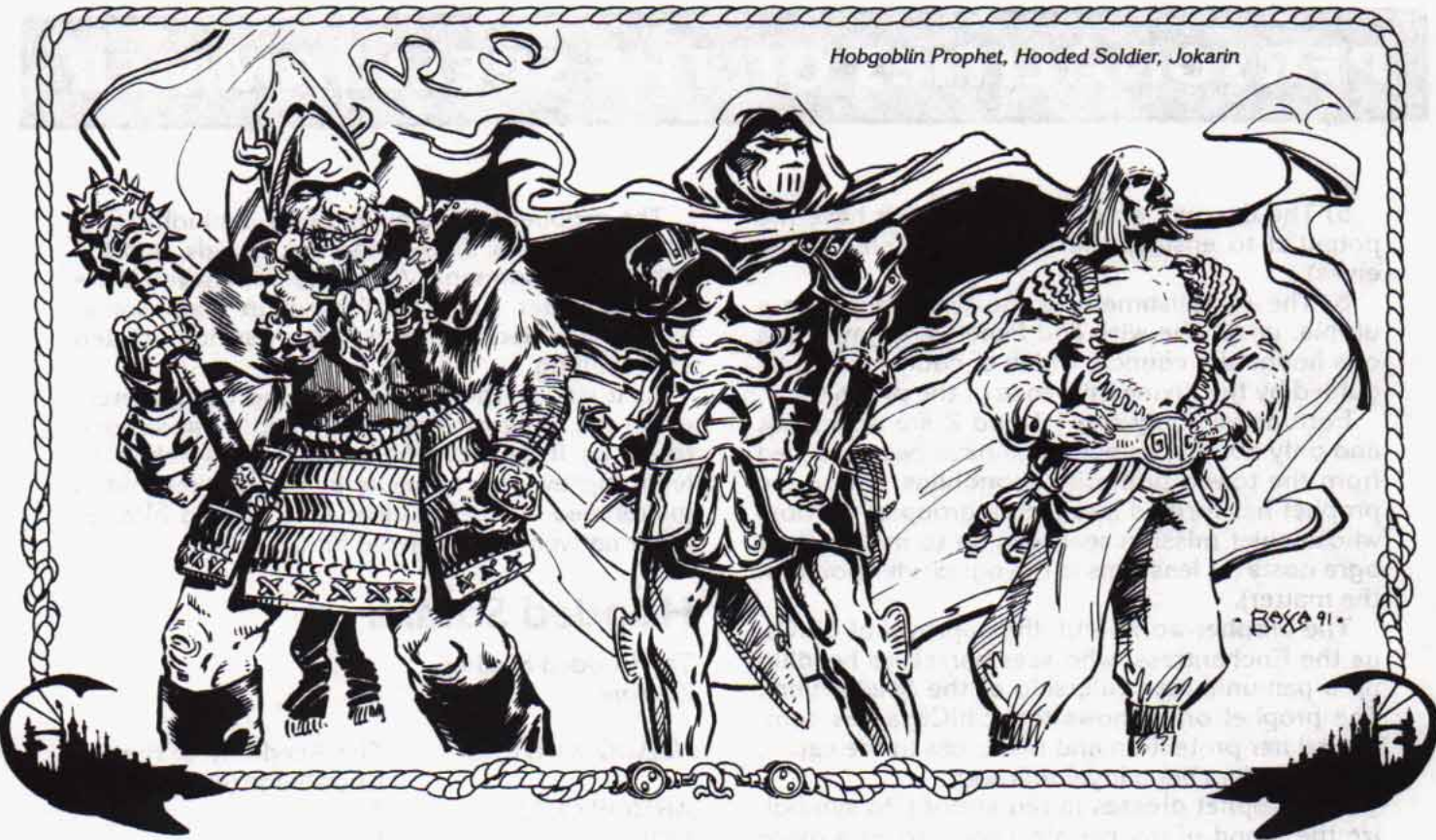

The Hobgoblin Prophet has no other known name. "My name was taken from me by the tentacled devils, and shall be returned to me only when all my people are free. Until the devils are turned to dust, I shall be no more than the humble voice of my trapped people, fighting to return them to freedom."

The prophet is a rare creature—an intelligent goblinoid who escaped the dinner tables of the mind flayers. The illithids keep their goblin slaves under control in part through skimming off the best and the brightest, leaving only the stupid ones to breed. The prophet not only avoided being killed, he also escaped from the horned tower, eventually finding refuge in the ogre wizard citadel, under the auspices of ShiCaga the Enchantress (q.v.).

The prophet is dedicated to the freeing of his

people to the degree of being a monomaniac. All other matters on the ship pale by comparison, and if the matter does not directly affect his people, he does not even recognize it. The Fool, the captains (secret and real), and the raids between rival citadels do not even register to him, and are dismissed if brought up.

The prophet sees the freeing of his people as being accomplished in several steps;

- 1) The rescue of the hobgoblins enslaved by the illithids.
- 2) The formation of those rescued hobgoblins into a fighting force.
- 3) The rescue of the remaining goblinoids from the horned tower.
- 4) The destruction of all illithids, so that this does not happen again.

The Hobgoblin Prophet is dedicated to freeing his people from slavery, but his version of freedom extends to destroying all potential enemies and seizing the *Spelljammer* for a goblinoid homeland.

PERSONALITIES OF THE SPELLJAMMER

5) The destruction of all races which have the potential to enslave the hobgoblins (chiefly the elves).

6) The establishment of the *Spelljammer* as a utopia, under the wise and beneficent governing of a hobgoblin council, which of course would be guided by the divine influence of the prophet.

Fortunately, only steps 1 and 2 are underway, and only about 20 goblinoids have been rescued from the tower, primarily hobgoblins. These the prophet has formed into a core group of warriors whose chief mission seems to be to irritate their ogre hosts (at least this is the ogres' viewpoint on the matter).

The prophet works with the approval of ShiCaga the Enchantress, who sees herself as heading up a pan-unhuman rulership of the *Spelljammer*. The prophet only knows that ShiCaga has committed her protection and resources to the cause, and considers her a loyal follower.

The prophet dresses in red armor ("to symbolize the blood of my people") and carries a mace with the head fashioned to resemble a hobgoblin's head ("so there may be no mistake to my foes who slays them.") Everything the prophet says, does, and wears ties back to his crusade. He is pedantic and practiced at discoursing extensively to prove his point. The ogres, with generally short attention spans, avoid arguing with him, as they do not have several days to listen to his litany of illithid atrocities. The prophet takes this as a sign that he has converted them.

As a shaman, the prophet has spellcasting ability. However, he can only cast spells in the divination, combat, and elemental spheres.

Interestingly, the prophet is unaware of the sentient nature of the brain mold in the horned tower, but even if he were aware, that would have little affect on his attacks on the illithids. At heart a racist who believes that all other races should be subordinate to his own, the prophet is ultimately fighting to free his people so they can enslave someone else.

The prophet has many enemies, including ShiCaga's two sons, Trebek and the illithids, and the elven high command. All would be relieved if the little monster suddenly turned up dead somewhere, provided their own group was not indicted in the killing.

As it stands, the prophet is being warily watched by the other groups, and his little band monitored as it grows. The prophet has taken to lecturing every few weeks in the market and is guaranteed to keep a clear area around him, as other natives seek to avoid him.

Hooded Soldier

The Hooded Soldier
Zombie

HEADQUARTERS:	The Academy of Human Knowledge (area #34)
ARMOR CLASS:	8
MOVE:	6
HIT POINTS:	16
NO. OF ATTACKS:	1
DAMAGE/ATTACK:	1-8
SPECIAL ATTACKS:	Nil
SPECIAL DEFENSES:	Immune to <i>sleep</i> , <i>charm</i> , <i>hold</i> , and death magic, poison, and cold
MAGIC RESISTANCE:	Special
SIZE:	M (5 ft.)
ALIGNMENT:	N
PSIONIC ABILITY:	Nil
Str 12 Dex 12 Con 12 Int 0 Wis 0 Cha 3	

The Hooded Soldier is the recognized head of the Xenos, a secret society based in the Academy of Human Knowledge. At the time of a meeting, the Hooded Soldier appears by means of a secret panel into the meeting room, where he communicates with his fellow members through a combination of thieves' signing (a silent tongue using hand signals), and messages drawn on paper with char-

The prophet has many enemies, including ShiCaga's two sons, Trebek and the illithids, and the elven high command.

All would be relieved if the little monster turned up dead somewhere.

PERSONALITIES OF THE SPELLJAMMER

coal. The Hooded Soldier never speaks.

The soldier is dressed as a warrior wearing a great cloak. Every part of his human body is perfectly proportioned and covered by armor, from his greaves to his neck. He wears a cowl up over his head and a silver mask across his face.

This mask is from Waterdeep, and is identical to those used by the Lords of the City to maintain their secrecy. No mind-affecting magic can be used against the wearer, nor can divination spells reveal the wearer's thoughts, alignment, or identity. Short of information from the gods, no one may divine the Hooded Soldier's true identity.

The Hooded Soldier, in fact, has no identity. It is a zombie under the control of the Fool, who uses it to order the Xenos to do his bidding, sowing discord and weakening the various houses and factions of the citadel district. The Hooded Soldier does not speak because it cannot—its true face is a ruin and its vocal chords have long-since rotted away. The Fool can move the Hooded Soldier's limbs and see and hear what it would hear, and as a result it signals and uses its signboards.

None of the Xenos know the Hooded Soldier's identity. If forced to reveal it, Burke and the other academicians will finger Si Loo (*q.v.*) as the likely suspect.

Jokarin

Jokarin the Bold, ex-captain
10th Level Fighter

HEADQUARTERS:	The dark tower (area #38)
ARMOR CLASS:	10
MOVE:	12
HIT POINTS:	90
NO. OF ATTACKS:	1
DAMAGE/ATTACK:	1-3 or with weapon
SPECIAL ATTACKS:	Nil
SPECIAL DEFENSES:	Nil

MAGIC RESISTANCE: Nil
SIZE: M (6 ft.)
ALIGNMENT: N
PSIONIC ABILITY: Nil
Str 17 Dex 16 Con 18 Int 12 Wis 13 Cha 12

Jokarin was the most recent of the captains, and he ruled more than 20 years ago for a period of only six months. During this time he forced the *Spelljammer* into a series of four battles with rival space fleets, until the ship determined that he was a threat to its own health and had him removed, dragged in the night through underground passages by the shivaks to the dark tower, where he remains to this day.

Jokarin had found an ultimate helm, disguised as a crown, in the lair of a celestial dragon. He fought through a number of hazards before attaining the *Spelljammer*, and took command in the control room. He declared himself captain in the landing deck, to the approval of thousands of sentients. Six months later many of the towers were in flames, and he was imprisoned by the servitor creations of the ship he served. The experience has left him bitter, even after 20 years.

Jokarin is still a powerful man, the first streaks of grey appearing in his shovel-bladed beard and raven-black hair. He misses his weapons and he misses his armor and most of all he misses the linkage between his mind and the *Spelljammer*, between his spirit and the spirit of the great ship. He plots and plans his escape, and dreams of finding another ultimate helm and taking command again of the *Spelljammer*, but all his attempts are foiled and he is always returned to the captains' quarters.

Jokarin will applaud any rescue, but will immediately attempt to overthrow and/or kill any sitting captain when he escapes. He knows of the Fool (who was a minor annoyance when Jokarin first appeared), and feels that he is the only one who can save his precious ship from that threat.

In fact, the Hooded Soldier has no real identity. It is a zombie under the control of the Fool, who uses it to order the Xenos to do his bidding and to sow discord among the various houses and factions of the citadel district.

PERSONALITIES OF THE SPELLJAMMER

Kaba Danel

Dracon Leader

HEADQUARTERS:	The dracon tower (area #40)
ARMOR CLASS:	5 (3)
MOVE:	18
HIT POINTS:	32
NO. OF ATTACKS:	2 or 1
DAMAGE/ATTACK:	1-4/1-4 or 1-10 (halberd)
SPECIAL ATTACKS:	Nil
SPECIAL DEFENSES:	Nil
MAGIC RESISTANCE:	Nil
SIZE:	L (12 ft. long)
ALIGNMENT:	LG
PSIONIC ABILITY:	Nil

Kaba Danel is the master of the dracon herd, having succeeded his father following that Kaba's untimely death at the hands of a beholder. To

Danel's credit, not only did he defeat the beholder who killed his father, he managed to escape from the other beholders who sought to pursue him. The pursuit lasted to the gates of the dracon tower, where only the presence of Suza the Brass convinced the eye tyrants to accept their loss and retreat.

Kaba Danel is still young at rulership, and confused by the maddening variety of different races on his home ship (and secretly thankful that his citadel is far from the others). He has managed to offend Highstar of the elves horribly by suggesting the elves were very similar to the goblins in appearance, and is personally afraid of the neogi, wanting to stomp out the spiderlike creatures like the bugs that they are. Hopefully, Kaba Danel's judgement and wisdom will improve with age. As it stands now, he is willing to help any good creatures, and leans heavily on advice from his shalla (local priest) and Suza.

Kaba Danel appears as a typical draconian, his

Kaba Danel, Koua, Korvok

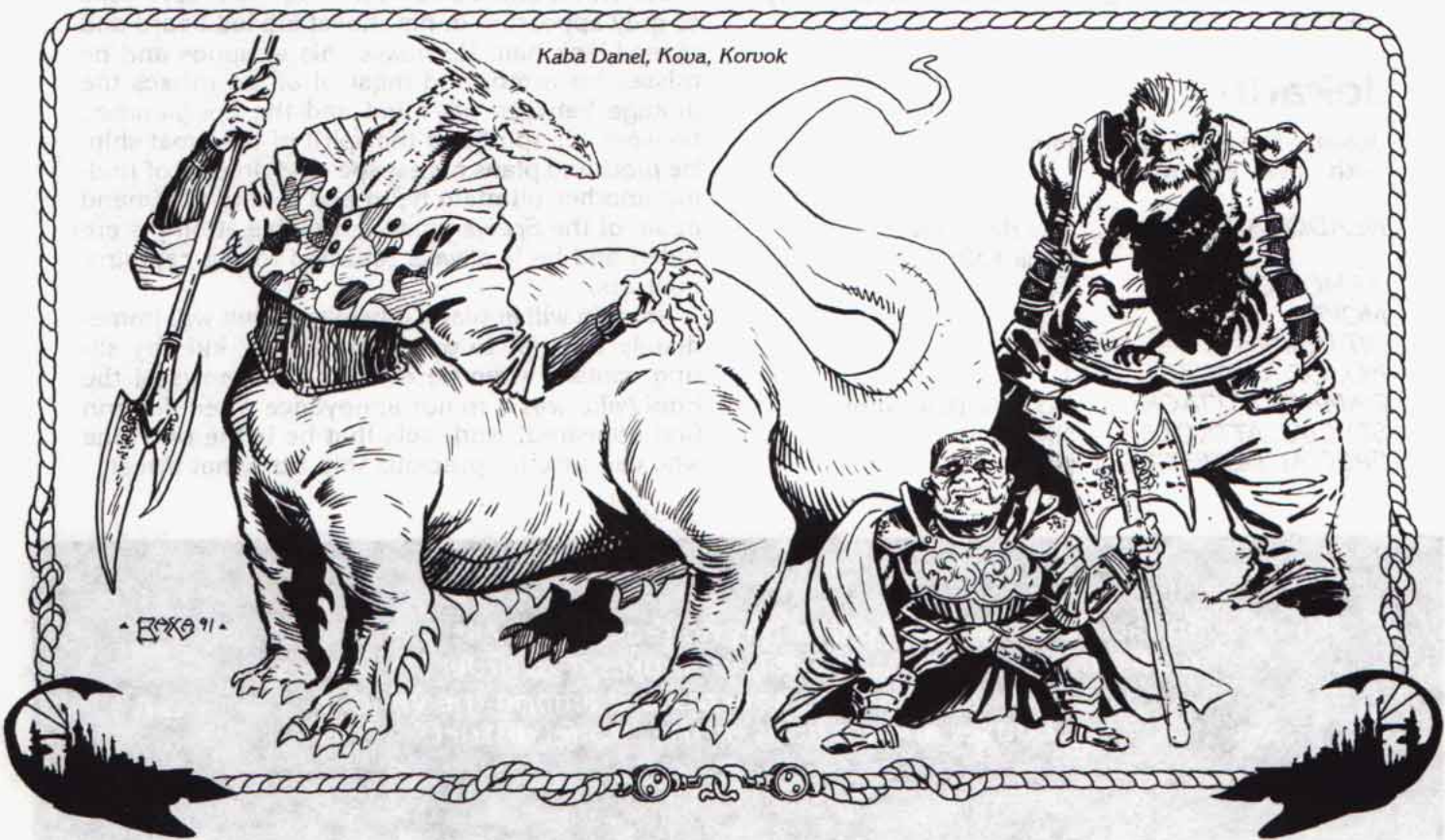

PERSONALITIES OF THE SPELLJAMMER

hide a tad more yellow than green, with a deep green stripe down his nose.

Korvok

Korvok the Fell
17th Level Thief

HEADQUARTERS: The Tenth Pit (area #32)
ARMOR CLASS: 0 (leather +3, Dex bonus)

MOVE: 12 (boots of striding and springing)

HIT POINTS: 74

NO. OF ATTACKS: 1

DAMAGE/ATTACK: 1-8 (long sword)

SPECIAL ATTACKS: Backstabbing, thief abilities

SPECIAL DEFENSES: Amulet of proof against detection and location

MAGIC RESISTANCE: Nil

SIZE: M (6 ft. 6 in.)

ALIGNMENT: LE

PSIONIC ABILITY: Nil

Str 12 Dex 18 Con 17 Int 13 Wis 14 Cha 7

Korvok the Fell fancies himself as the nastiest of the nasty, the worst the human race can produce, and is incredibly proud of his accomplishments: Looting, pillaging, and burning his way across the starfields until finally reaching the *Spelljammer*, where he magnanimously decided to set up permanent shop.

Korvok is a foul, unwashed brigand who assumes that everyone else is just as guilty as he, and that he has gotten as far as he has by being honest with himself about it. His favorite tactic is to root out one secret or another, something that would start a minor war, then let that slip into common knowledge, always hiring out his Tenth Pit group to the stronger of the two possible opponents.

Korvok can usually be found at his favorite ta-

ble, wenches and imported wine at hand (he has a taste for the off-ship varieties of alcohol). He is a powerful, wide-bodied man, quick and nimble despite his great size. His face is scarred from numerous fights, and his black beard is always short and patchy.

Despite his appearance and manners, Korvok feels that he is the ultimate in human development, in particular in regards to appeal to women. He fancies Selura Killcrow of the Long Fangs, and hopes that their partnership will blossom into something more worthwhile. He should not hold his breath (though those in front of him might wish he would).

Kova

Agate Ironlord Kova
12th Level Dwarven Fighter

HEADQUARTERS: The citadel of Kova (area #25)

ARMOR CLASS: 0 (plate +3, no shield)

MOVE: 6

HIT POINTS: 119

NO. OF ATTACKS: 2

DAMAGE/ATTACK: 1-8 +6

SPECIAL ATTACKS: +1 vs. orcs, half-orcs, goblins, hobgoblins;

-4 to be hit by giants, trolls, ogre magi, titans

SPECIAL DEFENSES: +5 on saves vs. spells, wands, rods, staves, and poisons

MAGIC RESISTANCE: See above, otherwise nil

SIZE: S (4 ft.)

ALIGNMENT: LN

PSIONIC ABILITY: Nil

Str 18/50 Dex 9 Con 18 Int 12 Wis 13 Cha 12

Kova is the name of the largest citadel on the *Spelljammer*, the leading family of that citadel, and the title of the patriarch of that family. The

Korvok the Fell fancies himself as the nastiest of the nasty, the worst the human race can produce, and is incredibly proud of his accomplishments: looting, pillaging, and burning his way across space.

PERSONALITIES OF THE SPELLJAMMER

Kovans are among the oldest continuous citadel lines on board the ship, and the most conservative. Agate Ironlord Kova, or "The Kova" in conversation, has held his position for more than 100 years, through at least two dozen dark times.

A powerful, broad-built dwarf with a closely-cropped gray beard, Kova is no dotard on his throne. He is actively involved in council matters, planning and leading raids, and even working in the foundry, refashioning weapons and procuring new metals. The Kova is comfortable in armor and has several sets in his throne room. As a symbol of his office, he carries a *battle axe* +3 which has the ability to detect and identify metal.

The Kova family is said to stretch back to the origins of the *Spelljammer* itself, but that may be just speculation. All the tales of the Kovans and the *Spelljammer* (told from a dwarf-eyed view) were written down in great books of steel plates, a tradition that continues today. Only Volumes 13 and 14, cataloging the last 150 years of the *Spelljammer*, currently survive, the others being lost or stolen.

The Kova is open and friendly toward other dwarves, reserved and cool toward nondwarves. Much of the pain of the Kovans has been caused by ties (in one way or another) to outsiders, such that they are very cautious about dealing with other races. The Kova holds humans in the highest regard, but places elves and halflings almost with beholders and the neogi in disdain.

Agate Ironlord Kova's heir apparent is a nephew, Sulfer Darkblood Kova. The nephew's attitudes and abilities are so similar to his uncle's that a change in rulership would hardly be noticed.

The Kova teaches that the *Spelljammer* is controlled by dwarf elders beyond even his level of power, and it is the creative activity of the *Spelljammer's* foundry that gives it motive force. He can point to the fact that dwarven citadels are the only other vessels massing greater than 100 tons which are capable of moving at spelljamming speeds, and that no dwarf has ever, in the known

histories of the *Spelljammer*, become "captain," a false title created by greedy humans to exploit their own power.

The Fool is known to the Kova as the burrower, and is described as a skeletal worm that twists through the heart of the *Spelljammer* like a parasite through an apple. Mortal men brought the burrower to the *Spelljammer*, and it is up to mortal men to take care of it.

Kristobar

Kristobar Brewdoc
5th Level Halfling Fighter

HEADQUARTERS: The Open Air Public House, in the market (area #6), or, failing that, the halfling district (area #14)

ARMOR CLASS: 4
MOVE: 6 (9)
HIT POINTS: 30
NO. OF ATTACKS: 1
DAMAGE/ATTACK: 1-6 (long sword)
SPECIAL ATTACKS: +3 with bow and sling
SPECIAL DEFENSES: save vs. magic and poison as 9th level fighter

MAGIC RESISTANCE: Nil
SIZE: S (3 ft. 6 in.)
ALIGNMENT: CG
PSIONIC ABILITY: Nil
Str 13 Dex 16 Con 15 Int 9 Wis 10 Cha 17

Kristobar Brewdoc was born and raised on the great ship, and was a mere pup when the gardens last closed with the ascendancy of a captain. In the time since then, he has endeavored to apply himself to the life he knows best, that of brewing and working a tavern. His latest (and most successful) attempt in the latter has been the Open Air Public House, located in the market district. Brewdoc oversees a staff of about a half-dozen halflings,

Lord Kova believes that the *Spelljammer* is controlled by dwarf elders and that it is the creative activity of the *Spelljammer's* foundry that gives the ship motive force.

PERSONALITIES OF THE SPELLJAMMER

cooking, cleaning, and serving drinks at any one time. The halflings have a standing rule ("no pilfering on the premises") which makes the location an ideal meeting spot for the various races.

Brewdoc is a dreamer, and while his dreams tend to center around the *Spelljammer* itself, he is more than interested in the activities of others, in particular newcomers. He has the standard halfling energy and curiosity toward new things, and while he would never think to leave his home, he is glad to hear tales from other lands. These tales, along with whatever other information comes along, are then funnelled back to Old Astor (*q.v.*), who is a combination ally, protector, overseer, and bookkeeper.

Brewdoc is lean in halfling terms (which tends to a mean "thinner than a keg"), and very excitable. His green eyes gleam with energy when he's listening to tales, and given the right speaker, he will sit for hours, listening to every word someone has to say, and remembering it.

Brewdoc is a wonderful source of information on daily life in the great ship. He knows nothing about how to become a captain, nor the cycle of the ship, but he can give very good input on most of the other major players, at least those who spend any time in the Open Air. He is prejudiced toward humans in general and against dwarves and elves, who tend to be elitist toward their fur-footed cousins. He also does not trust the beholders, given their own dislike of Astor. His comments reflect these basic assumptions (a beholder's actions are always suspect, while a human may be given "the benefit of the doubt").

Brewdoc is more than willing to listen to the players, asking questions in an excited voice. If asked for information, he'll provide it if possible, but in a loud fashion, motioning with his hands. ("You want to know about TREBEK?" he says loudly, pointing toward a table of mind flayers who have suddenly craned their heads in your direction, "He's one of them ILLITHIDS! DANGEROUS lot, they are, and LOUSY TIPPERSI!") Gold

and other valuable items might persuade him to lower his voice.

Brewdoc and most of his staff have never ventured into the warrens, though they know of a second cousin or two who have, never to return. Brewdoc believes the ship is ruled by "secret captains" who control everything, and "the Fool" is merely something these captains made up to keep folk out of areas where they weren't wanted.

Leoster

The Puissant and Sage Leoster IV,
Regent of All Humanity
20th Level Fighter/13th Level Wizard (dual-class)

HEADQUARTERS:	The guild tower (area #13)
ARMOR CLASS:	0 (<i>bracers of defense plus boots of speed</i>)
MOVE:	24 (<i>boots of speed</i>)
HIT POINTS:	120
NO. OF ATTACKS:	2
DAMAGE/ATTACK:	Either 1-6 +2 (as mace), 1-8 +1 (as sword of flame), 1-8 +4 (as battle axe), or 1-6 +3 (as spear); all are functions of his <i>rod of lordly might</i>
SPECIAL ATTACKS:	Paralyzation, fear, drain 2-8 hit points, all functions of his <i>rod of lordly might</i>
SPECIAL DEFENSES:	<i>ring of invisibility, ring of fire resistance</i>
WIZARD SPELLS:	1st:5, 2nd:5, 3rd:5, 4th:4, 5th:4, 6th:2
MAGIC RESISTANCE:	Nil
SIZE:	M (5 ft. 7 in.)
ALIGNMENT:	LN
PSIONIC ABILITY:	Nil
	Str 16 Dex 13 Con 18 Int 15 Wis 13 Cha 15

Brewdoc is a wonderful source of information on daily life in the great ship. If asked for information, he'll provide it if possible.

PERSONALITIES OF THE SPELLJAMMER

Leoster is also known as the "Silver Lion," a reference to his long, gray hair and beard, well-trimmed and braided with silver cords. He has been in charge of the guild tower as long as Arvanon has ruled the lizard men, and seen his share of captains and would-be captains come and go.

Like most of the guild, he and his extended family are insular, more concerned with the latest tower gossip than any particular attack or threat to the *Spelljammer*. Only when the hordes of goblins or legions of beholders are at the very gates do he and his people choose to enter the fray, usually with exceptional results. His walking staff is really a *rod of lordly might* and his shoes are *boots of speed*. Combined with his *bracers of defense* (AC 2) and *rings of invisibility* and *fire resistance*, he is a fighting machine that no one wishes to get too angry.

Fortunately, Leoster is rather distracted in his dotage, and it would take something on the order of a major assault or the arrival of a new captain to

jar him out of it. He is very interested in his coin collection, and is always interested in new additions. Individuals from other worlds may find ancient coins in mint condition among his effects, and he is very proud of them, willing to lecture for hours on the various details.

Leoster has seven children, all daughters. Six of them are married into other families in the guild. The seventh is the youngest, Llewellyn, and the most headstrong. Leoster has hopes that she will eventually wed a captain of the ship, but sees that hope dimming as the years pass.

Leoster has heard of the Fool, and intends to get around someday to taking care of that creature, if such a beast exists. As an aside, he'll note that one of his advisers (now passed on, gods rest his soul) had come up with the Fool as a way of proving the guild still had a reason for existing. Stuff and nonsense, but it keeps the commoners in line, in particular those nasty military brotherhoods.

• ROYA 91 •

Leoster, Kristobar, Miark

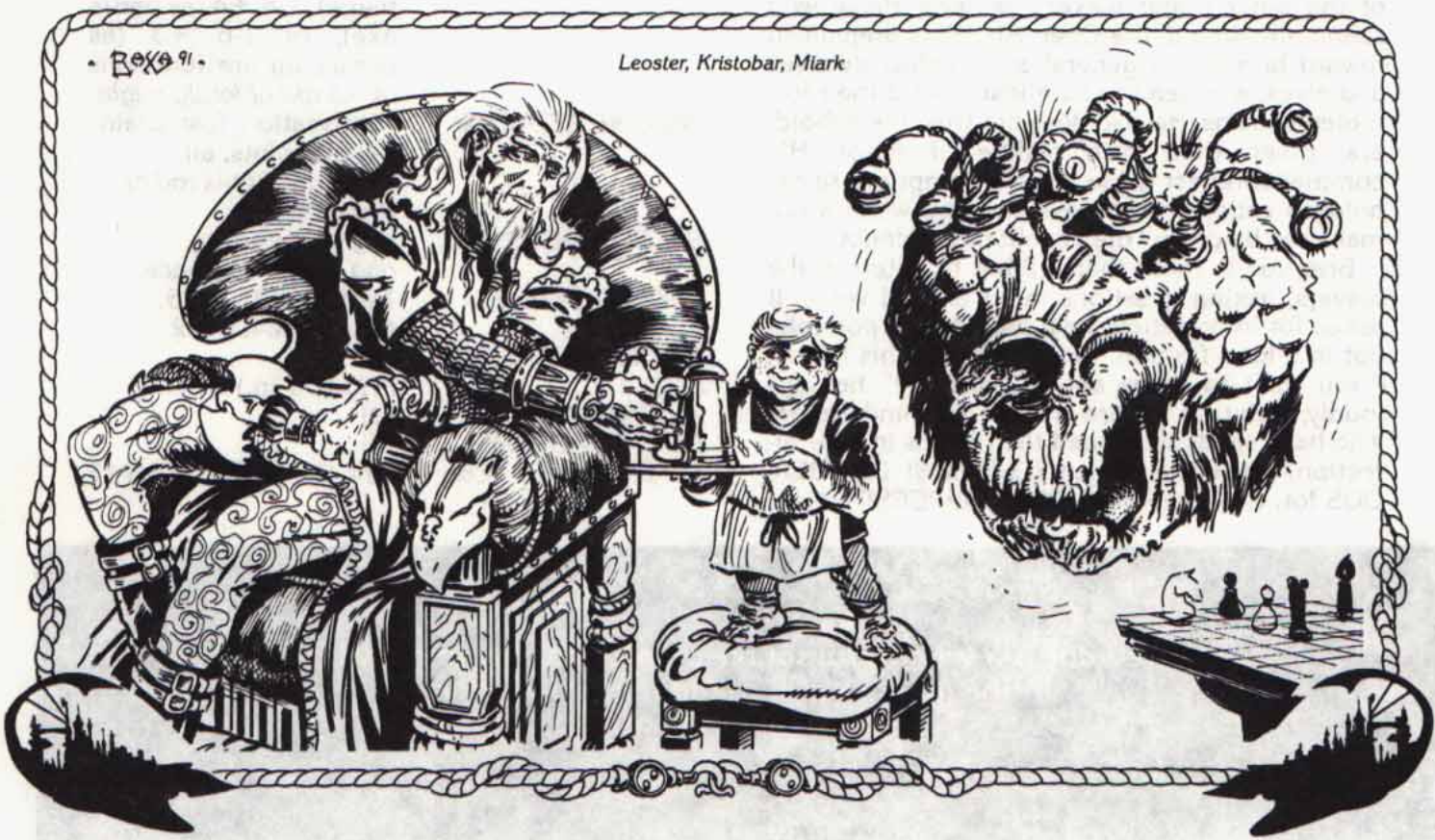

PERSONALITIES OF THE SPELLJAMMER

Leoster has a healthy respect for nobility, even groundling nobility, and will on occasion throw a cotillion or other bash to celebrate a new arrival. Of course, every new arrival should not expect a welcome in his Leoster's court, unless he has something really important to share.

Miark the Blind

12th Level Beholder Wizard

HEADQUARTERS:	The dark tower (area #38)
ARMOR CLASS:	0/2/6
MOVE:	fl 3 (B)
HIT POINTS:	65
NO. OF ATTACKS:	1
DAMAGE/ATTACK:	2-8
SPECIAL ATTACKS:	Magic eyes
SPECIAL DEFENSES:	None
WIZARD SPELLS:	1st:4, 2nd:4, 3rd:4, 4th:4, 5th:4, 6th:1
MAGIC RESISTANCE:	Nil
SIZE:	S (4 ft. wide)
ALIGNMENT:	LE
PSIONIC ABILITY:	Nil

Miark the Blind is one of those few beholders who have sacrificed a central eye for the ability to cast spells, and he is also the only eye tyrant to have ever captained the *Spelljammer*. Miark's ultimate helm was nothing more than a magical beholder mouth-pick, a simple tool used by some beholder nations to manipulate objects. His path led to the *Spelljammer*, where his control room was in the tail itself, surrounded by pulsing pods of negative energy.

Miark ruled well and wisely for years, punishing good, encouraging others of his nation to settle, and while not actively seeking battle, destroying all abominations (other beholders of different species) who crossed the ship's path. Miark's reign went well until a combined beholder fleet of 20

different nations launched an assault, and the air envelope rained spheres of death. Miark's people were slain, their slaves destroyed, and Miark fled into the warrens. This was before the coming of the Fool, and it was in the warrens that the shivaks found him, depriving him of his spell books and dragging him back to the tower.

He has been here two years. Or has it been 200? The time passes strangely for the old beholder, who has forgotten much, and sometimes still believes he is at the helm, sending commands to his ship to swoop, to bank, to attack. He plays chess with Theorx and listens to Jokarin rant. Miark is dimly aware that his other minor eyes still function, and that he has used them in the past to destroy captains who had finally cracked and attacked him. And he remembers that someone wanted him to kill them.

Miark occasionally thinks of escaping, but regaining his old ship is not on his list. First he would find a spellcaster and relearn his old spells. Then he would destroy every other beholder on the ship. He had lost his nation when the other nations attacked, and has no illusion about their survival.

Unlike Astor and Gray Eye, Miark has fur on either side of his central mouth, creating the impression that he has sideburns.

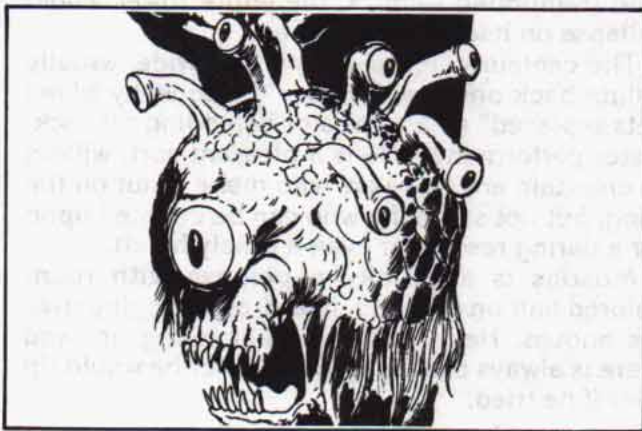

Miark the Blind was the only eye tyrant ever to captain the *Spelljammer*. He ruled well and wisely for years, until a combined beholder fleet of 20 different nations launched an assault.

PERSONALITIES OF THE SPELLJAMMER

Mostias

Mostias the Centaur

HEADQUARTERS:	The centaur tower (area #41)
ARMOR CLASS:	5 (4)
MOVE:	18
HIT POINTS:	24
NO. OF ATTACKS:	3
DAMAGE/ATTACK:	1-6/1-6/1-8 (spear)
SPECIAL ATTACKS:	Nil
SPECIAL DEFENSES:	Nil
MAGIC RESISTANCE:	Nil
SIZE:	L (9 ft.)
ALIGNMENT:	CG
PSIONIC ABILITY:	Nil

Mostias is an incredibly fat centaur who has discovered the easy life on the *Spelljammer* and has no intention of either giving it up or fighting for it. The remote location of their tower does not bring them into conflict often with other races, and it has been years since a concentrated attack has forced them to limber up the catapults.

Mostias is lazy, and most of his clan follow his example, lazing away the day on grain and mushroom wine. Were it not for a family of energetic (and traditional) wemics, the entire tower would collapse on itself from disrepair.

The centaur chief takes it all in stride, usually falling back on homilies like "the squeaky wheel gets replaced" as a means of defending his lackluster performance. He is a pleasant sort, willing to entertain any travelers who make it out on the wing, but not someone who can be counted upon for a daring rescue (or even a timely hand).

Mostias is a chunky appaloosa with roan-colored hair on his head, beard, and hanging over his hooves. He is rarely seen standing up, and there is always debate about whether he would tip over if he tried.

Nagasimi

Nagasimi of the Shou
12th level Wizard/Wu Jen

HEADQUARTERS:	The Shou tower (area #30)
ARMOR CLASS:	10
MOVE:	12
HIT POINTS:	36
NO. OF ATTACKS:	1
DAMAGE/ATTACK:	1-4 (<i>dagger of venom</i>)
SPECIAL ATTACKS:	Nil
SPECIAL DEFENSES:	<i>Ring of fire resistance</i>
WIZARD SPELLS:	1st:5, 2nd:5, 3rd:5, 4th:4, 5th:2, 6th:2
MAGIC RESISTANCE:	Nil
SIZE:	M (6 ft. 3 in.)
ALIGNMENT:	NE
PSIONIC ABILITY:	Nil

Str 9 Dex 13 Con 10 Int 18 Wis 12 Cha 9

Note that the stats above are from the AD&D 2nd Edition game. If the DM has a copy of *Oriental Adventures*, Nagasimi should be treated as a wu jen and his spells should come from the OA book.

Nagasimi is the trusted adviser of Si Loo (*q.v.*) of the Shou, and his lordship's connection between the real world of the Shou tower and outlander madness that consumes the rest of the *Spelljammer*. Nagasimi is aware that his master does not control the *Spelljammer*, though he comforts his lord by publicly supporting the fiction while working toward the day when Si Loo is the captain, by virtue of being the only surviving lord on the ship, and the Shou the only surviving people.

Nagasimi is pencil thin, with long, straight black hair reaching halfway down his back. He has no facial hair, but has a butterfly tattooed on his bald forehead. Nagasimi has taken a vow never to eat meat and is offended by those who partake of

Mostias is lazy, and most of his clan follow his example, lazing away the day on grain and mushroom wine. He is a pleasant sort, but not someone who can be counted on.

Ollister, Nagasimi, Mostias



meat in his presence.

Nagasimi hates all the gaijin that swarm through the ship, humans and nonhumans alike, and his polite disdain is only barely held in check by his manners. He would be quite happy if they would all kill each other. When he is away from the Shou tower, he never misses an opportunity to encourage one faction or another to fight, hoping that they will bring the entire house of cards down on top of themselves, leaving the way clear for the true people, the Shou, hiding in their citadel.

Nagasimi is a member of the Xenos (area #34), though he does not attend in person. Rather he sends a subordinate to represent the name of Si Loo. As a result, the other Xenos know nothing of Nagasimi, but only of Si Loo's envoy (and in fact many believe Si Loo himself to be the Hooded Sol-

dier and leader of the Xenos, a fiction which exists only because so many of them have never actually met Si Loo). Much in the way of Xeno resources can be traced back to the Shou, and in fact the demolition of the elven academy was accomplished from a store of smoke powder squirreled away by Si Loo's predecessor.

Nagasimi is loyal to his master in that he sees that as a wu jen, he is unsuitable for leadership (otherwise he would have been made leader). He attempts to sniff out any plot against his master and deal with the offender as quickly as possible. One or two likely human assassins found themselves invited to the tower, and then never left it again.

Nagasimi would like the captaincy of the *Spelljammer* for his master, but is unaware of how

Nagasimi hates all the gaijin that swarm through the ship, humans and nonhumans alike, and his polite disdain is only barely held in check by his manners.

PERSONALITIES OF THE SPELLJAMMER

to go about obtaining it. He believes the gaijin legends are mostly lies, not to be trusted. He would like to contact the one known as the Fool, for he seems to be the true master of the *Spelljammer*.

Ollister

Ollister of the Blood of Leoster IV,
Regent of Humanity
7th Level Fighter

HEADQUARTERS: The guild tower (area #13), or the Academy of Human Knowledge (area #34)

ARMOR CLASS: 2 (chain +3, shield)
MOVE: 12
HIT POINTS: 46
NO. OF ATTACKS: 1
DAMAGE/ATTACK: 1-8 (long sword)
SPECIAL ATTACKS: Nil
SPECIAL DEFENSES: Nil
MAGIC RESISTANCE: Nil
SIZE: M (5 ft. 11 in.)
ALIGNMENT: N (arguably neutral-stupid)
PSIONIC ABILITY: Nil
Str 13 Dex 13 Con 13 Int 7 Wis 7 Cha 15

Ollister is living proof of the problems you can get into by not getting around much. The descendant of Leoster himself, Ollister set out to find out more about his world than he could learn just in the human collective, to experience and enjoy.

Of course, immediately he fell in with one of the worst terrorist groups on the entire ship, the Xenos, and has been used by them as a pawn and dupe ever since.

Ollister thinks of the academy as simply having a "secret club" which he is privy to, since he does represent the elite of the *Spelljammer's* society. He occasionally attends meetings, often enough to make himself and the guild look responsible if the

Xenos are ever revealed. He has been sworn to secrecy (and lives by his word) and just for good measure, the Xenos placed a geas on him as well, to cause pain and death if he tries to reveal anything about the organization.

Ollister is a happy-go-lucky, friendly individual, a break from the more refined (read "stuck-up") members of the guild. He can sometimes be found at the Open Air, listening to stories. He'd like to visit the warrens some day, since he believes there is a dragon's horde down there (of course, there is a dragon's horde underneath the dragon Suza, but that doesn't count).

If asked (or even if the subject comes up in his presence), Ollister will volunteer that the Fool is a myth, created by his grandsire's adviser or something, to keep the little people in line.

The DM should have fun with Ollister—he is capable in combat if not competent in society. And he really, really tries hard.

Orik

Orik the Umber Hulk

HEADQUARTERS: The hulk tower (area #28), the neogi tower (area #27), or in the company of his lord, Master Coh

ARMOR CLASS: 2
MOVE: 6 (does not burrow)
HIT POINTS: 72
NO. OF ATTACKS: 3
DAMAGE/ATTACK: 3-12/3-12/1-10
SPECIAL ATTACKS: Confusion
SPECIAL DEFENSES: Nil
MAGIC RESISTANCE: Nil
SIZE: L (8 ft.)
ALIGNMENT: CE
PSIONIC ABILITY: Nil

Ollister is living proof of the problems you can get into by not getting around much. The Xenos have used him as a pawn and dupe for years.

PERSONALITIES OF THE SPELLJAMMER

Orik is the personal slave of Master Coh of the neogi, and will almost always be found in his company when not in his personal quarters. Orik is intensely loyal to Coh, who treats him well, has other slaves polish his hide, and allows the umber hulk first choice of the slaves to kill and eat. If a creature as evil as an umber hulk has loyalty, Orik has loyalty to Coh, and will defend him to the death.

Coh is a typical umber hulk, marked on the forehead with the interlocked rings which are the symbol of his wise master. He and the rest of his race can burrow into the chitinous hide of the *Spelljammer*, but are forbidden to do so by the neogi, and so do not. Orik bullies and pushes around the other umber hulks and nonhulk slaves, but does not kill them, at least not without Master Coh's permission.

Orik speaks his own language but has also made attempts to learn the common speech. His diction is slow and slurred, and he often forgets to

use tenses correctly, but he can get his ideas across. Most of his ideas are Coh's, of course, at least the ones he voices in council. Orik's presence there offends the other members of the council and he is often called "Coh's parrot" (though not to his face).

Orik is frankly amazed that everyone would not choose to be owned by someone else. It makes life much simpler if an owner is calling the shots, in particular if the owner is as wise as Master Coh. Therefore everyone should be owned, primarily by Master Coh. Attempts to put this belief into action have resulted in battle, and Master Coh (concerned master that he is) has ordered Orik to cease "recruiting" people at random to be slaves.

Master Coh is the greatest owner in the universe, according to Orik. His greatest enemy is the Fool, who is another owner, who has taken the ground away from the hulks and captured many of the other slave-hulks. The Fool is a bad owner, and Coh wishes to destroy him before he owns



PERSONALITIES OF THE SPELLJAMMER

anyone else. This Coh has told Orik, and while Orik is not privy to Coh's discussions with the Fool, Orik believes him. Why would Coh lie to a slave?

Selura

Selura Killcrow
18th Level Fighter

HEADQUARTERS: The Long Fangs citadel (area #33)

ARMOR CLASS: AC 1 (elven chain mail, Dex bonus)

MOVE: 12

HIT POINTS: 104

NO. OF ATTACKS: 2

DAMAGE/ATTACK: 1-8 +1, (long sword +1 / +4 vs. reptiles)

SPECIAL ATTACKS: necklace of missiles (1x11 HD, 2x9 HD, 2x7 HD, 2x5 HD, 2x3 HD fireballs)

SPECIAL DEFENSES: ring of regeneration, boots of elvenkind

MAGIC RESISTANCE: Nil

SIZE: M (5 ft. 11 in.)

ALIGNMENT: CE

PSIONIC ABILITY: Nil

Str 13 Dex 18 Con 17 Int 12 Wis 14 Cha 18

Selura was born and bred on the *Spelljammer*, spawned in the sprawl and clutter of the human collective, orphaned and enslaved by first the ogres and later the minotaurs. Selura learned to fight for her life and found she was very good at it. First with a pack of other young thieves, then as a mercenary leader, she has the advantage of most of the other military leaders in that she is a native, and knows many secret routes and passages from place to place, in particular the entrances of the warrens. She has no fear of using the warrens as an escape route, or as a way of getting from place

to place. She is more than willing to sacrifice a few of her number to the Fool in exchange for safe passage, and the Fool feels that her missions of death are more than sufficient to justify letting her live.

Selura is tall, lean, with dark red hair the color of curdled blood. She lost an eye in battle with a minotaur, and wears an eyepatch over it marked with the symbol of the Long Fangs in silver. Having lost partial vision, she is continually checking on those around her, making sure of their placement.

Selura will kill anyone, anytime, for the right price. She feels no loyalty to humanity, which abandoned her, nor to any other race or people. All of her comrades, including friends and allies, are expendable, provided that she gets what she wants.

Selura is enchanted, however, with things elven. She rescued the boots from a minotaur's treasure pile and pulled the chain from an outlander paladin. Her one recent romantic liaison was directed toward the elven commander Stardawn, who used her as a contact to deal with Arcane, then spurned her further advances. Angry at being rejected, she has added Stardawn and the elves to her list of enemies.

Selura has great plans of revenge. Her dream is to conduct a "night of long knives," when the leaders of all the various factions will be killed at once. In the resulting bloodbath, Selura will profit greatly, as well as enjoy the carnage. She is still planning this and significant problems remain to be overcome, but she has recruited Korvok of the Tenth Pit and several of Taja's younger hill giants as assistants. Korvok is very enamored of the young fighter, but Selura plans to have him killed, too. And if he makes any advances on her, killed soon.

Selura will kill anyone, anytime, for the right price. She feels no loyalty to humanity, which abandoned her, or to any other race or people. All of her comrades are expendable.

PERSONALITIES OF THE SPELLJAMMER

ShiCaga

ShiCaga the Enchantress
Ogre Mage Chieftess

HEADQUARTERS: The ogre wizard citadel (area #23)
ARMOR CLASS: 4
MOVE: 9, fl 15 (B)
HIT POINTS: 45
NO. OF ATTACKS: 1
DAMAGE/ATTACK: 1-12
SPECIAL ATTACKS: *fly, invisibility, darkness 10 ft., polymorph self, regenerate, charm person, sleep, gaseous form, cone of cold; attacks as a 9 HD monster*
SPECIAL DEFENSES: Saves as a 9 HD monster
MAGIC RESISTANCE: Nil
SIZE: Large (12 ft.)
ALIGNMENT: LE
PSIONIC ABILITY: Nil
Str 18 Dex 12 Con 18 Int 15 Wis 13 Cha 6

ShiCaga is one of three ogre mages on board the *Spelljammer*, the other two being her sons. She and her family are recent arrivals. They came soon after the most recent dark time, and after an unsuccessful attempt to usurp control of the Shou Lung tower, took over command of the ogres instead. ShiCaga's husband was slain in the fracas involving the Shou by the warrior CassaRoc the Mighty (q.v.), and while ShiCaga has forgiven the loss, she has not forgotten.

ShiCaga has been for most of her time on board the *Spelljammer* a patient spider, sitting at the center of her web, protecting the ogres from outside enslavement and dubious alliances, working for other races in order to hoard precious food.

This has changed in the past year, with the arrival of the Hobgoblin Prophet (q.v.), who has captured ShiCaga's attention and turned her mind to

expanding her realms by freeing the goblin races from the illithids and taking control of them herself. This has caused her to become vocal in criticism of the mind flayers, and supportive of the prophet in his attempts to rescue his fellow hobgoblins. This tilt toward the diminutive hobgoblin has sparked some speculation and created rifts within the ogre community, ShiCaga, the prophet, his followers, and some other ogres on one side, the bulk of the ogrish population and the two sons on the other.

ShiCaga's relationships with the other citadels (other than Trebek's) are cool and cordial. Ogre raids are not common enough to be dangerous, and the same ogres will gladly hire out to do someone else's dirty work. This includes CassaRoc and the Shou, although those relationships are chilly.

ShiCaga has a good relationship with Father Goat, though she suspects that he and the mind flayers are in cahoots, so she does not trust him with information. ShiCaga has been linked romantically with Breakox the minotaur giant, but this is a relationship of convenience as opposed to true feeling—ShiCaga will happily turn over Breakox to any other faction when the minotaurs are attacked. Finally, ShiCaga has no dealings with the Fool, who she believes was created by the forces of good to blame all evil activities on.

ShiCaga is a beautiful ogre, at least to other ogres. She prefers make-up in the oriental tradition, making her look like a *no* actor. Further, she enjoys long gowns of oriental fabric, and should such material come to the *Spelljammer*, there will be an ogre willing to buy it.

ShiCaga has two twin sons, AziKash and HiRotu. Both believe that their mother's age has finally caught up with her. This is how they account for her sudden interest in the hobgoblin and his faith. She may need to be replaced, but each feels that he is the best suited to replace ShiCaga. Both have their supporters among the ogres, but both must move carefully—should one brother move

ShiCaga has been a patient spider for most of her time on board the *Spelljammer*, sitting at the center of her web, protecting the ogres from outside enslavement and dubious alliances.

PERSONALITIES OF THE SPELLJAMMER

openly against his mother, the other brother will certainly turn on him, and neither is strong enough to overcome both brother and mother simultaneously. As a result, neither sibling wishes to make the first move. Unlike ShiCaga, AziKash and HiRotu have many old scores to settle, including against CassaRoc and the Shou. Rumors float occasionally (and are hotly denied when they do) that Trebek is in contact with one or both brothers. Such rumors usually are followed by an ogre raid against the mind flayers, led by the brother who was slandered.

Si Loo

Magistrate Under the Heavens
8th level Bushi (Fighter)

HEADQUARTERS:	The Shou tower (area #30)
ARMOR CLASS:	3
MOVE:	12
HIT POINTS:	66
NO. OF ATTACKS:	2/1
DAMAGE/ATTACK:	1-10 (+2) (katana +2)
SPECIAL ATTACKS:	Nil
SPECIAL DEFENSES:	Nil
MAGIC RESISTANCE:	Nil
SIZE:	M (5 ft.)
ALIGNMENT:	NE
PSIONIC ABILITY:	Nil
Str 17 Dex 14 Con 12 Int 12 Wis 9 Cha 17	

Note that the stats above are from the AD&D® 2nd Edition game. If the DM has a copy of *Oriental Adventures*, Si Loo should be treated as a bushi and given all the powers and qualities of that class.

Si Loo is the most recent in a long line of magistrates to rule the reclusive Shou aboard the *Spelljammer*, having arrived a scant five years ago. Si Loo and his wu jen found the present magistrate in deadly danger of dealing with non-Shou

outlanders, to the point of opening his tower to them. Acting quickly, Si Loo disposed of the erring magistrate and set himself up as ruler. The people were unaware of the revolution until it was over, and they returned to their regular life. All records of the previous administration were destroyed and composted into the rice fields.

Si Loo is a thin Shou with a drooping moustache. He is a dreamer, and fancies himself the true master of the *Spelljammer*, which reacts to his every whim. The fact that he often quickly forgets what his whims were helps to maintain this fantasy. Si Loo does not believe captains exist, nor does he believe in the Fool; both are creations of the outlanders and nonhumans, who need these fictions to prevent them from going mad with the realization that one as radiant as Si Loo, master of the *Spelljammer*, is among them. Being a kind and generous master, Si Loo allows the deception to continue.

It has been four years since Si Loo last saw an outlander, and two years since he has seen another Shou who was not a member of his court. He spends his time composing poetry, orders to the outlanders in the other citadels, and reports to the Emperor of the Shou, to be sent out with the next ship leaving the *Spelljammer*. These reports are dutifully filed by his adviser Nagasimi, composted, and returned to the rice bed.

Should some character be granted an audience with the mighty Si Loo, he should be prepared to step into a world where even the strangeness of the *Spelljammer* looks calm and serene. Any supposed enemies are ordered slain, friends rewarded from ship's stores, and information freely given. However, Si Loo has no power outside his own gates, and most information bandied about in his court is laced with allegory and quite useless ("Space is little more than a serpent swallowing not only its own tail, but also the tail of its neighbor"). Within the tower, however, Si Loo's power is absolute, enforced by Nagasimi and his own loyal retainers, and a single false step or mis-

It has been four years since Si Loo last saw an outlander,
and two years since he has seen another Shou who was not a
member of his court. Within his tower, however,
Si Loo's power is absolute.

PERSONALITIES OF THE SPELLJAMMER

taken word can bring instant calamity.

Reports that Si Loo is the Hooded Soldier are entirely false.

Stardawn

Commander Lothian Stardawn, Elven Fleet
6th Level Elf Fighter

HEADQUARTERS: The elven high command (area #36)
ARMOR CLASS: 5 (elf chain)
MOVE: 12
HIT POINTS: 49
NO. OF ATTACKS: 1
DAMAGE/ATTACK: 1-8 (long sword + 1)
SPECIAL ATTACKS: Nil
SPECIAL DEFENSES: 90% immune to *charm* and *sleep* spells
MAGIC RESISTANCE: See above
SIZE: M (5 ft. 6 in.)
ALIGNMENT: NG
PSIONIC ABILITY: Nil
Str 14 Dex 16 Con 12 Int 14 Wis 9 Cha 17

Stardawn is one of the rising stars of the elven fleet, since even before his arrival on the *Spelljammer*. The scion of a powerful admiralty family, Stardawn was known for his forceful, take-charge manner as well as his bravery under fire in a series of campaigns against stellar corsairs. He was given a plum assignment by the high admirals: discover the secret of the *Spelljammer*, (why does no one return from it?) and if possible, bring it back for use by the elven fleet.

Locating the *Spelljammer* proved easy—its course had been marked through admiralty space for months—but upon arrival, Stardawn found himself on his own. The *crystal ball* he had been provided with for communication malfunctioned and was soon stolen, presumably by forces of darkness (actually by shivaks who picked it up and threw it in the trash).

Stardawn joined the staff of Admiral Highstar aboard the great ship and quickly earned a reputation for his bravery on the *Spelljammer* as well, in particular in punishing goblin incursions, once or twice taking the battle to the gates of the horned tower itself. He has earned the respect of his comrades and the hatred of Trebek, lord of the mind flayers, who has branded Stardawn "the most violent and petty of his violent, petty race."

Throughout all this, Stardawn continues researching the *Spelljammer*. He was dismayed that Highstar does not care about the ship's secrets and that the other non-elves all told varying (and conflicting) reports as to the great ship's nature (the most useless source was the so-called Academy of Human Knowledge, an oxymoron if ever there was one).

Working through a striking but unpleasant young human named Selura, Stardawn made contact with Arcane. Arcane posed a deal—he would trade information for the master seed kept in the elves' vaults, from which the elves could grow new ships.

Stardawn considered his options, decided that the ends justified the means, and pirated the master seed from the elves, replacing it with a ceramic duplicate. From Arcane, the elf commander learned that all captains possess a single item, a symbol of command (the ultimate helm, in one of its many forms). This item provides passage to the heart of the ship, where the captain takes full command of a crew locked in a frozen sleep. The crew thaws and responds to the captain's every need, bringing the ship to life. The gardens are closed then, to starve out evil; presumably good folk have stockpiled enough food to keep themselves alive during the dark times. (The last three points were intentional lies on the part of Arcane. Stardawn has never met a lying arcane, and believes what he was told.)

Stardawn broke off his contact with Selura upon getting the information, covered his tracks in contacting Arcane, and now waits for the arriv-

Believing that the ends justified the means, Stardawn pirated the master seed from the elves' vault, from which the elves could grow new ships, and traded it to Arcane for information.

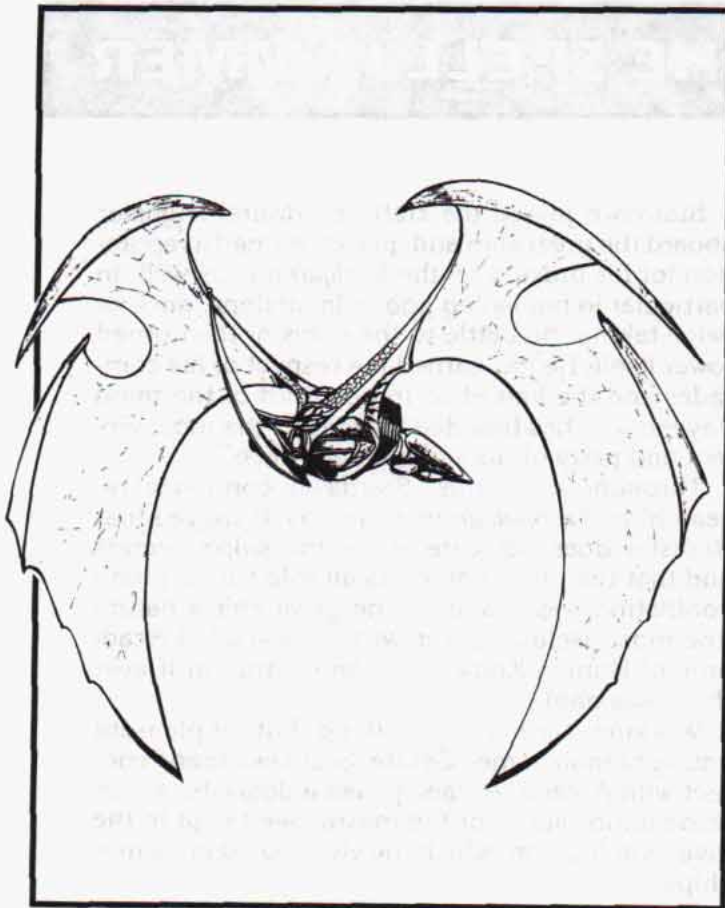

Suza the Brass

Suzarindarcallioup
Mature Female Brass Dragon (15 HD)

HEADQUARTERS: The dracon tower (area #41)
ARMOR CLASS: -3
MOVE: 12, fl 30 (C)
HIT POINTS: 90
NO. OF ATTACKS: 3
DAMAGE/ATTACK: 1-6/1-6/4-16 (all +7)
SPECIAL ATTACKS: Breath weapon 14d4+7 or sleep gas; *suggestion, control temperature, dust devil, create water*

SPECIAL DEFENSES: Nil
WIZARD SPELLS: 1st:2, 2nd:2
MAGIC RESISTANCE: 25%
SIZE: G (30 ft.)
ALIGNMENT: CG
PSIONIC ABILITY: Nil

Suzarindarcallioup was captured by neogi who crash-landed on her home planet, a world without human or humanoid life, where elves, dwarves, and men were only fairy tales to frighten small drakes. She was fitted with a leech to be used as an emergency vehicle, and taken into space. The transport ship passed alongside the *Spelljammer*, and Suza was used as a landing craft. The effect of the atmosphere caused all to stay on board. The leech was dismantled, Suza was freed, and the neogi who captured her was killed by his fellow neogi (using Suza to strafe the neogi citadel with heat breath probably contributed to the native neogi's decision).

Suza found herself in an incredible world where creatures of myth and legend honestly existed—the brave little men, the driven elves, and the roly-poly dwarves. Best of all, there were races she had never heard of, including the dragons, who considered her the voice of a god. Having never been the voice of a god before, Suza was honored, and moved in with the dragons.

Suza really liked the dragons, and told them what they wanted to hear. Unfortunately, what they wanted to hear was that they were the favored children of the gods and that all other races

al of a new captain. Stardawn intends to intercept the newcomer, take his badge of office, and assume command himself. He will then return in triumph to the admiralty with the greatest ship in known space beneath him.

Stardawn also figures that others know what he knows, and keeps close tabs on them. He believes Arcane is trustworthy, but the lizard king's grandson, Demets, seems a little shady, and Trebek, the beholders, and the neogi are all smart enough to figure things out. Further, this Fool creature may be a red herring, a piece of goblin agitation, or something else entirely. He is currently the biggest mystery and most puzzling gap in Stardawn's personal understanding of the ship. Stardawn will move when the time is right, perhaps even aiding the new captain against the others before taking the ship for himself.

Stardawn awaits the arrival of a new captain because he intends to intercept the newcomer, take his badge of office, assume command himself, and return in triumph to the elven admiralty.



Stardawn, Si Loo, Suza

should honor them. Suza inadvertently fanned racial attitudes that nearly sent the dragons on a holy crusade against the beholders, creatures who looked like soft sea urchins. A quick confab with the kaba (leader) of the tribe, and the shalla (priest and spellcaster) convinced Suza to tell the fired-up dragons that she had got it slightly wrong—that the gods thought highly of the dragons because the dragons didn't care whether they were honored or not. The crusade was called off and Suza settled in for an easy life on board.

Suza has been adopted into the dragon tribe, and while she misses the open fields and dells of

home, she loves her new family and marvels at all the things that happen in the nearby city (where the city-dells are). She will defend her people and her home, and has in the past proved to be a nasty surprise to attackers who never expected to confront a brass dragon in space.

Suza knows the limits of the air bubble surrounding the sphere, and tries to avoid leaving it (as she might die and would be leaving her friends behind). She loves to gossip about all the city members, whether what she hears is true or not, and always takes visitors, particularly mythological and imaginary characters like men.

Suza liked the dragons and told them what they wanted to hear. Unfortunately, what they wanted to hear was that they were the favored children of the gods and that all other races should honor them.

PERSONALITIES OF THE SPELLJAMMER

Taja

Taja Deeplunder
Frost Giantess

HEADQUARTERS: The giant's citadel
(area #29)
ARMOR CLASS: 0 (5)
MOVE: 12
HIT POINTS: 99
NO. OF ATTACKS: 1
DAMAGE/ATTACK: 1-8 +9 (bare hands) or
2-15 +9 (giant axe)
SPECIAL ATTACKS: Hurl boulders
(2-20 damage)
SPECIAL DEFENSES: Impervious to cold
MAGIC RESISTANCE: N
SIZE: H (21 ft.)
ALIGNMENT: N
PSIONIC ABILITY: Nil
Str 21 Dex 11 Con 8 Int 10 Wis 15 Cha 13

Taja arrived at the *Spelljammer* a decade ago, at a time when both neogi and dwarves were seeking to wipe out the giant colony and enslave its members. Quickly rallying the giants and alerting the attackers' traditional enemies (which was everybody in the case of the neogi, and the elves in the case of the dwarves), Taja managed to save the community from being overrun. She established herself as the leader of the giant family.

In the years since then, Taja has done well as a leader, turning the hill giants into a potent labor and mercenary force, willing to work for hire for most races (except the dwarves). She has attracted three stone giants as assistants and has on several occasions managed to negotiate with the dwarves to release family members who have been enslaved (usually after losing a brawl with a dwarf or 10). She has been unable to convince the dwarves to release those slaves who are not official "family," but the dwarves will concede that Taja has a moderating influence over the other giants, and

keeps them (generally) out of trouble.

Taja is interested in the history of the *Spelljammer* and its races, and has endeavored to collect information about the various races and their adventures on the *Spelljammer*. She can identify the arrival dates of most of the present leaders, as well as the outer cycle of the dark times (the arrival of the captain, the closing of the gardens, the dark times, and the flight of the smalljammers). She knows when the Fool first appeared, but not that he was formerly a captain, nor does she know that he is undead (though she can add up the long years he has been active). She is particularly interested in songs and has a good voice. She will often sing for payment, particularly to human and halfling audiences, and once sang before Leoster IV himself.

Despite her positive moves to improve her race's image, Taja has many enemies on the ship, in part because of her high profile. The dwarves respect her, but worry that her popularity will turn other races against them, considering their long-standing enmity toward the giants. More importantly, Breakox the giant minotaur has drawn away many of the hill giant family who believe that his way of thinking is more "giantish" than Taja's neutral alignment allows. Lastly, the neogi, beholders, and illithids would all like to add the remaining giants to their own slave collections (Coh and the neogi in particular), especially if Taja was overthrown and her people committed a few acts of violence so they could be legitimately enslaved.

Taja is 21 feet tall, with light blue hair and pale, ivory skin. She uses a harp of correct size for her frame, and is learning to write (aided by an assistant of Hancherback's) so that she may record the tales she has collected.

Ten years ago, Taja rallied the giants and saved the community from being overrun. Despite her positive moves to improve her race's image, Taja has many enemies on the ship.

PERSONALITIES OF THE SPELLJAMMER

Theorx

Theorx the Aged
13th Level Priest of Odin

HEADQUARTERS:	The dark tower (area #38)
ARMOR CLASS:	10
MOVE:	12
HIT POINTS:	97
NO. OF ATTACKS:	1
DAMAGE/ATTACK:	1-3 or by weapon (any type of weapon)
SPECIAL ATTACKS:	Attacks as 13th level fighter
SPECIAL DEFENSES:	Nil
PRIEST SPELLS:	1st:8, 2nd:7, 3rd:6, 4th:4, 5th:2, 6th:2
PRIEST SPHERES:	all, animal (minor), com- bat, divination, elemen- tal (minor), protection, summoning
MAGIC RESISTANCE:	Nil
SIZE:	M (5 ft. 6 in.)
ALIGNMENT:	LG
PSIONIC ABILITY:	Nil
Str 14 Dex 7 Con 13 Int 12 Wis 15 Cha 15	

Theorx was originally the ship's priest on a world which venerated the entire Nordic pantheon. His ship defeated a sea serpent, and in its belly he found a great rune, which stuck to his skin. Soon afterward he and his crew were drawn into the sky by a strange force which turned out to be a neogi deathspider. So did his journey begin that ended in the discovery of the *Spelljammer* and his attaining captaincy.

Theorx served long and well as captain, helping the land recover from the depredations of warring beholder nations on board. After a decade, he told the *Spelljammer* to take him home. Then he told it to let him leave the ship. Then the ship imprisoned him in the dark tower.

At first Theorx railed and howled at the injustice. Then he plotted, and planned, and researched. Then he attempted to escape. And he failed. And he failed again. And he failed continually.

Finally, Theorx accepted his fate as the will of Odin himself, and decided that he was in a sort of valhalla—he could rest if he wanted, fight if he wanted, and all his needs were taken care of. Of the three captives, Theorx is the best adapted. He has even begun writing a book on his experiences (though he has to keep it hidden from the shivaks).

Theorx is a broad-shouldered, good-natured old man dressed in Norse garb, even though the rooms are warm enough to do without furs. As new captains arrive, he will learn what has happened in the outside world from them, and try to ease their transition into involuntary retirement.

Occasionally, the *Spelljammer* drifts into spheres where Odin's name is still used in worshipful tones. Theorx has long since ceased to call on his god for aid, and now takes to the simple life. If freed, he would still like to go home, though life has been very good for him aboard the *Spelljammer*.

Finally, Theorx accepted his fate as the will of Odin himself and decided that he was in a sort of valhalla—he could rest if he wanted, fight if he wanted, and all his needs were taken care of.

PERSONALITIES OF THE SPELLJAMMER

Trebek

Lord Trebek
Mind Flayer

HEADQUARTERS: The horned tower
(area #16)
ARMOR CLASS: 5
MOVE: 12
HIT POINTS: 68
NO. OF ATTACKS: 4
DAMAGE/ATTACK: Special
SPECIAL ATTACKS: Mind blast
SPECIAL DEFENSES: Nil
MAGIC RESISTANCE: 90%
SIZE: M (6 ft. 6 in.)
ALIGNMENT: LE
PSIONIC ABILITY: Nil
Str 9 Dex 13 Con 15 Int 18 Wis 17 Cha 15

Trebek is a newcomer to the ship, arriving within the past two years and quickly rising (through guile and compromise) to the leadership of the horned tower. Not a member of any particular clan of illithids on the *Spelljammer*, he has used his nonpartisanship to represent himself as a neutral third party in internal disputes. As long as he appears to not play favorites, he is popular among his people, and from that power base, he is expanding into new areas.

Trebek is taller than the average mind flayer, with a more pronounced forehead. He dresses as others do of his race, in black robes with a star-embazoned cape. Trebek always uses a splash of color, usually red or yellow, as well—a pin or amulet, or a sash—to set himself apart from the common illithid and make himself more recognizable as a leader to other races.

Trebek is smooth, polite, and intelligent, choosing to make his point with words, not actions, and fighting only if no other course is available. To the other citadels, he portrays the illithids as a victimized minority, slandered by the elves and other op-

pressive forces when they are only trying to survive in peace and harmony. He presents the idea that the mind flayers are the protectors of other hunted races such as the goblins, and as an ally to the poor of Father Goat's church. His efforts have been quite successful, particularly among the poor and the disenfranchised on board the great ship, and Trebek is a popular spokesman for them.

Among his own clan leaders, Trebek speaks of the enslavement of the goblin races and the eventual conquest of the remaining races on the ship. Ultimately he is an illithid and he believes all other races are cattle to be harvested for their brains or husbanded as slaves. He needs to show steady advancement of that cause in order to retain his position among the mind flayers, so Trebek is continually wheedling and planning. His current project is to bring Breakox and his minotaurs under mind flayer control.

Trebek's ideal situation would involve a minimum of danger to himself and his people. He would love to see the neogi and beholders batter themselves senseless against each other. To that end he has offered to help chair peace negotiations (which to date have proven unsuccessful . . . how unfortunate).

He would deeply enjoy seeing the elves split from their normal allies in the human towers. He has staged an atrocity or two involving goblins so that the elves can overreact and appear as the aggressors.

And he looks forward to the arrival of a captain, particularly an evil captain, as the resulting confusion and dark time would set the stage for a mind flayer rampage which would roll over the other citadels and reduce them all to slave-states.

Trebek has no desire to be captain—there are too many unknowns involved for his taste (most important is what happens to old captains). He would like to control the new captain, however, whether by alliance or by sorcery, and use him as a tool.

Trebek would love to see the neogi and beholders batter themselves senseless against each other. He would deeply enjoy seeing the elves split from their normal allies, the humans.

PERSONALITIES OF THE SPELLJAMMER

Trekak does not believe in the Fool, nor in lost captains. He has little regard for the mad Arcane and his gnomes, or for the squabbling human factions, and discounts the influence of the lizard men of the gardens. He believes that the battle for the *Spelljammer* is between evil (represented by himself) and good (represented by the elves). Further, he believes it is a battle for the hearts and minds (literally) of the other natives, as opposed to a fight for the inanimate ship. In this fight Trekak uses the council as a podium to lash out at the elves and speak sugar-coated words to the other races.

Throughout all of this, he also must remain on guard for treachery within his own ranks, as there are other mind flayers who covet his position.

Even the most loyal illithid lieutenant understands that every officer above him is an impediment to his own advancement and every officer below him is a potential assassin.

Trekak should be played as a friendly, interested party, willing to help others as long as their plans do not interfere with his own. If helping is against his interest, he will make the offer anyway, then work to guarantee failure. He will seek to slander (politely) and blacken the names of those who oppose him and draw those who ally with him tightly under his control. He is not above theft and blackmail, but tries to make sure that the evil deeds cannot be traced back to him. Ultimately, he has no one's interest but his own in mind.

Theorx, Taja, Trekak

• BOKS 91 •



CAMPAIGNING WITH THE SPELLJAMMER

The *Spelljammer* can be used either as the goal of an epic adventure or as part of a larger campaign. Included below are two separate adventures using the *Spelljammer*. The first is for lower level characters and involves hunting down the *Spelljammer* and recovering an artifact that has been captured by shivaks. The second is a presentation of how to handle the *Spelljammer* as a "campaign"—the ultimate goal of which is to gain possession of the *Spelljammer*, and what happens next.

The Owl of the Mystics

Summary: Your group of adventurers is approached by a dying man, one who has in his possession a set of magical devices that negate the effects of the *Spelljammer*. You are contacted by two parties immediately thereafter, each seeking a particular device that is on the *Spelljammer*. Rendezvous with the *Spelljammer* occurs, and the adventurers must first find the device, then get off the *Spelljammer* to collect their rewards.

This adventure is designed for mid-level characters and those still getting the hang of space travel (4-8 characters, levels 6-9). It is fairly straightforward, but the DM is welcome to elaborate as he goes along, particularly once the party reaches the *Spelljammer*.

I. The Halfling's Package

The players are hanging out in their favorite nightspot, whether that be on the Rock of Bral or in some groundling joint like The Yawning Portal of Waterdeep. Read the following to the players.

It is a quiet night, one of the few you've seen recently. The room is spacious, but most of the chairs and benches are empty. The regulars seem to have other business tonight, and the barkeep is more interested in taking inventory

than serving drinks. It is a boring evening all around.

The peace is broken by the front door swinging inward with a crash. A small figure sways in the doorway, stumbles a few feet into the room, then crashes backward to the floor with a heavy thump.

You rise as a group and surround the newcomer. He is a halfling of an unfamiliar sort, with a full, wide beard, and his long hair in disarray. He's dressed in an orange duster and had (until he fell) a wide-brimmed black hat. He's clutching a ball of paper in his hands.

As you kneel down, the hairy halfling smiles and with his last breath croaks a single word:

"*Spelljammer!*"

And then he dies.

His name is Jakobin Zeborox, and he was hired to procure the items he died with. He incurred a magical geas in the process and fought it to his last dying breath. If a *raise dead* spell is attempted, he will fail his system shock roll. If a *speak with dead* spell is used, he will reveal his name and the fact that he was supposed to meet Charity here, to give her the package.

The package, or ball of paper, contains about a dozen items that look like large golden horse-shoes. Actually, they are torcs which are worn around the neck. They radiate strong alteration magic, and when donned, allow the individual wearing them to survive without breathing, as long as they are worn (similar to the iridescent spindle *ioun stone*).

Checking the paper shows that it is a bundle of scrap used to hold the loose torcs together. Included among the scrap are pages of arcane symbols (magical recipes in a personal code), a torn (but usable) scroll containing three *lightning bolt* spells, some butcher's paper, and a map of the *Spelljammer* (use the one from the original box, and hand it to the players).

The peace is broken by the front door swinging inward with a crash. A small figure sways in the doorway, stumbles a few feet into the room, then crashes backward to the floor with a heavy thump.

CAMPAIGNING WITH THE SPELLJAMMER

About the time all of this sinks in, a sultry voice at the doorway says, "Oh, no, I'm too late!"

II. Charity

Framed in the doorway is a leggy blonde, an enchantress in all senses of the word. Her red satin robe is cut high at the hip and low at the chest, and cinched tightly around the waist by a wide golden belt embroidered with dragons. An ivory wand is tucked into that belt. Her hair is the color of winter wheat and cascades down on her bare shoulders. Her features would be perfect if they weren't now twisted into a mask of concern. She raises a delicate hand to her lips and says, "Is he . . . dead?"

The shapely young woman is Charity Phelonia, a 5th level wizard (AL CG; AC 10; MV 12; HD 5; hp 18; THAC0 19; #AT 1; Dmg 1-4 (Dagger); SA spell use, *wand of wireballs*; SD nil; SZ M; ML 10). While alarm bells should be ringing in the head of every suspicious player, Charity is on the level, honest, and no more (or less) than she appears.

Charity's story is that Zeborox is a member of a "lost tribe" of hairy halflings, the Furchin subrace. Charity helped the Furchins escape from a cruel master, Ominovin, and wants to send them home. However, she does not know where home is for them. The only way to discover the Furchin homeland is with a device called the Owl of the Mystics. All checks with divination spells say that the future of the Furchins is closely tied to the mythical *Spelljammer* ship.

"I knew enough of the *Spelljammer* to know that no one ever comes back," says Charity, a perfect tear streaking down the side of her face. "I had heard that its atmosphere was poison, so I had Zeborox here steal the torcs from Ominovin, both to prevent him from following us and to keep us alive on the *Spelljammer*. Poor Zeborox. . . ."

Again, the story holds water—no other means of divination shows where Zeborox's race is. The owl is a small figurine of wondrous power made of stone, its eyes of carved jade. Not fashionable, but the only clue she has.

Charity knows where the *Spelljammer* will be in a few days' time, and time is of the essence. Now she needs help. Will the players aid her in her quest?

The *Spelljammer* has in the past always returned to the edge of this sphere at the same time, every two years for the past twenty years. Charity learned this from notes stolen from Ominovin. This is the one opportunity to discover the Mystic Owl and reveal where poor Zeborox's people are hiding. The torcs should protect the characters (in theory) from the poisoned air. Charity has a tradesman she will provide (if needed), and is willing to act as the spelljamming mage if none is available. Or she can stay behind and wait for the players to return with the owl. The decision is the players'. She will offer the tradesman in payment for recovering the owl.

Did we mention that Charity is Ominovin's daughter? That might be important later on. . . .

III. Quentin

You have barely lifted off when another ship is spotted off the port bow. It appears to be another of the tradesman class, but its stern is oddly distorted. The ship has made no hostile actions, but is on a convergent course with your own.

The players can evade the ship if they so choose, but get a good look at it. It is Quentin's *Libraria* (described elsewhere in this book). He, too, is aware of the *Spelljammer*'s future position, and he is heading in that general direction, stopping for supplies on the planet below before setting out.

If the heroes hail the *Libraria*, they will find

Is he . . . dead?

CAMPAIGNING WITH THE SPELLJAMMER

Quentin Axan gruff but friendly—he is at last closing in on the *Spelljammer*, and soon her great libraries will be his. If the heroes are friendly, he will gladly share his information and be willing to accompany the hero's ship to the *Spelljammer* if they will wait two days for him to regain supplies (Charity did mention that time is of the essence). They will not miss the *Spelljammer* if they accompany Quentin, but the players will not know this.

Quentin will offer to carry the characters in his ship, if they so desire, if they are willing to pay passage (in burnable books), and contribute sufficient supplies to reach the great ship. He inquires about the character's intentions to determine that they are not threatening his goal. The characters are under no restriction to inform Quentin about the torcs.

If the heroes fire on Quentin, he will flee. The heroes may capture and/or destroy the *Libraria* in combat. This will cripple their attempts to get home.

IV. Leeches

Your ship drops from spelljamming to tactical speed, and everyone aboard tenses for the potential battle that often accompanies contact. Instead, at the edge of your contact area are a trio of kindori, the majestic space whales that float through the void. But while normal kindori bob and weave in the nonexistent currents of wildspace, these turn upon you and charge. You see mounted on their backs small metallic ships with catapults readied.

The kindori are under the command a trio of neogi leeches. Each leech has a neogi pilot and a human catapult team of five sailors (all 1st level fighters armed with long swords). The neogi have been retained by Ominovin to destroy the first ship that crosses its path, heading in the direction of the rendezvous. The hero's ship is elected. If

they are traveling with Quentin's *Libraria*, then both ships can combine their attacks to battle the Leeches.

The leeches will attack until two of them (or their mounts) are destroyed. A leech that has lost its mount will attempt to escape the battlefield. The survivors will retreat to a safe bolt-hole and later attempt to contact Ominovin to report their failure.

If the leeches succeed in destroying the heroes' ships, they will fly off, leaving the survivors to suffocate in their dwindling air envelopes. The heroes must save themselves at this point. In a day's time Quentin Axan and his *Libraria* (if not already present) will follow the same route and find the debris, taking on the stragglers, and head for the *Spelljammer*.

V. Arrival

The spelljammer is already there when you drop from spelljamming speed, its huge bulk filling half the sky. Its great wings shine in the reflected sunlight. In the shade of its back, a great city glitters with small lights and fires.

The heroes can land their ship anywhere on the ship, though coming too close to certain towers may be inviting attack. Remember that landing the ship elsewhere than in area #1 will result in almost immediate attack and dismantling (and even landing in area #1 only postpones the attack).

As long as the heroes keep their torcs on, they will be protected from the effects of the *Spelljammer's* magical air. However, after the first day, they will notice that their gold torcs begin to tarnish. On each day thereafter they will corrode further, as the magic within the torcs suffers from the assault of the *Spelljammer* itself. After 10 days, the torcs will fall away, useless, and the normal effects of the *Spelljammer* will occur. A character can remove a torc, but it will have no effect on re-donning it if the saving throw is failed.

The *Spelljammer* is already there when you drop from spelljamming speed, its huge bulk filling half the sky. Its great wings shine in the reflected sunlight. In the shade of its back, a great city glitters with small lights and fires.

CAMPAIGNING WITH THE SPELLJAMMER

Note that none of the natives on board (with the exception of Arcane) will even think of leaving the place, and their reaction to any such suggestion will be startled disbelief, as if the hero had suggested they flap their arms and fly away.

Regardless of area, the heroes will first encounter a young halfling named Holodin Castleknight. Holodin watched the approach of their ship and scurried to where they looked like they were going to land. Holodin is a curious halfling, only interested in making a few quick gold pieces. He will warn the characters if they are landing in an area other than area #1, and point them in the direction of the market (area #6) and the Open Air Public House. Of course, he will expect to be tipped every step of the way. Holodin will be an excellent introductory character, getting the characters initially involved with the other individuals on the ship. Holodin has the typical halfling prejudices (in favor of humans, wine, and gossip, against beholders, mind flayers, and combat). He has no real information about any of the power politics, but he will be glad to introduce them to Kristobar Brewdoc, who will have the information (he thinks).

Unless he accompanies the players, Quentin will land about a day later. Quentin will immediately seek out the centers for learning, starting with the Xenos (and not getting very far, since all their texts on the *Spelljammer* were taken by the wizard Neridox), then attempting to break into the tower itself. Which is what the characters have to do eventually as well.

VI. Investigation

Once at the *Spelljammer*, it will be very easy for the players to fall into the cycle of the various power groups and factions operating aboard ship. The investigation is a simple trail of contacts and favors, as each being in the chain wants something else for his little bit of information. Others not in the chain may or may not have pieces of the operation, at the DM's option, or may just send

the heroes back to someone they have already dealt with (or are avoiding dealing with).

A collection of small adventures to be used during the investigation is included below.

The search should begin with the Open Air, (either before or after the battle) with Holodin getting Kristobar over to their table.

Kristobar has never seen the owl, but he thinks he knows someone who will know. Would the heroes be willing to do him a favor in exchange for a name?

Kristobar jerks a thumb at a loud, rude hill giant in the corner, overturning tubs of mead in his face and backhanding waitresses on the rump. "This guy is ruining business. Could you bounce him for me?"

How the heroes get the giant out of the public house is up to them. Killing him outright will result in a later ambush by some of the other giants (and possibly some minotaurs, as Breakox decides to show support). Magical enchantment works, as does challenging him to a duel or merely duping him. The giant is none too bright.

When the heroes get the giant out of the public house, Kristobar gives them CassaRoc's name (area #11), and sends Holodin ahead to announce them.

When they arrive at CassaRoc, the fighter has laid out an impressive feast. Chaladar and Chila have been invited as well. CassaRoc does remember the device, a reddish owl, and knows where it should be. He'll turn over the information for a small favor in return (attacking or enspelling CassaRoc might yield the information directly, but it risks the wrath of the other human leaders and their troops).

CassaRoc wants proof of the heroes' bravery. Most mind flayers on board are a dour lot, but not their leader, Trebek. Trebek is a more colorful individual, easily identified by a bright badge of red or yellow.

Get CassaRoc that badge, and he'll tell the heroes where the owl is.

Kristobar jerks a thumb at a loud, rude hill giant in the corner who is overturning tubs of mead and backhanding serving girls on the rump. "This guy is ruining business. Could you bounce him for me?"

CAMPAIGNING WITH THE SPELLJAMMER

Trebek spends most of his time in the horned tower, except for when he attends council meetings, such as one that evening. The player characters may attempt to reach Trebek in his lair or at the council.

Trebek is more reasonable than either human or halflings and does not demand anything for his badge except an explanation of why they need it. He has been the brunt of some of CassaRoc's challenges before and considers the human a boor. If asked, Trebek will gladly surrender a small swatch (autographed) to help the party, with a side note that they may return the favor some day.

Of course, some player characters may not bother to ask for the badge, seeking to either break into the horned tower (good luck) or ambush Trebek en route to or from the council (Trebek is discoursing on the danger of the Hobgoblin Prophet). Trebek is accompanied by a second mind flayer and a pair of hobgoblin guards, who act as living proof of the benefits of working with the illithids.

Attacking Trebek (if successful) will result in a later ambush by illithids. Killing Trebek will result in the heroes being hunted down by all the evil forces on board, with the humans (even CassaRoc) standing aside (after all, CassaRoc never said they should kill the mind flayer).

If the heroes fail, CassaRoc may assign some other mundane task to them to complete before giving them the information. Should they succeed, CassaRoc will throw another feast (lasting most of the evening) and tell them that the previous time he heard of such an item, it was in the possession of Neridox, the wizard (building 8). Neridox was the chief wizard when the last captain died in battle, but in addition to his great library, Neridox had a collection of statuettes. He is sure that the red clay owl was one of them.

While CassaRoc is wining and dining, Holodin is making a little cash on the side selling out the heroes. He will meet with a gnome follower of the Arcane and explain all that has been revealed to him

so far (who the heroes are, what they are after, and definitely the fact that they are interested in the old wizard library).

This sets the stage for the final battle, but first . . .

VII. Things In Passing

There are a number of small adventures that can occur while the heroes are tracing the line back to Neridox. They include:

Ship Demolition: If the time expires for removal of the ship, the shivaks will move in, taking it apart. Common items go to the ship stores, more complex and unique items go to the museum. If any player character is present, read him the following:

You are roused by the sound of chattering. Looking out, you see a collection of about a dozen silvery forms—human, centaur, and beholder. As you watch, they begin to converge on your ship, arms held high to attack.

Getting the ship off the *Spelljammer* is a wonderful way of avoiding losing the ship. If the heroes left NPCs on board without instructions on how to proceed, the NPCs will seek out the heroes and report that the ship is being destroyed (likely too late to do anything about it). If the heroes simply trust that the ship will be safe, they will eventually return to find it gone.

Note that Quentin's *Libraria*, which arrives the day after the heroes, is under the protection of its idol, which will immolate anyone who attempts to harm it, including the shivaks. Untended, it will eventually weaken and be destroyed as well, but it will last longer than the torcs for getting off the ship.

If the heroes destroyed the *Libraria* and lose their own ship, they must find a way to get off the ship on their own. Good luck.

Ambush: The minotaurs are looking for a few good slaves, and they target the adventurers.

You are roused by the sound of chattering. Looking out, you see a collection of about a dozen silvery forms—human, centaur, and beholder. As you watch, they begin to converge on your ship, arms held high to attack.

CAMPAIGNING WITH THE SPELLJAMMER

They set up an ambush as the heroes are moving from place to place. There are as many minotaurs as player characters in the parties (if Charity is present, they will definitely try to keep her alive). They will not be led by Breakox. After taking half losses, the minotaurs will break off. If they defeat the heroes, the female survivors will be enslaved by the minotaurs, and the male survivors will be offered to the mind flayers. The survivors will be left with their torcs, and escape is up to them.

The Hobgoblin Prophet: The heroes are confronted by the rabid form of the Hobgoblin Prophet, ranting against Trebek and the mind flayers. The hobgoblin will go so far as to grab the heroes and shout at them that they must pay attention to the plight of his brethren. He is flanked by two bored ogre mages, ShiCaga's two sons, who were assigned to protect the Prophet. While they would not mind the Hobgoblin Prophet being bounced around a bit, they will step in and defend him if steel is drawn.

VIII. The Tower of Neridox

Use the map for area #8. The Owl of the Mystics is still on Neridox's desk, covered with soot but otherwise unharmed. There are four groups converging on this area: the heroes, the beholders, Quentin Axan, and the shivaks.

The heroes were sent by CassaRoc.

The beholders were sent by Arcane. There are three beholders already in the building, hovering near the ceiling of the main library. They have been told the Owl of the Mystics was a weapon designed by Neridox to harm beholders and that hirelings of the neogi are going to fetch it. They will attack only once they are sure that the heroes are after the owl. The Arcane is invisible in the corner and wants to grab a torc from the first fallen hero for further research. He will flee if discovered.

Unless Axan is with the heroes, he will appear behind them in about six rounds, with 12 armed

and armored giff (the best he could hire at the time). He wants the books and will be beside himself to find that they have already been burned. Unless the characters act fast, he will order the giff to open fire. If the heroes calm Quentin down, the giff will help when the beholders attack, firing one round before retreating in good order.

The shivaks are already on their way when the characters break in. They arrive three rounds behind Quentin Axan (nine rounds after initial entry). They seek to remove anyone they find, including beholders. There will be a few beholder versions to deal with their kindred as well.

The doors to the library are locked normally, then wizard locked as well and sealed with tar. The locks may be picked or bashed and the wizard lock dispelled, but it will require a strength of at least 18 to pull the door open. Once the heroes enter, the clock starts running. Read the following to the players and go from there:

The door swings outward slowly on rusty hinges, and you are overwhelmed by the smell of old, smoldering fire. A black cloud billows out toward you from the tower.

The smoke is harmless, but it reduces sight to about 4 feet and permeates the entire tower. The full tower description and its map are in the *The Grand Tour* book. There is nothing else in the tower (with the possible exception of a scroll placed by the DM).

IX. Getting Off the Ship

The DM may craft other adventures as he sees fit to delay and or interest the player characters on board the *Spelljammer* (see below for the *Spelljammer*™ Campaign). Note that the clock is ticking, not only for possible survival of their own ship, but for the duration of the torcs. The characters have several escape options.

The door swings outward slowly on rusty hinges and you are overwhelmed by the smell of old, smoldering fire. A black cloud billows out toward you from the tower.

CAMPAIGNING WITH THE SPELLJAMMER

Use Their Own Ship. If their own ship was placed out of the range of the shivaks, or the characters are quick in their mission, their ship should not be disassembled.

Use Quentin's *Libraria*. The *Libraria* has its own defense systems, and will likely be still available at the completion of the mission. Unfortunately, the players will have to be with Quentin to turn off the system or else be attacked themselves. If Quentin is dead, they will have to get through the system to take command of the ship (by tossing books into the burning maw of the ship, showing that they will serve it). Getting rid of the *Libraria* later is their problem.

Deal With Arcane. Useful only if both the above options do not work, Arcane will gladly attempt to get the heroes off the ship in exchange for a task (what, again?). They will have to get the large tower bell from the dwarves. Arcane will have the characters drink wine drugged with a paralytic venom (assuring them it will protect them from the void), load the bodies into the bell, and catapult the bell off the side of the *Spelljammer*. Arcane is checking to see if the catapult will be sufficient to launch that much mass into space.

The characters' ability to survive once the bell is launched into space is not Arcane's concern, though the players might note this and try other means to rescue themselves. Those tossed off the *Spelljammer* should be picked up (under a merciful DM) by Ominovin.

X. Endgame

After the heroes leave the *Spelljammer* (by whatever means), they will have one last encounter:

Called a whaleship, it lives up to its reputation. A huge beast of wood and polished metal, the upper deck bristles with ballista. As you enter

its air envelope, you hear a voice: "Resistance is useless. Surrender the owl to me. Surrender the owl to Ominovin."

If Charity is with the heroes, she will blanch and say something like, "Oh, Daddy's found me." If she is not, she is held captive aboard her father's ship (he will note that she is in chains).

Ominovin's ship is run by Furchin halflings, slaves to the wizard. There are only about 10 other human crewman on the ship, and all of these are 5th level fighters. There are five batteries of two ballistas each along the upper spine of the whale, with a single human ordering the crewmen about. Ominovin (and Charity) are found beneath a glass dome on the nose of the ship. The Furchin will not fight and will only fire the ballistas as long as the humans are there to enforce Ominovin's rule.

Ominovin wants the map to find more of the Furchin—they make such diligent workers. If the heroes surrender it, he and his crew will open fire and try to kill the heroes. If the heroes refuse to surrender it, he will still open fire, seeking to pull it from the wreckage.

Ominovin is a 15th level mage with *bracers of defense* (AC 4), a *dagger* +3, and the following spells:

- 1st Level: *sleep* (x2), *feather fall*, *wall of fog*, *magic missile*.
- 2nd Level: *flaming sphere* (x2), *spectral hand*, *web*, *shatter*.
- 3rd Level: *fly*, *haste*, *fireball*, *lightning bolt* (x2).
- 4th Level: *polymorph other* (into furchin, x3), *wall of ice*, *shout*.
- 5th Level: *cloudkill*, *cone of cold* (x2), *feeblemind* (x2).
- 6th Level: *death*, *disintegrate*.
- 7th Level: *finger of death*.

A huge beast of wood and polished metal, the upper deck bristles with ballistas. As you enter its air envelope, you hear a voice: "Resistance is useless. Surrender the owl to me. Surrender the owl to Ominovin."

CAMPAIGNING WITH THE SPELLJAMMER

Ominovin will use his killing spells on the heaviest fighters or those who seek to land on the deck and attack him. The *fireball* and *lightning bolts* are for distance attacks. He thinks that polymorphing individuals into hairy halflings is a good joke.

Should anyone land on the whale, the humans will abandon their posts and come forward to protect their masters. Should the heroes flee, the whale will pursue until their next landfall, then engage them there.

If Charity is alive and present, she will try to save her father from death at the hands of the adventurers, recommending imprisonment instead for the evil old man. Of course, Ominovin must be caught first.

And the Mystic Owl? Well, it does not radiate magic, but the circular base pulls away to reveal a lead-lined cache. Stored in the cache is another map, showing the directions to the Furchin hiding world, located in another crystal sphere. The owl

is red paint over solid platinum, worth some 10,000 gp. This tale about the *Spelljammer* would be worth another 10,000 gp to the Arcane, in particular any mention of their mad brother, and if the heroes have any information, the Arcane will pay another 10,000 to ensure it does not get passed around.

The players have a whaleship full of Furchin, and Charity is curious if they will provide an escort through all the dangers of space to their new home.

But that is another adventure.



CAMPAIGNING WITH THE SPELLJAMMER

The Spelljammer™ Campaign

The initial parts of the quest for the *Spelljammer* are best played against a backdrop of other adventures, the pieces attaching themselves as the game progresses. A piece is found here, a clue there, culminating in the discovery of the *Spelljammer* itself, and the battle for control. But the story does not end there. There is the little matter of running the *Spelljammer* while it moves through its dark times, until the flight of the small-jammers, and the return to "normalcy." Lastly, there is the question of leaving the *Spelljammer*.

The *Spelljammer*™ campaign is best played by experienced players of at least name level (about 9th level or higher). One player (the one who picks up the ultimate helm) will be the center of the campaign, but he will need as much help as he can get, so two to eight other cooperating characters are recommended.

I. Discovery

The campaign plot kicks off with the discovery of an ultimate helm. This helm can be any type of object, with several small magic powers.

The ultimate helm should be specifically placed by the DM into the campaign, most likely as treasure. The best bet is to treat an ultimate helm as an oddly-cursed variant of a standard item. For example, an ultimate helm in boot-form may function like *boots of elvenkind*, except that they cannot be removed. This will usually cause the characters to make extensive attempts to remove the items (with the effects as noted in ultimate helms—*remove curse* has no effect, *dispel magic* does, and *wishes* destroy the helm). It will also cause the players to wait with gritted teeth until the "obviously" cursed item shows its true nature.

The characters may succeed in removing an ultimate helm and even in palming it off on another individual. There will be others to find as the campaign progresses.

Within 2-20 days of initial discovery, the first of the minor powers should manifest itself. These minor powers have either been chosen by the DM (with an eye toward making things interesting for the players without unbalancing the campaign), or rolled randomly. Start with the weakest or choose one at random. Usually a power will manifest when it is a) useful, and b) the player character using the helm is in an excited or agitated state. This requires a little memory and sleight-of-hand by the DM (remember that the DM knows what the helm can do, but the player does not).

Initial research (*identify* spells, *contact other planes*, *legend lore*) should merely reveal that the item is what its base appearance is (a set of plate is *plate mail + 1*). If the helm is somehow deactivated and sold, it will fetch a price comparative to the item that it mimics. As additional minor powers appear, those too will show up as a result of such magical tests, but only after they have first manifested themselves ("Odd, that wasn't there before—this +1 sword allows you to cast a *light spell*.")

When referring to the ultimate helm in conversation, use its item name (*hat of disguise*, etc.). Calling it a helm is a giveaway to the players (unless, of course, it is a helm, as in *helm of comprehending languages and reading magic*).

The only other piece of information to keep in mind following the initial discovery is that the ultimate helm's priority is to get itself (and its chosen user) into wildspace, where it can eventually return to the *Spelljammer* (the assumption is that the ensuing adventure is sufficient to give the individual enough power to survive on the *Spelljammer*, but the ultimate helm is only driven to get the character there). If the hero with the helm is already in a space situation, all well and good. If such is not the case, the characters will soon encounter one of the many ways of attaining space travel as outlined in the original SPELLJAMMER™ boxed set, be it the discovery of a decommissioned or crashed ship or simple capture by one of

"Perhaps, m'lord, we have erred in accepting their challenge."

The late Admiral Blaise mon'Chevalier to
Comte Phillipa de Havuezollern, moments after sighting the
great bombard *Krakatoa*.

CAMPAIGNING WITH THE SPELLJAMMER

the many slaving races in space.

And if all that fails to interest them, send H'Carth's boys after them (Part II).

II. The Pursuit—H'Carth's Boys

The ultimate helms radiate a strong glow of magic around them, with the same intensity as artifacts, drowning out the magical auras of other items. This tends to attract attention.

For the purposes of this presentation, the helm has attracted the attention of a renegade beholder name H'Carth. H'Carth's nation had been wiped out by other beholders, and he is out for vengeance and looking for power. Artifact-sized power. When word comes back that something of great magical intensity is nearby, he sends someone to investigate.

This section consists of two encounters, the first being a set-up which will determine the strength of H'Carth's forces.

The Set-Up. The hero with the ultimate helm is approached by a stranger. This could be in a bar, on the street, in a church, or in any public place that the player character frequents. The stranger is of the same race as the hero and is a 0-level hireling employed by H'Carth and sent to check out the situation. He will be neutral in alignment and unarmed. If threatened, he will flee.

The stranger will introduce himself, offer to buy a drink, comment on the weather, and generally make small talk before homing in on his target—some item in the hero's possession. If the ultimate helm is visible (a sword, helmet, or gloves), he will target on that. If not visible, he will comment on the item that contains or hides it. ("Say, that's a real nice BAG you have there, friend. I remember my second cousin had a BAG like that. Only it was cursed. Had to cut his hand off to get it loose. Real pity, and he played violin. So, is your BAG cursed, friend?")

The stranger is sizing up the party and particularly the hero. He will notice the size of the party

that evening and their general raiment (full armor indicates fighters to him, blunt weapons priests, leather armor rogues and no armor wizards). If the hero (or his friends) threaten the stranger, he'll just move on. If they talk with the stranger, he'll attempt to find out as much information about the item as he can. The characters can lie like the Lower Planes and he'll just suck it in. ("So, that BAG contains undead rattlesnakes? Really, well, my second cousin's BAG didn't have nothing like that in there. We just couldn't remove it. Had to cut off the hand. Real pity. Used to play the violin. So, friend, do those undead rattlesnakes in your BAG do anything?")

Play the stranger for comedy. He talks funny, he radiates no evil, and he believes what he's told. After about five minutes of inquiry, he moves off ("Well, thanks for the conversation, friend. If I see another BAG like that one I'll be sure to mention it. Funny how my second cousin's BAG was cursed. Had to cut off the hand. Real pity. Used to play the violin. Well friend, thank you anyway.") About five minutes later he leaves, and the DM can get on with the regular part of his campaign.

Or maybe not. Suspicious players may follow the stranger. Here's what happens.

The stranger moves off to a scribe's establishment and spends about a half-hour there. A young boy, a runner for the scribe, leaves the scribe's office and delivers a letter to a ship on the docks (if no ship is available, then to a merchant). The stranger has been hired by H'Carth to check things out. His report details the following:

- The appearance of the ultimate helm (if he hasn't seen the ultimate helm, the appearance of the package).
- The appearance of the hero with the ultimate helm: race, sex, apparent class, apparent toughness, hair color, distinguishing marks, apparent intelligence (always listed as "not too bright").
- The appearance of the hero's companions, including number and apparent class and tough-

*"Say, that's a real nice bag you have there, friend;
I remember my second cousin had a bag like that. Only it was
cursed. Had to cut his hand off to get it loose.
So, is your bag cursed, friend?"*

CAMPAIGNING WITH THE SPELLJAMMER

ness (again, judging from appearances—a paladin dressed in comfortable clothes, unarmed and unarmored, will be noted as a wizard).

The suspicious heroes can find out the information from later accosting the stranger (after performing his mission he has no reason to lie), from bribing the scribe and/or the runner. The merchant captain is unbribable and his ship sails/he disappears soon afterward. The stranger was merely told to pick up what he could about the hero in question and deliver the information to the scribe. The scribe was merely hired to hire the stranger, write the message, and send it to the ship.

However, the heroes may not be suspicious, and the DM can slide into his regular adventuring, until about two weeks later. Then the ambush occurs.

The Ambush. Put this encounter at least two weeks after the set-up, at the next time it is appropriate (if the heroes are involved in an epic quest with no time to relax, it's OK, this can wait). The ambush should take place in the dark if possible, and the villains will lay in wait. If in the meantime the heroes have disposed of the ultimate helm, no further harm will come to them—it is now someone else's problem.

How many bad guys are involved will depend on the information that the stranger put into the message. There will be at least 50% more ambushers than there are comrades of the hero with the ultimate helm. For every mage or priest listed, there will be an additional fighter in the ambush. The remainder will be made up of fighters in black chain mail (AC 5) with long swords (1-8 damage). Level of toughness will be noted according to the message:

Not tough	All will be 5th level
Tough	All will be 7th level
Very tough	Fighters will be 9th level

The ambushers will be led by Heridos, a 9th level wizard, who is in the service of H'Carth. He

has been charmed by the beholder, and he recruited the other ambushers. His mission is to return to H'Carth's ship with the item, or not return at all.

Heridos will stop the party and demand that the rest of the heroes' allies pass on, leaving him to talk to the hero. His *friends* spell will make this sound like a reasonable request, while black-armored men slide out of the shadows. If the hero with the helm fails his saving throw, he will agree that the others should pass along, leaving himself behind. The ambushers will allow the other player characters to move along, but assign at least one ruffian to watch and see if they come back.

Heridos demands the ultimate helm. He is well aware that he will likely have to kill the hero in order to get it, and so draws his dagger of venom (he does not want to risk damaging the helm if he can help it). The ambushers close in against the hero and his remaining allies, and battle is joined.

If Heridos slays the hero, he will remove the ultimate helm (slicing off a hand if need be), *dimension door* out of combat, and *teleport* back to H'Carth. If the wizard takes more than half damage, he will *dimension door* to safety, watch to see if his ruffians can handle the situation, then either return to claim the prize or flee entirely. If he does not have the ultimate helm, he will not return to H'Carth, instead hiding out until the charm wears off. By that time H'Carth will be long gone. The heroes may be able to get information from Heridos through various means, but all that the wizard knows is that his master, the beholder H'Carth, desires the item that the one hero possesses.

The ambush should leave either the ultimate helm in H'Carth's hands (and out of the players' area) or the players now convinced that something is up.

Then H'Carth gets involved directly.

Evil wizard Heridos; Int High; AL LE; AC 10; MV 12; HD 9; hp 27; THAC0 18; #AT 1; Dmg 1-4 + poison (*dagger of venom*); SZ M; ML 15; XP 2,000.

Heridos wants the ultimate helm. He is well aware that he will likely have to kill the hero in order to get it, and so he draws his dagger of venom.

CAMPAIGNING WITH THE SPELLJAMMER

1st Level: *friends*, *detect magic* (already cast in preparation), *magic missile* (x2).

2nd Level: *hypnotic pattern*, *web*, *darkness 15' r*.

3rd Level: *lightning bolt* (x2); *protection from normal missiles* (already cast in preparation).

4th Level: *dimension door*, *stoneskin* (already cast in preparation).

5th Level: *teleport*.

III. Pursuit Part 2—H'Carth's Ship

This event should follow the next time the heroes are in space in a single ship. If it is necessary to find a reason for travel, float the tale that a sage might know what's going on, and a spelljamming sage is said to make his hermitage on a nearby asteroid. As soon as the heroes leave the atmosphere, H'Carth will attempt to destroy them.

H'Carth's ship is the sole survivor of his beholder nation. The crew consists of himself, the hive Mother, and five orbi, resulting in a very fast but badly undercrewed ship. He hopes to make up for this with two charmed gnome illusionists who will use their illusion abilities to help the tyrant ship defeat the heroes.

Each of the two gnomes casts an *improved phantasmal force*. One phantasmal force is cast on the shell of the tyrant ship (similar to the one on the back of the *Lorebook of the Void*) to make it appear that the shell is filled with beholders. The second will cast an *improved phantasmal force* of H'Carth, demanding the surrender of the hero with the helm.

The H'carth ship is waiting for the heroes. It will appear 24 hexes away and close as fast as it can. If the heroes have an SR greater than 6, they can escape; if not, they must fight. (Even if they do escape, H'Carth will show up the next time, and the next, etc., until they do fight.)

H'Carth will close for the first pass, and the gnomish illusionist will cast his *improved phantasmal force*. The figure of H'Carth will appear in

space in front of the hero's ship, within the air envelope. It will speak.

Greetings, foolish mortals. I am H'Carth of the One and True Beholder Regency. One of your number has an item that belongs to me. That item is the key to my race's salvation, the helm by which I may command the universe's mightiest weapon. By the great *Spelljammer*, artifact of my people, you will surrender and turn over the item and its owner to me, now, or you will be destroyed. This is your only warning.

If the characters ask for a description of the item, H'carth provides one, briefly (the players should not be left wondering what he is after).

In the unlikely event that the heroes surrender, H'carth will kill the hero with his death ray eye, remove the ultimate helm, return the body, then leave. As this sort of behavior is typical of beholders, it is more likely the characters will fight.

The tyrant ship is woefully undermanned, accounting for horrible maneuverability and poor effects of the attacks. However, the ship may still take out the hero's vessel, concentrating on disintegration to reduce its integrity. If the tyrant ship does destroy the heroes' ship, it will attempt to snare the hero with the helm, remove the helm, then depart, leaving the others to their fate.

Should the heroes board the tyrant ship, the ruse of many beholders will be exposed. In order to defend his last ship, H'Carth will attack himself, along with the hive mother (the gnomes will run in panic and hide, and the orbi are useless). They will fight to the death.

H'Carth's ship contains the ragged remains of his regency's treasure—about 20 gems worth 1,000 gp each, and a set of scrolls. Most are star-charts, but one is a detailed description of the item in the hero's possession, referring to it as a "helm." Another section describes the

"I am H'Carth of the one and true beholder regency. One of your number has an item that belongs to me. That item is the key to my race's salvation, the helm by which I may command the universe's mightiest weapon."

CAMPAIGNING WITH THE SPELLJAMMER

Spelljammer as the greatest ship in known space, its purpose unknown, and includes a number of the short tales presented in the start of book one. The last tale, scrawled in, is H'Carth's own notes that the *Spelljammer* is a weapon, and it belongs to him.

Should the players escape after receiving the warning, H'carth will not pursue. Should they leave H'Carth alive after this encounter, he will appear later on. The heroes should leave the encounter with the idea that the helm is valuable and, somehow, it is involved with the *Spelljammer*!

H'Carth's tyrant ship: Hull Points 23; Crew 9; Maneuver Class E; Armor Rating 0; Saves as Stone; SR 5. (The tyrant ship's high SR is the result of its multiple orbi. Its miserable MC is because it is seriously undercrewed.)

IV. Search for the Spelljammer

After one (or two) encounters with H'Carth, the heroes will be interested in what the ultimate helm really does. Here's what information can be divined.

From examining the item itself: Only the type of item and those powers that have been manifested will be revealed, but nothing of its origin. The best an attempt at discovering its origin will grant the user (say, by *legend lore* spells) will be to point off into space.

From researching the *Spelljammer*: There is a variety of claims involving the *Spelljammer*, many of them detailed in the opening section of the first book. Rely heavily on these tales, but do not give more than one or two at a time. There are a lot of stories about the *Spelljammer*, and most of them contradict each other. There is no mention of the particular hat/mirror/gloves that the individual possesses.

From checking out H'Carth (through sages, *speak with dead*, etc.): H'Carth is the last survivor of his beholder nation, and he seeks revenge.

He believed that the *Spelljammer* was a tool of vengeance created by his people, and he intended to capture it for himself. How he intended to do so was unclear, though the assumption was that he was seeking out some powerful magical artifact or entity to aid in his quest.

Talking to the arcane: Information regarding the *Spelljammer* is available at 2,000 gp per question, to be refunded if the answer is "I don't know." The arcane have access to all the legends and will use the information therein, quoting their sources and noting their possible veracity. They know nothing of the particular item, but can conjecture that its origin is in wildspace, possibly tied to the *Spelljammer*. Several research missions to the *Spelljammer* over the years have proved fruitless, as none have returned. The arcane will pay 100,000 gp in gems to anyone capable of proving who controls the *Spelljammer*, and 500,000 gp to anyone who can deliver the *Spelljammer* into their hands. They will stress that no one has returned from the *Spelljammer* alive, and that landing on the *Spelljammer* is an apparent one-way gate, with little hope of return.

Calling upon extra-planar beings or powers: A lot of high-level individuals have worked with or for a deity or two over the years, and may want to call in a favor to discover what is going on. The gods are mum on the *Spelljammer*, only giving the vaguest of clues ("Your fate lies far from us"). Those capable of granting wishes will do so, destroying the ultimate helm in the process.

V. Arrival

As the campaign progresses, the hero with the ultimate helm should come more and more into contact with the *Spelljammer*, perhaps seeing it streak across the sky when involved on a planet, or having it cruise by when the heroes are involved in a space battle. Eventually, the heroes will attempt to land on the *Spelljammer*.

And then the fun begins.

The arcane will pay 100,000 gp in gems to anyone capable of proving who controls the *Spelljammer*, and 500,000 gp to anyone who can deliver the *Spelljammer* into their hands.

CAMPAIGNING WITH THE SPELLJAMMER

The effects of the *Spelljammer's* air envelope and the actions of the shivaks to disassemble ships are noted in the first book of this boxed set. The initial saving throw against the ship is made for all those who come within its air envelope.

In game terms, falling within the aura of the *Spelljammer* is to place the player character within the restrictions and control partially of the DM—the DM can forbid or negate certain actions as being unlikely to occur, since it would take the character away from the *Spelljammer*. Building a new ship would be an odd thing to do, since no ever wants to leave.

As each character falls under the spell of the *Spelljammer*, take the player running the character aside and read him the following:

Your character has fallen under the spell of the *Spelljammer*. Your character feels as if the *Spelljammer* is his true home, and does not wish to harm it or to leave it. This is not a *charm* spell, and your character is under no other limitations, except to not take actions to leave or harm the *Spelljammer*. You will not speak directly of these restrictions to other players.

The player is then responsible for running his character in a manner compatible with the above guidelines. Maintaining this is good role-playing, and the player character should be rewarded accordingly. Continual attempts to escape should be reined in (but not punished) merely by invoking the above statement (and those who persist should be shown the Mad Arcane as an example of what happens when a player character knows he can't escape, but keeps trying anyway).

Now, the character is limited to this degree, but the players, of course, are not. Being a bright, intelligent group, they will come up with a number of ways to "accidentally" throw off the effects of the spell (for example, befriending one of the

many beholders on the ship, then finding a situation where their characters must be bathed in its anti-magic ray for an extended period). Such "inadvertent" attempts must be handled by the DM, but should not be quashed, unless the DM really feels like running the *Spelljammer* as his campaign. If anyone is going to escape the *Spelljammer*, it is the player characters—after all, they are the heroes of the tale.

For the ensorcelled heroes, the destruction of their ship is a minor loss; the loss of any important items will probably be more severe. The loss of the helm is unimportant, as they are not going anywhere. Those who leave a guard on their ship will likely find that guard attacked by shivaks seeking to disassemble the ship (see area #1).

The course of events after arrival depends on the players' actions. With the arrival of the ultimate helm, the *Spelljammer* begins to assemble its "control room" in one of the areas detailed in area #43. This will take 2-8 days, during which time it will be "conferring" with the ultimate helm to determine how difficult the guardian of the control room will be. At the end of that time, the ultimate helm leads the hero to the control room, but until then, it remains silent.

First contact between the heroes and the natives (discounting any possible interaction with the shivaks) will likely be with ordinary humans. They will be friendly toward other humanoid races (including elves, dwarves, and halflings), cautious toward unhuman races (ogres, goblins, mind flayers, and the ilk), and fearful of total nonhumans (neogi and beholders). Questions about captains will be responded to by confusion, though they will gladly take the individuals to their leaders (probably someone in the human collective). They will also gladly point out the citadels for various other races and note that the "center of activity" for the ship is likely the market (area #6).

Player characters reporting to the various citadels will encounter the leaders of those citadels, who have their own interests and agendas. Those

If anyone is going to escape the Spelljammer, it is the player characters—after all, they are the heroes of the tale.

CAMPAIGNING WITH THE SPELLJAMMER

who go to the market will definitely encounter the Open Air Public House, and Kristobar Brewdoc. Kristobar will give the players the general run-down (who lives where, who rules who, and where to find information and other sundries), as well as pump the players for information about their own mission.

If the heroes keep their mission a secret, they will have normal encounters similar to those listed in the first adventure; Orik and the minotaurs trying to "recruit" them, the Hobgoblin Prophet haranguing, a bit of Xeno terrorism, etc.

If the heroes tell their tale, of the item being somehow tied to the *Spelljammer*, the word will spread quickly. It will attract the attention of several individuals:

Astor will keep an eye on them initially, unless they speak of taking command of the ship, of becoming captain. If this is the case, he will try to ambush and disintegrate the would-be captain.

Demets knows that the captain brings a symbol of his authority. This item is that symbol. Should the information spread out, Demets will send a summons for the hero to meet him in the gardens, where he will explain that he believes that the hero is the next captain of the *Spelljammer*. He will support him in his captaincy if he makes Demets his regent. Otherwise he will cut off food supplies.

Stardawn will also send a summons, to meet with him at the Elven High Command. He wishes to befriend the individual and aid in him becoming the captain. That the hero may have little idea of captaincy puzzles and convinces Stardawn that the hero is unworthy. Stardawn will remain an ally until the battle in the control room. Then he will attempt to kill the hero and take command himself (with a similar rejection as experienced by Arcane).

Arcane knows all but is insane. He will agree to reveal all about the captaincy in exchange for a very high price (say, all the hero's assistants plus a spelljamming helm). He will tell the would-be cap-

tain that there is no retirement from captaincy, only death.

Coh will send two umber hulks led by a neogi lackey to the would-be hero and attempt to kill him. He will report his success or failure to the Fool. Definitely throw this encounter at the players.

The Fool will act based on Coh's success. Dark times under a weak captain are good, since it increases his own hand. Dark times under a strong, wise captain are bad, since he may gain enough power to challenge the Fool. If the heroes take losses from Coh's attack, then the Fool will hold back. If Coh's attack has no negative effects, then he will have a message sent (through a Xenos) to the hero, luring him into the warrens (most others will recommend staying away from the warrens). There an ambush using the banshee, two spectres, and about 30 zombies will be launched.

Lastly, the hero's own interests may take them to particular towers, such as Arcane. Given the descriptions of their personalities and the information the players are willing to provide with themselves, the various NPCs will decide if it is in their best interest to aid, stand aside, or turn the heroes over to another force to kill (the last can be done merely by putting onto the street that these might be captains).

After a short time (2-8 days after arrival, time enough for all player character to fail their saving throws and accept their fate as prisoners—for now—or actively get off the *Spelljammer*—to try and figure out why they were affected, then return), the control room is finished. The hero with the ultimate helm is told that he is suddenly attracted to a particular area. Getting to that area (such as the tip of the tail) is his problem, but there is a strong mental nudge to check out that region.

Demets knows that the captain brings a symbol of his authority. He will support him in his captaincy if he makes Demets his regent. Otherwise he will cut off food supplies.

CAMPAIGNING WITH THE SPELLJAMMER

VI. The Control Room

The control room is detailed in area #43. The DM chooses its location, and it is up to the player character to reach it. The guardian shivak has been activated and placed there, to attack when the captain first enters. Should the would-be captain retreat, the guardian shivak will pursue, up to the limits of the ship itself, until the possessor of the ultimate helm is dead. If the possessor of the ultimate helm dies after opening the control room but before defeating the guardian, the helm will be destroyed. If he dies after defeating the guardian but before bonding with the ship, the helm will survive and could be used by someone else.

In addition to the guardian shivaks, 1-10 regular shivaks will turn up per turn (maximum 20 at any time), but will not battle the would-be captain, only any of his companions in the area. They will not pursue if the companions flee the area.

The current guardian shivak is in the form of a 10-foot-tall mind flayer, and in addition has the ability to focus a mental blast, like that creature. If the guardian shivak manages to stun the would-be captain, it will close and automatically hit for normal damage, until the target is dead. At that point the ultimate helm will be destroyed.

In addition to the shivaks, the Fool will also use this opportunity to strike against the great ship. Once the guardian shivak is destroyed, there will normally be nothing to stand in the way of the hero from attempting to bond with the *Spelljammer*. However, the Fool will take the opportunity to attack. If Lothian Stardawn the elf is allied to the heroes, he will also take this chance to attack by surprise, kill the hero, and attempt to bond with the great ship himself.

If the Fool has determined that the captain is weak (from the encounter with Coh's forces), then he will send his banshee, three spectres, and 10 monster zombies led by Argargon (if the zombies can reach the area) to destroy the new captain and trash the control room.

If the Fool has determined that the captain is strong, then he will show up himself, leading his remaining high-level undead (spectres, banshee, and monster zombies) against the captain. As a side note, Stardawn will recognize the banshee, and she will choose him as a target, if he is present.

The hero with the ultimate helm may attempt to bond with the ship during the combat. It will take 1-4 rounds after initial contact to complete bonding. After that, the ship will be under the new captain's control. The Fool and his minions will try to kill the captain, excluding all others, if bonding is attempted. Even if bonding fails, the Fool will try to kill all others in the control room.

Bonding (either during or after the battle) takes place as dictated in the description of area #43. Should the bonding be successful, read the following to the new captain:

You suddenly feel as if you are expanding, as if your spirit is a great balloon, swelling with air, engulfing everyone around you. You feel that time is stopped, and everyone around you is reduced to shimmering light.

You continue to expand, and more points of light appear. Points of life, as you feel the entire community of the *Spelljammer* come under your control. Each mote represents a sentient, living being. Gray smudges move about you—the shivaks, now under your complete control.

You look up, look around you, and you see you are floating in space, the entire rainbow of energies swirled around you, brimming with life from every star and sphere. And you know that beyond the stars, beyond the spheres, are other worlds and other lives, and you can take yourself there in an instant, by whim.

You also feel another presence, a companion in the void, as powerful as yourself, giving you the energy. Its spirit is a world-rattling sympho-

"You are most welcome to take command," says the *Spelljammer*, speaking soul to soul, spirit to spirit.

"You are a part of us, as captains before you.
Let us make you welcome."

CAMPAIGNING WITH THE SPELLJAMMER

ny. It is the *Spelljammer*, or rather its sentient core, which grants you its power and commands you to be its captain.

"You are most welcome to take command," says the *Spelljammer*, speaking soul to soul, spirit to spirit. "You are a part of us, as captains before you. Let us make you welcome."

You can lay down the law on the prerogatives and restrictions of the captain with this player later, but the important thing (particularly if the Fool is still about) is that the captain can summon the shivaks and cause them to attack the undead that they normally could not see (but can now, because the captain is present). Also, note that the captain is now free of the magical air of the *Spelljammer*, though he has other restrictions, his character can now plot and plan as he sees fit to get other characters (and perhaps himself) off the ship.

Should the hero be rejected by the *Spelljammer*, read the following to him:

You feel yourself tumbling through the void, stars wheeling in all directions. You slow in your spinning and see that they are not stars, but rather little bits of life—human and elf and mind flayer and neogi all swirling about and through you. You look up and see the stars, the real stars, dancing and laughing at you.

You feel another presence, great and lumbering, like a whale passing by a minnow. You know it is the ship itself, the spirit of the *Spelljammer*. It examines you to your very soul, and then a single word cuts through your being like a dagger.

"No."

And you are back in the control room. The presence is gone, and you are shivering.

The helm is destroyed, but the would-be captain is not otherwise affected, with one major exception. For 24 hours he is not affected by the mystical atmosphere of the *Spelljammer*, and in that time can fashion an escape for himself and any partners.

The Fool, if present, will cut the battle short if the hero is rejected by the ship. He has done enough damage, and another day will come. He will escape the first round, and the others fall back the next. The zombies will fight until they are dead (OK—destroyed).

VII. Setting Up Shop

The new captain has one to four weeks before the gardens shuts and the dark times begin. During this time the captain should:

Learn the restrictions placed on him by the *Spelljammer*. This can either be done by having a heart-to-heart chat with the player, or letting the player discover as he goes along what he can and cannot do. The new captain wields godlike powers, but by the same token he has extreme limitations. Let the captain know (eventually, probably after Arvanon mentions it) that the dark times are coming, and what it entails.

Encounter a few spacecraft, such as a k'r'r'r multi-ship fleet, or several neogi death spiders. Let the captain have some fun wiping out a few enemies with the most powerful ship in the Known Spheres (but keep an eye on the restriction for endangering the *Spelljammer*)

Receive Envoys. Arvanon will see the first warning signs that the dark times are coming. He will pass out word that a new captain reigns, and the search will be on. The newcomer and his party will be feted, feasted, and allowed to stay in any tower of his or her choice (with the exception of the dark tower, which is still forbidden).

All the various factions will have a chance to show things off to the captain, make offers of alliance, and seek favors (such as punishing an oppo-

Arvanon will see the first warning signs that the Dark Times are coming. He will pass out word that a new captain reigns, and the search will be on.

CAMPAIGNING WITH THE SPELLJAMMER

ment or cutting off their food). The captain can choose what order he takes his visitors, and how he deals with their various problems.

Arcane will lock himself in and take no visitors, as he tries to figure out what to do next. While the captain is taking visitors, he will have his gnomes scope out any of the captain's companions for weaknesses and opportunities. He will gladly escape with the heroes if he can (killing them later because they know too much).

Arvanon will explain that the dark times are coming, and what it entails, including the development of the smalljammers and the lean times ahead. He will recommend stockpiling what is possible to help the majority survive. He will make clear that there is nothing he can do about it, it is natural law (and a check with the *Spelljammer* will confirm this).

Demets will make contact for the gardens if Arvanon is dead or out of action for some reason. He will state the same objectives as before—he wants to be regent. He does not mention the dark times, figuring the captain will know it for himself.

Astor will make an assassination attempt, if he has not done so before. If the captain kills Astor, his support from the halflings will diminish, and from Gray Eye's beholders will increase.

Breakox wants the captain to declare that Taja's giants should be part of his faction. He is a hill giant. They are hill giants. He will be blunt and rude.

Brother Burke and the **Xenos** will be entrenching if the Fool is destroyed, probably cutting a deal with Selura. If the Fool is still active, Brother Burke will continue to gather information for the Hooded Soldier. If the captain is nonhuman, they will be planning an assassination (details left to the DM, but the Xenos do have access to the Fool's powers, as well as Shou Lung smoke powder).

CassaRoc seeks an agreement that the captain will defend humans in case of attack, and to cut down on the thieves operating out of Father Goat's "church." He brings a gift of mead.

Chaladar seeks an agreement that the captain will cut off food to all evil races.

Chila seeks an agreement that the captain will defend humans in case of attack.

Coh (with **Orik**) seeks mediation in ending the war with the beholders. He demands a complete beholder surrender and the lower floors of their citadel for neogi use. He will deny all connection with the neogi/hulk ambush earlier (shocked, he is, simply shocked!), saying his people were charmed by beholders. He will not attack again until the dark times.

"Diamondtip" comes to swear fealty for the giff. If the captain is pleasant to him, he will tell about his quadruple bombard. He brings a gift of smoke powder.

Father Goat asks for an agreement to protect the lesser races of the *Spelljammer*. He denies any thievery in his church.

Firespitter sends a congratulatory message, with the note "Hope you last longer than the last one."

The Fool, if he still exists, is waiting for the dark times.

Gray Eye appears with two other beholders. He demands resolution of the war with the neogi, with the neogi giving them half their slaves in the deal. He also demands the death of Astor (if he is not dead already) as a plague carrier.

Hancherback appears to swear fealty to the captain and to note that if his nibs needs any information, he should call on him "nudge-nudge."

Highstar sends a representative requesting the captain meet with him, in regard to eliminating the goblin menace on the ship. If Stardawn is dead, his tone will be frosty and he will demand an explanation of the captain's barbaric behavior, leaving with a threat that the elven navy could take apart the *Spelljammer* if it so choose.

Kaba Danel appears to swear fealty for his people and **Suza**. If the captain wishes to meet Suza, he'll have to come to the tower of the dracon.

Korvok will appear to demand protection for

Coh demands a complete beholder surrender and the lower floors of their citadel for neogi use. He will deny all connection with the neogi/hulk ambush earlier, saying his people were charmed by beholders.

CAMPAIGNING WITH THE SPELLJAMMER

the humans under his care.

Kova appears with 10 dwarf courtiers and a weapon or suit of armor suitable for the new captain. He requests the captain provide protection for the foundries in case of attack.

Leoster is too busy to pay fealty to the captain, but sends his grandson **Ollister** to invite the captain to dinner and examine his coin collection. He does not offer to aid the captain in any way, but does not ask for any help, either.

Mostias invites the captain and his party for a cook-out and beer bash. A good evening, with no results.

Nagasimi is sent as **Si Loo's** representative, with his greetings. No offer of help. No request. No invitations. Seeing Si Loo would be "quite impossible."

Selura asks for protection for the humans under her control, and recognition that Taja's hill giants are really part of her citadel, since she hangs out with them. She is sizing up the captain for later execution.

ShiCaga requests the captain grants an audience for the **Hobgoblin Prophet**. The prophet harangues the captain and anyone else nearby for 45 minutes on the deadly slavery of his people by the mind flayers, and demands that they be released. ShiCaga also notes that most of the other evil creatures aboard are not to be trusted.

Taja will ask for a long audience to commit to memory the captain's life story, in particular the events that led to his captaincy, for future reference.

Trebek will appear to swear fealty and lodge a formal complaint against the elves for their harassment. He will not free his subject people unless all other races are freed as well, including the dwarves' prisoners (which Kova will flat out refuse) and the neogi's umber hulks (which Orik will refuse).

Each of these encounters can be run as a full encounter, or just in summary, depending on the DM's feelings for it. Too many meetings quickly

become boring, but sprinkle in just enough to keep things interesting and remind the captain that there are others on board watching him. The captain has limited power, but he can request Arvanon to reduce food supplies to one group or another, with good cause. More importantly, he can position shivaks to watch or protect certain groups. Placing these shivaks would be considered a sign of status for those groups, and irritate their opponents.

VIII. The Dark Time

After one to four weeks, the gardens close for 18 weeks while the smalljammers are created. All food shipments stop except for special shivak-delivered shipments to the captain and his command staff (those who live in his quarters). All but the lizard men are ejected from the gardens by a combination of the lizard men and shivaks. The captain can call off the shivaks, but the great ship will ignore the order and depose the captain. His former followers are left to fend for themselves.

The captain and his crew will not starve during the dark times, and the *Spelljammer* will let the captain know that this is part of the natural cycle. However, during this time, raids will become commonplace, including against the captain and his crew. The captain and his shivaks must watch out for themselves during this period.

Only the elves, centaurs, Shou, and mind flayers can survive through the entire 18 weeks with their at-hand supplies. The elves, centaurs, and shou have massive interior gardens, while the mind flayers intend to eat all their slaves and replace them later on. Encounters the captain will have to handle include:

Raiding the Larder. In particular, human groups stealing from centaurs and beholders (depending on alignment). Battles will cause the deaths of 1-2 beholders, 11-20 humans, and 3-4 centaurs (depending on the combatants). If the captain directly interferes, run the combat, otherwise just

The captain and his crew will not starve during the Dark Times, and the *Spelljammer* will let the captain know that this is part of the natural cycle. However, during this time, raids will become commonplace.

CAMPAIGNING WITH THE SPELLJAMMER

take the losses. There will be a number of these attacks through the dark times, and other nations can and will be involved. For the first three weeks of the dark time there is a 10% chance per day for a raid, increasing by 10% every three weeks following. The DM either chooses the target and the raider, or rolls on the following table (ignoring cases where a group raids itself).

Raider	Target
1. Human Collective	Human Collective
2. Dwarves	Dwarves
3. Neogi	Beholder
4. Centaur	Centaur
5. Giff	Elves
6. Father Goat	Shou Lung
7. Dracons	Dracons
8. Other Humans	Other Humans

Storming the Stores. Another dark times tradition—the looting of what is available in the storage area. A mixed group of humans, neogi, giff, and dwarves, whose only crime is being hungry, attempt to break into the stores and carry away as much as possible. The captain can repel them with shivaks, but at losses (run battle or assume 1-6 human deaths, 1-2 neogi, a 50% chance of an umber hulk or giff death, per attack). Using the shivaks to repel the assault will automatically turn these groups against the captain. If Astor is still alive, he will be in the defense, and if the captain does not defend the stores, an angry Astor will come looking for answers.

Night of the Long Knives. Selura attempts to consolidate her position. Unless stopped, she will have Taja and Korvok slain, taking over their memberships. Then she will try to take out the captain and his crew. ShiCaga and Breakox can be allies, but they have their own axes to grind (ShiCaga wants a move against the horned tower, Breakox wants Selura's troops as slaves.)

Assault on the Horned Tower. Rumors start to surface that the mind flayers are eating their form-

er slaves, and the horned tower has become a death camp. ShiCaga, the prophet, Coh, Orik, and Gray Eye all demand the mind flayers be brought back into the sunlight. Trebek denies everything, and is lying. The captain can help the illithids (turning the other evil groups and the elves against him), help with the assault (in which a quarter of the evils, 20 shivaks, and three-quarters of the mind flayers will be killed, along with half the surviving goblins, but the tower is taken and Trebek and the other survivors flee into the warrens to plot revenge), or do nothing (in which case half the evil alliance dies, half the mind flayers die, the tower is not taken, and everyone hates the captain).

Assault on the Captain's Quarters. Anyone with a grudge against the captain will assault the captain's quarters at one time or another. The captain can call on still-loyal groups to aid him, as well as use shivaks. Each assault can be gamed out, or cost 1-10 shivaks and 5% of the supporting troops, while wiping out 20% of the opposition. After suffering 20% losses, however, allies no longer show up to help.

The Flight of the Beholders. If, through various causes, the beholders are knocked down to three or fewer survivors, or Gray Eye himself is slain, the contingency plan for the undead beholders is brought on-line. The beholder-mummies are activated and turned loose on the citadel district. They will destroy everything they can reach in a mad burst of necromantic force. The captain's quarters will likely be besieged by refugees seeking an escape.

If the captain survives all this, at the end of the 18 weeks he is rewarded by the flight of the small-jammers; read him and his surviving crew the following:

There is a new sound in the ship, a deep rumbling that vibrates and courses through the bones of every surviving creature on the

The great doors on either side of the ship slowly roll open.
A small ship, looking like a miniature version of the
Spelljammer, slowly drifts out the doorway.
Then a second. Then a third. . . .

CAMPAIGNING WITH THE SPELLJAMMER

Spelljammer. The great doors on either side of the ship are slowly rolling open.

A small ship, looking like a miniature version of the *Spelljammer*, slowly drifts out the doorway. Then a second. Then a third. They bob and weave as they move down the great strips along either side, picking up speed and then finally dropping away from the great ship, spinning into the void on a life of their own, dancing among the stars.

The ships continue, and now sparkling fireworks shoot through the opening as well, spinning quickly and madly through wildspace before exploding in cold fireballs of blue and green. The lights are blindingly bright, and the reports of their explosions shake the ship.

All surviving eyes aboard the *Spelljammer* are raised to see the last of the smalljammers drift through space, away from its parent craft. The cycle has been renewed, the *Spelljammer* lives.

IX. Picking Up the Pieces, Further Adventures

The flight of the smalljammers is a once-in-a-career event. It will not be repeated as long as the captain rules. However, there may still be some unattended business left.

Retribution Against the Lizard Men, who are just as strong as when they kicked everyone out of the gardens, and have weathered the storm just fine, thank you. Arvanon may be a target for attacks, and if he dies, Demets, who has very different ideas about food distribution, will succeed him.

Retribution Against the Captain. Anyone with a grudge against the captain for the last 18 weeks will take the opportunity of trying at least one assassination attempt and, if possible, a full-fledged assault. Lawful enemies will call for a duel to the death. Good opponents can possibly be placated

with promises of food and protection, but eliminating hated enemies would be the best way to avoid getting into a war, such as killing almost all goblins for the elves.

Scouring the Warrens. If the Fool lives, he will still be in the warrens, working through any surviving agents to destroy the captain. The shivaks are useless without the captain to act as their eyes, so the warrens will have to be cleaned out first hand. For search parties without player characters, use the following table for success:

d100	Result (per party)
01-20	2-20 zombies destroyed, no loses
21-40	2-20 zombies destroyed, 1-4 searchers killed
41-60	1-10 zombies destroyed, 1-10 searchers captured
61-80	1-6 zombies destroyed, 1-10 searchers captured.
81-00	1-10 searchers captured

Captured searchers are turned into zombies (or monster zombies) by the Fool. Note that more powerful undead, including the Fool, will only be dealt with through player characters searching the warrens.

Other Assaults. Some other navies will attack the *Spelljammer*, including the k'r'r'r unity ships, the neogi with urchin landers, the mind flayers (including the new dreadnoughts), and beholder craft. There will usually be 1-10 such ships in an attack. The *Spelljammer* can fight or flee, but note the limitation of the captain's term by fighting too often or letting the ship take damage.

Newcomers. Just as the player characters first encountered the *Spelljammer*, there will be a number of newcomers appearing, with about a 20% chance per week. The captain can help or hinder them as the case may be, and the DM is encouraged to think up his own groups. Examples include:

Anyone with a grudge against the captain for the last 18 weeks will take the opportunity of trying at least one assassination attempt and, if possible, a full-fledged assault.

CAMPAIGNING WITH THE SPELLJAMMER

- A mixed group of adventurers in a squid ship or hammership, exploring space and seeing what the *Spelljammer* has to loot.
- A dwarven pirate in a citadel seeking to add the *Spelljammer* to his claim by killing the captain.
- A group of refugees of any race (probably one destroyed in the dark times) aboard a whale, looking for sanctuary.
- A Shou Lung dragonship, the most recent attempt to command the *Spelljammer*, resulting in two warring shou camps.
- A beholder nation ship which will land and attempt to take over the territory of any other beholders.
- A giff bombard bringing smoke powder—LOTS of smoke powder. They will be welcomed by their brother giff and there will be a lot of experimental explosions.

Encountering Other Space Civilizations. Pull up the *Spelljammer* next to the Rock of Bral and watch people panic! The *Spelljammer* is by turns regarded as a good omen or a harbinger of doom, so the captain will be worshipped as a god or face a wide variety of attacking ships. Then he must solve the problem of communicating through the *Spelljammer's* magical buffers—he cannot leave, and those who arrive may not want to leave.

Arrival of a New Captain. Captains are few and far between, no more than one per year of game time. About half of these are pretenders and posers, without the ultimate helm necessary to command the ship. The other half are real, and must kill the current captain in order to take command.

The details of a captain-to-captain fight are left to the DM, but it should be noted that they will be of similar power level to the current captain, and have companions of the same level. Reactions in part can be determined by comparing alignment of the two captains. An evil challenging captain will always try to destroy his opposition. Good challengers will wait to succeed other good characters, neutrals will not support the existing captains, and

chaotics will continually set up deals with the opposition to overthrow the current captain.

Getting Allies Off the Ship. This one is a little tough because, while the players may feel it is time to move on, their characters will consider the *Spelljammer* their home. As a result, the players will likely come up with interesting ways to “inadvertently” leave the *Spelljammer*, such as allowing themselves to be captured during a slave-raid by clockwork horrors. Depending on their creativity, the DM can reward them with escape (if that is their goal) or put them into a new, even worse situation. The only exception is the captain—his mind is directly linked with that of the *Spelljammer*, so any attempt to leave, or even to expose himself to an accidental departure, will be known by the ship. The *Spelljammer* will first warn the captain, then it will depose him and place him in retirement.

X. Retirement and Moving On

The captaincy of the *Spelljammer* is a life-time career. There are very few old captains floating around. Even if the captain figures out a method of getting his comrades off the ship, he is still stuck there. The following methods are recommended for resolving the *Spelljammer* captain's plight.

Retiring the Character. A decisive step, but keep in mind that these characters have achieved the equivalent of the holy grail of space, the captaincy of the *Spelljammer*. Swashbuckling campaigns of space pirates and interplanetary wars may pale by comparison (or may seem to be an improvement, depending on how much heat is being placed on the captain); gods themselves may step out of the heroes' way. If the players choose, their characters still on board the *Spelljammer* become NPCs, but remain in command of the great ship from that point on.

Involuntary Retirement. The captain is faced with a large force of shivaks. Every shivak will be

The Spelljammer is by turns regarded as a good omen or a harbinger of doom, so the captain will be worshiped as a god or face a wide variety of attacking ships.

CAMPAIGNING WITH THE SPELLJAMMER

raised against him, intent on dragging him to the dark tower or killing him in the process. The old captain joins Jokarin, Miark, and Theorx in retirement. The character can attempt to escape at that point (Jokarin is more than interested, the others less so), or the character may retire.

Continued Adventuring. There is no rule that the campaign aboard the *Spelljammer* has to end with the defeat of its major villains. There is a continual flow of newcomers to the ship, and all manner of potential threats for the DM to throw at his players, including full-fledged invasion, new undead or unliving creatures, and threats to the spheres themselves. The DM is encouraged to continue the campaign as long as the players are interested and feel that there are new challenges aboard the *Spelljammer*. Only when interest wanes should escape and/or retirement be considered.

The Hollywood Ending. This one is reserved for DMs who like to give their players a break, in particular if the players have been running their characters well and wisely and contributing to the civilization of the *Spelljammer*, destroying the Fool, and making the great ship a good place to live. It's called a Hollywood ending because it bends a few rules in the process, but it lets the player characters continue in the game.

About a year after the dark time, the captain and his surviving comrades are called to the gardens by Arvanon (or whoever rules the gardens). A great dome of earth has risen in the center of the community and Arvanon felt a sudden need to note it to the captain, as such a thing has never happened before in all his records.

As the captain approaches, the mound begins to disintegrate, revealing a smalljammer. It is silver, with fittings of gold and platinum, and its eyes are clusters of rubies. A voice sounds in the captain's head. A familiar voice:

"You have served me well, chosen one, though your heart longs to be elsewhere. Take this gift as a token of my gratitude and go with your allies to what new lands and new worlds you choose. You will always be remembered as a master among captains."

For the next hour the captain is freed of his compunction to remain on the *Spelljammer*, as are survivors from his original crew (later additions will have to be persuaded and/or knocked out and dragged aboard). He receives the ship and an open path to adventure, and takes off as the *Spelljammer*, once more under its own control, veers away and heads for far distant spheres and new captains.

He that strives to touch the stars,
Oft stumbles at a straw.

— Edmund Spenser, 1579

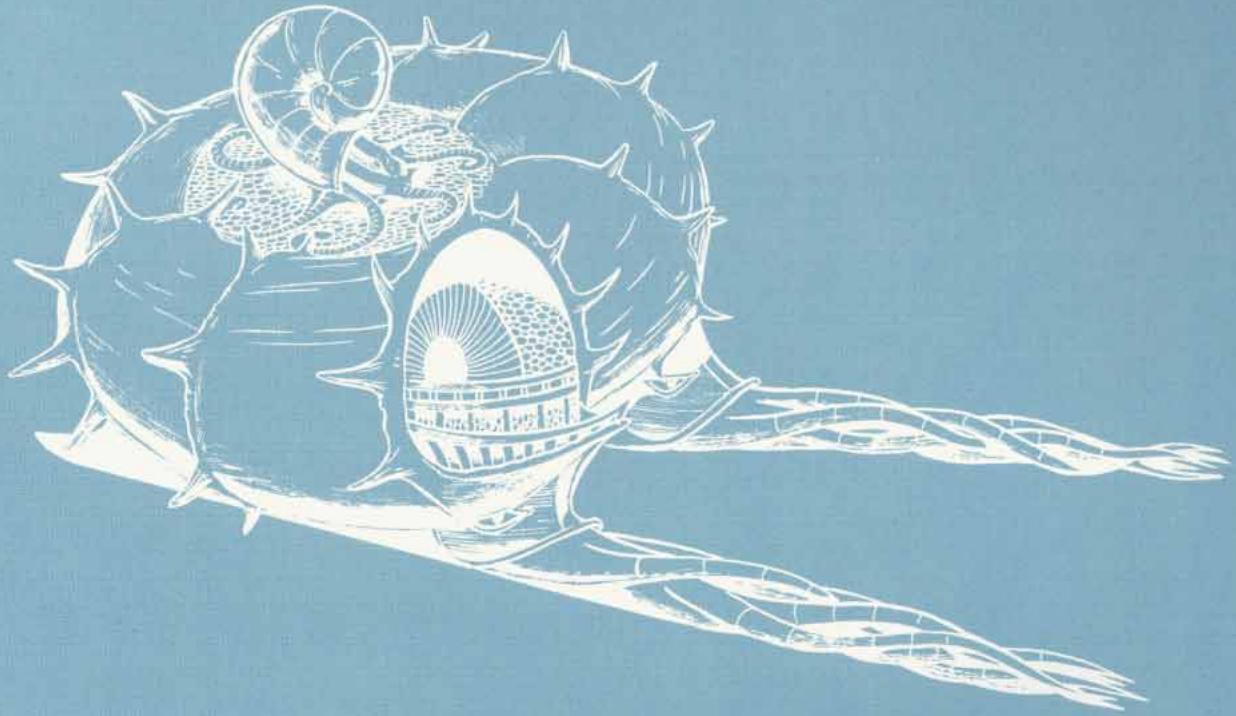

T065XXX1903

ADVANCED DUNGEONS & DRAGONS is a registered trademark owned by TSR, Inc.
SPELLJAMMER, and the TSR logo are trademarks owned by TSR, Inc. ©1991 TSR, Inc. All Rights
Reserved. Printed in the U.S.A.



Advanced Dungeons & Dragons[®]
2nd Edition

SPELLJAMMER[™]

Accessory

THE LEGEND OF SPELLJAMMER



The Grand Tour

Advanced Dungeons & Dragons[®]
2nd Edition

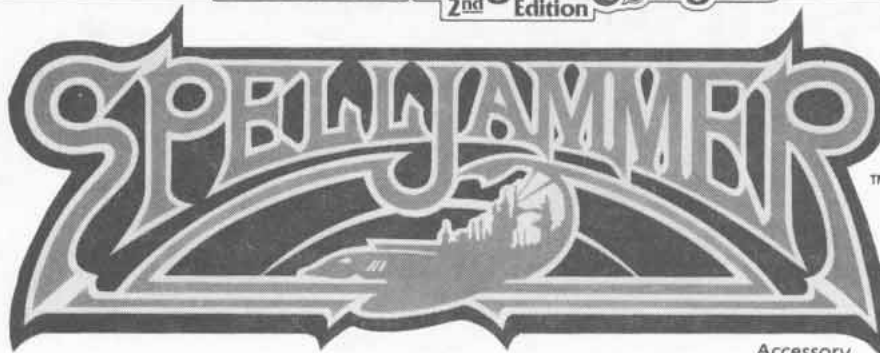

Accessory

The Grand Tour

by Jeff Grubb

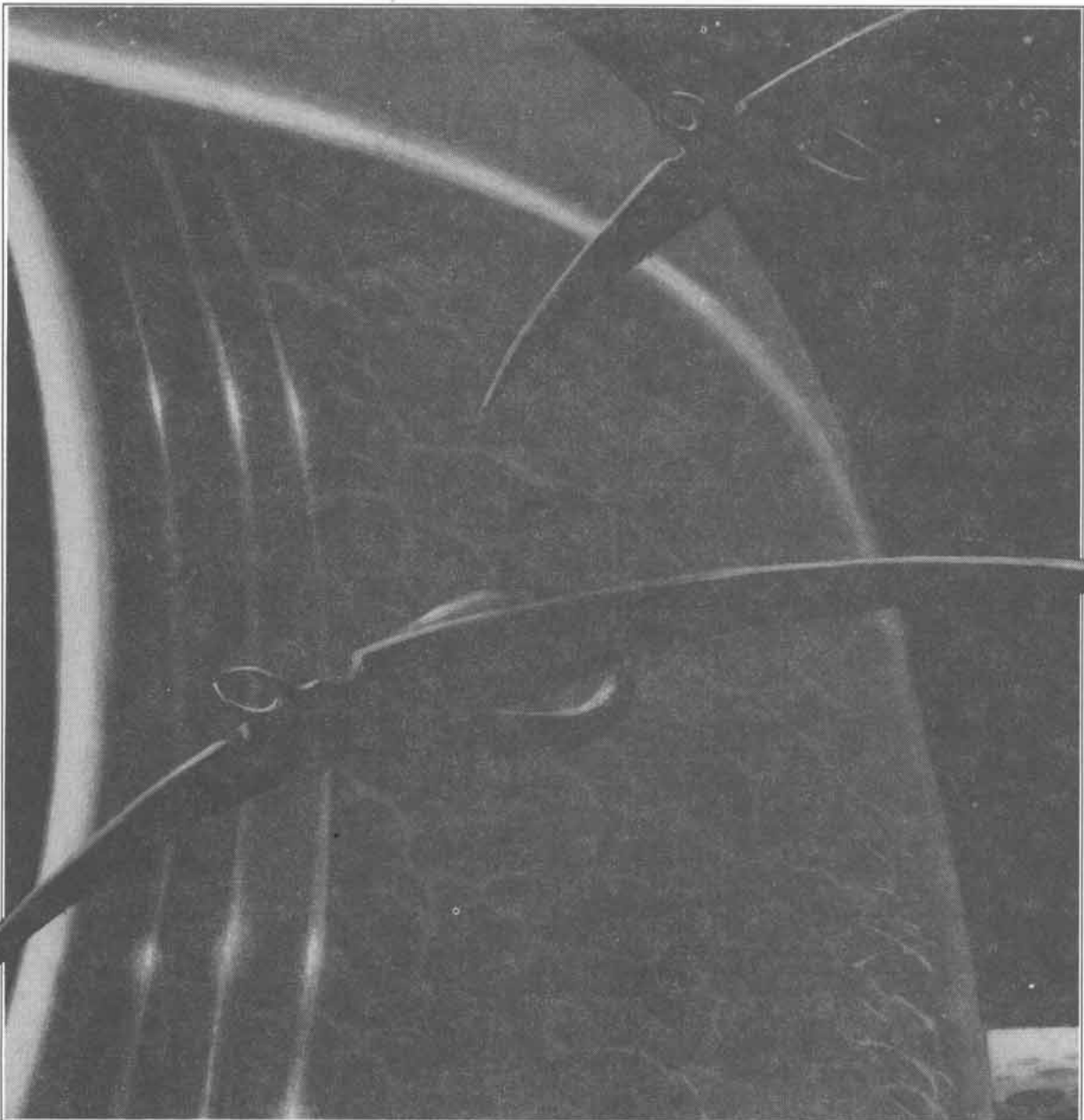



The Grand Tour

by Jeff Grubb

Design: Jeff Grubb
Editing: Dori "the Barbarian" Watry & Steve "Old Man" Winter
More Spiritual Guidance: James M. Ward
Cover Paintings: Jeff Easley
Ship Concepts & Illustrations: Jim Holloway
Ship Coloring: Les Dorscheid
Cartography: Diesel
Graphic Design: Stephanie Tabat
Production: Sarah Feggestad & Steve Beck
Art Coordinator: Peggy Cooper
Typography: Gaye O'Keefe & Angelika Lokotz

TSR, Inc.
POB 756
Lake Geneva,
WI 53147 USA



TSR Ltd.
120 Church End, Cherry Hinton
Cambridge CB1 3LB
United Kingdom

ADVANCED DUNGEONS & DRAGONS is a registered trademark owned by TSR, Inc. SPELLJAMMER and the TSR logo are trademarks owned by TSR, Inc.
Printed in the U.S.A. Copyright © 1991 TSR, Inc. All Rights Reserved.

TABLE OF CONTENTS

The Grand Tour	4
1) Landing deck	6
2) Gardens	6
3) Smalljammer strips	10
4) Council chambers	10
5) Captain's quarters	12
6) Ship's stores and market	13
7) Captain's tower	15
8) Library tower	16
9) Human collective	17
10) Chalice tower	19
11) Tower of thought	19
12) Tower of trade	20
13) Guild tower	21
14) Halfling community	22
15) Shivak terminal	23
16) Illithid tower	24
17) Goblin alliance quarters	25
18) Building of the giff	26
19) Communal Church	28
20) Old wizard's lair	29
21) Gnoll ruins	30
22) Minotaur tower	31
23) Ogre wizard quarters	32
24) Beholder ruins	33
25) Dwarven citadel of Kova	34
26) Free Dwarves tower	35
27) Neogi tower	37
28) Hulk tower	39
29) Giant tower	40
30) Shou tower	40
31) Arcane's tower	42
32) Tenth Pit	43
33) Long Fangs' tower	43
34) Academy of Human Knowledge	44
35) Old Elvish Academy	46
36) Elven High Command	46
37) Armory	47
38) Dark tower	49
39) Batteries	50
40) Dracon tower	50
41) Centaur tower	51
42) Warrens	52
43) Control room	53
Personalities of the <i>Spelljammer</i>	55
New Monsters	60

THE GRAND TOUR

TABLE OF CONTENTS

The *Spelljammer* is much more than a simple ship—it is a complex and complete ecology. A multifaceted society has evolved in the spires that dot the back of the craft. Members of that society have developed their own unique views and attitudes regarding both the *Spelljammer* and newcomers from other worlds.

All living creatures on board the *Spelljammer* are affected by its air envelope and, as a result, are disposed in a friendly fashion toward the ship and will resist harming it. They will otherwise act in a normal fashion among themselves (and toward each other). Beholders will still hate other subspecies of their race, gnomes will still engage in dangerous experiments, giff will still fire their guns, and neogi will still attempt to own everything (and everyone) they can.

The behavior of those who live on board the ship is further altered when it comes to matters regarding the *Spelljammer*. No one will attempt to leave, help someone to leave, or purposefully harm the *Spelljammer*. They are not physically restrained from doing such activities, but the magic of the air envelope is such that no one would actually think of leaving the *Spelljammer* or of harming it. Suggestions to either end would be met with disbelief or even wild-eyed rejection.

This refusal to harm the *Spelljammer* is the reason behind the lack of new construction outside the citadel area and, to a lesser degree, the reason for the few attempts to take over the *Spelljammer*. The inhabitants are not aware that the *Spelljammer* is a living thing, though that is a theory (one of many) of some on the ship. They are aware that outlanders come from time to time and that occasionally one of them becomes—through mysterious and arcane means—the captain of the ship. Thereafter most inhabitants forget the existence of the captain as he or she rarely influences the day-to-day life of the ship's inhabitants; conversely, the captain's actions may make their lives easier or tougher if so desired.

The refusal to harm the *Spelljammer* or let it come to harm does not extend to other inhabitants aboard the great ship, nor does it extend to the *Spelljammer's* shivaks. But full-scale wars tend to set nearly everyone against the aggressors. Most races

also tend to stay out of the way of the shivaks as well, since attacking one only brings more and the shivaks do perform necessary maintenance tasks.

Almost all of the inhabitants of the *Spelljammer* are aware of the great ship's need for a captain. Their histories tell them that from time to time new captains appear, some coming from the farthest of the four corners of the Known Spheres to run the ship. The inhabitants are not aware, however, of the *Spelljammer's* requirements for its captains or of the need for the captains to possess an ultimate helm. In fact, some individuals have attempted to claim the captaincy, only to be turned down by the ship because they did not have an ultimate helm.

The test for a true captain is simple: The ship goes where he or she wants it to go. If it does not do so on a regular basis, then that person is not the captain, and any captain privileges are renounced.

Since captaincy grants other privileges (such as access to portions of the ship otherwise not available to mere inhabitants), it is fairly easy to identify the new captain. Arcane does have this information, and he has sold portions of it to two other individuals. In addition, the Lost Captains (former captains of the *Spelljammer*) in their prison and the Fool are aware of what needs to be done to become captain.

All the living races aboard the ship share an intense dislike of the undead in whatever form they take. This is due to both the threat posed by the Fool and the fact that the *Spelljammer* cannot detect the undead. This dislike of the undead extends to the practice of the ship's inhabitants burning or destroying their dead's physical forms, lest the bodies fall into the hands of the Fool.

The races inhabiting the *Spelljammer* all have their particular areas where they feel most at ease. The major races have taken over a complete tower or building complex as their own. Lesser or related races often share space with their cousins; other races do not appear on the *Spelljammer* in large enough numbers to acquire their own colony. For example, members of the k'r'r'r have been found on the *Spelljammer*, but they rarely live longer than a year before they sicken and die because they are no long-

The test for a true captain is simple:
The ship goes where you want it to go. If it doesn't,
you're not the captain.

THE GRAND TOUR

er in contact with their unity fleets.

Each entry in this section notes the district (either citadel region, ship's region, or wing warrens), inhabitants, and usual leader. (The leaders have individual write-ups in the section in this book on "Personalities of the *Spelljammer*.") In addition, there are entries for activity, morale, and armament.

Activity, an indication of how busy an area is, is measured by how likely an encounter in that area will occur. Degree of activity is defined as follows:

- *None*—no activity at all from inhabitants or shivaks. Characters in these areas will likely be alone except for preplanned encounters.

- *Light*—infrequent activity. Inhabitants come and go, but characters may be left alone for a long period of time. Areas without inhabitants will have a chance of being frequented by other adventurers or inhabitants of other towers. Characters can go for up to several hours without encountering inhabitants. Roll random encounters once every three turns.

- *Moderate*—frequent activity. There is usually someone present in the area at any time. Roll random encounters once every two turns.

- *Heavy*—constant activity. Inhabitants are everywhere, bustling about. Roll random encounters once every turn.

Morale is a reflection of the morale of both the inhabitants and their trained troops. Unarmed inhabitants will have a morale of -3 from that of the troops'.

Armament indicates the "house weaponry" of the tower or area. Many citadels have their own light ballistas and catapults. A note of "individual" indicates the typical weaponry an individual might carry.

The *Spelljammer* is essentially divided into three main districts: the citadel region, ship's region, and wing warrens. The citadel district consists of the large structures on the *Spelljammer's* back, the out-buildings on its wings, and the homes of most of the ship's inhabitants. The ship's region consists of those areas restricted to outsiders (either always or at one time or another); these are used by the *Spelljammer* itself. Such areas include the gardens, the shivak production terminal, the "sting" of the

Spelljammer, the mysterious bridge of the ship, and the captain's quarters. The warrens include the remaining areas of the ship's body, which is a porous surface laced with passages and cross-passages. This is the region of outlaws and undead, and it is the domain of the *Spelljammer's* greatest foe, the Fool.

Each area is given a number that corresponds with the same number marking its location on the large map enclosed within this boxed set. The citadel region includes the following areas:

- 1) Landing deck
- 4) Council chambers
- 5) Captain's quarters
- 6) Ship's stores and market
- 7) Captain's tower
- 8) Library tower
- 9) Human collective
- 10) Chalice tower
- 11) Tower of thought
- 12) Tower of trade
- 13) Guild tower
- 14) Halfling community
- 15) Shivak terminal (also part of the ship's region)
- 16) Illithid tower
- 17) Goblin alliance quarters
- 18) Building of the giff
- 19) Communal Church
- 20) Old wizard's lair
- 21) Gnoll ruins
- 22) Minotaur tower
- 23) Ogre wizard quarters
- 24) Beholder ruins
- 25) Dwarven citadel of Kova
- 26) Free Dwarves tower
- 27) Neogi tower
- 28) Hulk tower
- 29) Giant tower
- 30) Shou tower
- 31) Arcane's tower
- 32) Tenth Pit
- 33) Long Fangs' tower
- 34) Academy of Human Knowledge
- 35) Old Elvish Academy
- 36) Elven High Command

The great ship is essentially divided into three main districts:
the citadel region, ship's region, and wing warrens.
Beware the wing warrens!

THE GRAND TOUR

The ship's region includes the following areas:

- 2) Gardens
- 3) Smalljammer strips
- 15) Shivak terminal (also a part of the citadel region)
- 37) Armory
- 38) Dark tower
- 43) Control room

The wing warrens include the following areas:

- 39) Batteries
- 40) Dracon tower
- 41) Centaur tower
- 42) Warrens

1) The Landing Deck

District: Citadel region

Inhabitants: None

Leader: None

Activity: Light

Morale: N/A

Armament: None

The large open region found directly behind the *Spelljammer's* head serves as a combination landing field and parade ground for the ship. This is the largest open area in the citadel district, and it is used on those rare occasions when there are large meetings of the assembled races. It is also used as a battlefield to attack invaders.

Ships landing anywhere on the *Spelljammer* will be attacked and dismantled by the shivaks. Those landing on the landing deck will be untouched for 1–4 days before they are assaulted, and those landing elsewhere will survive for only 1–4 hours before coming under attack. Part of the shivaks' duties is to keep the *Spelljammer* clean of debris—which includes invading craft.

After 1–4 days (1–4 hours elsewhere on the ship), 2–12 shivaks will appear and begin destroying the invading ship. If attacked, the shivaks will summon reinforcements as described in the "New Monsters" section in this book. If unopposed, the shivaks will

destroy one hull point per shivak per turn until the ship is destroyed. Perishables go into the ship's stores, and building materials are converted into new shivaks. The spelljamming devices used by the ship are also used to produce new shivaks (one spelljamming helm can be cannibalized to make up to 10 new shivaks). Living creatures are ignored by the shivaks unless they attack the shivaks.

The landing deck is made of the same hard chitinous material as is the rest of the citadel district; thus it can be considered hard stone for the purpose of individuals carving it or crashing into it. The deck is surrounded by a low railing, about 3 feet high, also of this material.

The landing deck is regarded as "neutral territory" among the inhabitants of the *Spelljammer*; as such, prearranged duels, battles, carnivals, and other meetings that require open space occur here. To the stern are the council chambers (Area #4) and the ship's stores and market (Area #6). Directly beneath the landing deck are the gardens (Area #2).

2) The Gardens

District: Ship's region

Inhabitants: Lizard men

Leader: Arvanon the Lizard Priest

Activity: Moderate

Morale: 17

Armament: Individual

The largest interior region of the *Spelljammer* is the gardens, a huge vault that dominates the central body of the ship. The gardens are a verdant, well-watered jungle rich with fruits and vegetables, and they are tended by the lizard men of the *Spelljammer*, who claim this area for their own.

The gardens are 500 feet wide and 700 feet from end to end. This area begins immediately behind the head of the *Spelljammer* and runs two-thirds the length of the ship, beneath many of the towers on the *Spelljammer's* back. The ceiling height varies but averages 150 feet from floor to roof. Full-sized, mature trees grow within the *Spelljammer's* gardens.

The gardens are the largest interior region of the ship—
a vast area of verdant green.
This jungle is tended by religious lizard men.

Area 2 - The Gardens

One square = 10 feet

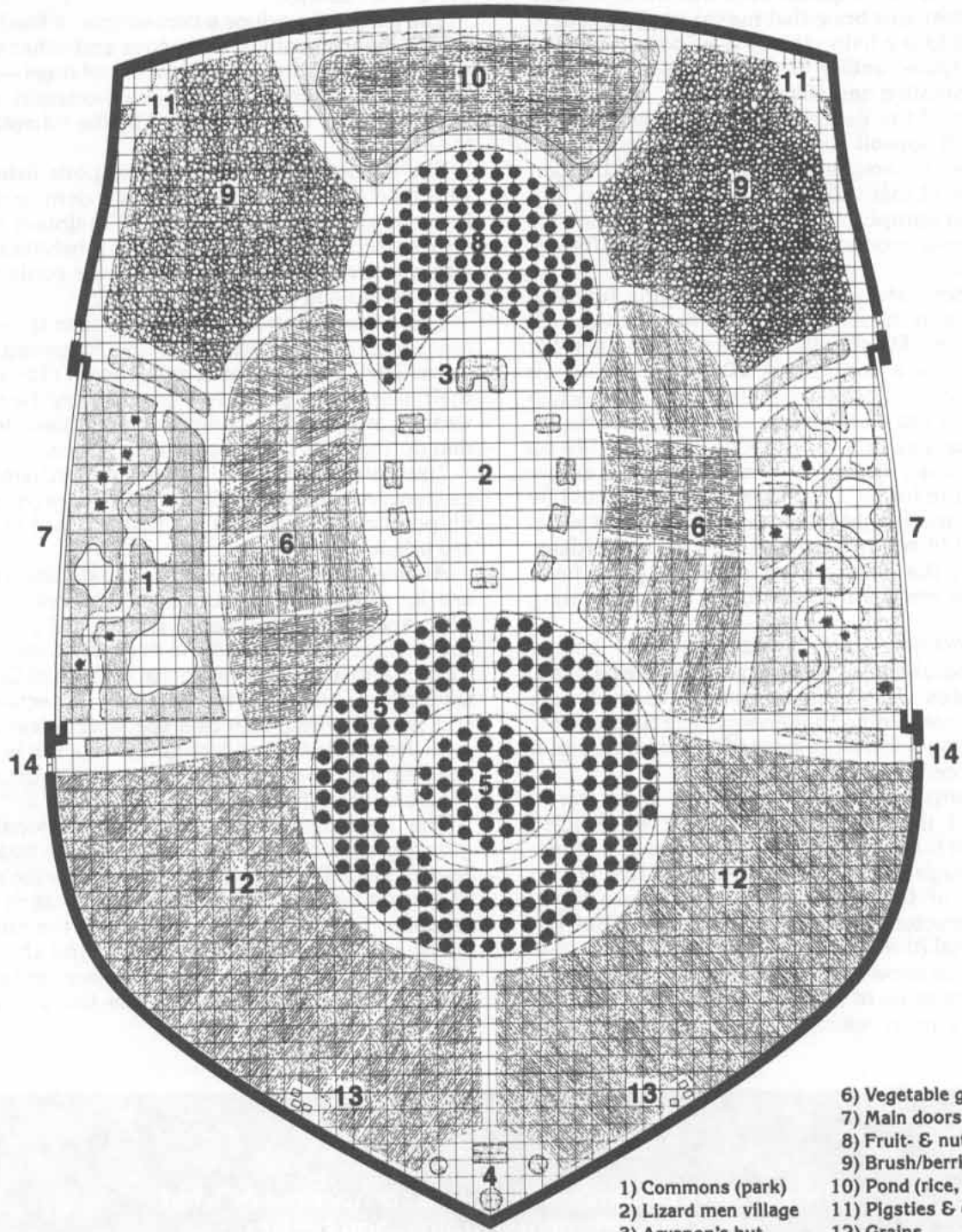

- 1) Commons (park)
- 2) Lizzard men village
- 3) Arvanon's hut
- 4) Lizzard men outpost
- 5) Jamerry trees
- 6) Vegetable gardens
- 7) Main doors
- 8) Fruit- & nut-bearing trees
- 9) Brush/berries
- 10) Pond (rice, fish)
- 11) Pigsties & compost
- 12) Grains
- 13) Apiaries
- 14) Lesser doors

THE GRAND TOUR

The walls are made of the hard, leathery material found throughout the remainder of the craft, and this material covers an impenetrable thickness consisting of the chitinous bone that makes up the citadels. Since the ship is a living thing, this "bone" is analogous to a spine; unlike other animals, however, it does not contain a nervous system.

The floor of the gardens resembles hard-packed earth, a rich topsoil running down 10 feet before striking the chitinous shell that surrounds the gardens. Some of this soil is from various worlds, but most of it is composted from dead plants from the gardens, waste products, and the remains of former inhabitants.

The gardens are well lit, as if enjoying full daylight, thanks to the luminous cells that line the ceiling of the craft. These cells, each a plate about a foot across, run on a continuous 20-hour cycle of 10 hours on high, followed by a 10-hour "night" when the plates dim to a bluish hue similar to moonlight. This 20-hour day sets the standard for daily life on the *Spelljammer*, and all other creatures have adapted to the time frame. Creatures that are affected by sunlight or moonlight (such as vampires and werewolves) would suffer similar effects in the gardens. In addition, the cells do not generate great heat, though they are warm to the touch when operating on high.

The *Spelljammer* is believed to transfer energy from fire bodies and suns to the plates while basking, and the plates and chitinous spine serve as storage devices for containing that energy. The *Spelljammer* has a seemingly limitless store of this energy, and it has never been without it.

The gardens provide food, water, and air for the inhabitants of the *Spelljammer*. The air is recycled through this huge complex and passed to the air envelope through the gill-like membranes that are on either side of the gardens. These gills are thick, sievelike structures that allow air to pass, but not solid material (the sieves are incredibly fine).

The gills do allow water vapor to pass, and this vapor provides some of the water needs of the inhabitants. While most water is distributed and traded

with food, additional water may be gained by solar stills that are in operation in many of the towers of the citadel district.

The gardens produce a cornucopia of food: dates, apples, pears, grain, rice, berries and other organic foods, along with a limited amount of meat—usually herds of wild pig and tapir. Such foodstuffs provide the bulk of the food consumed by the inhabitants of the ship.

The gardens are tended by religious lizard men who hold that the *Spelljammer* is a demilord of the heavens and that their duty is to maintain the balance of the ship. Thus, because the inhabitants of the citadel district are a part of the ship's ecology, they must be fed and maintained as well.

These lizard men have similar stats to those in the *Monstrous Compendium* with the following exceptions: Their intelligence is exceptional (15–16), and their alignment is neutral good. They have been weaned away from relying on human flesh for their diet during their long exposure in space.

There are an estimated 350 lizard men living in the gardens. An additional 35 patrol leaders (maximum hit point creatures) form the honor guard of the lizard priest.

Arvanon the Lizard Priest has the statistics of a lizard king from the *Monstrous Compendium*, again with exceptional intelligence and neutral good alignment. He is a shaman of the combined nature pantheons, and he has access to the spheres of Creation, Divination, Guardian, Necromantic, Protection, Sun, and Weather. Treat him as a specialty priest of 13th level. He is aided by a dozen acolytes of 9th level who have similar spell abilities. (Arvanon is detailed in "Personalities of the *Spelljammer*," below.)

The lizard men of the gardens are responsible for growing and distributing all food on board the *Spelljammer*. The priests are informed by the shivaks of the number and amount needed by each citadel complex. Enough food is provided for the minimum needs of the citadel's inhabitants, and the rest is placed into ship's stores or sold at market for steel, compost, or other goods that the lizard men may need.

**The gardens produce a veritable cornucopia of food:
dates, apples, pears, grains, and berries.
In addition, wild pigs and tapirs graze in the gardens.**

THE GRAND TOUR

The chief priest and his white-robed acolytes may not be attacked in accordance with a general understanding established between the other races and the lizard men.

If the priest or his acolytes are attacked, the lizard men have permission from the ship to withhold food from the race whose representatives were involved in the attack. Such withholding continues until the ones responsible are turned over to the lizard men. (Tales circulate among the citadel dwellers about how the lizard men give in to their cannibalistic urges when forced to mete out justice.) This permission to punish offenders does not protect all lizard men, of course—only the priest and his acolytes during the performance of their duties.

The gardens are considered an open area for all inhabitants of the *Spelljammer*, though only the lizard men may make it their home. Humans, elves, and halflings tend to make their visits during the day, while mind flayers tend to visit at night. These races, under the lizard men's direction, also help tend the gardens. The dwarves and the neogi, both of whom have no great love of nature, are rarely seen in the gardens.

When a new captain first comes to command the *Spelljammer*, the gardens are closed; for the ship's inhabitants, this is the beginning of the Dark Times. At this time new plants push up from the soil, looking like great weeping willows sporting white flowers and, at the same time, bearing huge red fruit. The flowers produce the seeds that will eventually become ultimate helms, while the fruit encases the future smalljammers.

During this construction period, the gardens are banned from all nonlizard men, and any others found within the area are immediately ejected (or slain if they resist). The lizard men know of the growth of the smalljammers, but they are forbidden from speaking of it to nonlizard men—this is a holy order fanatically adhered to by all.

During this period the other inhabitants must survive solely on their stored goods and whatever one race can glean from another. Food riots and battles between citadels often erupt (hence the rationale be-

hind the term of Dark Times). Water distribution also halts at this time, but the air escaping through the gills becomes heavier with water, possibly because of the new plants growing in the gardens. Dew is thus common, and solar collectors (little more than clear membranes to catch the water) help the inhabitants survive with this basic necessity.

At the time of the Flight of the Smalljammers, the "doors" (actually louvered flaps of heavy flesh) open to let the small ships fly free of their parent. The smalljammers disperse to the far corners.

After the Flight of the Smalljammers, the gardens are opened again. Those who survived the Dark Times are treated to a richness of new crops, including the leftover rind of the smalljammer "fruit," which is extremely tasty to all races. There have been reprisals against lizard men following the shutting of the gardens, but the fact that Arvanon and his priests control the bulk of the food distribution fortunately prevents full-fledged pogroms against the lizard men.

The lizard men of the gardens worship nature in all its forms, and they are on good terms with any druids they encounter (though they will still eject these druids if the gardens close). The lizard men believe that the *Spelljammer* is a living entity created by the nature gods in order to prove the superiority of their creed, even in space. The *Spelljammer* is a demi-power in their theology, which answers to all nature. These priests receive their spells while in any sphere where nature-related gods exist. When in the phlogiston or in spheres where they cannot reach their gods, the priests believe that their faith is being tested by these gods.

Arvanon is an incredibly old lizard man. He is so old, in fact, that he is the one individual old enough to remember the Fool before he became one of the undead as a master lich. Arvanon has lived through three captaincies, and he knows how to prepare his people for the closing of the gardens and the chaos it often engenders. He is aided by his acolytes, the chief among them Demets, his grandson. (Demets is detailed in the section on "Personalities of the *Spelljammer*," below.)

The smalljammers leave behind a tangy rind
after they have taken to the Flight.
This fruit is savored by all races aboard the great ship.

THE GRAND TOUR

3) The Smalljammer Strips

District: Ship's region

Inhabitants: None

Leader: None

Activity: Light

Morale: N/A

Armament: None

Four great yellowish bands mark the forward wings of the ship, giving the *Spelljammer* its distinctive markings. These are the "runways" used by the smalljammers on their flight from the gardens. The great louvered "doors" at the end of each runway are opened only when smalljammers are ready for this flight (smaller portals along the dorsal fin provide access to the gardens for the ship's inhabitants).

The runways are not inhabited, nor do any creatures build there. During the Dark Times before the actual Flight, squatters' camps will sometimes spring up outside the doors in the hopes that the lizard men will take pity and bring them food. These camps are discouraged by Arvanon's people before the Flight occurs as those camps that remain are destroyed when the smalljammers commence with their flight.

4) The Council Chambers

District: Citadel region

Inhabitants: All races

Leader: None

Activity: Moderate

Morale: As per individual race; in general 14

Armament: Individual, plus 4 medium ballistas on roof

The council chambers are the nearest thing to a government building on the *Spelljammer*, and its members are the nearest thing to a government among the various groups and races that inhabit the *Spelljammer*. The Council's quarters consist of a great amphitheater opening toward the bow, with recently installed glassteel windows overlooking the

landing deck. The rear half of the amphitheater is overhung by a great balcony, from which runs the stairs leading to the captain's quarters.

The amphitheater's stage is dominated by a row of risers and desks, one desk for each of the races aboard the ship. By common agreement, the existence of a living race on the ship implies that the race can call for representation, thus receiving a desk and the right to speak if so desired. For example, should a sprite find itself on the *Spelljammer*, it could demand to represent spritedom (despite the sum total on the ship being but one sprite), and its right would have to be recognized.

The Council can meet at any time, provided a majority of representatives show up. Each faction or race has its own member, so there are numerous human members from different citadels, while Arcane and the gnomes—though they share a citadel—have the right to two seats (being two races). The only requirement by the Council is that a representative of that race or citadel occupy its allotted seat.

In theory, the Council could form the basis for a just and representational government for the *Spelljammer*. In reality, however, it is little more than a debating society, given only as much power as its member factions permit. Since each citadel and race fears the "tyranny of the majority," none is willing to pass off its portion of power to the others. The only sure ruling to come down from the Council is the assigning of jurisdiction for settling disputes. For example, if a mind flayer is slain, the mind flayers may discover, try, and slay a guilty assailant rather than bring matters before the Council.

There have been times when a charismatic leader or captain has managed to pull together the council members into a team capable of making decisions amenable to all. This beginning of a truly stable government has occurred three times during the past decade. Each time has brought about mutually beneficial agreements—until a genuinely difficult or controversial decision was to be made. At such points, all the members who disagreed fled the council chambers and ignored the rulings until the government fell.

The Council could be the basis for a truly permanent and stable government aboard the *Spelljammer*, but instead it is rife with conflicting factions and races.

THE GRAND TOUR

All living inhabitants of the *Spelljammer* are welcome to witness the debates and dealings, though mostly humans, halflings, and gnomes spend any prolonged time watching the arguments. Elves find this method of government too blunt, and dwarves find it too delicate and imprecise. The mind flayers support the Council, but they think it would function better under an illithid leader granted veto power. And neogi tend to ignore the Council, save at times when they want to extend their jurisdiction and claim the right to attack others. At such attempts, both neogi and umber hulks cast their votes, and they always vote the same. (Little wonder since the umber hulks are the neogi's slaves.)

The voting to determine jurisdiction for an action or assignment is by majority. Voting to create new committees, leaders, and so forth, in theory, requires a unanimous vote from all representatives—which, needless to say, has proven impossible in practice.

The races and factions represented in the Council and their members are as follows:

- Arcane—Arcane.
- Beholders—representative chosen by Gray Eye; beholders rarely attend council meetings.
- Centaurs—Mostias.
- Chalice Tower—Grand Knight Chaladar.
- Communal Church—Father Goat.
- Dracons—Kaba Danel, leader of the dracons.
- Elves—Comander Lothian Stardawn, representative for Admiral Highstar.
- Free Dwarves—representative sent by Vagner Firespitter; changes regularly (sometimes in mid-meeting).
- Giants—Taja Deeplunder.
- Giff—"Diamondtip" Hojson.
- Gnolls—proxy given to the beholders.
- Goblins—proxy given to Trebek.
- Guild—an honorary chair; usually empty.
- Halflings—Hancherback Scuttlebay.
- Hobgoblins—proxy given to Trebek; contested by the Hobgoblin Prophet.
- Human Collective—freely elected representative; changes regularly.
- Illithids—Trebek.

- Kobolds—proxy given to Trebek.
- Kovan Dwarves—Sulfur Darkblood Kova, nephew to Lord Agate Ironlord Kova.
- Lizard men—Demets.
- Long Fangs—Selura Killcrow; in title only because no one actually uses this seat.
- Minotaurs—Hammerstun Breakox.
- Neogi—Master Coh.
- Ogre mages—ShiCaga the Enchantress or one of her two sons.
- Ogres—proxy given to the ogre mages.
- Shou—Nagasimi, representative for Si Loo.
- Tenth Pit—Korvok the Fell; rarely attends.
- Tower of Thought—CassaRoc the Mighty or his representative.
- Tower of Trade—Chila Irontooth or her representative.
- Uumber hulks—Orik, personal servant to Coh.
- Wemics—Webber, leader of the wemic clan.

The closest thing to a leader of the Council is Demets, primarily because his people and his grandfather control the food supply. The elvish and mind flayer factions are also strong. And when Arcane attends, he is always given the opportunity to speak.

Factions tend to break down along alignment and racial lines. Elves and good humans; mind flayers and neogi (when they show up); the gnomes supporting Arcane; and the wemics, centaurs, and dracons tend to be the typical divisions, with other races aligning themselves with those most closely meeting their present viewpoints.

Only living, sentient races gain a seat on the Council. The shivaks do not have a seat as they are mindless extensions of the great ship's will, nor do the undead, such as the Fool, have a seat. The captain is accorded a seat on the Council, but he or she is not granted any powers above those of other representatives. (This was not always the case. An earlier council had given the captain veto powers, but the resulting tyranny killed half the races and the *Spelljammer* was forced to reject that captain. In the only case of unanimous acclamation, the Council reduced the powers of the captaincy in council to no more than that of any other representative.)

All races and factions are represented in the Council—
from arcane to human, illithid to wemic.

Areas 4 & 5

One square = 10 feet

Council Chambers

Captain's Quarters

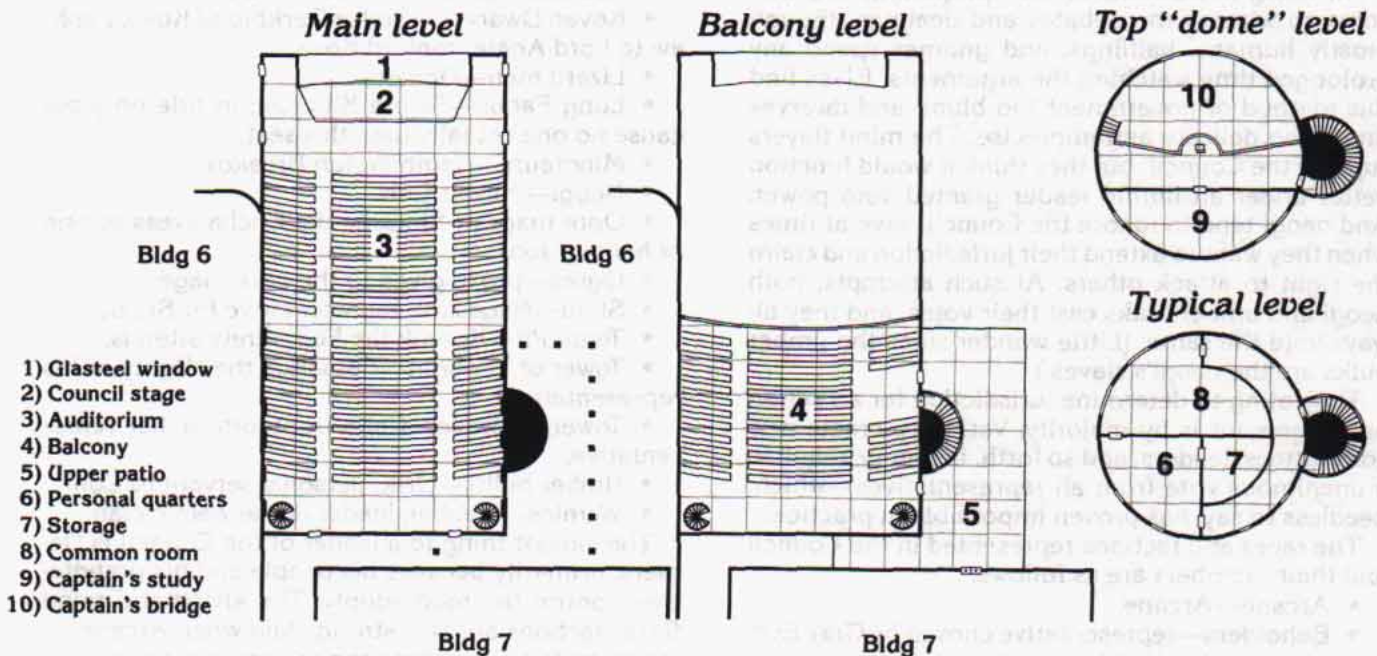

5) The Captain's Quarters

District: Citadel region

Inhabitants: Either none or the captain

Leader: Either none or the captain

Activity: Either none or light

Morale: Either N/A or as per the captain

Armament: Either none or as per the captain

The most forward of the living quarters on the ship are reserved for the captain of the *Spelljammer*. This tower, rising from the roof of the council chambers, is usually empty since the *Spelljammer's* inhabitants survive quite nicely without a captain.

The captain's quarters are sumptuously furnished in the style and manner of the captain's taste. The *Spelljammer* learns from its bonding with the captain what he/she/it prefers and then brings those materials from the stores (or has them created) in order to make the captain happy. If the captain has a taste for traditional wines, grapes will begin to grow in the gardens. If he or she likes handcarved tables and chairs, such furniture will appear as well (carved from the remains of wooden ships scavenged by the *Spelljammer*). Magical and unique items that are beyond the scope of the *Spelljammer* to provide will be respectfully denied.

The food for the captain's quarters and the captain's tower (Area #7) is provided directly by the shivaks and is untouched by sentient hand. The captain (unless of lizard man stock) is prohibited from the gardens during the creation of the smalljammers, but he or she will continue to receive shivak-delivered food from the stores for as long as supplies hold out.

The captain's quarters are only accessible when a captain is in residence. Otherwise the doors and windows are locked, and those breaking in will be ejected immediately by shivaks. When there is a captain present, the captain is allowed to decide who may and may not enter the quarters. For player characters, create a "pass list" of those individuals who are granted free access. Other characters will be barred



THE GRAND TOUR

and ejected from the quarters unless they appear with someone who has been granted access. (Which means that if a friend turns on a captain, he can bring his own assassins with him and the shivaks will let him pass—the *Spelljammer* operates under the premise that the captain knows best when dealing with his or her friends.)

6) The Ship's Stores and Market

District: Citadel region

Inhabitants: All races

Leader: The steward (Old Astor)

Activity: High

Morale: As per individual race (in general 8 in market, 15 in stores)

Armament: Individual

The ship's stores are contained in one of the largest buildings on the *Spelljammer*, sitting amidship directly astern of the landing deck (Area #1) and adjacent to the council chambers (Area #4). The stores rest on 30 pillars made of the same tough material as the rest of the ship. Beneath the stores, in the open area around the pillars, is the marketplace of the *Spelljammer* where all public commerce is conducted.

The market is a hodgepodge of temporary booths and sleeping blankets, lit from above by scattered cells from the gardens. Almost any common item available on the *Spelljammer* can be found here—food, water, swords and other weapons, talismans of protection against the Fool, jewelry, and so forth. Rarer items, such as magic, books, information, and spelljamming helms, will not be found here, but this is the place to initiate a search for who has them and what they want for them.

Each race has an allotment of food and water, as determined by the shivaks and delivered by the lizard men. The quantity is sufficient for basic needs, but is by no means excessive. Any extra food and water beyond the allotments finds its way to the market, where it is traded for other needed goods. Some citadels maintain standing trades, and there is usu-

ally enough excess food and water during good times to keep the market a lively place.

Trading is busiest between mid "day" and mid "night" for the market beneath the pillars, but there are often merchants in the marketplace at all times. One of the concessions in the market that is continually open is the Open Air Public House. The Open Air was formed three years ago as a result of a contest between various would-be brewmasters in the citadels. The contest was supposed to determine which race could distill the most potent starmash from the available resources. The result was a four- or five-way tie (the details are fuzzy on this point), and the "winning" citadels formed a communal bar—it operates in addition to a number of taverns and drinking holes throughout the ship. The Open Air is owned by Kristobar Brewdoc, the halfling assistant to the steward, and it is open to all races.

The ship's stores, situated directly above the market, include the supplies, dried food, and interesting items that have been collected by the shivaks and put into storage in preparation for the Dark Times. Surplus fruit and grain are dried and placed within the stores so the inhabitants of the *Spelljammer* can be given rations during the periods when the gardens are closed. There is usually sufficient foodstuffs within the stores to feed everyone on the ship, provided all go to half rations. During the Dark Times, it is the responsibility of the steward to regulate the flow of food from the stores.

The stores are also used for storing interesting and/or dangerous items discovered by the shivaks, usually brought to the ship by spacefarers or objects falling into the ship's atmospheric envelope. Spelljamming helms that have not been converted into new shivaks and magical items that no other faction has managed to snare will end up in the stores, placed there by the shivaks. Usually these items are found by the steward and thenceforth "re-routed" into hands that can use (and can pay) for them. The DM may choose to play any one magical item he or she wishes in the stores as being currently "in circulation" or may roll randomly from the magical item charts.

The ship's stores hold surplus grain and dried foodstuff in preparation for the Dark Times, and most everyone can survive—provided they can live on half rations for several weeks.

Area 6

Ship's Stores and Market

One square = 10 feet

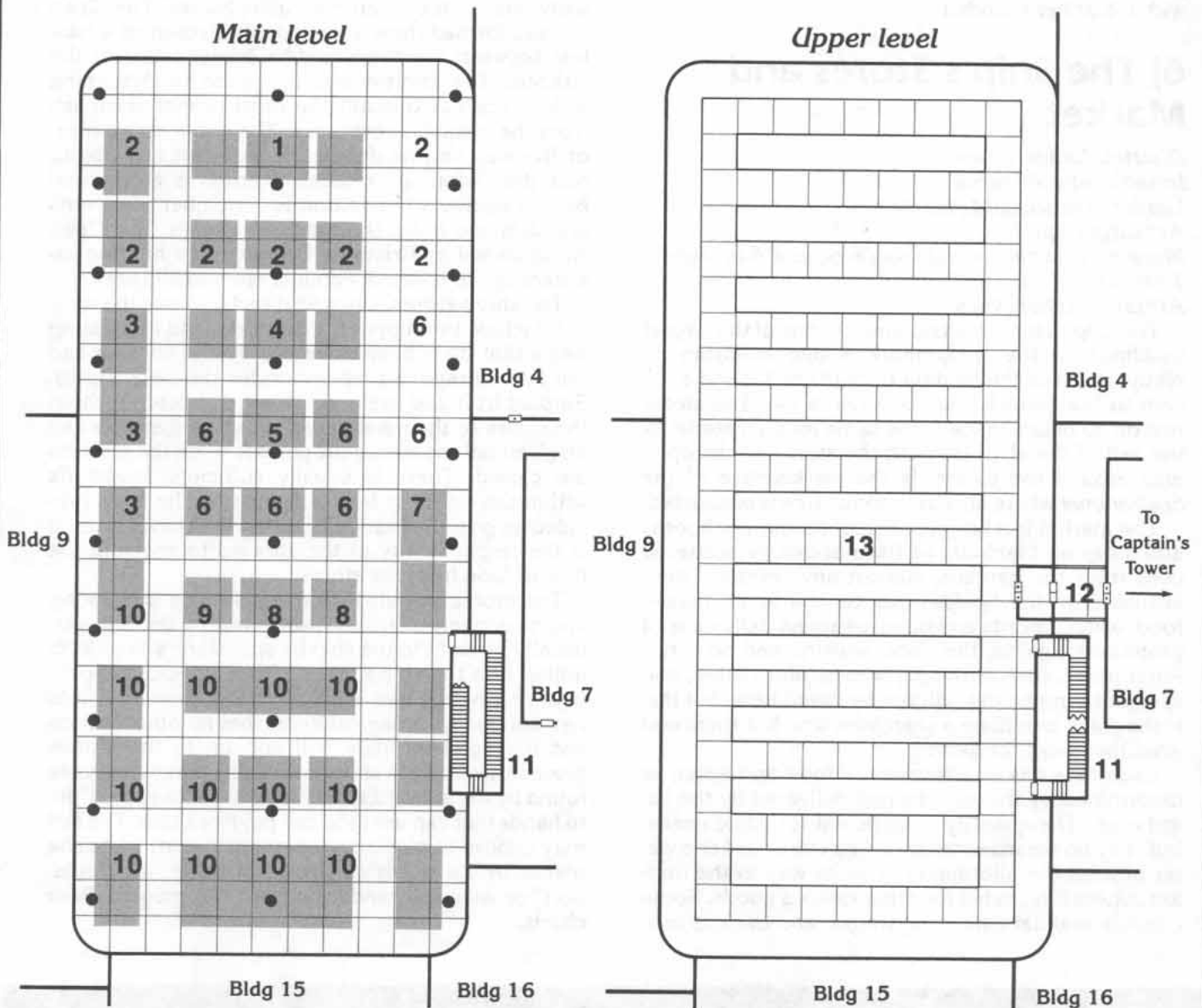

- 1) Open air public house
- 2) Food stalls
- 3) Jewelry
- 4) Dwarvish weapons
- 5) Dwarvish art
- 6) Crafts
- 7) Gnomish crafts

- 8) Sundries
- 9) Charms & fortunes
- 10) Transient owners
- 11) Stairway
- 12) Captain's passage
- 13) Upper warehouse

THE GRAND TOUR

The current steward is Old Astor, a blind beholder who is aided by his "seeing-eye" halfling, Kristobar Brewdoc. (Both Astor and Kristobar are listed in the "Personalities of the *Spelljammer*" section, below.) Astor has a lingering disease that prevents him from using most of his eyes. He may still see, but his fellow beholders consider him a travesty of "true" beholder life. When Astor became ill, he was driven out by the other beholders on the ship, and he would have been slain outright if he hadn't been provided with his post by the Council. (Actually, the Council had delegated the task of appointing a steward to the halflings, who were setting up the Open Air at the time. The halflings found Astor cowering behind some barrels and trying to hide from his fellow eye tyrants. They appointed Astor as steward on the spot. Their logic? Astor was all that was needed for the post because he could keep an "eye" on things.)

In any event, the beholders do not wish to court censure from the other races by having Astor slain, thus he survives by the will of the Council. But even so, when there are other beholders in the market, Astor remains in the stores "taking inventory."

One or more of Astor's eyes still operate to some degree. He has demonstrated that his telekinetic eye does work, and all assume that his antimagic ray is still in operation. The remaining eye functions are open to guesswork.

Astor is on good terms with the halflings, who regard him as a sort of mascot for their various enterprises in the marketplace, and they treat him as a revered old grandfather. This may be a mistake on the halflings' part because Old Astor has his own plans fomenting against his former citadel-mates.

Astor knows that one of the first things to happen should the *Spelljammer* gain a new captain is that the gardens will close. The second thing likely to happen will be a storming of the stores by one group or another. Astor dreads the appearance of any new ships and visitors to the craft. Through his halfling assistants (Kristobar and the Open Air gang), he seeks to divine visitors' intentions and their chances for seizing control of the ship.

7) The Captain's Tower

District: Citadel region

Inhabitants: Either none or any

Leader: Either none or the captain

Activity: Either none or high

Morale: Either N/A or as per the captain

Armament: Either none or as per the captain

The captain's tower is a low, squat complex adjacent to the captain's quarters (Area #5) and the council chambers (Area #4). This tower is reserved for the captain's staff and retinue. As captains often come with their own team of advisors (usually in the form of fellow adventurers who accompanied the prospective captain to the *Spelljammer* in the first place), these quarters are set aside for their use and are only accessible when a captain is in place.

As with the captain's quarters, the captain's tower is furnished according to the tastes of the captain (which may or may not coincide with the tastes of the captain's comrades). An elevated walkway connects the captain's tower to the stores—the walkway has a separate (usually locked) entrance. Using this walkway and entrance, food and material can be brought directly to the captain and his or her advisors without passing through the market.

This tower is also connected to the captain's quarters by means of a spiral-stair tower adjacent to the council chambers. This second means of access often permits a captain to get into or out of his or her quarters without detection.

When a captain is not in residence aboard the *Spelljammer*, the shivaks protect the tower in much the same way as they do the captain's quarters. Once a captain has been installed, however, all such vigilance ceases—the captain is left with only his or her advisors to provide protection. (The shivaks remain, however, in the spiral-stair tower to guard the captain's private quarters.) As a result, many individuals seeking help from the captain often descend upon the inhabitants of the captain's tower in order to gain the ears of those who in turn have the ear of the captain.

The Open Air Public House is a favorite watering hole aboard the *Spelljammer*. It came about as the result of a brewmaking contest. (The halflings won.)

Areas 7 & 8

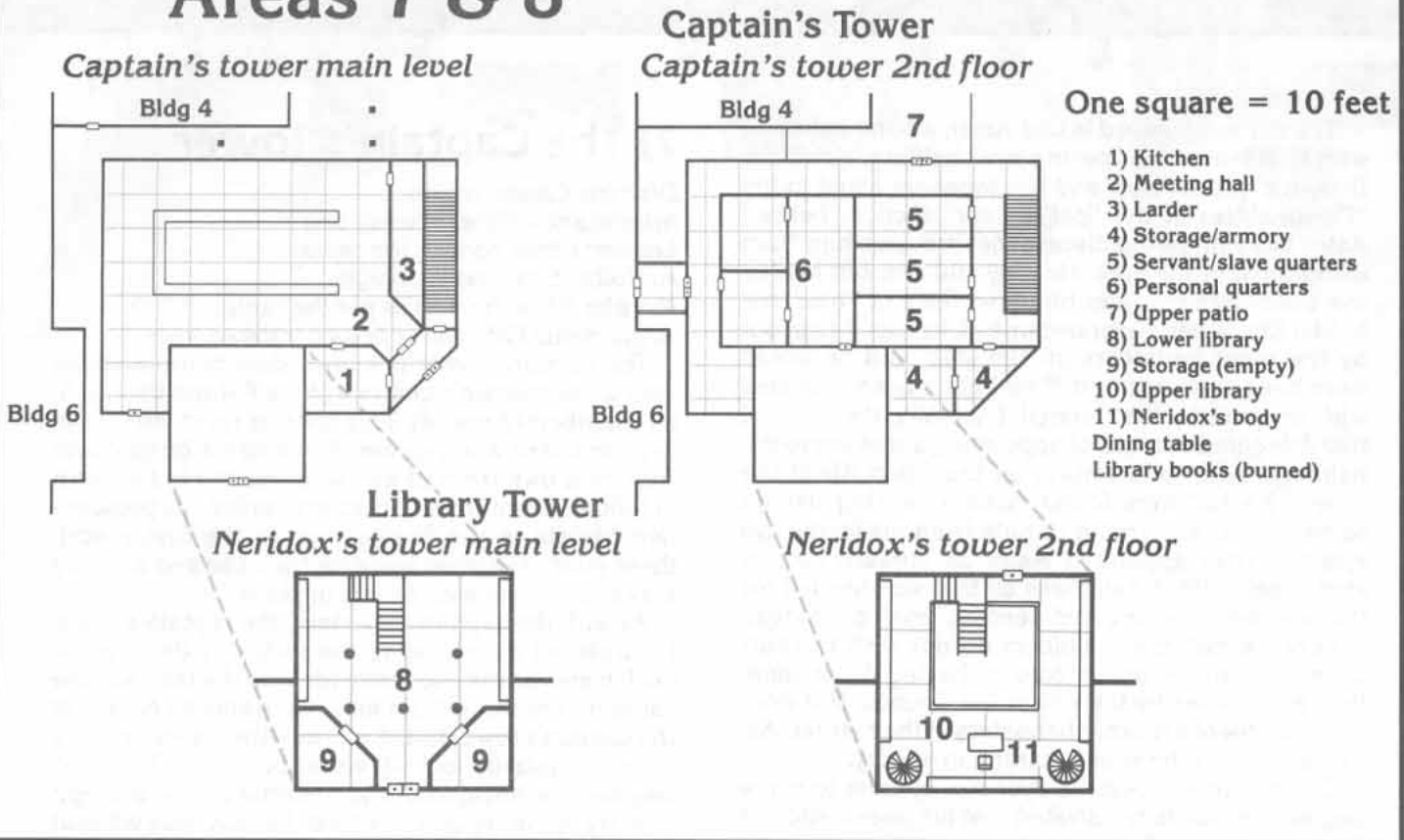

8) The Library Tower

District: Citadel region

Inhabitants: None

Leader: Neridox (believed alive but in fact dead)

Activity: None

Morale: N/A

Armament: None

Adjacent to the captain's quarters and officially a part of them is the library tower. Once originally erected for a particularly literate captain's wizard, the tower remains intact to this day, now protected by the shivaks and supposedly containing the accumulated knowledge of the previous captains of the great ship.

A more recent tale surrounding the library tower arose during the captaincy of the last captain, Jokarin the Bold. When Jokarin proved unfit to run the *Spelljammer* and was expelled by the great ship, his chief wizard, Neridox, sealed himself up in the library tower and protected it with dire traps and fell magics, such that even the shivaks do not enter. The wisdom of all the former captains is supposedly still there, along with Neridox, who found the answer to life eternal within the tower.

Attached to this tale is the prophecy that anyone entering the library tower will raise the wrath of Neri-

dox's spirit, which will join with the undead of the ship's warrens to lead them in an attack against the living.

Such are the tales, available for the price of a brew at the Open Air Public House. Tales such as these two, however, have kept the library tower sealed since the time of the last captain.

The truth of the matter is that Neridox is dead. He was killed by the mad Arcane when the shivaks stormed the captain's tower to remove Jokarin. Arcane then took what books he could from the tower, set the library ablaze, and sealed the building as best he could when he left.

Anyone actually breaching the tower will find Neridox's smoke-mummified body still in his chair, the dagger that killed him sticking between his ribs. He is not undead, of course, but simply dead. The fire burned all the books to ash, but the flames were contained within the building, and the tower is essentially intact. The manuscripts and texts were burned so badly, however, that although the spines still hold the ashen pages the words will fly into pieces at the slightest touch.

At the DM's option, there might be a magical scroll or tome untouched by the blaze. Either choose one or roll randomly from the tables found in the *Dungeon Master's Guide*.

THE GRAND TOUR

9) The Human Collective

District: Citadel region

Inhabitants: Humans

Leaders: Various

Activity: High

Morale: 12

Armament: 10 light ballistas throughout the complex; 10 more can be assembled within 6 turns

The main center of human activity aboard the *Spelljammer* is a collection of buildings adjacent to the stores and market. Known as the Collective, the center contains a wide variety of humans from different worlds and cultures, united together by their common denominator (being human), although deeply divided by their factions and differences—a difference each is quick to point out.

The Collective consists of a number of different towers joined together with a common base. Each tower is considered a separate entity by the Council, as is the base building. The bulk of humankind—traders, craftsmen, gardeners, and so forth—may be found in this building. The three towers that rise from the bow end of the base building are occupied by three of the five major mercenary brotherhoods of the void: the Company of the Chalice (Area #10), the Pragmatic Order of Thought (Area #11), and the Trading Company (Area #12).

The topmost floors of the large tower that rises out of the center are occupied by the Guild, the humans' petty nobility (Area #13). In addition, the halfling quarters (Area #14) are considered part of the Collective even though the halflings are another race. Finally, the Shou are technically considered part of the Collective, but they rarely have any contact with other humans.

There are about 800 men and women in the Collective. When added to the 150 in the military towers, another 200-some in the Guild, and the other humans scattered throughout the remaining outposts, this number makes humans the single largest race on the *Spelljammer*. Its control in the Council would be domineering were it not for the

deep divisions existing between the factions and human towers.

The Collective is divided into 10 floors, each floor having its own militia, family organization, and representative to a human-only council. In reality it is the merchants who profit from the nearby market and who generally run things, and the Collective's representative in the ship's Council can usually be counted on to vote in favor of the status quo as long as business is good—or for rampant protection of their interests if business is not so good.

Humans occupy many of the trading positions in the city, and they are often used as diplomats between quarreling factions as well as mercenaries in skirmishes. The reason for these opposing positions is the variable nature of humans themselves. While not all neogi are evil and not all elves are good, the initial reaction most people have to these two races is that they are. This inherent belief makes these races less effective when dealing with those of opposing alignments. Humans, on the other hand, tend to come in all types and alignments, from self-interested to noble, from good-spirited to black-hearted. As a result, humans are valued as "coins of the realm"—anyone can deal with them.

The Collective is primarily trade-oriented. Small craft shops are nearest the stairway, personal quarters farther away. Family arguments and group skirmishes are common, but if matters grow out of hand, one of the opponents usually moves to another location on the ship. In serious cases, the Guild interferes, which is not appreciated by any members of the Collective.

The Collective raises some small crops on their own beneath the growing plates, primarily modified versions of wheat and corn that produce high yields in minimal space. In addition, the lowest floors raise sheep for both fleece and food. Clothing made from wool is one of the chief bulk exports of the Collective.

The Collective's typical reaction toward the other human groups is reminiscent of feelings generally reserved for distant cousins—linked by family if not by fortune. The Guild is generally disdained until their help is needed, and the military brotherhoods

The Collective is composed of humans and is primarily trade-oriented. Its members can be found in the market, trading and hawking their wares.

Areas 9 through 14

Human and Halfling Towers

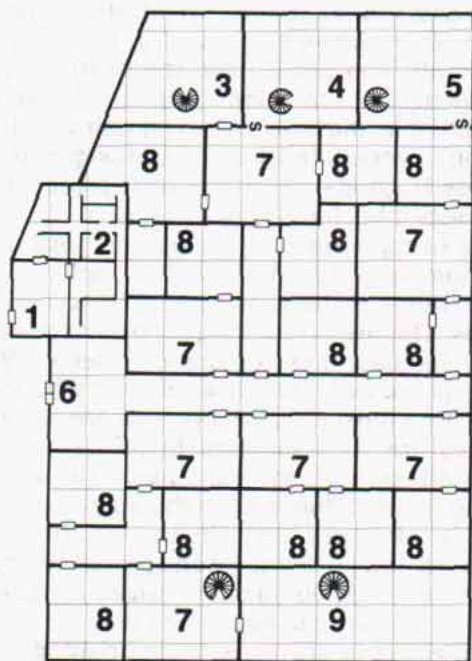

Main level

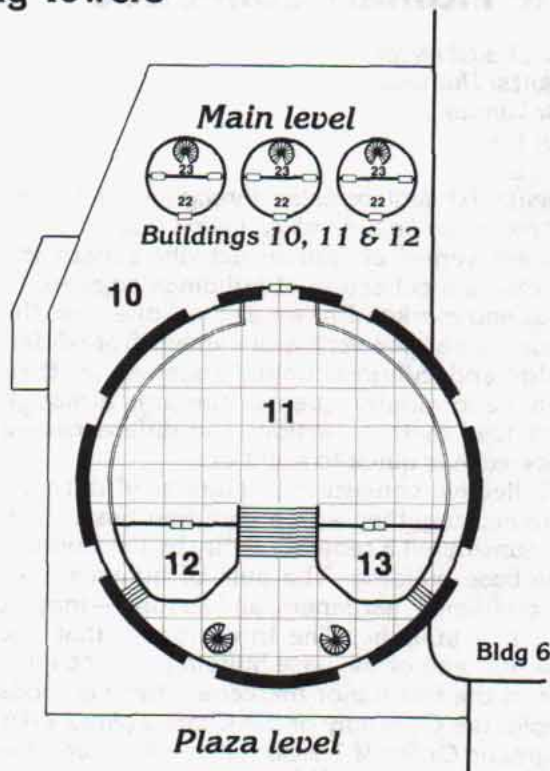

Plaza level

Buildings 10, 11 & 12



Upper level

Typical guild level

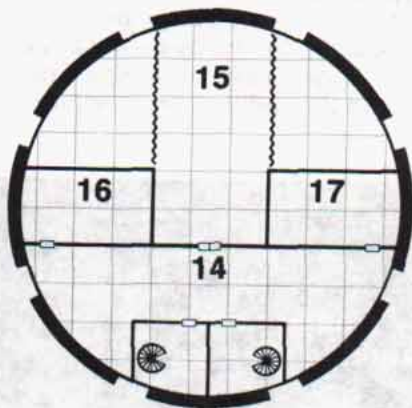

Leoster's quarters

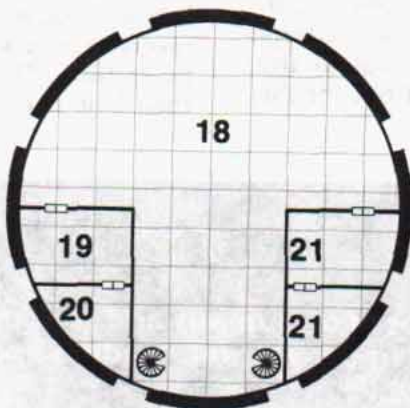

One square = 10 feet

- 1) Halfling entrance (no humans allowed beyond this point)
- 2) Halfling family quarters
- 3) Chalice Tower mess area
- 4) Tower of Thought storage area
- 5) Tower of Trade armory
- 6) Human collective entrance
- 7) Collective commons
- 8) Living quarters
- 9) Armory
- 10) Plaza of Humanity
- 11) Grand Hall
- 12) Meeting room
- 13) Meeting room
- 14) Reception area
- 15) Private noble's quarters
- 16) Servants quarters
- 17) Storage area
- 18) Leoster's audience hall
- 19) Leoster's personal study
- 20) Leoster's day room
- 21) Advisor's quarters
- 22) Tower entrance
- 23) Guards' room
- 24) Living quarters
- 25) Study
- 26) Bedroom

THE GRAND TOUR

are tolerated because they provide an added source of income through paid fighting.

Races aboard the *Spelljammer* are liked by the Collective depending on the race's nearness to the human form (and its need of humanmade products). Elves, dwarves, halflings, and illithids are steady customers and therefore "neighbors," while beholders and neogi are only intermittent customers and therefore "alien" and "dangerous."

In combat, most of the Collective should be considered as 1st level fighters. Their weapons will usually be clubs or other simple weapons. If a part of an organized strike from one of the military brotherhoods, they will be issued weapons such as daggers or swords. Humans will most likely fight only when it protects their own interests (for example, their homes or their markets).

Human strangers to the Collective will be welcomed, if cautiously. Having money to spend or goods to trade will go a long way toward earning the Collective's friendship. If the strangers stay (and there are places set aside as inns within the Collective's area), it is with the understanding that the newcomers will not "rock the boat" and that no other races are suddenly going to storm the human community looking for them. If the strangers are in trouble, the Collective will encourage them to look elsewhere for aid.

10) The Chalice Tower

District: Citadel region

Inhabitants: Humans

Leader: Grand Knight Chaladar

Activity: Moderate

Morale: 13

Armament: 2 light ballistas, 1 medium catapult

One of the five military brotherhoods of space, the Company of the Chalice is organized primarily by lawful good warriors. As a result, the chalice tower is also known as the Paladinrest, and its leader is the most powerful paladin on the ship.

The Company of the Chalice has a standing force

of some 50 male and female warriors, levels 3-18, all dedicated to the maintenance of law for the common good of humans and their allied races. They have little love of the mind flayers and beholders, and they have been actively engaged in running battles with neogi forces. The neogi and umber hulk representatives to the Council regularly complain of human ambushes—presumably set up by chalice warriors.

The current grand knight, Chaladar, deeply regrets that he cannot motivate the other humans of the Collective into a united group to purge the ship of all evil, including that of the evil human brotherhoods known as the Long Fangs and the Tenth Pit. Since his position and his duties prevent him from taking open action (he is very mindful that an outright attack could result in food being cut off to the Collective), he will be pleased if the occasional neogi is found spitted on a tower spire somewhere—anonously, of course. (Chaladar is listed in "Personalities of the *Spelljammer*," below.)

Good-aligned humans will be welcomed by the chalice tower and encouraged to join the brotherhood in its desire to purify the *Spelljammer* of evil. Delivering the body of a neogi would suffice in terms of gaining entry to this brotherhood. Chaladar's knights are loyal to their own and will often undertake daring rescues to save their followers.

11) The Tower of Thought

District: Citadel region

Inhabitants: Humans

Leader: CassaRoc the Mighty

Activity: Moderate

Morale: 13

Armament: 2 light catapults

The Pragmatic Order of Thought is a loosely banded organization of warriors that, on the *Spelljammer* at least, seems more interested in the pursuit of the most dangerous form of mead than glory in battle. They tend to view Chaladar and his chalice crew as overwrought about the natural order of things. Cas-

The Company of the Chalice and the Pragmatic Order of Thought are both military brotherhoods aboard the *Spelljammer*.

Both are of good alignment, but the second is more interested in pursuing ale than justice.

THE GRAND TOUR

saRoc's thought warriors think that nasty creatures such as neogi and beholders have a place in the universe, if for nothing else than to provide sparring partners for the humans' own best warriors.

The elite of the thought tower number about 50 warriors, levels 3–18, but will gladly arm up anyone interested in a good fight. Their lord, CassaRoc the Mighty, is much better thought of by humans in general than is Chaladar, partly because a typical comment circulating the *Spelljammer* is that "Chaladar may have the speeches, but CassaRoc has the mead."

Like Chaladar, CassaRoc is very aware of how dangerous open action is against other races. A major confrontation between racial groups in the closed society of the *Spelljammer* could mean the death of all. So CassaRoc endeavors to keep a lid on his group's level of violence, usually by finding a new target for human aggressions if tensions grow too deadly. (CassaRoc is detailed under "Personalities of the *Spelljammer*," below.)

Strangers, or "new blood" as CassaRoc calls them, are always welcome in the tower of thought. CassaRoc himself will wine and dine newcomers interested in joining the community. He will seek to get an accurate fix on a stranger's abilities and on how dangerous that individual might be to CassaRoc's own position; then he will usually suggest a test for membership. Those whom he feels are of little danger to his rule get easy tests (little more than pranks), while those who might prove very dangerous are given tests wicked enough to bring the community to a state of war if actually carried out. (Example: Bring the head of Jorivin, Trebek of the Illithids' chief advisor.)

12) The Tower of Trade

District: Citadel region

Inhabitants: Humans

Leader: Chila Irontooth

Activity: Moderate

Morale: 13

Armament: 2 medium ballistas

The tower closest to the market is occupied by the brotherhood most likely to engage in mercenary activities—the Trading Company. The Trading Company is the shadiest of the three towers surrounding the Collective, and its members are quite willing to talk to anyone on the ship interested in fighting—regardless of race, creed, or species—for the right price.

The core of the Trading Company is about 50 warriors, levels 2–20, but "invitations" are discreetly passed out to those interested in being a part of the company's number for particularly large (or dangerous) raids.

The Trading Company rarely attacks others on their own initiative—they are almost always in the pay of someone else. And for enough gold of your own, Chila Irontooth will even tell you who has bought them.

Chila is regarded as cold-blooded, her eyes glued to the ultimate bottom line of profit. In actuality, she always seeks to make sure that her opponents—if human—survive with most of their wits and numbers intact because she prefers to secure her objectives with minimal casualties. She is also known for her generosity toward the Collective's members, and she continues to foster that generosity because the Collective's admiration provides the best shield of all against reprisals.

Chaladar and CassaRoc are both openly contemptuous of Chila Irontooth and her methods, but they are also aware of the higher prices she commands by playing all sides against each other. She never lets personal alignment muddy the waters when cutting a deal.

Strangers to the Collective will be sized up by one of Chila's members, who will even go to the point of picking a fight to see how tough the newcomers are. A report goes back to Chila, and if any make the grade, they will receive an invitation to aid in some small matter. Unlike CassaRoc, Chila does not care for suicide missions that reduce competition, and she gives the tough and low-paying jobs to newcomers rather than to her own long-time followers. (Chila is listed in "Personalities of the *Spelljammer*," below.)

The third military brotherhood, the Trading Company, is most likely to engage in mercenary activities. They can be bought—if the price is right.

THE GRAND TOUR

13) The Guild Tower

District: Citadel region

Inhabitants: Humans

Leader: His Majesty, the Puissant and Sage Leoster IV

Activity: Moderate

Morale: 15

Armament: 5 light ballistas and 5 light catapults in storage

This part of the Collective contains what passes for the petty nobility among the humans aboard the *Spelljammer*—all descendents of the myriad heroes and adventurers who have been attracted to the *Spelljammer* over the years. Once their bloodlines had steel and fire in them, but those days are long past. Now the nobility are entrenched in their pedantic beliefs and devoted to the preservation of the way things are.

The Guild is primarily a neutral force aboard the *Spelljammer*, its members interrelated and capable of tracing their ancestry to the first arrivals on the ship. Lost to them, however, is what those heroes did and even what captains have come and gone in the generations they have been on the ship. Their forbears served as advisors to the captains, but now their primary duties are their hobbies and setting an example to the lower ranks of the Collective, the "rabble of commoners." In the Collective's eyes, however, the Guild members have become parodies of true nobles.

Despite their attitudes, the nobility do wield a great deal of power, mainly derived from the weapons of their ancestors and the fact that their "hobbies" tend to revolve around combat and magic. The Guild members have a good deal of time on their hands (mostly because their governing duties consist primarily of sending an occasional representative to the Council), so they devote hours and days to studying their hobbies.

Most of the 200-some members of the Guild are characters who have two classes, usually fighter and mage. All are human, though there is a slight admixture of elvish blood in the line—watered down as far

as abilities, but still present in the Guild members' delicate features.

Most of the Guild nobles are at least levels 4+13 (d10+3), in either fighter (20%), mage (20%), or both (60%) classes. In addition, they will *always* be equipped with a suitable magic weapon, armor (if appropriate), and a wand or staff, and they will have a 30% chance of possessing a ring or miscellaneous magic object.

Fortunately for the other races, the combined forces of the Guild have never been gathered in battle on the ship. Members of the Guild generally see battle as distracting and, more importantly, "lower class." However, the mere fact that this much power exists in one place makes other races generally hesitate before launching major offenses against the Collective since no one really knows just what would get the Guild angry.

At the moment, the Guild nobles prefer to practice their crafts, act in a lordly fashion, and continue to collect magical items from those who pass through the *Spelljammer*. A particular magical item of interest or power may fetch a high price from the Guild, and there are tales that even intact *Spelljammer* helms can be found in the Guild tower, safe from the reclamation efforts of the shivaks.

The Guild nobles are particularly insular. It is uncommon for them to marry outside their class, and in exceptions the proposed mate is usually a hero or an advisor to the captain (in other words, he—or rarely she—comes from "good stock"). They view the other members of the Collective with mild disdain. The rest of the Collective tends to return the favor, and they consider the Guild effete and useless in daily business. However, if the human community is endangered, they will look to the Guild members for protection.

The Guild numbers only about 200 men and women, banded together in 10 noble houses under their king, Leoster, "Regent of all Humanity." In addition, the Guild has more space for its 200 nobles than the Collective has for its 800. As a result, the Guild members live opulently in a manner usually reserved for captains. They are said to create food from the air

The Guild consists of 200 or so "nobles" aboard the ship.
They are vain, arrogant, and without regard for the "common rabble."
But they are good in a fight.

THE GRAND TOUR

on a regular basis and that they never have to fear the Dark Times of the closed gardens.

Leoster effectively sums up all that is both good and bad with the Guild. He is extremely powerful but extremely distracted, often appearing as a doddering, portly old fool with more interest in the coins brought in by new travelers than in any neogi raids. He is also very strong and, if the situation warrants, will be in the forefront of battle. (For additional information on Leoster, see "Personalities of the *Spelljammer*," below.)

Strangers to the *Spelljammer* will likely not encounter the Guild initially, except by rumor and gossip. The Guild members diligently protect their privacy because there are always interlopers who try to gain audience with the Guild's august presence. After several years, however, a sufficiently powerful wizard or fighter (particularly one who may hold his or her own tower or who advises the captain) will be invited to a tea or possibly a cotillion.

If the Guild has a weak spot, it is for the captain, especially if that captain is human. Being a human captain is a sure ticket to membership in the Guild, and Leoster will likely attempt to arrange a marriage with one of his children. Of course, if one controls the mightiest ship in space, how does the machinations of a dotty old ruler whose kingdom consists of a single tower compare?

14) The Halfling Community

District: Citadel region

Inhabitants: Halflings

Leader: Lord Mayor Hancherback Scuttlebay

Activity: High

Morale: 11

Armament: Individual

Hard-pressed up against the Collective is the *Spelljammer's* halfling community, curled next to the side of the human towers as if for protection from larger, more dangerous towers to the stern. As far as most of the other races are concerned, this is a fair

analogy to the halflings' true position on the ship—cowering behind their larger brethren, taking advantage where they can by dint of their small size.

The halflings tell a different story, naturally. In their opinion, they are the grease that makes the wheels of commerce turn. Humans, of course, provide much of the energy and there are a lot more of them, but halflings (or so they say) have the edge because of their craft and ability. Furthermore, they always have their ears open and their mouths shut.

Halflings typically serve as errand runners, waiters, and messengers for the other races. They are most commonly seen in the market at the Open Air Public House. They use their service positions to set themselves up as "facilitators," making sure that person A gets to talk to being B so business can be transacted. As a result of their efforts, the halflings have a very good handle on who is plotting what and when. So good is their grasp of the ship's goings-on that Arcane regularly shifts between hating the little beasts and trying to add them to his information network.

The halflings have other talents besides merely gleaning information. They are passable tailors for making human clothes, and they brew arguably the best mead on the ship. Those halflings who have an adventurous bend have tried to explore the warrens, but the subsequent mysterious disappearance of those adventurers has caused exploration to be officially banned by the Lord Mayor.

Lord Mayor Hancherback Scuttlebay is a smiling, jovial halfling who can usually be found at the Open Air encouraging discourse from others about their deeds and actions. He is particularly winning with humans, whom he treats as if he were a fond rich uncle. Beneath his disarming smile, however, he is continually on the lookout for information that can be used to help his race. (See "Personalities of the *Spelljammer*," below, for more information on Hancherback.)

A newcomer to the ship will undoubtedly soon encounter halflings—if not the Lord Mayor, then one of his followers operating as either a servant or as a thief picking through the newcomer's belongings. ("Acquisitions" is an unofficial major industry for

The halflings have their fingers
squarely on the pulse of the information network circling the *Spelljammer*.
They know what's going on—and when.

THE GRAND TOUR

halfings. They are quite successful thieves because most losses are blamed on the shivak constructs. However, a mayoral edict instructs halfing thieves to concentrate on strangers and to pass by long-established parties.)

Newcomer halfings are particularly welcomed on the ship. They are, of course, plied with free drink and pumped for information regarding their compatriots.

In battle, halfings prefer to fight from ambush, quite willing to flee to save their lives. They feel strongly toward their human compatriots, however, and will rush to their aid, particularly if the outcome looks favorable for the humans. They will almost always come to CassaRoc's aid because he pays his debts with alcohol.

15) Shivak Terminal

District: Citadel region/ship's region

Inhabitants: Shivaks

Leader: None

Activity: High

Morale: 19

Armament: Individual

This squat, nondescript building overshadowed by its neighboring towers is officially part of the citadel district, but it is also the base for the *Spelljammer's* shivaks and as such is considered a part of the ship's region.

Entrances are present on all sides, with the largest entrances opening onto the market itself (Area #6). All of these doorways open into an "airlock"—a small anteroom with other sets of doors. The interior doors remain shut until the exterior doors have been closed and no life is detected.

In addition, the terminal also has a network of underground passages tunneling through the hide of the ship that connect to the warrens, the stores, the captain's tower, other towers in the complex, and the gardens (when open). Because of this complex network, it is impossible to seal off the shivaks from their base.

There are an estimated 500 shivaks on the ship, though only a fraction of them are in operation at any one time. In theory, since they do not consume any air, the *Spelljammer* could have an unlimited number of shivaks activated. Restrictions imposed by the materials required for construction (in particular the need for spelljamming helms) limit the production of shivaks. Total figures vary according to witnesses since no living person has ever seen all the shivaks together, and the estimate of 500 may be off by as much as one-fifth.

While the exterior design of the building looks like any other structure in the citadel region, the interior of the shivak terminal is radically different. The inner walls are composed of the same thick material as are the warrens, with tunnels and overlapping burrows that wind through the structure in three dimensions. The shivaks move smoothly through the terminal and are never lost.

Larger areas serve as "nests" for the shivaks; deactivated shivaks can be found here hugging the walls, draining minimal energy from the ship to maintain their current state. These shivaks will draw additional energy as needed in preparation for reactivation.

Nonshivaks are not permitted in the terminal area, and patrols of 2-4 shivaks are regular sights within the terminal's walls. Living creatures are simply ejected, while the undead and nonliving, mobile creatures (for example, clockwork horrors) are destroyed if the shivaks somehow become aware of their presence.

The few bits of information regarding the terminal area have been gleaned by adventurous young inhabitants (mostly halfings) who had gotten past the airlock gates, explored the tunnel, and then been ejected by the shivaks.

The terminal is located in the middle of the citadel region and is largely ignored by most of the ship's inhabitants. When a number of shivaks leave the building together, however, one or more inhabitants are likely to follow the shivaks to see what the creatures are up to. Usually such missions are to rescue a shivak in trouble.

The shivaks "develop" within the walls of the shivak terminal. They are constructed of the same leathery material that covers the great ship.

THE GRAND TOUR

16) The Illithid Tower

District: Citadel region

Inhabitants: Mind flayers

Leader: Trebek of the Illithids

Activity: Moderate

Morale: 14 (mind flayers); 7 (slaves)

Armament: Individual

Also called the horned tower, this strange-looking structure is the home of the mind flayers aboard the *Spelljammer*. There are about 70 illithids on the ship—all under the command of Trebek, a newcomer who arrived five years ago and who quickly established himself as the leader of the warring rival clans. Before his arrival, there were three major clans and a smattering of smaller ones, each of which were vying for control of the "Illithid Empire of the *Spelljammer*." Now the mind flayers are a unified community under Trebek's guidance. Not everyone—including some illithids—is sure that this is such a good thing.

The mind flayers occupy the upper third of their tower, living in relative luxury. In addition to their standard rations, they receive a "tithe" of food from their goblin allies (Area #17). They also raise a crop—a nonpoisonous yellow mold the illithids call brain mold, which fulfills their dietary need for brains.

However, brain mold is to real brains what soybean steak is to real beef steak—edible, but hardly as palatable as the real thing. As a result, the mind flayers are always on the lookout for brains, which they consider a delicacy. Politics prevent them from openly hunting the established members of the *Spelljammer* community as they would prefer, but newcomers are considered a different matter, particularly those who have not yet been bound to a tower. The mind flayers know that there will be little stink raised if a newcomer is slain; further, if the attacking illithid is killed, Trebek can demand in Council that the mind flayers be given jurisdiction in capturing and punishing the killer of the illithid.

Mind flayers also serve as executioners and mercy killers aboard the *Spelljammer*, selling their ability to

slay in exchange for the victim's brain. They can deliver a gentle end to those who are dying and are sought after to help the aged, infirm, and hopelessly ill to their final rests should they wish it. The illithids will also mete out death to killers and criminals so sentenced by their races. In these manners of delivering death the mind flayers are accepted (at least marginally) by the races on the ship.

The mind flayers on the great ship seem dour and serious compared to their enterprising cousins in the stars. Their garb is similar in cut to that of their spaceborne relations, but the color is limited to shades of black, the only accent being a star field emblazoned across the standard black cape. The mind flayers are often referred to as "the undertakers" by the other inhabitants of the ship (though not in their presence, of course) because of both the function they fulfill and the garb they wear.

The ground level of the horned tower is a reception hall and meeting area, and it is here that most nonillithids meet with mind flayers. Humans and other nonslave races are prohibited from going above that level. The punishment is death for those who trespass beyond the ground level; this jurisdiction is allowed as per the Council's agreement for protecting one's home. The levels above the reception area are all devoted to growing brain mold and are tended by goblins and overseen by mind flayers. The highest of these maintenance levels is devoted to the breeding pool of the illithids. Above this level are the private suites of the mind flayer clans.

The elder pool of the *Spelljammer* mind flayers is a paltry one in comparison to those of major illithid communities in the Known Spheres. This is due, in part, to the fact that during the interclan conflicts, bodies of opposing sides were burned rather than added to the pool. As a result, the pool's power is limited to the horned tower itself. It is capable of detecting nonillithid minds, and if there are such minds anywhere in the building not in the company of mind flayers, Trebek will be notified. Further, while in the tower no mind flayer is ever surprised. This last ability of the elder pool's power has saved the mind flayers on numerous occasions.

Will an adventurer who has the ability to commune with plants hear the silent screams of the illithids' brain mold as it is being consumed?
Will the adventurer attempt to rescue the sentient entity—and risk the wrath of the mind flayer empire?

Areas 16 & 17

Horned (Illithid) Tower and Goblin Tower

Main level

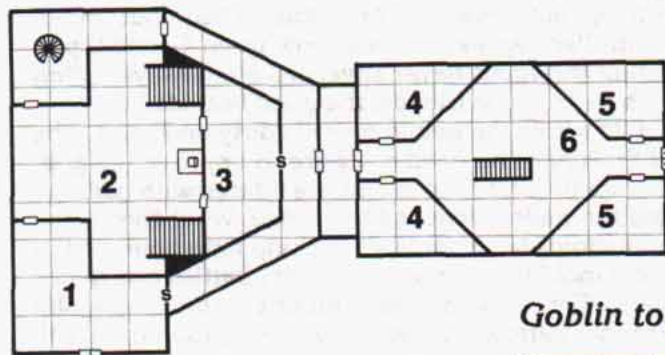

Goblin tower upper level

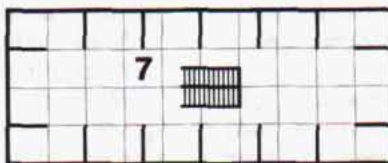

One square = 10 feet

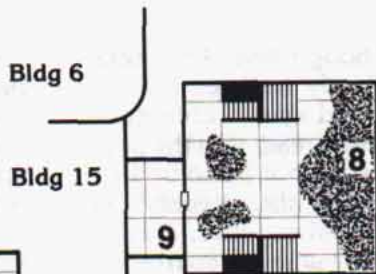

Horned tower highest level

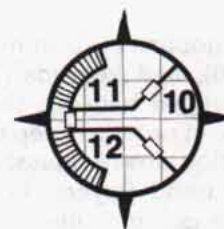

Horned tower upper level

- 1) Entry hall
- 2) Audience chamber
- 3) Private study
- 4) Goblin armory
- 5) Guardrooms
- 6) Goblin assembly area
- 7) Goblin quarters
- 8) Brain mold areas
- 9) Illithid personal quarters
- 10) Trebek's personal reception area
- 11) Trebek's bedroom & larder
- 12) Trebek's study

Unbeknownst to the other inhabitants aboard the *Spelljammer*, the mind flayers' brain mold is sentient, much like large colonies of yellow mold are reputed to be. It is this property that makes the brain mold nutritionally sufficient food for the mind flayers. However, literally floors of the illithids' domain must be devoted to the mold's growth—individuals are without sentience and must be in colonies to provide the nourishment needed by the mind flayers.

Since the brain mold is sentient, it deserves the rights of other intelligent races. However, the illithids would no more want to see rights given to their food than would humans want to see their cattle and vegetables voting against them. Thus the mind flayers will lie about the nature of the brain mold and, if questioned, offer nonsentient chunks for examination. They will not allow any investigators onto the growing floors, and goblins who are smart enough to figure things out will meet with an "accident." If need be, the illithids will have those prying into the brain mold matter killed.

Trebek currently rules the mind flayers with a mixture of cunning and charisma. He appears to be personable and reasonable, interested in serving as a mediator between warring parties on the ship. In reality, he is softening up the various factions for an ultimate illithid takeover, and to that end he has tak-

en control over the mind of Father Goat in the Communal Church (Area #19).

Trebek's rule is secure as long as he can maintain a position of power and strength. If he should meet with visible reverses of fortune, it is likely that the various clan leaders beneath him will be all too willing to declare themselves the successors to his reign. (Trebek is detailed in "Personalities of the *Spelljammer*," below.)

17) The Goblin Alliance Quarters

District: Citadel region

Inhabitants: Goblins, orcs, hobgoblins, and kobolds

Leader: Trebek of the Illithids (advisor)

Activity: High

Morale: 7

Armament: Individual

Attached to the port side of the illithid tower, the goblin alliance quarters consist of a supposedly independent organization of humanoid tribes. In reality, the building is little more than slave quarters used by the mind flayers to house their source of manpower for their brain mold farms.

The tower itself is divided into separate quarters

THE GRAND TOUR

for goblins (120 in number), hobgoblins (150), orcs (130), and kobolds (210). Bloody rivalries are encouraged between the races and even within each race in order to keep them in line (read: thin the population down). Massive losses are not permitted by the mind flayers, however, since they depend on their goblin "allies" for additional supplies. A 20% tithe of all foods brought into the alliance quarters is skimmed off and redirected to the mind flayers.

The illithids use their charm ability to keep the goblin races under continual control and to keep the workers happy in the brain mold farms. The *charm* spells are casted as needed in order to maintain control, and any goblin or orc showing the least amount of free will or disagreement with his or her masters receives another dose of enchantment magic. Particularly intelligent goblinoids are culled from the herd to serve first as servants then later as dinner for their illithid masters, a practice that most other races would deplore if they knew about it.

As a result of this culling over the years, the goblin races of the *Spelljammer* are singularly stupid, even by the standards and stereotypes of their races. All are quarrelsome, bad-tempered, and violent—they respect only strength in other goblins and the orders of their illithid masters. Under Trebek's leadership (they call him their advisor, and he is effectively regarded as the "chief of tribal chiefs"), the goblins are fawning toadies, falling over themselves to help their "great friends, the good illithids." Any goblin, half-orc, or other humanoid worth his or her mettle will look at these poor creatures and wonder how they could have once challenged the great elven armadas.

The elves aboard the ship remember that long-forgotten challenge, however, and they seek to guarantee that no goblin will ever threaten an elf again. The mind flayers use this hatred to plant the idea that the elves are vicious racists. The illithids will often send out a group of unarmed and drunken goblins to supposedly waylay elves and then condemn the more powerful elves when they overreact and slaughter the hapless goblins. In this fashion the illithids have reduced the reputation of the elves and

enhanced their own by portraying themselves as the protector of a minor race.

In theory, all of the slave races could demand their own representation in the Council, but their votes are only brought into play when the illithids want to run up numbers for their side. Then four mind-controlled representatives show up in Council, parroting the mind flayer speeches and always voting with their "great friends, the good illithids."

Life within the goblin tower is dirty and short. The illithids have no need or desire to improve the goblins' lot in life, so the rooms are littered with garbage and the walls blackened by smoke. What energy the humanoids have left after working long hours at the brain mold farms is spent in petty battles and minor wars. Formerly of their number, the Hobgoblin Prophet narrowly escaped becoming food for the illithids, and he now preaches a better life for goblinkind everywhere. The Hobgoblin Prophet is in exile and living with the ogres (Area #23).

When the next Dark Times come and when the gardens are closed and the food supply cut off, the illithids plan to seal the doors to the goblin tower, take the goblinoids' food, and dine on the brains of their former slaves until the gardens reopen.

18) The Building of the Giff

District: Citadel region

Inhabitants: Giff

Leader: Lord High Gunsman Rexan "Diamondtip" Hojson

Activity: Moderate

Morale: 16

Armament: Quadruple bombard

The giff tower is also called the smoke tower because of the sulfurous fumes that often leak out of the windows in billows of acrid smoke—the result of giff "experiments." Like the beholders, the giff are one of the least populous (there are only about two dozen on the great ship) but one of the most feared races. Unlike the beholders, the fear of the giff stems from the fact that they can be as dangerous to themselves as they are to others.

The goblin races aboard the great ship are singularly stupid. Over the years, the mind flayers have systematically culled the goblinoids until only pitiful remnants of once-powerful races remain.

THE GRAND TOUR

The giff of the *Spelljammer* retain their love of explosives, in particular smoke powder. Their casual handling of this dangerous material makes other races wary of their friendship. They have been given jurisdiction by the Council over all matters concerning smoke powder, and they enforce that jurisdiction zealously, confiscating any and all smoke powder weapons—from starwheel pistols to bombards—that are brought aboard the *Spelljammer*.

The giff retain enough unexploded smoke powder to fire five shots from their main gun (see below) and to give every giff 20 shots with their starwheels. All of these explosives are kept in a steel-encased powder room, sealed against air before the craft goes into the phlogiston. While an explosion in the flow would not kill the *Spelljammer*, it would destroy the giff tower and many surrounding buildings. This is one reason why the giff are slightly separated from the other structures in the citadel region.

The giff live a comfortable life in their tower, and they employ dwarves and humans to help them with their research. Since the "research" usually involves things exploding, there are few volunteers. The giff have to pay well for the help, in both food and powder, and as an enticement they allow their assistants to carry starwheel pistols while in their employ.

The giff are constantly seeking to mass-produce smoke powder or potential variants. One experiment produced a rich fertilizer suitable for tubers and other underground edibles, and the giff now trade in potatoes for additional products from the market. They also contribute a powerful homemade vodka to the Open Air Public House. The giff consider farming to be a "peaceful" pastime, and as such they share their land with humans in exchange for a large part of the produce yield.

The giff may be hired individually as adventurers and soldiers, but if more than two are to be hired, the entire 24-member platoon—led by "Diamondtip" himself—will be recruited. (For more information on "Diamondtip," see "Personalities of the *Spelljammer*," below.) The sight of two dozen giff entering any fray, guns blazing, is enough to make even the most stout-hearted enemy quake.

The giff are on good terms with dwarves, humans, and halflings and less so with elves and gnomes (the latter they believe to be under the control of Arcane, whose motives they do not trust). They will never hire out to neogi, illithids, or beholders as they are usually the individuals they are hired to protect against.

The giff have a secret weapon mounted in the top of their tower. The tower's four sides swing back on huge hinges to reveal a large gun platform. On the platform are four bombards bound together with tempered steel bands. This "quadruple" bombard has never been fired. It remains a closely guarded secret of the giff, but it will be engaged if the great ship or the giff tower is threatened. The bombards are mounted on a rotating platform, and the weapon requires eight giff to operate (one officer, one loader, one gunner, and five others to turn the gun).

If the quadruple bombard itself is hit, there is a 10% chance of an explosion for each loaded gun (as per standard rules). If a gun does explode, there is a 10% cumulative chance of another explosion occurring per remaining loaded gun, possibly knocking out all four guns.



"Volunteers, anyone?"

We'll give you food and good pay and even outfit you with a starwheel pistol!
All you have to do is volunteer for a little 'experiment.' . . ."

Area 18 Giff Tower

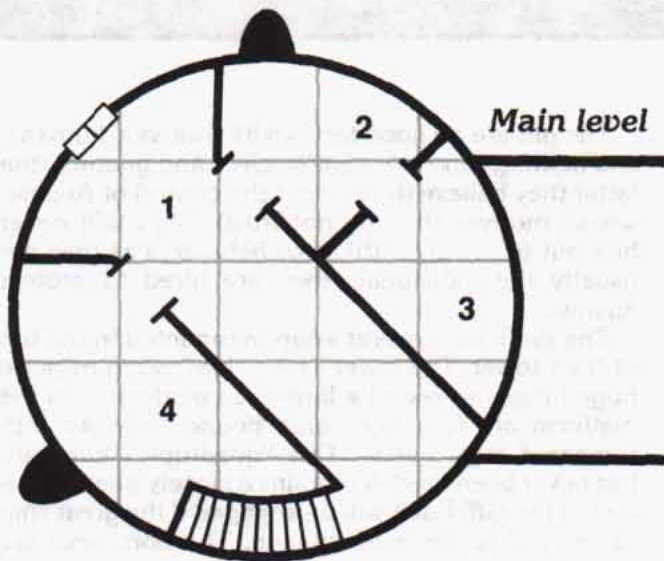

- 1) Entry hall
- 2) Communal gun-cleaning room
- 3) Kitchen
- 4) Planning room
- 5) Hatches to roof
- 6) Roof hinges (allows peak to fold outward)
- 7) Rotating platform
- 8) Quadruple bombard

Tower gundeck level

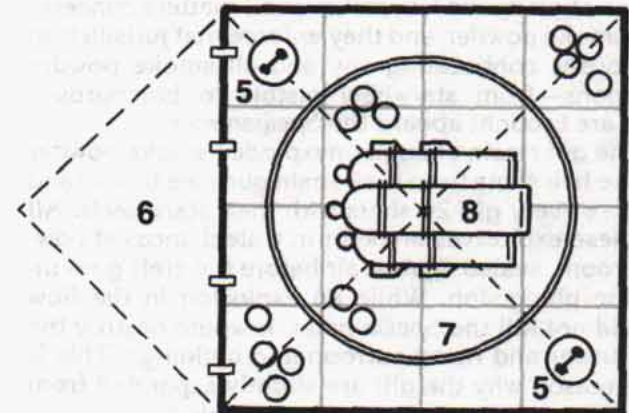

One square = 10 feet

19) The Communal Church (The Outcasts)

District: Citadel region

Inhabitants: Humans and others

Leader: Father Goat

Activity: Moderate

Morale: 8

Armament: Individual

A low, hulking building that makes the shivak terminal look impressive, the Communal Church of Wildspace has been called the thieves' guild and the great ship's sanctuary by different individuals on board the *Spelljammer*. It is the home of outcasts and villains, the persecuted and the hungry, the hunted and the hunter—all mixed in a cross-species aggregate that makes it difficult to determine friend from foe.

The building itself was apparently a warehouse for auxiliary stores at one time but was gutted by fire during the past Dark Times. It was then used by vagabonds and outcasts, individuals who were chased from their homes for personal or political reasons.

Many deposed citadel lords and their followers used the building as a hiding place while they set out to rebuild their forces to launch a counter assault—

assaults that seldom took place. The factions would realize their dreams were for naught, and their organizations tended to fall apart at such a realization. Perhaps because of shattered dreams, the building's interiors are in ruins and are a maze of crumbled walls and caved-in floors. Most of the remaining mix of races hold to the left wing of the building, which is closer to the giff and human towers.

From this mixture of disparate races arose a single leader who pulled together the conflicting races and factions under a semibenevolent and semipeaceful rule. This was an old satyr who has taken the name of Father Goat. Once a typical satyr who had little interest in more than wine and wenching, Father Goat was taken into *Spelljammer* space and promptly "transformed." Finding himself marooned on the *Spelljammer*, Goat began to aid the poor and needy and in the process became the central pillar of the Communal Church of Wildspace.

Father Goat has no clerical powers, and he claims to worship no particular gods. He believes all gods should be allowed to prosper equally and the same for all races. He believes that the mighty should tend the weak and that the rich should aid the poor. This attitude makes him very popular with the weak and poor, and the church has become a haven for outcast races and individuals.

THE GRAND TOUR

The church is the home for about 50 humans, 20 halflings, a handful of gnomes, a married pair of dark elves, a band of korreds, a very depressed treant, a rogue neogi reaver, three minotaurs, a dozen bugbears accompanied by their tribal leader, a yeti, and a double handful of nixies, pixies, sprites, quicklings, and leprechauns. And Old Astor was a member of the church before gaining his position as steward in the ship's stores (Area #6).

Under council rules, the church could claim over a dozen seats in the Council, but "as all races are one in the eyes of the church," they send only one representative, usually Father Goat or one of his human acolytes.

The church forbids fighting among its members on holy ground (the area of the church), and Father Goat uses his pipes to *sleep*, *charm*, or *cause fear* in potential combatants. Thus, most conflicts between members of the church take place off church grounds.

The wide variety of races who make their sanctuary in the church also protects the church from outside attack. Moving against the church means moving against humans and halflings, which may or may not bring in the Collective (or, worse yet, the Guild). Further, many of the races' special abilities (particularly those of the "little people") are enough to deter even a concentrated attack by any single race.

However, the fact that most other races allow the church its space also makes the building an opportune hiding place for a very pious thieves' guild. Consisting primarily of humans and halflings with a leprechaun or two mixed in, the thieves' guild specializes in easy-to-steal, unrecognizable objects, such as food, gold, and most weapons. These items will most often turn up at the church bazaar booth in the market.

Unique items will be left alone, except in cases where those items themselves have been stolen (for instance, items lifted from newcomers are often in turn lifted by members of the thieves' guild). In some cases, the thieves' guild will charge a "reacquisition fee" to reunite an item with its original owner.

Father Goat turns a blind eye to most of the thievery and only intervenes in the most serious cases. Then he will usually insist that the items be put back where the thieves "found" them, but he does not otherwise punish the "finders." (For more information on Father Goat, see "Personalities of the *Spelljammer*," below.)

Father Goat is under the control of Trebek (Area #16), who has charmed the satyr. (The mind flayer makes repeated castings until he is sure the charm succeeds.)

Trebek visits Father Goat twice a week with donations for the poor (part of the goblins' tithe) and takes the opportunity to reinforce his magics on the satyr. The illithid declares himself a pious ally of the church, and he promises Goat that if, the gods willing, Trebek ever has mastery of the *Spelljammer*, he will give Father Goat and the church domain over the gardens, taking it from the lizard men.

20) The Old Wizard's Lair

District: Citadel region

Inhabitants: None

Leader: None

Activity: Low

Morale: N/A

Armament: None

This small building was the home of the mage Asmodeus Pax, who visited the *Spelljammer* with a company of adventures. Like most, he remained here and lived to the end of his days serving his community. After his death a monument was erected inside the gate to his home, featuring a life-size statue of the wizard made of stone carved from the ships of fallen spacesea giants.

In the years since his death, the building has remained deserted, a state encouraged by both Asmodeus's stony greeting at the door and the repeated rumors that the wizard's lair is haunted. Several attempts to roust purportedly hostile spirits have failed, mostly because none of them showed up to battle the priests and adventurers who challenged them.

The Communal Church is home to all manners of outcasts—
from humans to dark elves, treants to neogi reavers,
yetis to nixies, pixies, and sprites.

THE GRAND TOUR

The building now serves as neutral ground for meetings, particularly between thieves and their fences and between spies and their informants.

The wizard's lair would make an excellent base of operations for a group of adventurers seeking a place to hide out on the *Spelljammer* if they have chosen not to side with any particular group. The Council and other powers would not object to a new ownership of the lair, provided the statue is not removed or damaged. Dire prophecies abound concerning the statue and the ultimate fate of the *Spelljammer*—while none of them have come true, no one wishes to stretch their luck.

21) The Gnoll Ruins

District: Citadel region

Inhabitants: Gnolls

Leader: Argargon (presumed dead)

Activity: Low

Morale: 6

Armament: Individual

This complex of buildings at the foot of the giff tower is in sorry shape. Though its external walls are solid, the roof has a number of unplanned skylights from when the giff dropped stone shot onto the gnolls' home during an intertower argument. The ruins are now practically deserted, and only 20 gnolls (divided into four separate clans) remain to live off of carrion and the discards of other towers.

The gnolls backed the wrong horse; that is, they made a bad choice when siding with one of the vying powers aboard the *Spelljammer*. They once numbered almost 200, which made them one of the more populous humanoid races on the ship. They were the contacts, messengers, and mouthpieces of the beholders, who preferred not to have direct contact with their alien neighbors.

During this time the gnolls' bullying traits came to the fore, and they pushed around other races as they saw fit. (Their motto seemed to be "When you are allies of creatures who can destroy matter in the blink of an eye, you get what you want.") The gnolls terrorized the humans and the giff, but if strongly con-



fronted they scurried behind their beholder allies for protection.

Then the Blinding Rot struck and the eye tyrants went mad, striking out against each other, believing each to be the harbinger of the disease. But then a rumor emerged that the gnolls were in fact carrying the disease, which resulted in a mass slaughter of the hyena-headed creatures by the beholders. Suddenly enemies of their former allies, the gnolls found they had no friends in the outside world. Matters came to a head when the giff retaliated for a past gnoll raid, knowing that the beholders would not float to the gnolls' rescue. The giff used their tower's superior height to drop stone shot down on the gnolls' building, killing dozens of gnolls and ruining the building.

The body of the gnoll king, Argargon, was never found, which did not surprise the giff, knowing gnoll dining habits. However, a large number of Argargon's followers in the battle disappeared soon afterward as well, their fates unknown by living creatures on the ship. The shivaks now bring only enough supplies for the surviving 20 or so gnolls, so it is assumed that all of Argargon's followers are in

The gnolls have become a pitiable lot aboard the *Spelljammer*.
Once 200-strong, they now number only 20.

THE GRAND TOUR

fact dead and consumed. Despite this evidence, however, the gnolls continue to hold Argargon as their leader.

The truth is that Argargon and his followers fled into the warrens beneath their tower, where they unexpectedly encountered the forces of the Fool. They are now in his service—in the form of gnoll zombies. (For more information on Argargon, see "Personalities of the *Spelljammer*," below.)

The surviving gnolls are not strong enough to harm anyone, and they are now little more than scavengers. They will flee to their lair rather than fight, and they are more pitiable than dangerous. Still, they will defend their home territory with their lives because they believe that Argargon will return to them one day soon and lead them back to glory and prosperity.

The giff are quite happy to let the gnolls retain claim to the wrecked building because that prevents anyone else from controlling the complex. Likewise, few other races are comfortable having the giff for neighbors.

Trebek has suggested that the goblin alliance be given charge of the gnoll refugees, but the other races have vetoed that idea so as not to give the illithid any more power.

22) The Minotaur Tower

District: Citadel region

Inhabitants: Minotaurs

Leader: Hammerstun Breakox

Activity: High

Morale: 19

Armament: Individual

There are 40 minotaurs on the *Spelljammer*, most of whom are refugees or descendants of refugees. They have formed a large, militaristic clan that, like the giff, hires out to the highest bidder. Unlike the giff, however, they do not have superior firepower on their side, and they have had to defend themselves against attackers.

As individuals, the minotaurs are loud, boisterous,

and rude. In groups they are dangerous, highly unstable, and quick to anger. Their primary targets are the human towers (from which they take "brides") and the goblin quarters (from which they take food). They are detested by most races, and humans have used both the Guild and the giff in repelling minotaur attacks.

The minotaurs are an eagerly sought-after target for three of the evil races aboard the great ship, all of whom see the bull-headed creatures as a potential acquisition.

The neogi consider the minotaurs similar to umber hulks and hope to turn the minotaurs into new, dangerous mounts.

The illithids, on the other hand, are both nettled by the minotaur raids and at the same time realize that the creatures can be added to their stock of slaves.

And the beholders want to control the minotaurs for use as a raiding force against the neogi. The beholders think the minotaurs will give them the necessary edge in their ongoing war.

Finally, most of the "good" races on the ship would prefer to see the minotaurs swallowed by the void. The ogres are the minotaurs' only true ally; all other races are effectively enemies.

The minotaurs would have disappeared into slavery at the hands of the other factions had it not been for their leader, Breakox, who is in fact a hill giant cursed to appear as a minotaur. Thus far, he has managed to keep the minotaurs from being enslaved, mostly through use of guile. (For additional information on Breakox, see "Personalities of the *Spelljammer*," below.)

Breakox is marginally smarter than his fellows, and he rules with an iron hand. He will seem to side with the neogi, mind flayers, or beholders for a few months, then switch sides to improve his own position. Just in case he fails to pull off this turncoat maneuver, he has a deal with Father Goat of the Communal Church (Area #19). Breakox guarantees the church to be off limits to minotaur attacks; in return, Breakox can use the church as a sanctuary if his tower is invaded.

The giff and minotaurs and ogres
are all in similar positions of vulnerability—none is a populous race.

THE GRAND TOUR

23) The Ogre Wizard Quarters

District: Citadel region

Inhabitants: Ogres, ogre mages, hobgoblins, and goblins

Leader: ShiCaga the Enchantress

Activity: Moderate

Morale: 14 (ogres and ogre mages); 6 (hobgoblins and goblins)

Armament: Individual

There are 40 ogres and three ogre mages encamped in the low barracks that run between the ruined warehouse (which serves as Father Goat's church) and the minotaur tower. Because of their few numbers, like the minotaurs, the ogres must also survive by craftiness and guile as opposed to brute force. Unlike the minotaurs, however, the ogres are good at it.

The chief proponent behind the ogres' survival is the three ogre mages who lead them, the self-proclaimed "enchantress" ShiCaga and her two sons. These ogre mages rarely appear in their natural form in public, choosing rather to appear as simple ogres of the community. Because of this predilection on the ogre mages' part, ambushers who would never hesitate to attack a gnoll or minotaur hold their weapons, unsure if what faces them is truly a relatively simple ogre or something much more deadly.

The ogres hire out small groups as independent units in raids and wars, and they have no problem working for any race—good or evil—provided they get paid. Their farming efforts are minimal, and they usually must supplement the rations they receive from the shivaks by raiding or by working for others. The ogres are allied with the minotaurs in a mutual defense pact, but ShiCaga has assured the neogi, beholders, and illithids that if the day comes when Breakox is besieged in his tower, the ogres will stand with the winners (in other words, effectively promising to help all sides).

ShiCaga is a beautiful (at least by ogre standards, anyway) widow whose mate was killed by CassaRoc in a brawl. She is forgiving but charges factions double that have CassaRoc the Mighty as an ally. Her two sons are much less forgiving, however, and they actively seek dire revenge against the human and his followers.

The enchantress has control over her sons for the moment, but their rebellion against their mother (and their own rivalry for who will succeed her) festers and continues to grow. (See "Personalities of the Spelljammer," below, for more information on ShiCaga.)

Furthering the dissension between mother and sons is the Hobgoblin Prophet, an intelligent hobgoblin who somehow escaped the mind flayer dinner tables and acquired priestly learning. The Prophet preaches a unified community of all humanoid—kobold, goblin, hobgoblin, orc, gnoll, ogre, ogre mage, giant, and even minotaur (the Prophet of course excludes the illithids).

ShiCaga is fascinated by the prospect of a holy alliance with herself as its obvious temporal leader. She has supported the Prophet in his views—despite her sons' objections—even to the point of ambushing inhabitants of the goblin tower and carrying them off for "deprogramming" under the Prophet's guidance. Progress is slow, both because the procedure is just starting and because the mind flayers have noticed the disappearances and now keep the goblins confined to the horned tower or to their own quarters.

About 20 goblins and hobgoblins, fanatical followers of the Prophet, inhabit the ogre wizard quarters with the ogres. ShiCaga's two sons agree with most of the resident ogre population that the smaller intruders are a general nuisance. And they think the Prophet's long-winded harangues and calls for a holy crusade against the mind flayers are potentially dangerous. If the Hobgoblin Prophet could be quietly disposed of in a manner that would not set ShiCaga herself on the path to holy war, both sons would be pleased.

Will adventurers encounter the Hobgoblin Prophet and "see the light"?
Will they support his cause to unite all nonhumans
(barring mind flayers, of course),
or will they attack the priest and his followers?

THE GRAND TOUR

24) The Beholder Ruins

District: Citadel region

Inhabitants: Beholders

Leader: Gray Eye

Activity: Low

Morale: 12

Armament: Individual

This building with colonnades is in ruins for the most part, its interior walls breached and shattered by battles between subspecies of the beholder race. There are only a dozen beholders left in the structure, and they are all under the leadership of one extremely old tyrant, Gray Eye. (For more information on Gray Eye, see "Personalities of the *Spelljammer*," below.)

The beholders were at one time the most powerful race on the ship—more powerful than the elves, dwarves, or humans and more dangerous than the illithids, neogi, or the solitary Arcane. A full complement of 100 beholders roamed the vaulted halls of this complex at one time. Then, in the course of only two standard years, the beholders were almost completely wiped out by a disease known as the Blinding Rot.

None know where the Rot came from, though suspicions run strong toward the illithids (because of their work in molds) or the neogi (because of their general hatred toward beholders). The disease affects the extremities of the afflicted beholder, causing his eyes to fail one by one until they are blinded and useless. Death typically follows in short order at the hands of either the Rot or of a fellow beholder who cannot abide the horror of his former comrade. Only one beholder has contracted the Blinding Rot and survived, mostly because he managed to escape from the paranoid beholder community. That beholder is Old Astor, now steward of the *Spelljammer's* stores.

The Rot heightened the beholders' xenophobic fears of variation in that their own numbers were now changing before their eyes into unfit horrors. Half of the beholders died of the Rot, and almost the entire

other half was wiped out by fear of the Rot. Old Astor fled his community rather than be terminated, which in the eyes of the remaining beholders is indication enough (combined with Astor's present deplorable association with halflings) that the diseased beholder deserved to perish.

During the time of the Blinding Rot the beholders also lost control of their gnoll allies (Area #21), who were equally decimated by both their maddened masters and by other races taking advantage of their sudden lack of a powerful protector. The beholders can now, however, stabilize their numbers and seek a new servile race. They are investigating the minotaurs, but realize that their leader, Breakox, will have to be removed.

Since their fall as a major race, the beholders have come under attack by the neighboring neogi. Despite their reduced numbers, the beholders have repelled the attacks and have sealed off all the lower entrances of their towers except one, which they keep heavily guarded. The intertower attacks have been reduced to a regular daily exchange of magical and missile fire.

The beholders have always been reserved and clannish, coming out from their lair only when necessary and then only appearing in force (no less than three in public places). They need a new servant race to take care of the difficulties of their day-to-day life, such as trading or raiding for additional food.

Curiously enough, the shivaks leave much more food for the beholders than their declared numbers would indicate. Some say that the beholders have a reserve force living in hiding; others say that the beholders project multiple images in shivak eyes and that the shivaks thus think there are more beholders than there actually are.

In truth, a number of beholders who contracted the Blinding Rot have been preserved at a barely living level in the heart of the complex. Wrapped in treated bandages, the rotted ones are kept alive with healing magics and given quarter rations to sustain them. The beholders receive full rations for these invalids because they are alive, but Gray Eye skims off three-fourths of the rations to use as barter with hu-

The Blinding Rot came aboard the ship
and literally decimated the beholder population.
Half died of the disease itself, and nearly all of the rest died from fear.

Area 24

Beholder Ruins

One square = 10 feet

- 1) Slave stairs
- 2) Beholder passage in ceiling
- 3) Typical beholder quarters
- 4) Trap room (exploding runes, deactivated by antimagic ray)
- 5) Beholder-mummy room

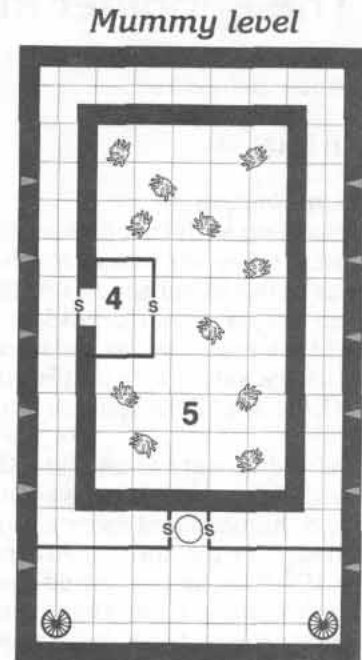
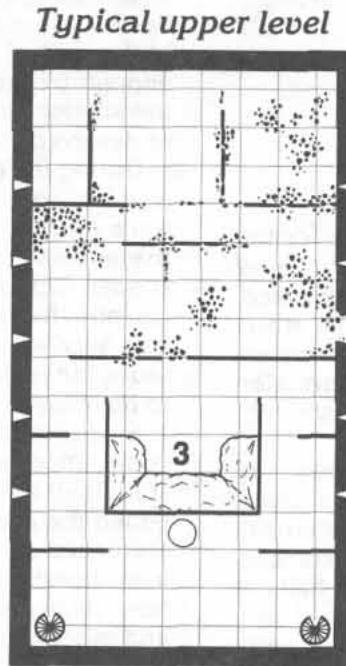
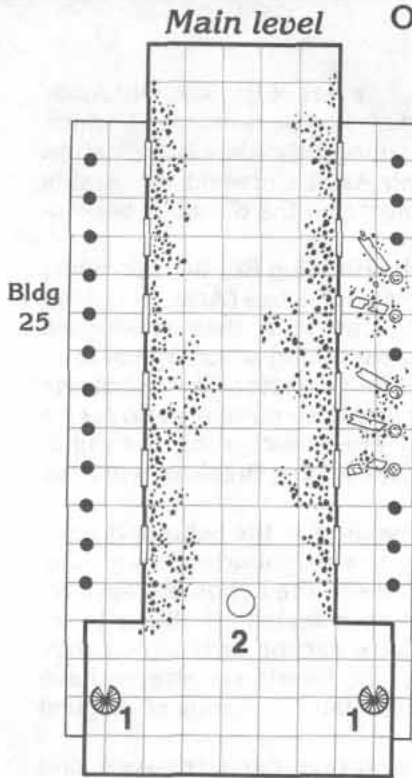

manoid lords. Gray Eye plans to use the invalids as an unexpected trump card if the tower is invaded. He is unaware that the invalids may have their own plans (see the kasharin or beholder-mummy entry in the "New Monsters" section, below).

25) The Dwarven Citadel of Kova

District: Citadel region

Inhabitants: Dwarves

Leader: Lord Agate Ironlord Kova

Activity: Moderate

Morale: 16

Armament: 5 medium ballistas, 5 medium catapults

The largest building on board the ship belongs to the dwarven nation of Kova. The tower is 120 feet across at the base and rises from a plaza of solid chitin mounted across the back of the ship, abutting the beholder territories and Father Goat's church. While the area beneath the plaza could easily house another race, it has proved to be impregnable, and dwarven mining attempts have proved fruitless. Furthermore, any small advances the dwarves do make are filled in by the shivaks almost as soon as the holes are created.

The Kova family, along with most of the ruling families in the community, are mountain dwarves. All newcomer dwarves (regardless of type) are automatically welcomed into the nation, provided they offer fealty to Agate Ironlord Kova. There are approximately 300 dwarves in the tower. (For more information on Lord Kova, see the section on "Personalities of the *Spelljammer*," below.)

The Kovan leadership is typified by the dwarves it governs. These dwarves are stolid, pragmatic, insular, and conservative in their attitudes. The way that dwarves have always done things is paramount in their minds, and they give only a minimum of adaptation to their new environment. To do otherwise would be to abandon their very dwarvishness.

The dwarves occupy the top levels of the 600-foot structure, which is accessed by a lift operated by minotaur and ogre "prisoners of war"—captured during abortive raids by those groups against the dwarves or when they have run afoul of dwarven fighters in the streets. The prisoners are well fed and treated, but they are slaves. They are held by dwarven-forged chains and kept in triple-barred cells when not about their tasks.

The base of the tower is taken up by the foundries, the only fire kept burning at all times on the *Spelljammer*. All other flames must be banked when

THE GRAND TOUR

the *Spelljammer* enters the phlogiston because of the risk of explosion. The foundry is allowed to operate continually, however, because of a quadruple shell of airlocks and fail-safe passages that prevent the chance of an explosion. If these protective methods were bypassed and the fires of the foundry exposed to the Flow, the resulting explosion would likely destroy most of the citadels on the ship and cripple the *Spelljammer* itself. For this reason, as keepers of the flame the dwarves are eternally vigilant.

As the masters of the foundry, the dwarves also control the fashioning of almost all metal items on board the great ship. Most metals are recycled from items that have found their way into dwarvish hands—in fact, nearly all weapons on board have been refashioned at least twice. Those items that are pure and without trace alloys are greatly valued by the dwarves, and they will offer twice normal price for them.

The dwarves trade their skill for additional food and drink from other races, and several dwarf families set up shop in the market to show off their wares. They are on best terms with humans, less so with halflings, polite (at least) with elves, and on good terms with the remaining demihuman races of the ship. They trust the gnomes and allow them to have free use of the foundry for their own work, but they do not trust the gnomes' firm and long-standing alliance with Arcane and never allow him access.

The Kovan Dwarves teach that the *Spelljammer* is powered in the same way as the dwarven citadels—in other words, by the work in the great foundry. The fact that it moves at will indicates that there is always a captain (likely a dwarven hero) who controls the ship's movements and that the "captains" that come and go are merely the dwarf captain's representatives. The fact that the *Spelljammer* has never had a dwarven representative on display in the armory is taken as proof of that theory.

Few of the dwarves of Kova will take on custom work willingly because they are concerned about what additional weapons among the various races will do to the balance of power. Still, they would rather have a sword raised in their behalf than against

them, and they will fill what orders Lord Kova approves. Because few orders are approved, most of the custom design goes to the Free Dwarves (Area #26). The dwarves of Kova tolerate their more excitable cousins and have been known to come to their defense on a number of occasions.

26) The Free Dwarves Tower

District: Citadel region

Inhabitants: Dwarves

Leader: Vagner Firespitter or his regent

Activity: Moderate

Morale: 14

Armament: 4 medium catapults, 10 light ballistas

Immediately adjacent to the large forge tower of the dwarves of Kova is the tower of the Free Dwarves, a splinter group of about 100 dwarves. They are primarily of hill dwarf stock but also a mixture of creatively inclined mountain dwarves; the few illusionist gnomes aboard the great ship can be found here as well. The Free Dwarves differ from their cousins in that they are more emotional, creative, and devoted to making objects beautiful as opposed to functional. They believe that space has relaxed the rules that have held dwarves to a stern, earthy breast for so long and that it is time to show what their race can truly achieve.

The leader of the Free Dwarves is Vagner Firespitter, a brilliant craftsman who has a mercurial temperament. It was he who crafted the scowling statue of Asmodeus Pax (Area #20). Those who meet Firespitter for the first time should be warned that he uses responses to the statue as a sort of litmus test when meeting people for the first time. He will disparage the statue without noting that it is his work and then wait for the person he is addressing to disagree and point out the obvious artistry of the work. Failure to do so will earn his ire, and he will shelve any projects asked for to lowest priority. Both Trebek and Arcane have fallen for this stunt, and Firespitter is referring to them when he refers to "the heathen" who cannot

The only fire continuously lit aboard the great ship is in the dwarven foundry. The smithy has a quadruple shell of airlocks and fail-safe passages to prevent explosion when entering the Flow.

Areas 25, 26, 29 & 31

Dwarf Towers, Giant Tower, and Gnome and Arcane's Tower

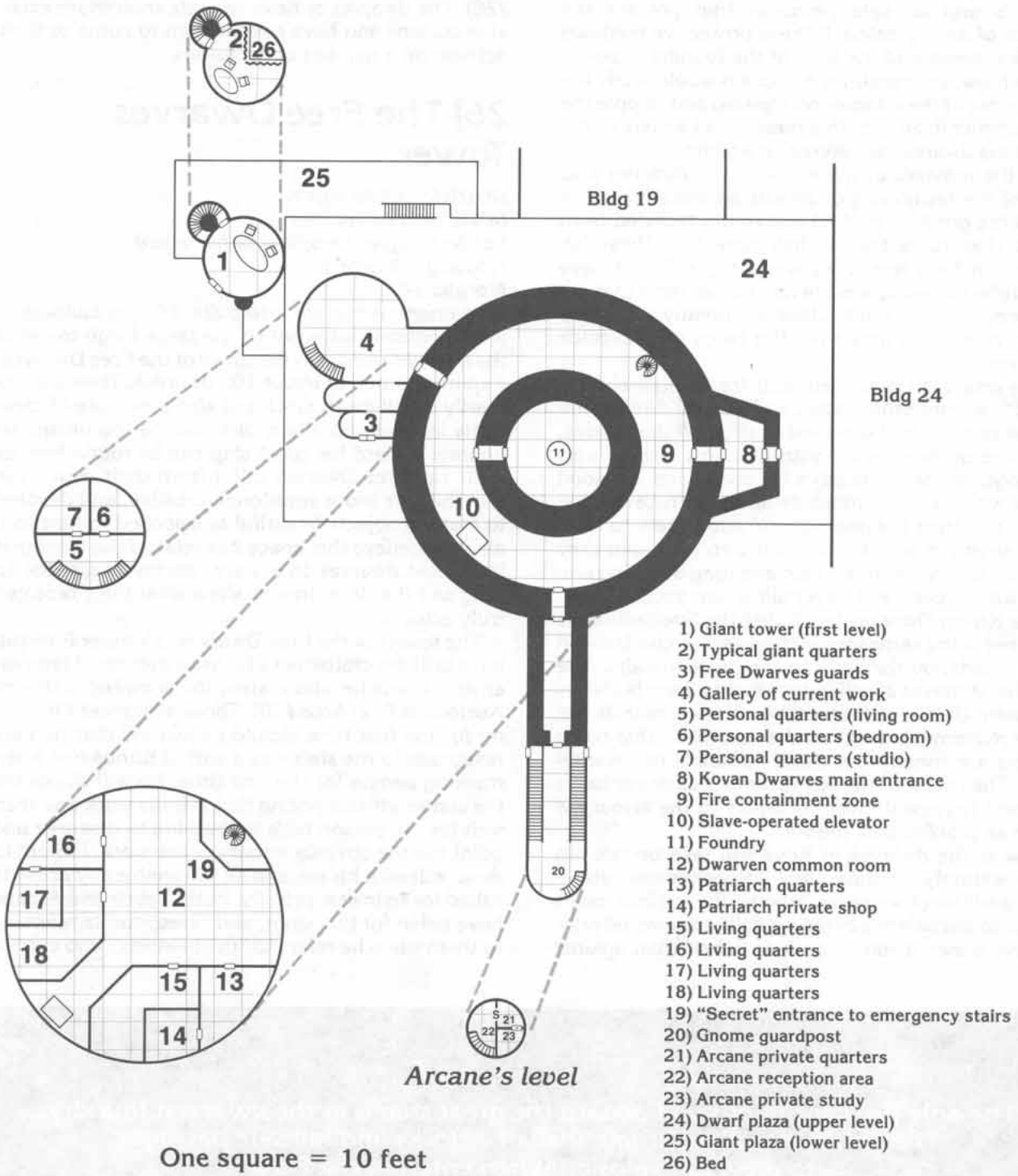

- 1) Giant tower (first level)
- 2) Typical giant quarters
- 3) Free Dwarves guards
- 4) Gallery of current work
- 5) Personal quarters (living room)
- 6) Personal quarters (bedroom)
- 7) Personal quarters (studio)
- 8) Kovan Dwarves main entrance
- 9) Fire containment zone
- 10) Slave-operated elevator
- 11) Foundry
- 12) Dwarven common room
- 13) Patriarch quarters
- 14) Patriarch private shop
- 15) Living quarters
- 16) Living quarters
- 17) Living quarters
- 18) Living quarters
- 19) "Secret" entrance to emergency stairs
- 20) Gnome guardpost
- 21) Arcane private quarters
- 22) Arcane reception area
- 23) Arcane private study
- 24) Dwarf plaza (upper level)
- 25) Giant plaza (lower level)
- 26) Bed

One square = 10 feet

THE GRAND TOUR

appreciate true art. (See the section below on "Personalities of the *Spelljammer*" for more information on Firespitter.)

Usually a person seeking work from the Free Dwarves will not even meet with Vagner Firespitter, but with one of the regents he appoints when he himself is in the midst of a project. The requirement for being appointed regent seems to be the proximity of the dwarf or gnome closest at hand when Firespitter wants time for himself. Regents thus vary between conservative bureaucrats worried about any decision while Firespitter is away to insurgents who want to remodel everything in their own image. Inappropriate changes (particularly those that cause the other races to attack the Free Dwarves) bring Vagner Firespitter out of his study, screaming at the top of his lungs—with the result usually being a new regent. (The more irrepressible dwarves have been known to quip—under their breath, of course—about the appropriateness of Vagner's name.)

The chaotic nature of the Free Dwarves is accepted, however, by any who really want something interesting, be it jewelry, weaponry, or stonework. The Free Dwarves have access to the forge of the dwarves of Kova, though they believe the stodgy mountain dwarves are excessive (and tedious) in their concern about fire.

The Free Dwarves also believe that their cousins are more interested in keeping their foot on the controls of the ship's only continuous foundry than in creating metal works. They take on more daring work than do the Kovan Dwarves, and they are the ones who created the quadruple bombard for the giff. (They are eagerly looking forward to seeing it in use because they signed a contract binding them to silence until the weapon is fired.)

If there is trouble on the ship caused by dwarves, the Free Dwarves are usually at the bottom of it. They tend to drink more than their cousins and to pick fights, not only with standard dwarven enemies such as ogres and giants, but with humans and elves as well.

Under the influence of their illusionist gnome cohorts, these dwarves have a standing rivalry with the

"official" gnomes of the *Spelljammer* who work with Arcane. The dwarves of Kova have often had to step in as a mediator (and often as a rescuer) in Free Dwarf disputes. For their part, the patronizing attitude of the mountain-dwarf-dominated Kovan Dwarves makes the Free Dwarves all that more rebellious.

Firespitter and his Free Dwarf allies are easily recognized in the market—they are dressed in flamboyant clothes that seem impossible to make, armed with the most ostentatious of weapons and armor, and drinking the greatest amount of alcohol they can manage. They claim that their refinements in liquor still production give their ironcut whiskey the most potent kick of any on ship, and they may be right.

The Free Dwarves, like their cousins, believe that the *Spelljammer* is basically a dwarven ship and is powered by its foundry. But these dwarves teach that the *Spelljammer* is an act of the dwarven gods, including Clangedin, to prove that dwarves can create such a thing of beauty. Its trip through the stars is to awaken the creative spirit of dwarves and other lesser creatures.

27) The Neogi Tower

District: Citadel region

Inhabitants: Neogi

Leader: Master Coh

Activity: High

Morale: 12

Armament: 5 medium ballistas, 8 light ballistas (all pointed at the beholders)

The neogi make their base in a cramped, narrow tower complex separated from the beholder and minotaur complexes by only an expanse of the *Spelljammer's* leathery hide. The neogi (about 50 in number) use the upper half of their building as their own quarters and reserve the lower half for their slaves (primarily umber hulks, but a few hill giants, minotaurs, and gnolls as well).

There are approximately 20 umber hulks on board the *Spelljammer* and about 10 of the other races that serve as slaves, so only the most elite of the ship's

Two types of dwarves coexist on the great ship:
Kovan Dwarves and Free Dwarves.
The difference is apparent after meeting one of each.

Area 27

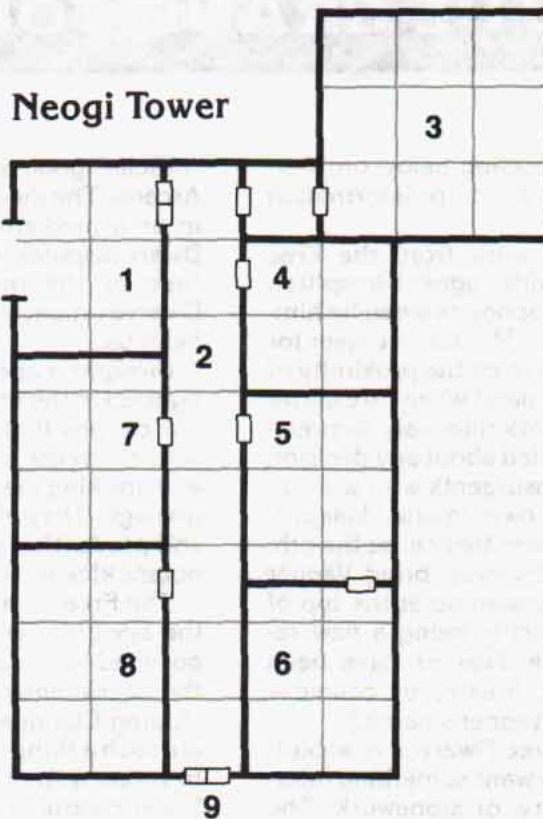

- 1) Entry area
- 2) Hall
- 3) Great Old Master's quarters
- 4) Meeting room
- 5) Quartermaster room
- 6) Prisoners' section
- 7) Coh's study
- 8) Slave exchange
- 9) Slave entrance

One square = 10 feet

neogi have the right to personal slaves. This paucity of slaves makes their acquisition very important to the neogi; indeed, the entire drive of their race on board the *Spelljammer* is the eventual enslavement of every other race on the ship—effectively turning the *Spelljammer* into a neogi ship.

Needless to say, this goal is opposed by the sentient races on the ship, which severely limits the neogi's attempts for control. Of all the races, the neogi are the most hated and shunned. They are a self-contained community; if anything is needed, their slaves deliver messages and fetch their orders. Indeed, Trebek and his illithids appear kind and gentlemanly in comparison.

The neogi believe that they are taking their rightful place among the races of the universe as those races' ruler and master. The concept that others are "unowned" is strange to them, and they think newcomers to the *Spelljammer* are runaways to be reclaimed by the neogi and reintroduced to slavery.

The current neogi leader, Master Coh, could be considered a moderate in that he wants to leave most of the present inhabitants alive after the eventual neogi takeover. He will seek any ally he can in his drive to control the ship and has even extended tenuous invitations to the Fool in order to gain the undead lord's help. Coh completely understands the

Fool's position among the undead—he is the ultimate lord of his minions. Therefore, all Coh has to do is control the Fool in order to control the Fool's followers. To that end, Coh is desperately seeking any devices or items that control the undead.

Coh's main preoccupation at the moment, however, is feeding the new Great Old Master. This Great Old Master was Coh's predecessor, who launched the neogi in a bitter (and so far unresolved) war with the beholders. The Great Old Master demands fresh meat, and no substitute will do. A deal to obtain most of the swine raised by the lizard men fell through, and Coh has had to resort to using slaves (which undermines his own position with his slave-hording subordinates) or to raiding other towers (which risks certain reprisals). Coh is very careful about his raids, targeting the weak, the ineffectual, and the disliked. The gnolls are a logical target, but the distance between his tower and their complex negates frequent runs.

Coh's predecessor left Coh with an unfinished war with the beholders as well. The Great Old Master thought to expand the neogi complex by annexing the neighboring beholder complex. He secured from a traveler (who subsequently died in the slave pits) a disease supposedly fatal to beholders, the Blinding Rot. Released in the complex, it did devastate the beholder

THE GRAND TOUR

community but did not destroy it. Furthermore, the remaining beholders were sufficiently powerful enough to retaliate and disintegrate a large chunk of the neogi population and its slaves (which is why the neogi's current slave population is critically low).

That leader of the neogi is now helping more neogi come into the world as the new Great Old Master and has left Coh to deal with the war and all the other problems.

The war has degenerated into periodic firing of ballista bolts and catapult shots into the beholder complex, with the occasional death or disintegration ray received in return. Neither side is ready to attempt more substantial attacks until it is sure of victory, but Coh will have to move quickly or he will soon find himself the next Great Old Master.

The life of neogi slaves makes the goblins' imprisonment by the mind flayers look cheery in comparison. The slaves are given minimum amounts of food and are literally worked to death, planting and harvesting a reedy bean beneath the light plates—marginal food even by neogi standards. On top of that, nonumber hulk slaves are regularly slain and served as food for their masters. The life expectancy of a new slave is a few months at best.

The umber hulks are treated only slightly better. Their muscle makes them more valuable to the neogi, and their tough flesh makes them generally inedible. Until Coh's predecessor's reign, the umber hulks were permitted to tunnel into the *Spelljammer* and attack (and eat) any shivaks that came to stop them. The disappearance of many of these umber hulks (believed to be at the hands of the Fool and his undead troops) has convinced Coh to rescind this permission.

The neogi have little history regarding their place aboard the *Spelljammer* because they are the most recent of a series of neogi races to settle on the ship. Previous neogi settlements had been either entirely wiped out by a combined alliance of a few of the races (an act that the other races on the ship quietly turned their backs on) or self-destructed during the Dark Times.

Coh wishes to avoid both of these fates and sees

no reason why the next captain could not be a magic-wielding neogi (such as himself). He does not know what the precise method of attaining captaincy is, but he does know that both the Fool and Arcane are aware of what is necessary to become captain. Coh's ultimate goal is to get something that either one wishes to have in exchange for that information. (For more information on Coh, see "Personalities of the *Spelljammer*," below.)

28) The Hulk Tower

District: Citadel region

Inhabitants: UMBER hulks

Leader: Master Coh through his personal slave Orik

Activity: Low

Morale: 17

Armament: Individual

A low tower that was seized by the neogi several years ago as "additional room" has been turned into quarters for umber hulk slaves. (The other slave races have to be kept in the neogi building or else they would run away and join the other towers. The umber hulks, on the other hand, have nowhere to run away to and thus are "trusted.") The previous tenants of this building were the *Spelljammer*'s thieves, who merely joined Father Goat's church (Area #19)—which resulted in an amazing increase in attendance and offerings.

The umber hulks have destroyed most of the building's interior with their tunneling through the walls and floors, so much so that the interior is little more than piles of gravel. Left intact is an iron stairway along one wall leading up to a large catapult, which is used to lob occasional missiles on the beholder complex.

The umber hulks, while intelligent, have no minds of their own because they are under the continual control of the neogi. In theory, Master Coh's personal slave Orik has some say in umber hulk matters, but in reality he just responds to Coh's wishes and parrots whatever he is told to say. (For more information on Orik, see the section on "Personalities of the *Spelljammer*," below.)

Neogi and beholders
have been at war aboard the *Spelljammer* since the beginning.
Periodically the neogi have been wiped out, but the current group is here to stay.

THE GRAND TOUR

Area 28

Umber Hulk Tower

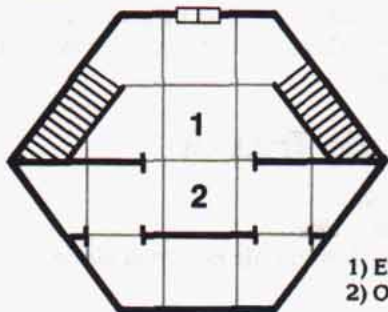

1) Entry hall
2) Orlik's quarters

One square = 10 feet

29) The Giant Tower

District: Citadel region

Inhabitants: Hill, stone, and frost giants

Leader: Taja Deeplunder

Activity: Low

Morale: 14

Armament: Individual

This relatively small tower is the home of the giants aboard the *Spelljammer*, who number less than a dozen (a family of seven hill giants, three stone giants, and a single frost giant). Seriously outnumbered by the other races, unwilling to throw in with the numerous but weak good forces, and equally unwilling to side with evil races that would reduce them to slaves, the giants have taken a neutral position. They offer to fight only in defense of the ship as living catapults, and they will aid in tasks requiring heavy lifting but will otherwise refuse to be part of any attacks between races.

The giants are in the shadow of the dwarves, a fact not lost on either race. There are several of their spe-

cies (but none of their immediate family) locked up in the dwarven tower as slaves, and there is no other race willing to come to their aid. The giants say that the dwarves have bought the other races' silence with steel weapons, but the dwarves state that the slaves are rightful prisoners of battles between giant and dwarf.

The leader of the giants is Taja Deeplunder, a neutrally aligned frost giant who is a follower of Ptah. She believes that the giants were placed on the *Spelljammer* in order to learn. To that end she has taken on the role of storyteller and talespinner, trying to keep track of all the captains and kings who have passed through the ship. Her surprisingly gentle manners have earned her a degree of respect from the human communities, but the fact that her tales are usually less than complimentary toward dwarves has further deepened that race's dislike.

Taja's position is supported by the stone giants but only just tolerated by the hill giants, who believe that their superior height and strength should make them rulers, not the bearers of heavy weights. They resent what they perceive to be Taja's toadying attitude toward the humans—thus, Breakox and his position of relative strength appeals to the hill giants. The fact that Breakox was once said to be a hill giant before becoming a minotaur also speaks highly to the giants, and the day is soon coming when they will either overthrow Taja or leave to join the minotaurs. Such an upset of power would likely further escalate the machinations of the neogi, beholders, and illithids to add Breakox's people to their own ranks.

30) The Shou Tower

District: Citadel region

Inhabitants: Humans (Shou)

Leader: Magistrate Under the Heavens Si Loo

Activity: High

Morale: 10

Armament: Individual

The last major human enclave on board the *Spelljammer* is the Shou community, located in the

The giants aboard the ship are few in number and in a position of unease. Should they throw in with the good but weak forces or be swallowed up by the evil races and made into slaves? Or should they join the minotaurs . . . ?

THE GRAND TOUR

shadows of the dwarf towers. Settled by several waves of oriental adventurers from different worlds but by most recently the Shou Lung of Toril, the Shou community seeks to keep its members "pure" and apart from the other human communities. Rigidly devoted to their duty to the empire, there are about 80 Shou in the complex.

Note that there are adventurers from oriental families in the other human communities as well as *Wa and Shou Lung families*, but these Shou consider the other orientals "tainted" and no better than the rest of the gaijin. Only the Shou who live in the Shou tower and who have minimal interactions with other humans are remaining true to the Path.

The Shou were sent into space to collect information for the edification of their mighty emperor. Their present magistrate, Si Loo, operates under the imperial seal and has claimed the *Spelljammer* as property of the emperor. All other races are welcome to live aboard it until the emperor chooses to take possession—such as when the Shou take control of the vessel.

The Shou tower is both poorly ventilated and extremely damp. The Shou traded their irrigation techniques with the lizard men for surplus water, which they continually filter through beds of charcoal and use for drinking, washing, and, most importantly, growing rice.

In the dampness of the Shou tower under the continuous beams of the light plates, the Shou manage to grow enough rice to feed themselves during the Dark Times, even if the flow of food from the gardens is interrupted. Furthermore, the dampness encourages the growth of molds and lichens, which are harvested and made into small curative potions (1–3 points per dose). These are sold by the clan's merchants who are given permission to attend the market.

Si Loo also brought silkworms and mulberry trees to the ship, and these have been successfully transplanted to the interior gardens in the Shou tower. The silk fabric produced by the Shou is considered the finest of its type on the ship, much to the envy of the other human races.

Most newcomers will encounter the Shou only through their merchants at the market. Usually the merchants are in groups of five and heavily garbed and veiled (to prevent contamination); they even go so far as to seal their goods before they return to their tower. The Shou never haggle over their wares' prices—attempts to wheedle a lower price will be met with a frosty glare and usually a raised price. This is a veiled insult that means the buyer should really go elsewhere.

The Shou are led by Si Loo, who is a bushi (or fighter) and the "magistrate under the heavens in the name of the emperor." In theory, his charter specifies that all matters on the *Spelljammer* come to him for judgment. In reality, however, he has deigned to pass control and jurisdiction to the Council, which is just as well considering that none of the other factions—not even the other humans—would submit to his rule. Si Loo operates in a fantasy world regarding his abilities, and he continually issues lengthy proclamations that have little to do with real life aboard the *Spelljammer*.

Si Loo's aid and advisor is a *wu jen* (or wizard) named Nagasimi, who tends to delete the more ridiculous and inflammatory statements when editing Si Loo's proclamations. Nagasimi also "deletes" non-Shou whenever possible to keep the Shou community pure. Nagasimi has seen the outside world and other humans, and he has no desire to join them and their diseased cultures.

A note on abilities: Si Loo is a bushi and Nagasimi a *wu jen* according to *Oriental Adventures*. If the DM does not possess this book, consider Si Loo a fighter and Nagasimi a wizard as far as abilities are concerned. (For more information on both Si Loo and Nagasimi, see the "Personalities of the *Spelljammer*" section, below.)

The Shou are considered a self-absorbed offshoot by the rest of the human community, and they would seriously question coming to the Shou's aid if they were in trouble. As a result, several of the other powers on the ship have been sizing up the Shou for possible takeover. As long as Nagasimi lives, however, this seems unlikely.

**The Shou, although human,
are purists at heart and will keep to themselves
in order not to be "tainted" by other humans.**

THE GRAND TOUR

31) Arcane's Tower

District: Citadel region

Inhabitants: Gnomes, one arcane

Leader: Arcane

Activity: High

Morale: 10 (gnomes); 15 (Arcane)

Armament: 10 gnome ballistas (20% chance of operating); other gnome devices as DM sees fit

Arcane's tower is a single spire attached to the Kovan Dwarves' citadel by a wide dormitory. The building is the home of most of the gnomes of the complex, and the tower's upper spire belongs to Arcane alone.

The gnomes of the complex are tinker gnomes whose family ties stretch back to Krynn but whose existence in space has all but obscured their origins. They are typical of their kind: bustling, haphazardous, interested, curious, and dangerous in their continuous search for inventions. They are as thrilled as they can be that Arcane has chosen their tower for his home and that they get to serve so august a personage.

Arcane is only known by his species name, and he is insane. He has been trapped on the *Spelljammer* for a decade now, in a closed economy, with a limited amount of material to sell or trade. He is aboard the greatest ship in the Known Spheres, with no way of controlling or selling that ship. The restrictions against his basic nature have driven him mad and turned him into a dangerous psychopath. He will kill if necessary (particularly if there is potential profit in it); what's more, he will kill with his own hands, a rarity for his people. He appears as a calm, cool, and collected arcane, typical of his race. In private, he flies into fits of rage and plots devious treacheries against those who have crossed him in any real or imagined way. Having never been close to a real arcane before, the gnomes assume this is common and simply stay out of his way when a black mood hits. (For additional information on Arcane, see "Personalities of the *Spelljammer*," below.)

Arcane knows how to control the ship—he killed Neridox for the information and then befriended a

prospective captain who had an ultimate helm, only to slit the woman's throat once they had attained the control room. Arcane took the ultimate helm and presented himself to the *Spelljammer* but was rejected by the ship. The helm dissolved harmlessly in Arcane's hands, and the control room's location was blotted from his mind. The experience proved too much for Arcane to bear, and he slipped totally into madness.

Arcane has sold parts of his secret knowledge on how to gain captaincy to the lizard man Demets and to Stardawn, a commander of the elves. He has also opened negotiations for selling his secret to Trebek. But Arcane tells only half a tale, changing pertinent information or out-and-out lying to the buyer about the *Spelljammer*. No one realizes that an arcane can lie, so his words are taken as truth.

Arcane will try to prevent anyone from attaining the *Spelljammer* without his help. In fact, he will go so far as to slay anyone who makes such an attempt, even another arcane. (This actually occurred two years ago when Arcane's own brother tried to become captain. The mad Arcane slew his brother and now keeps the decaying body locked in his tower.) Arcane in particular fears the Fool, and he sees all that happens on the ship as a continual chess game between he and the undead lord for control of the ship.

The rest of the ship's inhabitants consider Arcane spooky but as trustworthy as are the rest of his kind. Most do not have questions of sufficient importance to ask him, however, and if they do query him they know that he often asks for odd or impossible items in payment (an example being a bottle of air that has never touched the air of the *Spelljammer*).

The gnomes are regarded by the other inhabitants of the ship as part-time clowns, part-time geniuses. While the Free Dwarves are considered smart enough to keep their more dangerous inclinations under control, the same cannot be said for gnomes because the occasional gnomish invention will get loose, and the decks will need to be cleared until everything is under control again.

The current gnomish-made projects include an

What is a lone arcane doing aboard the *Spelljammer*? How did he get there? How does he feel being aboard the greatest ship in the Known Spheres—and unable to trade or sell that ship?

THE GRAND TOUR

underwater-breathing apparatus and plans for a ship-sized catapult. Both have been commissioned by Arcane, but no one—not even the gnomes—knows what their true purpose is.

32) The Tenth Pit

District: Citadel region

Inhabitants: Humans and others

Leader: Korvok the Fell

Activity: Low

Morale: 14

Armament: 2 medium ballistas

This squat, circular tower is more of a meeting place than an actual community since only Korvok and his personal retinue of about a dozen flunkies are normally found here. However, the most evil members of the human race, evil races, and thieves often use the Pit as neutral ground for meetings. No protection is offered by the management, and visitors come at their own risk.

The Tenth Pit is also the hiding place of any evil extraplanar creatures that find their way to the *Spelljammer*. If the DM has a copy of the *Outer Planes Monstrous Compendium*, he or she should feel free to add one or two fiends or tanar'ri to Korvok's forces. Such creatures are uncomfortable on board the *Spelljammer*, but they are not affected by the entrancing nature of the ship's air. They will seek to leave the ship as soon as possible, despite Korvok's hospitality.

Korvok is a hulking, beastlike man who has a fine eye toward pitting one group against another to benefit a third. He trades little secrets picked up from various groups, but currently he knows nothing worth trading. He and his assistants (mostly thieves and fighters) can be hired to acquire unique objects or to remove troublesome individuals. Nearly every leader on the ship has offended someone else in a position of power, and Korvok's business will improve as these tempers fray. (For more information on Korvok, see "Personalities of the *Spelljammer*," below.)

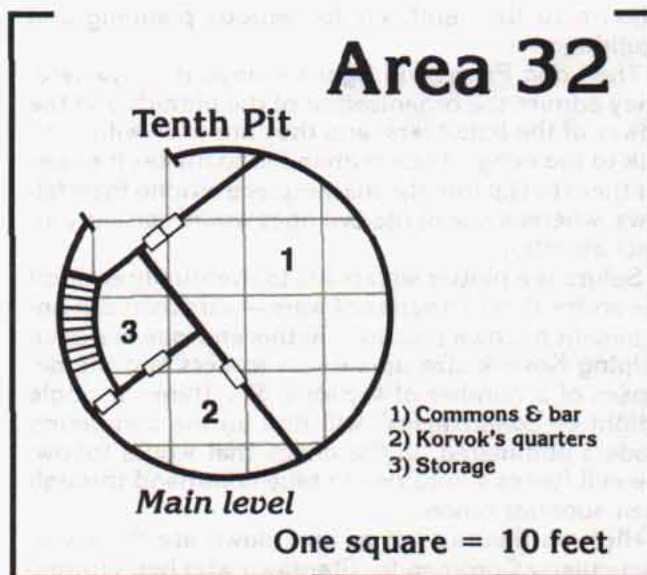

33) The Long Fangs' Tower

District: Citadel region

Inhabitants: Humans and others

Leader: Selura Killcrow

Activity: Moderate

Morale: 13

Armament: 1 light catapult

Slightly more popular than the dour, plotting Tenth Pit, the Long Fangs number about 50 humans (thieves and fighters, levels 4-16), typically outcasts who do not wish to hide behind Father Goat's skirts at the church. The Long Fangs' group is the closest thing to a rival thieves' guild and gives the Communal Church members a run for their money.

The Sharptooth Common Room, a tavern on the first floor, is a regular meeting place for evil races. Selura, the proprietress of the tavern and leader of the Long Fangs, keeps the peace with the aid of several of Taja's hill giants from Area #29. Many evil individuals use the Sharptooth as a place for an initial meeting; then, if neither side betrays the other, they

The Tenth Pit and the Long Fangs are two groups for hire. For the right price, they will acquire objects or perform assassinations.

THE GRAND TOUR

adjourn to the Tenth Pit for serious planning and skullduggery.

The Long Fangs will fight for anyone, anywhere. They admire the organization of the illithids and the power of the beholders, and they are even willing to talk to the neogi. Their human blood makes it easier for them to slip into the marketplace among their fellows, whereas one of the evil ones would certainly attract attention.

Selura is a plotter who plans to eventually embroil the entire ship in a series of wars—wars than can only benefit her own position. To this end, she has been helping Korvok size up various leaders and the defenses of a number of factions. She thinks a single "Night of Long Knives" will find all the competing leaders eliminated. In the chaos that would follow, the evil forces would rise to take command through their superior power.

High on Selura's list to take down are the elves, particularly Commander Stardawn who has spurned her advances.

34) The Academy of Human Knowledge

District: Citadel region

Inhabitants: Humans (Xenos)

Leader: The Hooded Soldier

Activity: Low

Morale: 15

Armament: Individual

Ostensibly an official monastery and retreat operated by the Seekers, the academy is in reality a front for the Xenos, a racist human-interest group dedicated to the elimination of all nonhuman races. The Xenos' goal is to turn the *Spelljammer* into a sanctuary for humans only.

The academy is also a library staffed by humans who have taken a vow of silence and who allow all other races to partake of the benefits of human knowledge. Only tomes and scrolls written by humans are permitted in their walls. No magical tomes are kept in the library, nor are there any books or manuscripts that refer to the *Spelljammer* or its captains. Brother Burke (who is allowed to speak) will explain that these texts were removed by the wizard Neridox many years ago and are locked inside his tower (Area #8).

The library documents a wide variety of human achievement on some 200 worlds. Other races are mentioned in asides, but there is no "dwarf section" or anything in an elvish alphabet. The Academy of Human Knowledge contains exactly that: *human* knowledge.

The librarians are always interested in increasing their knowledge base, and, if human adventurers are interested, Brother Burke will assign a scribe to take down their life stories for inclusion in the library. (See "Personalities of the *Spelljammer*," below, for more information on Brother Burke.) The assumption is that the academy is in some way attached to the Seekers, a human group dedicated to the advancement of all knowledge and the solving of mysteries.

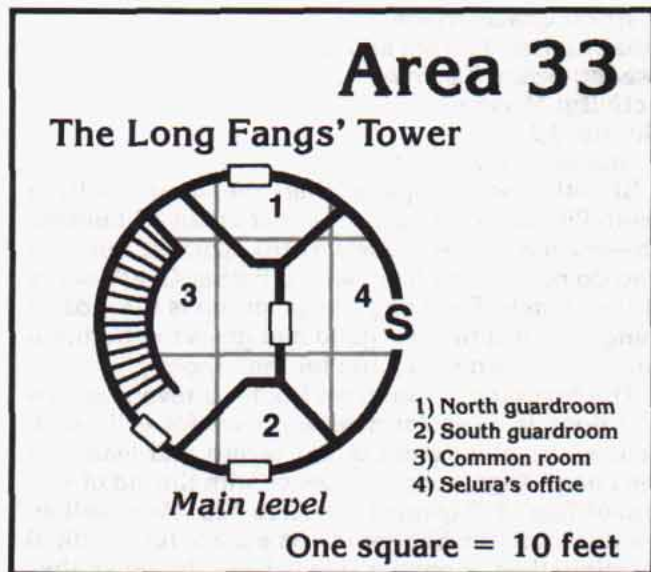

**A radical human-interest group,
the Xenos are devoted to the elimination of all nonhumans.
If a band of adventurers includes an elf or a kender or two, look out!**

THE GRAND TOUR

The academy is actually a cover for the Xenos, who work to destroy their nonhuman rivals on the *Spelljammer*.

There are only three dozen Xenos on the ship, but the membership includes many higher-ups in the military brotherhoods and in the Guild—in particular, King Leoster's grandson Ollister and Si Loo of the Shou. (In reality, Si Loo never actually attends any meetings and merely sends a representative in his stead.) The Xenos meet irregularly, and meetings are called by a posting of a thin red banner on the flagpole.

The Xenos' leader is a masked human known only as the Hooded Soldier; his identity is kept hidden from the others, and all attempts to discover it have been foiled.

The Hooded Soldier hears the complaints of his fellow Xenos and makes recommendations for attacks. These attacks are usually terrorist in nature rather than full-fledged assaults. Neither Brother Burke nor any of the Xenos have seen the Hooded Soldier's face, and they believe he is really Si Loo because of the Shou lord's predilection for not attending meetings.

This is untrue. The Hooded Soldier is actually an undead agent of the Fool's. Beneath his hood is a sil-

vered mask, originally belonging to one of the Lords of Waterdeep and containing powers that protect the identity of the wearer. (See "Personalities of the *Spelljammer*," below, for more information on the Hooded Soldier.)

The Fool, through the Hooded Soldier and the Xenos, was responsible for the destruction of the old elvish academy. Not only that, the Fool put the neogi in contact with an individual who knew how to acquire the Blinding Rot, which decimated the beholders.

The goal of the Fool through the Xenos is to sufficiently weaken and confuse the living races aboard the ship so that the Fool himself can take control of the *Spelljammer*.

The Xenos survive chiefly by their secrecy and disciplined natures, for they are almost categorically close-mouthed about their activities. One seeking admission to their circle must first prove his or her prohuman sentiments, usually by an attack on a nonhuman race that is both daring and secretive (the sudden disappearance of an elven captain or the head of an illithid appearing at the doors of the neogi, for example).

The Xenos will kill those people who are getting too close to their secret, and Brother Burke has his own magics to protect him from providing information.

Area 34

Academy of Human Knowledge

- 1) Entrance
- 2) Main reading room
- 3) Scribes' desks
- 4) Brother Burke's office
- 5) Xenos meeting room
- 6) Hooded Soldier warren entrance

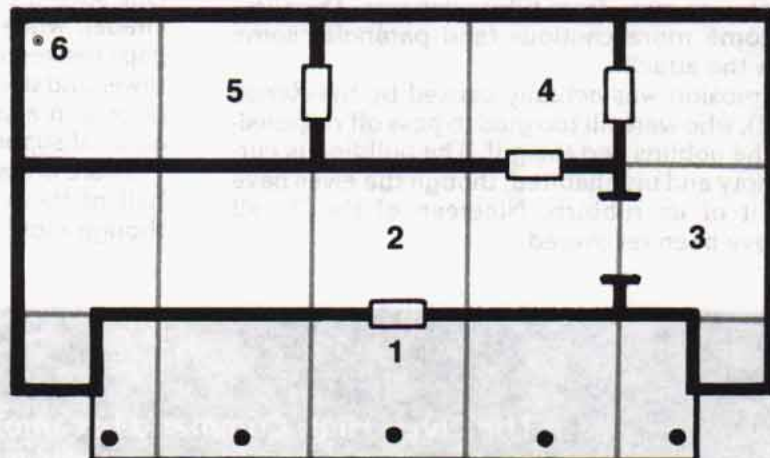

One square = 10 feet

THE GRAND TOUR

35) The Old Elvish Academy

District: Citadel region

Inhabitants: Abandoned (claimed by elves)

Leader: None

Activity: Low

Morale: N/A

Armament: None

This small building was once used as a drill area for elven guards as well as a training field for younger members of the race. The roof and grounds used to be overhung with a variety of plants, and the gardens there included the most bountiful examples of plant life aboard the *Spelljammer* other than that found in the gardens. All races were welcome at the elvish academy (except goblins, of course) on what was considered common ground beneath the majesty of the Elven High Command.

Then, little more than six months ago, a small explosion ripped through the building as the ship entered the phlogiston. The explosion killed 20 elvish cadets and gutted the building, though quick action by the Elven High Command, the Academy of Human Knowledge, and the shivaks prevented the flames from spreading further.

Investigation indicated that the explosives were stolen from the giff, but the timed flame device that ignited the fire was crude and goblin-made. For two months afterward the elves slew any goblin found on the ship, and they demanded (and received) permission to inventory the giff powder stores.

As a gesture of good faith, Brother Burke of the Academy of Human Knowledge offered his facility to the elves for permanent use, but the high command decided instead that their training should be moved into their tower, away from future dangers. The elves have become more cautious (and paranoid, some say) since the attack.

The explosion was actually caused by the Xenos (Area #34), who were all too glad to pass off responsibility to the goblins and the giff. The building is currently empty and uninhabited, though the elves have stripped it of its rubbish. Nineteen of the 20 elf bodies have been recovered.

36) The Elven High Command

District: Citadel region

Inhabitants: Elves

Leader: Admiral Drova Highstar, late of the Elvish Armada Triumph

Activity: Moderate

Morale: 16

Armament: 10 medium ballistas, scattered among the entries

The tallest structure on the *Spelljammer* (by virtue of the ornately carved serpent atop the pinnacle) is the Elven High Command, the headquarters of the elven navy aboard the *Spelljammer*. The fact that the elven navy has no ships that can operate outside the *Spelljammer* does not bother the high command; their goal remains to keep the *Spelljammer* out of potentially hostile hands, including all evil races—and in particular the goblins.

The high command is on constant alert. If an elven ship attempts to land on the *Spelljammer*, the crew will be met at the field by a detachment of the elven guard, who will escort the newcomers to their tower for official welcoming and processing. By the time that processing is complete, their ship will have been dismantled by the shivaks and the newcomers will feel no desire to leave. While the elves do not set out for this to happen, they are nevertheless gratified by the number of newcomer elves who decide to remain in service.

The elves have salvaged enough of their flitters that have landed on the great ship to maintain a culture of the plantlike cells that make these vessels. One such growth (the serpent) crowns the top of the citadel, while another has been used to bridge the gaps between the tower and the tail and between the tower and the armory (Area #37). This "master seed" is kept in a secure room in the tower, and only the admiral supposedly has access to it.

There are about 200 elves on board the ship, and half of them have magical abilities of some type, though most not above the level of a 2nd level wiz-

The Elven High Command became incensed when some group dared blow up their training building. Now they have grown more cautious—and some might say paranoid.

THE GRAND TOUR

ard. The elves enjoy a luxurious life aboard ship, and every area that is not devoted to official business is given over to small gardens producing flowers, fruits, and other flora. There is usually enough produce for simple feasts and revels at least twice a week without using rations from the food budget.

The government of the elven tower is militaristic, along the lines of an elvish navy. Admiral Highstar is supported by a staff of advising commanders, who are in charge of the captains, who in turn command squads of up to 10 elves each aboard the *Spelljammer*. Orders are unquestioned and immediately acted upon, and positions are for life. (For further information on Highstar, see "Personalities of the *Spelljammer*," below.)

The goals of the Elven High Command are three-fold:

1) To prevent the *Spelljammer* from falling into the hands of individuals who may mean harm to the elven race.

2) To eliminate the traditional enemies of the elves, primarily the various goblin races (including gnolls, orcs, hobgoblins, goblins, kobolds, bugbears, and ogres).

3) To lead the other, more primitive races to live in harmony according to the elven model.

While goal #1 is admirable, the elves' execution of goal #2 tends to offend other races (especially those listed), and the elves' high-handed attitude with regard to goal #3 offends those races not offended by #2. Elvish dedication to the eradication of the goblins has resulted in several large battles (read: massacres) between well-organized elven troops and unarmed humanoid families. Further, these attacks have caused the mind flayers under Trebek to appear virtuous by comparison because the illithids are seen to be *protecting* their goblin slaves—thus further legitimizing their ownership. The fact that their attacks are aiding a greater evil is lost on the elves, who consider it their time-honored duty to protect the other races by destroying the humanoid menace.

This "time-honored duty" tends to rub other races as well as goblins the wrong way, mostly because the elves tend to place themselves first in any situation.

They think that their "duty" is to bring the other races up to their standards. Admiral Highstar is typical of the elves in that he regards all other races as unsophisticated savages to be patronized. He believes these creatures can occasionally muster their native cunning to achieve some minor goal, but if long-term results are desired, then the elves must be brought in.

Elves think the humans are populous and not overly bright, the dwarves savage in their taking of prisoners (the elves, after all, execute theirs), and the halflings not even worthy of mention, save to keep an eye on one's wallet when they are about. Because of these attitudes, which are often displayed in an obvious and a condescending manner, the elves are not well loved aboard the *Spelljammer*.

One of the admiral's chief commanders, Lothian Stardawn, has traded information about elvish plans and defenses with Arcane in exchange for further knowledge regarding ultimate helms and the *Spelljammer*. He does know that the prospective captains always carry a particular item, a badge of office, that is recognized by the *Spelljammer* as a symbol of command. This badge provides access to the hidden controls of the ship.

Stardawn does not know what such an item might be, only that future captains carry it. He intends to intercept and relieve the would-be captain of the item and thereby put an elvish captain at the helm of the great ship. (Stardawn is described in "Personalities of the *Spelljammer*," below.)

37) The Armory

District: Ship's region

Inhabitants: Shivaks

Leader: None

Activity: Low

Morale: N/A

Armament: Individual

The armory of the ship is one of the massive towers to the stern of the ship, but it is patrolled by the shivaks and is therefore considered part of the ship's regions. Interlopers are grappled by the shivaks,

The elves want to prevent the ship from falling into enemy hands.
But more than that,
they want to wipe out every goblinoid under the sun.

THE GRAND TOUR

beaten into unconsciousness if necessary, and dumped outside the building. However, access to certain areas of the tower is permitted in cases of emergency, such as when weapons or equipment are needed for defending the ship. The captain supposedly has access to this area at any time, but he or she cannot remove anything from the armory except in emergencies.

The armory is a storehouse of those magical items and materials gathered over the years that may be dangerous or inappropriate for inclusion in the ship's stores. If the ship determines there is a need to open the armory, the doors at the base (and at the upper tower) will open, and shivaks will guard the passages meant to remain sealed. The items in the armory include the following:

- An additional stash of smoke powder in triple-sealed containers (which take two turns to open manually), equal to 500 charges of the material.

- Additional ballista bolts, catapult stones, and steel-encased bombard stones all stored in huge rooms, creating an essentially unlimited supply of these items.

- Replacement parts for the ballistas and catapults (but not the bombards) on board, in sufficient quantities to build all the large weapons on the ship twice over.

- Duplicates of every weapon type on the ship, from starwheel pistols to clubs to repeating crossbows to bastard swords—in amounts large enough to arm every member of the great ship's inhabitants.

- Scale models of every ship type that has ever landed on the *Spelljammer*. These are, in fact, the real ships, magically reduced and placed beneath glassteel cases. Whenever a new ship or novel variation appears on the *Spelljammer*, its living crew is removed and the shivaks come to dismantle the ship—the parts are then reduced and the ship reassembled here. All ship types and major variations are included, except for those that are unique (such as Quentin's *Libraria*). These model ships all have their original tack and spelljamming devices, if appropriate, sized down in exact scale.

- A hall of 40 magical swords, ranging from +1

to +4 in enchantment. There are no vorpal blades or weapons of sharpness, but there is a flametongue sword beneath two glassteel containers.

- A similar hall of war hammers and maces.

- A similar hall of arrows.

- A hall of glassteel cases containing the examples (dead) of every major and minor race that the *Spelljammer* has encountered. These are stuffed skins of former visitors who have perished on the *Spelljammer*. Every sentient race is represented here, including those not currently on the *Spelljammer* (such as the k'r'r'r, which are discussed in their entry in the section on "New Monsters," below). There are no treants, a fact that would further depress the already depressed and only treant currently on the ship. There are also three cases that have been broken into and the bodies removed; there is no clue as to the culprit(s).

- A long, spiraling hall of stone statues of men, elves, a halfling, a beholder, several illithids, a minotaur, and two ogre mages. They are all dressed differently, and the age of the stone (noted by dwarves) increases the further into the spiral one walks. The statues are unlabeled, but the most recent ones resemble the captains of recent memory. There are about 150 statues.

- A huge domed vault, surrounded on the perimeter by more than 2,000 diamonds set into the wall. Pressing one of the diamonds creates the image of a planetary system—the interior of a crystal shell. The illusionary planets orbit and are tinged with colors from red (indicating little life) through the spectrum to violet (teeming with life).

The armory is in reality the ship's memory. It is filled with exhibits that remind the ship of various individuals, races, planets, battles, and captains. Removing exhibits literally removes pieces of the ship's memory, though there are parts (like the multiple battles each ballista bolt represents) that the *Spelljammer* can do without, and so it lets the inhabitants use these items to protect it. Hence, the inhabitants think of the building as the armory—a place to retrieve weapon supplies. In reality, the armory is a mnemonic device that aids the ship in navigation and battle.

The armory is more than a weapons' storehouse:
It is the mind and the memory of the ship.

THE GRAND TOUR

38) The Dark Tower

District: Ship's region

Inhabitants: Prisoners and shivaks

Leader: None

Activity: High

Morale: N/A

Armament: Individual

The dark tower is the sternmost of all the citadels on the *Spelljammer*, and it suffers a reputation more foul than any tower controlled by evil creatures. While the shivaks will simply remove an offender found in most ship's regions, in the Dark Tower rumors are that the shivaks will kill the trespasser to protect that which is within. Soon after someone enters the tower, there is a trickle of black smoke seeping from its chimneys. The invader, it is said, has been captured, killed, and burned. No one may enter the tower and leave again to tell the tale.

Or almost no one. Mad Arcane has walked its halls and lived. But he has not told the tale, for Arcane wants to sell the information he gained there. However, he must first admit that he gained access to the dark tower.

The dark tower is the ship's brig—the dungeon—where the great ship puts its old captains, those captains who have been defeated in combat by newer captains and who survived, and those captains who were deposed for endangering the ship. Here they are well cared for, given luxurious apartments and sufficient food and each other for company. They are restricted by only two commandments: to never leave the tower and to never speak with anyone outside the tower. They are prisoners for life.

The walls of the dark tower are proof against all magic; they cannot be teleported through; and they prevent access to the outer, inner, astral, and ethereal planes. Much like the phlogiston, spells that access other dimensions, planes, and demiplanes will simply not function in the dark tower. The gods answer no calls or wishes within this confine. It is in many ways a perfect prison.

Arcane, with a party of gnomes, made his way into

the tower (the only known entrance is through the armory) and found the Lost Captains. There were four at the time, and now there are only three—the one who shared her secrets with Arcane died at the madman's hand, as did all the gnomes who followed their leader. Arcane escaped with his life only, and to this day he is convinced that the shivaks will come and carry him off as they have deposed captains. He fears he will be brought there to die in the dark tower at the shivaks' hands or be confined there for the rest of his extremely long life.

The remaining three Lost Captains are:

- Jokarin the Bold, who ruled the *Spelljammer* 20 years ago. His captaincy lasted only six months, however, because he attempted to use the ship to settle old scores he had with various wildspace navies. After the fourth such battle, the ship decided he was an unworthy captain, and the shivaks stormed his quarters and dragged him through underground passages to the dark tower. Jokarin is still bitter and angry about his failure as a captain and his subsequent imprisonment, and he continually plots to escape the tower and retake the ship.

- Theorx the Aged, another human male, who is old and fat and about 80. As a young man he captained the *Spelljammer* for over a decade until one day he attempted to leave the ship. He was steadfast in his decision, and the *Spelljammer* was given no other choice but to remove him and put him in the dark tower. He has seen the lives and deaths of a half-dozen other captains over the years, and he is resigned to his fate. Theorx seeks to keep a history of the ship and is always willing to listen to new tales. He will only share his own tale with another former captain.

- Miark the Blind, who is the one beholder depicted in the captain's gallery. He is now an ancient, dried husk whose central eye has long since gone dim. He still retains his wizardly abilities (as per a 12th level wizard) and his minor eyes, but he spends most of his time playing chess with Theorx. Much of his mind is gone, and he does not remember if he has been here two years or 200. He has killed several of the other former captains who tired of life and tried to kill him.

The dark tower is the ship's brig—the dungeon—
where all the old captains go to "retire."

THE GRAND TOUR

The Lost Captains do not think of escaping the *Spelljammer*, for once the mantle of captaincy is lifted the mystic nature of the air envelope reasserts itself. Theorx is comfortable, Miark is absent-minded, and only Jokarin still plans to escape. But he wishes only to escape the dark tower so that he can get his hands on another ultimate helm and retake the *Spelljammer* for his own.

Arcane knows about the three Lost Captains, plus the one he has slain. No other inhabitants aboard the ship know about the Lost Captains, and the ship itself will not inform the present captain of his predecessors and their fates, nor will the ship allow the captain access to the dark tower. If the captain insists on breaching the tower door, the *Spelljammer* will let him in . . . and not let him out.

39) The Batteries

District: *Wing warrens*

Inhabitants: *Various races*

Leaders: *Various*

Activity: *Low*

Morale: *See below*

Armament: *See below*

The batteries are the permanent installations of the *Spelljammer's* large ballistas. There are 10 ballistas per battery, arranged in two floors of five ballistas each. Each large ballista is on a great pivot and riser, which allows the weapon to hit any target visible on or above the *Spelljammer*.

The batteries are under separate commands. Some commands are shared by races, others are totally under the control of a single race. It takes about 40 people to man a battery. Usually only 20 are on station at any given time (and only half the ballista will fire), unless the great ship is under attack, in which case there will be the full complement.

The standard operating procedure is that nonhostile ships should be permitted to land. Hostile is defined as those that openly attack the ship—fire is instantly returned. The elves consider any goblin ship hostile and will open fire upon identifying their ships—this is an exception to the general rule.

The commands of the various batteries are comprised as follows:

- **39A, human contingent**—members of the Collective, Father Goat's church, the Guild, and the military brotherhoods; morale 13.

- **39B, dwarf contingent**—members of the Free Dwarves and the dwarves of Kova; morale 14.

- **39C, elf contingent**—members of the Elven High Command; morale 17. They are the most likely to fire on enemy ships.

- **39D, neogi contingent**—neogis and their slave races; morale 9.

In addition, the illithids have in the past volunteered to man a battery, but the elves will not trust the mind flayers' goblin allies, even enslaved, inside the batteries.

The batteries contain sufficient shot and replacement parts for a sustained battle (about 200 bolts per tower) and replacement parts sufficient to build five large ballistas. The humans' replacement parts have been stolen and now turn up at the market from time to time, and the parts have not been replaced in their battery. This equipment does not include the resources of the armory.

40) The Dracon Tower

District: *Wing warrens*

Inhabitants: *Dracons, one brass dragon*

Leader: *Kaba Danel*

Activity: *Low*

Morale: *13*

Armament: *See below*

The wing towers of the *Spelljammer* are the site of the heavy catapults. The left wing tower is manned by a colony of some 40 dracons (see the *Lorebook of the Void* from the original SPELLJAMMER™ boxed set for more information) who keep the catapults in operation, occasionally aided by lizard men from the gardens. The two races are on good terms, and a large number of lizard men are adopted members of the dracon clan.

The dracons have also adopted a prophet, a ma-

The four batteries located on the *Spelljammer's* wings are controlled by humans, dwarves, elves, and neogi—but not by goblins.

THE GRAND TOUR

ture female brass dragon named Suza. Suza was brought to the *Spelljammer* by a neogi leech and subsequently freed of its effects and rescued by the dragons, who consider dragons to be the mouthpieces of their gods.

The talkative Suza warmed to the task and was soon making prophecies and reciting words of wisdom "from the dracon gods." She nearly had the dragons off on a holy crusade against the rest of the *Spelljammer's* inhabitants before the shalla (dracon high priest) of the tribe had a heart-to-heart chat with the dragon (which he apparently backed up with some magical firepower). Suza saw the error of her ways and has gone back to making simpler prophecies, to the whole-hearted relief of everyone on board the *Spelljammer*.

Suza has settled into a comfortable life as the dragons' religious icon/mascot. She has learned to revel in the dragons' worship of her and to accept her good fortune. She has in fact, on occasion, even come to the ship's aid when the *Spelljammer* was under attack.

While Suza could theoretically fly away from the ship, she has no intention of ever leaving because her setup is such a sweet deal in her opinion. Suza's quarters are in the large central keep in the heart of the complex; the dragons use the wide, flat dormitories adjacent to the main structure. (Suza is listed in the section on "Personalities of the *Spelljammer*," below.)

The catapult tower carries some 15 large catapults mounted on the main keep and the tower rising from it. Most of the interior space of the upper tower is taken up by a variety of shot (from large stones to nets filled with rubble) for use as antipersonnel weapons.

The catapults are only manned at full strength in case of large-scale assaults (against a fleet, say) or an uprising or major battle taking place in the citadel district.

The dragons will take in what refugees they can from the other races, but except for the lizard men they have no real allies on the ship. The dragons have a distinct hatred for the neogi and would gladly open fire on them if given the chance.

41) The Centaur Tower

District: *Wing warrens*

Inhabitants: *Centaur, wemics*

Leader: *Mostias*

Activity: *Low*

Morale: *5 (centaurs); 15 (wemics)*

Armament: *See below*

The right wing tower of the *Spelljammer* contains the remaining 15 large catapults. This encampment is staffed by centaurs, who under their present leader Mostias have let their post fall into disrepair.

There are about 60 centaurs in the tower. Their living quarters are large, low stables on the outward side of the structure. The central keep has been converted into a small garden given over entirely to grains and mushrooms. The former are from the centaurs' homeworld, while the latter are a gift from the illithids, who lost a racing bet with the horse men. Both grains and mushrooms are used to make potent ales and wines, some of which are served in the Open Air at the market but more of which are consumed by the centaurs themselves.

Mostias is the greatest spirits consumer of his tribe—a great, fat centaur whose powerful legs still look unable to support his truly massive frame. His predecessor mysteriously disappeared while supposedly exploring the dark tower, and Mostias called in his political favors with a number of the clan leaders to assume command. (See "Personalities of the *Spelljammer*," below, for more information on the centaur Mostias.)

Under Mostias's rule, the centaurs have become soft—relaxing and enjoying life more, practicing their weapon skills less. Their morale is -2 for all attacks against them. If pressed, they will abandon their positions. If the mind flayers themselves had tried, they could not have done a better job than Mostias to undermine the military power of the centaurs.

In addition to the centaurs, the tower is the home of a family of five wemics, who are much more conservative and frown upon Mostias's tendency to party as if there were no tomorrow. The wemics are led

A brass dragon has made her lair on the great ship.
She has set herself up as the religious icon of the dragons.
She is very faithfully worshiped. . . .

THE GRAND TOUR

by an individual of maximum hit points named Webber, who is as gruff and short-tempered as Mostias is open and well-meaning. The lion men currently live in the upper tower among the additional weapons. They make sure the catapults are in good shape, even if their crews are not.

Mostias is on excellent terms with almost all the races on the ship that prefer a good time—humans, dwarves, illithids, elves (to a lesser extent), and especially halflings, who have a regular trade set up with the centaurs.

The centaurs' grain crops have been in decline for the past three years, in part because of bad light plates that have not been replaced and because of the spreading mushrooms, which must be periodically cut back before they crowd out the grains. Mostias has not worried about the crop problem, but the centaurs could soon suffer for their lack of action.

42) The Warrens

District: *Wing warrens*

Inhabitants: *Undead, scattered monsters*

Leader: *The Fool*

Activity: *Moderate*

Morale: *As per monster*

Armament: *Individual*

The body of the *Spelljammer* is not a solid slab but rather a thick porous substance riddled with tunnels and passages beneath the tough leather of its "skin" and the hard chitin of its buildings. These tunnels run from wingtip to wingtip, from eyes to tail, and beneath most of the buildings.

The tunnels are not meant for inhabitation but are usually used by the shivaks for access to repairs to the great ship. They have, however, been taken over by a type of creature that the *Spelljammer* cannot directly detect: the undead. The tunnels have become their warrens, and their leader is the Fool. (See "Personalities of the *Spelljammer*," below, for more information on the Fool.)

There are nearly 200 undead on board the *Spelljammer*, most of them zombies animated by the Fool. These undead creatures are a mixture of hu-

manoid (common) zombies (80%) and larger (monster) zombies (20%). The bulk of the latter are umber hulks who were waylaid while digging and who were subsequently ambushed by the undead.

In addition to the zombies, the Fool is served by 20 ghouls, a trio of spectres, and a banshee. The last is a recent addition, and she is the elf that the Fool convinced to plant the device that destroyed the Elven Academy. All are under the total control of the Fool.

In addition to the regular zombies, there are a number of zombie rats. The Fool has taken care of the typical vermin problem found on many large ships by turning the *Spelljammer's* vermin into his own agents. With the zombie rats, he can monitor passageways and set up ambushes.

The undead have established nests within the ship, from which they waylay and destroy shivaks and any adventurers who find their way into the ship's tunnels. They continually move their base of operations so that they cannot be pinned down. As the *Spelljammer* cannot detect the undead, its shivaks are only noted as failing in some way and not as being attacked. If too many shivaks fail in the same area, the captain (through the subliminal suggestions made by the ship) will send out a team of adventurers to deal with the problem.

Adventurers sent out and those that go to the warrens of their own volition have to deal with the menaces presented by both the undead and any shivaks they encounter. Shivaks consider the warrens to be the ship's region and, as such, living interlopers (which they can detect) are captured and removed. Those that can evade the shivaks and the undead will likely find hidden troves of treasure, left either by the undead or their victims.

The warrens have a number of entrances, including two in the gardens (well guarded and used by the shivaks), one in each tear duct of the *Spelljammer's* "eyes," one beneath the gnoll ruins (Area #21), one in the shivak terminal (Area #15), and one at the Academy of Human Knowledge (Area #34).

The Fool is Romar, a former captain who escaped the fate of the other Lost Captains by embracing undead life and becoming a master lich. (See the entry

The undead have established nests within the ship, and they can be encountered anywhere within the warrens.

Area 42

The Warrens

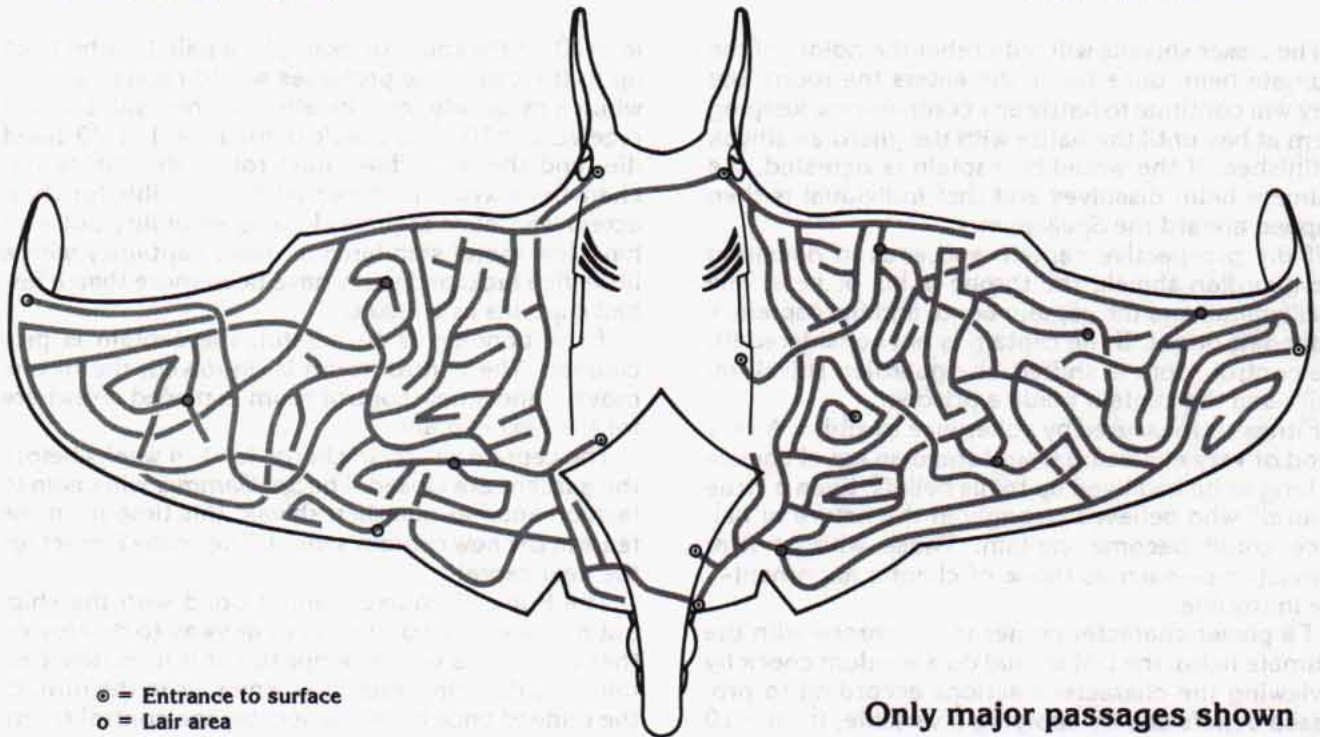

for master lich in the section on "New Monsters" for further information.) He lives for the destruction of the *Spelljammer* and, if he survives that destruction, the destruction of all its spawn.

43) The Control Room

District: Ship's region

Inhabitants: None

Leader: The captain

Activity: None

Morale: N/A

Armament: None

The control room of the *Spelljammer* is the location of the ship's "soul"—its personality and its spirit. It is the location where the prospective captain, armed with his or her ultimate helm, will be accepted by the *Spelljammer* and attain the captaincy.

The location of the control room is not provided on any map in this set. Such information should be determined by the DM, who can locate it anywhere he or she sees fit. Suggested locations for the control room include:

- In the tail assembly, directly behind the sphere of annihilation converter.
- Behind one of the *Spelljammer's* eyes.
- Beneath the plaza below the dwarven foundry.

- In the heart of the shivak terminal.
- In an unused section of the armory.
- Beneath the exact center of the gardens.

The control room will *not* be located in either the dark tower or the warrens, despite local tales and false stories to the contrary. The former is too close to the Lost Captains, while the latter is too close to the Fool.

The ultimate helm acts as a divining rod, tugging the user toward the control room's correct location. These tugs are felt at hour intervals and will only indicate direction—not exact distance or placement. How the would-be captain reaches the control room is up to him or her—only rarely is the room protected by something as simple as a secret door. Much more likely the finding will involve burrowing into the ship (thus attracting shivaks in the process, unless the individual is unusually quick).

The control room contains only an ornate throne and the guardian shivak. The guardian is a special form of shivak created by the *Spelljammer* from the fears of the previous captain. The guardian has similar powers as other shivaks, but it gains special abilities according to the creature it duplicates. The guardian at the moment is a giant illithid shivak, conjured from the mind of Jokarin. It is equipped with a psionic blast similar to that of a mind flayer.

THE GRAND TOUR

The lesser shivaks will not bother the holder of the ultimate helm once he or she enters the room, but they will continue to battle any companions, keeping them at bay until the battle with the guardian shivak is finished. If the would-be captain is defeated, the ultimate helm dissolves and that individual is then trapped aboard the *Spelljammer*.

If the prospective captain succeeds in defeating the guardian shivak, the throne is his or hers. The *Spelljammer* and the captain bond, and the captain is judged fit or not. If the captain is not considered fit, the control room is shifted, the guardian shivak rebuilt, and the captain made a prisoner.

Fitness is measured by adherence to ethics. A very good or very evil being would stand an equal chance as long as he had lived up to his beliefs. Even a "true neutral" who believed strongly in the nature of balance could become captain. Those without firm convictions—such as those of chaotic alignment—are in trouble.

If a player character comes to the throne with the ultimate helm, the DM should do a Wisdom check by reviewing the character's actions according to professed beliefs and by applying a variable, from +10

to -10, to the roll. For example, a paladin who lives up to the cause she professes would receive a -10, while a mage who continually switched sides would receive a +10. The check is made with a 20-sided die, and the individual must roll under his or her character's wisdom. Note that it is possible for characters who have high wisdom as an ability but who have low moral standards to make captaincy with a little dice luck, and there have been more than a few bad captains as a result.

If the bonding is successful, the captain is proclaimed. The control room is dissolved, the throne moved, and a new control room is placed elsewhere for the next captain.

The captain will be in charge for 1-4 weeks before the gardens are closed. The *Spelljammer* will begin to fashion another guardian shivak, this time from the fears in the new captain's mind. The scene is reset for the next captain.

The Fool, of course, cannot bond with the ship, but he seeks the control room anyway to destroy either it or those who attempt to enter it. A new captain may thus find additional enemies in the form of the undead once he or she locates the control room.

Area 43

Control Room

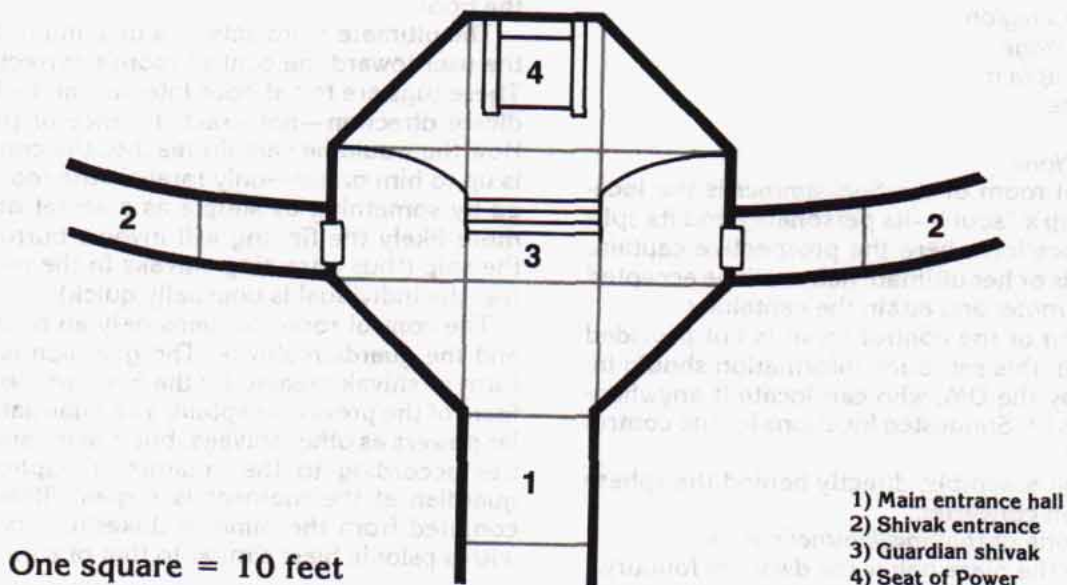

PERSONALITIES OF THE SPELLJAMMER

The *Spelljammer* is a huge ship, filled with a large number of individuals, races, and factions—all with their own goals and secrets. In the 96-page *Ships and Captains* book you will find a complete, detailed section describing the unique personalities found aboard the *Spelljammer*. Here, however, is a brief synopsis of those characters to help you moderate adventures on the *Spelljammer*. Feel free to cut out and use this section as a handy aid for enhancing these characters when using them in your campaigns. Each listing is organized as follows:

- Name;
- Level, class, race: where applicable (sex in parentheses);
- Headquarters: where normally found;
- Allies: stated or known friends;
- Foes: stated or known enemies;
- Goals: intentions for self and/or faction; and
- Secrets: personal information believed to be factual by that individual. (Note that not all secrets are true—you may have to check with "The Grand Tour" section under the headquarters listed to decipher the more contradictory details and to determine whether the individual would be willing to pass on this information. Keep in mind, however, that the characters below will play with their secrets—however errant—as truth as they perceive it.)

One final note: The characters listed below are arranged alphabetically as to their last name (if appropriate)—monikers and titles should be ignored. For instance, "Old Astor" is under "A" for Astor, and "Grand Knight Chaladar" is under "C" for Chaladar rather than "G" for Grand Knight.

Arcane

Level, class, race: Arcane (male)

Headquarters: 31

Allies: Gnomes

Foes: Captains, Fool

Goal: To escape the *Spelljammer*

Secrets: Understands everything about how to become captain of the *Spelljammer*; is insane; has sold portions of his secret to Demets and Stardawn

Argargon

Level, class, race: Former gnoll chieftain, now a zombie

Headquarters: 42

Ally: Fool

Foes: All living things

Goal: To serve the Fool

Secret: Survived the destruction of the gnoll citadel by the giff but was turned into an undead by the Fool

Arvanon the Lizard Priest

Level, class, race: 13th level lizard king priest (male)

Headquarters: 2

Allies: Lizard men, Demets, Suza

Foes: Those who attack the garden

Goal: To maintain the balance and the cycle of the *Spelljammer*

Secrets: The gardens close upon arrival of a new captain; smalljammers are grown in the gardens

Old Astor

Level, class, race: Beholder

Headquarters: 6

Allies: Halflings, Kristobar

Foes: Other beholders

Goals: To act as ship's steward; to prevent anyone from becoming captain; and to destroy all those who have insulted him

Secret: All but three of his eyes are functioning

Hammerstun Breakox

Level, class, race: Originally a hill giant but now cursed to appear as a minotaur (male)

Headquarters: 22

Allies: Minotaurs, hill giants, Father Goat, ShiCaga

Foes: Neogi, beholders, mind flayers

Goals: To keep the minotaurs free and to steal the hill giants from Taja

Secrets: Hates ShiCaga despite her being his ally; wants to kill Taja

Kristobar Brewdoc

Level, class, race: 5th level halfling fighter (male)

Headquarters: 6 or 14

Allies: Halflings, humans, Hancherback, Astor

Foes: None (at least none that he will admit to!)

Goals: To gather information and to serve drinks

Secrets: Privy to local gossip; thinks secret captains control the ship and that the Fool is a myth

PERSONALITIES OF THE SPELLJAMMER

Brother Burke

Level, class, race: 7th level human priest (male)
Headquarters: 34
Allies: Xenos, Hooded Soldier, Ollister, Si Loo (assumed)
Foes: All nonhumans
Goal: To destroy all nonhumans
Secrets: Is the front man of a terrorist organization; thinks Si Loo is the Hooded Soldier; is geased never to reveal these secrets

CassaRoc the Mighty

Level, class, race: 15th level human fighter (male)
Headquarters: 11
Allies: Humans, halflings, Chaladar, Chila, Kristobar
Foes: Those who attack humans, ShiCaga
Goals: To protect humanity and to have a good time doing so
Secret: Thinks the Fool is the secret captain of the *Spelljammer*

Grand Knight Chaladar

Level, class, race: 19th level human paladin (male)
Headquarters: 10
Allies: Humans, CassaRoc, Leoster
Foes: All evil creatures, all those who threaten humanity
Goals: To protect humanity and to eliminate evil
Secrets: Was not a hero in the War of the Lance; thinks the Fool was created by evil humans

Master Coh

Level, class, race: 8th level neogi wizard
Headquarters: 27
Allies: Neogi, umber hulks, Orik
Foes: Beholders, all other races
Goals: To defeat the beholders; to enslave all other races on the *Spelljammer*; and to become captain
Secrets: Is in communication with the Fool; thinks the Fool chooses the next captain and that the captain must be a magic-user

Kaba Danel

Level, class, race: Dracon leader (male)
Headquarters: 40
Allies: Dracons, lizard men, Suza
Foes: Neogi, beholders
Goal: To protect and lead his people
Secrets: None

Taja Deeplunder

Level, class, race: Frost giant (female)
Headquarters: 29
Allies: Giants, humans
Foes: Neogi, beholders, Breakox, Coh
Goals: To keep her people independent; to make ties with humans; and to collect new songs and tales
Secrets: Knows recent history and appearance of the Fool; knows cycle of the Dark Times

Demets

Level, class, race: 9th level lizard king priest (male)
Headquarters: 2
Allies: Lizard men, Arvanon
Foes: Those who threaten the gardens
Goal: To use food as a weapon to control the captain and the ship
Secrets: He sacrificed his sister to Arcane to learn part of the secret; captain must bring an artifact on board to become captain

Vagner Firespitter

Level, class, race: 10th level dwarf fighter (male)
Headquarters: 26
Allies: Free Dwarves, gnomes, Kova
Foes: Talentless critics, Arcane, Trebek
Goal: To preserve the creativity and artistic freedom of the dwarvish people
Secrets: Thinks the Fool was created by the Kovans; thinks the *Spelljammer* was created by dwarven gods and that it flies because of dwarven creativity

PERSONALITIES OF THE SPELLJAMMER

The Fool

Level, class, race: Master lich
Headquarters: 42
Allies: Hooded Soldier, Argargon
Foes: All living things, the *Spelljammer*
Goal: To destroy the *Spelljammer*
Secrets: Was once a captain of the great ship; communicates through his zombies; controls the zombies' actions

Father Goat

Level, class, race: Satyr (male)
Headquarters: 19
Allies: Humans, Communal Church members, Trebek, Breakox
Foes: Those who attack his people
Goal: To protect members of minority races under his care
Secrets: Is unknowingly charmed by Trebek; thinks the Fool was created by violence

Gray Eye

Level, class, race: Beholder
Headquarters: 24
Allies: Beholders of Area #24
Foes: All other beholders, neogi, Astor
Goals: To kill other beholders; to kill neogi; and to create a new slave race (perhaps minotaurs or ogres)
Secrets: Has undead beholder-mummies in tower; the Fool shifts his base around in the warrens

Admiral Drova Highstar

Level, class, race: 8th level elf fighter/7th level wizard (male)
Headquarters: 36
Allies: Elves, Stardawn
Foes: Goblins, Trebek
Goals: To eliminate the goblin menace; to defeat evil; and to teach other races to live like elves
Secret: Thinks the Fool is part of a goblin plot

The Hobgoblin Prophet

Level, class, race: 6th level hobgoblin shaman (or priest) (male)
Headquarters: 23
Allies: Hobgoblin refugees, ShiCaga

Foes: Mind flayers, ogres, ShiCaga's sons, Highstar, Trebek
Goals: To free his people from the mind flayers and to set up a utopia ruled by his people
Secrets: None ("In the utopia of our people, there will be no secrets—we will know everything")

Lord High Gunsman Rexan "Diamondtip" Hojson

Level, class, race: Giff commander (male)
Headquarters: 18
Allies: Humans, those who pay for his services
Foes: Neogi, illithids, gnolls, beholders, other evil creatures
Goals: To gather more smoke powder; to make giffs the premier military force on the ship; and to collect maps
Secrets: Has an extensive map collection; worries about getting old

The Hooded Soldier

Level, class, race: Zombie
Headquarters: 34
Allies: Xenos, Fool, Brother Burke, Ollister, Nagasimi
Foes: All living things
Goal: To serve the Fool by using the Xenos as a tool
Secret: Is an undead creature under control of the Fool

Chila Irontooth

Level, class, race: 18th level human fighter (female)
Headquarters: 12
Allies: Humans, halflings, CassaRoc
Foes: Those who threaten her charges
Goals: To protect her people and to make money
Secret: Thinks the Fool is a force of elemental evil, balanced by the Secret Captains of Good

Jokarin the Bold

Level, class, race: 10th level human fighter (male)
Headquarters: 38
Allies: Theorx, Miark
Foes: Shivaks, the *Spelljammer*
Goals: To escape the dark tower and to become captain again
Secret: Jokarin is a former captain

PERSONALITIES OF THE SPELLJAMMER

Selura Killcrow

Level, class, race: 18th level human fighter (female)
Headquarters: 33
Allies: Hill giants, Long Fangs' members, Korvok
Foes: All other leaders (including Korvok)
Goals: To kill all other leaders; to start a senseless bloodbath; and to steal away Taja's hill giants
Secrets: Hates Korvok; was rejected by Stardawn

Korvok the Fell

Level, class, race: 17th level human thief (male)
Headquarters: 32
Allies: Members of the Tenth Pit, any who pay him to kill, Selura
Foes: All who get in his way
Goals: To discover secrets and to start wars with them
Secrets: Has a crush on Selura

Lord Agate Ironlord Kova

Level, class, race: 12th level dwarf fighter (male)
Headquarters: 25
Allies: All dwarves, Firespitter
Foes: None
Goals: To continue to build and create and to protect his people by keeping other races at arm's length
Secrets: Thinks the dwarves provide the motive force for the *Spelljammer* and that the ship is ruled by a secret cabal of elder dwarves

His Majesty, the Pulssant and Sage Leoster IV

Level, class, race: 20th level human fighter/13th level wizard (male)
Headquarters: 13
Allies: All humans, Guild nobles, Chaladar
Foes: All who attack the Collective
Goals: To lead by good example; to punish those who attack the Collective; and to work on his coin collection
Secret: Thinks his advisor created the story of the Fool

Miark the Blind

Level, class, race: 12th level beholder wizard
Headquarters: 38
Allies: Theorx, Jokarin

Foes: None

Goals: When lucid, to escape and destroy other beholders; otherwise, to play chess

Secrets: Miark is a former captain of the *Spelljammer*, the only beholder ever to captain the ship

Mostias

Level, class, race: Centaur (male)
Headquarters: 41
Allies: Centaurs, humans, wemics
Foes: None
Goal: To party hearty!
Secrets: None

Nagasimi

Level, class, race: 12th level human wu jen (or wizard) (male)
Headquarters: 30
Allies: Shou, Si Loo, Hooded Soldier
Foes: All non-Shou and nonhumans
Goals: To eliminate all nonhumans and to enslave all non-Shou humans
Secrets: Sends Si Loo's representatives to the Xenos; provided smoke powder to destroy the elven academy; thinks the Fool is an outlander fairy story

Ollster

Level, class, race: 7th level human fighter (male)
Headquarters: 13 or 34
Allies: Guild nobles, Xenos, Hooded Soldier, Brother Burke, Leoster
Foes: None
Goal: To have a ripping good time
Secrets: Is a member of the Xenos (though he is unaware of their terrorist acts); believes the Fool was a story created by his grandfather

Orlk

Level, class, race: Umber hulk slave
Headquarters: 27 or 28
Allies: Umber hulks, neogi, Coh
Foes: Anyone who threatens Coh
Goals: To protect Coh and to convince others that everyone should "belong" to Coh
Secret: Coh battles the Fool, but no one wants to help him

PERSONALITIES OF THE SPELLJAMMER

Lord Mayor Hancherback Scuttlebay

Level, class, race: 10th level halfling thief (male)
Headquarters: 14 or 6
Allies: Halflings, humans, Kristobar
Foes: None
Goals: To protect his people and to make money while doing so
Secret: Thinks the Fool is a parasite from a lower plane

ShiCaga the Enchantress

Level, class, race: Ogre mage chieftess (female)
Headquarters: 23
Allies: Ogres, hobgoblins, her sons, the Hobgoblin Prophet, Breakox
Foes: Trebek, CassaRoc
Goals: To free goblin races from the mind flayers and to set up a nonhuman community ruling the ship, with her in charge
Secrets: Believes the Fool is a story created by Good to slander Evil; will gladly send Breakox to his death (despite his being her ally)

Magistrate Under the Heavens Si Loo

Level, class, race: 8th level human bushi (or fighter) (male)
Headquarters: 30
Allies: Shou, Nagasimi
Foes: All who oppose his rule
Goal: To rule the *Spelljammer* wisely in the name of the Shou Emperor
Secrets: Si Loo is not a member of the Xenos, although the Xenos believe him to be

Lothian Stardawn

Level, class, race: 6th level elf fighter (male)
Headquarters: 36
Allies: Elves, Highstar, Arcane
Foes: Goblins, potential captains
Goal: To take command of the *Spelljammer* and bring her to the Elven Admiralty
Secrets: Listed goal is a secret mission; has had dealings with Arcane; stole the master seed in payment for Arcane's information; knows that the new captain will be carrying a symbol of power to identify him- or herself

Suza the Brass

Level, class, race: Mature brass dragon (female)
Headquarters: 40
Allies: Dracons, Arvanon
Foes: Neogi
Goal: To have a good time with her role as the dracons' religious icon/mascot
Secrets: Knows local gossip

Theorx the Aged

Level, class, race: 13th level human priest of Odin
Headquarters: 38
Allies: Miark, Jokarin
Foes: None
Goals: To play chess and to write
Secret: Theorx is a former captain

Trebek

Level, class, race: Mind flayer
Headquarters: 16
Allies: Mind flayers, goblins, Father Goat
Foes: Elves, any who stand in his way
Goal: To enslave the *Spelljammer's* inhabitants
Secrets: Does not believe in the Fool; has charmed Father Goat



Kasharin



CLIMATE/TERRAIN:	<i>Spelljammer</i> (beholder tower)
FREQUENCY:	Rare
ORGANIZATION:	Community
ACTIVITY CYCLE:	All
DIET:	Nil
INTELLIGENCE:	High (13-14)
TREASURE:	Nil
ALIGNMENT:	Neutral evil
NO. APPEARING:	1-4
ARMOR CLASS:	6
MOVEMENT:	Fl 3 (B)
HIT DICE:	10
THACO:	11
NO. OF ATTACKS:	1
DAMAGE/ATTACK:	2-12
SPECIAL ATTACKS:	Deathcharm eye
SPECIAL DEFENSES:	Nil
MAGIC RESISTANCE:	Nil
SIZE:	M (4-6' diameter)
MORALE:	Fearless (19-20)
XP VALUE:	3,000

The kasharin are those beholders who contracted the Blinding Rot disease and who survived long enough to seemingly die from the disease and not from beholder retaliation. (The Blinding Rot caused the beholders' eye stalks to wither and decay and subsequently fall off, leaving the beholder severely disabled if not dead. At least half of the beholders aboard the *Spelljammer* acquired the disease, but most of those afflicted were killed by their fellow beholders during the early stages of the disease, so great is the race's xenophobia over any disparity in the eye tyrant race.)

The disease did not actually kill the creatures, but rather placed them in a state of living death. They still register as living beings according to the shivaks' ability to detect life, and thus they still receive food rations from the ship's stores. The kasharin operate on that thin edge between the living and the undead, but for how long they can remain so is unknown. Currently they are being cared for by the beholders in their tower; the kasharin are given healing magics and minimum food rations to maintain their existence in the event that they can be made into servants for the Gray Eye (the leader of the beholders aboard the *Spelljammer*).

The kasharin appear to be blackened, burnt beholders, their scales curled and separated, apparently from some intense heat. Their eye stalks are charred and useless, but their central eye still remains intact and usable.

Combat: The beholder-mummies' main form of attack is their central eye. It retains the range it had when alive, but the eye now has a two-pronged attack. The eye acts as a powerful *charm person/monster* to those characters or creatures who are affected by such spells; to those who are not, it acts as an equally powerful ray of death magic.

Any who encounter the kasharin make their saving throws at -4. If they can be charmed and fail their first saving throw, they continue to make all successive saving throws to shake off the charm at -4 as well. Creatures and characters that cannot be charmed because of inner magic resistance or immunity must make a saving throw versus death magic at -4, with failure indicating immediate death.

Beholder-mummies can be turned or destroyed if confronted with sufficient clerical power. Treat them like ghosts or other 10 HD monsters.



Habitat/Society: The beholder-mummies retain their xenophobic hatred, but the hatred is now focused on all surviving living beholders. The kasharin's new state has, curiously enough, made them more forgiving toward the denizens of the undead, but these feelings occur only if the undead cannot otherwise affect the beholder-mummies.

Only beholders that have passed completely through the transformation caused by the Blinding Rot are considered "true" beholders by the kasharin. To them, the beholders of any subrace that have passed "the test" are now considered brethren, while any former (and living) relations are not, regardless of whether they were once the same subrace. The xenophobic hatred that drives multiple subraces apart in the world of the living beholder has been simplified to simply living versus unliving in the beholder-mummy world. The transformation to undead may prove to be a blessing in disguise for the strife-ridden beholder factions.

Ecology: The kasharin are products of the disease that has transformed them into their present state. They are changed both in body and in mind, yet they retain many of their natural beholder tendencies.

The beholders kept within the tower have now been metamorphosed into beholder-mummies, but the plague itself originally came from beyond the decks of the *Spelljammer*. It may be that there are colonies (and perhaps even entire planets) of beholders so infected somewhere in the Known Spheres.

The Blinding Rot was originally developed as an "ultimate unifier" of the beholder race. The philosophy behind its development is that it brings the beholders—every race, subrace, and sub-subrace—together in a single, unifying death. Rising from the ashes of that death is a new race, a *single* race of beholder-mummies. All creatures of space must fall to the beholders, and now all the undead must fall to the beholder-mummies.

CLIMATE/TERRAIN:	Wildspace, jungle
FREQUENCY:	Rare
ORGANIZATION:	Community
ACTIVITY CYCLE:	Day
DIET:	Carnivorous
INTELLIGENCE:	High (13-14)
TREASURE:	A (N)
ALIGNMENT:	Lawful neutral
NO. APPEARING:	10-40
ARMOR CLASS:	5
MOVEMENT:	12
HIT DICE:	3
THACO:	18
NO. OF ATTACKS:	1
DAMAGE/ATTACK:	By weapon or 1-4
SPECIAL ATTACKS:	Nil
SPECIAL DEFENSES:	Nil
MAGIC RESISTANCE:	Standard, +4 vs. illusions
SIZE:	M (5-6' tall)
MORALE:	Fanatic (17-18)
XP VALUE:	1,400

The k'r'r'r are sentient spiders that developed in deep space. Unfettered by a dependency on gravity, the k'r'r'r are not locked into the two-dimensional thought processes that seem to affect other races. Their homes and ships can be built of three-, four-, or five-sided designs to suit their needs.

The k'r'r'r are firm in their belief that their place is at the apex of creation. The rest of the Known Spheres is a larder for their kitchens and a quarry for their constructions. It is their destiny to exploit all the resources that their gods have made available to them. The k'r'r'r's duty is to organize themselves so that they may fully grasp that destiny.

The k'r'r'r look like thin spiders resting on stiltilike legs. Whereas most spiderlike beings are relatively horizontal with bodies held close to the ground, the k'r'r'r are upright with torsos held 2 feet off the ground. This disparity is attributed to a superior design granted by the gods.

The k'r'r'r come in shades of black and dark blue. A sky-blue strain is a natural mutation, and they are considered touched by the gods and treated with inordinate respect.

Combat: The forward pair of legs are smaller than the other six, and they end in delicate claws used for manipulating tools and weapons. The head is multieyed but dominated by two primary orbs. The multiple eyes coupled with high intelligence provide the race with a +4 to saving throws versus illusion/phantasm spells. The head also has great jaws that allow the k'r'r'r to bite if it is weaponless.

K'r'r'r prefer spears, pole arms, and other piercing weapons to the shorter weapons such as maces. They are physically hampered when using weapons that require slashing strokes, such as swords, and they suffer a -1 to hit penalty with them. K'r'r'r do not use bows, but they can use specially modified and mounted crossbows and starwheel pistols, though each weapon takes an additional round for the k'r'r'r to load. In combat, the k'r'r'r who have such weapons fire the first round then use their pole arms thereafter. Those without a secondary weapon will bite for 1-4 points of damage.

One k'r'r'r in 10 has exceptional abilities. Half of these are higher level fighters, with additional 1-6 HD. The other half are specialist priests of levels 3-12. These specialized priests have limited access to spells (All, Guardian, Protection, and Sun spheres only), and they are used primarily as



helmsmen for exploration and colonization vessels.

Habitat/Society: The k'r'r'r believe they have the right to colonize and exploit the remainder of the universe. Their logic to support this philosophy is straightforward: Other races in space apparently come from one grounding society or another—they have no more purpose in space than does a fish on land. The k'r'r'r, however, were born to the void.

To that end the k'r'r'r are expanding their infiltration of various spheres through use of their unity fleets. These fleets are like caravans to the stars, identical ships being constructed and sent out one after another. The ships are modular, and once they arrive on the scene they can link up to form larger, more powerful ships to defeat an enemy. The peculiar nature of the k'r'r'r allows their ships to move quickly on a tactical scale, even if the ships have linked together and exceed the normal 100-ton limit. It is a combination of the k'r'r'r's mindset and their specialized helms that allows them to pull off this maneuver—a maneuver that other races, even with k'r'r'r helms, have not been able to duplicate.

The k'r'r'r are led by their strongest fighter, supported by priests. The fighter and priests are likened to empty vessels that must be filled by the k'r'r'r spider-god called the Wise Queen. Her body is jet black, and she has a humanish mold to her face. The k'r'r'r consider her superior to all other gods just as the k'r'r'r are superior to all other creatures.

There is a disturbing similarity between the k'r'r'r Wise Queen and the Dark Elves' Lloth. The drow goddess is extremely chaotic and utterly evil—could she be advising and providing spiritual leadership for a group of neutral but primarily lawful spider-creatures? The answer is unknown.

Ecology: The k'r'r'r are carnivores and will eat any creature, including their own dead, in order to survive. However, they are extremely efficient feeders and do not need to eat often, and a single meal will hold a k'r'r'r for two months or more. There will be dried meats of unknown origin on k'r'r'r ships.

Lich, Master



CLIMATE/TERRAIN:	Spelljammer
FREQUENCY:	Unique
ORGANIZATION:	Leader
ACTIVITY CYCLE:	Continuous
DIET:	Nil
INTELLIGENCE:	Genius (17-18)
TREASURE:	H×4
ALIGNMENT:	Chaotic evil
NO. APPEARING:	1
ARMOR CLASS:	-2
MOVEMENT:	6, Fl 12 (C)
HIT DICE:	13
THACO:	8
NO. OF ATTACKS:	2
DAMAGE/ATTACK:	3-18 (or by weapon)
SPECIAL ATTACKS:	See below
SPECIAL DEFENSES:	See below
MAGIC RESISTANCE:	20%
SIZE:	M (5½' tall)
MORALE:	Fearless (19-20)
XP VALUE:	15,000

The master lich is a variation of the standard lich developed from a combination of incantations, potions, and promises made to dark, extradimensional powers. An undead creature becomes a master lich until such time as it must pay the price of the promises given to the dark powers.

The master lich resembles a normal lich in many ways, save that its flesh is not rotted. Rather, the body is desiccated, the skin pulled back like leather over the skull and bones. It retains the standard lich's deep-set, black eye sockets, with burning white pinpoints of light dancing deep within the recesses.

Combat: A master lich will not enter into direct combat unless he has no other choice or unless his target is helpless and easy to slay. If he chooses to avoid physical combat, he uses his ability to animate the dead to create an army of undead skeletons and zombies to fight in his stead.

The undead are under the master lich's full control, and all their actions can be manipulated by the lich. He can see through the remains of their eyes and hear through the remnants of their ears. Any living creature killed by or through the master lich's hand can be reanimated in this fashion.

In addition to retaining the abilities gained when alive, the master lich can paralyze on touch. Those failing a saving throw versus paralyzation will be immobile for 4-24 rounds.

The master lich cannot be affected by enchantment/charm or necromantic spells, including those that allow others to control the undead. He is also unaffected by polymorph, poison, cold, insanity, and electricity magic. The master lich can be turned, however, except when he is on his home grounds; treat this lich as a special undead for purposes of turning. (The home grounds of the master lich known as the Fool are located in the warrens of the *Spelljammer*, and he is the only known example of a master lich. However, given the vastness of space, there is no telling whether another master lich may already be created—or when another may occur.)

Unlike normal liches, the mere appearance of a master lich does not cause fear, and he may be struck with normal weapons. The master lich does regenerate 1 point/round and will do so even if the body is destroyed and separated. As such, he is truly undead.



This lich is not restricted to humans and humanoids when creating undead. Long-dead creatures become skeletons, humans and humanoids become zombies, and all other large creatures become monster zombies. In addition to his regular zombies and skeletons, the Fool has created a pack of undead rats (1 HP, AC 9, MOVE 6, all other stats as per normal rats). These rats serve as his eyes, scouting the warrens for potential targets or enemies.

Habitat/Society: The master lich is not as solitary as are his lichling counterparts. Rather, he prefers to be at the apex of an undead society, typically of his own creation. He commands his skeletons and zombies without question and imposes his will on other undead through the force of his personality or through threat if need be. Any type of less-powerful undead may be under the command of a master lich, excepting only liches, arch liches, and demiliches. Vampires and other sentient undead will be treated as uneasy allies at best.

Since the master lich exists in part because of his eluding some dark bargain, he seeks safety in numbers. In particular he seeks protection from those who might seek to take the master lich to his final death.

Ecology: The master lich is undead, and with his regenerative properties can survive until he falls under the one true death. This will only happen if either of two events occur: if a dark power shows up to collect the lich's immortal spirit in payment, or if the lich is captured and dragged to a power's home plane. The master lich fears the dark powers that helped make him more than anything else in the world, for they are the ones who will prove to be his undoing.

Occasionally a master lich will fixate on a particular place, event, or person, and he will work to the best of his undeadly ability to control that place, event, or person. This becomes an overriding obsession with the master lich, eventually negating all other needs.

	Common	Guardian
CLIMATE/ TERRAIN:	Spelljammer	Control room
FREQUENCY:	Common	Unique
ORGANIZATION:	Squad	Solitary
ACTIVITY CYCLE:	Continuous	Continuous
DIET:	None	None
INTELLIGENCE:	High (13-14)	Genius (17-18)
TREASURE:	None	None
ALIGNMENT:	Neutral	Neutral
NO. APPEARING:	1 or 1-8	1
ARMOR CLASS:	3	-3
MOVEMENT:	12	12
HIT DICE:	5	20
THACO:	16	1
NO. OF ATTACKS:	2	2
DAMAGE/ATTACK:	1-8	3-18
SPECIAL ATTACKS:	See below	See below
SPECIAL DEFENSES:	See below	See below
MAGIC RESISTANCE:	40%	60%
SIZE:	S or M (3-5')	L (10' high)
MORALE:	Fanatic (17-18)	Fearless (19-20)
XP VALUE:	5,000	23,000



increase its movement to 24 at will.

- *Beholderian*—The beholderian shivak is a floating egg-shape that has a bundle of tentacles nestled around its crown. It does not have the eyes of a beholder, but its coils are incredibly strong (STR=19). More importantly, this shivak can fly at its normal movement speed, and it has an MC of A.

- *Serpentine*—The serpentine shivak is a narrow ellipsoid that has an extended tail, which the shivak uses to coil around its opponents. It constricts its target, then crawls off with the creature still in its coils. The serpentine shivak has the ability to compress its body as well, allowing it to squeeze into spaces no more than 1 foot across in pursuit of its opponent.

- *Spiderian*—Also called neogian, this shivak is a horizontal ellipsoid much like the centaurian's body. This shivak's body, however, is supported by eight movable legs and is slung upward like a spider. Spiderian shivaks have the ability to spit a paralyzing poison up to 20 feet away. This poison can freeze an opponent for 1-3 rounds—enough time for the spiderian (and the other shivaks as well) to overwhelm and remove the intruder.

- *Enigmatic*—The enigmatic shivak is a mystery because it does not resemble any of the currently known major races of space. This shivak has a triform body, with three stump-like limbs and three arms coiled like rope and ending in trilateral "hands." While it resembles both the xorn and the triphegs, neither of those races have been known to have had a major impact in space outside their home worlds. The enigmatic shivak has a nasty ability in that it may produce a shocking grasp (as per the spell) for 2-12 points of additional damage when grappling with an opponent. This is only used to shock its opponents into submission.

The shivaks are only found aboard the *Spelljammer*, and they are constructed (grown) in a manner similar to the smalljammers. In the shivaks' case, they are constructed in the shivak terminal (Area #15) rather than in the gardens (Area #2) like the smalljammers. The shivaks grow in pods out of the lifeless corridors.

When shivaks are destroyed or wear out, more are constructed. Those that are not immediately needed are kept in storage, where they are maintained on small amounts of energy from the ship. There are about 500 shivaks on board the ship at any one time.

Shivaks resemble headless ellipsoids that have limbs. The limbs are arranged in such a manner that varieties of shivaks resemble various species aboard the ship.

The surface of a shivak appears to be covered by a thick gray leather. However, this leatherlike exterior extends fully to the core of a shivak—in other words, shivaks lack organs in the known sense. The limbs are made of similar material, and they are what allow the shivaks to maneuver. (Shivaks move forward, backward, and sideways at will, much as if they were on rollers.)

Each variety of shivak also has a special attack form that it may use at will as described below.

COMMON SHIVAKS

The types of common shivak include the following:

- *Humanoid*—This shivak has humanoid limbs that consist of two stumplike legs and two multithinged arms, each arm ending in a delicate bundle of tapered coils. The coils allow the humanoid shivak to perform delicate work, but the humanoid's chief attribute is incredible strength. At will, they may raise their strength to that of fire giant level, gaining +4 to hit and +10 to damage.

- *Centaurian*—The centaurian shivak's elliptical body is horizontal rather than upright. It is supported by four horse-like limbs, and it has a set of multijointed humanoid arms mounted at what is presumed to be the forward end of the shivak. The centaurian's chief attribute is speed, and it can

Shivak

Combat: The shivaks in battle fight as a unified whole, regardless of their appearance. Their tactics are generally straightforward, consisting of overwhelming their opponents with numbers, then carting them off. Their main function seems to be to keep trespassers out of areas of the *Spelljammer* that are off limits.

The shivaks are apparently connected to both the ship and to each other, for attacking one shivak typically brings others in quick succession (usually 1-8 additional shivaks will appear 3-6 rounds after the initial attack).

The shivaks have been given only limited orders, however, and they will only attack if they are attacked, if a creature is in a restricted area, or if they are prevented from doing their normal tasks, which include food delivery and dismantling ships. Otherwise they tend to leave the other races on board alone and are in turn left alone by other races.

The shivaks are immune to illusion and light-based attacks. They cannot be poisoned, polymorphed, or paralyzed, nor may they be charmed or otherwise affected by enchantment spells, including sleep. They are immune to their own attack forms, including those of other shivaks.

The shivaks do not see in the traditional sense, but rather they emanate a continual detect life. Otherwise invisible living creatures stand out brightly to them, as do those masked by illusion spells. They know the buildings and warrens of the ship by heart and can move smoothly around inanimate objects. However, animate, unliving creatures (such as undead, golems, and clockwork horrors) are invisible to them. They cannot attack what they cannot see, though they may flail around at -4 to hit.

Habitat/Society: The shivaks have no real society and are little more than extensions of the will of the *Spelljammer* itself. Unless specifically commanded otherwise by the captain, they will continue to perform their normal duties.

When under the control of the captain, they will respond to his or her orders as long as those orders do not directly contradict the shivaks' functions. (For instance, the captain cannot order the shivaks to *not* attack a trespasser found in the warrens.)

Ecology: The shivaks are "grown" in the shivak terminal, far from the light of the gardens, in great pods hanging from the wall. Unlike the smalljammers, the shivaks' only requirement for development is the presence of a spelljamming helm, which will create 1-10 new shivaks. Any spelljamming helms that are found will be taken back to the terminal for future use.

It takes only a few days for the terminal to create these shivaks once it has a new helm. The process is similar to the creation of the smalljammers upon the arrival of a new captain. The spelljamming helms, however, are consumed in the process and cannot be regained.

GUARDIAN SHIVAK

The guardian shivak is the largest of the shivaks and is found only in the control room. (The control room is an area that appears on the *Spelljammer* only when a prospective captain comes on board; the area randomly shifts position throughout the ship and is seldom found in the same place twice in a row. The adventurer must defeat the guardian shivak to bond with the ship and become captain.)

The guardian shivak is built to encompass the worst fears of the previous captain. As such, it strongly resembles the physical form those fears take (as opposed to the elliptical shape of the other shivaks). The current guardian shivak re-

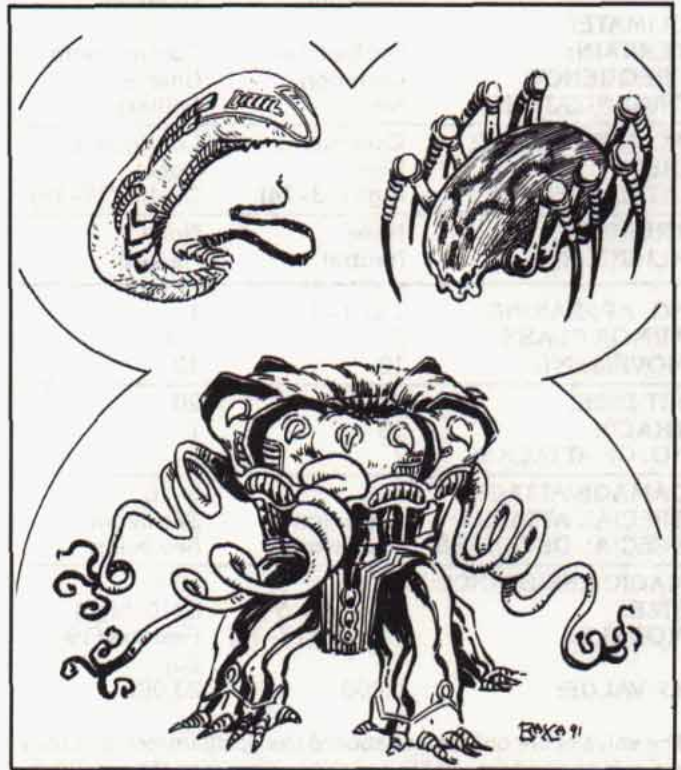

sembles a gigantic mind flayer. It is equipped with a psionic blast similar to that of a mind flayer.

The guardian shivak is made of the same leathery material as are the common shivaks, however, and it too has no apparent internal organs. The guardian has all the resistances and immunities of the other shivaks.

The guardian shivak exists only when an ultimate helm is carried on board the *Spelljammer*. This shivak is developed specifically for the purpose of challenging the possessor of the helm.

If the helm is destroyed or carried off the ship, the guardian shivak is absorbed back into the ship itself. It will reform each time an ultimate helm is present, and it will continue to be in the form that encompasses the fears of the previous captain, regardless of how many times the guardian shivak is called upon to appear.

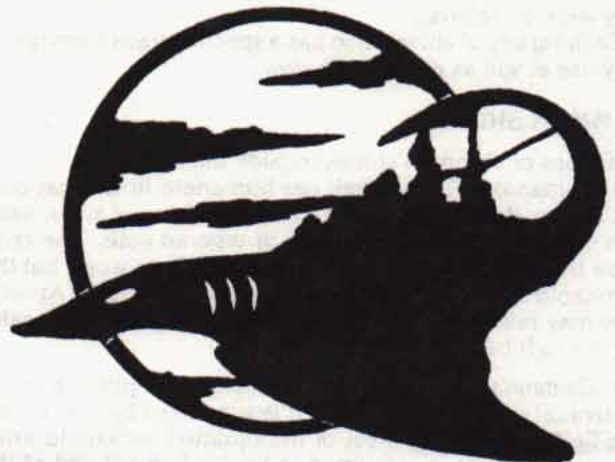

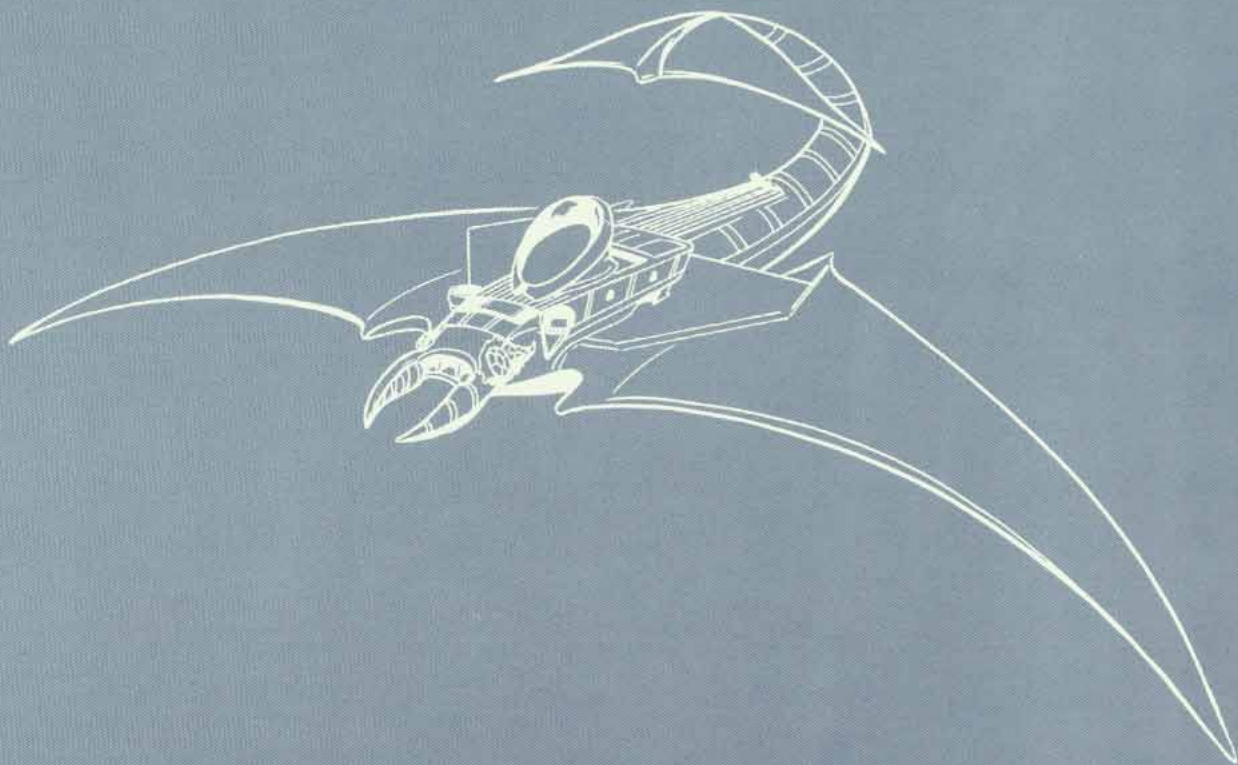

1065XXX1902

ADVANCED DUNGEONS & DRAGONS is a registered trademark owned by TSR, Inc.
SPELLJAMMER, and the TSR logo are trademarks owned by TSR, Inc. ©1991 TSR, Inc. All Rights
Reserved. Printed in the U.S.A.



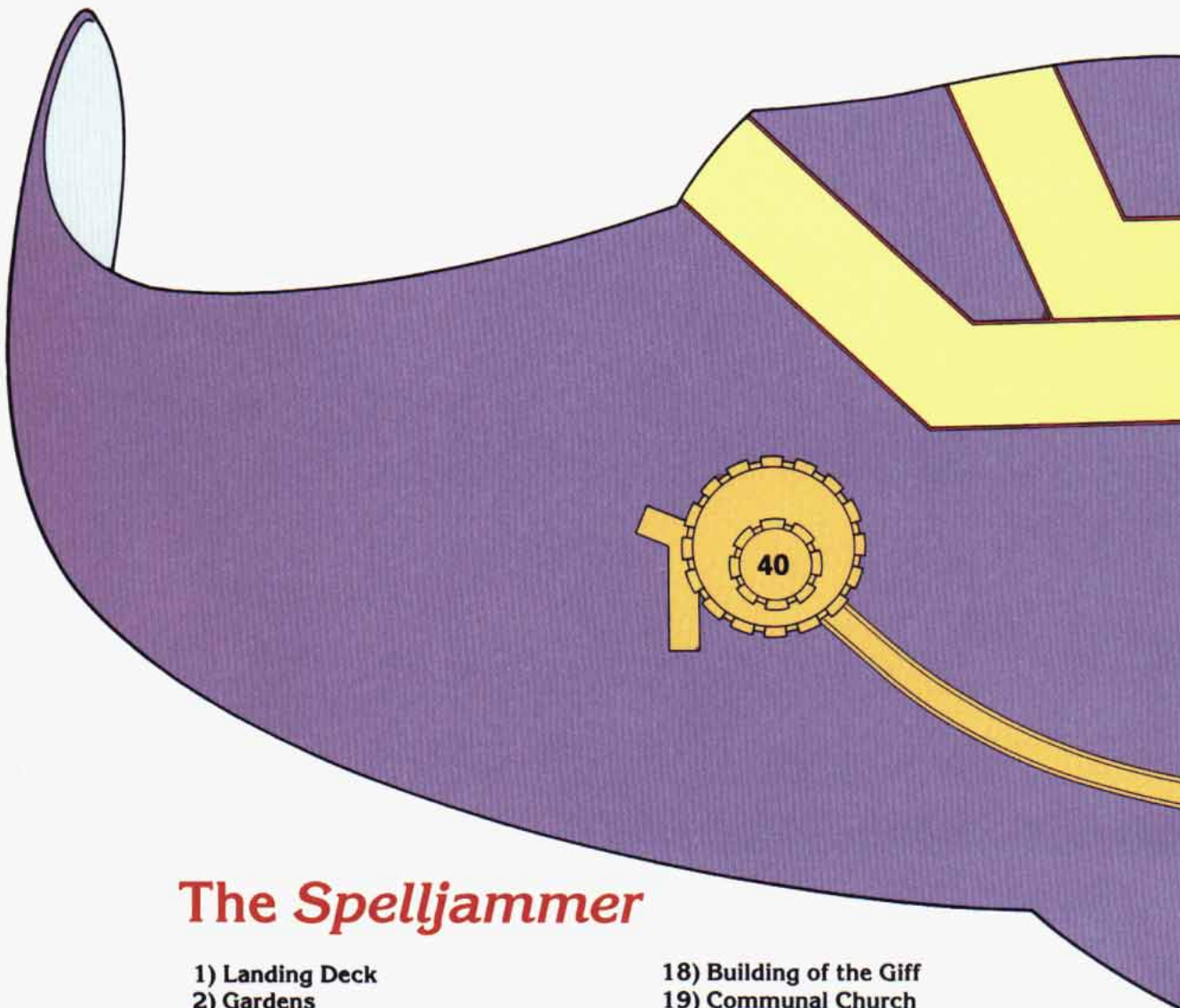

The Spelljammer

- | | |
|-----------------------|--------------------------|
| 1) Landing Deck | 18) Building of the Giff |
| 2) Gardens | 19) Communal Church |
| 3) Smalljammer Strips | 20) Old Wizard's Lair |
| 4) Council Chambers | 21) Gnoll Ruins |
| 5) Captain's Quarters | 22) Minotaur Tower |

- 7) Captain's tower
- 8) Library Tower
- 9) Human Collective
- 10) Chalice Tower
- 11) Tower of Thought
- 12) Tower of Trade
- 13) Guild Tower
- 14) Halfling Community
- 15) Shivak Terminal
- 16) Illithid Tower
- 17) Goblin Alliance Quarters

- 24) Beholder Ruins
- 25) Dwarven Citadel of Kova
- 26) Free Dwarves Tower
- 27) Neogi Tower
- 28) Hulk Tower
- 29) Giant Tower
- 30) Shou Tower
- 31) Arcane's Tower
- 32) Tenth Pit
- 33) Long Fangs' Tower
- 34) Academy of Human Knowledge

- 35
- 36
- 37
- 38
- 39
- 39
- 39
- 39
- 39
- 40
- 41

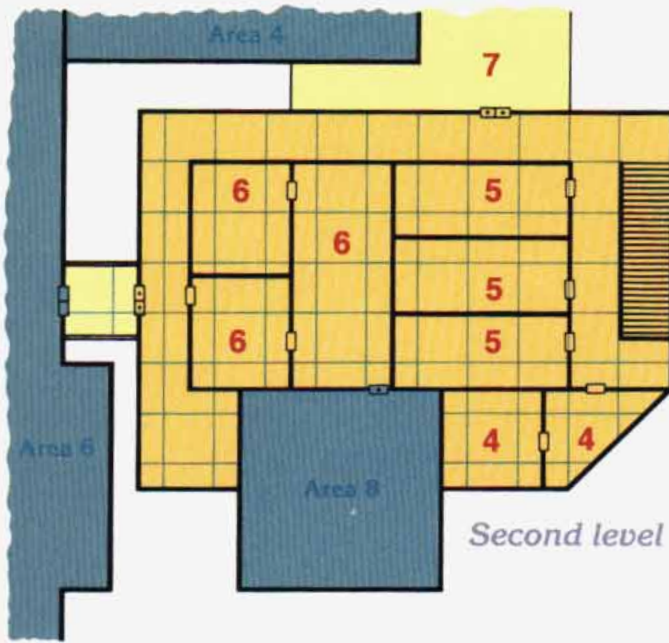

Area 7 Captain's Tower

- 1) Kitchen
- 2) Meeting hall
- 3) Larder
- 4) Storage/armory
- 5) Servant/slave quarters
- 6) Personal quarters
- 7) Upper patio

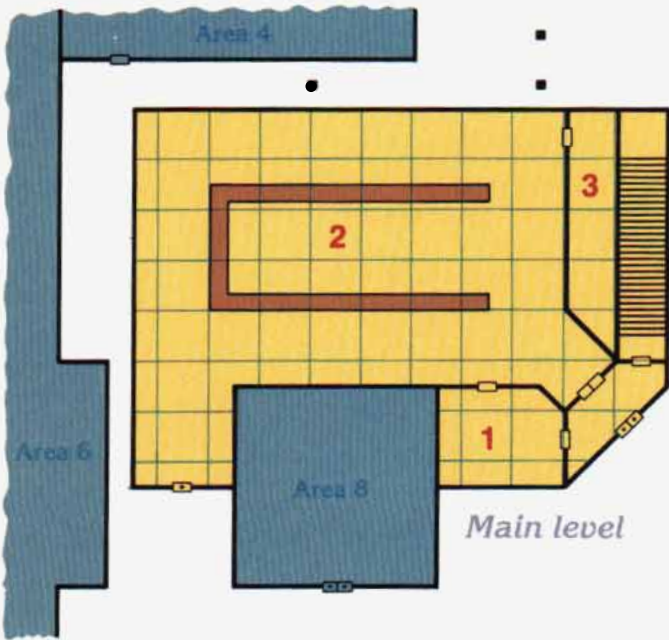

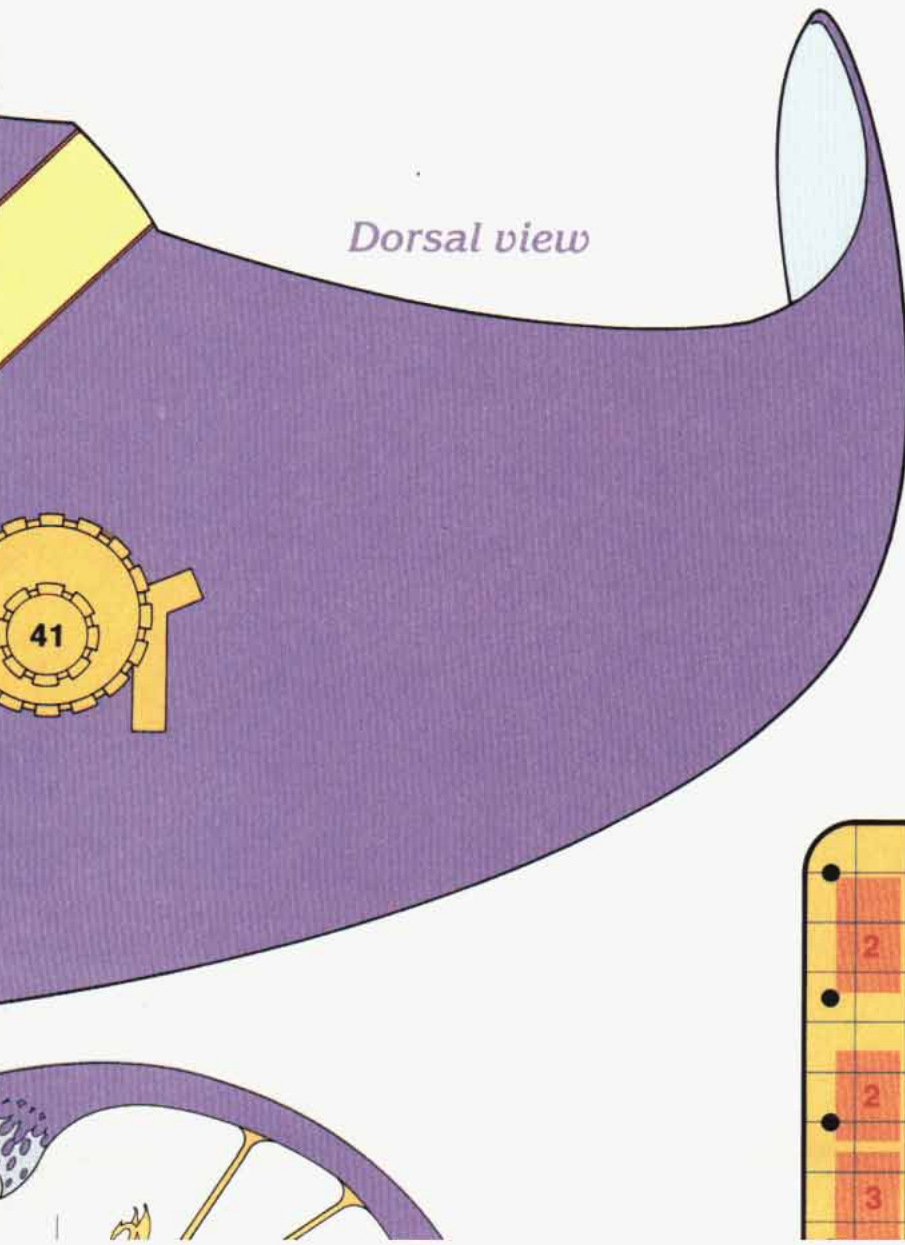

Main level

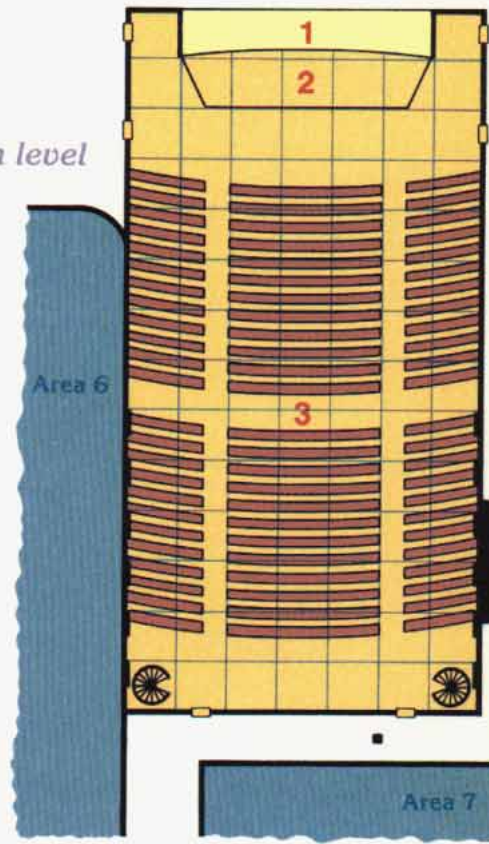

- Area
Co
- 1)
 - 2)
 - 3)
 - 4)

Main level

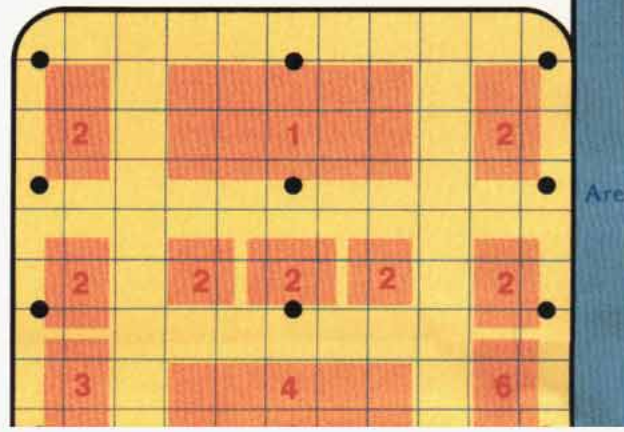



Port view

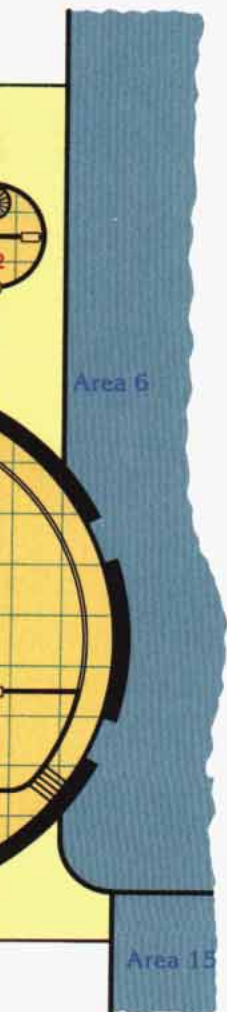
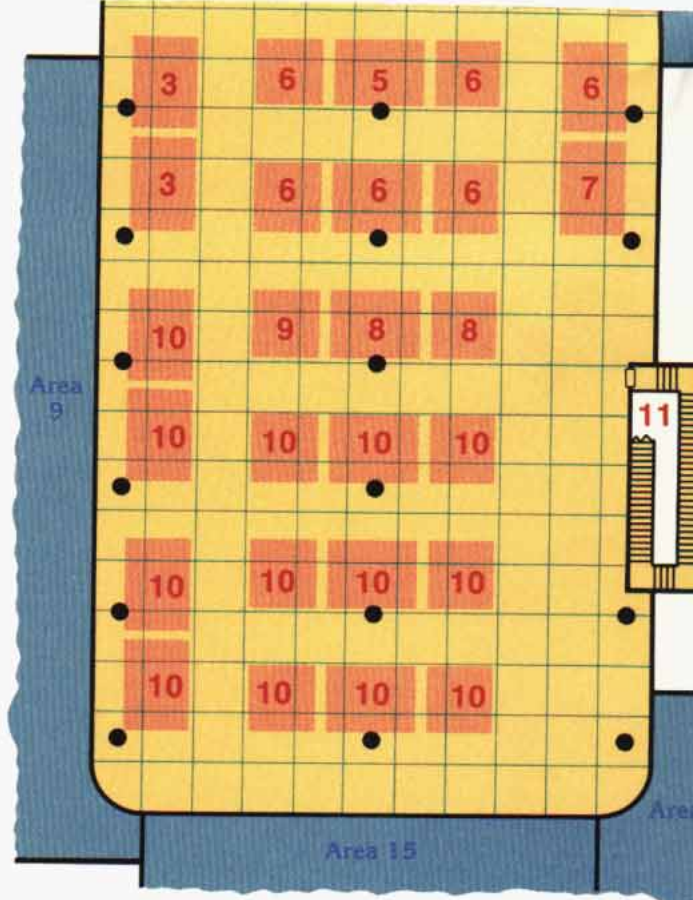

Typical guild level

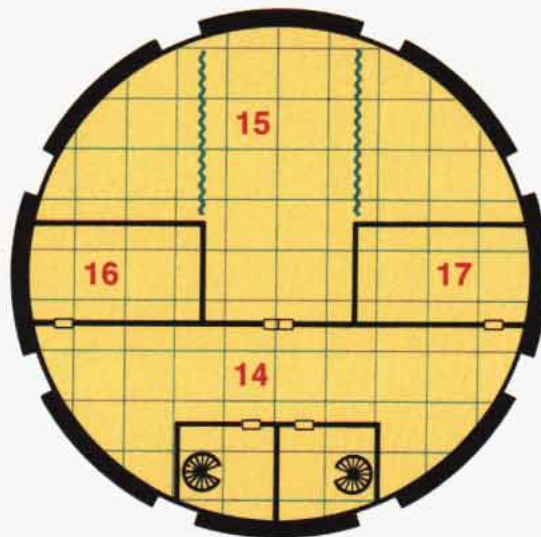

Leoster's quarters

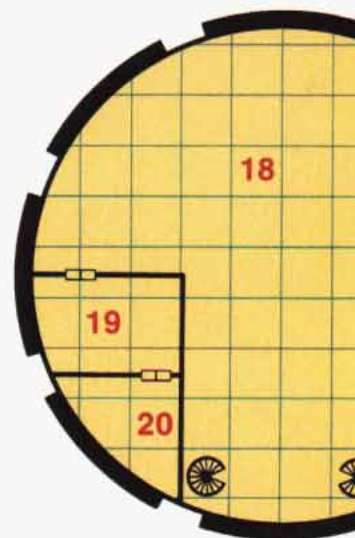

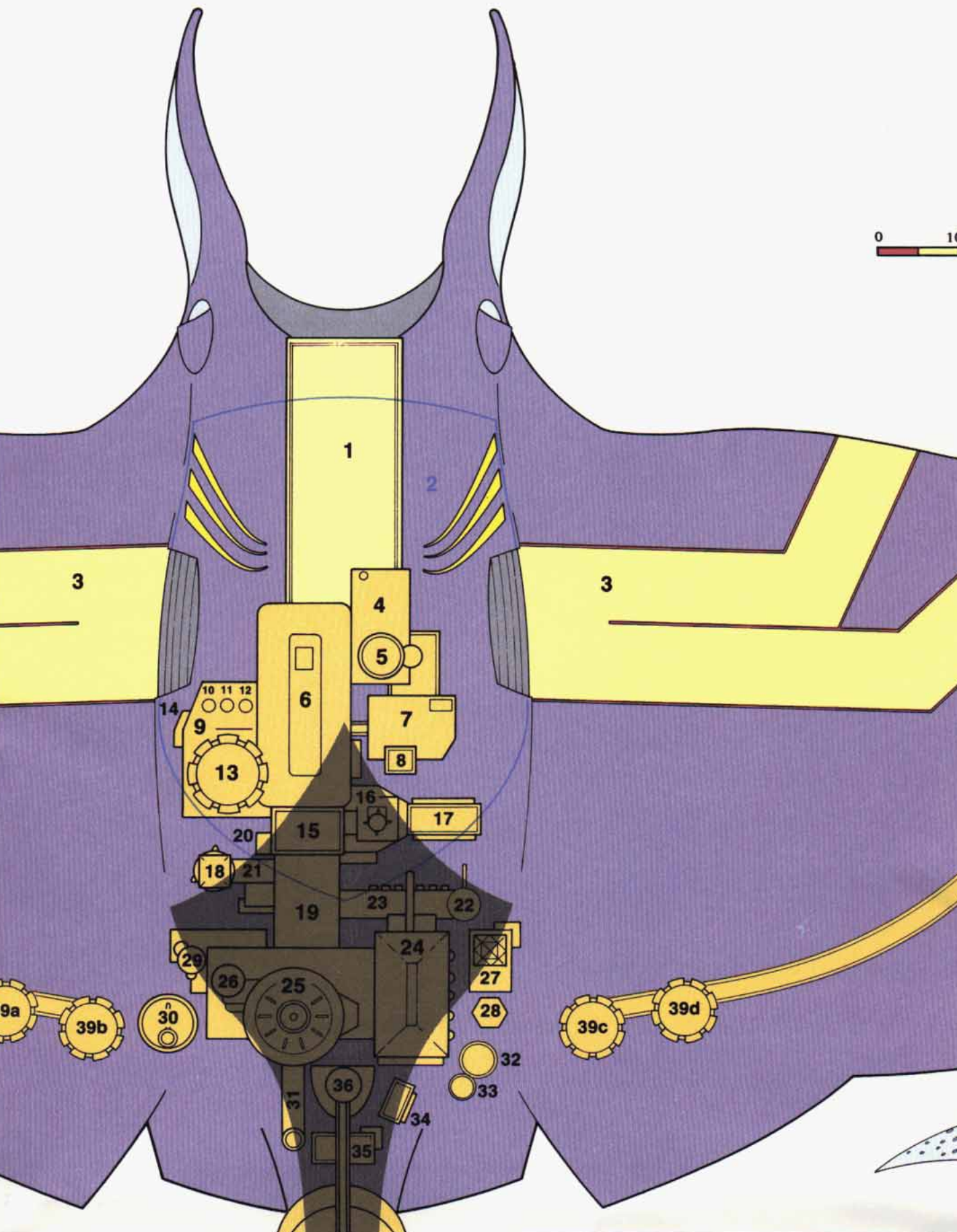

1

2

3

3

4

5

6

7

8

10 11 12

14

9

13

16

17

20

15

18

21

19

23

22

29

26

25

24

27

28

39a

39b

30

39c

39d

32

33

31

36

35

34

d Elvish Academy
 /en High Command
 mory
 rk Tower
 attery (human contingent)
 attery (dwarven contingent)
 attery (elvish contingent)
 attery (neogi contingent)
 acon Tower
 ntaur Tower

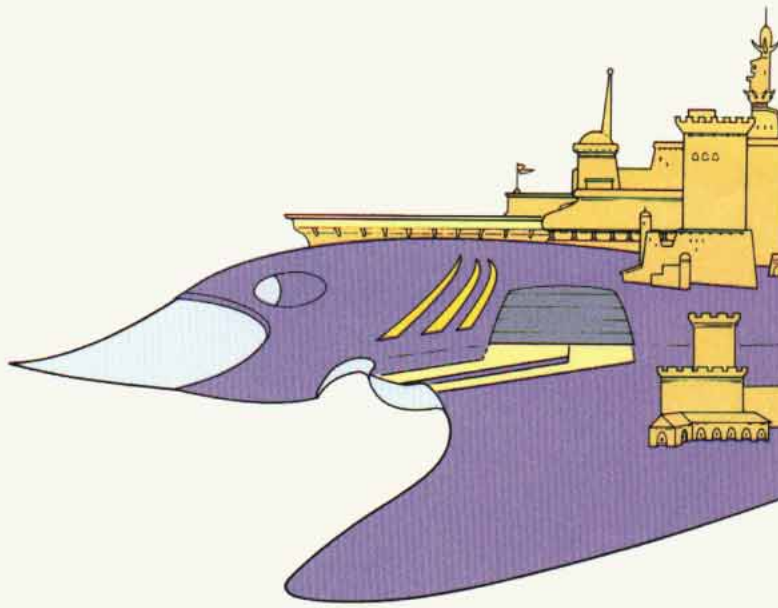
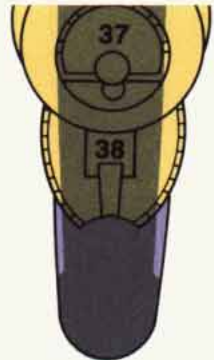

Main level

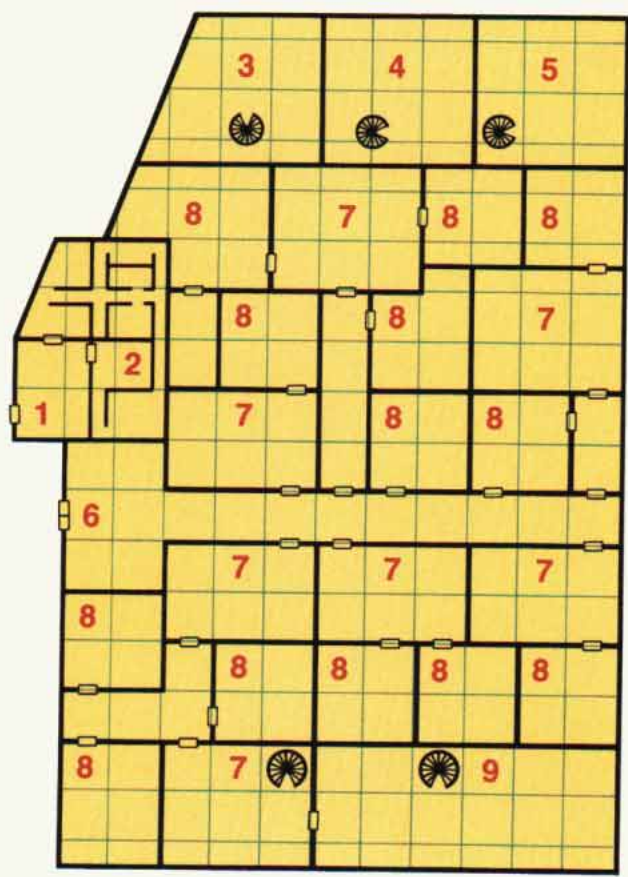

Plaza level

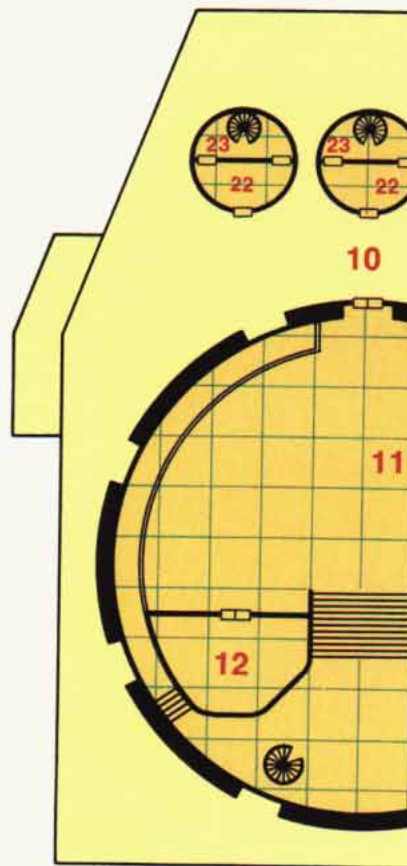

Balcony level

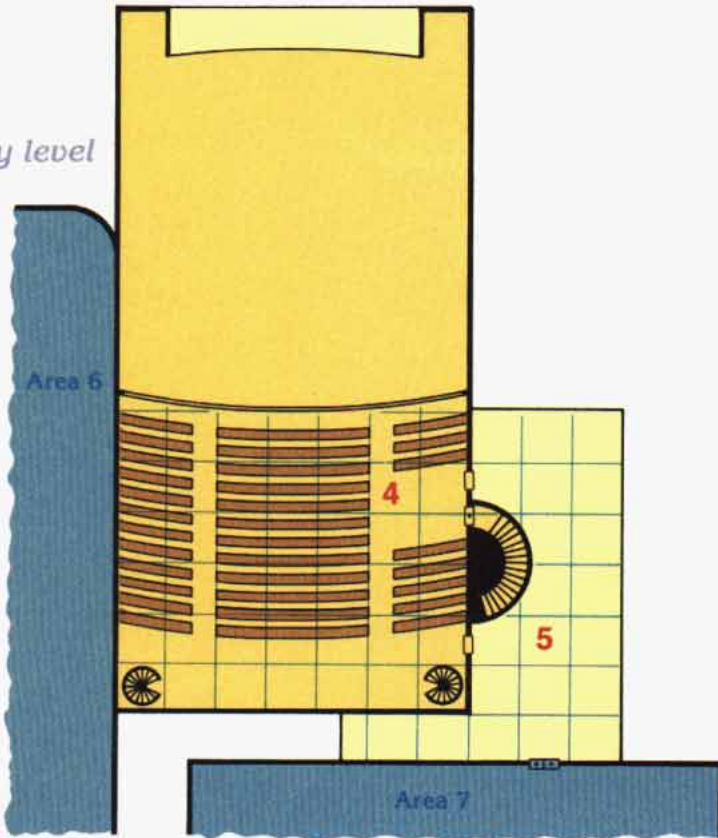

Typical level

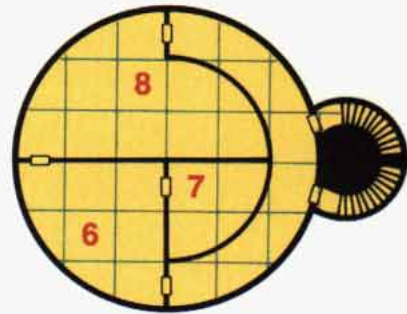

4 & 5 Cabin Chambers and Captain's Quarters

Steel window
Cabin stage
Cabin orium
Cabin ny

- 5) Upper patio
- 6) Personal quarters
- 7) Storage
- 8) Common room

Upper level

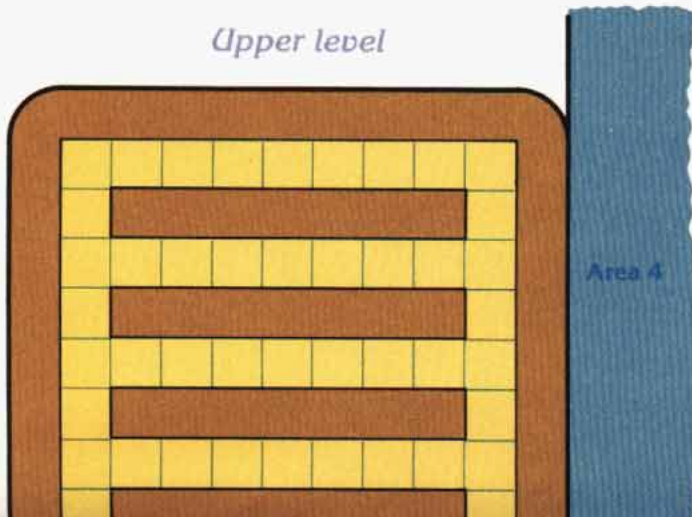

Area 6 Ship's Stores and Market

- 1) Open air public house
- 2) Food stalls
- 3) Jewelry

- 5) Dwarvish art
- 6) Crafts
- 7) Gnomish crafts
- 8) Sundries
- 9) Charms & fortunes
- 10) Transient owners
- 11) Stairway
- 12) Captain's passage
- 13) Upper warehouse

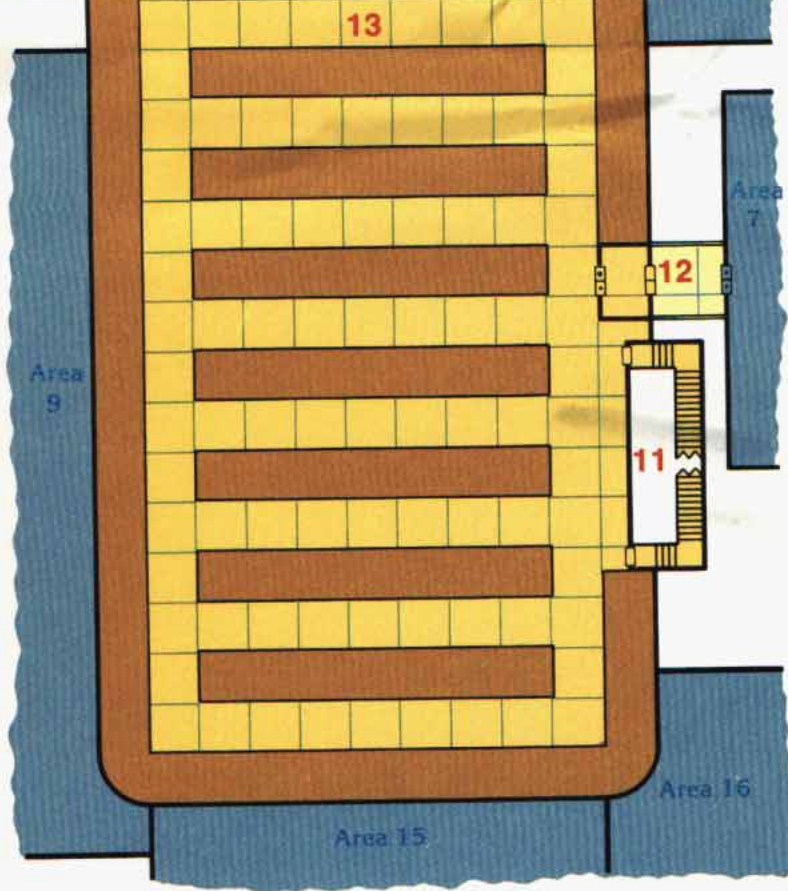

Areas 9 through 14 Human and Halfling Towers

- 1) Halfling entrance
- 2) Halfling family quarters
- 3) Chalice Tower mess area
- 4) Tower of Thought storage area
- 5) Tower of Trade armory
- 6) Human collective entrance
- 7) Collective commons
- 8) Living quarters
- 9) Armory
- 10) Plaza of Humanity
- 11) Grand Hall
- 12) Meeting room
- 13) Meeting room
- 14) Reception area
- 15) Private noble's quarters
- 16) Servants quarters
- 17) Storage area
- 18) Leoster's audience hall
- 19) Leoster's personal study
- 20) Leoster's day room
- 21) Advisor's quarters
- 22) Tower entrance
- 23) Guards' room
- 24) Living quarters
- 25) Study
- 26) Bedroom



Area 2 The Gardens

- 1) Commons (park)
- 2) Lizard men village
- 3) Arvanon's hut
- 4) Lizard men outpost
- 5) Jamberry trees
- 6) Vegetable gardens
- 7) Main doors
- 8) Fruit- & nut-bearing trees
- 9) Brush/berries
- 10) Pond (rice, fish)
- 11) Pigsties & compost
- 12) Grains
- 13) Apiaries
- 14) Lesser doors



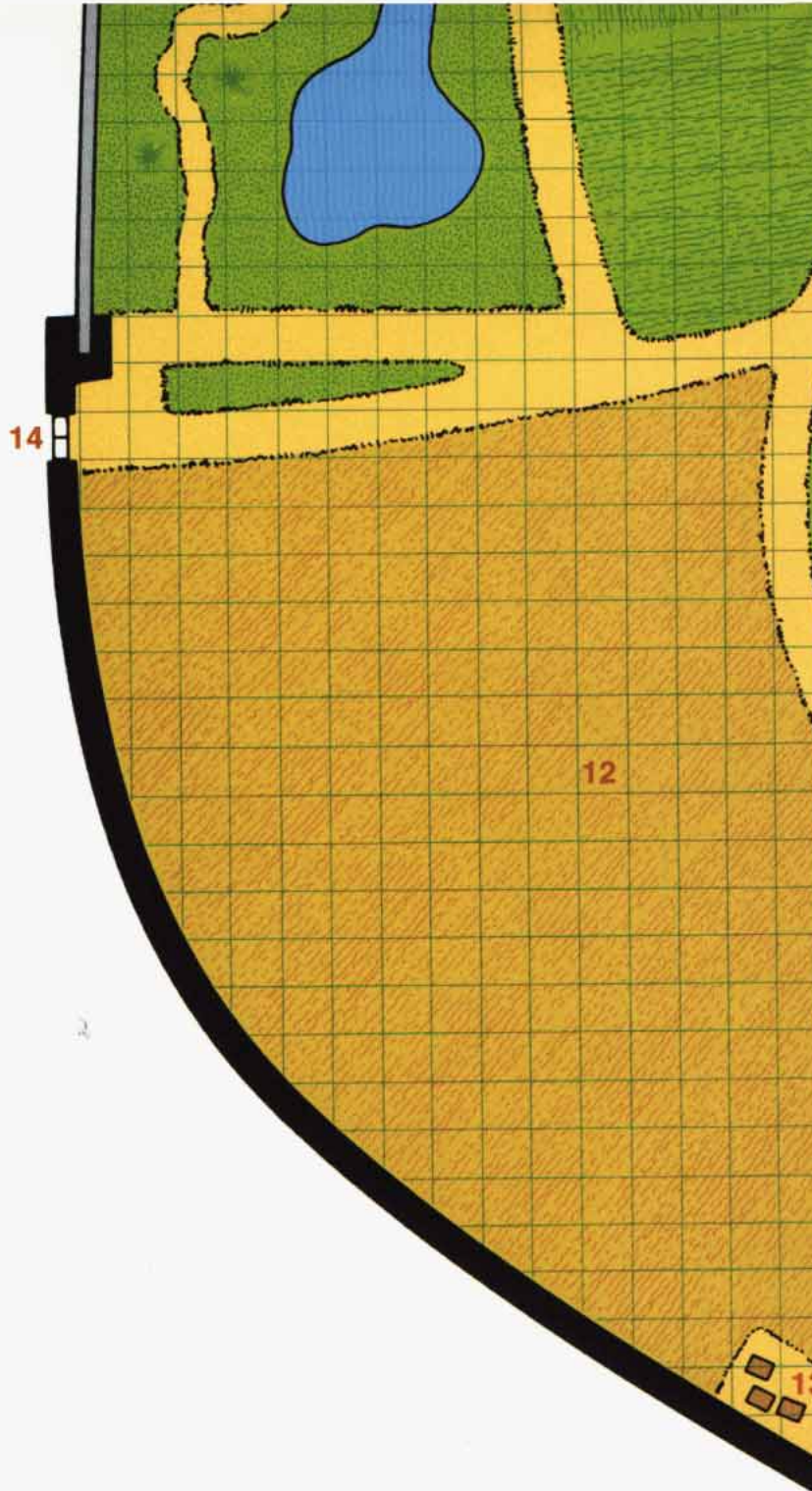

-  Door
-  Double Doors
-  Locked Door
-  Secret Door
-  Spiral Stairs
-  Archway
-  Curtain
-  Rubble
-  Statue
-  Brain Mold

One square = 10 feet

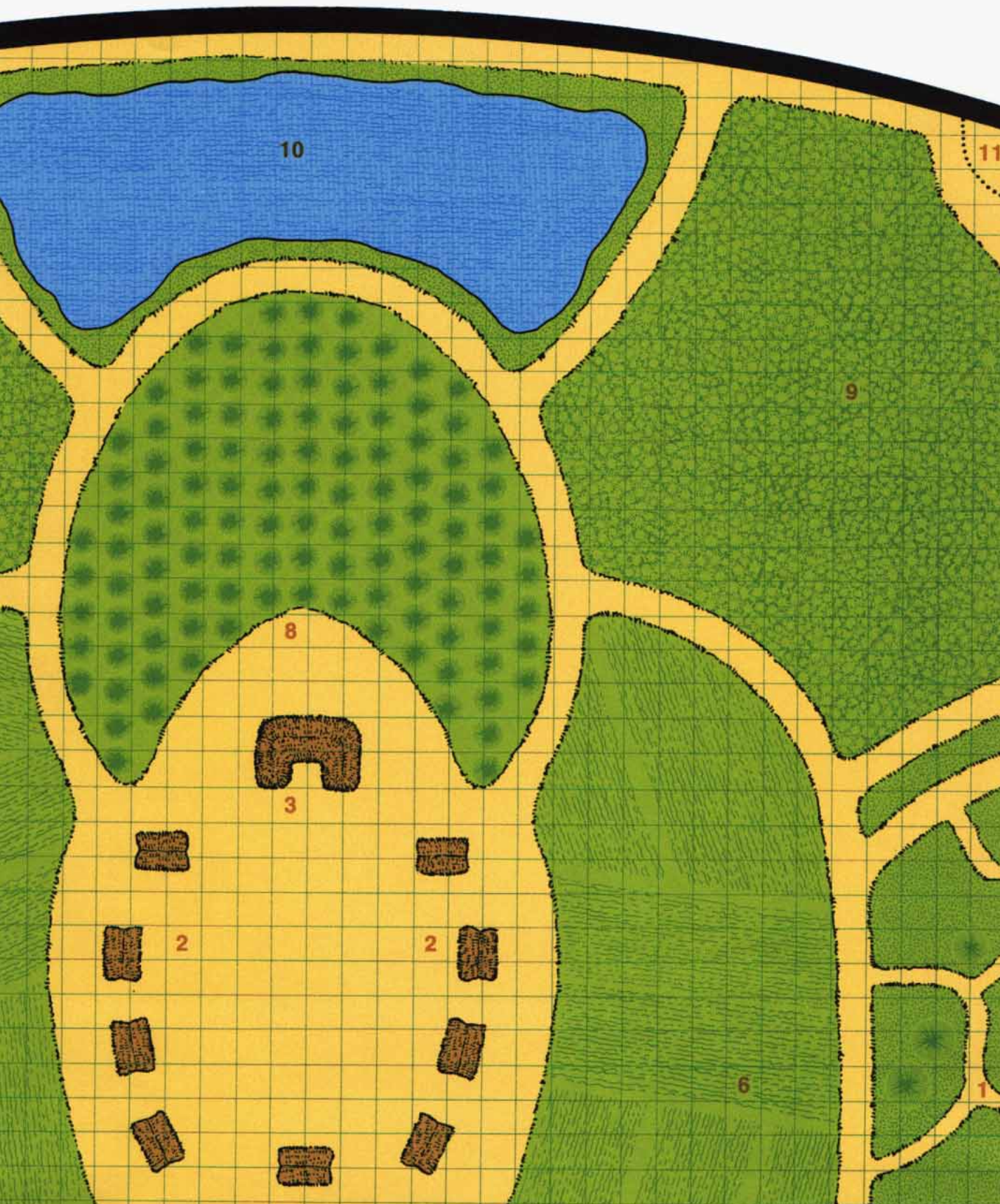

10

11

9

8

3

2

2

6

1

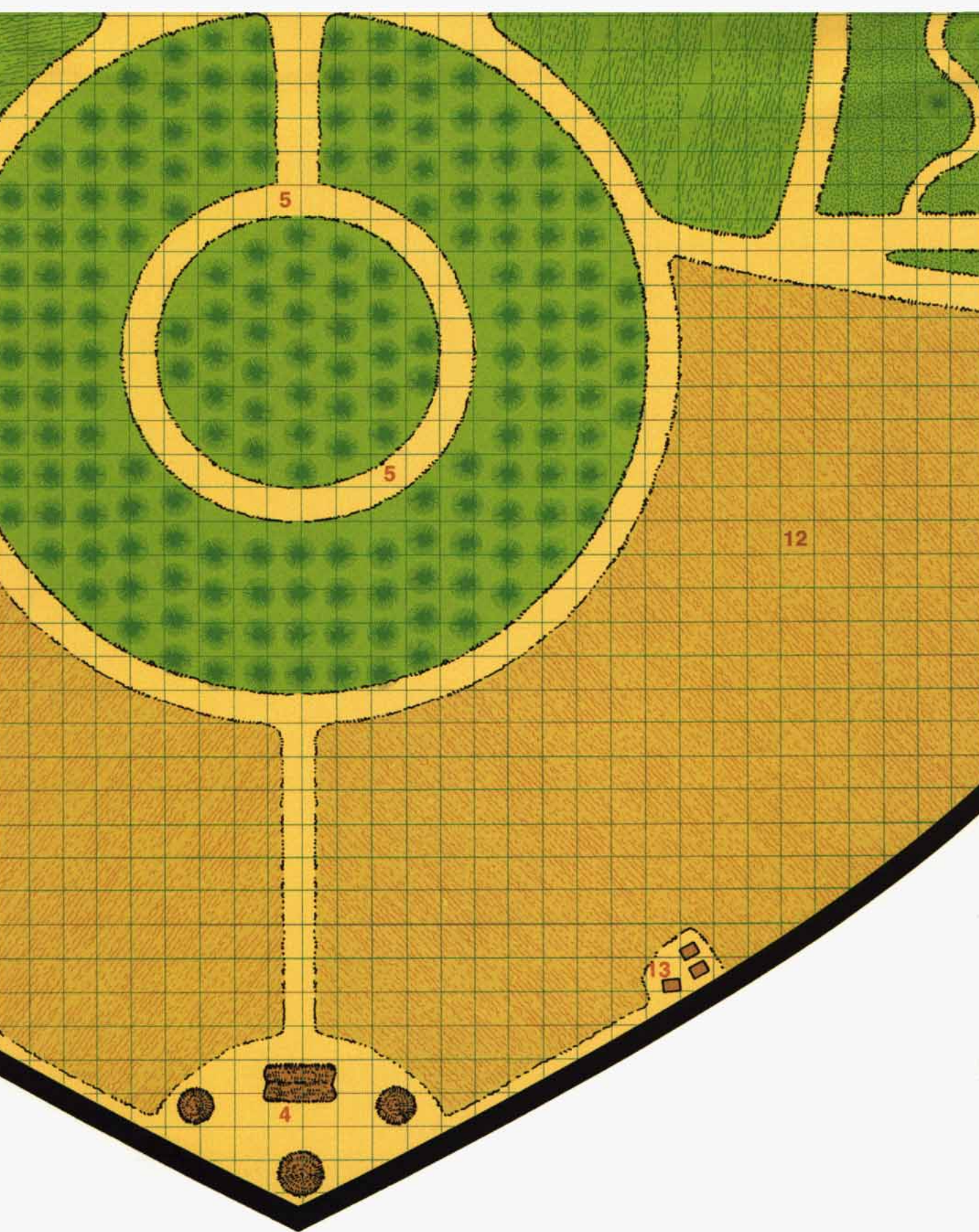

5

5

12

13

4

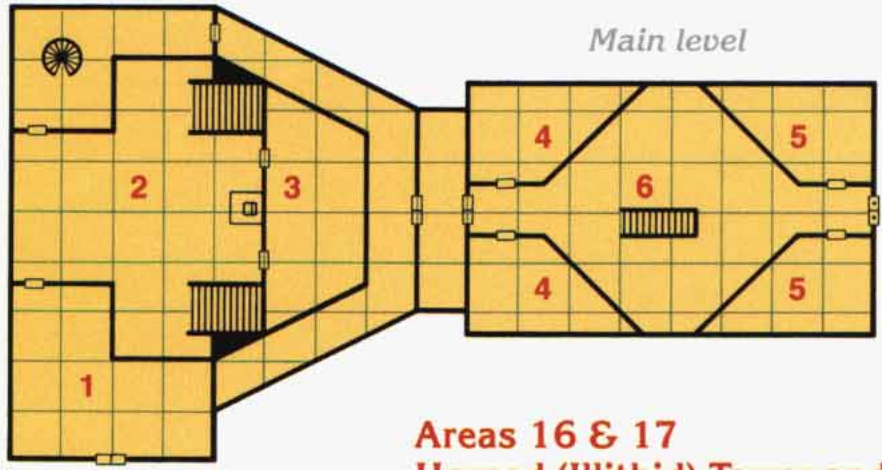
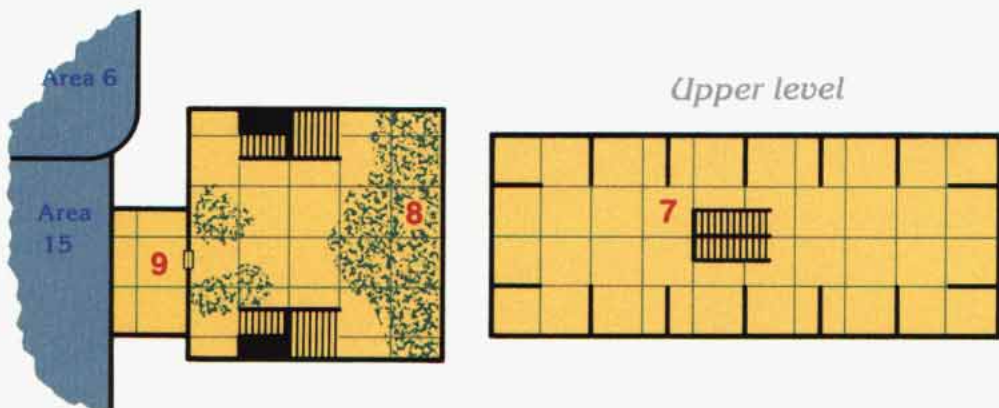

**Areas 16 & 17
Horned (Illithid) Tower and Goblin Tower**

- 1) Entry hall
- 2) Audience chamber
- 3) Private study
- 4) Goblin armory
- 5) Guardrooms
- 6) Goblin assembly area
- 7) Goblin quarters
- 8) Brain mold areas
- 9) Illithid personal quarters

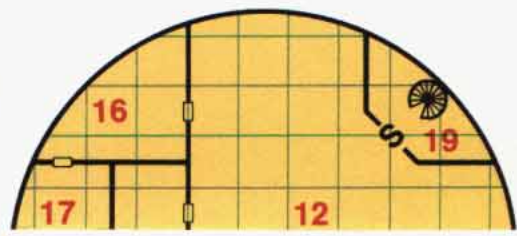

Upper levels

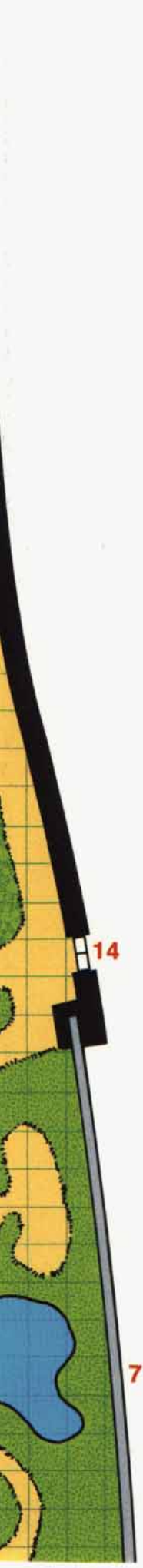

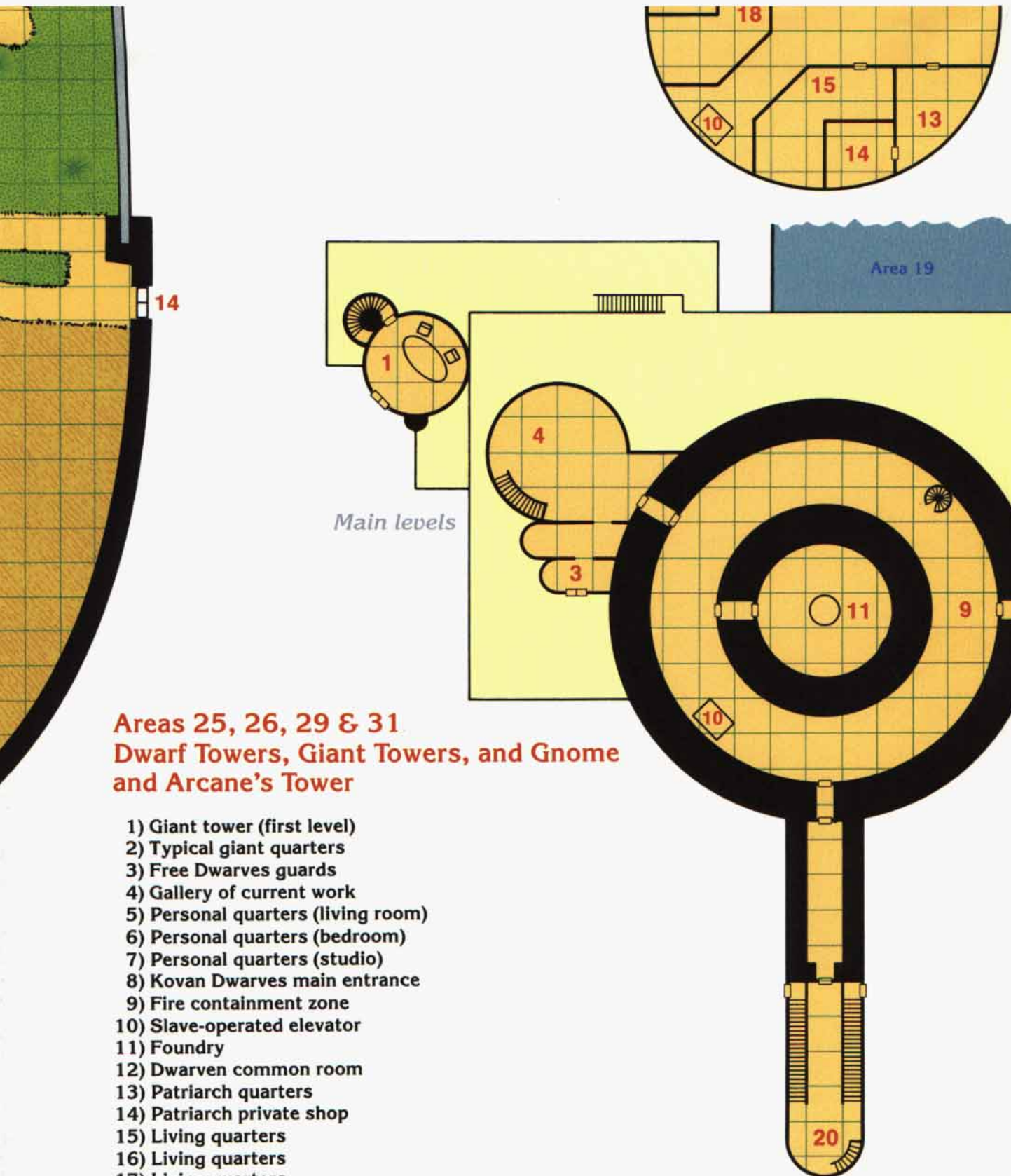

**Areas 25, 26, 29 & 31
Dwarf Towers, Giant Towers, and Gnome
and Arcane's Tower**

- 1) Giant tower (first level)
- 2) Typical giant quarters
- 3) Free Dwarves guards
- 4) Gallery of current work
- 5) Personal quarters (living room)
- 6) Personal quarters (bedroom)
- 7) Personal quarters (studio)
- 8) Kovan Dwarves main entrance
- 9) Fire containment zone
- 10) Slave-operated elevator
- 11) Foundry
- 12) Dwarven common room
- 13) Patriarch quarters
- 14) Patriarch private shop
- 15) Living quarters
- 16) Living quarters
- 17) Living quarters
- 18) Living quarters
- 19) "Secret" entrance to emergency stairs
- 20) Gnome guardpost

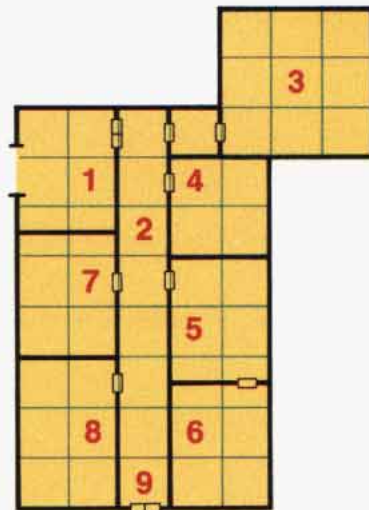

Area 27 Neogi Tower

- 1) Entry area
- 2) Hall
- 3) Temple
- 4) Meeting room
- 5) Quartermaster room
- 6) Prisoners' section
- 7) Coh's study
- 8) Slave exchange
- 9) Slave entrance

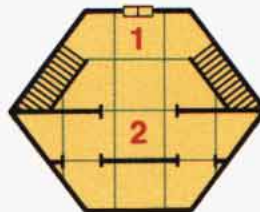

Area 28 Umber Hulk Tower

- 1) Entry hall
- 2) Orik's quarters

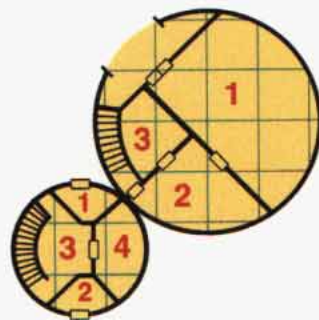

Area 32 Tenth Pit

- 1) Commons & bar
- 2) Korvok's quarters
- 3) Storage

Area 33 The Long Fangs' Tower

- 1) North guardroom
- 2) South guardroom
- 3) Common room
- 4) Selura's office

Area 34 Academy of Human Knowledge

- 1) Entrance
- 2) Main reading room
- 3) Scribes' desks
- 4) Brother Burke's office
- 5) Storage

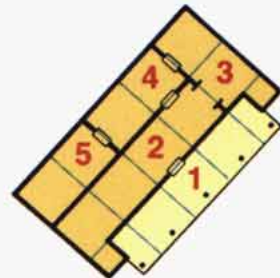

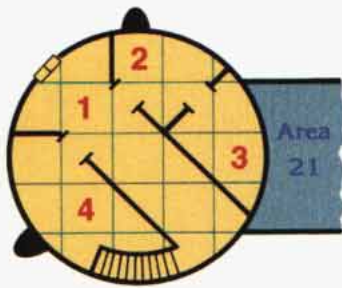

**Area 18
Giff Tower**

- 1) Entry hall
- 2) Communal gun-cleaning room
- 3) Kitchen
- 4) Planning room

First level

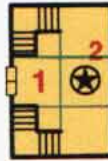

Second level

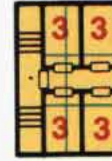

**Area 20
Old Wizard's Lair**

- 1) Main gallery
- 2) Statue of Asmodeus Paxx
- 3) Individual quarters

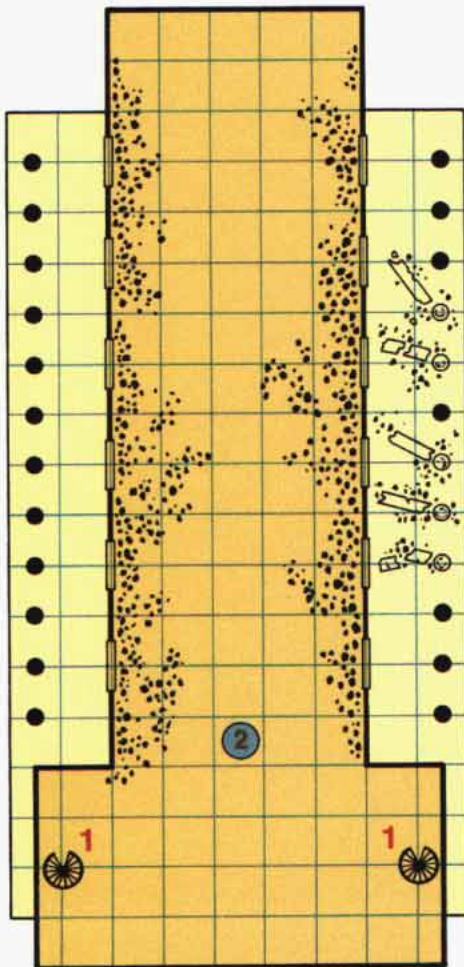

Main level

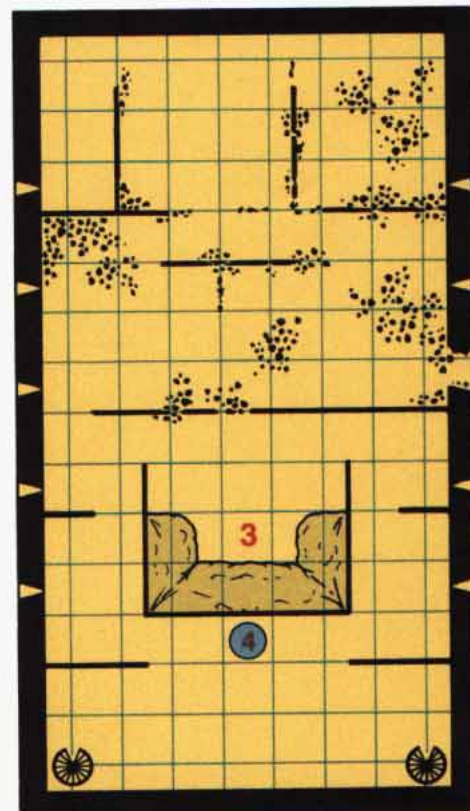

Typical upper level

**Area 24
Beholder Ruins**

- 1) Slave stairs
- 2) Beholder passage in ceiling
- 3) Typical beholder quarters
- 4) Beholder passage in floor

DM's Summary of NPCs Onboard the *Spelljammer*

The *Spelljammer* is a huge ship, filled with a large number of individuals, races, and factions, all with their own goals and secrets. To help the DM in moderating adventures on the *Spelljammer*, this summary sheet has been provided. Reference to the personalities section of *Captains and Ships* is recommended for full details on any individual.

Information listed as *Secrets* is not necessarily true; check the character's full description in the *Captains and Ships* book for full details on accuracy and whether the NPC is willing to share his information.

Arcane

Level/Class/Race: Arcane.

Headquarters: Area #31.

Allies: Gnomes.

Foes: The Fool, other captains.

Goals: Escape the *Spelljammer*.

Secrets: Understands everything about the *Spelljammer*; is insane; has sold information to Demets and Stardawn.

Argargon

Level/Class/Race: Gnoll chieftain, now zombie.

Headquarters: Area #42.

Allies: The Fool.

Foes: All living things.

Goals: Serve the Fool.

Secrets: Survived destruction of the gnoll citadel but then made undead by the Fool.

Arvanon

Level/Class/Race: 13th level lizard priest.

Headquarters: Area #2.

Allies: Lizard men, Demets, Suza.

Foes: Those who attack the gardens.

Goals: To maintain the balance and the cycle of the *Spelljammer*.

Secrets: The gardens close upon arrival of a new captain; Smalljammers are grown in the gardens.

Astor

Level/Class/Race: Beholder.

Headquarters: Area #6.

Allies: Halflings, Kristobar.

Foes: Other beholders.

Goals: Act as ship's steward; prevent anyone from becoming captain; destroy all those who have insulted him.

Secrets: All but three of his eyes are functioning.

Breakox

Level/Class/Race: Hill giant/minotaur.

Headquarters: Area #22.

Allies: Minotaurs, ShiCaga, hill giants, Father Goat.

Foes: neogi, beholders, mind flayers.

Goals: Keep the minotaurs free; steal the hill giants from Taja.

Secrets: Hates ShiCaga; wants to kill Taja.

Brother Burke

Level/Class/Race: 7th level human wizard (male).

Headquarters: Area #34.

Allies: Xenos, Hooded Soldier, Ollister, Si Loo (presumed).

Foes: All nonhumans.

Goals: Destroy all nonhumans.

Secrets: Front man for terrorist organization; Si Loo is the Hooded Soldier; Burke is geased never to reveal these facts.

CassaRoc

Level/Class/Race: 15th level human fighter (male).

Headquarters: Area #11.

Allies: Humans, halflings, Chaladar, Chila, Kristobar.

Foes: ShiCaga, those who attack humans.

Goals: Protect humanity, have a good time at it.

Secrets: The Fool is the secret captain of the *Spelljammer*.

Chaladar

Level/Class/Race: 19th level human paladin (male).

Headquarters: Area #10.

Allies: Humans, CassaRoc, Leoster.

Foes: All evil creatures, those who threaten humanity.

Goals: Protect humanity, eliminate evil.

Secrets: Was not a hero in the War of the Lance; the Fool was created by evil humans.

Chila

Level/Class/Race: 18th level human fighter (female).

Headquarters: Area #12.

Allies: CassaRoc, humans, halflings.

Foes: Those who threaten her charges.

Goals: Protect her people, make money.

Secrets: The Fool is a force of elemental evil, balanced by the secret captains of good.

Coh

Level/Class/Race: 8th level neogi wizard.

Headquarters: Area #27.

Allies: Neogi, Umber hulks, Orik.

Foes: Beholders, all other races.

Goals: Defeat the beholders, enslave all other races on the *Spelljammer*, become captain.

Secrets: Is in communication with the Fool; the Fool chooses the next captain; the captain must be a magician.

Demets

Level/Class/Race: 9th level lizard king priest.

Headquarters: Area #2.

Allies: Arvanon, lizard men.

Foes: Those who threaten the gardens.

Goals: Use food as a weapon to control the captain and the ship.

Secrets: Own sister killed in deal with Arcane; captain must bring an artifact on board to become captain.

"Diamondtip"

Level/Class/Race: Giff commander.

Headquarters: Area #18.

Allies: Humans, those who pay for his services.

Foes: Gnolls, beholders, evil creatures.

Goals: Gather smoke powder; make giffs the major military force on the ship; collect maps.

Secrets: Has extensive map collection; worries about getting old.

Father Goat

Level/Class/Race: Satyr.

Headquarters: Area #19.

Allies: Communal Church, humans, Trebek, Breakox.

Foes: Those who attack his people.

Goals: To protect members of minority races under his care.

Secrets: Fool is created by violence; has secretly been charmed by Trebek.

Firespitter

Level/Class/Race: 10th level dwarf fighter (male).

Headquarters: Area #23.

Allies: Free dwarves, kova, gnomes.

Foes: Talentless critics, Arcane, Trebek.

Goals: Preserve the creativity and artistic freedom of the dwarvish people.

Secrets: The Fool was created by the Kovans; the *Spelljammer* was created by the dwarven gods and flies through dwarven creativity.

Fool

Level/Class/Race: Master lich.

Headquarters: Area #42.

Allies: Hooded Soldier, Argargon.

Foes: All living things, the *Spelljammer*.

Goals: Destroy the *Spelljammer*.

Secrets: Was once captain of the Great Ship; communicates through his zombies and controls their actions.

Gray Eye

Level/Class/Race: Beholder.

Headquarters: Area #24.

Allies: Beholders of area 24.

Foes: Astor, all other beholders, neogi.

Goals: Kill other beholders; kill neogi; find a new slave race (perhaps minotaurs or ogres).

Secrets: Has undead beholder-mummies in tower; Fool moves his base around in the warrens.

Hancherback

Level/Class/Race: 10th level halfling thief (male).

Headquarters: Area #14 or #6.

Allies: Kristobar, halflings, humans.

Foes: None.

Goals: Protect his people, make money at it.

Secrets: The Fool is a parasite from a lower plane.

Highstar

Level/Class/Race: 8th level elf fighter/7th level wizard (male).

Headquarters: Area #36.

Allies: Elves, Stardawn.

Foes: Goblins, Trebek.

Goals: Eliminate the goblin menace; defeat evil; teach other races to live as elves.

Secrets: The Fool is part of a goblin plot.

Hobgoblin Prophet

Level/Class/Race: 6th level hobgoblin shaman.
Headquarters: Area #23.
Allies: ShiCaga, hobgoblin refugees.
Foes: Highstar, Trebek, mind flayers, ogres, ShiCaga's children.
Goals: Free his people from the mind flayers; set up utopia ruled by his people.
Secrets: None—"In Utopia, we know everything."

Hooded Soldier

Level/Class/Race: Zombie.
Headquarters: Area #34.
Allies: Fool, Xenos, Brother Burke, Ollister, Nagasimi.
Foes: All living things.
Goals: Serve the Fool by manipulating the Xenos.
Secrets: Is a zombie controlled by the Fool.

Jokarin

Level/Class/Race: 10th level human fighter (male).
Headquarters: Area #38.
Allies: Theorx, Miark.
Foes: The *Spelljammer*, Shivaks.
Goals: Escape the dark tower; regain captancy.
Secrets: Jokarin is a former captain.

Kaba Danel

Level/Class/Race: Dracon leader.
Headquarters: Area #40.
Allies: Dracons, Suza.
Foes: Neogi, beholders.
Goals: Protect and lead his people.
Secrets: None.

Korvok

Level/Class/Race: 17th level human thief (male).
Headquarters: Area #32.
Allies: Selura, Tenth Pit, any who pay him to kill.
Foes: All who get in his way.
Goals: Discover secrets; use same to stir trouble.
Secrets: Has a crush on Selura.

Kova

Level/Class/Race: 12th level dwarf fighter (male).
Headquarters: Area #25.
Allies: All dwarves, Firespitter.
Foes: None.
Goals: Continue to build and create; protect his people by keeping other races at distance.
Secrets: The dwarves provide the motive force for the *Spelljammer*; the ship is ruled by a secret cabal of elder dwarves.

Kristobar

Level/Class/Race: 5th level halfling fighter (male).
Headquarters: Area #6 or #14.
Allies: Hancherback, Astor, halflings, humans.
Foes: None (that he will admit to).
Goals: Gather information; serve drinks.
Secrets: Local gossip; secret captains control everything on the ship; the Fool is a myth.

Leoster

Level/Class/Race: 20th level human fighter/13th level wizard.
Headquarters: Area #13.
Allies: The Guild, all humans, Chaladar.
Foes: All who attack the human collective.
Goals: Lead by good example, punish those who attack the collection; work on coin collection.
Secrets: His advisor created the story of the Fool.

Miark the Blind

Level/Class/Race: 12th level beholder wizard.
Headquarters: Area #38.
Allies: Theorx.
Foes: None.
Goals: When lucid, escape and destroy other beholders; play chess.
Secrets: Miark was a former captain of the *Spelljammer*.

Mostias

Level/Class/Race: Centaur.
Headquarters: Area #41.
Allies: Humans, wemics, centaurs.
Foes: None.
Goals: Party hearty.
Secrets: None.

Nagasimi

Level/Class/Race: 12th level wu jen or wizard (male).
Headquarters: Area #30.
Allies: Si Loo, the Shou, the Hooded Soldier.
Foes: All non-Shou and nonhumans.
Goals: Eliminate all nonhumans, enslave all non-Shou.
Secrets: Sends Si Loo's representative to the Xenos; provided smoke powder to destroy elven academy; the Fool is an outlander fairy story.

Ollister

Level/Class/Race: 7th level human fighter (male).

Headquarters: Area #13 or #34.

Allies: Leoster, the Guild, the Hooded Soldier, Brother Burke, the Xenos (though he is unaware of their terrorist acts).

Foes: None.

Goals: Have a ripping good time.

Secrets: Member of the Xenos; the Fool was a story created by his grandfather.

Orik

Level/Class/Race: Umber hulk.

Headquarters: Area #28 or #27.

Allies: Umber hulks, neogi, Coh.

Foes: Anyone who threatens Coh.

Goals: Protect Coh; convince others that everyone should belong to Coh.

Secrets: Coh battles the Fool, but no one wants to help him.

Selura

Level/Class/Race: 18th level human fighter (female).

Headquarters: Area #33.

Allies: Korvok, hill giants, Long Fangs.

Foes: All other leaders (including Korvok).

Goals: Kill all other leaders; start senseless bloodbath; steal away Taja's hill giants.

Secrets: Hates Korvok; was rejected by Stardawn.

ShiCaga

Level/Class/Race: Ogre mage chieftess.

Headquarters: Area #23.

Allies: ogres, hobgoblins, her sons, Hobgoblin Prophet, Breakox.

Foes: Trebek, CassaRoc.

Goals: Free goblin races from mind flayers; bring ship under nonhuman control, with her in charge.

Secrets: Fool is story created by good to slander evil; will gladly send Breakox to his death.

Si Loo

Level/Class/Race: 8th level human bushi/fighter (male).

Headquarters: Area #30.

Allies: Nagasimi, the Shou.

Foes: All who oppose his rule.

Goals: Rule the *Spelljammer* wisely in the name of the Shou emperor.

Secrets: Si Loo is not a member of the Xenos, though the Xenos believe him to be.

Stardawn

Level/Class/Race: 6th elven elf fighter (male).

Headquarters: Area #36.

Allies: Highstar, the elves, Arcane.

Foes: Goblins, other captains.

Goals: Take command of the *Spelljammer* and bring her back to the elven admiralty.

Secrets: Listed goal is a secret mission; has had dealings with Arcane; stole the master seed to pay Arcane for information; knows that the new captain will be carrying a symbol of power to identify himself.

Suza the Brass

Level/Class/Race: Mature brass dragon.

Headquarters: Area #41.

Allies: Dracons, Arvanon.

Foes: Neogi.

Goals: Have a good time talking with all these fantasy characters.

Secrets: Local gossip.

Taja

Level/Class/Race: Frost giant.

Headquarters: Area #29.

Allies: giants, humans.

Foes: Breakox, Coh, neogi, beholders.

Goals: Keep her people independent; make ties with humanity; collect new songs and tales.

Secrets: Knows recent history, appearance of the Fool; knows cycle of the dark times.

Theorx

Level/Class/Race: 13th level priest of Odin (male).

Headquarters: Area #38.

Allies: Miark, Jokarin.

Foes: None.

Goals: Play chess, write.

Secrets: Theorx was a former captain of the *Spelljammer*.

Trebek

Level/Class/Race: Mind flayer.

Headquarters: Area #16.

Allies: Mind flayers, goblins, Father Goat.

Foes: Elves, any who stand in his way.

Goals: Enslave the *Spelljammer's* races.

Secrets: Does not believe in the Fool; has charmed Father Goat.

BATTLE DOLPHIN

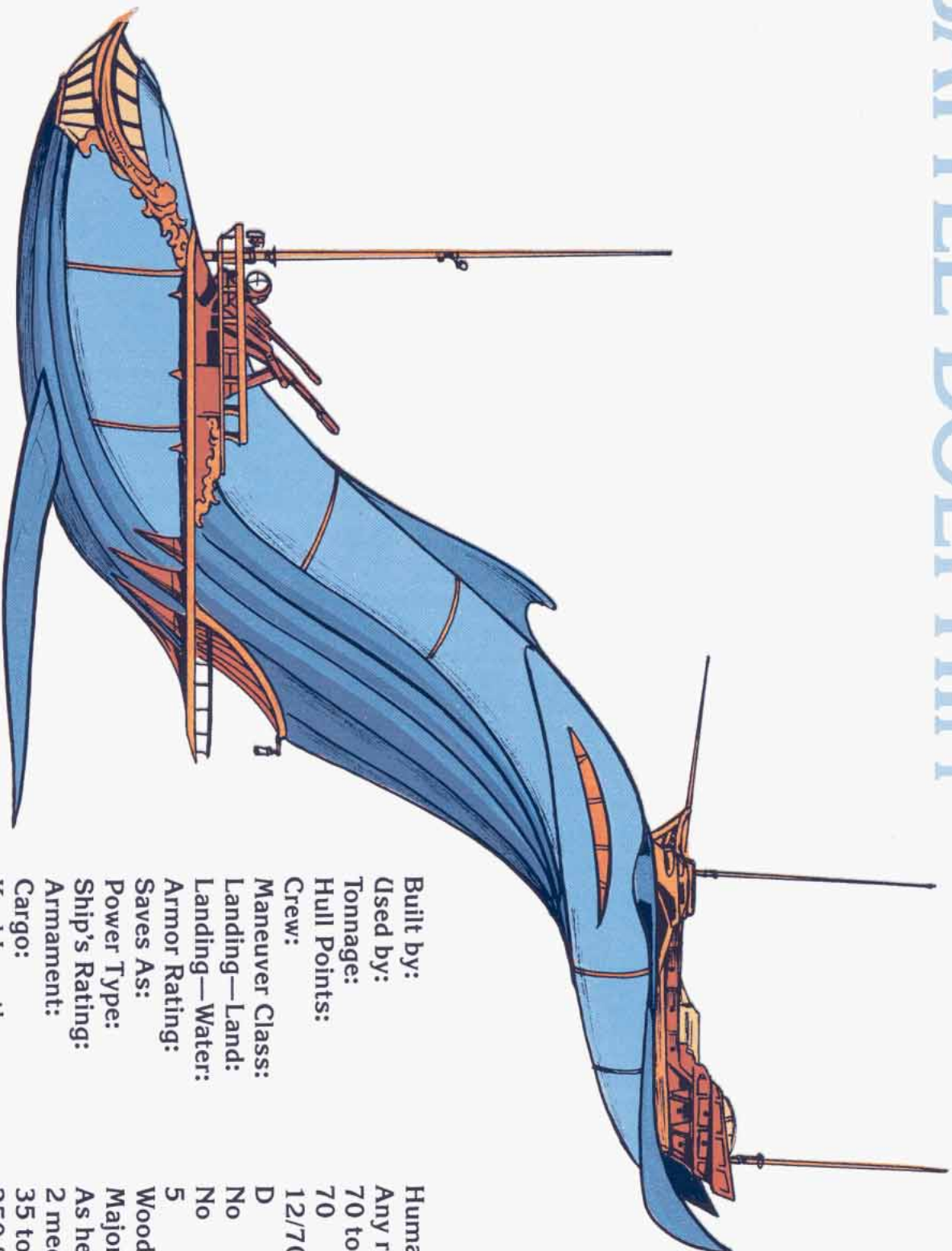

Built by:	Humans
Used by:	Any race
Tonnage:	70 tons
Hull Points:	70
Crew:	12/70
Maneuver Class:	D
Landing—Land:	No
Landing—Water:	No
Armor Rating:	5
Saves As:	Wood
Power Type:	Major helm
Ship's Rating:	As helmsman
Armament:	2 medium catapults
Cargo:	35 tons
Keel Length:	250 ft.
Beam Length:	30 ft.

Battle Dolphin

1 square = 5 feet

Surveillance Deck

1. Crew's Nests
2. Shuttle Dock

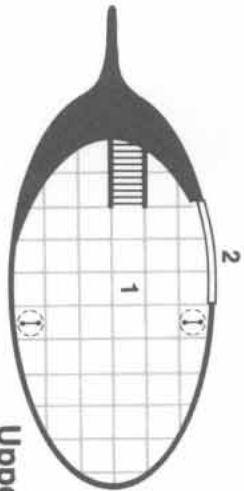

Upper Cargo Deck

- ## Cargo Decks (Upper and Lower)
1. Cargo Hold
 2. Cargo Doors

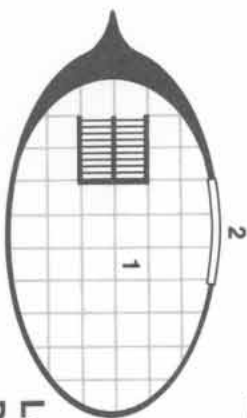

Lower Cargo Deck

- ## Command Deck
1. Main Mast
 2. Catapults
 3. Weapons Deck
 4. Commons
 5. Floor Passage to Officer's Deck
 6. Armory
 7. Quartermasters' Room
 8. Captain's Day Room
 9. Captain's Quarters

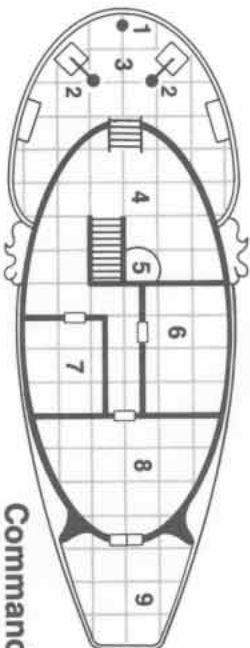

Command Deck

Shuttle Hold Deck

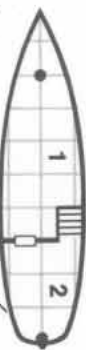

Shuttle Stern Castle

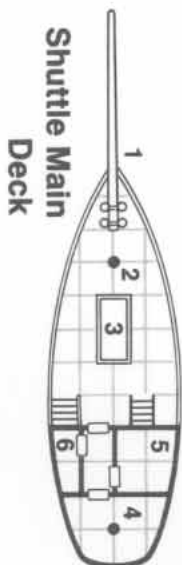
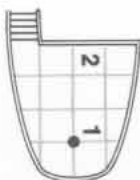

Shuttle Main Deck

Shuttle Hold Deck

- ## Officers' Deck
1. Forward Bridge and Helm
 2. Chart Room
 3. Library/Spellcaster's Quarters
 4. Commons
 5. Floor Passage to Command Deck
 6. Daywatch Post
 7. Storage
 8. State Room

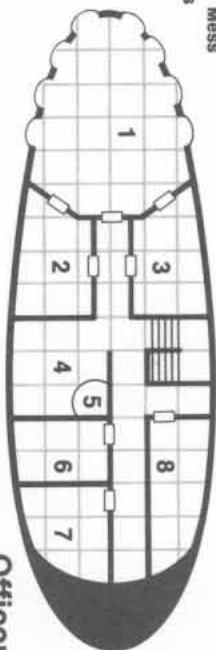

Officers' Deck
(Reverse Gravity From Upper Decks)

Surveillance Deck

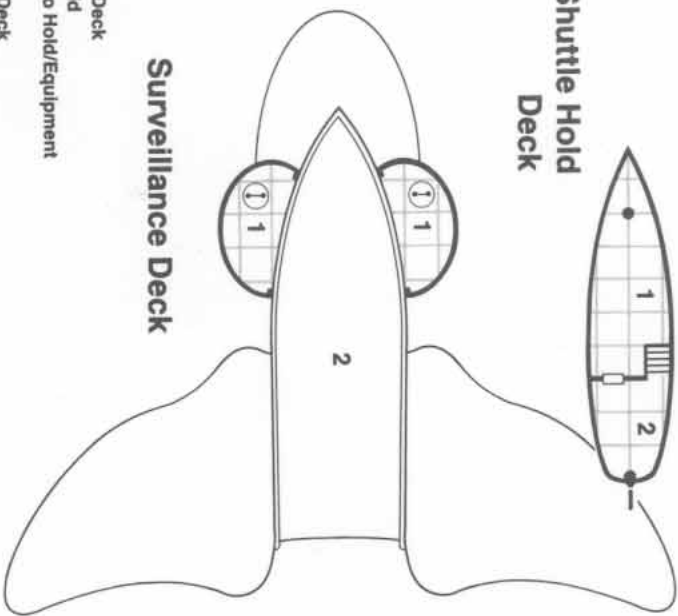

- ## Shuttle Hold Deck
1. Shuttle Hold
 2. Stern Cargo Hold/Equipment

Shuttle Main Deck

1. Jib Boom
2. Foremast
3. Cargo Hold Bay
4. Day Room/Chart Room
5. Captain's Quarters
6. Spelljamming Helm

Shuttle Stern Castle

1. Mizzenmast
2. Captain's Post

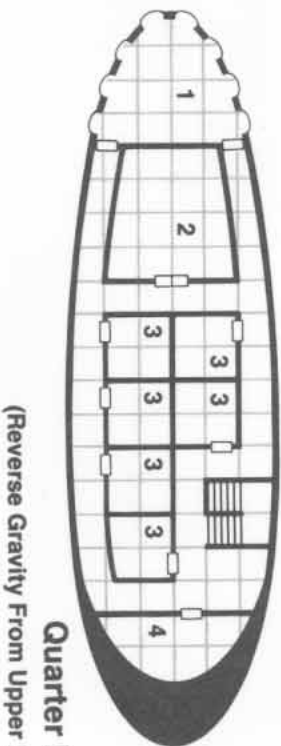
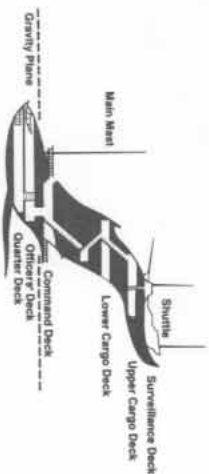

Quarter Deck
(Reverse Gravity From Upper Decks)

CATTLE COMMAND

Built by:	Humans, mind flayers
Used by:	None
Tonnage:	100 tons
Hull Points:	100
Crew:	30/100
Maneuver Class:	E
Landing—Land:	Yes
Landing—Water:	No
Armor Rating:	8
Saves As:	Wood
Power Type:	Major helm
Ship's Rating:	As helmsman
Armament:	4 heavy ballistas 2 heavy catapults 1 heavy jettison
Cargo:	50 tons
Keel Length:	120 ft. (high)
Beam Length:	Variable

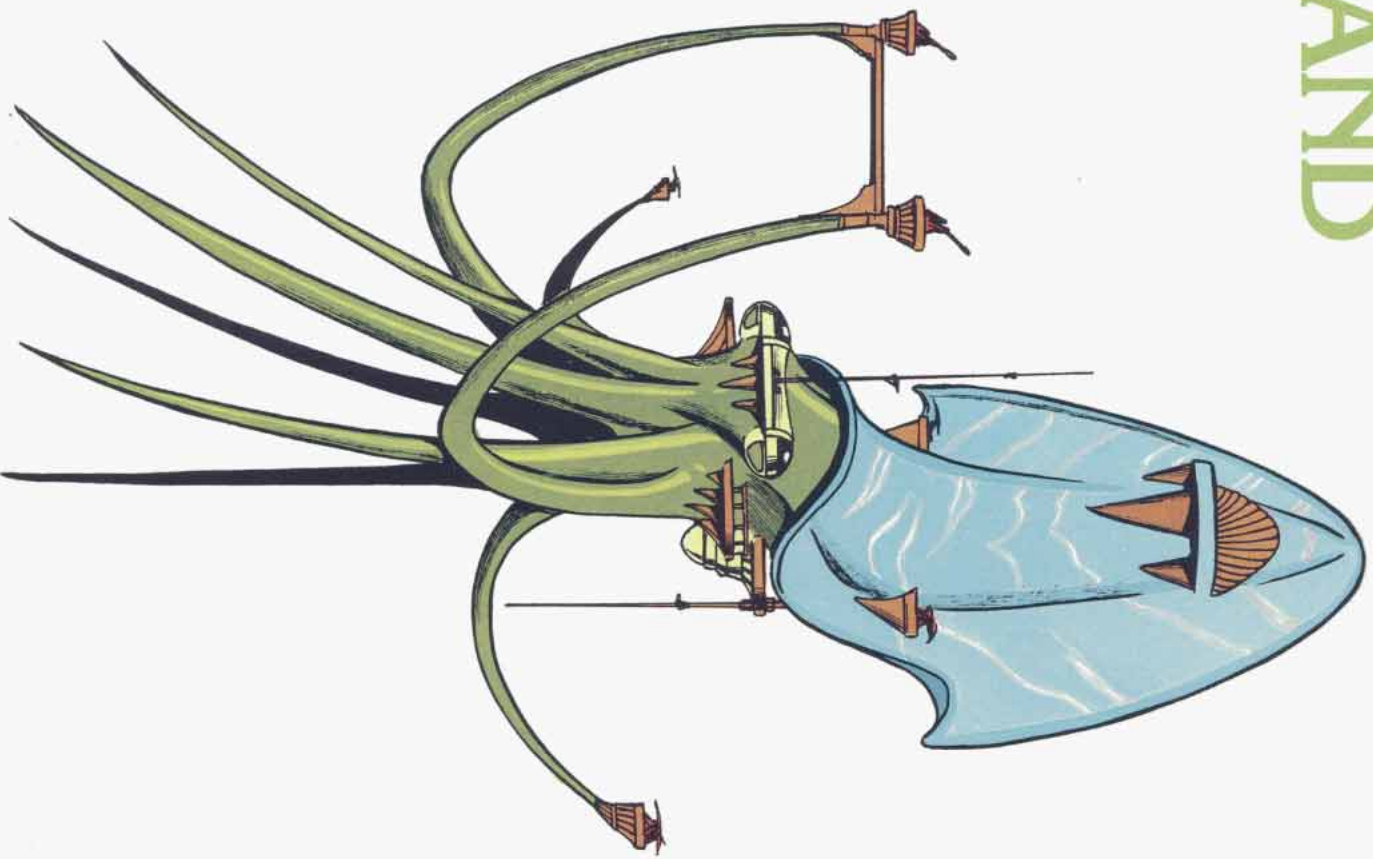

Cuttle Command

1 square = 5 feet

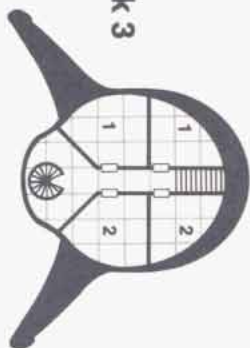

Deck 3

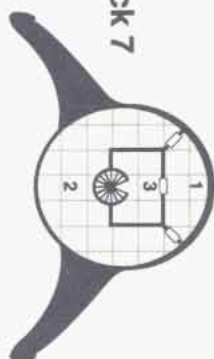

Deck 7

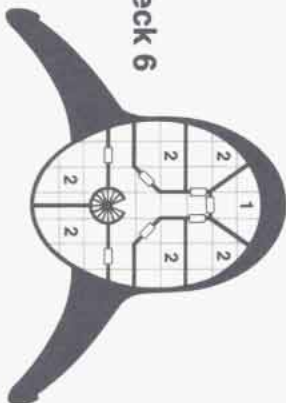

Deck 6

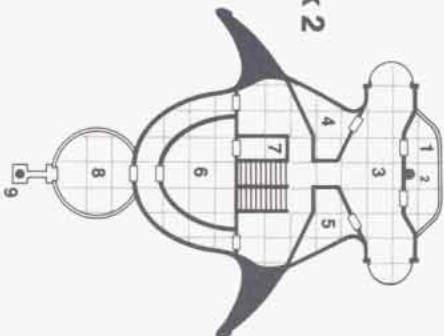

Deck 2

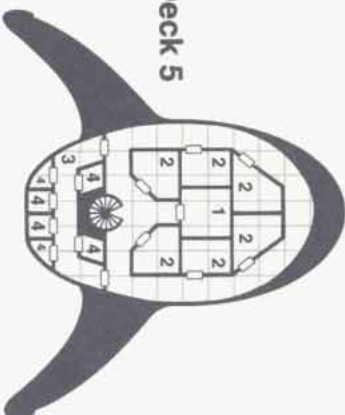

Deck 5

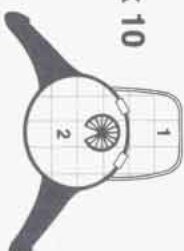

Deck 10



Deck 9

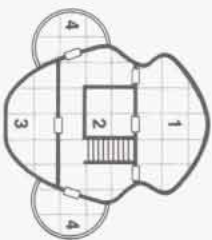

Deck 1

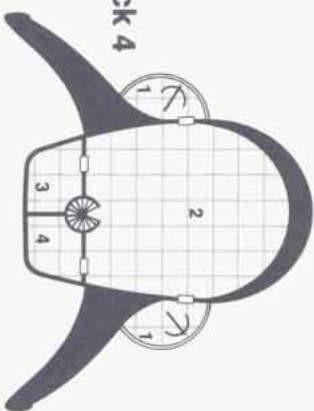

Deck 4



Deck 8

- Deck 1—Level Alpha, Captain's Deck
 1. Captain's Suite
 2. Captain's Private Quarters
 3. Tentacle Control Room and Winches
 4. Observation Platforms
 5. Jettison
- Deck 2—Level Beta, Command Deck
 1. Bow Platform
 2. Foremast
 3. Bridge
 4. Chart Room
 5. Day Room
 6. Helm/Back-Up Helm
 7. Storage/Larder
 8. Jettison Control Platform
 9. Spanker

- Deck 3—Level Gamma, Quarter Deck
 1. Officer Quarters
 2. VIP Cabins
- Deck 4—Level Delta
 1. Ballista Stations
 2. Mess and Muster Hall
 3. Galley
 4. Larder
- Deck 5—Level Epsilon
 1. NCO Quarters
 2. Crew Quarters
 3. Guard Room
 4. Brig
- Deck 6—Level Zeta
 1. NCO Quarters
 2. Crew Quarters
- Deck 7—Level Eta
 1. Guard Room
 2. Treasure Vault
 3. Anteroom

- Deck 8—Level Theta, Wizard's Level
 1. Anteroom
 2. Wizard's Lab and Quarters
 3. Wizard's Library
 4. Secure Room
- Deck 9—Level Iota
 1. Anteroom
 2. Private Cabins
- Deck 10—Level Kappa, Observation Level
 1. Crow's Nest
 2. Observation Deck

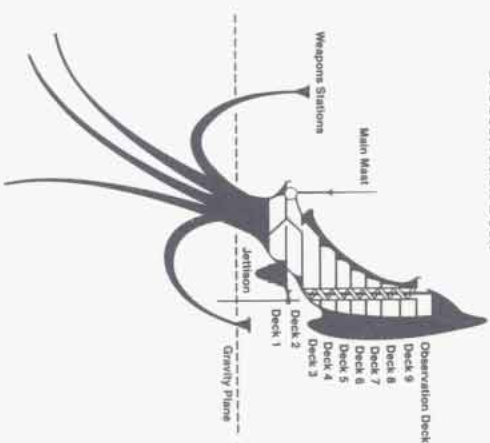

GNOMISH WHELK

Built by: Illusionist gnomes
Used by: Illusionist gnomes
Tonnage: 40 tons
Hull Points: 40
Crew: 20/40
Maneuver Class: D
Landing—Land: Yes
Landing—Water: Yes

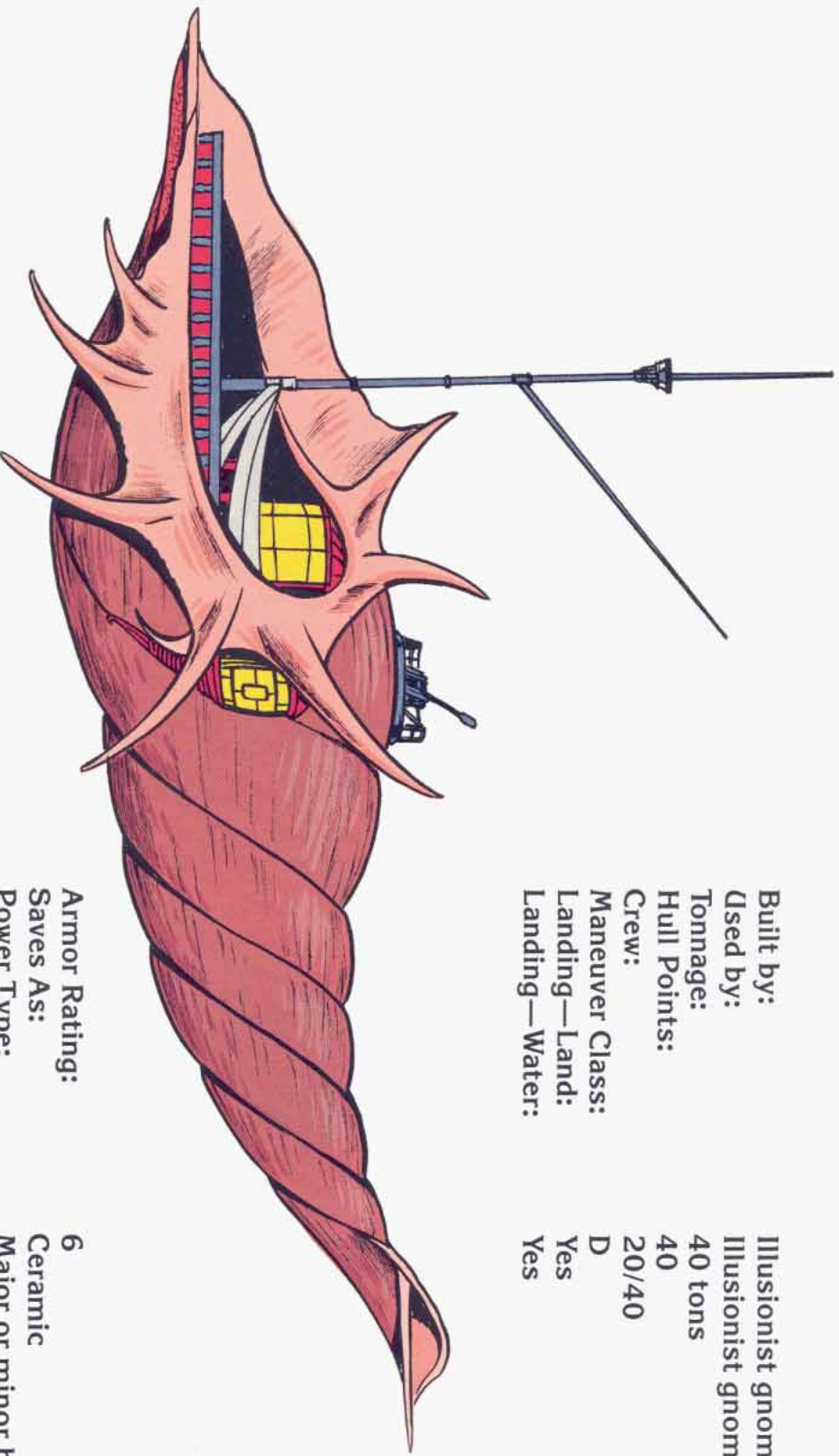

Armor Rating: 6
Saves As: Ceramic
Power Type: Major or minor helm
Ship's Rating: As helmsman
Armament: 1 medium catapult
1 medium jettison
Piercing ram
Cargo: 15 tons
Keel Length: 125 ft.
Beam Length: 35 ft.

Gnomish Whelk

Catapult Deck

1 square = 5 feet

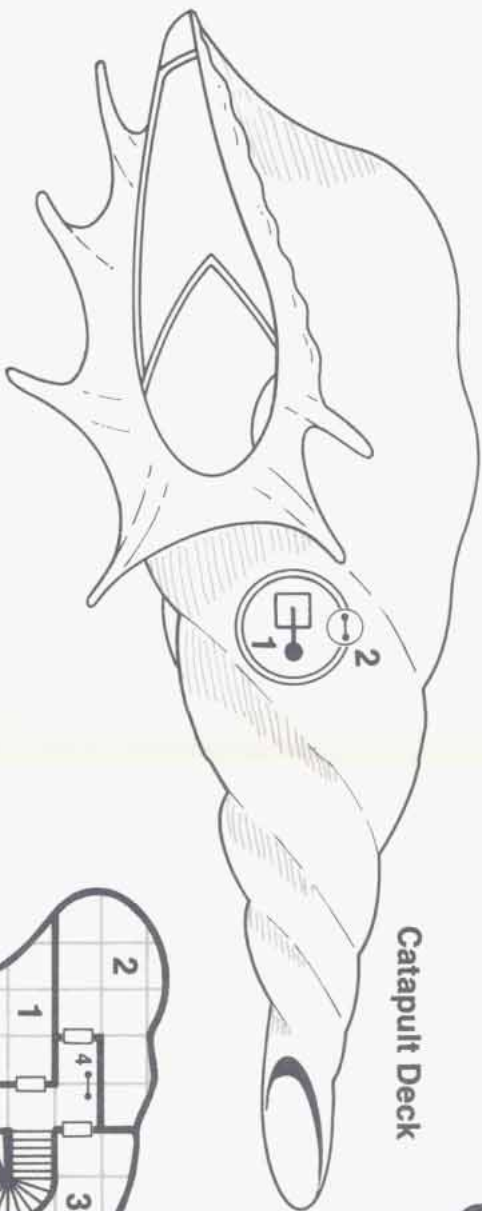

- Catapult Deck**
1. Catapult
 2. Ladder to Upper Deck

Upper Deck

1. Galley/Mess
2. Library
3. Larder
4. Ladder to Catapult

Main Deck

1. Open (Reception) Deck
2. Floor Passage to Cargo Deck
3. Promenade Deck
4. Captain's Quarters
5. Crew Quarters
6. Personal Storage
7. Badger Den
8. Day Room
9. Officer's Quarters
10. Jettison

Cargo Deck

1. Hold (Place for complaining Big People)
2. Floor Passage to Main Deck

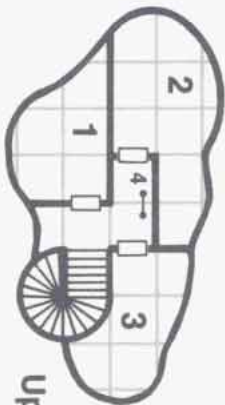

Upper Deck

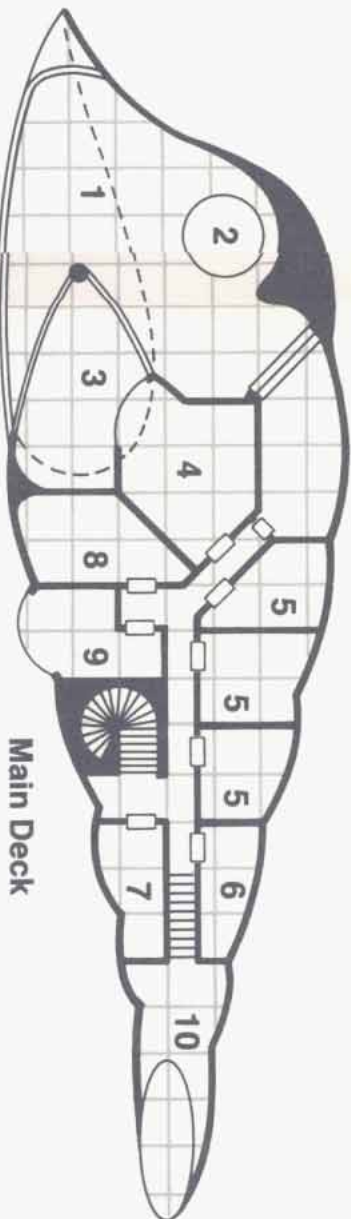

Main Deck

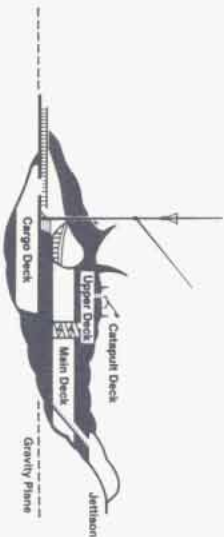

Cargo Deck

(Reverse Gravity From Upper Decks)

GREAT BOMBARD

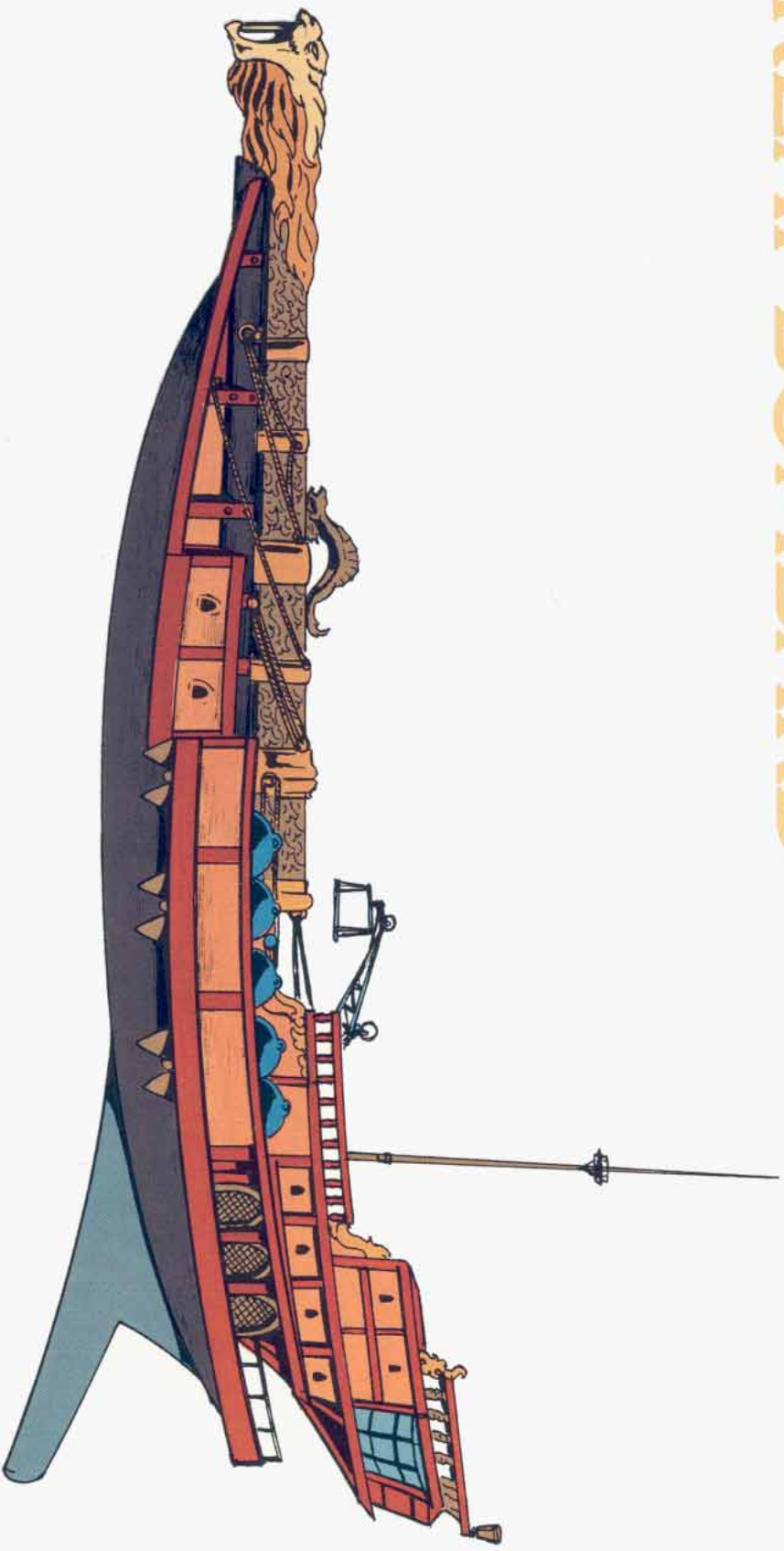

Built by: Giff
Used by: Giff
Tonnage: 50 tons
Hull Points: 50
Crew: 20/50 (10 giffs)
Maneuver Class: E
Landing—Land: No
Landing—Water: Yes
Armor Rating: 6

Saves As: Thick wood
Power Type: Major or minor helm
Ship's Rating: As helmsman
Armament: 1 great bombard
2 light ballistas
Blunt ram
Cargo: 20 tons
Keel Length: 155 ft.
Beam Length: 30 ft.

Great Bombard

1 square = 5 feet

- Fantail Bridge Deck**
1. Ballistas
 2. Ammunition Hold
 3. Flying Fantail Post

- Signal Deck**
1. Gift Quarters
 2. Winch
 3. Main Mast

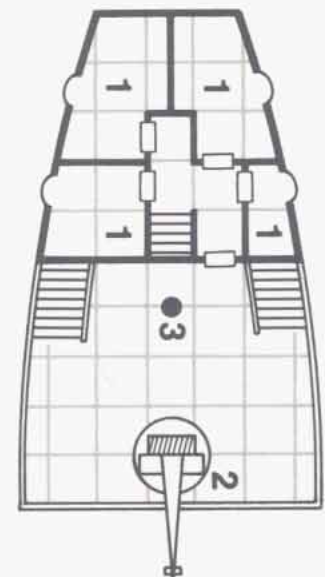

Signal Deck

Fantail Bridge Deck

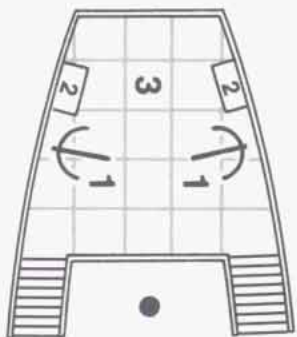

- Gun Deck**
1. Captain's Quarters
 2. Brige and Helm Room
 3. Chart Room
 4. Captain's Larder
 5. Powder Room (Steel-lined)
 6. Bombard Shot
 7. Great Bombard

- Below Deck**
1. Att Promenade
 2. Galley
 3. Gift Mess
 4. Non-Gift Crew Quarters
 5. Gift Quarters
 6. Guest Cabin
 7. Cargo Hold

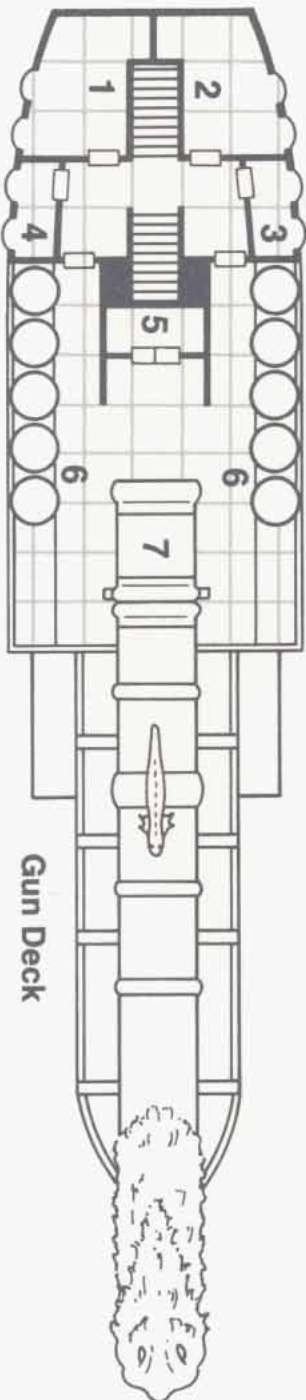

Gun Deck

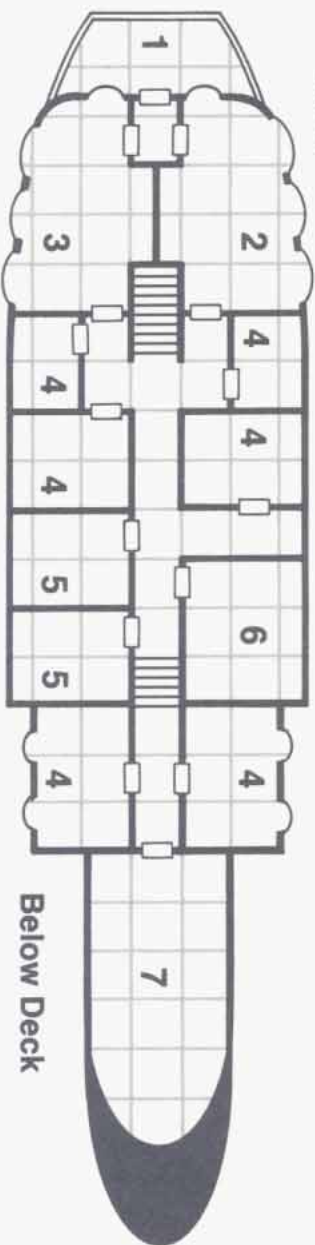
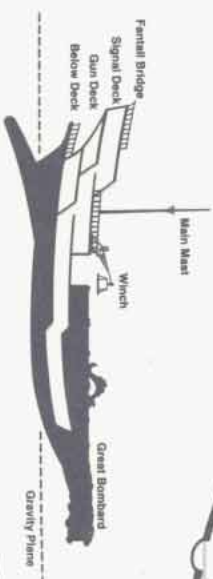

Below Deck

QUENTIN'S LIBRARIA

Built by:
Used by:
Tonnage:
Hull Points:
Crew:
Maneuver Class:
Landing—Land:
Landing—Water:
Armor Rating:
Saves As:
Power Type:

Human (Quentin Axan)
Human (Quentin Axan)
30
30
5/30
E (variable)
Yes
No
7
Thick wood
Major helm

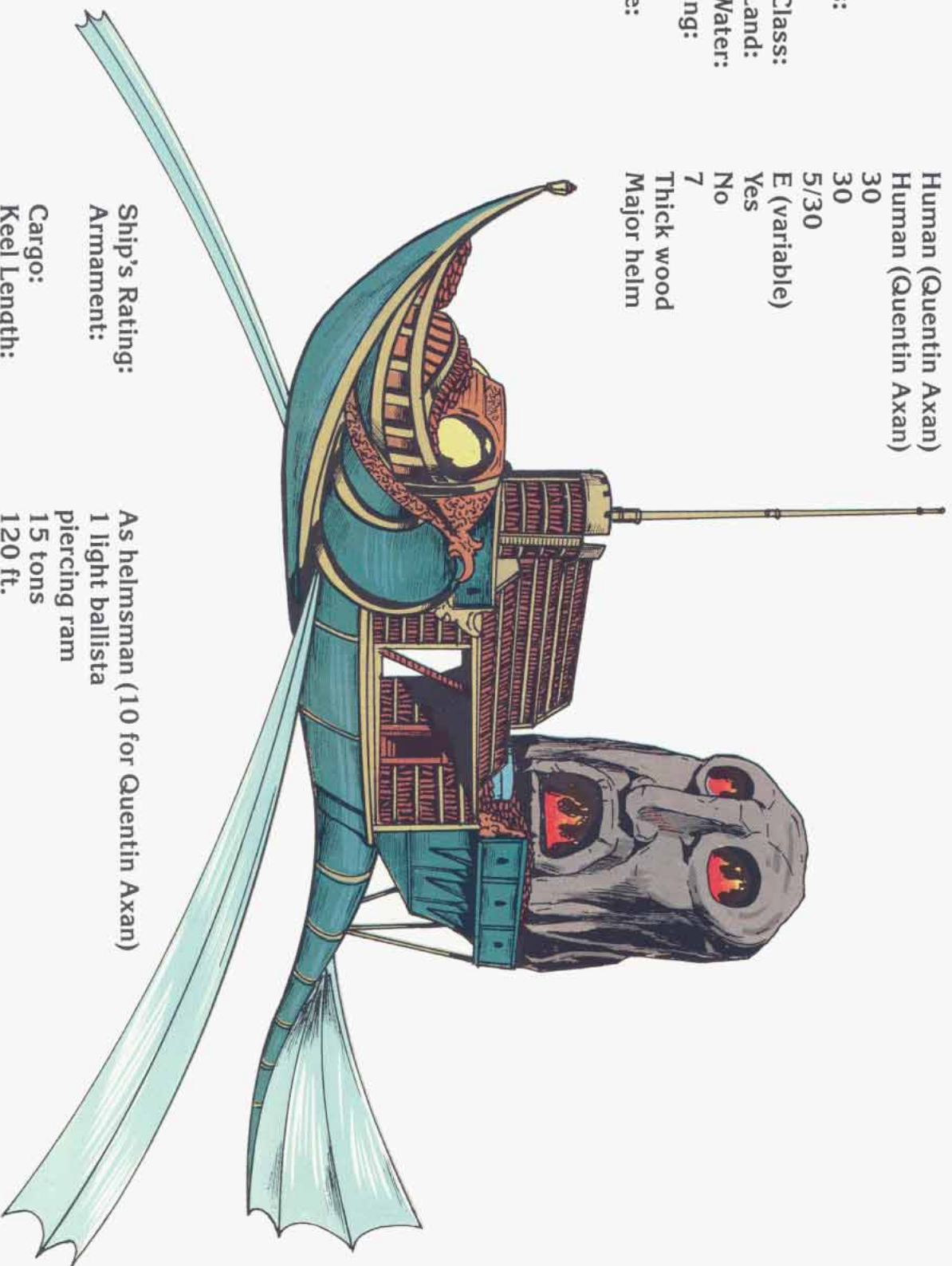

Ship's Rating:
Armament:
Cargo:
Keel Length:
Beam Length:

As helmsman (10 for Quentin Axan)
1 light ballista
piercing ram
15 tons
120 ft.
25 ft.

Quentin's Libraria

1 square = 5 feet

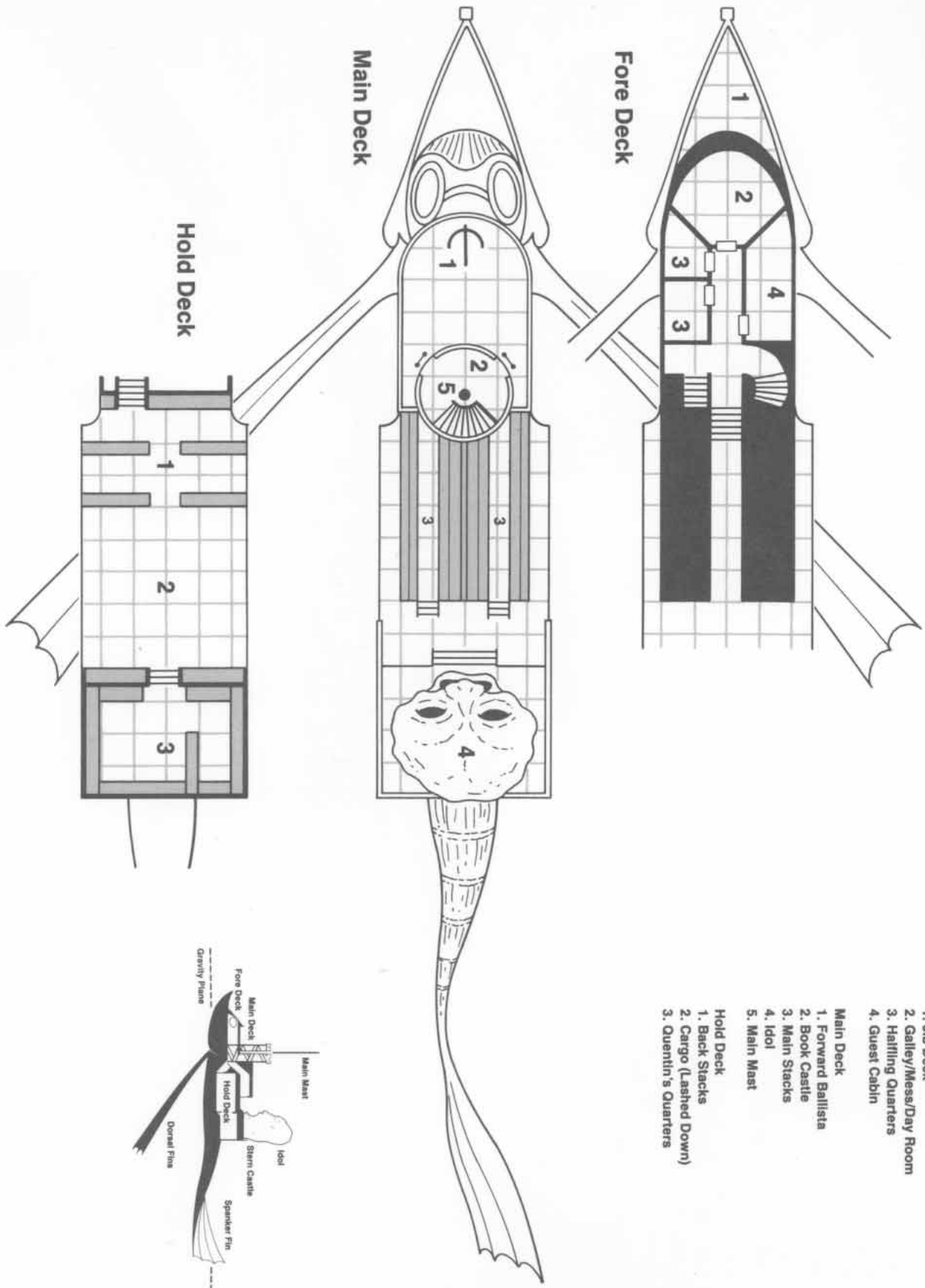

- Fore Deck**
- 1. Jib Deck
 - 2. Galley/Mess/Day Room
 - 3. Hailling Quarters
 - 4. Guest Cabin

- Main Deck**
- 1. Forward Ballista
 - 2. Book Castle
 - 3. Main Stacks
 - 4. Idol
 - 5. Main Mast

- Hold Deck**
- 1. Back Stacks
 - 2. Cargo (Lashed Down)
 - 3. Quentin's Quarters

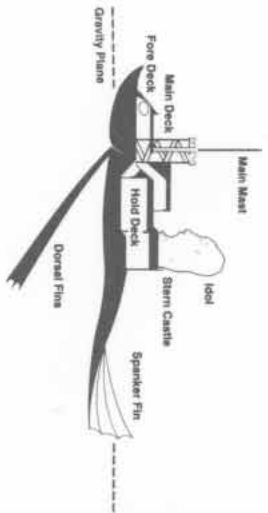

SMALLJAMMER

Built by:	Spelljammer
Used by:	Any race or none
Tonnage:	25 tons
Hull Points:	25
Crew:	1/25
Maneuver Class:	B
Landing—Land:	Yes
Landing—Water:	Yes

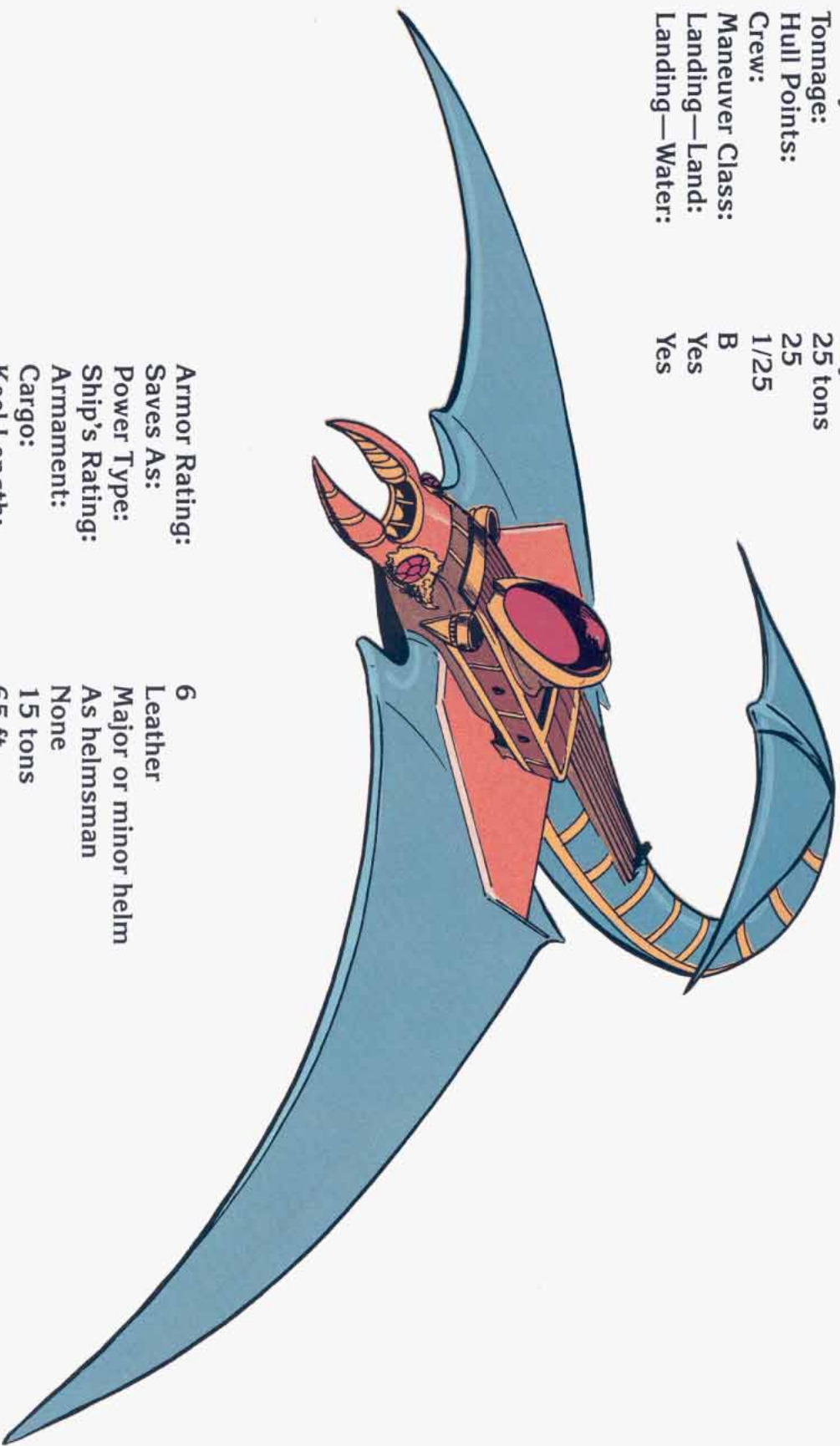

Armor Rating:
Saves As:
Power Type:
Ship's Rating:
Armament:
Cargo:
Keel Length:
Beam Length:

6
Leather
Major or minor helm
As helmsman
None
15 tons
65 ft.
140 ft. (wingspan)
40 ft. (hull beam)

Smalljammer

1 square = 5 feet

- Observation Deck
 - 1. Roof Hatches
 - 2. Observation Cabin
- Upper Deck
 - 1. Hatchways
 - 2. Passage
 - 3. Personal Quarters
 - 4. Storage/Larder
 - 5. Galley
- Wing Deck
 - 1. Forward Controls
 - 2. Cabins
 - 3. Open Deck

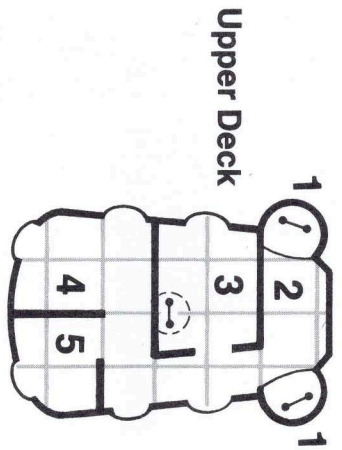

Upper Deck

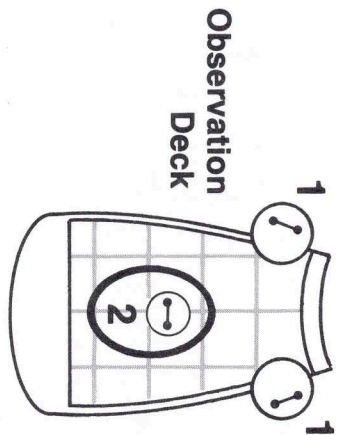

Observation Deck

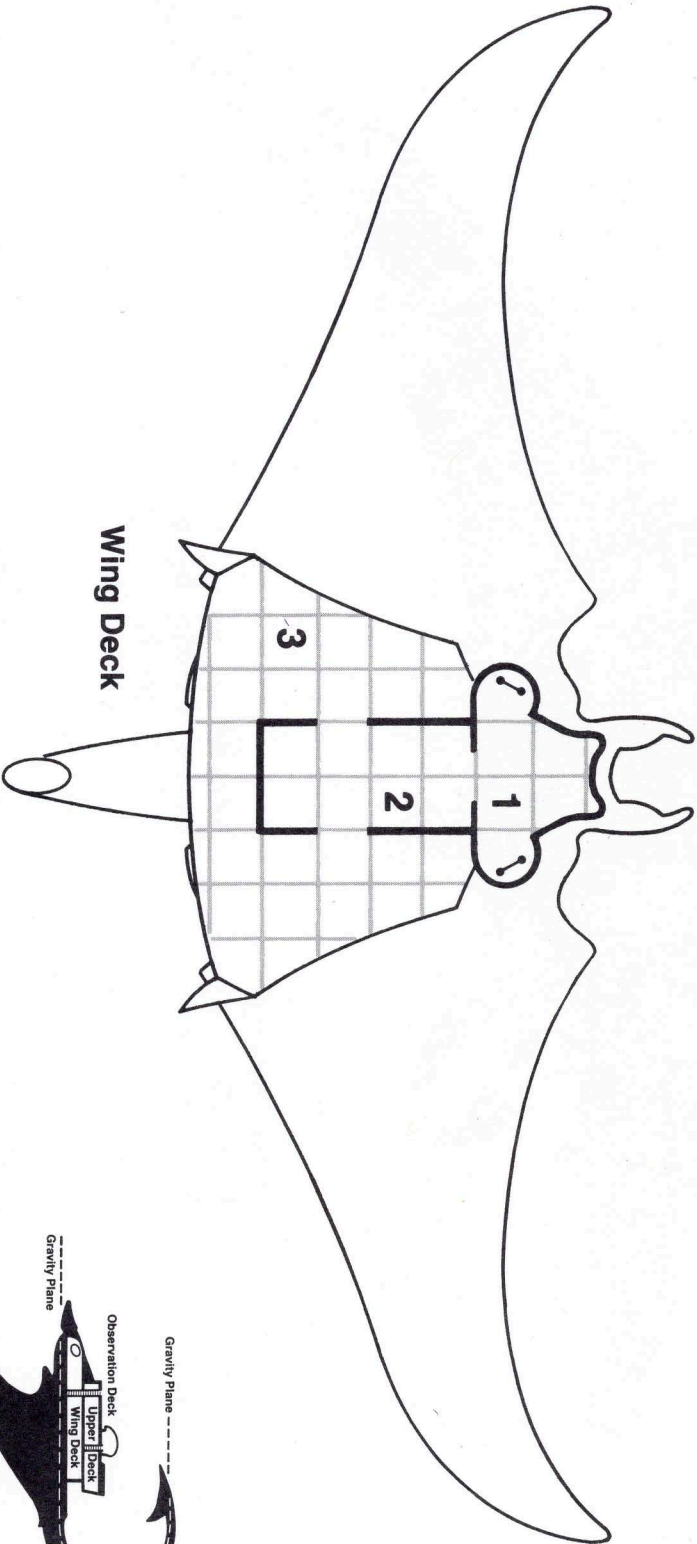

Wing Deck

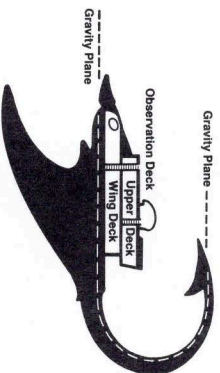

Smalljammer interiors vary radically between smalljammers, and interior walls and passages may shift over time. This configuration is one version, and does not apply to all smalljammers.

WHALESHIP

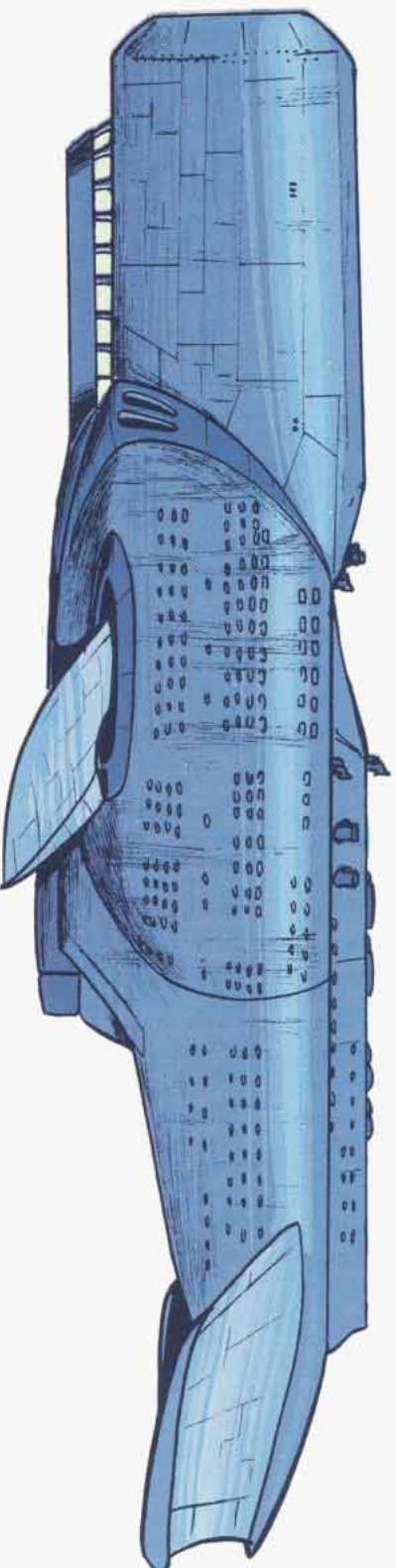

Built by: Humans
Used by: Humans
Tonnage: 90 tons
Hull Points: 90
Crew: 20/90
Maneuver Class: E
Landing—Land: No
Landing—Water: Yes
Armor Rating: 4

Saves As:
Power Type:
Ship's Rating:
Armament:

Thick wood
Major helm
As helmsman
1 medium jettison
blunt ram
Cargo: 40 tons
Keel Length: 250 ft.
Beam Length: 40 ft. (90 ft. with Flippers)

Whaleship

1 square = 5 feet

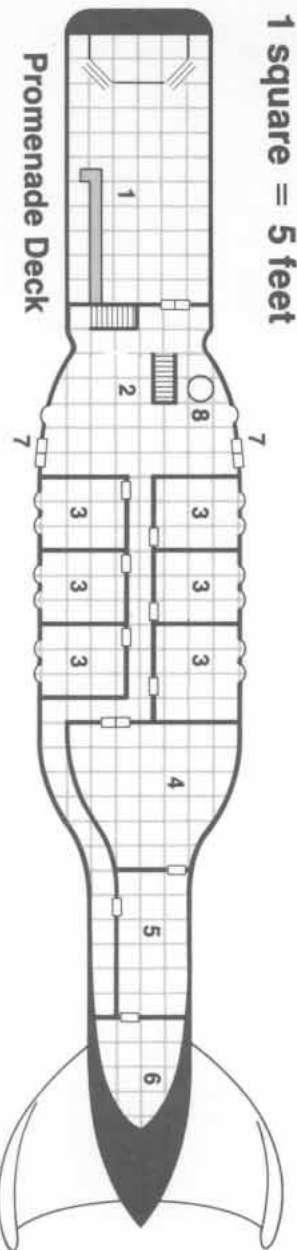

Promenade Deck



Quarter Deck

(Reverse Gravity From Upper Decks)

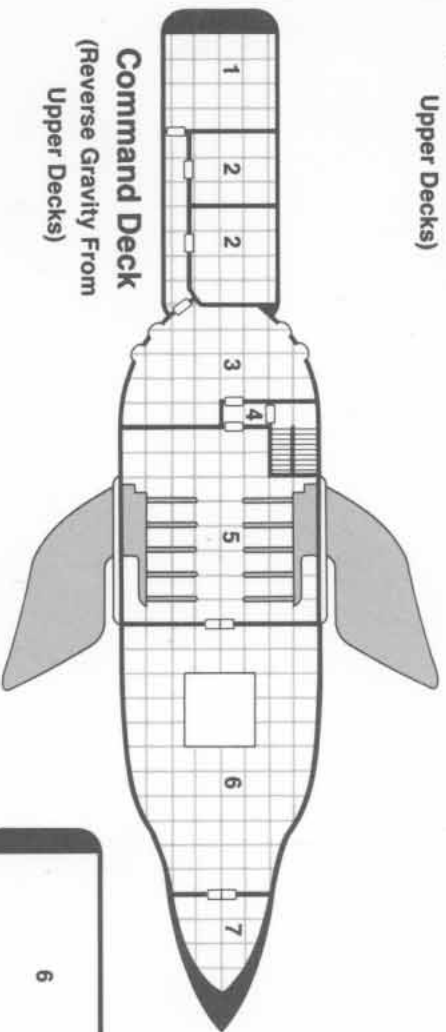

Command Deck

(Reverse Gravity From Upper Decks)

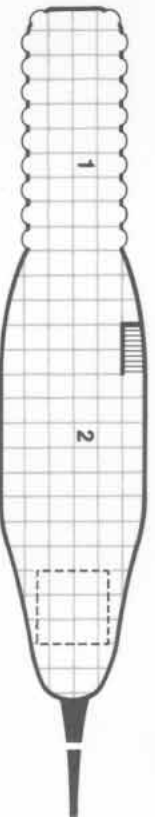

Cargo Deck

(Reverse Gravity From Upper Decks)

- Observation Deck
 1. Passenger Cabins
- Gallery Deck
 1. Purser's Office
 2. Passenger Cabins
 3. Linen and Ship's Storage
 4. Laundry and Water Supply
 5. Purser's Lockroom
 6. Open to Forward Salon
- Promenade Deck
 1. Forward Salon (Including Bar and Stage)
 2. Ship's Commons
 3. Passenger Cabins
 4. Formal Dining Room
 5. Galley
 6. Ship's Pantry
 7. Extendable Passenger Gangplank
 8. Floor Passage to Quarter Deck
- Quarter Deck
 1. Passenger Quarters
 2. Private Suites
 3. Crew Quarters
 4. Cargo area with overhead pulley system
 5. Floor Passage to Promenade Deck
- Command Deck
 1. Captain's Quarters
 2. Officer's Quarters
 3. Bridge and Dayroom
 4. Security Passage
 5. Flipper Controls
 6. Central Cargo Area
 7. Jettison
- Cargo Deck
 1. Cargo Loading Ramp
 2. Cargo Area

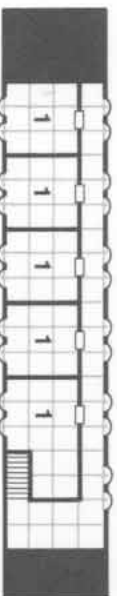

Observation Deck

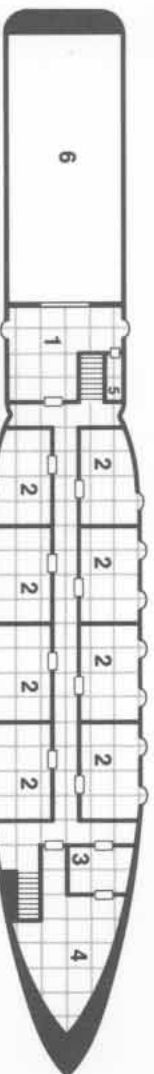

Gallery Deck

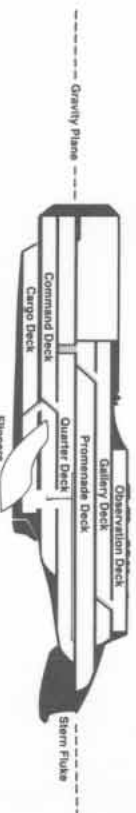

OCTOPUS

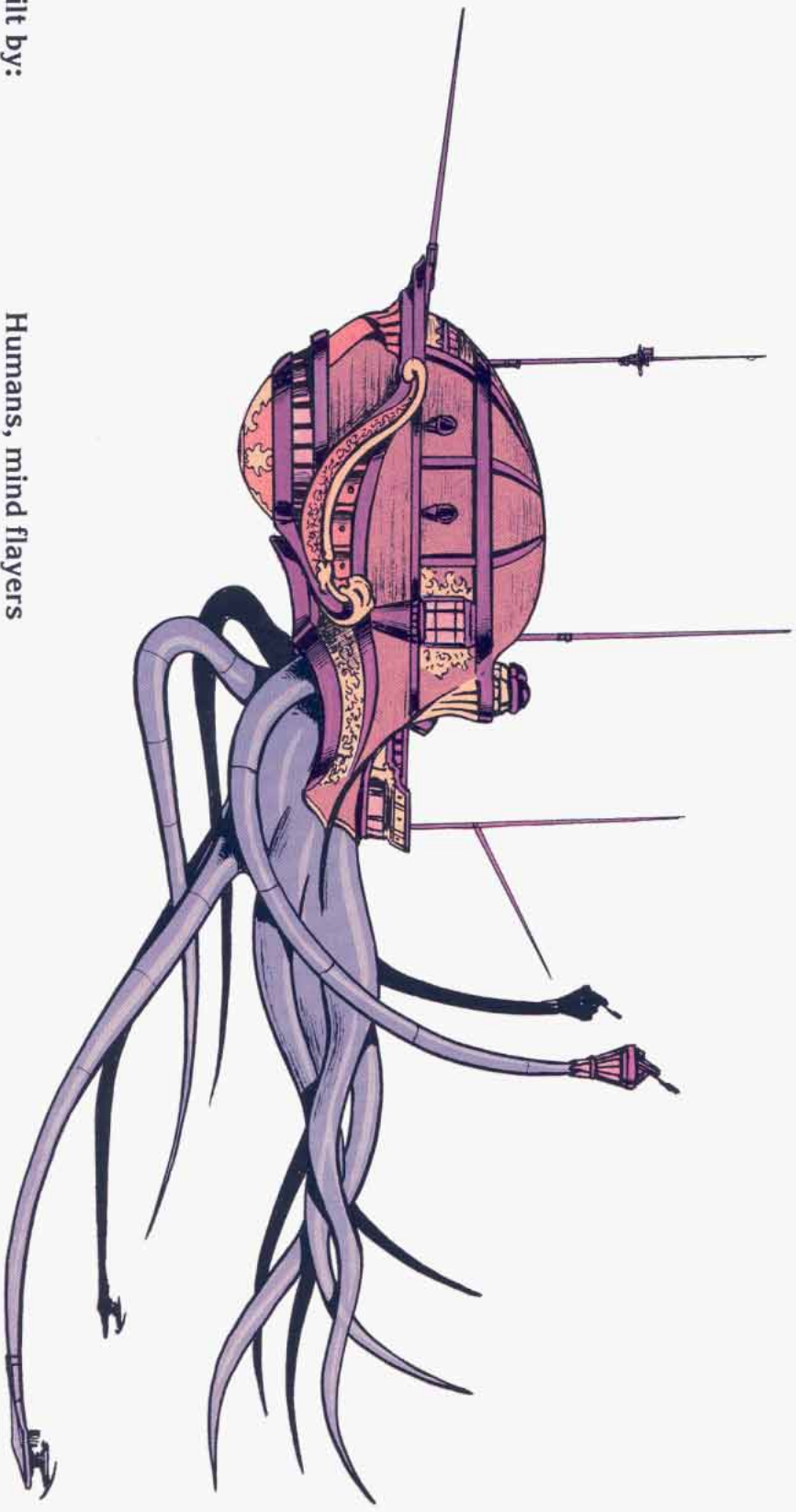

Built by: Humans, mind flayers
Used by: Humans, mind flayers
Tonnage: 70 tons
Hull Points: 70
Crew: 13/70
Maneuver Class: D
Landing—Land: Yes
Landing—Water: No
Armor Rating: 7
Saves As: Wood

Power Type: Major helm or pool helm
Ship's Rating: As helmsman
Armament: 2 heavy catapults
2 heavy ballistas
Cargo: 35 tons
Keel Length: 100 ft. (not including tentacles)
Beam Length: 50 ft.

Octopus

1 square = 5 feet

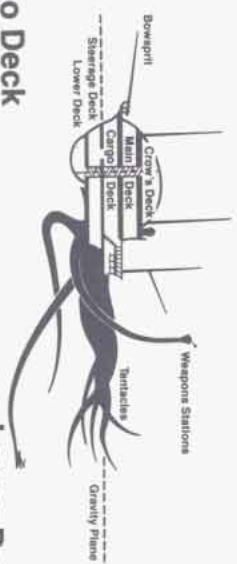

Main Deck
(Reverse Gravity From Upper Decks)

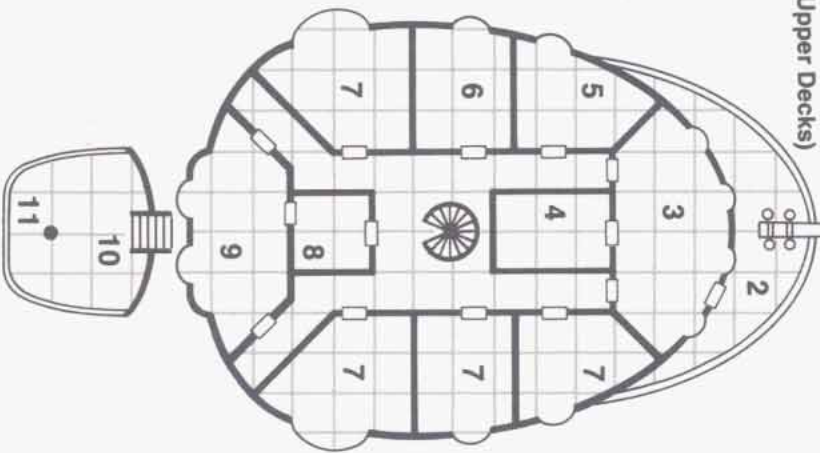

Cargo Deck

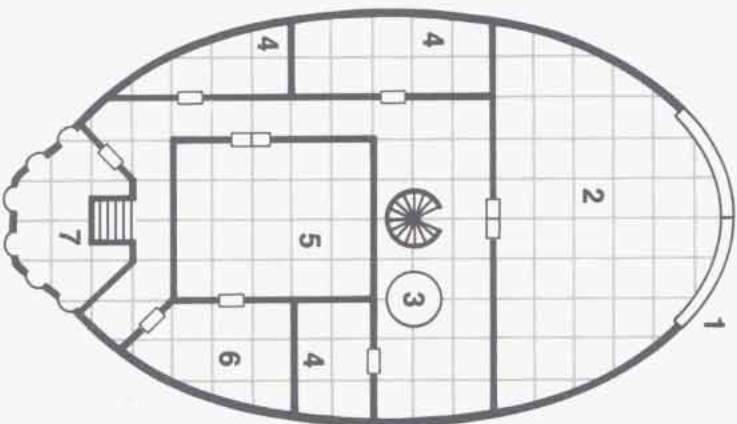

Lower Deck
(Reverse Gravity From Upper Decks)

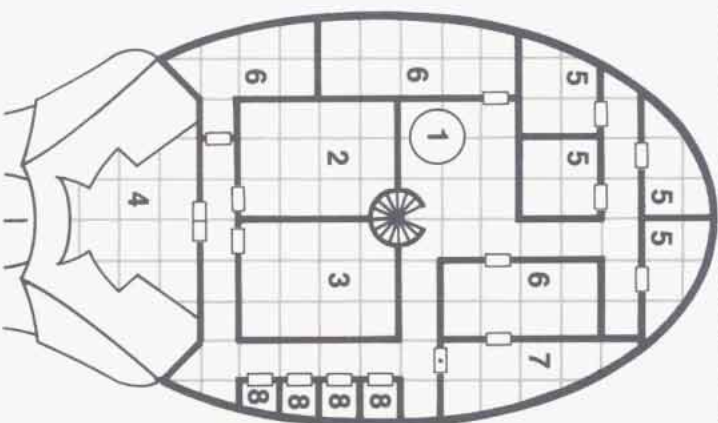

Crow's Deck
(Reverse Gravity From Upper Decks)

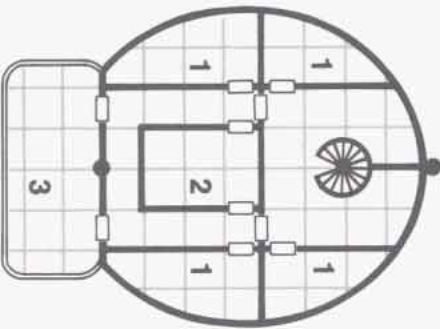

- Crow's Deck**
1. Private Quarters
 2. Private Mess
 3. Flying Bridge

Main Deck

1. Bowsprit
2. Forecastle
3. Bridge/Helm
4. Day Room
5. Captain's Quarters
6. Ship's Mage Quarters
7. Officers' Quarters
8. Galley and Larder
9. Ship's Mess
10. Sterncastle
11. Mizzenmast

Cargo Deck

1. Cargo Bay Doors
2. Main Cargo Bay
3. Access Passage to Lower Deck
4. Lesser Cargo Bays
5. Meeting Hall and Muster Room
6. Cargo Crew Quarters
7. Cargo Master's Quarters

Lower Deck

1. Access Passage to Cargo Deck
2. Officer's Quarters—Master Mechanic
3. Officer's Quarters—Weapons Master
4. Tentacle Control Winches
5. Crew Quarters
6. Officers' Quarters
7. Ship's Armory
8. Detention Cells

Steerage Deck

1. Stowage

Steerage Deck

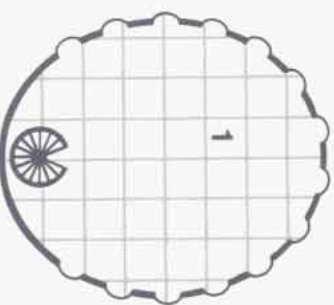

UNITY SHIP

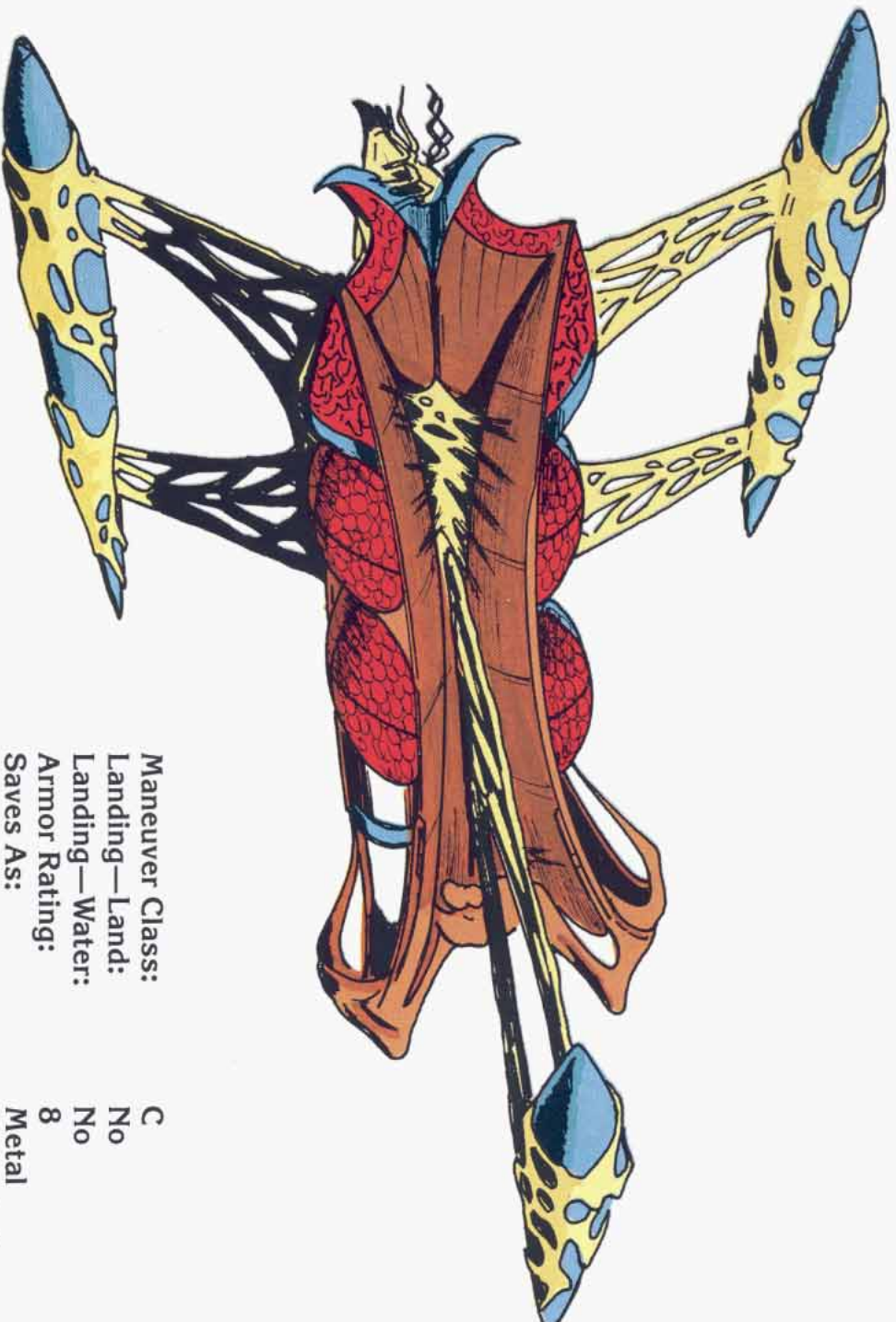

Built by:
Used by:
Tonnage:
Hull Points:
Crew:

K'r'r'r'r
K'r'r'r'r
30 tons each
30
15/30

Maneuver Class:
Landing—Land:
Landing—Water:
Armor Rating:
Saves As:
Power Type:
Ship's Rating:
Armament:

C
No
No
8
Metal
K'r'r'r'r helm
As helmsman
3 medium ballistas
Piercing ram
10 tons
120 ft.
30 ft.

Unity Ships of the K'r'r'r'r

1 square = 5 feet

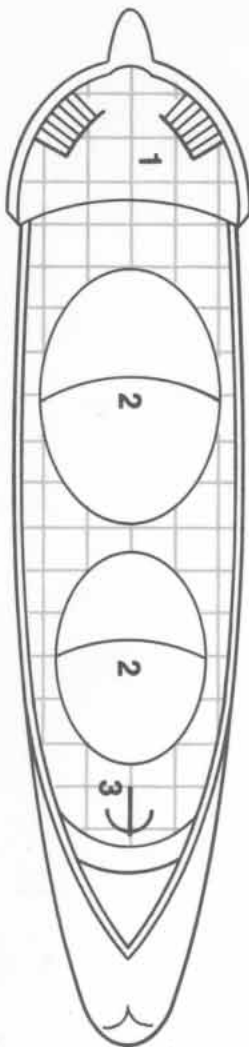

Typical Upper Deck

- Typical Upper Deck**
1. Aftcastle /Lookout
 2. Cargo Bay Doors
 3. Bow Ballista

- Deck A**
1. War Master's Quarters
 2. Warrior Quarters
 3. Passage to Other Decks
 4. Cargo—Valuables

- Deck B**
1. Helm/Bridge/Priest Quarters
 2. Passage to Other Decks
 3. Cargo—Bulk Storage
 4. Prisoner Cells/Larders

- Deck C**
1. Passage to Other Decks
 2. Bulk Cargo (Overhead Doors for Loading)

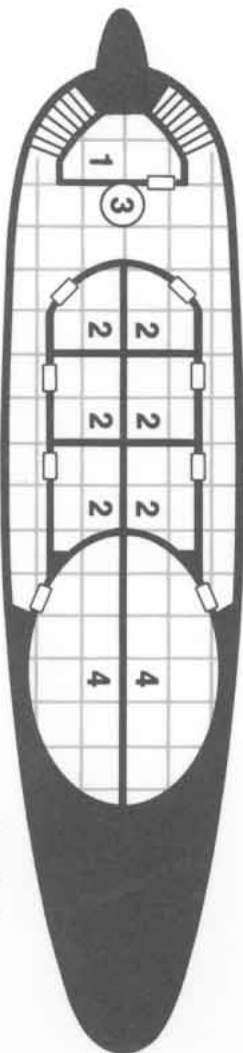
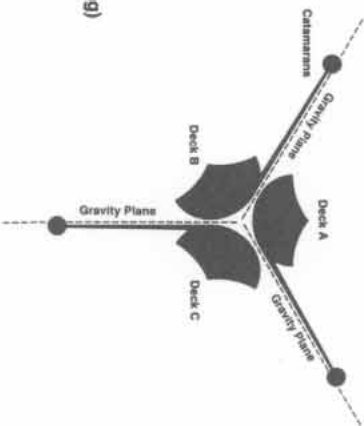

Deck A

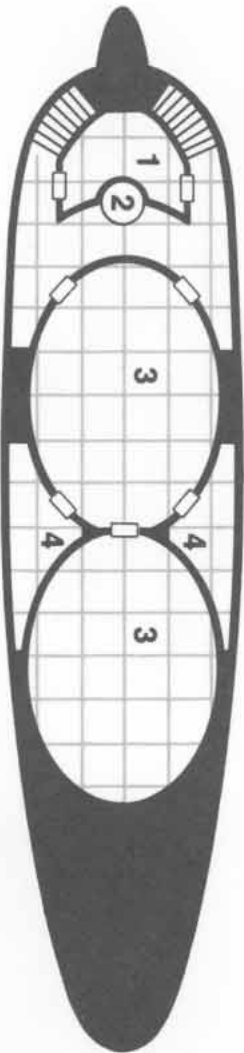

Deck B

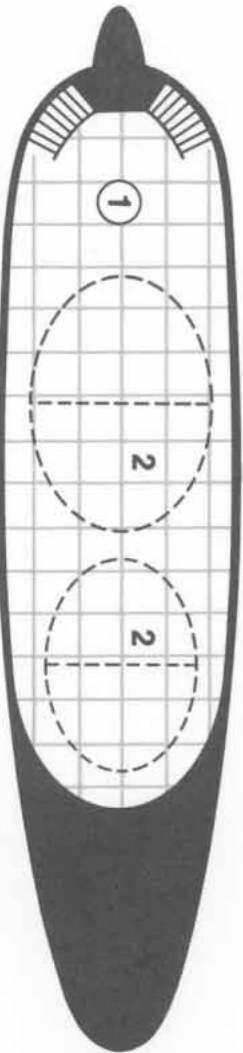

Deck C

ILLITHID DREADNOUGHT

Built by:	Mind flayers
Used by:	Mind flayers
Tonnage:	100 tons
Hull Points:	100
Crew:	20/100 (usually 100 mind flayers)
Maneuver Class:	E
Landing—Land:	No
Landing—Water:	Yes
Armor Rating:	4
Saves As:	Thick wood
Power Type:	Pool helm
Ship's Rating:	5

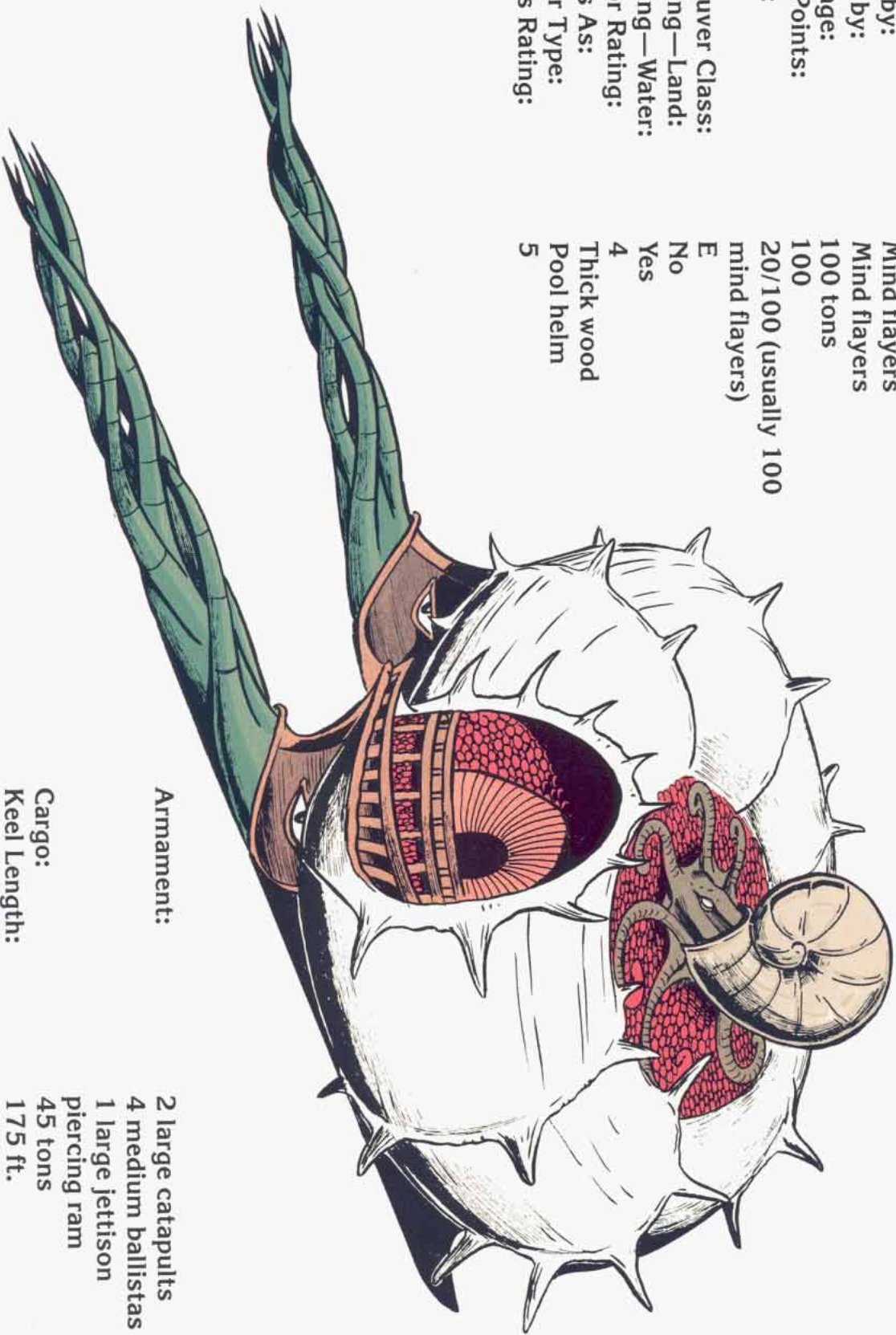

Armament:

- 2 large catapults
- 4 medium ballistas
- 1 large jettison
- piercing ram

Cargo:

Keel Length:
175 ft.

Beam Length:
95 ft.

Illithid Dreadnought

1 square = 5 feet

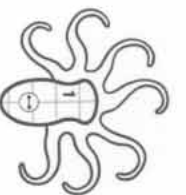

Meditation Level

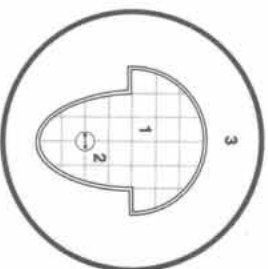

Meditation Level

1. Back-Up Bridge—Major Helm
- ### Command Level
1. Captain's Chair
 2. Captain's Day Room
 3. Open to Lower Levels

Bridge Level

1. Weapons Officer Station
2. Navigation Officer Station
3. Morale Officer Station
4. Maintenance Officer Station
5. Access to Command Level (Restricted)
6. Open to Lower Levels

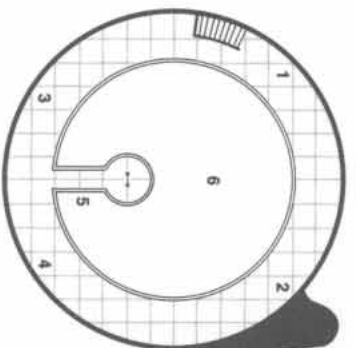

Bridge Level

Command Level

- ### Weapons Level
1. Battle Stations
 2. Hatches and/or Illusionary Walls
 3. Muster Area for Boarding Parties
 4. Pool of Immature Illithids
 5. Pool Helm
 6. Open Lower Levels

Cargo Level

1. Cargo Area
2. Crew Quarters
3. Galley
4. Mess and Larder

Quarter Level

1. Captain's Quarters
2. Mess/Day Room
3. Chart Room
4. Officer's Quarters

Command Hull

1. Jettison and Storage
2. Crew Quarters
3. Morale Area
4. Mess
5. Private State Room

Battle Hull

1. Guard Quarters
2. Guard Post
3. Slave Quarters
4. Interrogation Section

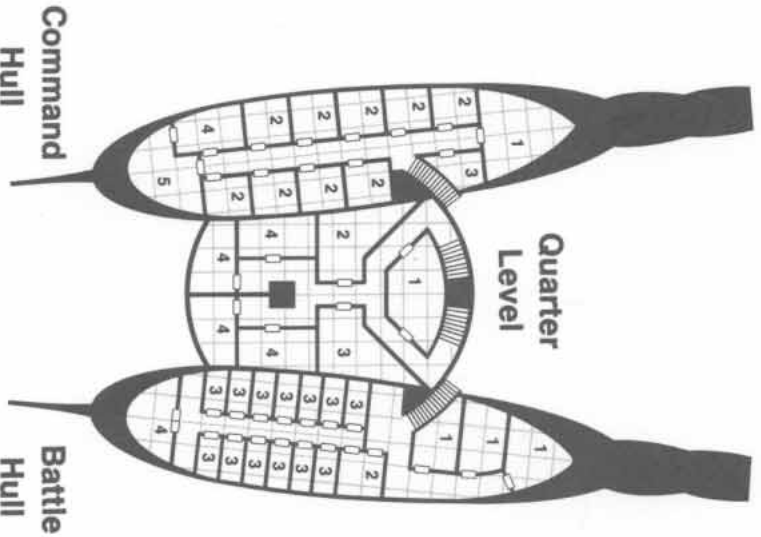

Command Hull

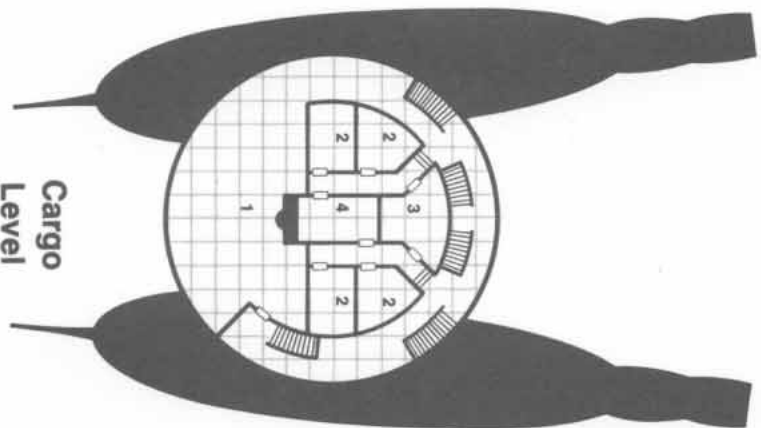

Battle Hull

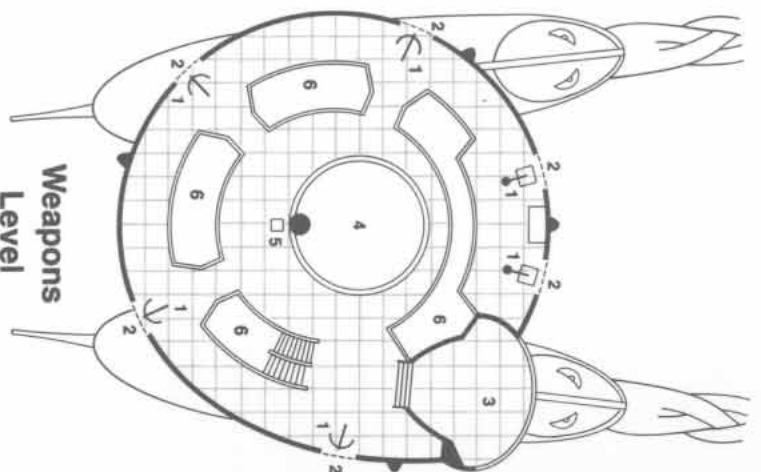

Cargo Level

Weapons Level



THE LEGEND OF SPELLJAMMER

Feared by some, hunted by others, the awesome vessel *Spelljammer* glides through the vastness of space on manta wings. For the first time ever, the myths surrounding the Great Ship are unveiled, allowing you to expand your SPELLJAMMER™ game campaign.

Is the *Spelljammer* a legend from the past or a mystery of the present? Is it truly a ship or a living being? Who commands it? What secrets hide in its massive hull and dark towers? The true story of the *Spelljammer* is revealed in this box.

This accessory is an epic adventure setting for use with the original SPELLJAMMER™ Adventures in Space

boxed set. Within this box you will discover new monsters and races, exciting new ships and characters, plus the fantastic *Spelljammer* itself.

The Legend of Spelljammer accessory contains:

- A 32-page book of legends and statistics about the Great Ship;
- A 64-page guided tour of the citadels, towers, and communities that crowd the back of the *Spelljammer*;
- A 96-page book of new ships and nonplayer characters, plus adventures aboard the *Spelljammer*;
- Two maps revealing the ship's citadels; and
- Full-color cards showing new ships and their deck plans.



TSR Inc.
POB 756
Lake Geneva,
WI 53147 U.S.A.

TSR Ltd.
120 Church End, Cherry Hinton
Cambridge CB1 3LB
United Kingdom

ADVANCED DUNGEONS & DRAGONS and AD&D are registered trademarks owned by TSR, Inc.
SPELLJAMMER and the TSR logo are trademarks owned by TSR, Inc.
©1991 TSR, Inc. All Rights Reserved.

\$20.00 U.S.
1065

£11.99 U.K.