

Advanced Dungeons & Dragons[®]
2nd Edition

SPINNING JAMMER[™]

GAME



AD&D[®]
ADVENTURES IN SPACE



Advanced Dungeons & Dragons
2nd Edition

SPELLJAMMER™

AD&D® ADVENTURES IN SPACE



Lorebook of the Void

Advanced Dungeons & Dragons
2nd Edition

SPELLJAMMER™

Supplement

Lorebook of the Void

by Jeff Grubb



***There are worlds beyond worlds—
cold, hot, light, dark,
watery and earthen.
They all share one basic need—
a need for Heroes.***

—Elminster the Sage

***I look at the night sky and I think . . .
there's gotta be something out there
worth stealing.***

—Alliya Makabuck, Halfling Inc.

Design: Jeff Grubb
Editing and Development: Steve Winter, Jim Lowder, Jon Pickens,
Karen Boomgarden, Eric Severson, Kim Mohan
Spiritual Guidance: Jim Ward
Box Painting: Jeff Easley
**Book Cover Paintings,
Illustrations, Ship Concepts:** Jim Holloway
Cartography: Diesel
Color Inking, Counter Silhouettes: Roy Parker
Graphic Design: Stephanie Tabat
Typography: Angelika Lokotz, Gaye O'Keefe

**A product such as this is the result of much cross-fertilization.
To those friends and associates who contributed and are not
listed above, we extend our thanks and apologies.**

TSR, Inc.
POB 756
Lake Geneva,
WI 53147 USA



TSR Ltd.
120 Church End, Cherry Hinton
Cambridge CB1 3LB
United Kingdom

The product you are holding in your hands is the result of a brainstorming session held in a local Lake Geneva restaurant. The designers and editors had been cloistered there to come up with some new ideas and alternatives for the AD&D® game system. The general talk was pretty wild and the waitress asked if we were working for Steven Spielberg, who was rumored to be scouting locations in the area.

If this project is weird enough to be considered a potential movie idea, then we may have done our job here.

The design directive for the SPELLJAMMER™ supplement was simple: Take the AD&D game into outer space. Then we started adding stuff. It couldn't be like anything ever done before. It shouldn't overturn existing campaigns. Then, "Hey, we've got these 24 pieces of cardboard available, Jeff, how about designing some ships to put on them?" The setting should link together the Realms, Krynn, and Greyhawk without invalidating any of those worlds or the games already set there.

This was becoming a tall order: Maintain the spirit and play of the AD&D game *and* tie it in with years of previous work without invalidating anything. But if space functions normally, how (for example) do the constellations of Krynn move around without messing up other planets?

Zeb Cook pulled out some medieval woodcuts showing a traveler passing through the spheres of the world to discover the sun and planets on tracks, and with that the idea of crystal shells was born. Each fantasy solar system could have its own placement and rules, while being a part of a larger whole.

That larger whole created its own problems, because space is big. Really big. As I write this, *Voyager II* has just rounded Neptune after a 12-year voyage. Conventional movement

would result in long and empty voyages, which would make for poor role-playing. Yet, everything we see in most fantasy worlds posits an Earthlike world with Earthlike celestial effects.

The need to travel quickly across space brought about the spelljamming helm and with it we cut ourselves fully loose from real science and began creating a "fantasy physics" that was true to its own rules and laws. Dave LaForce (better known as Diesel) and I started kicking ideas around for gravity planes and atmospheric envelopes, making it possible for the space pirate to stand on the deck of his ship beneath open space.

How does it all work? Well, the easy answer is "It's magic." The more involved answer is "It's magic and it *knows* it's magic." The rules are still there and must be obeyed, but it is a different set of rules from what we are used to in our world. As anyone here will tell you, a fire-breathing, 50-foot-long, flying reptile is impossible, but it can live in our imaginations. The same argument applies to spelljamming ships.

Jim Holloway started playing with ship types and Diesel began designing both the *Spelljammer* itself and the asteroid base that became the Rock of Bral. Jim was surprised when he brought in five different beholder ship drawings and we accepted them all. Previously, one ship type or style would do for a space-based campaign, but here we had flying things that looked like half-walnuts, modified galleons, and giant moths!

The reason for this diversity is to keep with the precepts of our fantasy universe—there are a lot of different races out there and all their ships should not look the same. "Real science" restrictions like aerodynamics are not a concern in worlds with flying carpets and mind flyers. The

ships of wildspace reflect this diversity. In many cases, Jim came up with a drawing and then the rest of us showed how it could work.

You'll notice the editors are also listed as developers in the credits. In particular, Steve Winter (general coordinator and main editor) and James Ward (design manager and my boss) were responsible for multiple additions and revisions in the text. I would finish a particular section, James would review it and come up with five more neat things we could do with it, and I would scurry back to my computer, giggling and cackling over the new ideas.

Similarly, Steve Winter went over the rules with an eye toward consistency and fun, adding and refining the various pieces of the system into a complete whole. This was a Herculean task. Our main goal was to not to produce a miniature wargame that simplified AD&D game procedures but rather a supplementary system to help DMs and players enjoy ship-to-ship fighting in a most unusual setting.

And there you have it. I once described designing this product as the gaming equivalent of running through a mansion, flinging open the doors, and discovering what lies beyond them. In many ways the size of space itself, the unlimited number of possible encounters, ships, races, monsters, and other neat stuff to be found out there, has proved to be the greatest challenge. This box is the first giant step—not a furtive foothold but a full-tilt charge—into a new universe of gaming.

On behalf of the creators of the SPELLJAMMER supplement, I hope you enjoy the trip.

Jeff Grubb
August 1989

Table of Contents

Foreword	3
CHAPTER 1 CAMPAIGNS IN SPACE	6
Getting Started: The Type of Campaign	6
Getting There: Going Into Space	7
Space Adventures	9
Life on Other Planets	11
Types of Worlds and Their Life Forms	11
Monsters by World Type	11
Monster Appearance	11
Change in Monster Statistics	12
Landfall Arriving at Planets	13
When Space Meets Ground	13
CHAPTER 2 SPELLJAMMERS	14
Definition of Terms	14
Flitter	15
Mosquito	16
Caravel	17
Dragonfly	18
Damsel fly	19
Wasp	21
Tyrant Ship	22
Tradesman	25
Gnomish Sidewheeler	27
Nautiloid	29
Neogi Mindspider	31
Galleon	32
Squid Ship	33
Dragonship	35
Hammership	37
Man-o-War	40
Neogi Deathspider	41
Armada	44
Citadel	45
<i>Spelljammer</i>	47
CHAPTER 3 SPACEFARERS	50
Life in Space	50
Humans	50
The Elven Armadas	55
Dwarves	56
Lizard Men	57
Gnomes	58
Halflings	59
Goblin Races	59
Extraplanar Beings	60
Giants	60
Mind Flayers	61
Dragons	62
Centaur's	62
Undead	62
Golems	64
Lycanthropes	64
Other Monsters	65
Starbeasts	65

Table of Contents

<i>New Monsters:</i>	
Arcane, The	67
Beholder (Orbus & Hive Mother)	69
Dracon.	71
Dragon, Radiant.	73
Elmarin.	75
Ephemeral	76
Giff.	77
Kindori	79
Krajen.	81
Neogi.	83
Scavver.	85
CHAPTER 4 KNOWN SPHERES.	87
A Brief Tour of the Known Spheres	87
Krynnspace	87
Sun, Sirion, Reorx, Krynn, Chislew, Zivilyn	
Greyspace	89
Oerth, Kule, Raenei, Liga, The Grinder, Edill, Gnibile, Conatha, Ginsel, Borka, Greela, The Spectre	
RealmSpace	92
The Sun, Anadia, Coliar, Toril, Karpri, Chandos, Glyth, Garden, H'Catha	
SHIP INFORMATION FORM.	96
A Guide to Sidebar Subjects	
At the Helm.	6
Why Ships In Space?.	14
Packing Them In	20
Types of Worlds, Part 1: Earth Worlds.	26
Types of Worlds, Part 2: Fire Worlds	30
Types of Worlds, Part 3: Water Worlds	36
Notes on the Creation of the Universe	42
Major and Minor Races.	50
The Adventurer Who Fell to Earth	56
Types of Worlds, Part 4: Air Worlds	62
Homeworlds.	88
Types of Worlds, Part 5: Liveworlds	90
PRODUCT CONTENTS	
BOOKS:	
Concordance of Arcane Space	
Lorebook of the Void	
MAPS:	
The Spelljammer	
The Rock of Bral	
Planetary Display Chart	
Tactical Combat Chart	
REFERENCE & COUNTER CARDS:	
1 Planetary Information Sheet	3 Ship Counter Sheets
2 Hammership Deckplans	2 Squid-Ship Deckplans
2 Tradesman Deckplans	2 Dragonfly Deckplans
2 Nautiloid Deckplans	2 Dragonship Deckplans
2 Wasp Deckplans	2 Man-O-War Deckplans
2 Galleon Deckplans	
1 Neogi Deathspider Deckplan	1 Neogi Mindspider Deckplan



At the Helm

What spelljamming feels like:

The wizard or priest who uses a spelljamming helm deals with two levels of reality: In the first, they are in their own body and aware of the actions around them. They may talk and converse with others normally, though they may not move or cast spells while at the helm without breaking contact with the spelljamming device.

The second level of reality is a larger, expanded consciousness in which the spellcaster feels the ship he is in as an extension of his own body. The ship itself, to the limits of its gravity plane, and the air envelope, feel like a bubble under the control of the spelljamming mage or priest. This concept of linking is important for the spelljammer helm to function.



AD&D® game campaigns using the SPELLJAMMER™ fantasy setting pose some problems unlike those found in other fantasy worlds. The greatest problems are the open-ended nature of the campaign, and the space involved. A trip from Earth to Mars in our fantasy terms takes only a few days. Using 20th century technology, the same trip would take over a year and a half under optimum conditions.

The other challenge of fantasy space is diversity. We are talking about a campaign that includes Greyhawk, Kara-Tur, the Forgotten Realms, and Krynn, plus whatever campaigns the DM chooses to add. Keeping an eye on the diverse campaigns is a bit of a trick, not to mention making sure that new worlds appear truly fresh and different to the star voyager.

Much of space is empty, but encounters can happen anywhere on the trip, which may aid or hinder the traveler. The nature of the spelljammer helms makes it necessary to slow down for obstacles and intersecting ships, rendering encounters all the more likely.

This section is to aid the DM in getting a fantasy space campaign started and in running it over long periods of time.

Getting Started: The Type of Campaign

The SPELLJAMMER fantasy setting can be used in a number of ways. It may be used as a change from the standard ground-based campaign, using established heroes from your campaign who find themselves in space. The heroes may have one (or several) adventures in space before deciding to return to their native lands, or they may choose to remain in a full-fledged space-based campaign. A second use for the setting is to create a fully space-based AD&D

fantasy campaign, not tied to any planet or area. A third use of the setting is to provide background for adventures within your own campaign.

Dealing with these uses in order, the greatest task is in bringing a ground-based campaign into space. Bringing the characters directly in is discussed in the next section. The DM has to do some ground work (so to speak) before dragging his heroes into the void.

The first step is to determine what is out there in the first place. This can be as simple as laying out the planetary system, or as complex as doing several planetary systems initially. For the "TSR worlds" of Oerth, Krynn, and Toril, their solar systems are already established and detailed in the *Concordance*. For a DM's private campaign setting, the DM may either create the system randomly, using the tables in chapter 5 of the *Concordance*, or lay out his cosmology as he sees fit.

A word of advice: Unless you've already set up a cosmology for your fantasy world (such as a ringworld or Dyson sphere), it's best to keep with the ideas of our "typical" space: spherical planets orbiting around a central body in an orderly fashion. Since this is the system that your players have lived with in the real world, it is the easiest to grasp. They have enough new ideas hitting them when they get into space, and tossing puzzling cosmologies at them may confuse them even further. Their fantasy campaign is "normal" to them, a common touchstone from which the fantastic can spring. As an example of this, note that all three of the TSR campaigns are based on spherical planets, rotating in 24-hour periods, and revolving around the sun in the period of a year. (Well, Oerth's sun revolves around *it* once a year, but the effect is the same.)

Things to worry about in your initial cosmology:

- Locations of the planets
- Sizes of the planets
- Types of the planets
- Shapes of the planets
- Level of spelljamming activity
- Types of creatures found in this area of space
- Inhabitants of other worlds
- Nearby asteroids, bases, and stellar cities

The first four are handled in chapter 5 of the *Concordance*. The activity level of the spelljamming ships describes how often the heroes will run into other spelljamming ships. A low number reflects that the area is out of the way and not traveled much (such as Krynn), while a high activity level indicates that the sphere is a crossroads of activity.

As far as types of creatures in space, it is use the ones within these books that suit your fancy. If your characters are sick to death of beholders and will attack you physically if they run into a ship with 20 of them on board, then the beholder civil war does not have to spill into this section of space. If you want to establish a medusan city-dome on an airless moon, go ahead. In general, there will be human life in your section of space (adventurers if nothing else), and likely dwarves and elves. Undead ships and mind flayers are common as well, and neogi only slightly less so. The neogi and the beholders are tough customers, and as such it is best for low-level adventurers to avoid such encounters early on.

Finally, the characters will need a base of operations from one mission to the next, a place to rest up and get supplies. Included in this box is a map of the Rock of Bral, a "typical" space city. The DM is free to place this asteroid city around the world of his choice: Krynn, Toril, Oerth, or one of his own choosing, to use as a base.

For campaigns which start in space, the Rock also provides an initial base of operations for the characters. Such heroes would have a little more knowledge than your groundling adventurers; they would understand the basics of space travel and spelljamming helms. This does not mean that they have used helms or been off the Rock before in their lives. There are a number of possible adventures on the Rock or beneath its surface. For more information on the Rock, see Appendix 4 of the *Concordance*.

Finally, the omnivorous DM may use SPELLJAMMER™ settings as a source of new ideas and source material. (The phrase "omnivorous DM" is not meant as a slam—the writer once described his own campaign as a "cosmic vacuum cleaner, sucking up every fantasy idea that crossed its path.") The races of the SPELLJAMMER campaign setting have little cause to visit the groundlings on a day-to-day basis, but their presence may make for interesting adventures. A case of introducing wheel locks into the Realms in Waterdeep is described on page 50 of this book. Other ideas may include acting as bodyguards for a member of the arcane doing business with a local chieftain, or stumbling upon an elven search party looking for a lost spelljamming helm in a flutter. The adventurers do not have to journey into space to benefit from the worlds of the SPELLJAMMER setting.

Getting There: Going Into Space

The first obstacle for any groundling characters is getting into space. The longstanding barrier to space travel in fantasy has been the fact that there is nothing up there, compared with the slews of dragonhordes and orcish legions on the ground.

However, once characters are made aware that space is yet another frontier, they will be looking for ways to get there.

Here are a number of ways to start groundlings on their way into space.

The Ancient Artifact: At the bottom of the haunted mines located near the heroes' current base of operations, or at the summit of the mad wizard's abandoned tower, there is a great vault with a domed ceiling. In the center of the vault is a huge ship (probably a tradesman or other less powerful ship, but for those who have never seen one before, it is large and impressive). The chamber is guarded by creatures suitable to challenge the adventurers, such as stone guardians or golems. The ship has an obvious throne (the spelljamming helm) mounted on the aft deck, along with whatever other treasures the DM would like to add.

The ship is too large to take out through the great doors, but a series of inlaid buttons mark the podium on the far wall of the room. At a touch of one of the buttons, the dome above opens, revealing a wide passage out into the sunlight. With a little experimentation, the player character seated on the throne can figure out how to operate it to control the ship. Note that learning to operate does involve learning finesse with the controls: the first attempt to rise out of the shaft will likely put the ship (and all those on board) out near the orbit of the moon before the actions can be reversed.

This option provides a fully operational ship for the players immediately. It is recommended if they, through their most recent adventures, had done something momentous, like save the world from a dark, evil power, and now are looking for new adventures.



Moving through space is no more than mentally visualizing the distance and direction (usually given by the navigator, based on his charts) that the ship should move and willing the ship to move in that direction. The feeling has been compared with moving a limb that has fallen asleep—a pins-and-needles sensation, though not as painful as its analog.

The helmsman is aware of the actions of others on the ship as if he stood on the aft deck (or similar location in other ships). The general movements of crew and officers do not register directly unless the spelljamming mage is paying attention.

When the ship encounters another object in space, the spelljammer is usually the first to detect it, but only because it causes the ship to slow down to avoid possible collision. The mage or priest can identify the other object in general terms: larger similar size,



The Ancient Artifact, Part 2: The setup is the same as before, within a "standard" dungeon setting. Instead of the ship, the heroes find the helm itself, which may be anything from a simple chair to an ornate throne. The chair radiates a very strong magical aura. The kind-hearted DM may provide a book or diary describing the use of the chair (useless in its present setting, secured to the floor). The less charitable will place the instructions for mounting and use elsewhere in the dungeon, or in another country entirely, and the truly cruel will provide no instructions whatsoever. In this case the heroes will likely have to find a sage conversant in such matters, and, once the object's purpose is known, keep it secret and out of the hands of others who would be interested.

The Scroll: An even nastier version of the above. The heroes find no helm and no ship, but only a scroll with three *create minor helm* spells and general instructions on how to use the result. The instructions will run to the tune of: "Find a suitable ship of no more than 50 tons, mount the chair desired to be the throne in its aft section, have a spell-user seated in the chair, and cast the spell to turn the chair into a helm."

Tonnage, of course, is in spacial tons, which are larger than naval tons, so a smaller ship will likely be used. Keep in mind the limitations of air and crew on the party. The "suitable ship" referred to in the scroll is a spacegoing ship, but unless the heroes have knowledge of space, they may try to use a riverboat or light cog.

This version will likely carry the individuals, overloaded, into space. It would be a nice idea if the Rock or a passing *real* space vessel were in the area before their air runs out.

The Sage: The heroes are hired by a sage to investigate travel in space. If the world the heroes are on

is already active in spelljamming, the sage may hire them to seek out the artifact or book mentioned in the above sections. Otherwise he will have the heroes test out a number of interesting ideas for getting into space, including:

- A chariot drawn by swans.

- A saddle on the back of a charmed dragon.

- A huge balloon.

- A brass sphere containing the morning dew. Since the dew rises toward the sun, the sphere will be taken with the dew toward the sun.

- Wings of flying*, used to a height never before attempted.

- A machine, built from old gnomish drawings, that mimics the birds themselves.

- A huge tower filled with smoke powder and ignited. The heroes are at the top of the tower within a *cube of force*. The blast shoots the heroes into space.

- A dimensional ladder that continually extends itself as you climb up it, the bottom rungs vanishing as other rungs appear above.

This being a fantastic world, all of the above methods work to a certain degree. They will take the heroes to the edges of the atmosphere of their planet, at least three miles up, far above the cloud cover.

The DM may then choose the next move for the heroes. If they continue on, they will have a long voyage to the nearest moon (say, 3-18 days, being kind). If their ship has insufficient tonnage to keep them alive, then they will experience the dangers of suffocation in space (*ioun stones* and *word of recall* spells help here). Should the ship be able to reach the nearest body, they should find inhabitants and adventures there as well.

The DM may also choose to give the heroes a glimpse of a spelljamming ship (or the *Spelljammer* itself) while they are in space, then force their return (the swans become con-

fused, the dragon reaches its limits of endurance, the dew escapes from the brass ball, or the magic runs out of gas). In this case, the heroes are encouraged to refine their methods (they have seen a large ship in space) and try again.

The DM may also choose to force an encounter with a ship, either a trader, pirate, or slaver. This opens other choices to the players, including delivery to the Rock, or being taken to another planet for sale.

The nature of the DM's choice depends on how deeply he wishes to bring the player characters into the SPELLJAMMER™ universe. This "first encounter" can potentially go in a number of directions: piracy, mutiny, escaped slaves, or just finding oneself on the Rock looking for a way to get home.

Aliens from Another Planet: The heroes are called upon by a local lord to investigate a series of disappearances in a distant part of his fief. The heroes discover that the disappearances are the result of neogi slavers making a landfall and taking on a batch of new slaves. The ship on the ground should be a neogi mindspider, with a deathspider in orbit above. The heroes may be captured by the evil neogi (a standard crew with personal umber hulk slaves) or defeat them and capture the mindspider.

If the heroes fail to defeat the neogi, they will find themselves in space involuntarily until they escape or are slain. If the heroes defeat the neogi, they must deal with several problems: figure out how to operate the mindspider (with either a lifejammer or a minor helm), defeat the deathspider up above, and then, defend themselves against the first ship that assumes the heroes to be evil neogi and attacks them.

The Envoy: The characters, renowned through their lands (or perhaps even the rulers of the land), are

summoned to court to investigate the claims of a strange trader. The trader is a tall, blue giant with a narrow face (an arcane), and is offering a magical throne in exchange for an extreme price (some artifact of power in the hands of the heroes, or which the heroes must go and fetch).

The magical throne is a minor helm, and the arcane is using it to see if this part of the world is civilized enough to open relationships with the spaceborne nations. If the Arcane is attacked, it will try to escape, and not return for a hundred years. A nice turn on this would be a rival wizard who would want the item for himself, so that he would slay the arcane and take the helm.

The Crash, Part 1: There is a meteor shower one night when the party is outside. During the shower, a particularly large meteor streaks overhead, trailing fire. It passes directly over the heroes, seems to detonate as part of the meteor blows off, then changes direction and crashes in the nearby mountains. The heroes may investigate if they choose.

The ship is a tradesman that came down with the storm. It is almost destroyed, its hull scattered over a mile-long line scarred into the mountain. The crew (what is left of them) is dead, but the spelljamming helm and a few weapons survived. It is up to the heroes to piece it together from here.

As an option for this version of the crash, there may be one lone survivor, who mutters something about "The Black Spot" before dying. The Black Spot is a local pirate who shot down the merchant in the first place, and if the heroes make it into space, he'll be after them as well.

The Crash, Part 2: Similar in setup to the crash, part 1, except that the ship is a beholder tyrant ship. Its orbis and most of the crew died in the crash, but five beholders and the

hive mother survived. Their mission—to get back into space, preferably on the backs of slave labor, and under the hive mother's directive, seek to carve out a kingdom to gain the resources. The beholders will go back to their normal nasty behavior if the hive mother is slain, and no longer seek to return to space. The heroes may get an inkling of space life from this adventure, or the beholders may have a prisoner, a mage capable of casting a *create minor helm* spell.

The Crash, Part 3: Similar to the crash, part 1, save that the crashed ship is an elven man-o-war. The crew and ship survived (mostly, but medical aid and repairs are needed). Evil forces are looking to kill the space elves and take the ship. The heroes will likely have similar ideas, though without the killing. In addition, a second man-o-war will appear in a few days to find the first, and to kill anyone that has found the helm on-board.

The Door: Lastly, the most simple way of getting characters into space in a hurry—a dungeon door (or trap, for that matter) that is a dimensional hole, which deposits the heroes in a distant sphere, under strange stars, in a place called the Rock, with no way home except to learn the customs of the natives and their strange boats.

Space Adventures

Once the heroes have gotten into space (by whatever means) with a decent vessel, the next step is figuring out what they're doing up there. There are a number of options, depending on the tendencies of the adventurers themselves.

Adventuring: This is generally described as "cruising around and seeing what attacks us." The DM should have some set-piece encounters for this type of group (treasure



or smaller. Long-time helmsmen can guess even from this what type of ship or object they are running near (an asteroid "feels" different from a dwarven ship). Visual sighting, either by the mage in his deck position or a crew member, is required.

The helmsman can maneuver the ship sluggishly, but any real maneuver—like a turn—takes the ship out of its rapid movement and down to tactical speed. In combat, the helmsman is limited by the feel of the hull and its capabilities, and cannot maneuver the ship above its capacity without magical aid. The crew provides the true maneuverability of the ship during tight turns and while evading enemy missiles.

Combat under the helm is a frightening, but usually nonlethal, prospect. The helmsman is aware of damage to the hull as bright flashes of



lairs, abandoned dwarven mines, etc.) and mix liberally with random encounters. Many of the descriptions within this book are intended as springboards for the DM to provide interesting adventures and encounters for the characters.

Trading: A subset of adventuring which usually involves getting Item A to Point B. Most items along this line are small and valuable, ranging from components needed to fill a wizard's requirements for a spell to precious gems and artifacts. In the last case, the patron must either be sure of the individual's honesty or very, very desperate to put a magical item of great power into the hands of the characters. Of course, in addition to encounters along the way, there may be other individuals who would want to intercept the heroes and relieve them of their items, which brings us to . . .

Pirating: A nasty word, so most individuals engaged in it call it freebooting or swashbuckling. Pirating is a common occupation for space crews, and there are as many cities based on pirating as there are on trade (they are made of the same coin, and a pirate one day may be a trader the next). The best of the pirates cut a swath across the stars, legendary heroes who are kind to the weak and dangerous to the strong. The worst are called marauders and reavers, and leave a trail of blood floating in the void. Both are hunted by whatever local authorities exist, but the reavers are shown no mercy.

A specialized pirate is a privateer, a free agent who serves space-based nations as a raider, choosing his targets from among the ships of that nation's enemies. In reality, the privateers are less concerned with such details, and a number have "accidentally" attacked friendly ships.

Local Navies and Military: These types of adventures tend to be boring in times of peace, deadly in times of

war. Every small city maintains a militia fleet charged with patrolling its orbit, aiding ships in distress, and repelling possible threats. The nature of these threats vary from city to city, but usually include neogi deathspiders, reavers, and known pirates.

War is a common occurrence in space, and with indiscriminate fire, soon brings a large number of factions into play. Typical warlike missions include patrol, search and destroy for enemy ships, spying missions, and all-out assaults. Cities war among themselves for trade or to right grievances, trading costers battle for patrons and routes, and various races are involved in continual running battles (the beholders, for example, hire both military and privateers among humans to fight other beholders).

Exploration: For all the years that men have sailed the void and cruised the phlogiston, there is a great deal that men do not know about their universe. Fantasy space is a universe not of theorists and scientists but of explorers and adventurers, whose solution to test out what is beyond a shell is to journey there and find out. The Seekers are excellent patrons for these types of adventures, since they will willingly finance exploration into new areas to receive detailed maps of new lands.

Intrigue: A sneakier sort of adventuring, suitable to rogues and those who prefer the (relative) safety of the cities. The various factions and races of space continually tilt against each other for dominion: Seekers against Xenos, military brotherhoods against each other, wizards against competitors, and the neogi against all. The long distances and relative lack of information make spies and scouts very valuable in space.

Life on Other Planets

Many of the fantasy worlds share similar creatures, species, and types of government. A native of Water-deep would not be totally lost in Greyhawk, and an elf from Silvanesti could fit in at the elven courts of Evermeet. Other planets do not necessarily share those same similarities, and the DM may create worlds to fit his fancy and the needs of his adventures.

Types of Worlds and Their Life Forms

The easiest method of populating other worlds, short of creating all-new monsters for every possible planet and terrain, is to use already existing creatures in different situations. Certain types of planets are more amenable to specific types of creatures than others (fish do not survive well on fire-worlds, for example).

Given the choice of weighing the DM down with yet more monsters, some of which would be variants on existing types, the DM may choose to use the following tricks to make his worlds look and feel different, and to give the heroes unexpected monsters and encounters.

Monsters by World Type

Following are general examples of typical inhabitants of the various world types (the four elemental types, discounting for the moment the "fifth" element used by the Karatur characters).

Earth-Type worlds have a diverse selection along the lines set out in the *Monstrous Compendiums*, and in the *Monster Manuals* and FIEND FOLIO™ tome that preceded them. In fact, many of the monsters in those previous texts will never see the light of day in the *Compendiums*, and as such could be used on alien worlds. (Then again, who wants to admit that

his paladin was eaten by a flail snail in a distant crystal shell?)

Fire-Type worlds tend to have fire elemental based creatures, such as the salamander, efreet, and azer, but also fire-based analogs of existing creatures (such as a fire-based bear). These analogs have the same appearance, hit dice, and attacks as their regular versions, but in addition are made of elemental fire, plasma, molten rock, and other materials. As a rule of thumb, these creatures will have the following special abilities:

They inflict 1-6 additional hit points in fire damage to normal damage for every Size class. (Size S = 1d6, Size M = 2d6, Size L = 3d6, Size H = 4d6, and Size H = 5d6.)

They are more vulnerable to cold, suffering double damage from cold attacks. They are vulnerable even to the cold that we consider comfortable temperatures, taking 1d6 points of damage for each round of exposure to these chill temperatures, eventually burning out or fusing into a lump of inanimate rock.

Water-Type worlds have a rich diversity of aquatic life. All fish, whales, and water-breathers are possible on water-type worlds, including mermen, sahuagin, sea elves, and locathah. The DM may double the size and hit dice of these creatures, as they are perfectly adapted for their worlds (creating mergiants from mermen, for example). DMs may also take creatures who are normally air-breathers and create an aquatic version (such as a water-breathing beholder, which unlike the eye of the deep retains use of its eyes). On those islands that break the surface of the water, earth-type life will also be found.

Air-Type worlds specialize in fliers. Dragons, djinn, aaracokra, and other winged creatures will be common. The DM may double the hit dice and size of these creatures to

represent their adaptive nature to a world without a surface, and the fliers here never need tire or land. The DM may also modify existing creatures for flight (the airboar, for example, which has batlike wings). These creatures will have a speed equal to their earthly analog's ground speed doubled, and have a maneuverability class of either C or D (50% chance for either).

Monster Appearance

One of the great advantages for AD&D® game players is that once the basic monsters are known and committed to memory, they are an open book for the players. Their weaknesses and vulnerabilities are well known enough that a prepared party can take on most monsters with special vulnerabilities. This is particularly true of monsters specialized to a point where a single type of attack will drive them off or slay them.

This situation makes sense on most home planets, where the heroes have at least a passing familiarity with tales of rakshasa and water weirds and other creatures. But in the new lands opened by space, this is not always the case. A hero should not be always able to identify a monster from his home campaign, and have the same tricks work in every case.

One way of dealing with this problem (short of new monsters, which are nice if there is time) is to change the appearance of the monsters. All abilities, hit dice, and raw stats remain the same, but the creature, if humanoid, takes on a nonhumanoid appearance; if it is normally reddish in hue and looks like a cow, it is now blue and looks like a giant fox.

An example from the writer's own campaign: The grimlock from the FIEND FOLIO tome is a creature that will likely not reappear in the *Monstrous Compendium*. These creatures



pain, but can easily maintain control. In certain circumstances (a critical hit), the pain can knock the helmsman out, slowing the ship to a stop.

Many helmsmen have described the sensation of being merged with the ship, likening it to the feeling of personally flying among the stars. Sometimes they have a tendency to look down on warriors, rogues, and others as mere passengers in the marvelous ship that the mage or priest has become.



appear as grey-skinned humanoids with sharp teeth and blank eyes, and are particularly vulnerable to *audible glamor* spells while being invulnerable to illusions. Most of my players knew this description and brought out the needed spells when they appeared. They traveled to another world and found more grimlocks, but this time I changed them *in appearance only* to resemble land-walking squids with weapons in their tentacles. Confronted with the "land-squids," the players fought as if they were encountering the beasts for the first time (which they were), all the while trying to figure out why I was reading from the FIEND FOLIO™ tome.

Changes in appearance can be minor (blue elves) or major (giants with mind flayer heads but none of their psychic abilities). The limitations of the appearances are up to the DM, though he should note them in sidebar if the heroes ever come back looking for the "Land-squids unaffected by illusions." Examples of changes of appearance are:

- Change in color (blue elves)
- Change in flesh type (scaly humans)
- Appears as a related creature
- Appears as a creature of a different species
- Appears with the head of a different creature (dragon, horse, etc.)
- Is translucent or faded, but still visible (no penalties to hit)

Change in Monster Statistics

A more involved modification is to change one or more of the statistics of the monster to reflect its appearance in a new environment. This is more chancy than just changing the monster's appearance, as it can affect game play severely, often creating unkillable creatures or those that the players may use to their advantage.

Here are some general changes to monsters that can preserve their freshness, and limitations to those changes.

No. Appearing: Never more than double or less than half.

Armor Class: Raise or lower by only 1 point.

Movement: Double speed at best.

Hit Die: Double at best, plus give the players a clue by increasing size.

Number of Attacks: Double, but never more than four per round.

Damage/Attack: Leave as for normal monster.

Size: See under Hit Die above.

In general, alter special attacks, special defenses, and in particular magic resistance at your own risk. When modifying such special abilities, try to trade for an equal or weaker special ability. For example, a creature that can only be hit by silver may be altered to one that can only be hit by cold iron, but not to one that could only be hit by magical weapons. The first case would surprise and hamper the character, while the second would give too great an advantage to the monster. Further, a monster that was more resistant to certain attacks would eventually force out his normal cousins and become the dominant type of creature.

An example of a modified special attack is our beholder/bartender on the Rock of Bral. The death-ray eye is disabled, and replaced with one that projects a *detect lie* spell. The result is a more socially oriented monster, who can survive better in a city since most patrons know they will not be knocked dead (of course, he retains his disintegration ability with another eye).

Landfall! Arriving at Planets

Fantasy worlds are large entities in themselves, and are often developed as the players move through them. In ground-based campaigns, the DM can often stay one jump ahead of the players—if they move toward the “impassable” mountains at the edge of the map, the DM has a chance to build more world before they arrive.

In fantasy space, this problem for DMs is intensified in that the players have more mobility. They can effectively land anywhere on a planetary surface, which seems to require that entire planets need to be created wholesale before the play can proceed.

Such is not the case. Most campaign worlds are not full globes, and are developed over time. The “other side of the world” tends to stay vague and with large areas of similar terrain until the heroes arrive there.

As a rule of thumb, when adventurers land on a planet, they will come down where the DM says they come down. If the far side of Toril does not exist as yet, they cannot land there.

This sounds a little harsh, but taken as a group rule, makes sense. If the DM has plans and adventures set around the fantasy equivalent of New York, it makes little sense to land the heroes in Istanbul and expect them to make the long march. Adventures tend to happen near adventurers—when the space barbarians land on the deserted planet with the ruins of an ancient race, said ruins are usually within walking distance. This is a convention used regularly in fiction and may be used here as well.

The exception to this is when the heroes know where they are going. A native of Krynn, for example, landing in the Realms for the first time may be placed by the DM as he sees fit (preferably with an eye toward ad-

venture and within the wishes of the player—if they ask to land somewhere fairly removed from civilization, having them come down in Waterdeep is not a good idea). A native of the Realms can likely identify his homeland from space, and as such be able to set down pretty much as he sees fit.

When landing, the DM should check the weather, according to the *Concordance*. Strong winds or rains may reduce the chance of landing safely. The characters may choose another landing area, choose to brave the storm (with attendant possible damage) or simply wait out the storm in space. This last would involve additional possible encounters while waiting for the clouds to clear.

When Space Meets Ground

One of the key rules to keep in mind when introducing the SPELL-JAMMER™ setting to established fantasy campaigns is that they are very much separate worlds, and one should not outweigh or overwhelm the other.

Civilizations in space consider themselves superior to the swarming groundlings, and most of their citizens do not worry about the state of the Realms or the Dragonlance Wars—in a huge galaxy of myriad spheres, it simply doesn't matter to them. They have their own provincialism, dealing with shipping and pirates. Their subjects of discussion are neogi incursions and beholder civil wars, two subjects that would leave a groundling listener believing he was in the company of professional liars. The demands of their space are different from the demands of “the ones below,” and as such the two do not mix.

This is not to say that they do not know of each other's existence; simply, that matters not. Groundling nations hear tales of space armadas and translate them into the equiva-

lent fleets, not understanding fully the difference in cost and potency. The powerful and the adventurous in both worlds know of each other, and often try to link the two worlds. Wizards in particular are very interested in the differences between the spacers and the groundlings.

In the Realms, for example, Khelben of Waterdeep and Elminster of Shadowdale are both powerful wizards. They know of the spelljammers and the ships that regularly ply the skies over their heads. Khelben has an active interest, while Elminster prefers dimensional travel as quicker and easier, and has less to do with such matters. The Lord of Waterdeep is aware of space craft, but only listens to what Khelben has to say about it when a strange ship docks in the harbor with odd and unusual items. The Lord of Shadowdale, who runs a much smaller community, knows nothing of spelljammers and space civilizations, since he is concerned with invading troops from Zhentil Keep.

If inventions from space (such as wheel locks and smoke powder) threaten to overwhelm a ground-based campaign, the DM has full permission and encouragement to correct the situation. In Greyhawk, for example, smoke powder does not function, though if taken off-planet it regains its abilities.

The gap between groundling and space is both a state of reality and a state of mind. The groundling campaigns can run smoothly and effectively without interference from space, and the spaceborn legions can fight among themselves without worrying the nations of the various planets.

The reason? Simply put, because they lack a common ground.



Why Ships in Space?

The basic hulls of the spacefaring humanoid nations reveal their aquatic origins. The first human ships in space were modified seacraft, just as the first ships that most groundling adventurers take into space for the first time are galleons and caravels fitted with spelljamming helms. Such vessels are both easy to acquire and familiar to their crews.

But the nature of the helm does not limit sailing ships as the only types of ships to be found in space, as the dwarven flying mountain citadels and elven butterflies clearly show. Why then do men take ships into space?

The basic seafaring ship's shape and organization is ideal for spelljamming activities. The plane of gravity lies very low in the ship, in some cases almost on line with the keel itself. The ship



Definition of Terms

Name: Common name of the type of ship described.

Built By: Hull usually constructed by this race.

Used Primarily By: The major races that use this type of ship. Other races than those listed may use these ship types unless otherwise noted, but generally the users will be one of the types listed.

Tonnage: Tonnage of the ship determines hull points and amount of crew and passengers that may be safely carried.

Hull Points: Amount of damage the ship may take before breaking up.

Crew: The number before the slash is the number required to operate the ship at its optimum maneuverability class. The number following the slash is the maximum number of man-sized passengers and crew the ship can carry without straining its air envelope.

Maneuver Class: The rating for the ship's maneuverability. This affects the ship's ability to turn and evade in combat. A is the best rating, F the worst.

Landing: Whether the ship can land safely on land or water without crashing. This does not affect ships in orbit or using space docks. If a percentage is given, that is the chance the craft has of landing successfully.

Armor Rating: The strength of the ship's hull, given as a number similar to a character's Armor Class.

Saves As: Saving throw category used for the ship. See the table on p. 25 of *The Concordance of Arcane Space*.

Power Type: The form of spelljammer engine usually found with this type of ship. Replacement and alternate engines are common, but

in general, this type of engine is best suited for the ship.

Ship's Rating: The speed of the ship in combat. Ships that use major or minor *spelljamming helms* are noted as such, and have variable speeds according to the spellcaster manning the helm.

Standard Armament: The typical weaponry of the ship. More than any other feature, armament varies the most from ship to ship. These are standards, but individual owners customize their ships. The crew required to man typical weapons is noted, too. This is in addition to crew needed for ship maneuvering.

Cargo: Amount of space available for cargo, passengers, and other sundries, once the amounts required for weapons, crew, and the helm are taken. This space may be used for transporting cargo or given to other uses (like more weapons).

Keel Length: The length of the ship, stem to stern.

Beam Length: The width of the ship at its widest point.

Description: A general summary of the ship and its appearance.

Crew: A listing of the typical crew of the ship, along with the normal positions manned by its typical users. If a ship's owners usually have an organized chain of command, it is mentioned here. Location of the helm and bridge are often noted here as well.

Ship Uses: Some ships are better suited for specific tasks than others. This section lists the most common uses for the various types. While there are squid ship landers and mosquito battlewagons, they are rare when compared with the number of squid ship dreadnoughts and mosquito landers.

Other Configurations: This section lists the common alternatives

for the various ship types, such as more armor, more maneuverability, modifications for particular races or special tasks. The DM is free to throw these alternate versions at the players to keep them on their toes. Merely switching one weapon type for another is not listed in the section, unless the change affects a large percentage of ships in common usage.

This section also outlines how the various races that commonly use a particular ship modify it for their own ends.

In the descriptions that follow, ships are presented in order of tonnage from lightest to heaviest.

FLITTER

Built By:	Elves
Used Primarily By:	Elves
Tonnage:	1 ton
Hull Points:	1
Crew:	1
Maneuver Class:	B
Landing—Land:	Yes
Landing—Water:	Yes
Armor Rating:	8
Saves As:	Ceramic
Power Type:	Major or minor helm
Ship's Rating:	As for helmsman
Standard Armament:	None
Cargo:	1/2 ton
Keel Length:	20'
Beam Length:	5'

Description

The flitter is the smallest standard ship in fantasy space and has little more than a modified *spelljammer helm* tucked within its small butterfly shape. It carries a single passenger/captain/helmsman, who sits just ahead of the wings. The flitter is not recommended for long trips, given its small size and delicate construction. Traveling in a flitter has been compared to riding a tireless horse

for several days—you get where you're going, but not very comfortably.

The flitter has insufficient interior space for anything but personal items in its tiny cargo hold. The ship is too small to carry any large weaponry. The flitter is really nothing more than an extension of the user's own form.

Ship Uses

Messenger: In its spelljamming configuration, the flitter is best at carrying light goods over short interstellar distances. The lightest good to carry is information, so the flitter often serves as a messenger between elven fleets separated by the void or in different spheres entirely. Such missions are dangerous for these messengers, called in their tongue "lone riders."

Scout: Similarly, the flitter is an excellent reconnaissance and espionage ship, capable of slipping into small areas and making planetfall. Heading for the nearest large solar body is a favorite tactic for the "lone rider" seeking to escape from dangerous pursuers.

Landing Craft: Sometimes owners strip the spelljamming engine out of a flitter and replace it with a more conventional engine. In this configuration, the flitter is useless for interplanetary voyages, but suitable for short hops into and out of the atmosphere or between ships. The elven navy follows a strict policy of only allowing ships without helms to make planetfall, so this use of flitters as landing craft is very common.

Small Fighters: Another place for a flitter lacking a *spelljammer helm* is in close combat with enemy ships.

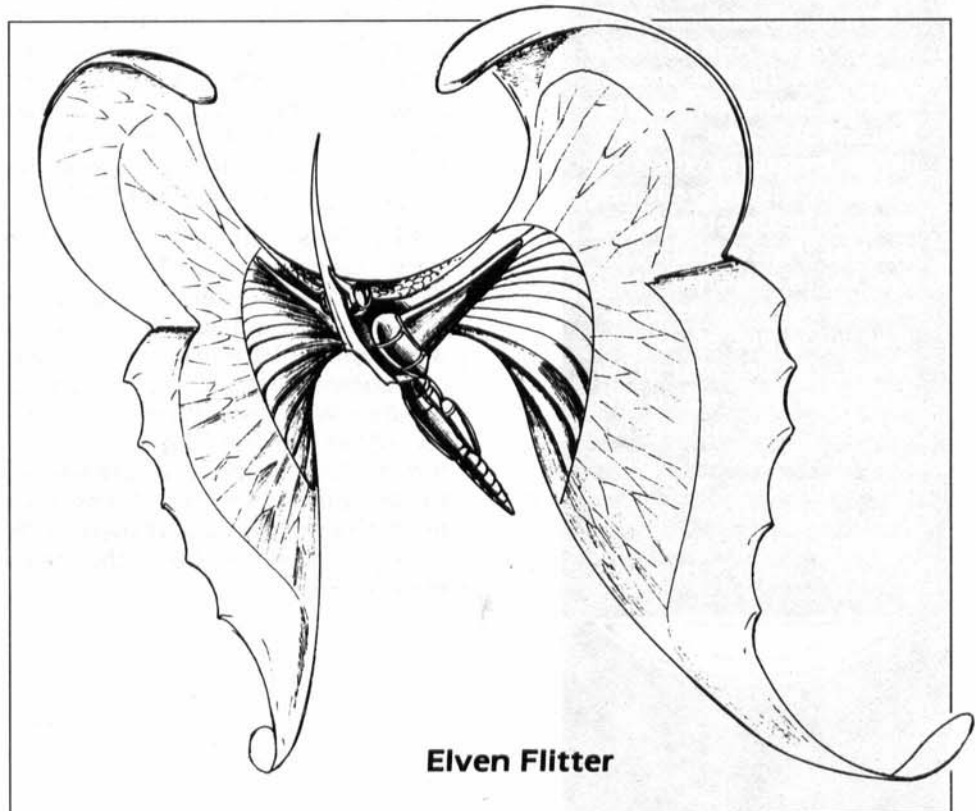

Elven Flitter



is portable and made to stand up under pressures from several directions. Its layout, with a limited crew under the command of a captain and his officers, makes it easy to handle in space. Even the rigging, oars, and other deck furniture onboard aids in maneuvering the ship. Finally, the standard sizes of ships fits with the tonnage requirements of the spelljamming helms.

Other objects can and have been taken into space, including monuments, boulders, several pyramids, and a few large creatures such as dragons. Living creatures seem to be upset by being used as ships and they often try to return to their homes as soon as possible, going out of control if not. Castles and other buildings secured to the ground will not move unless released from their moorings, and then they experience severe problems as the plane of gravity moves through



Large elven dreadnoughts of the armada class (see below) carry a number of depowered flitters. While these ships cannot manage interplanetary flight, they are capable of attacking enemy ships. Controls are set into the seat of the flitter, and the ships are manned by archers or mages, who soften up a target before the main attack.

Other Configurations

Depowered Versions: Used as landing craft and small fighters as noted, these flitters have their *spelljammer helms* removed and replaced with simpler, more conventional engines. The common elven engines used for these craft have a movement on the tactical map of 2 spaces per round.

Wild Flitters: There are a number of abandoned flitters littering the cosmos, the remains of failed missions, undelivered messages, and old battles. Such craft are seriously overgrown, their wings curled in on themselves like seashells. Such ships may have workable engines within, and are MC E and AR 9 until trimmed back. Repair costs are equivalent to refitting half the hull.

Firewinds: This type of depowered flitter has not been used by the elven fleet since the Unhuman Wars. The firewind is a suicide craft, loaded with flammables and piloted to crash on enemy decks. Used against wooden ships, each flitter has the effect of two hits from a greek fire projector. The firewind pilots are trained to bail out if possible. Elves even used charmed orcs and men to fly the ships near the end of the Unhuman War.

MOSQUITO

Built By:	Humans
Used Primarily By:	All races
Tonnage:	6 tons
Hull Points:	6
Crew:	1/6
Maneuver Class:	C
Landing—Land:	Yes
Landing—Water:	Yes
Armor Rating:	5
Saves As:	Thin wood
Power Type:	Major or minor helm
Ship's Rating:	As for helmsman
Standard Armament:	None
Cargo:	3 tons
Keel Length:	100'
Beam Length:	15'

Description

The mosquito, along with the elven flitter, is among the smallest *spelljammer helm*-carrying ships in common use in fantasy space. The mosquito is used as a shuttle, landing craft, spy ship, and infiltrator. Its small size makes it unsuitable in combat (one good hit from a heavy weapon can usually knock it out).

Crew

The mosquito can be run at full rigging by a single man, making it prized as a personal star-traveler. The low maximum capacity of the ship makes it suitable only for small parties, or for short trips, where the ever-stifling air will not pose a serious problem.

Ship Uses

Landing Craft: Most mosquitoes are carried on larger ships and used as shuttles or landing craft for individual crew members. They are also used occasionally as rescue craft and alternate lifeboats. Often the *spelljammer helms* are stripped out of mosquito landing craft, as that is the most expensive part of the vehicle.

Spy Ship/Infiltrator: The mosquito is not made to stand up in a fight, but makes a great stealth ship. Mosquitoes can be easily modified and made harder to detect, making them prime candidates for spy ship duty.

Space Hulk/Bomb: In sections of space with longstanding wars, mosquitoes are often stripped of their helms and cast adrift after being filled to the brim with greek fire canisters and other flammables. The hope is that such space hulks will fall into the gravity planes of large enemy ships and crash, setting them on fire. Often swarms of these flammable mosquitoes are left in orbit around enemy planets.

Other Configurations

Gnat: A stripped-down version of the mosquito, the gnat is one of the most maneuverable ships in space. Its armor rating is 8, but maneuverability climbs to B. The gnat is often used as a shuttle in high-combat zones.

Stinger: In this configuration, the mosquito's cargo section is filled with weaponry—a ballista, catapult, or jettison, according to the tastes of the user.

Domed Deck: This enclosed version of the mosquito (or, occasionally, the gnat) has a dome covering the upper deck. The domed mosquito is used by mind flayers and other beings sensitive to light. The dome does not change the AR or saving throws of the craft, but prevents those on the upper deck from being attacked freely.

CARAVEL

Built By:	Groundling humans
Used Primarily By:	Groundling humans
Tonnage:	10 tons
Hull Points:	10
Crew:	8/10
Maneuver Class:	F
Landing—Land:	No
Landing—Water:	Yes
Armor Rating:	9
Saves As:	Thick wood
Power Type:	Major or minor helm
Ship's Rating:	As for helmsman
Standard Armament:	1 medium ballista
	Crew: 2
Cargo:	5 tons
Keel Length:	70'
Beam Length:	20'

Description

Unfortunately, the most common form of first-time ship an adventurer is likely to own is something along the lines of the caravel. This ship is a cheap vessel with low armor rating and maneuverability, little capacity to maintain a crew above the listed minimums, and woefully inadequate weaponry. This is the type of ship created by adventurers who find a *spelljammer helm* in the ruins of an ancient civilization.

If such an adventuring team survives their first adventure into space and discovers other civilizations with better, more refined ships, they quickly junk the caravel for at least a tradesman. As a result, coasters, caravels, biremes, and the like are often abandoned by their owners, who wise up and leave them propped on the side of an asteroid base as a source of lumber and scrap.

Mosquito

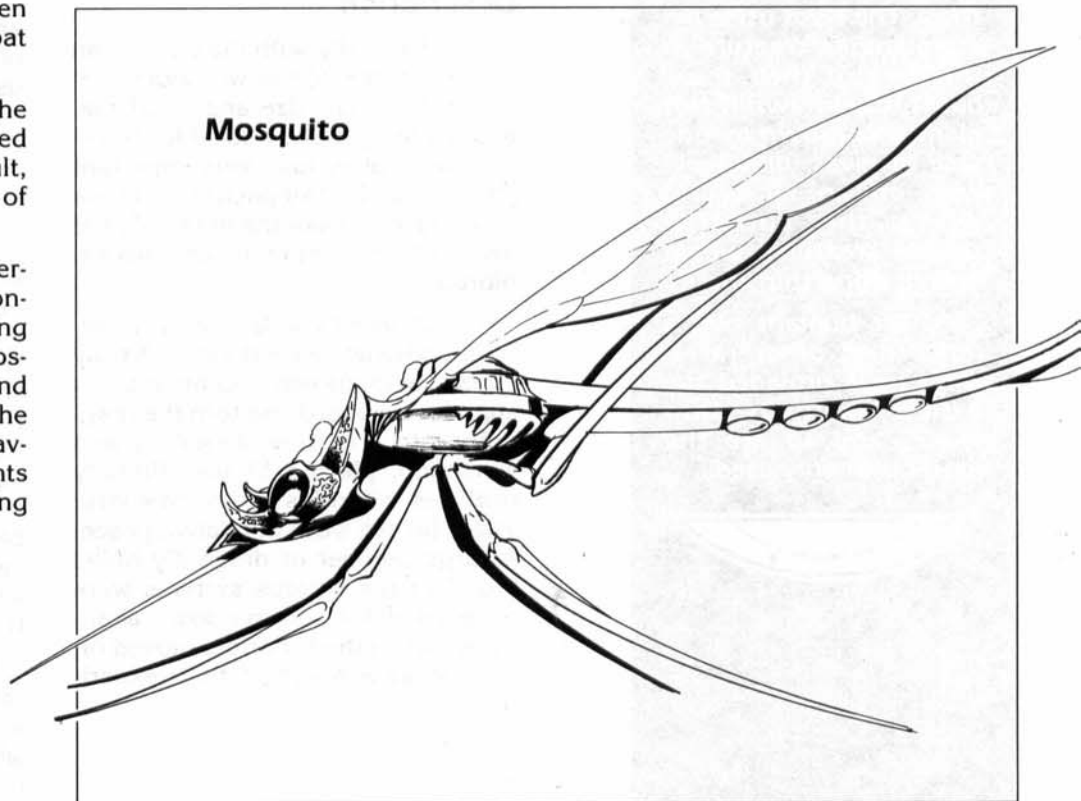



the building. Walls that carry forces in one direction now must carry them in opposite directions, which in turn causes some to crumble, which in turn shifts the plane of gravity further upward until eventually the entire structure collapses.

The dwarves rely on the solidity of their mountain ships, but even they do not land with them. The elves use a living plantlike creature as the base of their ships, but it is unknown if this plant was grown by one race of elves, or discovered on an air world where the butterfly-shaped creatures would evolve along ship lines.

As for humans and a number of other races, ships have provided the easiest methods into space, and so are the most commonly used.



DRAGONFLY

Built By: Humans
Used Primarily By: Humans, elves
Tonnage: 10 tons
Hull Points: 10
Crew: 3/10
Maneuver Class: C
Landing—Land: Yes
Landing—Water: No
Armor Rating: 8
Saves As: Thin wood
Power Type: Major or minor helm

Ship's Rating: As for helmsman

Standard Armament:

1 light ballista
 Crew: 1
 OR
 1 light catapult
 Crew: 1

Cargo: 5 tons
Keel Length: 100'
Beam Length: 20'

Description

The dragonfly, with the tradesman (below) is one of the workhorses of space. Its small size and good maneuverability make it ideal for transporting small groups, very important persons, and small packages. These features also make the dragonfly the ideal ship for smuggling and fast exploration.

The dragonfly also is highly recommended as a wizard's ship. A truly antisocial mage can load most of his supplies on board and turn the dragonfly into a mobile laboratory and workshop, placing himself literally millions of miles from nowhere. There he can work in relative peace. A large number of dragonfly hulks found in the various systems were once used for this purpose, abandoned when their masters moved on or died as a result of their experiments.

Crew

The dragonfly is capable of being handled (badly) by a single man, but operates best with a three-man crew, not including any men required for the *spelljammer helm*. The captain is usually the navigator and the quartermaster. The first officer generally doubles as the helmsman and the cook.

Ship Uses

Smuggling: The "light package" trade is a favorable one for spacefarers. Those who wish to send items such as magic tomes, artifacts, or magical items to other planets or spheres without passing through the various planes of existence find black-market traders very helpful—for a sizable price. Smuggling ships are often stripped for maneuverability and powered by a high-level cleric or wizard for speed.

The stripped-down dragonfly has an improved maneuverability class of B, but its AR is only 9. This version usually uses a furnace as its spelljamming device, and requires that the agents employing the smuggler provide sufficient magic to power it.

Free Adventuring: The dragonfly is a handy small exploration ship for adventurers who are looking to land on a planet, scout around, and leave at will. "Leave at will" is a big part of the dragonfly's desirability; the ship's relatively small size and landing ability make it the ship of choice for such situations. Its chief disadvantage is also its size, which prevents it from being used to haul large objects into space. The crew of an adventuring ship will vary greatly, but will always include a mage or priest to man the helm.

Wizard's Ship: Such ships are normally gutted and redesigned from within to suit the needs of the wizard, who operates the ship alone or with a few trusted retainers, familiars, and/

or magical creations. Wizards who do not venture into the phlogiston will often open extradimensional holes from their ship in order to provide more storage space. (In the Flow, the storage space will disappear and can't be opened until the ship reaches another crystal sphere.) A wizard's ship usually carries no heavy armaments, as the wizard himself is often the most dangerous weapon on board.

Ship's Boat: A dragonfly can be gutted of its *spelljammer helm* (the most expensive part of a ship) and used as a "ship's boat" for a larger craft in making planetary landings. The dragonfly retains its hull and maneuverability characteristics, but has a nonmagical engine as its power source. Such ships sometimes retain their *spelljammer helms* and are used as scouts or light fighters.

Other Configurations

This version of the dragonfly is used by some humans in desperate naval actions. The firefly is nothing more than a large bomb. The ship's light catapult is replaced with either a bombard or a greek fire projector and stuffed to the gills with ammunition. The idea is for the spelljamming mage or priest to drive it into the heart of an enemy armada and detonate it by crashing into a larger ship. The mage is sometimes provided with a lifeboat or dimensional escape device.

Heavy Dragonfly: Occasionally, more armor is added to the dragonfly, improving the AR to 7 and reducing its MC to D. Most individuals seeking a better protected ship look at the superior damselfly class instead of modifying a dragonfly.

DAMSEFLY

Built By: Humans
Used Primarily By: Humans
Tonnage: 10 tons
Hull Points: 10
Crew: 2/10
Maneuver Class: D
Landing—Land: Yes
Landing—Water: No
Armor Rating: 4

Saves As: Metal
Power Type: Major or minor helm
Ship's Rating: As for helmsman
Standard Armament: 1 heavy weapon
Cargo: 5 tons
Keel Length: 100'
Beam Length: 20'

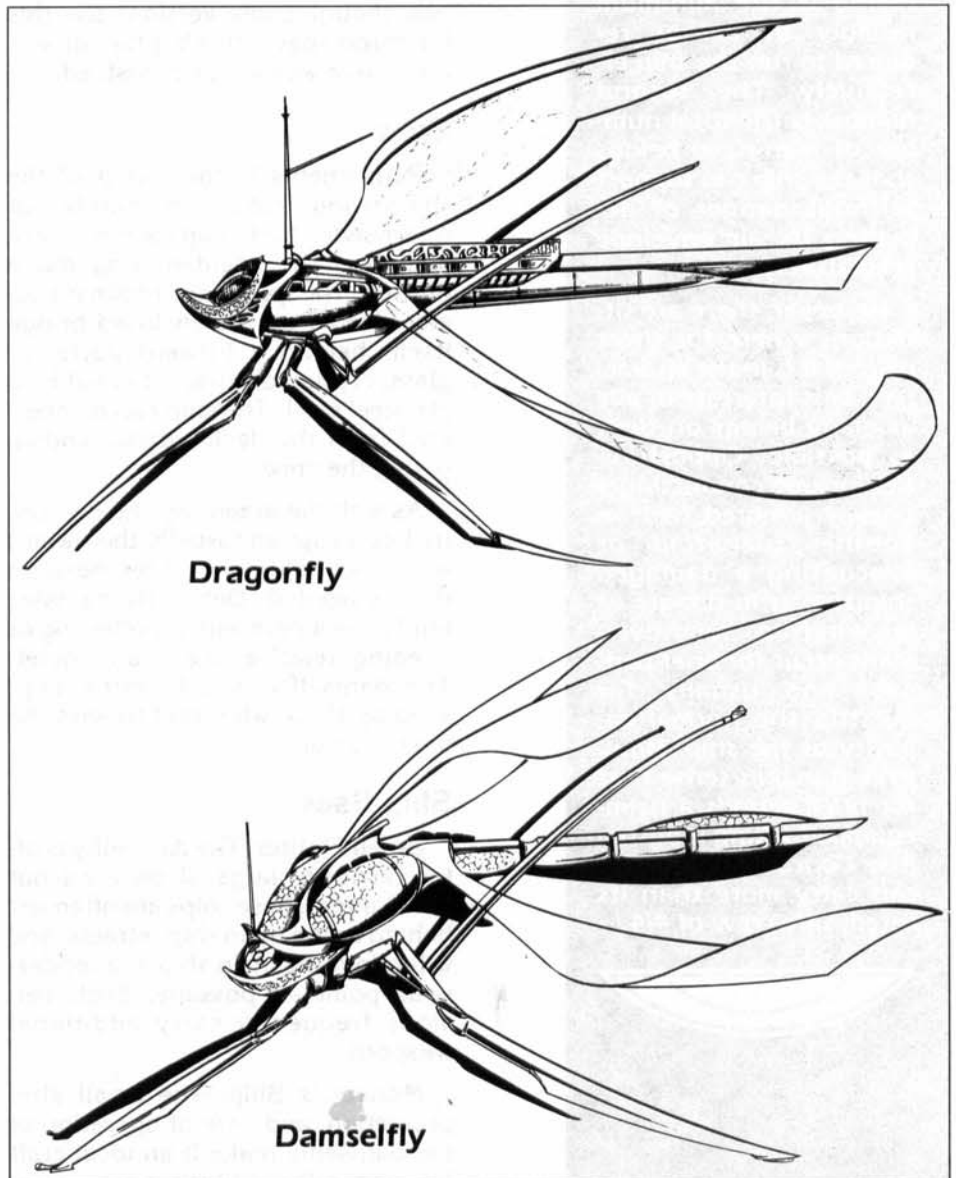



Packing Them In

The first number listed under a ship's "crew" rating is the minimum number of beings required to run the ship effectively. The second number is the total number of man-sized beings that the ship can support without danger of depleting its air envelope prematurely.

However, there are situations where for short periods it is in the characters' best interests to pile as many beings on deck as possible. Opportunities include conducting a heavily armored raid on another planetoid or evacuating a damaged ship that is in danger of breaking up. Such overloads occur for brief periods, and usually far outstrip the normal capacity of the ship. However, it makes sense that for brief periods a helm-equipped viking longship (the *Concordance*, p. 29) can carry more than its listed, safe crew of 4/4.



Description

A second-generation version of the standard dragonfly, the damselfly has the same general configuration as the dragonfly, but has been totally redesigned along its main body. The thin wood has been replaced with metal and other, harder substances, and all exposed decks have been covered. A sliding hatch just behind the wings is used for the single heavy weapon the damselfly has, though some versions use this for cargo space, turning the aft section into a weapon deck instead.

Crew

Refinements in the layout of the ship's wings reduce the number of men needed for full operation to two, including the spelljamming mage himself. The *spelljammer helm* is usually located on the enclosed bridge itself, behind a forward portal of glass, crystal, or metal affected by a *glassteel* spell. The ship can be operated from the deck without endangering the crew.

As with the dragonfly, the damselfly has a captain (usually the owner) who also holds any other position that is needed. Damselfly captains tend to be loners, either preferring or needing relative peace and quiet. The damselfly is a hermit's ship, used by those who want to shut the universe out.

Ship Uses

Small Fighter: The damselfly is often carried by larger ships as a scout and fighter. These ships are often left behind as the main ship retreats, and will rejoin the main ship at a rendezvous point—if possible. Such versions frequently carry additional weapons.

Monster's Ship: The small size, protection, and ease of operation of the damselfly make it an ideal craft for generally solitary, nasty crea-

tures. The fact that a casual observer cannot tell if the ship carries a wizard, lich, or rakshasa provides a level of comfort for the user.

Smuggling: Like the dragonfly, the damselfly is used extensively in the "small package trade," particularly in locations where open warfare is common and/or the local authorities have the power to back up a blockade. Damselfly captains rarely take on passengers (see the above notes on personality of such captains), but may be induced to do so for a high price.

Ship's Boats: As the dragonfly, the damselfly often has its expensive *spelljammer helms* stripped and replaced with nonmagical engines, turning the ship into a planetary scout or shuttle. Such shuttles are useful for zipping about a planet's surface, but are useless for interplanetary travel since their air will run out long before they reach a destination.

Other Configurations

Alternate Weapons: The damselfly's main weapon is usually a heavy ballista stored behind a hatch located just aft of the wings. The hatch slides back for combat operations. Some damselflies have the ballista in the rear (normally cargo area). Some captains replace the ballista with a heavy jettison.

Additional Weapons: If the cargo space is eliminated, a damselfly often carries either a second ballista, a jettison, or a greek fire projector in the tail. Weapons mounted in the rear are called "stingers" regardless of their type.

Super-Heavy Damselfly: In the quest for still more protection, a modified super-heavy damselfly has appeared. Its armor rating is 3, among the best for ships its size, but its low maneuverability class (E) makes it hard to manage in a fight.

Alternate Shell: Enameled metal is the damselfly's common covering, often painted in bright colors that warn other ships away. Versions built by some space-based humans use bone, ceramics, or shells to the same effect. The armor rating remains the same, but the ship's saving throw is changed for the new material.

Mind Flayer Crews: The damselfly appears frequently in mind flayer formations as a scout or planetary landing craft. This fits in with the general preferences of the mind flayers for safe, secure ships. The damselfly is undergoing test flights with the mind flayers, and if the ship is deemed successful, it will be added to their fleets. Even if the craft fails the mind flayers' rigorous tests, the damselfly's successful design features will be added to those of the illithids' standard nautiloid craft (see below).

WASP

Built By:	Lizard men
Used Primarily By:	Lizard men, humans
Tonnage:	18 tons
Hull Points:	18
Crew:	8/18
Maneuver Class:	D
Landing—Land:	Yes
Landing—Water:	Yes*
Armor Rating:	6
Saves As:	Thick wood
Power Type:	Major or minor helm
Ship's Rating:	As for helmsman
Standard Armament:	
	1 heavy ballista
	Crew: 4
Cargo:	9 tons
Keel Length:	80'
Beam Length:	20'
	*Bee class only

Description

The wasp is a relative of the dragonfly, built to suit the lizard man's physique. It is one of the few vessels designed first and foremost with the lizard man in mind, but even as such looks slapdash and poorly engineered.

The lower decks of the central section are bowed outward and flooded for use by the lizard men and as a storage area for their pets. The raised hump on the wasp's back provides high ground for the ship's main weapon turret, usually a ballista.

Crew

Lizard men normally have a single tribal captain and a shaman responsible for the spelljamming engines (regardless of the type of engines). Beyond that, tasks are shared with-

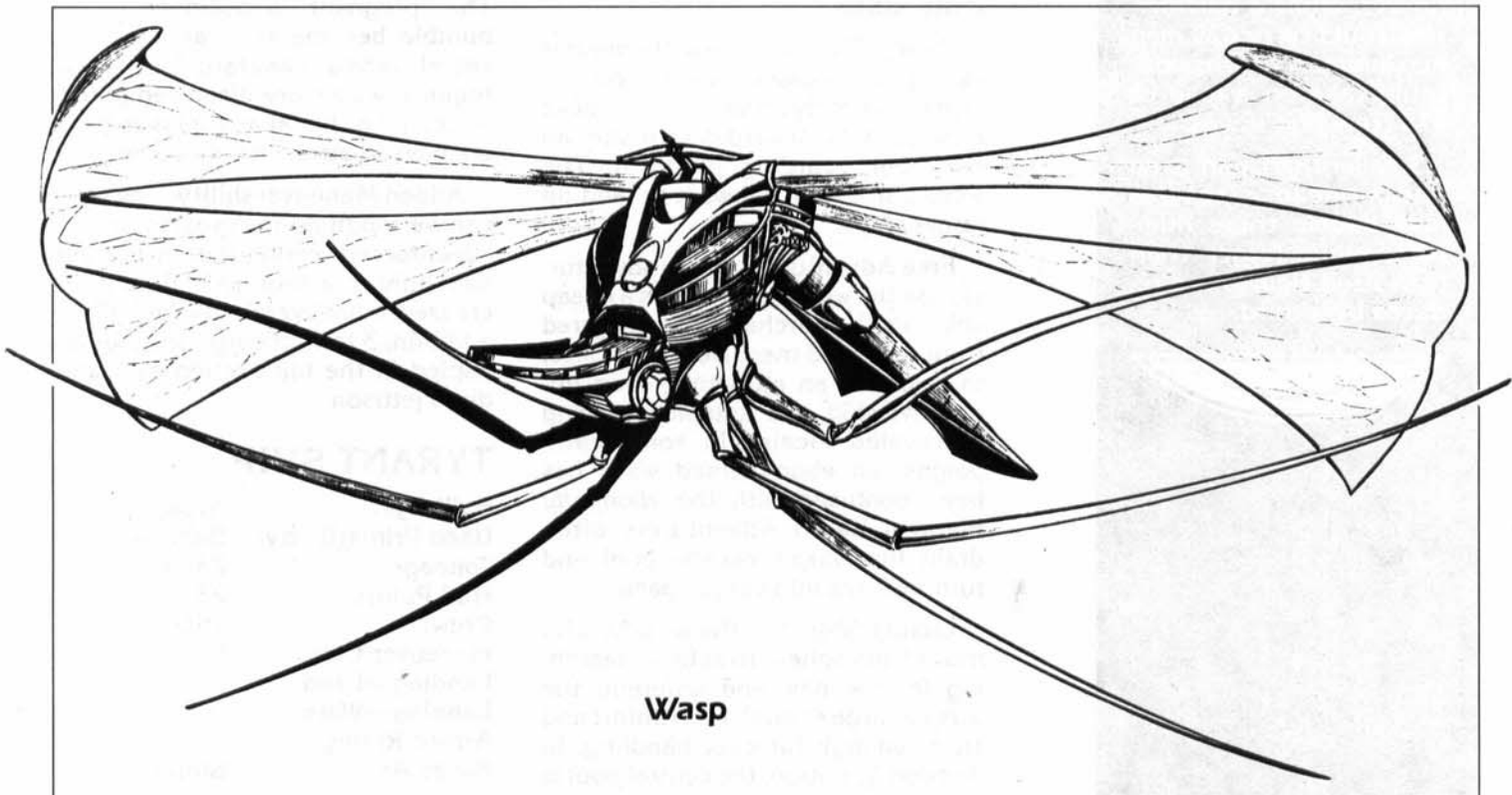

Wasp



To figure maximum capacity, multiply the beam length times the keel length and divide by 10. This is the total number of man-sized creatures that can be packed into the ship without damaging it. The viking longship mentioned above can carry 112 man-sized figures, while a hammer-ship could carry 625 men maximum. A deathspider could take on a load of 875 crew and slaves.

Smaller than man-sized and undead creatures may double these numbers, while larger than man-sized figures are reduced by a third.



out official positions. The weapons teams often consist of those lizard men closest to the turrets at the time of a battle.

The captain is usually positioned either on the foredeck or at the turret, where he leads by example. The *spelljammer helm* is usually found beneath the foredeck, which is where the navigation checks are kept. The crew's quarters are placed haphazardly throughout the ship; there are no official crew bunks on lizard man ships.

Many lizard man ships carry "crew mascots" in the flooded bulkhead. These mascots are often schools of fish, such as grouper and sharks, and are sometimes used to feed the lizard men (and provide a convenient method of disposing of unneeded prisoners). Some ships carry large creatures such as octopi, squid, or eyes of the deep.

Ship Uses

Piracy: The chief use of the wasp is as a pirate vessel, preying on unarmed or lightly armed ships. It lacks a ram, but its forward deck makes an excellent boarding platform. The wasp's size even allows it to land on larger ships.

Free Adventuring: Many adventurers use the wasp because it is a cheap ship, easily purchased or captured from the lizard men. Despite its size, the wasp is an attractive, even impressive ship, and suitable for awing untraveled locals. (In some campaigns, an ebon-painted wasp has been confused with the *ebony fly* magical item.) Adventurers often drain the wasp's central pool and turn the area into cargo space.

Luxury Ship: For the wealthy who move from sphere to sphere, searching for the new and different, the wasp is large enough for comfort and small enough for easy handling. In this configuration, the central pool is

drained and either used as the owner's quarters or as a banquet hall. The crew not directly involved with running the ship are usually pressed into service as cooks and the like. Some of the more magically oriented owners use undead, automatons, golems, or other non-air breathing beings as servants.

Other Configurations

The Bee Class: This variant is a purely deep space craft used in areas where lizard men have an established off-planet base. The wasp's landing gear is removed and replaced with two additional turrets, containing 2 more medium or heavy ballistas. The bee can land in water, but is usually used only in space.

The Bumble Bee: This configuration is a massive variant of the bee in which the legs are jettisoned and the hull itself deepened and widened to carry an additional 9 tons of cargo. The "pregnant" appearance of the bumble bee marks it as a trader's vessel—and an easy target. In certain regions, wasps are disguised (either by magic or by false fronts) as bumble bees to attract would-be targets.

Added Maneuverability: The wasp can be modified for evasion. In this "fleet-footed" configuration, the ship has lighter armor (AR 8) but increased maneuverability (MC C). In addition, 3 tons of cargo space is occupied in the tail section by a medium jettison.

TYRANT SHIP

Built By:	Arcane
Used Primarily By:	Beholders
Tonnage:	23 tons
Hull Points:	23
Crew:	15/23
Maneuver Class:	C
Landing—Land:	No
Landing—Water:	No
Armor Rating:	0
Saves As:	Stone

Power Type: Orbus
Ship's Rating: 1-6
Standard Armament: Special
Cargo: 11 tons
Keel Length: Varies
Beam Length: Varies

Description

The tyrant ships are the most diverse class of ships in fantasy space. They look like walnut shells, huge eyeballs, shells carried by squidlike tentacles—even huge beholders. The above stats apply to a “typical” tyrant ship, but there are commonly both larger and smaller tyrant ships in the spaceways.

The individuality of the tyrant ship reflects the individual nature of the

beholder races. While all beholders share the same basic form and abilities, the creatures’ genetic lines are plastic, such that small regional differences result in radically different-looking creatures. The trouble is that all beholders have their own ideal as far as perfection, and they consider all other species of their race mutants, suitable only for elimination from the gene pool.

Each tyrant ship reflects the individuality and racial paranoia of its master. Each ship also is a reflection of its owner’s subspecies. But all share the same basic structure: a concave “shell” indented with small pockets. These pockets are the resting place of the beholders, tentacles

down. At the center of the bowl usually rests the eye mother, surrounded by a number of orbi.

Beholder ships usually lack weapons, but make up for it with one of the most terrifying weapons in space: the combined force of a large number of beholders in a single place. A “beholder circuit” of common beholder, orbus, and a queen can provide a beam of magical energy about 400 yards (1 hex in tactical combat) in length and up to 100 yards across at the base.

This beam can do a number of things, based on the beholder’s natural magical ability:

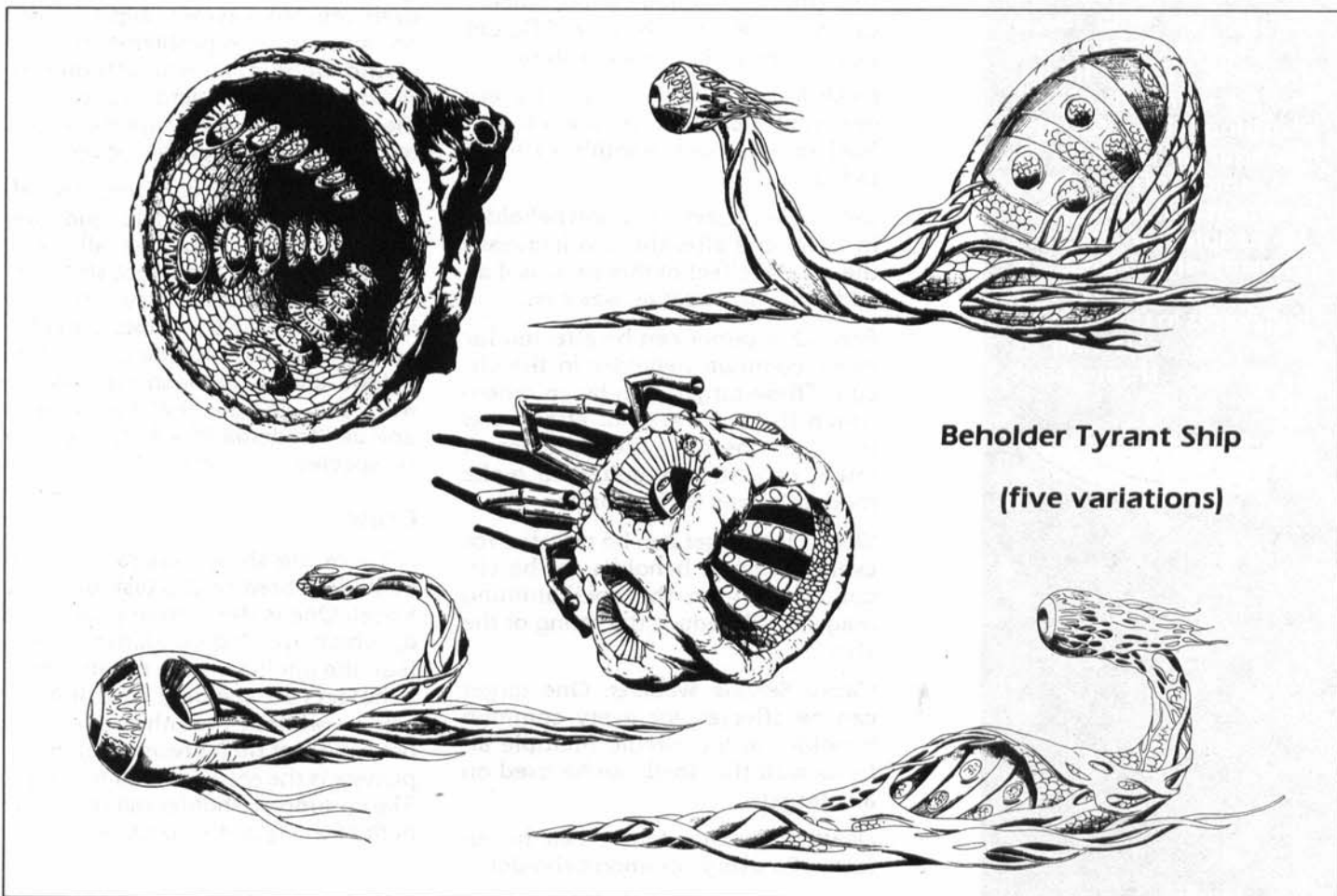

Beholder Tyrant Ship
 (five variations)



Approaching these limits means the ship is in an extreme situation. A point is reached where the physical presence of all these bodies begins to damage the ship itself. Each round that the ship exceeds these limits, make a saving throw vs. crushing blow for the material of the ship or the ship suffers 1d10 points of hull damage per 10 people (or fraction thereof) of overload. A ship that is reduced to 0 hull points in this fashion breaks up, scattering its passengers throughout space.



Charm Person: One target—if within range—per common beholder in the circuit. Targets do not need to be grouped together, though all must be within the area of effect. Any one target need only save once against this spell.

Charm Monster: As charm person.

Sleep: For each common beholder in the circuit, a target may be affected. The intensity or effect of the magical sleep is not increased, nor may one target be affected by multiple *sleep* spells.

Telekinesis: Add 250 lbs. to the normal spell's capacity for every additional common beholder in the circuit. As a rule of thumb, consider 250 lbs. about the weight of 1 ton of ship (this is a simplification, since 1 ton of stone ship is very different from 1 ton of thin wooden ship).

Flesh To Stone: One target for every common beholder in the circuit. Such targets must be within a 10-foot radius.

Disintegrate: Each common beholder in the circuit after the first increases the area of effect of this spell as if an additional *disintegrate* was cast.

Fear: One target can be affected for every common beholder in the circuit. These targets can be anywhere within the eye's area of effect, and may be chosen by the beholder. A target cannot be required to make more than one saving throw.

Slow: One target can be affected for every common beholder in the circuit. If cast on the spelljamming mage, it will reduce the rating of the ship.

Cause Serious Wounds: One target can be affected for every common beholder in the circuit. Multiple attacks with this spell can be used on any target.

Death Ray: One target can be affected for every common beholder in

the circuit, but all such targets must be within a 10-foot radius.

Anti-Magic Ray: The most deadly of the beholder's arsenal of attacks in space, this ray affects everything within the target area. Should it strike the *spelljammer helm*, it will shut it down, rendering the ship helpless. A ship's upper decks usually provide adequate cover from this ray, but used in conjunction with the *disintegrate*, the ray can easily and quickly immobilize an opponent. Note that the *anti-magic ray* can work against other *anti-magic rays* as well.

The key to dealing with aggressive beholder ships is to stay out of their range, and use what speed and maneuverability is available to escape. Long-range attacks work best, but even causing a tyrant ship to break up poses its own problems: the surviving beholders will attempt to swarm over to the victorious ship, either to destroy it or capture it as a temporary home for their queen.

The magic that combines the effects of many beholders and produces a single, effective attack is within the hull of the tyrant ship. The arcane, who cannot deal in *spelljammer helms* to the orbus-using beholders, instead provide a variety of unique shells for each subspecies, with the design registered as a unique "trademark" of that particular species.

Crew

There are three general types of beholders bred to the task of space travel. One is the common beholder of which most groundlings live in fear: the intelligent eye tyrant. These beholders are the only type that can survive without the others, and it is believed that their presence on many planets is the result of crashed ships. The common beholder makes up the bulk of the tyrant ship's crew.

One to six orbi surround the central queen. These are the creatures that provide the ship's spelljamming power. They channel the energy of the other beholders into a motive force. An orbus can do this as long as one common beholder is in the circuit, but needs the queen to provide direction.

The term beholder queen is a misnomer. Beholders are sexless, but show personality traits that outsiders tend to interpret as male or female properties. The queen rests at the center of the shell, the ultimate captain, controlling the actions of all the crew. All the ship's energies pass through her massive central eye in attacks.

Ship Uses

Purification: The beholder nations exist for only one reason: the purification of their race of the scum (meaning any other beholders who look different from them). All other activities—including trading, raiding, piracy, and the like—are secondary to this basic goal. Beholders live to elevate their own subspecies over the other beholders. To an outside eye, since all beholders look pretty much alike, this is fairly stupid, but the fact that the beholders would rather kill each other than take on the rest of universe gives some sages cause to worry.

Other Configurations

Tyrant Rammer: A version of the standard shell with a large piercing ram modified to fit over the front. Used primarily against non-beholder ships, the rammer makes boarding actions easy.

Combined Race Ships: Most tyrant ships have small cargo areas, reserved for food and water. In some cases, beholder subspecies have built more elaborate ships with additional cargo and/or living space for allied races. Such relationships re-

main tense, however, since all other beholders regard dealing with non-beholders as a sign of unworthiness.

There have been beholder/man, beholder/dwarf, and even reports of beholder/mind flayer team-ups. The beholders have an apparent hatred of the neogi, and no such combinations are reported. The most common configuration for these team-ups is a tyrant "shell" mounted to a larger ship.

Tyrant Wrecks: Warring beholders gut the wrecks of their opposition, enslave the enemy orbi (if still alive), and leave them as a warning to others. As a result, there are usually a number of tyrant wrecks in any system.

Such wrecks are usually home to a variety of nasty creatures, but if salvaged, they may be sold to the correct subspecies of beholder for full price, or to the arcane for half. Of course, finding the correct subspecies of beholder is sometimes difficult. The ships of two bitterly opposed factions often can be told apart only by the shape of the tyrant ship's rivets.

TRADESMAN

Built By:	Humans
Used Primarily By:	All races
Tonnage:	25 tons
Hull Points:	25
Crew:	10/25
Maneuver Class:	D
Landing—Land:	No
Landing—Water:	No
Armor Rating:	5
Saves As:	Thick wood
Power Type:	Major or minor helm
Ship's Rating:	As for helmsman
Standard Armament:	
	1 light catapult
	Crew: 1
	1 medium ballista
	Crew: 2
Cargo:	13 tons
Keel Length:	120'
Beam Length:	30'

Description

The standard tradesman is the most common ship in civilized space, varying only in weaponry and added features from Greyspace to Realmspace to the ends of fantasy space. It is used by humans, lizard men, elves, dwarves, mind flayers

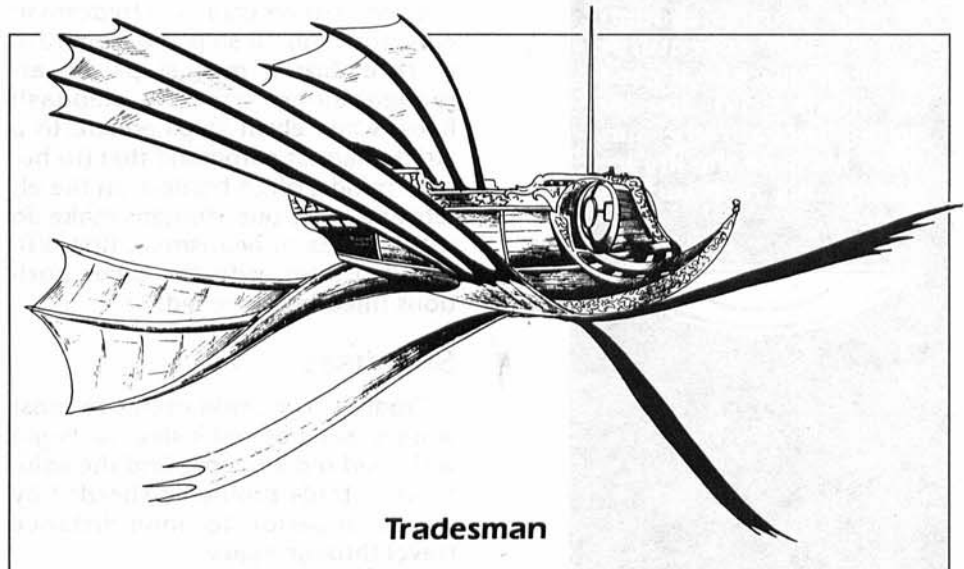

Tradesman



Types of Worlds, Part 1: Earth Worlds

Earth-type worlds are the type most common to adventurers—they are balls (or platters, or whatever celestial body is in vogue) of rock. They may have elements of fire (volcanoes) and water (oceans) on them, and almost always have a large quantity of air covering their surface, though there are earth-type planets that have no atmosphere.

Earth-type worlds have their adventures primarily on the surface of the earth, though there are adventures that take place on the sea or slightly (in spacial terms) beneath the surface. Most of the life inhabits this near-surface zone.



(under duress), gnomes, and even non-spacefaring races such as orcs and halflings.

The tradesman is a common short-range merchant ship, plying its way between the planets, not equipped to deal with much more than a similarly equipped vessel that has turned pirate. The tradesman is often a first ship for deep-space adventurers.

Crew

A typical tradesman is operated by a single captain. If the ship is a free trader, the captain is also the owner. However, there are collections of guildsmen and combined business interests, called trading costers, who own fleets of tradesmen, with each ship's captain both partial owner of the fleet and of his own ship.

Trading costers have the advantage of strength through numbers. They can minimize the loss of a particular ship because they have so many. Costers vary from locale to locale, but all tradesmen owned by a particular coster fly similar colors. Often groups of coster tradesmen will be encountered, carrying merchandise across space in a caravan—if the profit is high enough.

Crew assignments on a tradesman vary from ship to ship and from race to race. Lizard men ships are arranged along typically slapdash lines, while elven ships adhere to a strict chain of command that (to human minds) often borders on the effete and ludicrous. Humans make do with a captain, helmsman, first officer, and pilot, with the other positions filled in as needed.

Ship Uses

Trading: The trade routes to most worlds are not extensive to begin with, and most people find the solutions to trade problems afforded by magic superior to long-distance travel through space.

There are exceptions. Worlds that lack certain metals, lumber, or finished goods are often quite happy to be part of interstellar trade. And, of course, all worlds appreciate the glow of extraterrestrial gems and jewels. The most common traffic—even to worlds that value magic over space travel—is in information; small, valuable items; unique items; smuggling; and passenger service. In these areas the standard tradesman is at its best—a cheap way to get from point A to point B.

The tradesman's *spelljammer helm* is located in the aft of the ship, just below the sailing deck. The bridge is either topside (in calm situations) or within the "head" of the fish (in more dangerous space). The fish's head also holds the captain's quarters.

Free Adventuring: The tradesman is often a first-time adventurer's craft, mainly because it can be bought cheaply and repaired easily. Later, anyone who has made a sufficient amount of money in space to be serious about adventuring there usually jumps ship (pardon the pun) and buys a more suitable squid ship or hammership, or something more suited to their racial temperament. (Gnomes, for example, are surprisingly ill at ease on a tradesman because its operation is so simple.)

Aboard adventuring ships, the chain of command usually stops after captain—which in adventuring terms usually means "the one who yells the loudest." Merchant tradesmen are not particularly happy with the collection of spell-wielding and sword-swinging maniacs who trample all over their stock and trade, riling up the monsters and bringing attention to the tradesman as a ship to attack. The traders' reactions to adventurers who use these ships varies. Some are unwilling to deal with such individuals. Other send them on wild goose chases to other systems to drive them away.

Piracy: The common nature of the tradesman also makes it a vessel for pirates new to the trade, again before they "trade up" to more impressive craft. When using a tradesman, the pirate's best targets are other tradesmen and the occasional galleon (see below) that is brought up out of the ocean by grounding adventurers. Pirates who use the same tradesman for a while tend to modify it by speeding it up, making it more maneuverable, and adding more weapons.

Other Configurations

Light Cruiser: A tradesman variant preferred by pirates and those plagued by pirates. This type of ship has reduced MC (E), but AR of 4. It carries three medium ballistas or catapults.

GNOMISH SIDEWHEELER

Built By:	Menoi gnomes
Used Primarily By:	Gnomes
Tonnage:	30 tons
Hull Points:	30
Crew:	20/30
Maneuver Class:	E
Landing—Land:	50%
Landing—Water:	50%
Armor Rating:	7
Saves As:	Metal
Power Type:	Gnomish
Ship's Rating:	As for gnome helmsman
Standard Armament:	None
Cargo:	15 tons
Keel Length:	120'
Beam Length:	25'

Description

Each gnomish sidewheeler is unique. Each ship is built of the collected scrap, odd inventions, and leftover bits from other ships. Gnomish individualism and personality is found in each sidewheeler, so no two look exactly alike.

For that matter, the same gnomish sidewheeler will look different over time, as the gnomes modify various portions of the ship to their own needs. New portholes and accessways cross the ship as weapon turrets are added and then discarded. Gnomes are more interested in salvage than standard repair and refit, so the scraps of two ships are often brought together to form one hybrid vessel.

Landing a Gnomish Ship: Given the unstable design of gnomish ships, there is a 50% chance that any land-

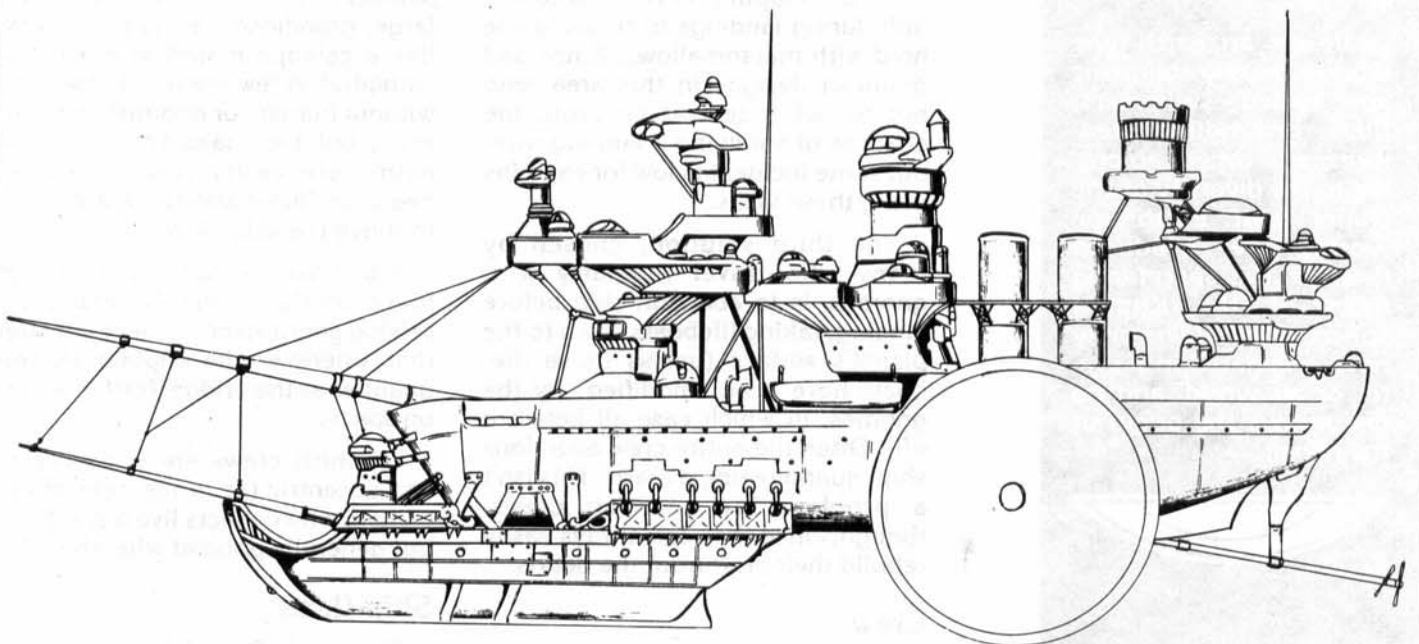

Gnomish Sidewheeler



Earth-type worlds can range from ice to desert and from jungle to plains. There are often multiple environmental niches on the same planet.

The greatest dangers to travelers approaching earth-type worlds are burning up when passing through the air envelope and crashing in an uncontrolled landing. The land tends to be very unforgiving to most ships, and many starships do not land on earth-type planets at all.

Life on an earth-type world is usually abundant and varied—swimmers, fliers, groundling creatures, and others according to the diversity of the planet itself. Earth-type worlds have produced most of the spacefaring races of the Known Spheres (beholders may have originated in a water or air world, and no one knows the origin of the neogi).



ing will result in a crash. A waterborne vehicle brought into space by gnomes may have so much of its hull pierced and modified that it is no longer viable on the water, and will sink. Similarly, with the gnomish tendency to expand, it is highly likely that the gnomes will place additions on the ship without considering the "mundane" matter of landing gear. For example, former struts and landing gear may now be shorter than a recently installed lighthouse on the base.

Gnomes and the individuals they hire have a number of methods of dealing with this problem. The most common solution is to never land, confining the gnomes to sections of deep space and keeping the tinkers away from the various planets with "normal" gnome colonies.

A second solution, preferred by tinker-gnomes, is some form of crash protection. The method of protection varies from installing cloth webbing all over the ship as safety nets to strapping individuals to the hull during landings to flooding the hold with marshmallows. Since bad gnomish designs in this area tend not to get a second test run, the chances of surviving a landing without some incident is low for captains using these ideas.

The third solution, chosen by many who travel regularly with gnomes, is to abandon ship before landing, taking lifeboats down to the planet's surface (unless those lifeboats have been "modified" by the gnomes, in which case all bets are off). Often the entire crew abandons ship, guaranteeing a crash. This isn't a problem for gnomish crews, though, since they can always easily rebuild their craft from the debris.

Crew

A typical gnomish ship has a crew of 21-40 gnomes. Due to the gnomes' small size, they count as half a human-sized creature for air

depletion. On their ships, gnomes continually scoot through the halls, bouncing off the bulwarks and tinkering with everything in sight.

Gnomes are fairly egalitarian in their operations, with only the captain's position being fixed for any long period of time. All other positions upon the ship—helmsman, navigator, quartermaster—rotate through the rest of crew by a schedule determined by time, ship's position, sphere, and phase of the moon of the gnome's homeworld (if any). As this often moves ill-suited individuals into vital positions, gnomish ships operate haphazardly at best; this week's chief cook might be summoned to the bridge next week (wherever it is then) to lay out a course for the next planet.

Gnomish crews include gnomoi, minoi, and "standard" gnomes. It is that latter group, in particular the individuals with spellcasting ability, that are used to power the *spelljammer helms*. Gnomish helms are large, grandiose creations that look like a calliope mated with a gothic cathedral. A few are reputed to work without human (or gnomish) interference, but the majority of gnomish helms are vastly complicated by needless "innovations" that do little to move the ship along.

A gnomish captain can usually be found on the bridge. Several enterprising gnomish crews have declared that wherever the captain is, that qualifies as the bridge, further saving on space.

Gnomish crews are idiosyncratic and eccentric (as in the case of one captain who collects live butterflies), but generally good at what they do.

Ship Uses

Transport: Gnomish ships are the proverbial "slow boat to Krynn." If you're sending a message, package, or ill-favored relative somewhere,

and it doesn't matter when (or if) they arrive, gnomish ships are the cheapest way to travel. Gnomish captains are usually eager to take on cargo relatively cheaply.

Exploration: Gnomish captains and crews are excited by the idea of new things and discoveries, and can often be hired on by the brave (and foolish) to go where no gnome has gone before. It usually isn't difficult to convince a gnomish captain that he would be furthering the cause of gnomish exploration. Since they keep such poor records of their travels, most gnomes can visit a sphere any number of times, but remain certain that each visit is their first.

Gnomish Juggernauts: Gnomish ships do not normally carry large weapons. Neogi and mind flayers have discovered that gnomes make incredibly poor slaves (and some ships have been destroyed by gnomes "helping" with the rigging).

Occasionally, a traveler will encounter the complete opposite—a gnomish ship that is loaded to the gunwales with every weapon they can lay their hands on. Up to 15 tons of weapons can be mounted on a gnomish ship, probably in a random pattern. Gnomes will mount more weapons than they possibly can crew, since the extras are "spares." Gnomish juggernauts can be of two types: the obvious juggernaut (often with big glowing signs made from light spells, saying "Hey, we're bad!") or the Q-ship version (Q standing for quiet), which is detectable as an armed ship only at close range.

Other Configurations

Juggernauts: Weapon choice for a gnomish juggernaut is up to the DM, but should follow something of a pattern—either all ballistas, or all small weapons, or all light weapons. Up to two rams can be used (front and rear). Juggernauts sometimes (10%) have extra armor plating

(made from scrap iron golems) that improve the armor rating by 1 while reducing the maneuverability class by 1 factor (to F).

Speed Clipper: This version of the gnomish sidewheeler is little more than a framework with a few level surfaces for the crew. Hammocks and netting hang everywhere to keep the cargo in place. In this fashion, the ship's maneuverability is improved to C, but its armor rating is reduced to 8. Further, the ship cannot make any type of safe landing, and all members of the crew are visible and can be shot at (there is no "below decks" to take cover in).

NAUTILOID

Built By:	Mind flayers
Used Primarily By:	Mind flayers
Tonnage:	35 tons
Hull Points:	35
Crew:	10/35
Maneuver Class:	D
Landing—Land:	No
Landing—Water:	Yes
Armor Rating:	4
Saves As:	Thick wood

Power Type:	Series helm (90%) Pool helm (10%)
Ship's Rating:	2-5 (series) 5 (pool)

Standard Armament:	
3 medium ballistas	Crew: 2 each
1 medium catapult (forward)	Crew: 3
1 medium jettison (rear)	Crew: 3
Piercing ram	
Cargo:	17 tons
Keel Length:	180'
Beam Length:	30'

Description

The nautiloid is the standard ship of the line of the various spacefaring illithid nations, and reflects the nature of the race. Its coiled shell provides the comfort of enclosed spaces while protecting the mind flayers from the irritating rays of the sun.

Crew

A standard mind flayer crew numbers 10 illithids, plus 2-5 additional

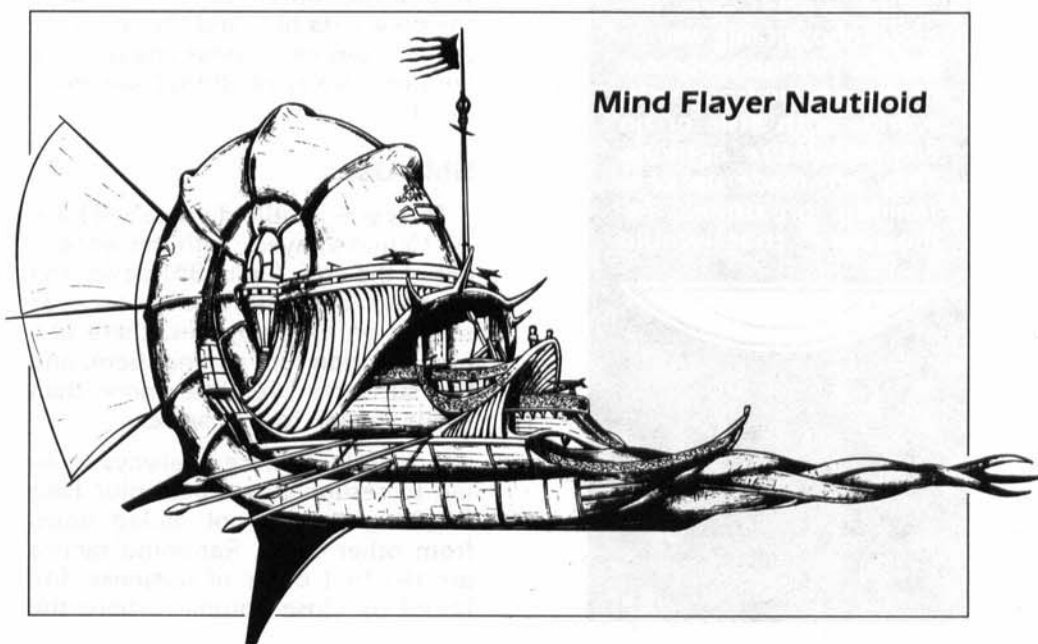

Mind Flayer Nautiloid



Types of Worlds, Part 2: Fire Worlds

Fire worlds are the second most commonly encountered type of celestial body after earth-type worlds. They are usually referred to as stars, suns, and solar spheres. The most common type of arrangement for a planetary system is to have a large fire body in the center, earth bodies surrounding it, and scattered, smaller fire bodies dotting the crystal shell. Fire worlds can be any shape, though spherical is most common.

Fire worlds are the most inhospitable worlds for star voyagers, as most of them come from earth worlds with little or no elemental fire activity. They are made up of a flaming, breathable atmosphere that would



flayers, depending upon the number of series helms in use. The ship's rating of a nautiloid ship is determined by the number of such helms in use. A mind flayer ship has a single captain and first officer, the remainder of the group being crew.

If additional crewmen are on board, they are usually slaves of the mind flayers. The illithids prefer to use (expendable) slaves to man the catapults, while the mind flayers remain in the relative comfort of the interior. Humans (treat as fighters, levels 1-4) are the slaves of choice, but there are sometimes other races (gnomes, halflings, elves, dwarves, but never beholders, neogi, or other "monster" races).

The ship's captain is always at the controls, overseeing the ship's general welfare and giving orders to the helmsmen. The first officer is usually stationed on the upper deck, directing the main catapult. As this is the site of most attacks against the ship, the first officer's position is not envied, and any first officer is usually conspiring to attain the relative safety of captaincy. Still, no position is completely safe on a mind flayer ship. If the captain is incapacitated, the crew eats him and the first officer is promoted. Assassination is a common form of illithid advancement.

Ship Uses

Piracy: A nautiloid pirate will have 12-15 mind flayers, with the remainder of the crew (up to 35) slaves and boarders. Since slaves often serve as rations on long voyages, there is a high attrition rate among them, and the survivors are little more than shells of their former selves.

A nautiloid pirate is always looking to resupply its stock, plus take anything that is not nailed down from other ships. Ramming tactics are the first order of business, followed by close combat, where the

flayers use their mental powers on the creatures at close range. Often a nautiloid pirate will masquerade as a trader to close with a target, then ram the unsuspecting ship.

Trading: As the workhorse of the illithid fleet, the nautiloid is often pressed into service as a trade ship. Such ships will have only 2-5 mind flayers to man the helm, plus a captain and first officer, and 3 slaves to man the catapult. These ships rely on speed to make their escape from enemy ships.

Military: Nautiloids are used in picket duty in various hot spots and as fast spy ships that can report back to the mind flayer fleet. A long-time standard ship, the nautiloid is being replaced slowly by larger ships using the pool throne.

Other Configurations

Alternate Power Source: The majority of nautiloids use a series helm that links multiple mind flayers into a "magical chain." This chain provides the ship's spelljamming power. A new form of propulsion being brought on line in the illithid fleet is the pool helm, in which a batch of immature mind flayer tadpoles is harnessed and used to power the ship. Only 10% of the mind flayer ships have this new power type, believed to have been invented by the arcane with the illithids in mind.

Pool-helmed ships have an SR of 5. In addition, the pool helm frees the 2-5 mind flayers that were previously occupied in maneuvering the ship. This makes pool-helmed ships even more deadly.

Added Armor: Some customized nautiloids have a thicker shell that provides further protection from outside attacks. Traders and pickets sometimes have this extra armor. The MC of such a ship is reduced by 1 class (to E), while the armor rating is improved by 1 (to 3).

Added Speed: A stripped-down version of the nautiloid sacrifices armor for additional speed, increasing the MC to C, and reducing the AR to 5. Such ships carry either a pool helm or series helm with 5 mind flayers, but no additional crew. In some cases the ship's weapons are pulled as well.

Optional Armament: The medium catapult is occasionally replaced with a heavy ballista (crew of 4), in ships posted as naval pickets.

Non-Mind Flayer Crews: Often adventurers and other hearty souls will refurbish a nautiloid for their own use, replacing the series helms with a major or minor *spelljammer helm*.

NEOGI MINDSPIDER

Built By:	Neogi
Used Primarily By:	Neogi
Tonnage:	40 tons
Hull Points:	40
Crew:	3/40
Maneuver Class:	C
Landing—Land:	No
Landing—Water:	No
Armor Rating:	4
Saves As:	Metal
Power Type:	Lifejammer
Ship's Rating:	As for victim
Standard Armament:	
	2 medium catapults Crew: 3 each
	1 medium jettison Crew: 3

Forward grappling/piercing ram
Rear piercing ram

Cargo:	20 tons
Keel Length:	40'
Beam Length:	15'

Description

The mindspider is a new ship; the general adventuring public knows little about it. This will change over time as the mindspider gathers the same reputation as the neogi deathspider (see below)—a deadly craft that should be attacked on sight.

The mindspider is a lighter, faster, more maneuverable, stronger craft than the deathspider, but carries less weaponry. It is used in situations

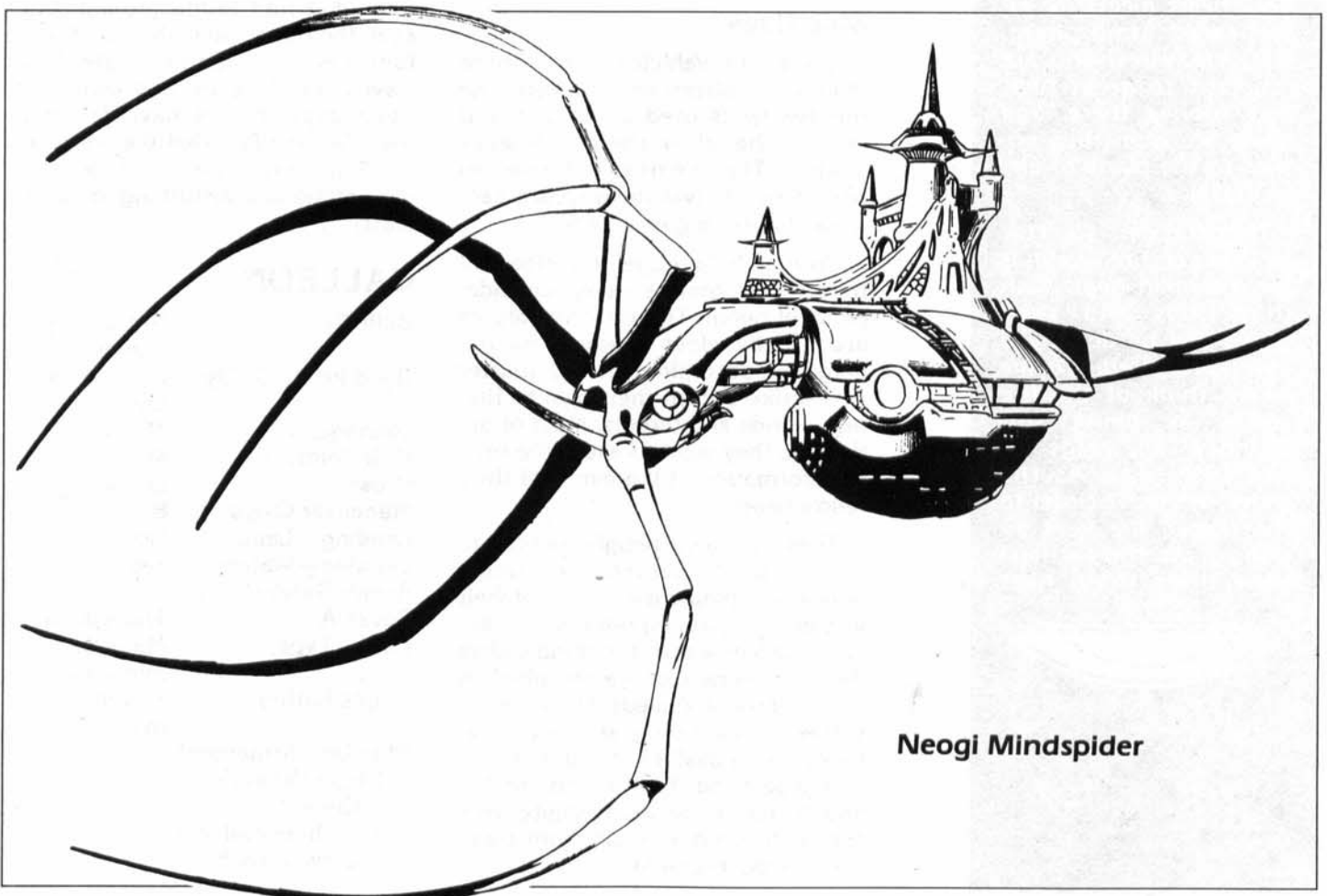

Neogi Mindspider



burn out the lungs of an ordinary mortal, wrapped around a volatile fiery core. Earth islands in the molten sea are rare, and water is non-existent.

Known life on fire worlds exists where the fiery heart meets its superheated atmosphere. Only creatures who are resistant to great heat may survive there, and there are numerous entries to the plane of elemental fire.

The danger to star travelers on fire worlds is the inhuman heat, such that ships and their crews will be destroyed unless protected. In game terms, think of the fire world as being surrounded by rings or zones of heat. As the characters move closer to the center, the heat increases. At the farthest zone there is no heat



where subtlety or what passes in neogi terms for subtlety, is needed.

Crew

The deathspider can be operated by as few as three neogi (though the operation is actually through their umber hulk slaves). The ship's weapon pits are usually manned by slaves. On a mindspider, however, the slaves are placed under a *charm* spell or other enchantment magic to make them willing servants, loyal to the neogi captain.

Organization aboard the mindspider is typical of the neogi race; all crew members, regardless of race, are the property of the captain, and supposedly loyal until death.

Ship Uses

Command Vehicles: When more than one deathspider is present, the mindspider is used as a command vehicle, the lair of the neogi fleet's "owner." This seems to cut down on the cases of rival deathspider captains challenging each other.

Piracy: In a huge universe, all things are possible—even an independent neogi. These rare creatures are usually elder captains on the verge of becoming an old master who strike out on their own to find new worlds and targets. Most of all, though, they want to avoid the final transformation at the hands of their fellow neogi.

These renegade neogi captains are often total berserkers, consumed only with wiping out any trace of their existence, including other ships that pass them in space. The mindspiders these captains use are modified to suit their owners' needs. This often involves the addition of as many armaments as possible, though some renegade neogi have found stealth, and therefore maneuverability, very useful in avoiding their more traditional neogi brethren.

Other Configurations

Broodship Lander: The neogi are noted for their (fortunate) absence from larger planetary bodies. However, there seems to be a neogi movement to invade and settle larger planets. For this purpose, mindspiders are adapted for use as landing craft.

These mindspiders are stripped of their engines, weapons, and crew, and let loose from orbiting deathspiders. Their cargo holds loaded with neogi eggs and an undead old master as their guardian, the ship circles a potential seed planet until its orbit decays and it falls.

Should the ship burn up or land in an ocean and sink, there is no loss. Should it find fertile ground, however, the old master will train the infant neogi to domesticate local slaves and develop their own base. Such experiments have failed to date, but the fact that the neogi are looking at planets as a possible base of operations is disturbing to say the least.

GALLEON

Built By:	Groundling humans
Used Primarily By:	Groundling humans
Tonnage:	40 tons
Hull Points:	40
Crew:	20/40
Maneuver Class:	E
Landing—Land:	No
Landing—Water:	Yes
Armor Rating:	7
Saves As:	Thick wood
Power Type:	Major or minor helm
Ship's Rating:	As for helmsman
Standard Armament:	
	1 light catapult Crew: 1
	2 medium ballistas Crew: 2 each

Cargo: 20 tons
Keel Length: 130'
Beam Length: 30'

Description

The galleon is the best ocean-going craft that groundling nations can bring into space. It is nothing more than a sailing ship with the *spelljammer helm*—purchased or salvaged from some wreck—attached.

Of the peoples of the known worlds, only the nation of Shou Lung on Toril sponsors a realistic approach to space travel. Other nations dabble, though, and the most thoughtful of them use the galleon as their vessel of choice. Bulky and slow, it still gets the job done, and its large cargo hold carries a great deal of spoils from other lands.

SQUID SHIP

Built By: Humans
Used Primarily By: Humans, lizard men
Tonnage: 45 tons
Hull Points: 45
Crew: 12/45
Maneuver Class: D
Landing—Land: No
Landing—Water: Yes
Armor Rating: 5
Saves As: Thick wood
Power Type: Major or minor helm
As for helmsman

Ship's Rating:

Standard Armament:

1 heavy catapult
 Crew: 5
 2 medium ballistas
 Crew: 2 each
 Piercing ram

Cargo: 23 tons
Keel Length: 250'
Beam Length: 25'

Description

The squid ship—officially the cephalopod-class brig—is known throughout space by its more common name.

Many scholars believe that the original design for the squid ship was created by revolting prisoners of an illithid slave-world, who fused together elements of sea ships and the standard nautiloid design. Some sages point to the existence of such ships in spheres where the mind flayer is either extinct or unknown as proof against this theory, but the tale remains.

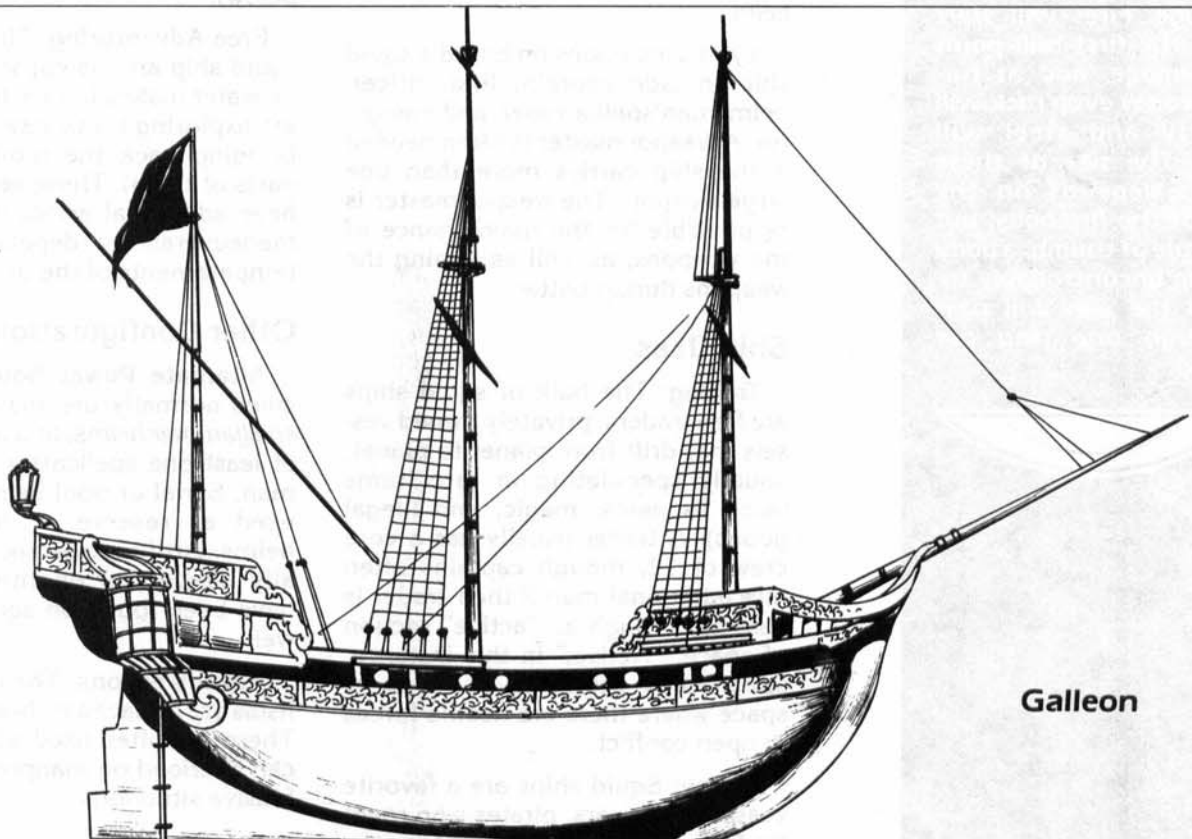

Galleon



or fire damage. One zone in, living creatures take 1d6 points of damage per round, and this doubles with each ring moved into, to a maximum of 30d6 per round. Hulls take similar damage with 10 hit points of damage equaling 1 point of hull damage. Fires will start with the first hull point of damage, and at further zones even rock will liquefy and steel will melt. The size of these zones depends on the size of the fire body, but as a rule of thumb, a body falling uncontrollably toward the sun will pass through one ring per round.



The straight lines and good maneuverability of the squid ship make it one of the most popular vessels of its size. It is usually used for trading, exploration, and privateering.

Crew

The squid ship's simple design allows a relatively small crew to handle the rigging and maneuvering. The captain is usually found on the aft deck, where he gets a good view of most of the ship. The *spelljammer helm* is usually located directly beneath the captain's station, with communications to the helm via speaking tube.

Human ships typically have an obvious captain's bridge, while the helm remains hidden. The damage to morale from the loss of a captain in combat is nothing in comparison to the loss of the ship's *spelljammer helm*.

Typical positions on board a squid ship include captain, first officer, helmsman/spelljammer, and navigator. A weaponmaster is often needed if the ship carries more than one large weapon. The weaponmaster is responsible for the maintenance of the weapons, as well as aiming the weapons during battle.

Ship Uses

Trading: The bulk of squid ships are free traders, privately owned vessels that drift from planet to planet, usually speculating in rare items (such as gems, magic, and illegal goods). A trader usually has a core crew of 12, though captains often hire additional men if their trader is passing through an "active" section of space. "Active," in this instance, specifically refers to sections of space where there are hostile forces in open conflict.

Piracy: Squid ships are a favorite vessel for reavers, pirates who roam far from their base looking for easy

plunder. Capable of laying in wait for other ships for a long time, the pirate squid ships carry a full crew of 35, usually fighters of level 2-4. They also carry a second mage in addition to the spelljamming mage or priest. This mage is usually less powerful than the primary spelljammer and is often placed at risk in boarding situations. Squid ships used for piracy usually use a grappling ram (see below).

Military: The simple design and size of the squid ship makes it a common choice for human space navies as both a defensive warning craft and an assault vehicle. For short distances and actions close to base, a naval squid ship will overload (carry more than its standard complement of troops) to repel attackers. Such ships will replace their medium ballistas with heavy versions (see below).

Free Adventuring: The size of the squid ship and its capability to land on water makes it ideal for adventurers exploring brave new worlds (and bringing back the more profitable parts of them). These versions often have additional armor or increased maneuverability, depending on the temperaments of the users.

Other Configurations

Alternate Power Sources: Squid ships normally use major or minor *spelljammer helms*, and as such carry at least one spellcaster as a helmsman. Serial or pool helms are often used as reserve or replacement helms. Artifurnaces and (for the really desperate) gnomish furnaces have been found on squid ships, as well.

Naval Weapons: The medium ballistas are replaced by heavy versions. These are often used when the ship can overload on manpower or in defensive situations.

Added Armor: An additional layer of wood strengthened by copper bands is laid inside the existing hull, increasing protection at a sacrifice of maneuverability. The AR is raised to 4, but the MC drops to D.

Alternate Ram: Favored by pirates and others preferring boarding actions to ship-to-ship combat, the grappling ram sometimes replaces the piercing ram on squid ships. Such vessels usually carry the full complement of troops.

Lizard Man Crews: A large number of squid ships controlled by lizard men tribes are used as transports. Others, used as incubators for lizard man eggs, take their cargos in tight

orbits around solar bodies. Between 1-6 tons of a lizard man egg ship are used for the cargo of eggs, with another 2-8 tons being used for plants. Lizard man ships tend to be overgrown with plant life to help recharge the air. They are also often heavily painted in bright colors.

DRAGONSHIP

Built By: Humans
Used Primarily By: Humans
Tonnage: 45 tons
Hull Points: 45
Crew: 20/45
Maneuver Class: D
Landing—Land: No
Landing—Water: Yes

Armor Rating: 5
Saves As: Thick wood
Power Type: Major or minor helm
Ship's Rating: As for helmsman

Standard Armament:
 2 medium ballistas
 Crew: 2 each

Cargo: 22 tons
Keel Length: 150'
Beam Length: 20'

Description

As a rule, the groundling nations tend not to think about the empires that battle far over their heads. There is the occasional upstart nation or magocracy that turns its attention to

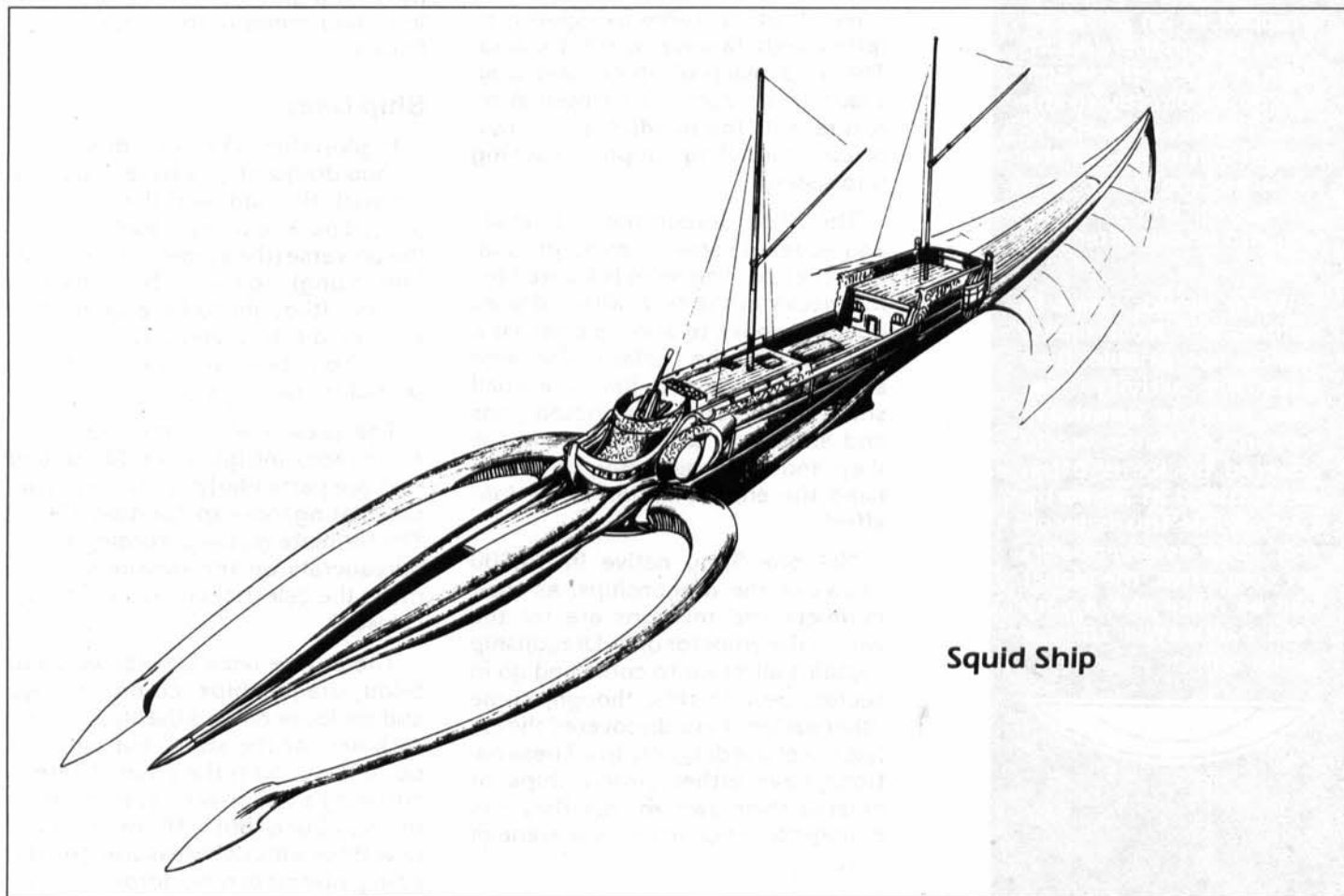

Squid Ship



Types of Worlds, Part 3: Water Worlds

Water worlds are generally water to the core, though at the deepest levels the pressure is so great that materials cave in on themselves in a tight, solid earthen ball. Water worlds are usually wrapped in an envelope of air, though there are instances where the water is exposed directly to the void. There is no evaporation in this case, but the surface of the water has a "skin" which may be broken and reseals after passage.

Water worlds range in temperature from almost boiling hot (should they have fire activity near their core) to practically frozen. A water world covered by ice is often misclassified as an earth-type. While this is incorrect, as far as adventurers are concerned, the planet will be more like a very cold earth-type than a water-type.



space, but these efforts are short-lived since either internal pressures do them in or other spacefaring nations quickly put the upstarts back in their place. As a result, a major effort to reach space only comes from worlds with one ruler.

An exception is the so-called "oriental" lands of the FORTOTTEN REALMS™ campaign world. Based in a large area of land with long-lived ruling organizations, the eastern nations of Toril have dabbled in space exploration.

In fact, Shou Lung's approach to space exploration is typical of the oriental nations throughout known space. While "western" nations dismiss space travel or turn their attentions to more militaristic ends, the oriental nation pushes its experimentation with fantasy space forward. The dragonship of Shou Lung is an example of such experimentation and reflects the mindset of an organized groundling empire reaching into space.

The Shou dragonship is boatish, and suffers in space—as all groundling craft do. The helm is located below decks in the rear, with a domes opening above to allow a clear view of space and the captain. The large structure on the deck itself is a small shrine to the crew's venerated gods and ancestors, to the Path and the Way, and to the emperor, by whose hand the entire mission is set into effect.

Not one Shou native in 10,000 knows of the dragonships, as their numbers and missions are for the ears of the emperor only. Dragonship captains all swear to come and go in secret. Despite this, though, some other nations have discovered the existence of the dragonships. These nations have either stolen ships or created their own so that they can contest the Shou in the new arena of space.

Crew

A typical Shou dragonship has both a captain and a helmsman. Perhaps the most important post on a Shou ship belongs to the recorder. The recorder's task is to keep notes on all encounters, collect specimens and trophies, and to act as the official diplomat from Shou Lung. To that end, each recorder is given a number of blank scrolls of official greeting from the emperor. The recorder is empowered to fill in the name of the appropriate race and present them.

The crew of the Shou dragonship (and similar "oriental" vessels) are single men used to long voyages. They are armed with repeating crossbows, a groundling invention that has found great favor in space, making Shou crews both respected and feared.

Ship Uses

Exploration: The chief mission of a Shou dragonship is to seek out the unusual, the odd, and the new, and bring it back to the spiritual center of the universe (the emperor's palace in Shou Lung). So far, such wonders as a neogi (thought to be a demon), a preserved orbis, and a *crown of the stars* have been returned and presented to the emperor.

The presence of other spelljamming races intrigues the Shou, and they are particularly interested in accumulating more *spelljammer helms*. The ultimate goal—according to the bureaucrats on the missions—is to make the celestial bureaucracy truly celestial.

There have been several waves of Shou dragonships commissioned and set loose among the stars, as the "scholars of the stars" fall into and out of favor with the court. There is currently a lull in interest in the stars in Shou Lung, but with the return of new ships with rich treasures and the rising interest of other lords, it is only

a matter of time before the dragonships sail the spheres again.

Free Adventuring: Of course, if you cast your bread upon the waters, some of it will turn soggy. A large number of captains and recorders exposed to the marvels of arcane space suddenly wonder why they would throw in with some small-time emperor when there are whole worlds out there to be discovered or even conquered.

The result is a large number of dragonships no longer loyal to the emperor, cruising around the spheres, taking what they need. Such ships end up in the hands of adventurers, merchants, pirates, and other "free agents" of space. These ships reflect their owners' needs—added armor or increased maneuverability, more weapons (up to three more heavy weapon mounts), and alternate power sources.

Other Configurations

Flaming Dragons: The Shou who take to space in dragonships (especially those who have gone freebooter) have a love for bombards and greek fire projectors matched only by that of the lizard men. Such destructive weapons appeal to these newcomers to space, and often all the heavy weapons on board are of this type, with much of the cargo space taken up by shot and shell. As a result of this dangerous tendency, there are significantly fewer dragonships in space than there might be if their captains favored carrying "safer" weapons.

HAMMERSHIP

Built By:	Humans, lizard men
Used Primarily By:	Humans, lizard men, some elves
Tonnage:	60 tons
Hull Points:	60
Crew:	24/60
Maneuver Class:	D
Landing—Land:	No
Landing—Water:	Yes
Armor Rating:	6
Saves As:	Thick wood
Power Type:	Major or minor helm
Ship's Rating:	As for helmsman
Standard Armament:	
	2 heavy catapults
	Crew: 5
	1 heavy ballista
	Crew: 4
	1 blunt ram

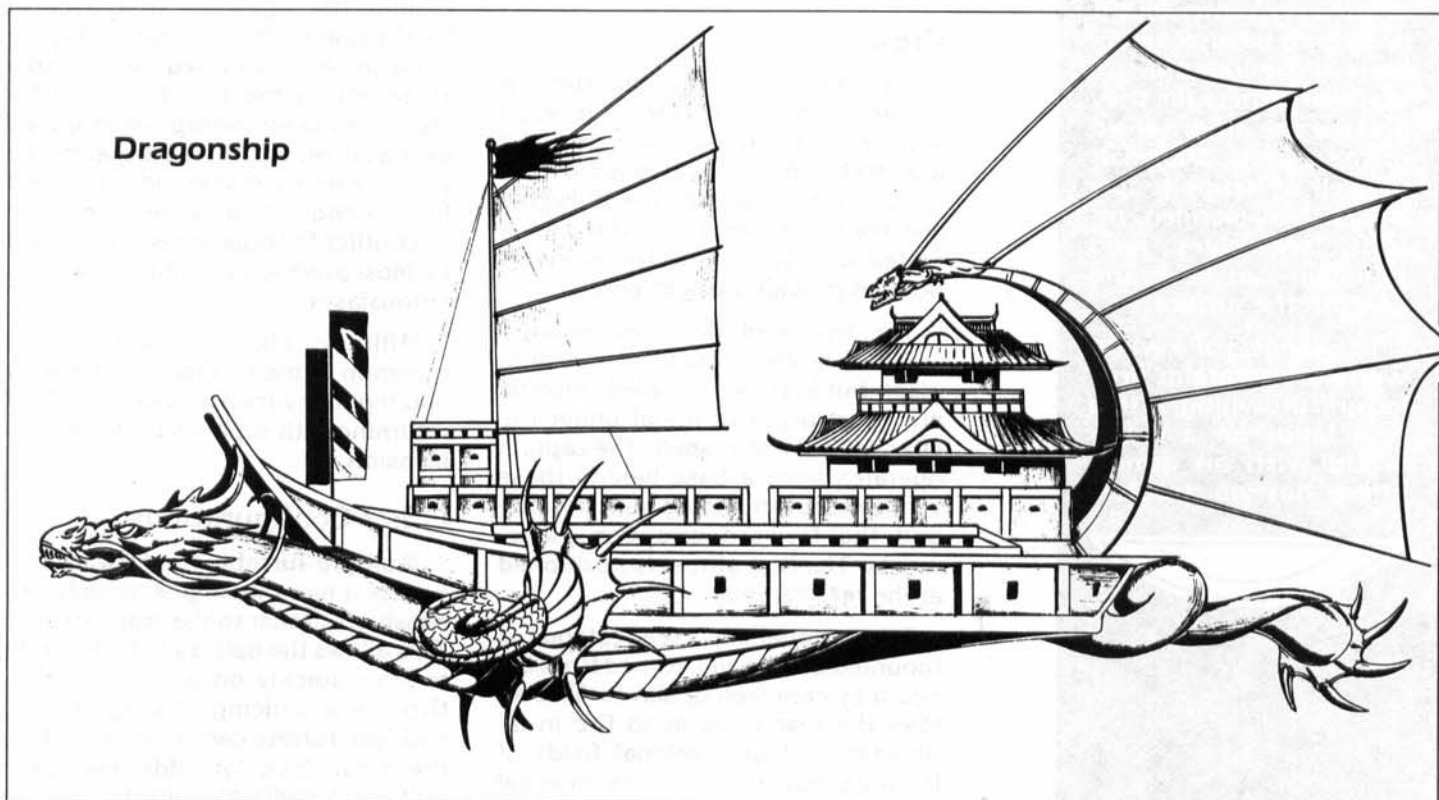



Islands and small bits of earth floating beneath the surface are common on water worlds, and those that exist are often settled by the intelligent life of that world. These form handy trading posts with stellar visitors, who otherwise would be lost in the expanse of water.

Life on a water world is concentrated in the top one mile of its surface, where the air meets the water. There may be life at the very center, but it has yet to be discovered. Most of the creatures are water-breathers (or they breathe the air dissolved in the water). Mammals as well as sentient species such as mermaids, tritons, sea elves, and sahuagin can be found beneath the surface.

The dangers of a water world are twofold: sinking and drowning. A ship that lands on a water world with an atmosphere has no trouble,



Cargo: 30 tons
Keel Length: 250'
Beam Length: 25'

Description

Another standard human ship of space, the hammership is both large and powerful, capable of withstanding large amounts of punishment and dealing out a massive amount with its blunt ram. If the squid ship is the light warship of space, this is the heavy galleon.

Hammerships are found, with small modifications to their design, throughout all known space. The hammership's design has been relatively unchanged, such that hulks several millenniums old resemble those under construction in the asteroid dry docks of the arcane. Even the elves and mind flayers, with their own distinctive ships, use the hammership design for their ships used in workhorse and supply situations.

Crew

The "brains" of the hammership are in the heavily protected forward section. Both the *spelljammer helm* and the bridge are located in this section, behind the massive bulwarks and the blunt ram. Often this ram is plated with heavy metals, ivory, or bone to provide extra strength.

The lenses of the hammership's "eyes" are often made of paneless glass, but in some modified versions are constructed of metal under the effect of a *glassteel* spell. The captain operates from a base behind these windows, commanding both the ship and the forward weapons placements. The first officer is positioned at the rear catapult.

The hammership's rear catapult is mounted on a swivel, turned beneath by crewmen or slaves. This allows the rear catapult to fire in all directions (if the optional fields of fire are used). In some cases, magical

creatures such as golems are used to man the swivel. Otherwise, a team of 10 men is required to move the weapon.

Ship Uses

Trading: A hammership requires a larger crew than the more common squid ship, but can carry more cargo. This makes it ideal for transporting large bulk cargos of semiprecious material (such as amber or semiprecious raw stones, or extra-planar delicacies such as wine or planetary beef). Such ships run on a minimum crew, unless they are passing through contested space. Then, the captain will take on a full crew (including a large number of wizards and priests).

Piracy: Though not commonly used as a pirate vessel, the hammership is the favorite craft of some of the most stylish and brazen pirates and privateers in known space, including the legendary Bloodjack of Realmospace. His hammership is dyed in shades of red, supposedly representing the blood he and his ship, the *Lucky Victory*, have spilled over a career spanning a decade. The size of a hammership makes it ideal for prolonged battles—just the type of conflict Bloodjack seems to revel in. Most privateers wouldn't share his enthusiasm.

Military: The hammership is a common armada craft, capable of hauling many men across space and returning with supplies to support an invasion.

Other Configurations

Multiple Turrets: The forward ballista of a hammership is mounted in a fashion similar to the rear catapult. This allows the ballista to be brought to bear quickly on any target. Further, by sacrificing of cargo space, multiple turrets can be mounted on the main deck for additional catapults and ballistas. Turrets may be

mounted on the bottom of the ship as well, but this prevents water landings.

Bombards: Since lizard men use the ship's central pool as a fire prevention device, they often install bombards instead of ballistas and catapults on a hammership's main mounts. Bombards are used only in spheres where smoke powder is in common use.

Greek Fire Projectors: Lizard men will cheerfully use greek fire wherever it's available. They mount the projectors at the forward ballista. The section where this projector is mounted becomes more vulnerable to fire damage.

Heavy Hammerships: Multiple platings of bone, wood, and metal reduce the maneuverability of a heavy

hammership to that of a groundling vehicle in space (MC F), but raises its armor rating to 4 and provides a saving throw as if for metal. Heavy hammerships often use multiple turrets, and are excellent central command vessels for armadas (and, alternately, "armada-busters"). Heavy hammerships are often used to plow into and destroy smaller ships. With its poor maneuverability, however, the heavy hammership is not usually seen outside large fleet actions.

Lizard Man Crews: Hammerships are commonly used as traders by the lizard men. In such vessels, the ship's central decks are flooded to provide a central relaxation and breeding area for the crew. These interior lakes are dumped into space if the ship has to flee, creating the equivalent of a debris field behind

the hammership that will slow pursuers.

Mind Flayer Crews: Hammerships are used by mind flayers as free traders, unaligned to any illithid faction or house. Since many captains will fire upon any standard mind flayer nautiloid, a growing number of mind flayer traders have adopted the hammership as the craft of choice. The eyes of hammerships controlled by mind flayers are often covered over with steel plates.

Elven Crews: Hammerships are occasionally used by elven armadas, primarily as supply and troop ships. A hammership's bulky size and difficult handling (in comparison to most elven craft) make it unsuitable for anything but a support vessel in most elven armadas.

Hammership

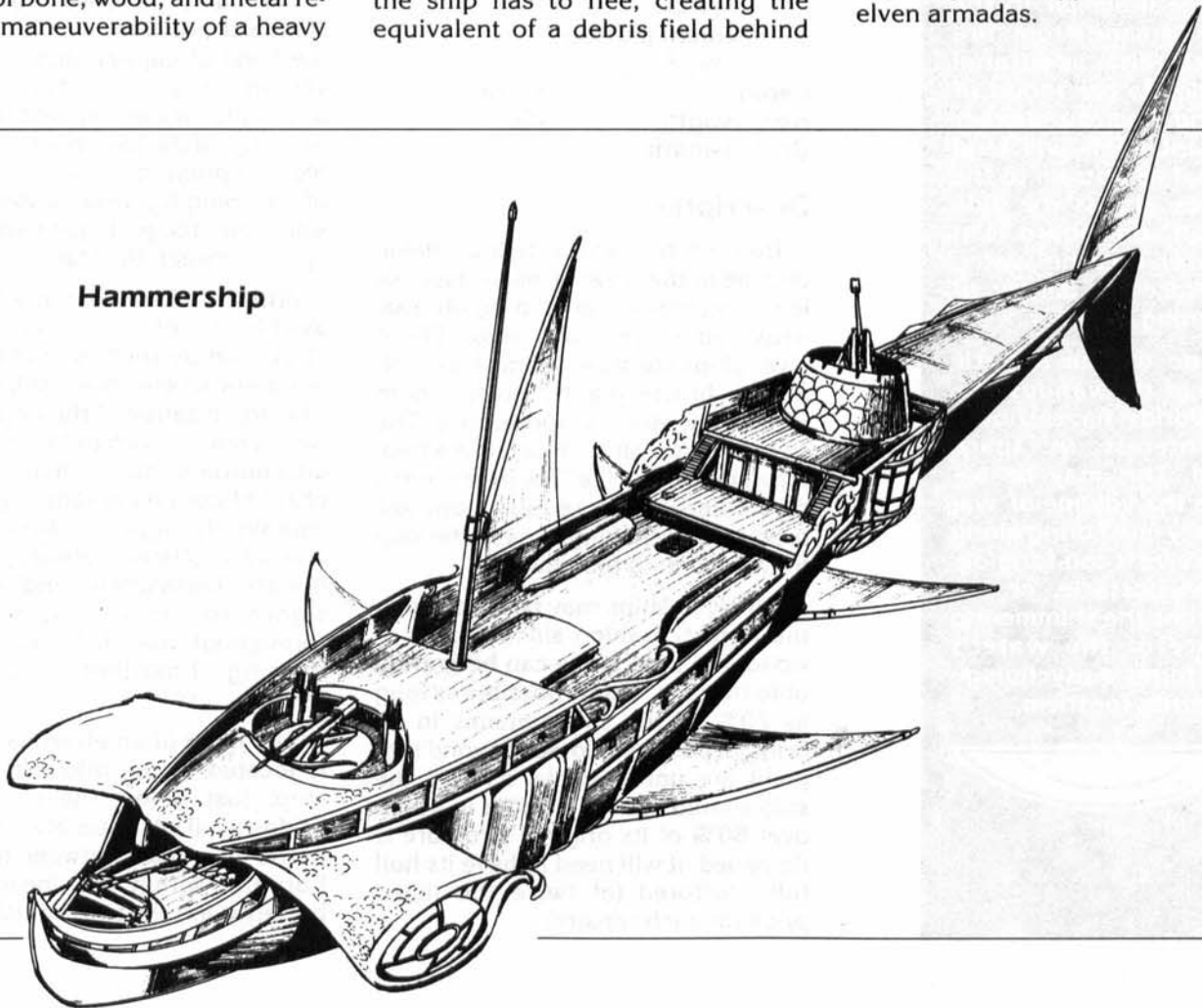



but one that dives beneath its surface will lose its air envelope, unless the *retain air* spell has been used to keep the air bubble intact. Still, unless the craft has been designed for sea travel, it will sink, taking damage from the pressure and eventually rupturing from the water pressing in on the envelope. This damage is similar to the heat damage from fire bodies—an additional 1d6 points per round of sinking. Bodies and other buoyant items will tend to float as flotsam to the surface. Unless the individuals on board can swim or breathe water, they face the danger of drowning.

None of the aquatic races of the various water worlds have shown an interest in space travel. This may be because the volume of water they must bring along to survive is too formidable an obstacle, or the fact that the shimmering surface of the water's edge forms a psychological barrier for them.



MAN-O-WAR

Built By:	Elves
Used Primarily By:	Elves, some men
Tonnage:	60 tons
Hull Points:	60
Crew:	10/60
Maneuver Class:	C
Landing—Land:	No
Landing—Water:	No
Armor Rating:	7
Saves As:	Ceramic
Power Type:	Major or minor helm
Ship's Rating:	As for helmsman
Standard Armament:	
2 medium ballistas	
Crew: 2 each	
1 medium catapult	
Crew: 3	
1 medium jettison	
Crew: 3	
Cargo:	30 tons
Keel Length:	200'
Beam Length:	20'

Description

Built on the largest hull available outside of the great armadas (see below), the man-o-war is a highly maneuverable, well-built ship. These elven ships are grown from glossy, relatively brittle plants, giving them their shiny, ethereal appearance. The ships remain "alive," much like a tree, throughout their life. The man-o-war's crystalline wings require constant pruning and shaping to keep the ship from becoming too unwieldy.

All elven ships may be repaired in the normal fashion since blocks of wood and even stone can be grafted onto the ship. This is possible as long as 20% of the ship remains in its original position. Losses beyond that point are unreparable. Even if the ship should survive a battle in which over 80% of its original structure is damaged, it will need to have its hull fully restored (at twice the listed price for such repairs).

Crew

The crew of an elven man-o-war depends greatly upon what it's being used for. Adventuring ships have few set positions below captain, while naval vessels have a highly structured chain of command.

Ship Uses

Free Adventuring: The elven man-o-war is a good adventuring craft for deep space. As long as the ship's users have no intention of making planetfall with the craft, it should serve them well. In addition, any character with forester or woodworking/carpentry proficiency should be able to keep the ship in good trim.

On such adventuring vessels, standard positions are loose below the level of captain and owner. Adventurers usually paint colorful signs and sigils on the ship and the graceful wings of the man-o-war. One notable exception to this is the Company of the Singing Void, whose man-o-war is painted jet black to match the space between the stars.

Military: The man-o-war is the workhorse of the elven Imperial Navy, and as such is found in great numbers where these ships swarm. The organization of the naval man-o-war's crew is much tighter than on an adventurer's ship, with an organized chain of command ranging from the captain through the first, second, and third officers, primary and secondary helmsmen, and elves assigned to the various battle pits throughout the ship, such as fire-fighting, boarding, and weapon teams.

The helm of an elven naval vessel is located in the midsection of the ship, just below the bridge. The bridge itself sits squarely on the back of the man-o-war between the wings. Forward, within the "head" of the butterfly, are the twin ballistas, firing

from positions in the eyes. The catapult is located just to the rear of the bridge and is covered by a retractable dome. Finally, at the rear of the ship's abdomen, is a medium jettison, located just aft of the cargo bays.

The elven navy adheres strictly to this particular man-o-war design. Individual captains and admirals who change the basics of the craft are reprimanded (though often along with a commendation for battles won using those unofficial modifications).

Other Configurations

Personal Modifications: Adventurers are not so limited as the navy in their perception of the man-o-war, such that lower-armored, heavier-winged craft are common (with a reduction of AR to 8 and an increase in MC to B). Sacrificing maneuverability for better armor is much less common, since speed and turns seem to resolve man-o-war battles more than armor. Weaponry is also up to the user, though most captains shy away from bombards, greek fire, and other fire-using and explosive devices due to the nature of the ship.

Wild Men-o-war: If cast adrift and left to themselves, men-o-war (and almost all elven craft) continue to grow, their crystalline wings curling in on themselves in ornate spirals. If such a ship is found in the wilds of space, and made functional, its MC would be E, and its AR 9 (older growths are more brittle). These poor ratings could be corrected by repairs to the ship equal to restoring half its hull points, done by individuals skilled in forestry or woodworking.

NEOGI DEATHSPIDER

Built By: Neogi
Used Primarily By: Neogi
Tonnage: 100 tons
Hull Points: 100
Crew: 30/100
Maneuver Class: E
Landing—Land: No
Landing—Water: No
Armor Rating: 5
Saves As: Crystal
Power Type: Major helm
Ship's Rating: As for helmsman

Standard Armament:
 1 heavy catapult
 Crew: 5
 1 heavy jettison
 Crew: 4
 4 heavy ballistas
 Crew: 4 each
 1 grappling ram
Cargo: 50 tons

Keel Length: 175'
Beam Length: 50'

Description

One of the largest of the standard ships of space, the deathspider is the pride and joy of the neogi, a deadly, xenophobic race of slavers and murderers. Its large size and distinctive shape make the deathspider easily recognizable in space. As a result, it is usually attacked on sight.

The neogi deathspider is divided into the command section and the cargo pits. The command section is in the forward half of the vessel and contains the bridge, the *spelljammer helm*, and the crew's quarters. The larger "abdomen" of the craft is used as weapons platform, cargo space, and slaves' quarters. The top half of the abdomen can slide back to reveal a small citadel perched on the lower

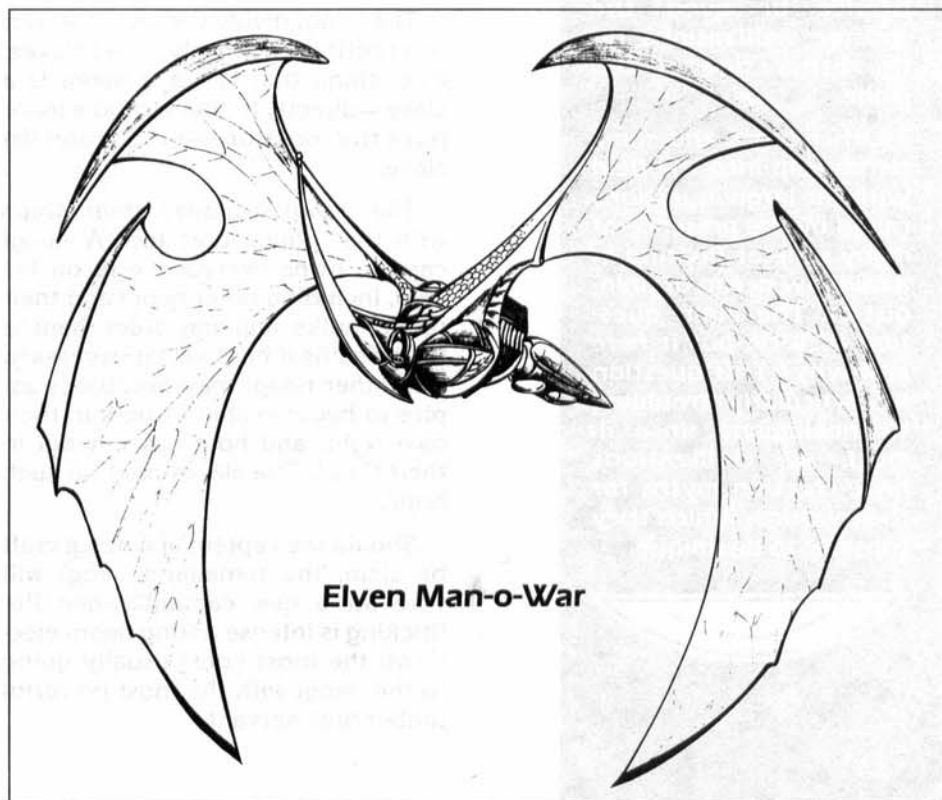

Elven Man-o-War



Notes on the Creation of the Universe

The discovery that there is a greater universe beyond the sky is a shock to most learned sages of the various known worlds, at least temporarily. Those used to a provincial view common to most groundlings often turn their backs on the stars, or refer to them as a minor sidelight compared to the wonders of the infinite planes of existence or even the strange civilizations on the other side of the globe.

Other sages and some clerics leap into the field with the larger questions raised by the presence of many spheres floating in a rainbow ocean of phlogiston. The main question is: *Who put it here and why?* This question is particularly troubling to theologians, since almost all civilizations have creation myths for their worlds, which they consider to be unique.



haunches. This structure is normally revealed only in battle situations, since the deathspider's weapons platforms are usually located there.

Crew

The neogi themselves are small creatures, but make use of a large number of umber hulk slaves. The umber hulks are personal bearers and soldiers under the neogi's direction. There are usually eight neogi on a standard craft (including their spelljamming mage), and the same number of umber hulks.

The remainder of the standard 30-man crew is made up of slaves, who toil in the depths of the ship, forestalling the day when they are served up as a main course for the crew. A standard crew on a deathspider takes up the same amount of air as 34 normal men, due to the presence of the large umber hulks and the small neogi.

The neogi divide the universe into two portions: themselves and slaves. Everything that is not a neogi is a slave—directly to them, or to a more powerful creature—or a *potential* slave.

The neogi organize their ships with that philosophy, too. A neogi captain owns everyone else on his ship, including other neogi and their umber hulks, and may order them to their deaths if he thinks it necessary. The other neogi may eventually aspire to become ship owners in their own right, and hold other neogi in their thrall. The slaves hold no such hope.

Should the captain of a neogi craft be slain, the remaining neogi will vote for a new captain/owner. Politicking is intense during neogi elections, the most votes usually going to the neogi with the most powerful umber hulk servant.

Ship Uses

Neogi Workhorse: The deathspider is the most common neogi ship, and serves as a cargo hauler, battle wagon, discovery ship, army transport, and slave trader. Since all deathspiders look identical to non-neogi eyes, it is not easy to determine if the neogi ship is fitted for exploring or actively hunting for slaves. As a result, all neogi ships are usually either attacked or evaded, whichever the defending ship is most capable of doing.

Carrier: On occasion, the abdomen of a deathspider is hollowed out and the ship used to carry a mindspider (see above). Such carriers are relatively new to known space, but carry the standard deathspider crew, as well as the mindspider crew. In this configuration, the captain/owner of the mindspider owns the deathspider that carries it, too.

Broodship: Those neogi fortunate enough to reach the end of their natural lifespans become Great Old Masters. These old neogi begin to swell and take in a large amount of food. The masters attain huge size, at which point the young neogi incubating within them devour their host and break through to form a new community.

When a neogi attains Great Old Master status, its ship is transformed into a broodship. The cargo pits are cleared to provide room for the master, and the ship—along with its allied ships—attempts to capture as many living slaves as possible to feed the Great Old Master.

A second shell is built over the Great Old Master's quarters to allow the main crystal shield to be pulled back for the deployment of weapons. A broodship is driven by its master's hunger and will attack anything, including other neogi ships, for slaves and food.

Other Configurations

Hulks: Deathspider hulks are available for sale from the neogi, but since they are not the best ship to be seen in, they are often stripped and used as floating bases for larger asteroid civilizations. In this configuration, the ship's legs and sails are removed, and the dome pulled back or removed entirely. Some asteroid civilizations put deathspider hulks in orbit around them as a warning to would-be pirates or raiders. The warning is meant to be read: This base can and has defended itself in the past.

Black Widow: Appearance and armament is standard for most neogi ships, and they do not engage in such human pursuits as stripping down for maneuverability or adding more ar-

mor. The neogi have built the black widow—a specialized version of the deathspider for use as an attack craft against long-time enemies. (Long-time enemy in neogi terms means one that has beaten them *once*.)

The black widow triples the number of ballistas and catapults used on the standard deathspider, and may add greek fire projectors and bombardards as well. The overloading such a large crew places on the ship's atmosphere does not bother the neogi; those slaves who survive the battle will be eaten on the return trip. The black widow is not used for trade, only punishment of the recalcitrant.

There are rumored to be up to a hundred of these black widows, but the most ever seen at any time is three, and in this case two attacked

each other over ownership of the fleet.

Mind Flayer Trader: The only races that have any real dealings with the paranoid neogi are the mysterious arcane and the mind flayers. The former have no known ships, and the latter have their own fleet of nautiloids. Still, several neogi deathspiders have been traded to mind flayers in exchange for large slave hauls (like the entire population of a small planetoid).

Unfortunately, the universal hatred of the neogi is such that mind flayer deathspiders are subject to immediate attack from most other ships. Mind flayer ships acquired from the neogi have their abdomendomes blackened to spare the mind flayers the light of the suns.

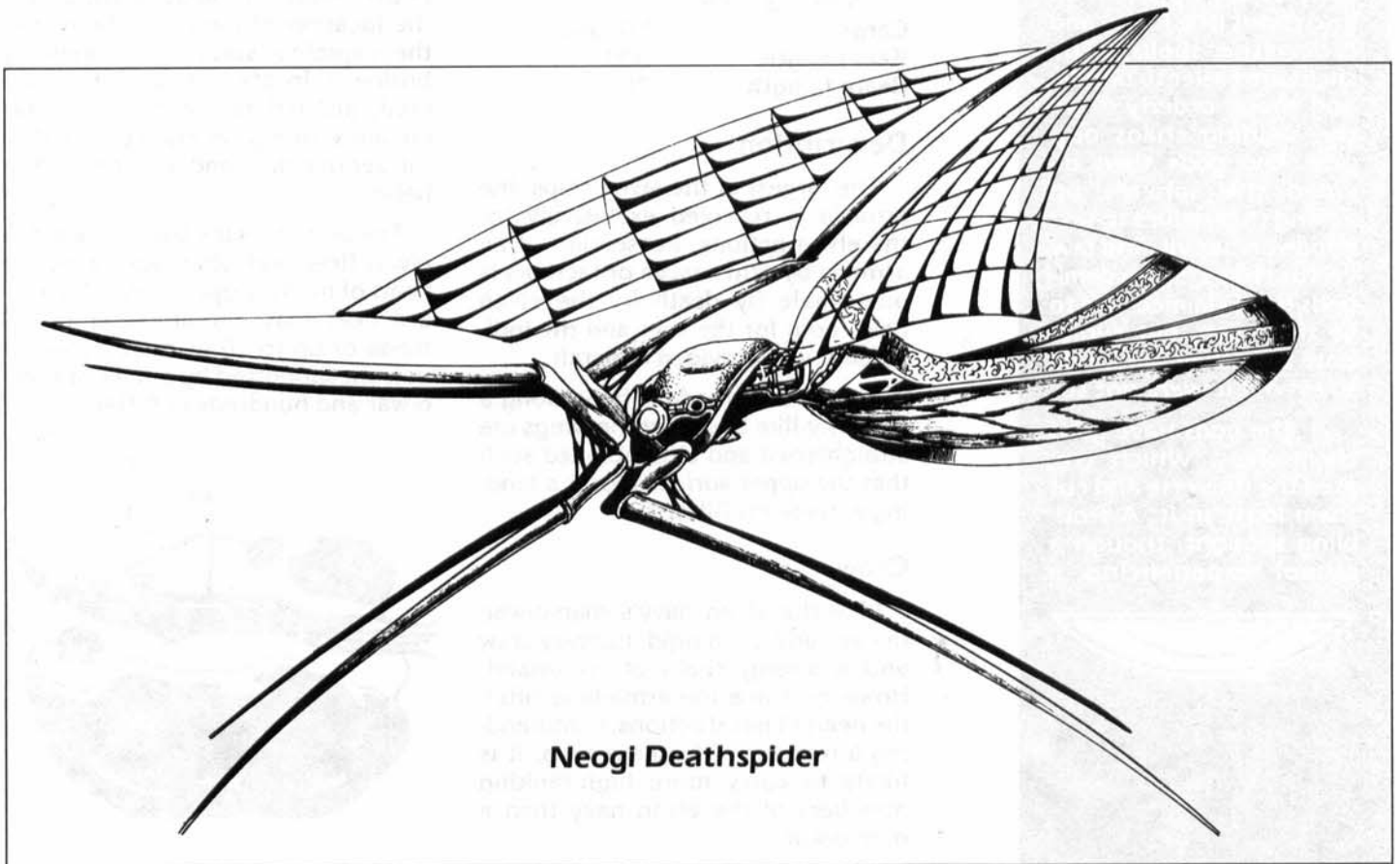

Neogi Deathspider



The main theories in regard to the shells, the Flow, and the gods are as follows:

1) The gods created the shells and the Flow to divide up their territories. Theologians love to advance this argument, though it places some limits on the powers they worship. Space is infinite, even for an omniscient deity, so they broke it up into chaos (the Flow) and order (the shells). The shells are easier to handle and more orderly than the swirling chaos outside. The gods then divided the spheres up among themselves to test good versus evil, and law versus chaos. Some demigods have claimed this to be the truth, but cynics note that they would do so even if it were not so.

2) The gods have gods themselves, which created the universe and cut them loose in it. A troubling thought, though a school experiencing a



ARMADA

Built By:	Elves
Used Primarily By:	Elves
Tonnage:	100 tons
Hull Points:	100
Crew:	40/100
Maneuver Class:	D
Landing—Land:	No
Landing—Water:	No
Armor Rating:	5
Saves As:	Ceramic
Power Type:	Major helm
Ship's Rating:	As for helmsman

Standard Armament:

6 heavy catapults	
Crew: 5 each	
6 heavy ballistas	
Crew: 4 each	
2 heavy jettisons	
Crew: 4 each	
3 bombards (optional)	
Crew: 3 each	
Cargo:	50 tons
Keel Length:	300'
Beam Length:	30'

Description

The largest of the elven ships, the armada is reserved exclusively for the elven nations. Possession of an armada by other races or factions is punishable by death by the elven navy, both for the user and the individuals who provided the craft.

The elven armada is built along a butterfly-like body, but the wings are straightened and strengthened such that the upper surfaces form a landing surface for flitters.

Crew

Like the elven navy's man-o-war, the armada has a rigid, military crew and a strong chain of command. However, since the armada is often the heart of naval actions, commanding a number of lesser vessels, it is likely to carry more high-ranking members of the elven navy than a man-o-war.

Ship Uses

Military: The chief use of the armada is as a base for large military actions against other factions, races, or planets. Their heavy firepower and their use of flitters makes them a dangerous weapon.

Each armada carries 40 flitters, five of which have spelljamming capacity. Those members of the crew who are not involved in the general movement and upkeep of the ship are assigned as flitter pilots and are exclusively charged with the maintenance and care of their ships. Flitters are used primarily as messengers and landing craft, or to disable enemy heavy weapon emplacements and seize an enemy's bridge.

The heart of the armada's operations is in the forward bridge, located in the "head" of the butterfly. This is the location of the major helm and the captain's station. An auxiliary bridge is located in the tail of the craft, just before the jettisons. This auxiliary bridge is equipped with a full set of charts and a second major helm.

The armada is the backbone of the elven fleet and often serves as the heart of military operations. A standard fleet may contain a single armada or up to 10 or more acting in unison, supported by a fleet of men-o-war and hundreds of flitters.

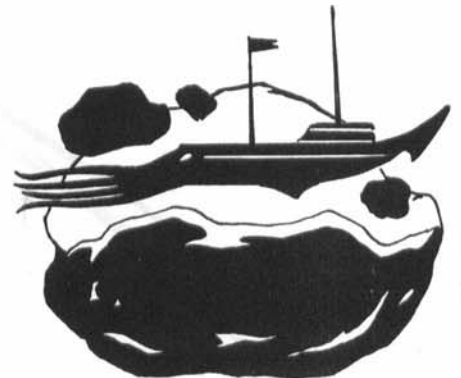

Other Configurations

Command Post: Several armadas carry large tower complexes along their backs, where the wings meet the body. These special armadas are the permanent residences of the fleet admirals and are used as command posts to coordinate large fleet actions. These small citadels (with a decidedly dwarven appearance) are used both as a military center and quarters for either entertaining other allies or negotiating with surrendering fleets.

These command posts can be jettisoned (without power of their own) if the armada is endangered. This has the same effect as a heavy jettison on pursuing ships. In one case, the jettisoned armada citadel was used to bombard an orc pirate base, with impressive fatalities.

Wild Armadas: Armadas are normally not abandoned, given the length of time it takes to grow one and their long lifespans. The elven nations would rather destroy this type of ship than let it fall into another race's hands. Should an abandoned, overgrown armada be found, its AR would be 9 and its MC would be E.

Dark Elf Crews: Rumors of drow operating in space continue, though incidents with spacefaring drow are few and far between, always seeming to occur "in another shell," or "a long time ago." One confirmed sighting is of a purplish armada with a huge dome where the command post would be based, giving the ship the appearance of a bloated hunchback.

This "gypsy moth" is said to be run by drow. The dome supposedly filters out light that is deadly to the drow. Several sages have discounted the sighting, noting that the drow are creatures of the deep earth, of the night, and would likely prefer to travel across dimensions than bother with spelljammer technology.

CITADEL

Built By:	Dwarves
Used Primarily By:	Dwarves
Tonnage:	300 tons
Hull Points:	300
Crew:	100/300
Maneuver Class:	E
Landing—Land:	No
Landing—Water:	No
Armor Rating:	0
Saves As:	Stone
Power Type:	Forge
Ship's Rating:	1-3
Standard Armament:	
3 heavy jettisons	
Crew: 4 each	
1-4 heavy catapults	
Crew: 5 each	
2-8 medium catapults	
Crew: 3 each	
3-12 light catapults	
Crew: 1 each	
Cargo:	150 tons
Keel Length:	250'
Beam Length:	200'

Description

The citadel is the smallest and most common of the mobile asteroids used by dwarves as a combination home and base. The largest citadel that may move by forge-powered helm is 700 tons. Those larger than this are still used by the dwarves, but have no mobility—they are simply left orbiting larger bodies. The 300-ton citadel is the smallest that a forge can power, and as a result, the most frequently encountered citadel in space.

Larger asteroids can hold more dwarves to man the forges, and, as a result, larger asteroids have higher ship's rating values. The larger a citadel is (up to the 700-ton maximum), the faster it is capable of moving, should it provide the space for the necessary forges.

The majority of a citadel's space is taken up by the forge and the living quarters for the crew. On a dwarven ship, everyone works, from the

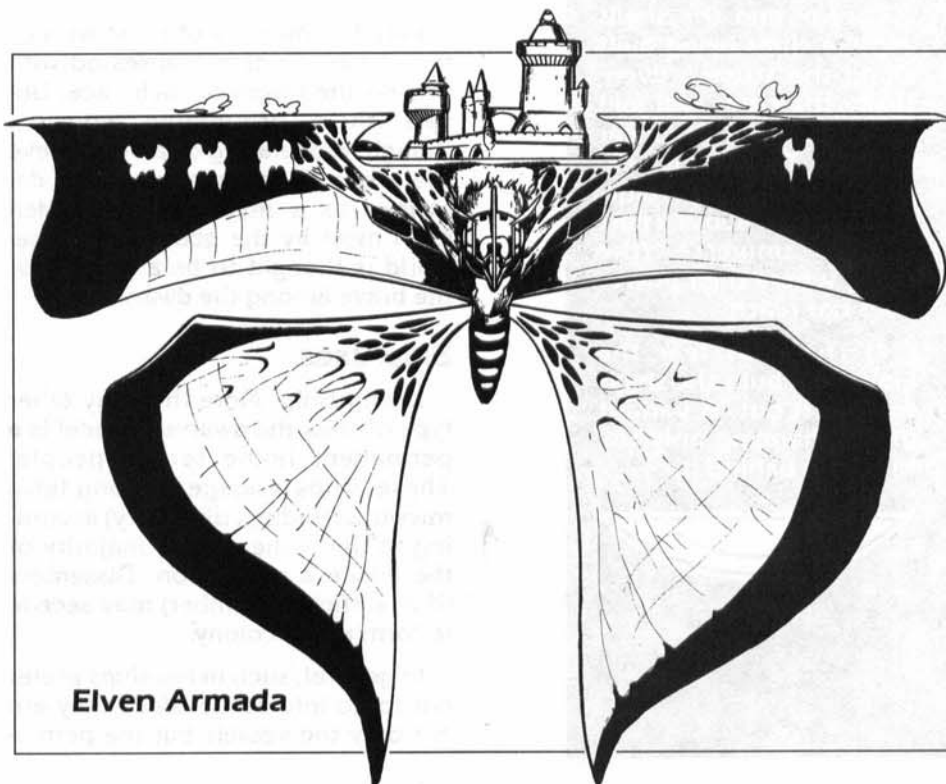

Elven Armada



rebirth in Realspace, which recently experienced their gods at close range and found them wanting. An unprovable theory, since it leads to the obvious line of reasoning: Well, if our gods have gods, why don't we have beings that think of us as gods?

3) The phlogiston is a naturally occurring object: The gods created the various shells in order to settle and domesticate it. The rainbow ocean is like a stream, and the shells are like cities being built along the stream. Eventually the cities will join and the stream disappear entirely. This would explain most godly reluctance to talk about a part of the universe (the Flow) where their power does not reach.

4) The gods fear the Flow, and built the shells to keep it out. A variant of #3, changing only the rationale behind it.



smallest toddler to the eldest gray-beard, creating the wondrous items that are a side product of the forges themselves.

Crew

The citadel's crew is organized like dwarven colonies on the ground. The captain is referred to as "the king within the mountain," and his bridge crew is called "the shining council." Since the majority of the crew works at the spelljamming engines themselves, there is no spelljammer or helmsman position. However, it is not uncommon for citadels to be equipped with smaller, spelljamming ships. These are used to carry messages or as landing craft.

Kings from different citadels treat each other with respect, and the first order of business for strange dwarven ships is to arrange a festival, where the kings compare notes, including travels, rich hauls, and, most importantly, genealogical information.

Like the dwarves of most worlds, the citadel kings are obsessed with finding the origin of their race. Unlike their groundling cousins, though, spacefaring dwarves believe there is a dwarven homeworld, described as a mythic place hidden from most by the gods. The homeworld is thought to be a reward for the brave among the dwarves.

Ship Uses

Living Ship: More than any other type of ship, the dwarven citadel is a permanent home for its people. These ships engage in long-term missions (trading, discovery) according to the wishes of the majority of the citadel's population. Dissenters (if of sufficient number) may secede to form a new colony.

In general, such living ships prefer not to go into battle, since they are not only the vessels but the perma-

nent homes of the dwarven kingdoms within. Citadels will fight to the best of their ability, using their large size to force opponents to crash into them, a maneuver that usually leaves the larger citadel the victor.

Jihad Ship: Dwarves in space are linked by blood and by faith, such that any attack on a dwarven ship may be taken as an attack on the entire dwarven race. Every so often a council of kings and priests of the combined dwarven pantheons will gather together and declare a crusade against a people, sphere, or race. An enemy is declared anathema, and their ships and people are attacked on sight. The neogi are currently the object of a dwarven jihad, though less religious races also attack the neogi on sight, more out of common sense than anything else.

Jihad ships have a large contingent of forge-tenders, but also a large number of well-armed and well-trained soldiers under the control of a fighter of at least 6th level. Jihad ships actively seek out enemy ships, board them, and slaughter those aboard to a man.

Jihad ships will often carry double the normal heavy weapons. In the case of a crusade against a ground-based enemy, a jihad ship will use asteroids and abandoned citadels as bombs. It will drop these massive objects on its opponents from the sky en masse. Citadels used as bombs are stripped of their forges and crews. This isn't common, though, as the loss of any citadel before its time is considered a great sign of dwarven sacrifice.

Abandoned Citadels: Dwarven spelljamming engines—forges—require a large amount of raw material to work properly. After a few years (about 2-8 years per 100 tons of the ship), the citadel's resources are exhausted and the people must find a new home. Once an asteroid of sufficient size is located, the forges are

packed up and moved to their new home. Only then does construction begin on the new base.

After one month per 100 tons of asteroid, the new citadel has sufficient space to support the new population. Then the old home is abandoned. Abandoned citadels are often used by other spaceborne races as lairs, much like the way that hermit crabs appropriate the shells of other organisms.

Former citadels are the homes of pirates and monsters, who journey out into space looking for goods and meals. Given the size of the largest citadels, the multiple monsters and groups can hold possession of parts of the ship, working with or against each other. Since citadels are not always stripped completely, they often attract adventurers like a magnet.

If the citadel's population is sufficiently large at the time of transfer, more than one asteroid may be selected. The ship's forges are split between the two new citadels, allowing each side to pursue its own course. Similarly, dying kingdoms, torn by war or disease, may be swept up by newer groups in larger citadels, leaving abandoned ships that are not fully exploited.

Other Configurations

Larger Citadels: The stats above are for the smallest of the citadels commonly found in fantasy space. Ships of up to 700 tons can often be found, with similar increases in crew, weapons, and capacity of the forges. Note that while a ship of 700 tons can reach SR 7, such elaborate forges are rare and difficult to maintain.

In general:

For every 1 additional ton, 1 hull point and one additional human-sized figure can be sustained on the citadel.

For every 3 additional tons, another crew member must be added to aid with the forges.

For every 100 additional tons, the forge can be expanded, increasing the ship's rating by 1.

For every 30 tons, another heavy weapon can be added without interfering with cargo and/or living space.

Gnomish Citadels: Gnomish citadels are to dwarven citadels what gnomish clippers are to normal ships—a bad satire. Abandoned dwarven citadels are often taken over by gnomes, who simulate the effects of the forges with their various gizmos. In reality, their gizmos add nothing to the final output of the system, causing the ship to drift as aimlessly

as when it was abandoned. Gnomes, being gnomes, usually come up with careful explanations that detail why they wanted to go in the direction they are drifting anyway.

There are gnomes who have gotten hold of operating forges in a citadel. While spectacular when they are working, these ships are often short-lived due to the gnomish tendency to tinker.

SPELLJAMMER

Built By:	Unknown
Used Primarily By:	Unknown
Tonnage:	1½ million tons (est)
Hull Points:	1½ million
Crew:	1(?)5,240(?)
Maneuver Class:	B

Dwarven Citadel

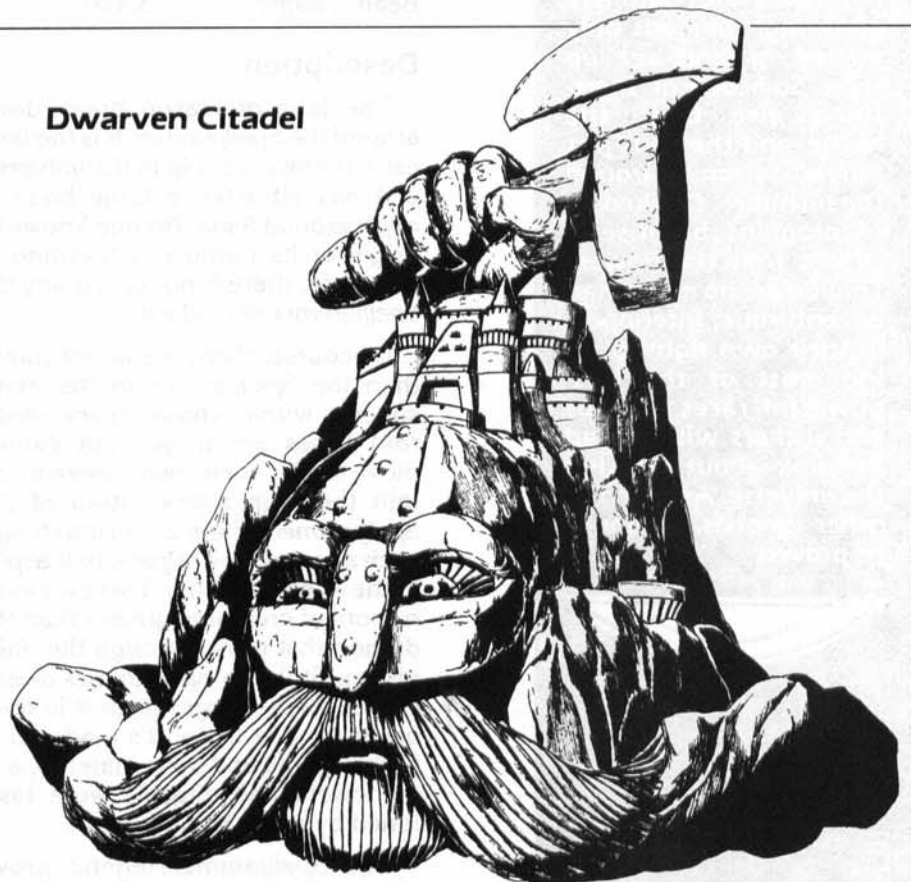



5) The gods fear men and the other sentient beings, and built the shells to keep them IN. Another variant of #3, changing the rationale. If this was their purpose, they seem to have failed miserably.

6) The phlogiston and the shells are naturally occurring; the gods only moved in and set up shop. Someone or something else built the house, and the gods just arrived to move around the furniture. Disliked by theologians because it implies that the Powers That Be are no more than adventurous interlopers in their own right, playing most of the less-powerful races as saps and suckers with a load of bunk about creating the universe. As with the other theories, it cannot be proved.



Landing—Land:	No
Landing—Water:	No
Armor Rating:	5
Saves As:	20th-level wizard
Power Type:	Unknown
Ship's Rating:	8
Standard Armament: (estimated)	
30 heavy catapults	
Crew: 5 each	
15 light catapults	
Crew: 1 each	
40 heavy ballistas	
Crew: 4 each	
20 light ballistas	
Crew: 1 each	
15 heavy jettisons	
Crew: 4 each	
20 bombard (rumored only)	
Crew: 3 each	
Cargo:	Unlimited
Keel Length:	1,575'
Beam Length:	3,100'

Description

The laws of reason break down around the *Spelljammer*. It is the largest self-powered ship in the universe, and has attracted a large body of myth around itself. No one knows its origin or its purpose. According to the sages, there is no reason why the *Spelljammer* should exist.

Of course, there are larger things than the *Spelljammer* in the many spheres within known space. Asteroid bases are larger, but cannot move under their own power or attain the high ship's rating of the *Spelljammer*. There are living things, such as celestial dragons, that aspire to the size of this ship. There are even rumors of creatures greater than the dragon that move through the phlogiston. Still, the *Spelljammer* dwarfs any of these things, since it is obviously a made thing. It's made up of both organic and inert material, and its towers and citadels were fashioned by some being's hands.

The *Spelljammer* legend grows with each passing year, fueled by ru-

mor and gossip. It is said that a single man can pilot the ship, that at the *Spelljammer's* heart rests a device like a *crown of stars* that allows the user to command the ship. It is said the ship is the plaything of an elder god, a toy sent out to sow discord in the universe. Some say the *Spelljammer* is a test set up by the gods of good (alternately, by the gods of evil), as something that may be attained at some time by their faithful.

The *Spelljammer* has been sighted in many spheres, and attempts have been made to land on it. Often battles between conflicting factions over possession of the *Spelljammer* ensue when the ship appears in a system. Reports of the *Spelljammer's* destruction have surfaced several times in myth, but it has always reappeared after a time. There may be multiple *Spelljammers*, but no man has seen more than one at the same time.

The *Spelljammer's* motive force is a mystery. Nothing that big should be able to move that fast. Accounts of speed do not seem to consider the level or abilities of its captain, which breaks the rules for spelljamming. The ship is an enigma.

The ship's weaponry is believed to have been accumulated over a period of centuries as various legendary individuals and nations have taken control of the *Spelljammer*. In one tale, the ship was owned by the illithids. In another story it was the site of the last conference of beholders. In a third, it was the death machine of the unhuman nations. Yet each time it has reappeared, unmanned and uncontrolled.

In addition to the items listed, the *Spelljammer* contains the debris of half a hundred conquerors, in some cases their ships and helms, as well as their treasure. Wise (or short-sighted) adventurers have often landed on the *Spelljammer* to take that which others have brought there, as opposed to trying to take control of the ship.

The *Spelljammer* is rumored to be filled with a variety of monsters and creations. Whether these creatures are natives to the ship or denizens from other lands taken by the ship is unknown.

Random Spelljammer Helms

Many of the ships of space are powered by either major or minor *spelljammer helms*. The question of which helm is being used is important to the adventurers, both in determining how powerful their enemy is and what the chance is that they can "lift" the helm after an encounter.

When a "major or minor helm" is noted in the description of a ship, use this table to determine which type of helm the ship has. Roll 1d10:

Die Roll Result

1-7	Minor Helm
8-9	Major Helm
0	Other, roll again:
1-2	Gnomish Helm
3	<i>Crown of Stars</i>
4-8	Furnace
9	Artifurnace
0	Lifejammer

If a major or minor helm is called for, roll for the level of the spellcaster using the helm. The level of the spelljamming mage or cleric determines how fast the ship can move tactically.

The DM should always use his own judgment with these rolls: a heavy elven armada will not be helmed (usually) by a 1st-level mage, nor will a clunker tradesman be helmed by a 20th-level evil high priest. Roll 1d10:

Roll Type of helmsman

1-6	Wizard (or subclass)
7-10	Priest (or subclass)

Minor Helms

%Roll	Level of Helmsman	SR
01-07	1	1
08-14	2	1
15-21	3	1
22-28	4	1
29-35	5	1
36-42	6	2
43-48	7	2
49-54	8	2
55-60	9	3
61-65	10	3
66-70	11	3
71-74	12	4
75-78	13	4
79-83	14	4
84-88	15	5
89-92	16	5
93-95	17	5
96-97	18	6
98-99	19	6
00	20	6

Major Helms

%Roll	Level of Helmsman	SR
01-07	1	1
08-14	2	1
15-21	3	1
22-28	4	2
29-35	5	2
36-42	6	3
43-48	7	3
49-54	8	4
55-60	9	4
61-65	10	5
66-70	11	5
71-74	12	6
75-78	13	6
79-83	14	7
84-88	15	7
89-92	16	8
93-95	17	8
96-97	18	9
98-99	19	9
00	20	10

Modifiers:

Ship is at least 20 tons:

Raise helmsman's level by 1

Ship is at least 60 tons:

Raise helmsman's level by 2

Ship is elven naval vessel:

Raise helmsman's level by 1

Ship is tradesman:

Lower helmsman's level by 1

The level of the spelljamming wizard or priest cannot be raised above 20 or lowered below 1. Racial restrictions apply to particular ships and spelljamming wizards.

Special Cases

Gnomish Helms: Roll for the level of the user (for those that work) as a minor helm.

Crown of Stars: Roll for spelljammer as a minor helm, but allow the user full mobility on the ship.

Furnaces: These devices have an SR of 2, which may be boosted to 3 under certain circumstances.

Artifurnaces: Have an SR of 5, but come equipped with powerful and dangerous magical artifacts. Given that there are a huge number of gods, wizards, extraplanar beings, and heroes in the many worlds, the fact that the groundlings are not hip deep in artifacts may be ascribed to the fact that someone has come up with a use for them—artifurnaces.

Lifejammers: SR is based on the hit dice of the victim.

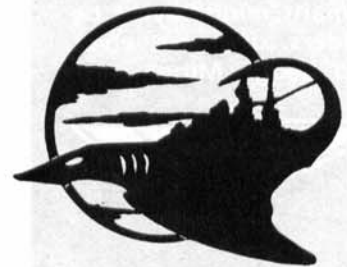



Major and Minor Races

There is a false division of sentient races when it comes to space travel. Races are sometimes referred to as "major" or "minor." The difference is unimportant, but reflects the nature of many spacegoing races, such that even sages refer to races by major and minor status.

A major spacefaring race is one which has a definite presence in space in the form of bases and/or colonies, a large population in space, has the use of a spelljamming helm or similar device for rapid travel among the stars, and has designed ships for its race. Races and species which have not done so are lumped together as "minor races."

Major races in the Known Spheres include humans, mind flayers, beholders, dwarves, elves, and neogi. Minor races



Life in Space

In addition to the new creatures listed in this book, many creatures common to the Known Worlds are found in space. This section refers to the various civilizations, organizations, and races which have gone off-world.

The size of space defeats many an empire builder in that there is a lot to control in a multiplanet empire. While there are worlds ruled by a single authority, most worlds are a combination of states and quasi-states. The situation in space is similar—many rulers over a shifting terrain of space. Who rules a particular chunk of space often depends on whose flags are flying from the masts of the ships you encounter.

Humans

As on many of the worlds of the SPELLJAMMER™ universe, the human population is the most numerous in space. Some attribute this to their rapid reproductive rate, others to their superior intelligence, others still to their adaptability with new magics, and still others to the fact that they have the larger number of diverse gods rooting for them and helping them. Whatever the situation, the humans are the dominant species on most worlds, and the most populous species in space. In space, humanity is not a majority species—there is no species with a clear majority save in selective areas—but it is the most numerous of the hodge-podge of various races that exist in the SPELLJAMMER universe.

Ninety percent of the humans in space are free agents, operating for no master or for a temporary master on a particular job. In a change from the feudal attitudes of many groundling nations, the chain of command is much looser and the caste system of peasant to gentleman to noble less

prevalent. There are still princes and peasantry, but the interaction between the two is more relaxed.

It should be noted that while only an organized human state can put a strong presence into space, it is those with a more adaptable social system that survive best there. This may explain why many organized nations such as Cormyr, Kozakura, and Furyondy do not have an organized space presence.

This is not to say that adventurers from these lands do not reach into space. Many of the humankind in space are adventurers or descendants of adventurers. Once taken from their homeworlds, most of these adventurers find spaceborn life to their liking, and do not return. Those who do return add more tales to their own legendary status. Most of the groundling populace, if aware of life in space to begin with, consider it something far removed from their lives, like the nature of the myriad planes of existence. Stuff for sages and adventurers, of course, but rarely something that has effect on their everyday life.

There are exceptions where groundling and space voyager come into contact and conflict directly. Crashes are all too common in known space, and new adventurers will often gain their first spelljamming helm from the wreckage of some ancient disaster, now buried by the sands of some great desert. There are more social contacts as well. In the city of Waterdeep in the Realms, there is a record of a merchant in a flying ship landing in the harbor and offering smoke powder at a reasonable price. The sudden detonation of that powder in the harbor ended the transaction and the ship, though the helm survived and was returned by the sea elves of the harbor to its rightful owner. An investigation by Lord Khelben and the Lords of Waterdeep found no foul play in-

volved in the accidental detonation, but since then, no one has tried bulk importing of smoke powder into the Realms.

In space, humans settle in communities ranging from lone hermitages to huge asteroid cities. These cities are usually the remains of a dwarven citadel or radiant dragon lair, but the humans tend to build up along the surface, in the manner of their groundling ancestors. The accessibility of the human civilizations to other races make these communal cities a center of activity for many races.

Humans, then, given their numbers and their willingness to deal with other races, provide the common ground in space. It is in their warrens where an adventurer will often find other races, major and minor, hanging about, looking to advance their own ends.

An example of such a human settlement is the Rock of Bral, an asteroid citadel under the nominal rulership of a prince. In reality, the loyalty of the people of the Rock goes to the individual who can offer protection, safety, and regular meals.

On a smaller scale than the asteroid cities, there are the human ships. These crews vary from place to place, but form the same sort of family and organization. Some crews are put together for a single voyage, while others operate over long periods of time, their crew members forming their own community.

Of the ten percent of spaceborne humans who *do* have a particular allegiance, their lords are often more ideas and ideals than individuals. Even given the quickness of space travel, the idea of loyalty to some distant emperor or general quickly breaks down. Among the factions currently common in The Known Spheres are:

Faith: Polygot, pantheistic, and Ptah are all major faiths among humans, and many follow the sect and its directives. Polygots and pantheists tend to be relatively open toward the attitudes of rival religions, although you will see small holy wars erupt from two related pantheistic faiths on matters of the sect. In general, the local pantheistic or polygot church sets the rules for its region of space.

Followers of Ptah tend to be a little more pressing. In their grey robes trimmed with scarlet they are found throughout the SPELLJAMMER™ universe preaching the superiority of their god. Despite the fact that Ptah originates from an "Egyptian" mythos, most of its followers in space are spaceborne and tend to look down on groundlings as well. They are fanatical in their zeal to convert people to the way of Ptah, and use as an argument that his clerical spells work in *all* the spheres. Ptah priests tend to equate Ptah with whatever ruling god they happen to encounter to show that Ptah is the true ruler of the pantheon; Odin is considered by them to be an avatar or disguise of Ptah, as are Zeus and Ao. This is usually news (and disturbing news at that) to local followers of these gods, such that Ptah worshippers are not well loved.

The followers of the Path and the Way have a different problem. Since they profess a central universal idea but encourage originality in making that idea a reality, there are a number of smaller schools of thought, all professing to have a different idea of the path to the truth. Among the groundling nations, these smaller schools have small geographical territories where they impose their thinking. In space, there is a constant (and often violent) debate between contesting schools, which at times can be compared with the beholder civil wars. A follower of the Path and the Way is recommended to be well armed and

well trained in space, not to avoid persecution from other faiths, but from challenges from other members of his own.

Military Brotherhoods: Many warriors, and some rogues and wizards as well, owe their fealty to a military brotherhood, an organization of similarly minded and aligned individuals dedicated to a particular cause. Some military brotherhoods aspire toward paladinhood and number paladins among their ranks, while others are little more than mercenary units for hire by the highest bidder. Several of the main military brotherhoods are:

The Company of the Chalice: Primarily lawful and good in organization, they are ruled by a Grand Knight appointed by the membership. This Grand Knight is always a paladin, and charged with organizing and leading attacks against the evil infidel wherever he may be found. The evil infidel may be determined by the Grand Knight, but excesses may be corrected by the Grand Knights of other spheres. The current vogue in evil infidels are the neogi, who hate the Company and will torture and slay members that they find, as well as offer hefty rewards for the local Grand Knight. The symbol of the Company is a golden chalice.

The Pragmatic Order of Thought: Called "the Pots" by its detractors, this is a loose organization of good-neutral and good-chaotic individuals founded on the idea that all men deserve liberty of thought and freedom, that slavery is an abomination, and that travel and trade should be unrestricted. Hampered by the fact they are disorganized, they normally run safe houses and hostels in major cities and help in escape attempts. Their symbol is a torch held aloft.

The Long Fangs: A military brotherhood dedicated to destruction and chaos, it gathers mercenary units for



include halflings, giff, centaurs, kender, giants, and dragons.

Orcs and their kindred were once a major race but with the virtual elimination of their navies are now considered a minor race.

Gnomes are generally considered a minor race despite the fact that they have space travel because the majority of the race would never have reached the stars without the tinker gnomes, and even at that, gnomish helms are a questionable lot at best.

The arcane are considered a major race since they supply so many others with spelljamming helms and have done so for as long as memory serves. They do not have any known colonies in space (a usual requirement), but no one questions their status.



evil masters. Its hiring policies and quality of troops are erratic, and may include undead and other monsters. Rulership is by the strongest, such that there are often internal battles between Long Fang members for dominion. Lordship of the Long Fangs usually extends to only those individuals within the swing of a club.

The Tenth Pit: This group is small but very well organized and dangerous. It turns away most of its petitioners, taking only those with the most talent and the blackest hearts. The organization's stated goal is to extend order into the spheres and provide guaranteed safety between them, but the unstated follow-up is that the Tenth Pit will be set in charge. There are stories of Tenth Pit agents working among evil groundling organizations such as the Draconians of Krynn and the Zhentarim, and their dealings with powerful extradimensional beings of lawful and evil alignment. Their symbol is an X, a groundling symbol for 10.

The Trading Company: What the Trading Company trades is manpower and weapons to those who need it. Staunchly neutral, except for refusing to supply men to both sides of a conflict, the Trading Company commonly organizes expeditions to wars and other hot spots to open negotiations. Trading Company mercenaries are common in space, and some are found in groundling wars, where they are legendary as "soldiers from strange far-off lands with odd accents and powerful weapons." The Trading Company takes all those who are interested, and trusts that the daily deaths of war will weed out the undesirable and the unworthy. Their symbol is an infinity sign within a crystal sphere.

Admittance to a military brotherhood varies with the location and the organization. The Company of the Chalice is heavy on pomp and circumstance and charges to action in a

knightly fashion. The Tenth Pit requires a program of training, usually ending in a battle to the death with a creature or fellow knight of equal armor class and double hit points. The Trading Company requires the ability to write one's name on a list.

The advantages of a military brotherhood are several. Most military brothers recognize the symbol of their brotherhood and will act to help fellow members. Similarly, a member is obligated to aid another member (or as the Long Fangs say—If you stab a fellow member in the back, make sure there are no clues left behind). Military orders have outposts (overt or hidden) on many asteroid cities and other locations. Here a character may rest at moderate cost and be fed, and depending on the situation, charter the services of other members or a ship. Similarly, a member of a military order may suddenly find himself confronted by a Grand Knight with a mission to be carried out. Such missions can be refused, but usually at the cost of membership (and occasionally one's life).

Military brotherhoods number a few hundred or thousand per sphere, and can usually manage a dozen hulls per sphere. The strength depends on the powers, and whether the order is recognized or hunted by local officials.

Schools of Magic: These are not organizations in the same sense as military brotherhoods and clerical faiths, but rather loose gatherings of mages who follow the same general types of magic. Their followings transcend alignment, since magic is a constant throughout the spheres: A conjuration spell in one is a conjuration spell in another.

Schools of magic are a training ground for specialist wizards, and there are rarely more than one or two per city. In some large metropolises of space, the various schools have banded together to form a university,

which promotes studies of all the magics. These organizations are supported by donations from established wizards and sometimes taxation on magic, and are powerful enough to buy hulls and helms and send explorers out looking for new items and magic spells.

Wizards of the same school are obliged to be courteous, though they may test, needle, wheedle and deal within that limit as they see fit. There is little competition between the schools, as opposed to that within the schools of the Path and the Way.

The schools live for knowledge, in particular magical knowledge. Each school among the myriad worlds is researching space-related spells, the most common of which are noted in the *Concordance*. They are also seeking a method of creating helms without the aid of the arcane. While the arcane do not approve of this idea, they have yet to take any overt steps against it.

Rogues' Galleries: Even more loose than the schools of magic is the organization of the galleries, the chief organizations of bards and thieves. Set up hundreds of years ago by enterprising adventurers, and supported now and again by new blood, these galleries were intended to function as interplanetary thieves' guilds, where things could be ordered and sold with few damning questions.

The result is that the rogues' gallery is a miniature clearing house of local thievery in a small area, such as a single planet or chunk of space. The gallery masters (similar to the masters of a thieves' guild) are possessive about their territory, the men they control directly, and the loot they bring in. As a result, they do not trust one another very much, and this distrust precludes cooperation.

Being a member of a rogues' gallery in one sphere carries very little

weight in another sphere. At best, a messenger may be dispatched to confirm one's identity if the two galleries are friendly, but more often than not the newcomer is viewed as an outsider and potential spy. By common law, a thief may always find safe haven at a gallery, but no law precludes that gallery turning him in as soon as he steps outside.

Rogues' galleries vary in power according to their location, and vary in their membership as well. Those in illithid-heavy areas will have mind flayer members, while those operating in dracon-populated spheres will have those dragonish centaurs as guards. The most powerful galleries can fund their own expeditions to recover magic and artifacts, and in their ships prefer furnaces and art-furnaces over trusting wizards and priests to run their ships.

The symbols of the various rogues' galleries are as different as the various adventuring companies.

Adventuring Companies: One groundling custom that translates well into spacial terms is the idea of the adventuring company. These companies are more plastic in their membership than any of the orders, faiths, schools, and galleries, and include members of all classes and alignments. Many who claim to be free men still honor the commitments of an old group of fellow adventurers. An adventuring company is usually never larger than a single group or ship, and its membership varies according to the situation and deaths in the group.

Adventuring companies have the advantage of creating their own tales around themselves and attaining legendary status. Groups known for their ability are The Band of Seven Thieves, The Starhunters, and The Lost. The difficulty in being a member of a legendary band, or taking the name of such a band, is that the adventurer will have to

prove himself up to the legendary status of his predecessors, which often becomes more impressive with each telling.

Trading Companies: There are a large number of trading organizations in space, ranging from a single tradesman to a large coster with a fleet of well-furnished ships and warships to protect themselves. Ninety percent of tradesmen are independents, free traders peddling a variety of wares from planet to planet. Exceptionally large trading companies include:

The Smiths' Coster—Specializing in weapons and armor, in particular weapons not available in the area due to low technology or scarcity. It was a representative of the Smiths' Coster who attempted to bring gunpowder to Waterdeep.

Clevar's Gimcracks & Sundries—Specializing in the odd, bizarre, and small package trade (meaning smuggling), Clevar's is noted for hiring adventuring companies for particular jobs. They pay well, but according to those who have gone on such missions, get their money's worth for the danger they attract.

Gaspar Reclamations—A young organization led by an immensely fat mage named Gaspar, it specializes in the location and recovery of magical items and artifacts. Gaspar often works with the schools of magic on commission work, and interesting discoveries are turned over to them, in exchange for a finder's fee.

The Sindiath Line—A trading group that specializes in transportation and boats for hire. Adventurers without a ship may find the Sindiath Line useful, either as passengers or as crewmen. Their flag is a gold S on a white field.

Chainmen—As the name indicates, this is a human slavers' organization, operating among evil nations both on the ground and in space. If



The big difference between major and minor races is generally bragging rights and the distinction of classification. The fact that some Sembian farmer who finds a helm in his field can be considered a member of a major race and a giff mercenary who has fought in seven separate spheres is a minor race is an indication of the inequity of the labeling.

For the most part, the labeling is used by major races to talk down to minor races and by minor races as a reminder that they are still unique in a new world (a centaur appearing in a bar in the asteroids still can stop conversation, while an elf won't).



you want to “lose” a defeated enemy, you can sell him to the Chainmen. Within a month the victim will be toiling for some foreign prince who asks no questions, or on a completely different world. The Chainmen Traders are hated and feared in turn; however, they do not take slaves where they dock (otherwise the local authorities would be on them like a cheap suit of armor).

Other Groups: Two other human groups should be mentioned, as they often work against each other in their machinations. They do not appeal to a particular character type, but instead operate on higher (or lower) ideals: The Seekers and the Xenos.

The Seekers are a group dedicated to knowledge, and want to stay on good terms with sages both in space and on the ground. They look for answers to questions such as what is the home planet of the giff, how the arcane fill their orders so quickly, and why crystal shells are spherical. Often these arguments bog down due to lack of evidence, but the Seekers look to adventurers to gather interesting information, which they then make available to sages and seers seeking advice.

The Seekers are said to have their own secret, a planet or shell filled with the knowledge they have gathered. The Seekers admit or deny the existence of this world, called Compendium, depending on the situation, but none have found it yet.

The Seekers will deal with most sentient races, provided that these sentients deal with each other fairly. They have no dealing with the neogi, for example, but will work with beholders, illithids, and humanoid races to gather information.

The symbol of the Seekers is an eye with a sword behind it, and they are known in more feudal spheres as the Company of the Orb and Sword.

A rival organization is the Xenos, who are made up entirely of humans with a rabid hatred of the other races of space. The liberal Xenos believe that the other races of space should be enslaved, while the more traditionalist members believe that complete eradication is called for.

The number of Xenos is unknown, in part because they remain mostly underground in quasi-humanoid societies. Their active numbers are small, but they enjoy the tacit support of many humans who have had their fill of drunken dwarves, aloof elves, and temperamental beholders. Finding an active Xeno is easy, but imprisoning one is difficult—they have a habit of escaping when under human guards.

The Xenos act to sabotage and destroy nonhuman works and ideals. This may range from demolishing the forge of a dwarven vessel to putting two warring beholder factions on each other in hopes they wipe each other out. To further their ends they put out false, misleading, or slanted information, which is how they become the enemies of the Seekers. The Xenos muddy the waters to the degree that no truth can be seen, and think nothing of destroying artifacts and rewriting histories to fit their own purposes. To a Xeno, the elves did not suddenly disappear from the Realms for a home in the west—they called down the gods in the Time of Troubles and then got out when they realized they had endangered themselves. Such foolish lying is the heart of Xeno thought—if you lie loudly enough and often enough, it will taint the truth.

Diehard Xenos are often pirates with purely human crews and spell-jamming helms stolen from another race (being unwilling to deal with the arcane). They are chaotic reavers and will gladly turn traitor to an ally if he shows weakness to nonhuman

life. Xenos tend to be armed and armored to the teeth, which is not surprising, given their approach to life.

The Elven Armadas

Elven life in space is much more mobile and organized than human settlements. The elves of space consider themselves to be the link between the scattered elven groundling settlements across the spheres. They take an active attitude toward large elven nations, and a paternal attitude toward those smaller tribes that are scattered in densely populated human continents. The Elven Imperial Navy regularly makes contact at Evermeet, in the Realms, and, before its destruction, also landed in the nation of Silvanesti on Krynn. The ideas and techniques shared by the space elves may have helped both those nations in their defenses and protection from encroaching human and nonhuman invaders.

The heart of this linkage between disparate elves is the elven fleet, an uncountable multitude of ships, ranging from the huge armada through the men-o-war to the small, personal flitters. With them the elves maintain regular contact (yearly or so) with the major elven capitals on the ground and in space.

The elven fleets are highly organized, with the full rulership of the fleet controlled by the Council of Admirals, headed by a Grand Admiral. These august leaders, elders even in elven years, rule from a hidden base called Lionheart, whose location is secret and is changed every few years to avoid surprise attacks.

Local fleets within spheres are under the control of admirals, though if the number of elven ships is low (there are no elves naturally in the system), a single ship with a captain will suffice to maintain the "elven presence" in a system.

The Council of Admirals recognizes the sovereignty of the various elven kings, queens, and princes littering half a hundred planets within their patrol area. An order from one of these heads is enough to mobilize elven naval forces. Balancing this is the council's knowledge of the area and the dangers of interfering overly in groundling politics. As long as the orders are of the type that show self-defense, they are passed through; otherwise, the fleets are strangely wrapped up in other matters and the orders lost. The elven rulers on the ground have learned not to depend overly on the Imperial Fleets.

The fleets have acted across the board against multi-sphere menaces that they have deemed dangerous to elvenkind. The last such war was in the lifetime of the eldest of the Council of Admirals, the Unhuman War. In it, a massed group of elven armadas, men-o-war, and pyrotechnic firewind-modified flitters destroyed half the existing orcish and nonhuman fleets in the Known Worlds, and dispersed the remainder to be hunted down later. The largest battle occurred near Kule in the Greyspace system, where over 100 elven ships crushed a 50-ship orcish fleet, but the rout was repeated in every known sphere.

The events leading up to the Unhuman War were typically elvish—long-winded debates of several human lifetimes, culminating in a single decision that, once made, was irrevocable. Currently the elven admirals are supposedly debating the danger of the neogi to elven nations. That debate is as yet unresolved.

That the elven nations use their spaceborne fleets in a coordinated link with other elven nations on other planets is unsurprising. Unlike humans, the elves' grasp of higher levels of magic, including plane-crossing techniques, is tenuous at best. As a result, space travel is their

best link, and serves them well in dealing with other like-minded elven leaders. Usually within a groundling kingdom there is an elven diplomat charged with space dealings, though he will often carry the title of court astrologer as well.

The elven fleets come to the aid of the larger nations and expect those nations to in turn aid the smaller, scattered tribes of elvendom. A local outpost of elves has likely never heard of the Imperial Fleets and could not care less. The elven fleets make an important part of keeping their contact with the groundlings (especially *human* groundlings) to a minimum. They are particularly interested in keeping elven magical abilities, such as spelljamming helms, out of non-elven hands, and will destroy an elven ship rather than see it taken over by non-elves.

Due to their triumphs in the Unhuman War and their powerful fleets, the elves of space tend to be a little pushy and presumptuous in dealing with others. Humans and the other races are short-lived and unable to take the long, protective view that elves are capable of. While not the "Guardsmen of the Spheres," elven forces have a tendency to stick their noses in areas where they are neither wanted or needed. Directing them (politely) to mind their own business may result in an apology and withdrawal, or in a sky full of men-o-war.

Elven communications are miserable in space; some elven ships disappear every year without anyone noticing. The elves are willing to sustain a certain number of such losses in standard patrolling, and write off such ships as "overdue" as opposed to being lost.

The space elves maintain their ships well, and according to the regulations handed down by the Council of Admirals. In general, the Council will punish lightly those who flaunt their rules and succeed, but woe to



The Adventurer Who Fell to Earth

One of the most often pointed-at "glitches" of the AD&D® rules is the fact that a high-level fighter loaded with hit points can pitch himself off a mountainside, absorb the damage, and walk into battle from there. With the possibility of characters falling from much farther in space (like many, many miles up), this becomes even more humorous.

Of course, this is fantasy, and such things *can* happen.

There are two dangers to a character making an involuntary reentry into an atmosphere. First is heat. For every round of uncontrolled falling after maximum damage (20d6) has been reached, the character takes 1-4 points of heat damage. This number doubles each turn, such that at the end of the third turn, the character is taking 4d4



the individual who disobeys their strict commandments about weapons, crews, and inspections and then fails in a mission.

The elven Imperial Fleet maintains an embassy in most human settlements, which is a hub of elven activities and a settling house for complaints by or against elves. As with most bureaucracies, the embassies tend to be inefficient, a matter made worse by the fact that most elven bureaucrats consider humans to be a waste of time.

The elves do maintain bases in space apart from humans. These are usually old armada-style ships linked together and permitted to overgrow into a thick protective battlement. The ships are pulled into a circular shape, such that they retain their gravity planes, and appear as a ring of butterflies linked at the wings. The living ships of the elves are planted, and the crops provide both food and air for the settlement. Such "rings" are usually kept hidden from humans and serve as bases of large elven activities. One of the largest rings is called Lionheart, and is the base for the Council of Admirals.

All types of elves and subraces are found in space with a few notable exceptions: The drow and the sea elves. The drow have long stayed out of space since they, with the aid of evil extradimensional partners, are capable of bridging dimensions more easily, and because they, like the mind flayers, do not care for the light. There have been sightings of a supposed drow ship in several areas, though it is unknown if it is truly dark elf in origin.

The sea elves, on the other hand, have a physical limitation (water-breathing) that keeps them out of space, though there is no reason why an envelope could not be filled with water instead of air. The various sea elves seem to have little interest in modern magics, and as such are

treated as junior partners in the elven rulership of the stars.

There is one final group that makes up elven society in space: the exiles. Not all elves agree with the beneficent, fatherly (or motherly) image put forward by the Grand Admiral and her staff. These elves use old navy gear, trim it back, reinstall the helms, and seek to bring their own brand of reason to the spheres. Often the regular navy is fighting alongside these exiles, who are more active in their involvement with other races. Equally often they are capturing their officers and trying them for crimes against the Imperial Navy.

Dwarves

The dwarven communities of space are much more separate than the monolithic elven nations, but no less powerful or widespread. While the elves regard themselves (regardless of the truth of the matter) as a single nation, each dwarven citadel is a nation of its own, with its own king, princes, and nobles. The master of a dwarven community, whether it can move or not, is called "the king within the mountain," and his court "the shining council."

The smallest of these dwarven nations are the citadel ships, powered by the creativity-tapping forges, which ply the skyways. The dwarves devour their own ships in building and carving and then, once they have no more space for art or no more riches to be tapped, they are abandoned, their forges quenched and moved to a new ship.

The larger nations are unmoving asteroids that tumble around the suns and planets. The dwarves hunt out earth-type planetoids as bases and set up colonies. Dwarven citadels whose populations have grown too large may move into an asteroid as opposed to creating another citadel immediately. Part of the asteroid

is carved away to form a new citadel, and the forges placed within, so that some of the population may move on, should they so desire.

Dwarven life within the asteroids is similar to that of dwarven life on most planets: an underground existence with much mining, crafting, and other activities, broken by feasts and celebrations. The dwarven citadels are lit within by a pale, luminous moss which also provides most of the air found within an asteroid base. The moss grows everywhere, and often conceals carvings or secret doors installed by previous generations.

The dwarves of a citadel or asteroid consider all other dwarves their relatives, and will go to great pains to establish a genealogical relationship, however faint. This is reflected in a strong sense of personal honor among the people, such that an attack against one dwarf is seen as an attack on all dwarves. The dwarven leaders can be worked into a fury by tales of atrocities against dwarves, and many a careless bard has set off a dwarven jihad by elaborating too greatly on his tales.

The dwarves are on cordial, if long-distance, terms with their groundling cousins. Most of their communication is with adventuring dwarves who pass to and from the planetary surfaces with other adventurers in non-dwarven ships. A dwarven citadel will never intentionally land on a planet.

*Note: Two years ago in the Realms, a particularly bright asteroid streaked over Waterdeep and the North, apparently burning up or landing in the Great Desert of Anauroch. This may have been a dwarven citadel or asteroid base.

The dwarves are concerned with the decline of the dwarves in the face of more robust populations of men, orcs, and elves. Those asteroids and citadels that dwarves inhabit are

thriving, but a huge number of empty and abandoned citadels and bases have been drifting through space, later to be used as lairs of monsters and bases of humans.

The elves say that the dwarves are doing as well as they are because of the elven Imperial Fleet and the Un-human War. The dwarves will deny this stoutly as elven propaganda, but the fact remains that groundling dwarves are on the decline while space dwarves, relatively secure in fortress-homes, are safe.

A fair number of dwarves mix with men and are found in human cities. They serve as artisans, weapon-smiths, and craftsmen, and some become adventurers before settling down to life "within the mountain."

A myth among the dwarves is the dwarven homeworld, a concept missing in elven and human tales (the elves feel the concept is unnecessary, the humans consider whatever world they are on as their homeworld). The dwarven home is a wonderful planet of huge mountains bored by great tunnels and filled with ornate, wondrous sculptures the size of dwarven citadels. Attempts to recreate this fantasy have often been made on other worlds, but the legend persists. Races new to space, such as the giff and the dracon, have homeworld tales, but the dwarven legend has been maintained for as long as the spheres themselves have been in space.

Lizard Men

The first lizard men in space were lumpish brutes little better than the primitives now found on a hundred planets. On these worlds the lizard men are at best savages, and at worst cannibals and threats to the general populace.

It is thought that the first lizard men were slaves of humans or mind flayers. They proved very fertile in

space, and their descendants benefited from the escape from the large planets. These lizard men were smarter, faster, and more adaptable than their slave parents. Some think this was a response to their enslavement, but the lizard men believe that it was due to their new existence in space, and the close passes to the various suns.

There is some truth in this idea, in that lizard men who developed on planets closer to the sun (in a typical system) were marginally smarter than the ones farther away, but the difference was found more in their ability to plan ambushes and use swords than in heavy thinking. The spaceborn lizard men gained levels of both civilization and communication unmatched by their groundling cousins.

The lizard man society in space is founded on the principle of bringing more intelligent lizard men into the world. They have incubator ships whose purpose is to bring the eggs close to the sun. The neogi have on a number of occasions captured these ships for a new generation of slaves, so now the lizard men go armed.

Intelligent lizard men are still short-tempered and emotional—their newfound status is still relatively recent. They use human ships, modified for their own use, to travel in space, but they have clerics and (very rarely) wizards that may power the major and minor helms.

Most cities will have an enclave of these intelligent lizard men, and relationships may vary from hostile to cool to a close cooperation with humans. Lizard men are often adventurers in space, and serve on human ships, provided the humans can adapt to their voracious appetites and lack of table manners or choice in cooking food. The neogi are hated, and the other races merely suspect, with the exceptions of the



damage every round. Items like *rings of fire resistance* will provide some aid, but will eventually be overwhelmed. The number of turns it takes to fall is the same as for a controlled landing of a ship.

The second danger for the falling character is impact. Regardless where the character lands (if he hasn't burned up already in the atmosphere), he will take 20d6. In addition, the character must make a saving throw vs. death to avoid a sudden demise from all the damage.

Note that this applies to lone figures making an uncontrolled descent to a planetary surface with an atmosphere. Heat from atmospheric reentry will not affect someone falling onto an asteroid without an atmosphere. A figure on a



giff and the kindori. The giff are seen by the lizard men as comical and clownish, much as halflings appear to men, while the dragons seem to lizard men more aloof and old, like the elves do to humans.

Gnomes

Most gnomes are creatures of the earth, tied to the soil both in attitude and actuality. Unlike the rock-living dwarves, the gnomes by nature inhabit the living earth in wooded areas, two habitats that are in short supply out in space.

There is a breed of gnome, however, that has taken to space rather readily. This is the Krynnish gnome, also called the tinker gnome. Made up of two subraces of the gnomish race, the minoi and the gnomoi, many tinker gnome communities have launched themselves into space and into greater adventures and chances for invention.

These gnomes are similar to their ground-dwelling cousins with the notable exception that they seriously enjoy invention, often to the point of excess. They are a gadget-happy race that will invent something to solve a problem, then invent a second item to solve the problems caused by the first invention, a third invention to solve the problems of the second, and so forth ad infinitum and ad nauseum. It is little wonder that these inventive creatures came across methods to hoist themselves (willingly or no) beyond the atmosphere and into wildspace.

The tinker gnome explosion has occurred within the last thousand years in the Known Spheres, and shows no signs of slowing down. Many communities of gnomes have found themselves in space. In most worlds, this would be noted and commented upon. However, in shattered Krynn, the sudden disappearance of a group of creatures who play with

smoke powder (among other advances) is hardly noticed, and in some cases brings a sigh of relief from the neighbors.

No such sigh may be heard from those space-dwelling races that the tinker gnomes have since encountered. On a scale they rate above the giff in general destructiveness, but below a boatload of drunken mind flayers. They seek to improve the devices, artifacts, and other objects they find, such that they often improve them into oblivion. There is a Krynnish saying: "If you want something broken, give it to a gnome."

Despite this, the gnomes have incorporated well into interstellar society. They have a fairly loose structure in space, no more than a scattering of ships and a growing number of gnomes living in human settlements. Their explorations have brought them into contact with their nontinker cousins, who lack their incessant drive but do have illusionist specialty mages whose abilities can be used to power spelljammer helms. This new blood has helped spread both types of gnomes to all corners of the Known Spheres.

The tinker gnomes do not consider their earthbound cousins backward for their lack of technological ability. Indeed, they hardly notice, and will often ask these gnomes for technical advice. Being too polite to refuse or explain, the "normal" gnomes give it their best shot, making a dangerous situation positively explosive.

Ordinary gnomes in space can be identified by their lack of incredible (and stupid) inventions in their area. Tinker gnomes have a hodgepodge of odds and ends, old machinery and clock workings, and dangerous items from half a hundred worlds cluttering up their areas. Attempts to control or at least move gnomish materials away from others have failed in that a gnome working at full tilt

can produce something dangerous overnight. In most cities, there are a few blocks at the edge of the city for gnomish experiments. This district is under continual renewal.

The tinker gnomes do seem to have a strange relationship with the arcane, such that the cosmic businessmen seem to like the little folks, as nearly as they can appear to like anyone. The idea that there might be some kinship between them, even in that the tinker gnomes may become the next race of arcane, is too horrible to contemplate.

Halflings

Halflings, like gnomes, are primarily creatures of the earth, in this case pastoral fields and gardens. This habitat is not common in space, and as a result, the more agricultural-based halflings never made it into space.

The other main habitat of the halflings is urban centers, where halflings seem to get along well with humans. As a result, as human communities started moving into space, so too did halflings. While there are no "halfling ships" or "halfling nations" in space, there are a great deal of halflings themselves, serving on crews and working in the major cities.

Halflings have the industry and intelligence of most humans and have the additional advantage of not taking up that much space or requiring that much air. A halfling can do much of the light work of a man, and requires half the air (though the same amount of food—a halfling's gullet is legendary). As a result, they are quite popular for work in tight quarters.

Halflings can be found in most spaceborne cities, involved in much of what they normally do . . . fighters, rogues, traders, and adventurers. There are even ships captained by halflings, though they have hu-

man and humanoid crews.

Most of the worlds of known space that have humans have halflings as well. An exception to this is Krynn, in which a related race, known as the kender, have taken their place in the planetary ecology. It is unknown why the kender, a similar but unrelated race, arose on Krynn and the halflings did not, but these halfling-like creatures are so far only noted on Krynn itself. Those kender who reach into civilized space run the risk of being mistaken for halflings.

Goblin Races

(Including Goblins, Hobgoblins, Kobolds, and Ogres)

The goblin races have a long history in space that ended relatively recently. For the longest time, the various goblin races flew through space on spelljammer ships powered by their shamans and witch doctors, fighting among themselves and against the other races of space, especially the elves.

The goblins, though powerful, were split among a huge number of local chiefs, leaders, and kings, and unable to coordinate more than scattered assaults. Given their numbers, these raids completely depopulated areas of space, wiping out elven installations, human cities, and dwarven citadels.

Most local organizations and kingdoms fought the assaults as best they could, but the combined elven Imperial Fleets came up with their own answer: a full-fledged war against the goblin races in space. Beginning with the Battle of Kule in Greyspace, and running through the next decade, fully half of the various goblin fleets were destroyed, with the remaining races' ships scattered and later hunted down.

The destruction was almost total, leaving the elven armadas the most powerful ships in space until the ap-

pearance of the neogi deathspiders. Of the goblin ships, the survivors were stripped of parts and equipment, for it is too dangerous to be caught in an unhuman ship. The kobold angelship, the debris-strewn goblin porcupine, the orcish scorpion ship, and the huge ogre mammoth all disappeared in the Unhuman War, never to return.

The power of the goblin races was crushed, and many of the races fled to their surface cousins for security. The elven fleets pursued many of these and bombarded their lairs from above, but when such bombardments brought down the ire of powerful groundling wizards, priests, and deities, the elves retreated and formed their present policy of limited ground actions.

The goblin races are still a factor in space, but like the halflings, have no organized state or specialty ships. A pirate may have an ogre first mate/bonebreaker, or an "orc nation" may have three raiding tradesmen vessels captured and poorly overhauled, but the threat of the orc hordes is long since passed.

Those orcs and goblins that do survive in civilization take their refuge in the human cities, or often below them. Relatively safe from the elves (whom they hate, for obvious reasons), the orcs and goblins operate on the same scale as they do on the ground—in secret if they must, in the open if they can, but always to the benefit of their own race. Many human cities, looking for workers, are not averse to hiring an ogre as a strong back or a kobold as a night watchman, as long as they are supervised and controlled by others.

There are tales in space, of course, and one of them is of the great orc horde that lies gathering just beyond the area of the Known Worlds. Sometimes it is in one particular backwater sphere, at others in a sphere as yet undiscovered, and in a third tell-



ship will be protected by the ship, though that ship will suffer the heat effects as listed, plus the added excitement of the crash. A character controlling a ship (or characters who can fly) are not out of control and therefore can get down to the surface safely.



ing it is in the phlogiston itself. But the remnants of the orcs and ogres and kobold fleets have banded together and grown in the centuries since their races' mutual destruction. Sometimes the stories add new elements: a minor race with strange powers that has never been seen before, or an evil human bringing the disparate races together, or a race like the neogi or fanatical beholder racists offering them an alliance in exchange for crushing the elves and all other races in the Known Spheres. They lay in space building, training, and growing, waiting for the day of vengeance.

Many discount this tale as one more lie of the bards, or a hopeful yarn cobbled together by orcs and half-orcs to frighten the foolish and appear that they are more than they are. Some put it in the same class as the dwarven homeland and the Big Rock Candy Mountain, an extension of the wishes of a people. But some also take it very seriously, including some members of the Council of Admirals of the elven Imperial Fleet. Should such a force be discovered anew, the stars will shake again from the destruction of elves and orcs.

Extraplanar Beings

Most natives of the other planes, including the various elementals, devils, daemons, archons, modrons, and slaadi, do not like being in wildspace. This is because the ties between them on this plane and their native planes are strongest on large planets. This may be due to the large number of extradimensional portals congregated in one planet-sized location, or because the mass of a planet is sufficient enough to make transit between this plane and others easier. Regardless of the reason, extraplanar natives do not enjoy being in wildspace.

These creatures will come if summoned (by *djinn ring*, or *conjure ele-*

mental spell) but their service will be short and limited, their attitude surly, and in the case of chaotic extradimensional creatures, there is a chance that the user might be dragged back to the home plane to learn just what discomfort means.

Extradimensional creatures cannot be summoned in the phlogiston, but may travel into it. They lose all contact with their native planes (an exception being undead, which are of this plane but have contacts with other planes), and cannot gate or use dimension-spanning abilities. This makes most sentient extradimensionals unwilling to cross into other spheres.

There are exceptions, as always. A demon prince seeking to spread into a new home, or the minion of a deposed god seeking reestablishment of faith, or even an organized party of modrons seeking out an artifact can be found in the wilds of space; however, all extradimensionals are very rare outside the surface of planets.

Giants

At first blush, giants seem singly unsuitable for space travel—they are huge to gigantic in size, making them both prime targets and hard to maintain as far as air requirements.

However, if a captain is willing to risk the loss of air to take on a hill giant, he gains a portable catapult. A giant throwing stones inflicts damage as normal, with 10 hit points of damage equaling 1 hull point of damage. Their normal maximum range is raised to 500 yards (1 tactical hex) in space because of a lack of atmosphere. A giant in space will have to gain a proficiency in compensating for space travel (-2 to hit for the first few battles), but soon will be able to lob stones in on his enemies with great precision.

There are as yet no known giant ships, though neogi have often taken

giants as slaves to use in boarding parties. The giants are unwilling partners at best, and mutinies are common when the neogis bring too many giant slaves together. There is an unconfirmed tale of a giant-run neogi deathspider which pulls its energy from a lifejammer hooked up to the former captors.

Of the giants, the storm giant can leave the atmosphere of a planet with enough air for 2-20 rounds, usually enough time to meet with a ship. Often these giants serve as guardians or wardens of planets that they want the spacefaring nations to avoid.

Mind Flayers

The illithids are a major race in space. They have their own navies and colonies, and engage in brisk trade with everyone, including the neogi. Their success in space gives cause for concern, since on the ground they are mostly creatures of the deep underdark, light-hating and rarely seen by men.

That hatred of light carries over into space, and while the mind flayers suffer no penalty for fighting in light, their specially designed craft have extensive coverings to keep exposure to a minimum.

The success of the mind flayers in part comes from the use of the series helm, which allows the illithids to channel their magical psionic abilities into motive power. This throne is sold by the arcane to the illithids, and the assumption is that they helped the mind flayers develop it. Whether this was a rational action on the part of the arcane is unknown, but in the meantime a large number of mind flayer colonies have sprung up.

Mind flayers in space may be neutral or even chaotic, though tales of a lawful good mind flayer are just so much space dust. Mind flayers engaging in deals with other thinking creatures make a point of eating only

the brains of nonthinking creatures, or the brains of enemy sentients of the race they are dealing with. In those rare areas where there is a mind flayer enclave near a human settlement, there is usually a brisk brain-trade business.

The illithids of space consider their land-trapped cousins provincial, and even backward. There is a universe of minds out there to be learned from and/or eaten. This is a driving force of the illithid race, and the spaceborne members of the breed look forward to the day when they can consider everyone (even the neogi) their vassals.

The mind flayer habit of keeping mind-dead personal slaves makes them kin to the neogi, though they do not share that race's overwhelming drive for dominance. The relationship between the races is born of caution and expedience—each sees the other as a potential cat's-paw for advancing their own ends.

The mind flayers of space belong to a loose trading organization that recognizes the existence of other mind flayers and tries to avoid overlapping territories or missions. The strong urge to "hunt and dominate" has been replaced with one of "trade and dominate."

The mind flayers will maintain enclaves near human cities if they do business, but prefer to keep their communities apart from other races. This is in part because the elder brain-pools of the illithids, where the young swim and grow, can easily detect alien thought patterns. Also, the mind flayers can keep their slaves easier without outside interference, which is a constant problem near other civilized and good-intentioned races.

Mind flayer bases are usually within abandoned asteroids, hollowed out by radiant dragons or dwarves. There are recorded in-

stances of mind flayers taking over a dwarven citadel, killing or enslaving the entire population. With the population in this state, however, the forges will not function, and the ship becomes a drifting base for the mind flayers.

The mind flayers, working again with the arcane, have developed a "pool helm" which allows the elder brain-pool to be stored on a ship itself. In addition to allowing additional scanning benefits to the ship (the range of a brain pool is 2 miles, within which thinking creatures will be detected), it allows greater tactical speed for the mind flayer ships.

The relationship between the mind flayers and the arcane is suspect. The mind flayers act as intermediaries with the slaving neogi for the arcane, and in return the illithids have benefited from arcane devices. Other races are concerned, but need the Arcane devices as well.

In addition to the deadly powers of the mind flayers, there are tales (aren't there always?) of mind flayers with magical and/or clerical powers. This has been confirmed recently, but such creatures are very, very rare (one illithid in ten thousand will have such powers, usually either magical or clerical, at levels 2-12). Mind flayer nautiloids carry such magic-using crewmen as a back-up for the series helm normally installed. It may be that these creatures were a parallel development with pool helms to expand the mind flayer repertoire in space.

The nautiloid is the most common mind flayer craft in operation, though they use a variety of human-built ships modified to their needs. With the introduction of the pool helms, larger mind flayer craft may be on the way.



Types of Worlds, Part 4: Air Worlds

Air worlds are almost entirely gas from one end to another. They come in all shapes, with spheres being most common. Often there are large chunks of land, fire, or water drifting in the midst of the air, usually orbiting around the central point of the air world. Air-type worlds can be thought of as miniature solar systems, though with an atmosphere replacing the void.

Air worlds are generally breathable, though there are those with poisonous clouds and smoke as natural occurrences, and a rare few where the entire atmosphere, with few exceptions, is poisonous.

Unlike water worlds, air worlds do not increase in pressure the farther you descend. This is a unique facet of air



Dragons

With the exception of the radiant dragon, most draconian species do not travel well in space. They may survive for 2-20 rounds once they leave the atmosphere, as normal creatures, but this will not allow them to fly any farther than a very close moon. As a result, they tend to lay relatively low, preferring the thicker atmospheres of the lower climes.

Dragons have been found in space, usually the result of some magical effect or individual collecting life forms. They are limited in that any gas attacks (including fire) will end at the edges of an atmospheric envelope. Such attacks as lightning or acid will not be affected, nor will cold.

Centaur

Centaur are a minor space-faring race; that is, they possess no inherent spacefaring interests or specially designed ships. They have traveled into space, primarily as adventurers.

The dragons have taken an interest in the mammalian centaurs, and in their distant cousins the wemics as well. The dragons seem to be looking for centaurian relatives, with an eye to eventually building their own ships. The centaurs are to dragons much like elves are to men: a forest-dwelling, peaceful relation. The availability of wood through centaurs make them a prime contact of the dragons.

Undead

Undead are perfectly adapted to space—they have little in the way of food and air requirements, and a number of mages have attempted to use *animate dead* spells to staff a ship with skeletons and zombies. The problem is that such creatures generally must be supervised and lack the talent to react in an emergency.

Any type of ship encountered in space may be a ghost ship, crewed by undead, instead of a normal ship. Such craft sometimes have moldy sails, tattered rigging, and hulls laced by krajen spores and other parasites. Often this is the case for ships which have been entirely taken over by an evil undead, who then uses the ship to its own end. If possible, the ship will use a spelljammer helm or similar construct, but just as often an undead ship will drift in space until it is contacted. Undead have a lot of time on their hands, so that the huge distances involved do not bother them.

A particular type of undead ship is the skeletal form of a kindori, radiant dragon, or other gargantuan monster. This creature's bones are attached to a spelljamming helm and are used by powerful undead to cross between the planes with a crew of followers. A typical undead crew would be 1 mummy captain, 2 wraith first officers, and 15 zombie crewmen and fighters.

The maneuverability of a skeletal ship is always class F, unless the skeleton has itself been animated, in which case the maneuverability class is one rank worse than it was in life. Nothing can drop below a maneuverability class of F.

Skeletons: Skeletons are unthinking, animated bones of once-living creatures, with no minds of their own. They may only handle simple orders, though they may remember their orders years before implementing them. A ship crewed by skeletons has a maneuverability class one rank worse than the ship would have under a similar human crew.

During the Unhuman War, a standard defensive tactic by necromancers was to fold up their skeletal minions in small bony balls and scatter them through space, much like caltrops dropped in front of a cavalry charge. Centuries have passed since

the creatures have been let loose through the many spheres, but packs of them still exist. From 2-20 skeletons will be found in a pack. Their orders are, once they drift into the gravity plane of a ship, to board it and attack it. Intended originally against invading humanoids, these skeletal packs now pose a menace to all travelers.

Zombies: Zombies are well preserved in the void, though the ships they travel on soon smell like charnel houses, and have stale air. They are not used as crews due partially to this stink, but more importantly due to the fact that zombies suffer the same loss of maneuverability class as ships stocked by skeletons, and in addition, always move and attack last in a turn.

There are ships commanded by juju zombies (those humanoids affected by the wizardly *energy drain* spell), which are staffed entirely by zombies and monster zombies. These creatures have a low, mean intelligence and seek to bring more undead under their sway.

Zombies, like skeletons, are not bound by air restrictions, so a ship may be filled (twice normal crew size) with the creatures.

Ghouls and Ghosts: Ghouls and ghosts do not need to feed on the flesh of the dead, and can survive in the depths of a dungeon or the airless void of a planetoid for centuries without living flesh. They are, however, addicted to it, such that they will eat it whenever possible.

Ships run by ghouls are commanded by ghosts, and run under the black flag as marauders. Their purpose is to create more crewmen. A ghoul ship can have up to three times the standard number of crew. The ship has a charnel odor, and the atmosphere, though breathable, is stale.

Ghouls and ghosts can use any ship types, but are most often found

on old tradesmen, hammerships, and squid ships. There is an unconfirmed report of a dwarven citadel ship entirely taken over by ghouls and led by a ghast of double normal hit dice.

Wights: These solitary creatures are occasionally found as ship captains, but just as often haunt the depths of ancient asteroid civilizations and other dark, unknown places. Their hatred of sunlight is as great as that of the mind flayers, and as such, if they take command of ships, it will be ships with great enclosed places, such as the mind flayer nautiloids (there are mind flayer wights, but in gaining their undeadly power they lose their mental blast and other abilities).

Wraiths, Shadows, and Ghosts: These noncorporeal creatures usually are found only in abandoned asteroids and in the heart of old hulks. They are often used by more powerful undead as servants.

All three creatures are often found adrift in space, vague essences without real mass or weight. If a spelljamming craft passes close enough to them, they may be swept up in the gravity plane of the ship. Once rescued in this fashion, they will attack the ship's crew, and seek to reduce the ship to a hulk and new lair.

Wraiths and shadows have strong ties with the negative material plane, and as such do not prefer to journey into the phlogiston. Ghosts exist primarily on the border ethereal, and as such cannot enter the phlogiston. Trying to force a ghost to enter the phlogiston will merely cause him to retreat farther back into the ethereal plane.

Spectre: Unlike the other semi-transparent beings, spectres retain a strong feeling of their past, and will attempt to take command of ships if the opportunity arises. Spectres can be swept up from deep space much

like ghosts, wights, and shadows, but once on board, they take on a definite mission: taking over the ship for their own command.

A spectre on board is a dangerous creature, as it will not attack everyone at once, but rather pick off its targets one at a time when they are separated from the others. This master spectre will then send his initial victims out against the others in similar fashion, until fully half the ship may be drained of energy and turned to spectres before the damage is realized. One reason that clerics are a preferable spelljamming helmsman is that they may turn these undead without sufficiently affecting their normal spelljamming powers.

Mummies: These creatures are rare in space, as they are usually the result of intricate burial procedures. These procedures are followed by some subcults of Ptah, so there are mummies in all the Known Spheres.

Mummies are usually found on planets and asteroids and only rarely in space. An exception is a barge of Ptah, a vehicle used by followers of Ptah over three centuries ago. The barge was a powerless hull carrying the body of the deceased, along with treasure, trappings, and traps to defeat the unwary. These barges were then cast into a spiraling orbit around the nearest fiery celestial body, eventually to be burned. However, this cult's astronomical skills were as suspect as their mummification techniques, so that there are a large number of these barges still floating about. The cult was driven underground after a number of their burials attacked ships in space, but is still reported to be active, and one subcult is said to jettison their mummies into the Flow.

The mummies are creatures of the positive material plane, but exist in the Flow without any problem. The phlogiston does provide them with some measure of protection, since



worlds, since the atmosphere of an earth world does thicken toward the surface. Also unlike a water world, there is often no "center" to the air world. The focal point of all the orbits is missing.

Air worlds are all atmosphere, trailing off into the void itself. In some cases it is a bubble, much like the skin on a water world. A traveler can pass through this bubble without damaging it and vice versa.

Air worlds are excellent for refreshing stale air envelopes, and their mass is sufficient to keep ships from plunging through them at spelljamming speeds.

The inhabitants of air-type worlds are usually fliers, including some that are native to earth worlds as well. When familiar animals evolve on an air world, they usually are larger than their earth-world counterparts (double hit points and size). There are



open flames, the bane of mummy existence, are as dangerous to the user as to the mummy.

In one of the spheres, there is supposedly a mummified pharaoh of high intelligence who pilots a flying pyramid. This pharaoh is obsessed with the idea of creating more mummies, in the way that spectres and other negative plane undead replicate.

Vampires: Vampires in space have a significant problem in that they cannot withstand sunlight. However, the danger in space is less than that on earth. While it is true that the sun (or, to be technical, a fire-based celestial body) is always shining, any manner of shade provides sufficient protection from its effects for vampires. This could include working within a nautiloid or other enclosed ship, or for a female, wearing a full-length dress, gloves, and a parasol to keep the rays of the sun away.

Vampires prefer a ground-based existence, where they may use other natural agents, such as rats, bats, and wolves, which are in short supply out in space. There is a small number of vampires acting as ship captains, and one or two have sought deals with mind flayers, since they feed on related materials. Mind flayers and other monstrous creatures are not immune to a vampire's energy drain, but do not turn into vampires upon being slain.

Liches and Other Great Undead: The stars are eternal, and several groundling mages have attempted to cross between them by becoming undead liches and drifting in a low-powered carriage. Some of these vehicles, resembling boats, barges, and dragons, can be found in space, moving leisurely from planet to planet. Whether these would-be liches knew of spelljamming helms and their rapid travel or had other reasons not to use them is not known; however, in general they are not pleased when they discover there are faster ways to travel.

Liches, with their magical abilities, can use major and minor helms as normal mages and priests can. Many have become magical marauders, preying on the living for their magic and treasure. They stock their ships with other undead creatures to handle the minor tasks. Liches tend to prefer human ships such as the hammership and the squid ship over elven and dwarven models. Given the level and abilities in spell use of a lich, one makes a formidable opponent in space combat.

Golems

Golems serve well in space; they require no air for themselves and they retain a large atmospheric envelope that others may use if cast adrift. Greater golems are about one ton in mass, and will be detectable by ships with the *voidscan* spell.

Some wizards have used golems as guardians for their fortresses and hidden workshops. Some have gone so far as to put the golems into space, in orbit around their homes, with instructions to board any ships that come too close.

Golems otherwise function as outlined in the AD&D® *Monstrous Compendium*, with the note that the iron golem's breath will not pass across the void, and instead seeks to fill the area that the golem is in.

Lycanthropes

True lycanthropes can control the change in their bodies from humanoid to wereform. As a result, the onset of darkness, the rising of the full moon, and other "traditional" effects that cause the change have no effect on lycanthropes. In space they have no limitations on changing from human to wereform.

Infected lycanthropes, humans and humanoids bitten by lycanthropes and given the affliction of lycanthropy, have a harder time of

things. Those bitten on a planetary surface are bonded to the time table of the planet they were injured on. If that planet has a 30-day cycle between full moons, then the infected human will assume wereform every 30 days for two to three 12-hour periods, during which time the character is run by the DM as a lycanthrope.

Infected lycanthropes bitten in space have even further problems. Not tied to any particular pattern, these humans will be triggered to lycanthropic status by any of a number of triggers (DM-determined, with an eye toward making the player character's life "interesting"). Anger, violence, or the sight of blood are good triggers, as is the presence of a "full" earth-type body in the sky of at least size B (a werewolf on the moon would be triggered by a full earth). Such changes would be sudden and erratic, making dealing with the lycanthropy difficult.

True lycanthropes can enjoy a small community on their ships, and use a number of human ships as traders, pirates, and adventurers. The relative privacy of the ships allows the lycanthropes to maintain their own society without spilling over into that of the easily infected and easily upset normal humans. There are ship colonies of weretigers, werebears, and werewolves afloat. Wererats prefer the company of men (whom they refer to as prey), and as such are found in cities. The other lycanthropes are more likely to be found in cities than in groundling communities, though those found in the cities of the SPELLJAMMER™ universe have a greater tendency to obey the laws and customs of the local rulers.

Other Monsters

Any of the creatures from the *Monstrous Compendium*, or creatures native to Krynn, the Realms, or Greyhawk may be found in space, with the following limitations:

1) Extradimensional creatures will not be found in the phlogiston.

2) Those creatures with multiple existences in many planes, with the exception of undead, will not be found in the phlogiston.

3) Those creatures who require air and nourishment will be found in areas where they can gather such nourishment—a dragon in space would likely need a lair and a lot of cattle to keep it healthy.

4) Intelligent creatures will know of spelljamming helms. Those with magical abilities similar to wizards and priests will be able to use major and minor helms (such as centaurs, for example, whose shamans are the equivalent of 3rd-level druids). Creatures with spell-like abilities may be able to pilot ships using other specialized helms (like the mind flayers using their series helms).

Lack of mention of a particular monster type here does not preclude its existence in space, but does mean that it is not widespread through the Known Spheres. There may well be planets ruled by starfaring medusae or outposts of gargoyle legions planning a fanatical religious war, but in the scope of the universe, these are minor operations.

As for a rationale of how a hydra or other creature ends up on another planet, or even why similar creatures show up in widely separated spheres, we offer one last legend: There is supposedly a race similar to the arcane, who are called either the Keepers or the Zookeepers. These are cosmic collectors who raid various worlds for their native life, and take it elsewhere for either study or amusement or storage. The Keepers are halfling-sized creatures with no necks, three legs, and barrel bodies. Their heads are dominated by large milky-white eyes. Keepers are the closest thing fantasy space has to an ancient, extinct race, and it is un-

known whether they exist or are just a figment of a sage's imagination. Despite the wide variety of life found everywhere, and often in improbable locations, there are no signs of the Zookeepers, their disc-shaped ships, or their passage through our chunk of space.

Starbeasts

The largest creatures in the Known Worlds are larger than the planets themselves—in fact, they often carry planets on their backs. They are given the collective name of starbeasts, though they may appear as monsters, humanoids or gods.

Starbeasts are usually unique beings (in the sense that titans are unique) found in crystal spheres which support celestial bodies. Not all spheres use starbeasts to support the planets within, however.

Starbeasts are living things. They move, and in some cases have sentience and can react to others. They are normally 1-4 million miles tall, and in large spheres a number of them must stand atop one another in order to reach the bottom of the sphere (for example, the world is held by a giant on the backs of four elephants, which in turn rest on a huge turtle, which moves about at the bottom of the crystal shell).

The starbeasts are similar to the crystal shell, and share that material's strange ability in that they have neither a gravity nor an atmosphere, which should accompany creatures so large. Why these objects have neither is a mystery. Sages mumble something about the "will of the gods" and change the subject.

It is possible to moor a ship alongside a starbeast but, since no gravity, actually walking on one is very difficult (some would say pointless). Communication is extremely difficult, given the difference in scale. Some have been known to pass on



beings very similar to those found on earth-type planets living on earth islands, though they do not benefit from a size increase. These earth islands are excellent bases for itas pirates and military operations.

Air worlds can be very volatile, with high winds and storms which can damage ships. A mild storm can inflict 1d6 points on a ship's hull, while a major blow can inflict 3d6 plus damage from lightning. Captains moving through air worlds must be careful of their course.



messages or answer questions. Some are known in their systems as oracles, some as gods, and some as servants of (or those being punished by) the gods.

Where a world is in contact with a starbeast, the land is usually a blasted area in perpetual shadow. The land itself is twisted by the continual pressure of the creature's fingers or back or flippers. Nothing grows on the side of the starbeast, even in those parts within the atmosphere of the planet.

Starbeasts cannot be harmed by any spells or spell-like effects; again, a similarity with the crystal shells. They are unaffected by weapon attacks (or are so large that the attacks inflict no more damage than a gnat-bite to a fully armored warrior) and any damage inflicted on them heals almost immediately. Creatures of gargantuan size might (1% chance) gain their attention. The only attack starbeasts have is a death spell (saving throw -4) cast with a range equal to their size.

It is not possible to slay starbeasts by conventional means, and the effects should one be slain are horrible to contemplate. Legends tell of great heroes or villains who have tried to slay these creatures, only to destroy their own world in the process, or become enlarged and replace the slain starbeast in the sky.

Natives of planets carried by starbeasts insist that starbeasts are the only method of planetary movement. They say that all other planets are carried by starbeasts as well, ones which are invisible and intangible because those who live on those planets are not worthy of the starbeast's notice.

Starbeasts that are said to exist include the following:

A single giant holding the world above his head.

A flat world supported on the backs of four elephants, which in turn are supported on the backs of eight dragons, which in turn are held up by a turtle that moves the entire operation around the sun.

A water world held in the grip of a huge squid starbeast.

A fire flat world held in a huge bowl, held aloft by a female giant in flowing robes.

An air globe held between two huge hands. The arms extend far below the edge of the crystal sphere itself.

A monstrous jester who juggles a number of worlds. When the worlds are in his hands, there are earthquakes, tidal waves, and massive destruction. Of course, it takes centuries for one world-ball to make a complete circuit, which is time enough for civilizations to rebuild.

A tremendous beholder, holding the flat plane of a world above it with its eye-tentacles.

Alligator-headed, jackal-headed, and even gifflike giants, working in combination.

One legendary starbeast looks like a neogi on the back of an equally huge umber hulk. There is no world on their backs, and it is surmised that the neogi ate it millennia ago. This is a spacefarer's story, and likely has no place in reality.

If contact is made with a starbeast, it may be able to answer questions within its ken. Most could not care less about the actions on the worlds they carry, but know a great deal about the placement of other starbeasts and their movements.

Arcane, The

CLIMATE/TERRAIN:	Any space
FREQUENCY:	Very rare
ORGANIZATION:	Bands
ACTIVE CYCLE:	Any
DIET:	Omnivore
INTELLIGENCE:	Genius (17-18)
TREASURE:	R
ALIGNMENT:	Lawful neutral

NO. APPEARING:	1 (1-6)
ARMOR CLASS:	5 (3)
MOVEMENT:	12
HIT DICE:	10
THACO:	11
NO. OF ATTACKS:	1
DAMAGE/ATTACKS:	1-8 (weapon)
SPECIAL ATTACKS:	Nil
SPECIAL DEFENSES:	<i>Invisibility, dimension door</i>
MAGIC RESISTANCE:	40%
SIZE:	L (12' tall)
MORALE:	Champion (15)
XP VALUE:	3,000

The arcane are the merchants of space, found anywhere that there are spaceborne civilizations. They appear as tall, lanky, blue giants with elongated faces and thin fingers with one more joint than is common in most humanoid life. The arcane dress in robes, though there are agents of the race who are found in heavier armor. This appears to be a function of personal taste of the various arcane.

The arcane are normally found in those locations where there is an awareness and an interest in spelljamming equipment, which is their stock in trade. In those groundling backwaters that do not believe in space travel or life on other worlds, or on those insular worlds that make such travels by dimension-hopping, the Arcane are nonexistent. They speak the common tongue, and are believed to have their own language.

Combat: For creatures of their size, the arcane are noticeably weak and noncombative. They can defend themselves when called upon, but prefer to communicate and/or buy themselves out of dangerous situations. If entering an area that is potentially dangerous (like most human cities), the arcane hires a group of adventurers and/or fighters as his entourage.

The arcane may become *invisible* in order to avoid combat, and can *dimension door* up to three times a day, again with the intention of avoiding combat. An arcane feels no concern about abandoning his entourage in chancy situations, and for this reason, such entourages often take half their payment in advance.

The arcane can also use any magical items, regardless of the limitations of those items, including swords, wands, magical tomes, and similar items restricted to one type of character class. They will use such items if pressed in combat and they cannot escape, but more often use them as bartering tools with others.

Finally, arcane apparently have a type of racial telepathy, such that harming one arcane is immediately noted by the other arcane throughout space. The arcane will not seek vengeance against the one who hurt or killed their fellow arcane. They *will* react negatively to such individuals, and dealing with the arcane will be next to impossible until that individual has done something to get back into their good graces.

Some arcane do wear armor, a combination of chain links with patches of plate that seems to be more for show than for protection. It improves their AC to 3, and is sometimes worn in dangerous situations and in negotiations with unreliable adventurers.



Habitat/Society: Not much is known about the arcane's origins; they come and go as they please, and are found throughout known space. When they travel through space, they can do so on other races' ships. Finding such ships with arcane aboard is rare, and it is suspected that the arcane have another way of moving through space.

The arcane tend to be solitary, such that some primitive (and groundling) societies assume them to be avatars of a single greater power. Cults invoking the powers of the arcane are found on half a hundred worlds lacking spelljammer capabilities. It is presumed that the arcane visited such worlds briefly to ascertain their usefulness as potential markets, and left when the inhabitants proved uncultured, savage, or backward.

The arcane will gather together in larger groups for large-scale deals, such as opening trading relationships with a groundling nation, or the discovery of a new spacegoing race that is interested in the arcane's magical helms.

Contacting the arcane is no trouble in most civilized areas: a few words spread through through the local grapevine, through taverns, guilds, and barracks, are enough to bring one of these creatures to the surface. In game terms, there is a base 10% chance per day of such an encounter if the player characters are actively looking for an arcane, with the chance increasing or decreasing depending on their location.

The arcane usually do not contact the seeking party directly, instead operating through middlemen, subordinates, or members of their temporary entourage. They are not violent, but not particularly stupid, either, and the fact that they deal with anyone has made them suspicious of all newcomers.

The arcane's stock in trade is in providing spelljamming helms and other spacefaring equipment. They sell them at the prices listed for the various helms and equipment in the *Concordance of Arcane Space*. Their continual presence, high quality, and uniform prices make them the trusted retailers in space. Cheaper prices can be found in certain areas for goods of questionable quality (such as the gnome helms).

Arcane, The

The down side of this free enterprise is that the arcane will deal with almost anyone. They have provided helms for humans, elves, and mind flayers. They may or may not have developed the orbi for the beholder nations, but definitely provide the wide variety of hulls the tyrant ships use, and maintain a registry to make sure that no warring factions have the same ship design.

Those who have a problem with their methods quickly find themselves without a supplier, and other attempts to provide such material have been second-rate or quickly put out of business. The arcane have no dealings with neogi, who apparently have their own methods of building and acquiring spelljamming helms.

It is unknown whether the arcane create the wide variety of spelljamming helms themselves, or secure them from an unknown dealer. Their shipping methods are questionable as well, as they have been able to secure helms in locations where there have previously been no helms to acquire. In some cases, a short journey (to a nearby base or depot) is needed to provide the helm, and in these cases an arcane might be found on another ship.

As far as the politics and rivalries of the various factions in space goes, the arcane have no concern. All that exist for them are customers for their goods.

Those dealing with the arcane find them cool, efficient, and most importantly, uncaring. Trying to haggle with an arcane is a chancy operation. Sometimes they will engage in haggling with a bemused smile, but just as often leave the buyer hanging and walk out on the negotiations. They do not appreciate being threatened, insulted, or blackmailed. Those who do so will find it very difficult to purchase reliable equipment. An arcane will not raise his hand in vengeance or anger . . . there are more enjoyable and subtle ways to wreak revenge.

Other races view the arcane with a combination of irritation and recognition of them as a necessary evil. The various gods are silent or misdirecting as far as their origins go, and a number of rumors abound, including their possible links with the *Spelljammer* itself. One tale claims that the arcane traded their homeworld to an elder god for the *Spelljammer*, only to find that they could not control it, plunging the ship into a nearby sun and destroying their former planet. As a result they are doomed to wander as cosmic traders. The fact that the *Spelljammer* is still sighted indicates that this is only a tale, but the arcane have let the story pass from world to world without correction or comment.

Ecology: The arcane as a race need to eat and breathe as all normal creatures: they cannot breathe the void or survive for long periods without food. They will often make deals with both sides in a conflict, fully aware that the amount of firepower they provide will annihilate all of their potential customers in a sphere. Their market is large enough that such small losses as an entire planet and race do not have a serious impact on their trade.

The arcane seem sexless, or rather members at times seem to act in female or male roles, depending on the situation. No young arcane have been seen, though whether this is due to their reproductive cycle or their society is not known.

It is not known what the arcane do with the gold, gems, and magic they collect. One theory says that it is needed in their reproductive cycle (the basis for a large number of bawdy arcane jokes), while another links it to production of the helms themselves. As in most things, the arcane keep their own counsel on the matter.



Beholder

	Beholder	Orbus	Hive Mother
CLIMATE/TERRAIN:	Any space	Any space	Any space
FREQUENCY:	Rare	Rare	Very rare
ORGANIZATION:	Tribal/ship	Ship	Solitary/ship
ACTIVE CYCLE:	Any	Any	Any
DIET:	Omnivore	Omnivore	Omnivore
INTELLIGENCE:	Exceptional (15-16)	Non- (0)	Genius (17-18)
TREASURE:	I,S,T	Nil	I,S,T
ALIGNMENT:	Lawful evil	Neutral	Lawful evil
<hr/>			
NO. APPEARING:	5-20	1-6	1
ARMOR CLASS:	0/2/7	10	0
MOVEMENT:	Fl 3 (B)	Fl 3 (B)	Fl 6 (A)
HIT DICE:	45-75 hp	5-10 HD	20
THACO:	45-49 hp: 11 50-59 hp: 9 60-69 hp: 7 70+ hp: 5	Nil	3
NO. OF ATTACKS:	1	0	1
DAMAGE/ATTACKS:	2-8	0	5-20
SPECIAL ATTACKS:	Magic	None	Special
SPECIAL DEFENSES:	Anti-magic ray	Anti-magic ray	Anti-magic ray
MAGIC RESISTANCE:	Special	Special	5%
SIZE:	M (4-6')	M (4-6')	L (8' across)
MORALE:	Fanatic (18)	Average (10)	Fanatic (18)
XP VALUE:	14,000	270+	24,000

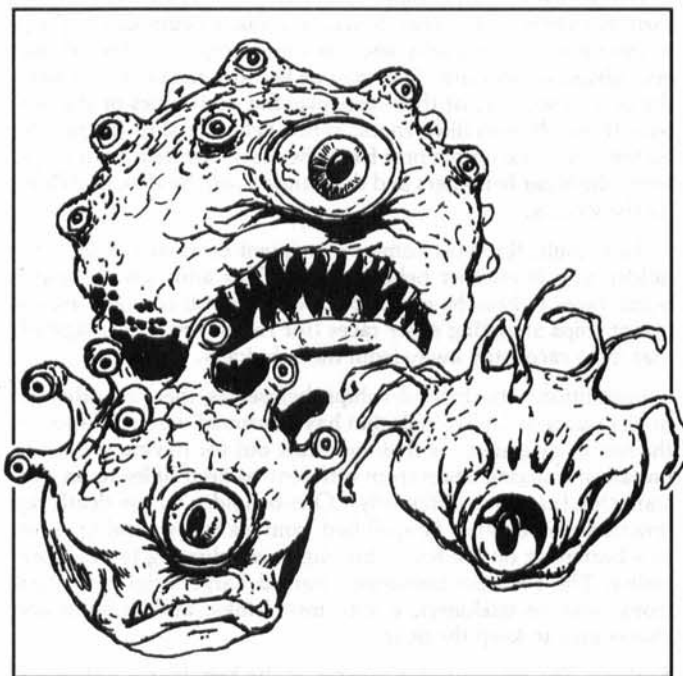

The beholder is the stuff of nightmares for many a groundling. The creature, also called the *sphere of many eyes* or the *eye tyrant*, appears as a large orb dominated by a central eye and a large toothy maw, with ten smaller eyes on stalks sprouting from the top of the orb. On the Known Worlds, a single beholder is considered a great danger. How would these groundlings react if they knew that in space beholders control their own specially designed ships, and traveled on them in large numbers?

The beholder found on the ground is only one of three distinct

types that are found in space. It is the only type that can survive for long periods on its own, and is comfortable in the constant gravity pull and thick atmosphere of most planets. This singleton beholder is crafty in its own right, and a dangerous opponent. Singletons are found in space as well, but most beholders are part of a larger ship, powered by the orbus and dominated by the hive mother.

All beholders retain their levitation ability in space, and in the absence of any set gravity, can use it to fly at will. Both the groundling beholders and their spaceborne cousins have their own language, and speak a wide variety of other languages as well, including the common tongue used throughout the Known Worlds.

In space, the common beholder social unit is the nest, which occupies one of their huge tyrant ships. The nest is similar to a hive, in that the ship is commanded and ruled by the hive mother, and powered by the orbi. The common beholders serve as scouts, soldiers, and guards for the hive mother.

Combat: The common beholders function in space much the same way they do on the ground. Their bodies are covered with hard shells of AC 0, their ten eyestalks are AC 2, and the small eyes themselves are AC 7. Each of these eyes, and the large central eye, has a different function. Generally, a beholder can use 1-4 of the smaller eyes if attacked from within a 90-degree angle in front, double that if attacked from within a 180 degree angle, triple if attacked from 270, and quadruple if attacked from all sides. The central eye can only be used against attacks from the front. If attacked from above, the beholder can use all of its smaller eyes. If attacked from below, it can use only 1-4 of its smaller eyes.

In space, then, a beholder that is not in the gravity plane of a larger object (like a ship) can orient itself as it sees fit, and can use all of its eyes simultaneously. Once it falls into a gravity plane, it is restricted to 1-4 eyes as it "rights" itself to the correct direction.

Beholder

For this reason a beholder that drifts into another gravity plane will attempt to come close to the surface to do battle with many attackers.

The standard eyes of a beholder are:

1. *Charm person* (as spell)
2. *Charm monster* (as spell)
3. *Sleep* (as spell, one target)
4. *Telekinese* 250 lbs. weight
5. *Flesh to stone* (30-yard range)
6. *Disintegrate* (20-yard range)
7. *Fear* (as wand)
8. *Slow* (as spell, single target)
9. *Cause serious wounds* (50-yard range)
10. *Death ray* (single target, 40-yard range)

Central Eye—*anti-magic ray*, 140-yard range, covers a 90-degree arc before the creature. All magic within the area (including the effects of the other eyes) will not function within that area. Spells cast in or passing through that area cease to function.

The common beholder can withstand the loss of its eyestalks, each eyestalk taking 8-12 points of damage before being lost. This loss of hit points is over and above any damage done to the central body. The body of the beholder can withstand two thirds of the listed hit points in damage, and the central eye one third before it ceases to function. Slaying the body will kill the beholder. For common beholders, there is a 75% chance that any hit strikes the body, 10% chance for the central eye, 10% for the eyestalks, and 5% for the eyes.

The Orbus

The orbus is either a genetically bred or a stunted and immature form of the standard beholder. It is only found in space aboard the tyrant ships of the beholder nations. It is chalk-white and lacks functioning smaller eyes. The central eye is huge and vulnerable, occupying most of the upper body above a small, toothless mouth. This eye has the normal anti-magic properties, but is milky white.

Despite their vulnerability, the orbi are the means by which the beholders travel through space. It is they that can funnel the magical energies of the other beholders into motive force—they are living spelljammer helms. There are 1-5 of them aboard any tyrant ship, and they are located closest to the hive mother, at the deepest point of the shell.

The orbi have their hit points distributed as common beholders: one third for the central eye and two thirds for the body. However, when attacking an orbus, 50% of the hits will strike the central eye, the remainder hitting the body. Both eye and body have the same Armor Class.

Hive Mother

The hive mother is also called the *ultimate tyrant*, or just "Ultimate," a form of greeting that seems to please their pride. They are twice the size of typical beholders, and differ in appearance as well. Their mouths are larger, such that they can gulp down a man-sized target on a natural die roll of 20. Once swallowed, the prey takes 5-20 points of damage (5d4) each round until it is dead or escapes. The beholder's mouth is not very deep, so a victim can escape by stating this intention and making a successful attack roll.

The ultimate has no eyestalks, either, but its eyes are protected by a hooded cover in the flesh of the creature's body. The central eye has a similar hood, such that the chance of striking the central eye is reduced to 10%, the remainder striking the body.

The ultimate's true ability is in controlling the actions of its brood, the common beholders that make up its crew. While a hive mother can survive groundside, it is not as effective as when it is linked up in a tyrant ship.

A tyrant ship allows the hive mother to focus the energies of her crew through the structure of the ship's shell itself. The tyrant ship shells are made by the arcane, who thus profit from the beholders despite the fact that the tyrants have their own genetic helms.

Habitat/Society: The beholders of space would be the greatest menace of the void, more deadly than the neogi, more sadistic than the mind flayers, were it not for one thing: they are rampant racists.

They are not true xenophobes in that humans and other races are considered subservient—it is not known if the beholders of space consider humanity anything other than one more item in space. Rather, the beholders war against their own species.

Within the basic body-type of beholder (a sphere with a mouth and a central eye, ten eye-tipped tentacles on the top), there is a great variety of beholder subspecies. Some have obvious differences, such as those covered with overlapping chiton plates versus those with smooth hides, or those with snakelike eye tentacles versus ones with crustaceanlike joints. But something as small as a change in hide color or size of the central eye can make two groups of beholders sworn enemies. Every beholder nation declares its own unique body-form to be the "true ideal" of beholderhood, the others being nothing but ugly copies, fit only to be eliminated.

The ultimate of a beholder tyrant ship shares the same body-form as its brood. The orbi, however, remain a curious exception to this idea of racial purity and remains exempt from the beholders' subspecies warfare. This may be because the beholders need the orbi to survive, or they recognize the similarities of the orbi over those obvious differences. When beholder ships battle, the victims will take on the orbi from the losers for their own ships, while the other beholders and the ultimate will be slain and eaten by the victors.

As a result, the most common recipient of an attack by a beholder ship is another beholder ship. This allows most spaceborne races to breathe easier, but there are still enough cases of tyrant ships attacking other races (for reasons real or imagined) that most races stay away from the beholders.

In addition to the beholder ships themselves, there are often beholder outcasts, individuals that have survived the elimination of the rest of their nest, or that were cast out for having some odd mutation (ranging again from different colored hides to an eyestalk that functions differently). One beholder whose death ray functions like a *detect lie* spell fled from his fellows and operates as a bartender on the Rock, his alignment slipping toward neutrality. The beholder-barkeeper, named Large Luigi by its patrons, uses its telekinetic eye to mix drinks, and its *sleep* and *charm* eyes to keep the peace.

Ecology: The reproductive process of the beholder is unknown, and for those who are interested in continued life, probably will remain so. The core racial hatred of the beholder race is likely based in the nature of reproduction, which seems to produce identical (or nearly so) individuals with only slight margin for variation.

Dragon

CLIMATE/TERRAIN:	Any space, prairie
FREQUENCY:	Rare
ORGANIZATION:	Herd
ACTIVE CYCLE:	Day
DIET:	Herbivore
INTELLIGENCE:	High (14)
TREASURE:	M, Q
ALIGNMENT:	Lawful good

NO. APPEARING:	3-18
ARMOR CLASS:	5 (3)
MOVEMENT:	18
HIT DICE:	6
THACO:	15
NO. OF ATTACKS:	2 or 1
DAMAGE/ATTACKS:	1-4/1-4 or by weapon
SPECIAL ATTACKS:	Nil
SPECIAL DEFENSES:	Nil
MAGIC RESISTANCE:	Nil
SIZE:	L (10-12' long)
MORALE:	Average (10)
XP VALUE:	270

The dragons are a sentient race of dragon-centaurs that have recently appeared on the fringe of the Known Spheres. Dragon exploration ships have been spotted in the phlogiston and at the edges of known space. They are just beginning to appear at the smaller communities of space.

A dragon is centaurlike in appearance, with the body of a brontosaur, the torso and arms of a human, and the head of a dragon. Its feet are flat, like those of an elephant, and it has a long, snake-like tail. Its hands have six digits (five fingers and a thumb) and end in claws.

Dragons speak their own language and that of dragons. They speak the common tongue haltingly and with a thick accent. Their speech is often formal and ornately ceremonial.

Combat: Dragons found in space will be found on ships with spelljamming helms. These are usually modified galleons, but there have been cases of hammerships appearing among the dragons.

The dragons consider themselves civilized, and have among themselves a stylized dueling code. Under this code, one challenges another, the challenged getting choice of weapons (swords, bare hands, etc.). The challenger then names the terms of the battle (to the death, to first blood, to half hit points, or to three falls, for example). Finally, the challenged names the place and time (within reason, though a dragon rhyme speaks of the Battle Eternal, in which heroes return each year to fight a single round of combat).

The dragons use these codes among themselves, but do not offer them to non-dragons. Should an individual outside the race offer such terms, the dragon would be honor-bound to adhere to them, within reason. (A single dragon will not accept a challenge from a mind flayer, unless said mind flayer pledges not to use its psionic blast.)

Dragons usually use thin-bladed long swords in combat, but are just as adept at holds and wrestling. Their long thumb-claws make them particularly dangerous; they use these to inflict 1-4 points of damage in hand-to-hand combat.

In addition to their swords, dragons carry large darts (1-6 points of damage, thrown 1/round, range of 20/40/60 yards) and halberds. The last is useful in space as a grappling hook, but is not



used in most common combat. It is most often used in formal duels and as a ceremonial tool.

Dragons are adequate metalsmiths, the equal of elves but less skilled than dwarves. They carry armor on board, to be ritualistically donned before entering battle. This improves their Armor Class to AC 3, if they have sufficient time to prepare.

Habitat/Society: The vegetarian dragons follow a strong herd instinct among their people, which carries through into space. A lone dragon is a rarity and a freak among its people, and the dragons prefer to travel in familial units, headed by the eldest dragon, male or female. Dragons separated from their family will take ill unless they find a method of recreating a familial unit, and individuals have been known to adopt non-dragons as pseudo-family members.

Sages assume that the most adventurous of the dragon species have traveled in the newest ships to new planets, but even so the dragons seem stuffy and passive, more content to retreat than fight. There are exceptions, in particular those dragons who have adopted humanoids into their family units.

The leader of a dragon herd is called a kaba. The choosing of a kaba is determined not by the strongest, nor the swiftest, but by means of a system of kinship relations that borders on the mystical. Dragons have a flair for genealogy, and through a long series of questions and answers can trace one dragon to another in a fashion that determines who rules the dragon herd. Cynical non-dragons believe that the dragons make up such relationships on the spur of the moment, relating old slights and favors in their attempts to determine precedence. If such is the case, this method of dealing with leadership shows that the quick-thinking and the crafty will tend to survive.

The kaba of the herd is assisted by the shalla, or high priest. Each herd, no matter how small, has a shalla, usually with clerical powers. The shalla is the keeper of ritual, the advisor of the kaba, and the healer of the people, if they have such. The shalla is a cleric of level 3-12, with the more powerful shalla usually found with larger herds. An additional shalla will be present for every 30 dragons. Dragon shalla draw their spells from the following

Dracon

spheres: Animal, Combat, Creation, Divination, Guardian, Healing, Necromantic, Protection, and Sun.

The dracon'ss' faith is a pantheistic religion that worships dracon equivalents of human, dwarven, and elven gods. They have gods of war, fertility, storms, and the sea. Unlike most human gods, the dracon gods are always pictured together in a huge herd, moving together and led by the Ub-Kalla, or Full Leader. The Ub-Kalla is a god of leadership and wisdom, and knows the correct course in every situation. To be called Ub-Kalla by a dracon is considered to be a high honor, for your decision-making is compared favorably with dracon thoughts.

When dracon herds meet, the first order of business is to determine who is the kaba of the entire group, empowered to make decisions. This is done in the odd fashion of relationships and favors exchanged between groups. There is no shame for a deposed kaba taken from his post by a new kaba that outranks him—the position is a duty, and the reward for such duty is that someone more powerful will come along and give you a rest.

Ecology: The familial relationships of dracons suggests that they are all natives of the same planet, and only recently have made the first steps out into the stars. This is confirmed by the fact that most dracon ships resemble old seaborne clunkers favored by groundlings, with higher ceilings to accommodate the taller beings.

According to the dracons, their homeworld is a dry, arid orb with two types of terrain, fast-growing grass and desert. The climate is in continual flux, such that the herds are forced to move and cooperate in order to survive. There seem to be no natural enemies on their homeworld, but there are tales of a spiderlike Dark God that lies beneath the sand and pops up to trap the youngsters that stray too far from their parents. This boogeyman may be a

real creature, or the product of the herd mentality. The dracon faith makes heavy use of imagery of the Dark God as an enemy and a tempter. The semblance between this Dark God and the spiderlike neogi may be a coincidence or the result of real encounters with the slaving race. Whatever the cause, the dracons hate spiders in general and the neogi in particular.

The dracon world has large, shallow seas, and at least one large moon. Beyond that, the dracons are reluctant to share more information about their homeworld, perhaps in fear of other races finding them. One suggestion has been made that the dracon ships encountered so far are lost, and do not know how to get back to their home. Another is that the dracons are cautious about strangers. Given a lack of known predators, it may be that there are few other creatures on their planet, and they are unwilling to encourage other visitors until they are ready.

Dracon relationships with humans, mind flayers, elves, and dwarves are cordial and curious: all these races are lumped under a word for "the deformed," and the dracons, usually very good at sorting out their own differences, often ascribe human traits to elves, and elven abilities to dwarves (they can never figure out who operates the big rock-ships). Lizard men get along very well with the dracons, and are often adopted into larger families as disabled smaller relatives. Centaurs and other similar races are considered long-lost allies as well. They hate the neogi, putting dracons in good stead with other races, but consider the beholders comical. Beholder jokes make the rounds among dracons, comparing them to large kickballs used in ritual games on their home world. How long this situation lasts remains to be seen. The race of dracons holds dragons in awe. The shalla have declared dragons to be messengers of their gods, and their actions are watched carefully for signs of the gods' wants or intentions.

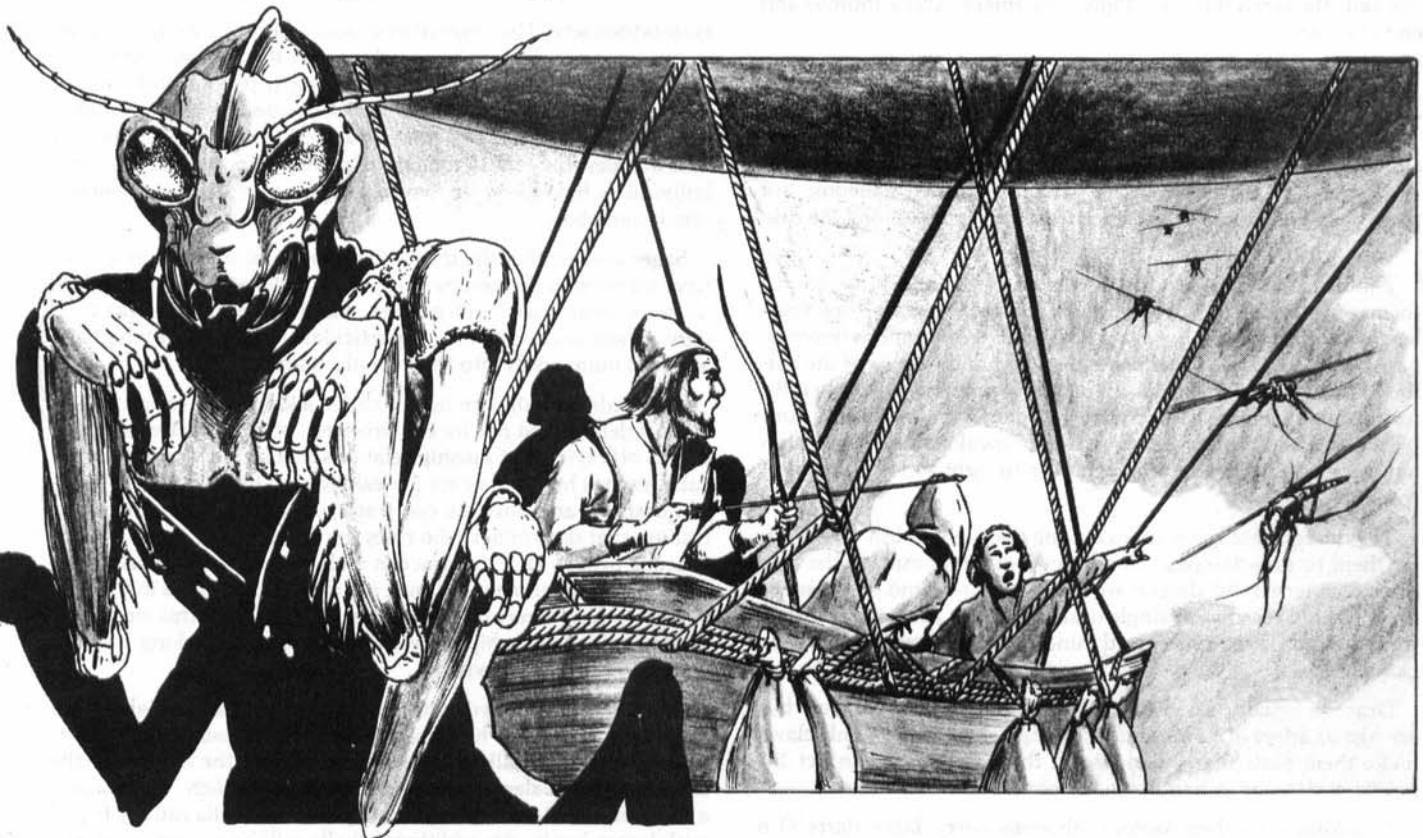

Dragon, Radiant (Celestial)

CLIMATE/TERRAIN:	Any space
FREQUENCY:	Very rare
ORGANIZATION:	Solitary or clan
ACTIVE CYCLE:	Any
DIET:	Special
INTELLIGENCE:	Exceptional (15)
TREASURE:	Special
ALIGNMENT:	Any

NO. APPEARING:	1 (2-5)
ARMOR CLASS:	1
MOVEMENT:	12, Fl 48 (B)
HIT DICE:	15
THACO:	5 base
NO. OF ATTACKS:	3 + special
DAMAGE/ATTACKS:	2-20/2-20/4-40
SPECIAL ATTACKS:	Special
SPECIAL DEFENSES:	Variable
MAGIC RESISTANCE:	Variable
SIZE:	G (100' base)
MORALE:	Fanatic (18)
XP VALUE:	Special



Age	Body Lgt(')	Tail Lgt(')	AC	Breath Weapon	Priest Spells	MR	Treas. Type	XP Value
1	1-20	2-20	4	2d12+1	2	Nil	Nil	4,000
2	21-60	21-60	3	4d12+2	2/2	20%	Nil	7,000
3	61-80	61-80	2	6d12+3	2/2/2	25%	Nil	12,000
4	81-110	81-120	1	8d12+4	4/2/2/2	30%	E,R,T	14,000
5	111-140	121-150	0	10d12+5	4/4/2/2/2	35%	H,R,T	18,000
6	141-200	151-220	-1	12d12+6	4/4/4/2/2/2	40%	H,R,T	19,000
7	201-250	221-270	-2	14d12+7	6/4/4/4/2/2/2	45%	H,R,T×2	20,000
8	251-300	271-350	-3	16d12+8	6/6/4/4/4/2/2	50%	H,R,T×2	21,000
9	301-350	351-425	-4	18d12+9	6/6/6/4/4/4/2	55%	H,R,T×2	22,000
10	351-400	426-500	-5	20d12+10	8/6/6/6/4/4/4	60%	H,R,T×3	23,000
11	401-500	501-600	-6	22d12+11	8/8/6/6/6/4/4	65%	H,R,T×3	24,000
12	501-600	601-800	-7	22d14+12	8/8/8/6/6/4/4	70%	H,R,T×4	25,000

The radiant dragon, also called the *star dragon* or the *celestial dragon* (though not to be confused with the oriental dragon of the same name), is a sinuous, serpentine dragon with graceful, translucent wings. Its scales are a collection of glittering pearl-like shards of mica and gypsum, which cause the dragon's scales to shimmer in the starlight, giving the creature its name.

Radiant dragons can be of any alignment, unlike the tendencies toward good and evil of the chromatic and metallic dragons. There exist radiant dragons who terrorize the spaceways, those who act in a beneficial fashion, and those who prefer to set themselves up as whimsical king-gods on small, distant worlds. As a class, the radiant dragons are proud, haughty, and feel they are the ultimate in draconian development: they are, after all, the largest of their type.

Radiant dragons speak their own language and the common tongue. They are quick with languages and fond of mimicry, so they tend to speak in a number of accents matching those of the individuals they talk with. There is a 10% chance that even a hatchling will understand any given tongue, with an increase of 5% for every age.

All common dragon attributes outlined in the *Monstrous Compendium* apply to radiant dragons as well. Modifications to the general description that apply specifically to fantasy space are listed below.

Combat: Actions of a radiant dragon depend on the situation and the individual. They rarely flee from a fight, however, depending on their huge size to keep them safe from opponents.

A radiant dragon will concentrate on the ship itself first, seeking to first destroy or eliminate any serious threats (such as ballistas and catapults). Of equal importance is elimination of the mages and any with magical powers. If the radiant dragon is aligned toward good, he will seek to neutralize them with *silence*, 15' radius spells (if available). If less concerned about killing, he will merely slay hostile wizards as he finds them.

The wing buffet used by young adult and older dragons is particularly potent in the small space of a ship, and has the effect of a "Ship Shaken" critical hit, and in addition inflicts 2-20 points of damage to all within the range of the attack (about 200 feet to either side).

In addition to the tail slap used by the radiant dragon against groups of creatures, the radiant dragon may grip a ship in the coils of its tail and inflict damage per round by squeezing it. The damage is 1-6 hull points against lighter materials such as wood or ceramic, but particularly heavy materials, such as stone and metal, suffer only 1-4 hull points damage. The dragon can make other attacks, and even attack other ships, while squeezing a ship.

As a general rule, radiant dragons will give a ship and crew the opportunity to leave, parley, or generally bow and scrape and beg

Dragon, Radiant (Celestial)

for its kindness and mercy. Even the smallest of these creatures has an overweening sense of pride.

Breath Weapon/Special Abilities: The radiant dragon breathes glowing pulses of force that in some ways resemble *magic missiles*. They can breathe a single pulse of the listed damage, or any number of smaller pulses in the same round, provided that no pulse inflicts less than 2d12 + 1 points of damage. A juvenile radiant dragon (age 4) can breathe a single pulse of 8d12 + 4 points, or four pulses of 2d12 + 1 points, or two pulses of 4d12 + 2 points. Each pulse can strike a separate target. These pulses are unerring in their attacks, and will hit unless the victim makes a saving throw vs. breath weapon. If the victim fails its saving throw, it will be struck for the listed damage. If the victim makes its saving throw, it has dodged that pulse, which then evaporates.

The radiant dragon can use its breath weapon on physical objects (such as a ship) as well, inflicting 1 hull point of damage for every 10 hit points of damage its breath weapon causes. Other physical objects must save vs. spell to survive being hit by a pulse.

As radiant dragons age, they gain a number of innate abilities. Juvenile dragons can *restore* or *corrupt air* as per the spell. A young adult they may use the *Bigby's interposing hand** spell, while adults can use the *Bigby's grasping hand** spell. A mature adult can *shapechange* three times in a standard day, gaining the abilities of the creature that it mimics, even to the point of spells and magical ability. Venerable radiant dragons can create a *wall of force* (as the wand), and a wyrm can use *forcecage* (as the spell). A great wyrm can create a *prismatic sphere* large enough to encapsulate itself and up to 4 other creatures of similar size, and to maintain it indefinitely.

*The radiant dragons refer to these as the *interposing claw* and *grasping claw* spells, and will declare loudly that this Bigby is an interloper who obviously stole their spells and gave them his name. A careful check by the sages indicate that the reverse is true: These spells did not appear commonly among the radiants until Bigby developed them. However, given the size and temperament of those dragons making the claim, few have chosen to argue the point with them.

Habitat/Society: Radiant dragons are totally spaceborne—indeed, their huge size would make them ungainly creatures on most worlds. Mature adults do mingle among mere mortals, often taking the face and the role of an adventurer or hero as the dragon passes through the asteroid citadels. A character who is faced with unpaid bills for services from places he has never visited may guess that his renown is great enough to earn him the mimicry of a radiant dragon. In some regions this is considered a great honor (once it is confirmed by *detect lie* and other divination spells). In other areas of space it is considered a blasted nuisance.

The radiant dragons are normally solitary and very territorial about their "turf," which can include up to the space surrounding a planet or moon. When they are found in numbers, they are usu-

ally a family group, and make their lair in an asteroid hollowed out by the parents. Some hollow asteroids that are used by certain human civilizations were created by these dragons.

When in family groups, radiant dragons are very protective, and slaying the young is a sure way of earning a radiant dragon's enmity. It will hunt down the individual responsible, devising nasty methods of revenge as it goes. There is a giff saying: "Better to be slain by a star dragon quickly, before it has a chance to think about it."

Ecology: Radiant dragons can survive long periods in space. They are sometimes seen near fire bodies with their wings spread, gliding on the heat, and it is surmised that they can take the energy from such celestial bodies and store it in their bodies, much like the kindori. However, a selfish and hungry radiant dragon can just as easily descend on an asteroid citadel and clean out all other living things (particularly if it considers the asteroid its "own" from an earlier stage of life).

The clerical spell ability of the radiant dragons may make them the only living creatures of such great bulk to be natural spelljammers. They move in this fashion as a cleric with as many levels as the dragon's age when piloting a major helm, and the dragons can do so at will without tiring. On occasion they have used this ability to rescue or tow wrecked ships (in return for a promise of reward, or a statue in their name at least). Radiant dragon hatchlings stay close to their lairs and the protection of the parents, but sometimes they also sneak out and do some spelljamming.

It is unknown if the radiant dragons have spelljamming ability naturally or as the result of some deal with the arcane. One school of thought indicates that the radiant dragons are the only natural spelljamming creatures, and the arcane use them to make their helms. A second school believes that the radiants gained this ability from the arcanes in exchange for transportation or other favors. The truth has yet to be revealed. The arcane and the radiant dragons, when brought into contact, have little to say to each other.

The radiant dragons are friendly with dracons and lizard men, whom they encourage to worship them at every chance. They are haughty toward men, elves, halflings, and most mammal-based races. They consider mind flayers, beholders, and neogis to be genetic failures that have not had the sense to die off. This opinion is reciprocated by those races, which hunt the radiants whenever they have a chance and think they can beat them. In addition, radiant dragons are occasionally attacked by the largest krajen.

Radiant dragons can be encountered in any wildspace area and in the phlogiston. Their great size gives them their own atmospheric envelope, but unlike the similarly huge kindori, they do not encourage riders, and will often preen their scales to remove krajen spores and other hitchhikers. Their clerical abilities operate in any sphere that has dragons as a native life form. In those rare spheres without dragons, they still retain first and second level spells and their spelljamming ability.

Elmarin

CLIMATE/TERRAIN:	Wildspace only
FREQUENCY:	Rare
ORGANIZATION:	Pack
ACTIVE CYCLE:	Any
DIET:	Warmth
INTELLIGENCE:	Animal (1)
TREASURE:	None
ALIGNMENT:	Neutral

NO. APPEARING:	1-10
ARMOR CLASS:	4
MOVEMENT:	18
HIT DICE:	5, 7, or 9
THACO:	5 HD: 15 7 HD: 13 9 HD: 11
NO. OF ATTACKS:	1
DAMAGE/ATTACKS:	1-8
SPECIAL ATTACKS:	Burns
SPECIAL DEFENSES:	Nil
MAGIC RESISTANCE:	Nil
SIZE:	S (4' across)
MORALE:	Unreliable (3)
XP VALUE:	5 HD: 175 7 HD: 420 9 HD: 975

The creatures called elmarin resemble living St. Elmo's fire. They are semisentient fire beings that live in wildspace, usually in close proximity to fire-based celestial bodies. They appear as naturally glowing balls of fire in a number of colors, ranging from deep red to light violet. Two darker spots toward the front of the orb resemble eyes.

Combat: The elmarin are drawn by warmth and energy. The activity of a spelljamming ship is such to attract a pack of them to investigate. They are often more curious than harmful, zipping about the rigging and through open hatchways, bouncing off the walls and leaving large scorch marks.

Once in contact with flammables, however, they start inflicting damage. Each round, an elmarin can cause flammables within 5 feet of it to burst into flame, starting fires throughout the ship. This is unintentional on the elmarin's part, but no less damaging. If attacked, the elmarin will attempt to escape, burning through decks and walls as it can. The elmarin's fire has no effect on stone or metal.

If trapped, the elmarin will turn on its attacker and try to burn it. It will inflict 1-8 points of damage per round, and cause all burnable items (cloaks, scrolls, etc.) on the body to make a saving throw vs. fire or be destroyed.

If reduced to 0 hit points, the elmarin fades into nothingness and dies. There is a 1 in 20 chance that the death of an elmarin will leave behind an *ioun stone*.

Habitat/Society: Elmarin are elemental creatures of fire, with little intelligence above the animal level. They enjoy the relative coolness of space above the surface of fire-based celestial bodies (such as suns) and can often be found here dancing, bobbing, and weaving about. Ships that are attacked and damaged by the elmarin are usually the victims of the creatures' curiosity rather than maliciousness.

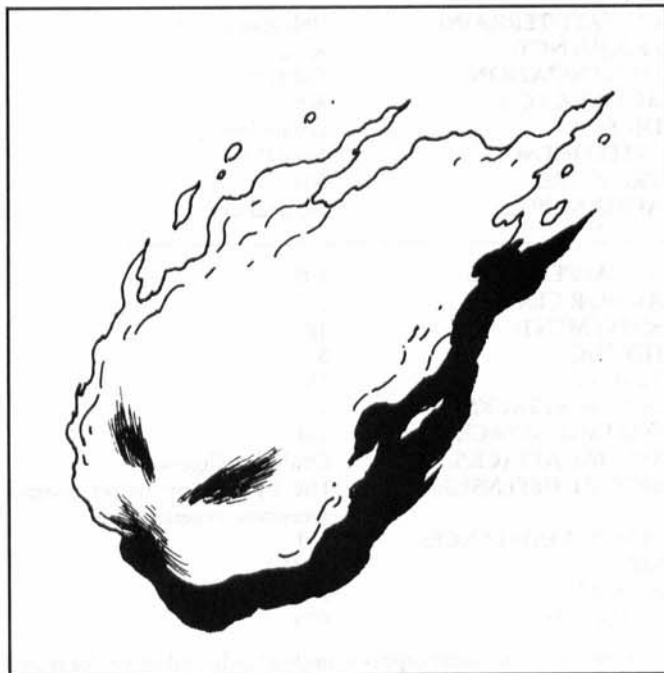

The size and color of an elmarin seems unrelated to its power or whether an *ioun stone* will be found after its death. Profiteering gnomes in their steel ships sometimes cruise the upper reaches of stars looking for elmarin, willing to slay many to gain a few *ioun stones*. The sudden appearance of elmarin is a good sign to sailors trapped with a furnace drive and no magic to feed into it.

Ecology: The elmarin are natives of the elemental plane of fire, and as such will not leave the wildspace that they are in. Attempts to take them into the phlogiston will result in their immediate detonation, unless they are in a completely sealed box or extra-dimensional space. Such detonation will result in 1d8 fire damage for each hit die of the elmarin to all within 20 feet of the creature, and all flammable items in that area immediately catch fire (subject to saving throws), causing more detonations in the Flow.

Elmarin produce by fission and are sexless. They lack the ability to move at the high speeds generated by spelljamming craft, but will drop into the air envelopes and tag a ride with passing craft.

Attempts to domesticate the elmarin have failed, save for certain mages, who use special variations of spells that conjure and command elemental creatures. They are generally useless minions, and are feared even by the explosion-loving giff, who at least recognize their potential for causing damage.

A legend involving elmarin goes as follows: A mage thought he had discovered a method to domesticate the elmarin and fit them into a special harness they would not burn through. He hooked the harness to a sled and commanded the elmarin to fly. This they did, on a direct course for the surface of the sun. Whether the tale is true or intended as a cautionary legend is unknown.

Ephemeral

CLIMATE/TERRAIN:	Phlogiston only
FREQUENCY:	Rare
ORGANIZATION:	Solitary
ACTIVE CYCLE:	Any
DIET:	Living beings
INTELLIGENCE:	Very (11)
TREASURE:	Nil
ALIGNMENT:	Neutral evil

NO. APPEARING:	1-8
ARMOR CLASS:	2
MOVEMENT:	18
HIT DICE:	5
THACO:	15
NO. OF ATTACKS:	1
DAMAGE/ATTACKS:	1-4
SPECIAL ATTACKS:	Drain Intelligence
SPECIAL DEFENSES:	Hit by +1 or better magical weapons, regeneration
MAGIC RESISTANCE:	Nil
SIZE:	M (6')
MORALE:	Average (9)
XP VALUE:	975

Ephemerals are noncorporeal undead believed to be the spirits of individuals who have died in the phlogiston. They appear as dusty gray humanoids, and it is thought that their forms are not only linked to the negative material plane, but also impregnated with the essence of the phlogiston itself. This makes them vulnerable to fire, but also gives them the ability to regenerate their unliving status. Ephemerals are attracted by use of magical energy, and a passing spelljammer helm might attract a group of them.

Combat: The touch of the ephemeral inflicts 1-4 points of damage and reduces the victim's Intelligence by 1-2 points. Should the damage inflicted by an ephemeral kill a sentient humanoid, the latter will become an ephemeral in 2-8 days. Should an ephemeral drain all the Intelligence from a sentient humanoid, the body will then become the host of the ephemeral (see below).

In hand-to-hand combat, only magical weapons have any effect on ephemerals. As undead, they are immune to *sleep*, *charm*, and *hold* spells, as well as cold-based attacks. They are vulnerable to fire, and always take maximum possible damage from a fire-based attack. However, since ephemerals are only found in the Flow, this type of attack is very risky.

Ephemerals can regenerate 1 hit point every melee round by pulling the surrounding phlogiston into their bodies. If sealed off in some fashion from the Flow, they will be unable to regenerate. When an ephemeral reaches 0 hit points, it dissipates permanently.

Generally, ephemerals cannot be turned, but this is the result of the inability of clerics in the Flow to contact their patron's powers. If a priest has some form of contact with his or her power, an attempt to turn ephemerals can be made, and in this case ephemerals can be turned as spectres.

Ephemerals will attack as a pack, if possible, seeking to drain as many humanoids as possible to use as bodies. The others will be slain and cast overboard. If seriously damaged, they will break off, trailing behind the ship, and attack again when they have regained their hit points.

Habitat/Society: Ephemeral packs wander the phlogiston, the disembodied spirits of the dead or cursed who have perished in the Flow. Unable to reach their home spheres and the rewards (or



punishments) of their afterlife, they tend to be mean, petty spirits who exist only to eventually return to a final resting place.

The living are their vessels of return, and an ephemeral will attempt to drain the mind of a single character in order to provide itself with passage to a safe sphere. Ephemerals cannot enter the crystal spheres except when controlling a living body and, if forced to do so, they will be randomly teleported deeper into the Flow.

Ecology: The origin of the ephemerals is a mystery. They might be the remains of a race of beings who managed to crack their crystal shell, letting the phlogiston into their sphere. Whatever their origin, they have propagated by preying on intelligent creatures that pass through the Flow. Men, mind flayers, and neogi have all had to battle ephemerals in their transit between the spheres.

Ephemeral Host

The physical characteristics of an ephemeral host are those of the host body. Thus, a host body vulnerable to normal weapons remains so while the ephemeral is present, and does not acquire the ephemeral's special vulnerability to fire or its ability to regenerate using phlogiston. If the host body is killed, the ephemeral can't use it. Magic that counters the *magic jar* spell is also effective against ephemeral occupation.

An ephemeral within its host immediately sets about returning to a crystal sphere. This often, but not necessarily, involves slaying anyone who would stop it, including former allies. The ephemeral will use the physical abilities of the individual it takes over, but cannot use any magical or special abilities. An ephemeral could take over a mind flayer, but could not use its mental blast.

When the host enters a crystal sphere, the ephemeral will immediately flee the body, leaving it a living, mindless shell of 0 Intelligence. The body can be restored to normal Intelligence by a full *wish* spell, but in the meantime, it may be inhabited by other bodiless spirits unless protected by means of a *protection from evil (good)* spell or similar wards.

Giff

CLIMATE/TERRAIN:	Any
FREQUENCY:	Rare
ORGANIZATION:	Platoon
ACTIVE CYCLE:	Day
DIET:	Omnivore
INTELLIGENCE:	Low (7)
TREASURE:	Nil
ALIGNMENT:	Lawful neutral

NO. APPEARING:	10-20
ARMOR CLASS:	6 (2)
MOVEMENT:	6 base
HIT DICE:	4
THACO:	17
NO. OF ATTACKS:	2
DAMAGE/ATTACKS:	1-6 +7 or by weapon +7
SPECIAL ATTACKS:	Head butt
SPECIAL DEFENSES:	None
MAGIC RESISTANCE:	10%
SIZE:	L (9' tall)
MORALE:	Elite (14)
XP VALUE:	270

The giff are a race of powerfully muscled, hippopotami mercenaries. They are civilized in that they understand the basics of spelljamming, though they lack mages among their own race. Instead, they hire on with various groups throughout the universe as mercenaries, bodyguards, enforcers, and general leg-breakers. They are pretty good at it, too.

The basic form of the giff is humanoid, with stocky, flat, cylindrical legs and a humanoid torso, arms, and fingers. The chest is broad and supports a neckless head that looks like a hippopotamus's. Giff come in colors ranging from black to gray to a rich gold, but many have colorful tattoos that leave their bodies a patchwork record of past jobs and victories. Giffs speak their own language and the common tongue.

Combat: The giff are military-minded, and organize themselves into squads, platoons, companies, corps, and larger groups. The number of giff in a platoon varies according to the season, situation, and level of danger involved. A giff "platoon" hired to protect a gambling operation may number two, while a platoon hired to invade an illithid stronghold may number well over a hundred.

The giff pride themselves on their weapon skills, and any giff will have a number of swords, daggers, maces, and similar tools on hand to deal with troublemakers. In giff terms, a troublemaker is any non-giff one's boss tells him is a troublemaker. Giff will collect weapons as well, accumulating pole arms from half a hundred worlds and being able to tell the origin and purpose of said arms, and what they killed most recently.

But the giff's true love in weaponry is guns. Their love of explosives serves as a good warning to other races. Any giff will have a 20% chance for an arquebus (or, rarely, a wheel lock) and sufficient smoke powder for 2-8 shots. A misfiring weapon is of little matter to the giff (occasional fatalities are expected)—the flash, noise, and damage is what most impresses them.

Even unarmed, the giff are powerful customers, as strong as a hill giant (+7 on damage for Strength benefit). They will wade into a brawl just for the pure fun of it, tossing various combatants on both sides around to prove itself the victor. A brawler should only pull a weapon on a giff in the most dire circumstances. Once a weapon is bared, the giff consider all restrictions off—the challenge is to the death.



The unarmed giff also uses a head butt in attacking. The top of the giff's head and snout are plated with thick, chitinous plates, flexible enough to permit motion, but giving the creature a natural helmet. The giff can charge using the head butt, inflicting 2-12 points of damage on his foe.

The giff prize themselves as mercenaries, and to that end have made elaborate suits of armor that improve their Armor Class to 2. These include full helms with other monsters on their crests, and inlaid ivory and bone along the large plates. Armor repair is a major hobby among the giff.

Finally, giff are somewhat magic resistant. They are deeply suspicious of magic and magical devices, and only accept spelljammer helms with deep misgivings, since they are needed to bring the giff into battle.

Habitat/Society: The giff are happiest among their own race—they consider larger races such as giants threatening and complain about the fragility of the smaller races. Unlike the dragons, they suffer no penalties for being apart from their fellows, but merely prefer the company of their own species. Outside their own platoons, the giff are happiest among military organizations with a strong chain of command.

Every giff, male, female, and giffing, has a rank within society, which can only be changed by someone of higher rank. Within this rank are subranks and within those subranks are color markings and badges. The highest-ranking giff gives the orders, the others obey. It does not matter if the orders are foolish or even suicidal—following them is the purpose of the giff in the universe. A quasi-mystical faith among the giff mercenaries confirm that all things have their place, and the giff's is to follow orders. This makes the giff very happy.

Giff platoons can be hired by those looking for their muscle. The arcane do a small business in giff mercenaries, but usually local contractors perform the task. These contractors review prospective employers according to ability to pay, then make a recommendation to the giff leaders. The leaders, in turn, consider the danger of the job, and whether taking it will enhance their giffdom.

Giff

Giff jobs are usually paid in smoke powder, though they often will accept other weapons and armor. It is purely a barter system, but to hire one giff for one standard week requires seven charges of *smoke powder* (one/day). In areas where smoke powder is more common, the price will rise.

On board ship, the giff have their own quarters, and will often request to bring on their own large weapons. They favor greek fire projectors and bombards for ground work, and will happily blaze away at opponents, regardless of the tactical situation.

The giff require the ships of others because they have no spell-casting abilities among them—they are magically inert in such a way that even the serial helms of the mind flayers have no effect on them. Lifejammers are considered to be a "wizard's way to die" (a giff insult). Giff trade their services for transport and for weapons—especially smoke powder.

Giff of both sexes serve in their platoons, and both fight equally well. Giff young are raised tenderly until they are old enough to survive an exploding arquebus, then are inducted fully into the platoon.

Giff are fierce fighters, despite their somewhat comical appearance and mania for weapons. They will not, however, willingly fight other giff. If forced into such a situation on a battlefield, both groups will retire for at least a day of drinking and sorting out ranks. There is a 10% chance that one platoon will join an-

other in this case, but most likely both will quit their current hirings and look for work elsewhere.

Ecology: Like the dracon, the giff are surmised to have evolved from one world, which was not blessed with a wide variety of intelligent species such as elves, men, dwarves, and beholders. Sages point to the giff as an example of what happens when only one sentient species is found on a planet.

The giff homeworld is the stuff of legend; as no living giff has seen it. Some tales say that the homeworld was destroyed by the giff, who were rescued by the arcane. Others say that the giff sold their planet and their lives to the arcane in exchange for spelljamming helms they could not use. Still others say that the giff homeworld is just beyond the range of one's ship, in a land where such warrior races are common, and the losers are exiled to the known worlds.

Whatever the truth, the giff describe their homeworld in legendary terms—a thick, verdant jungle, covered with swamps, mangrove trees, and fruit plants. The few mountains are rich in metals, caches of weapons, and smoke powder.

The giff practice equality among the sexes in battle and in child-rearing. They live about 70 years, but do not take aging gracefully. As a giff grows older and begins to slow down, he is possessed with the idea of proving himself still young and vital, usually in battle. As a result, there are very, very few old giff.

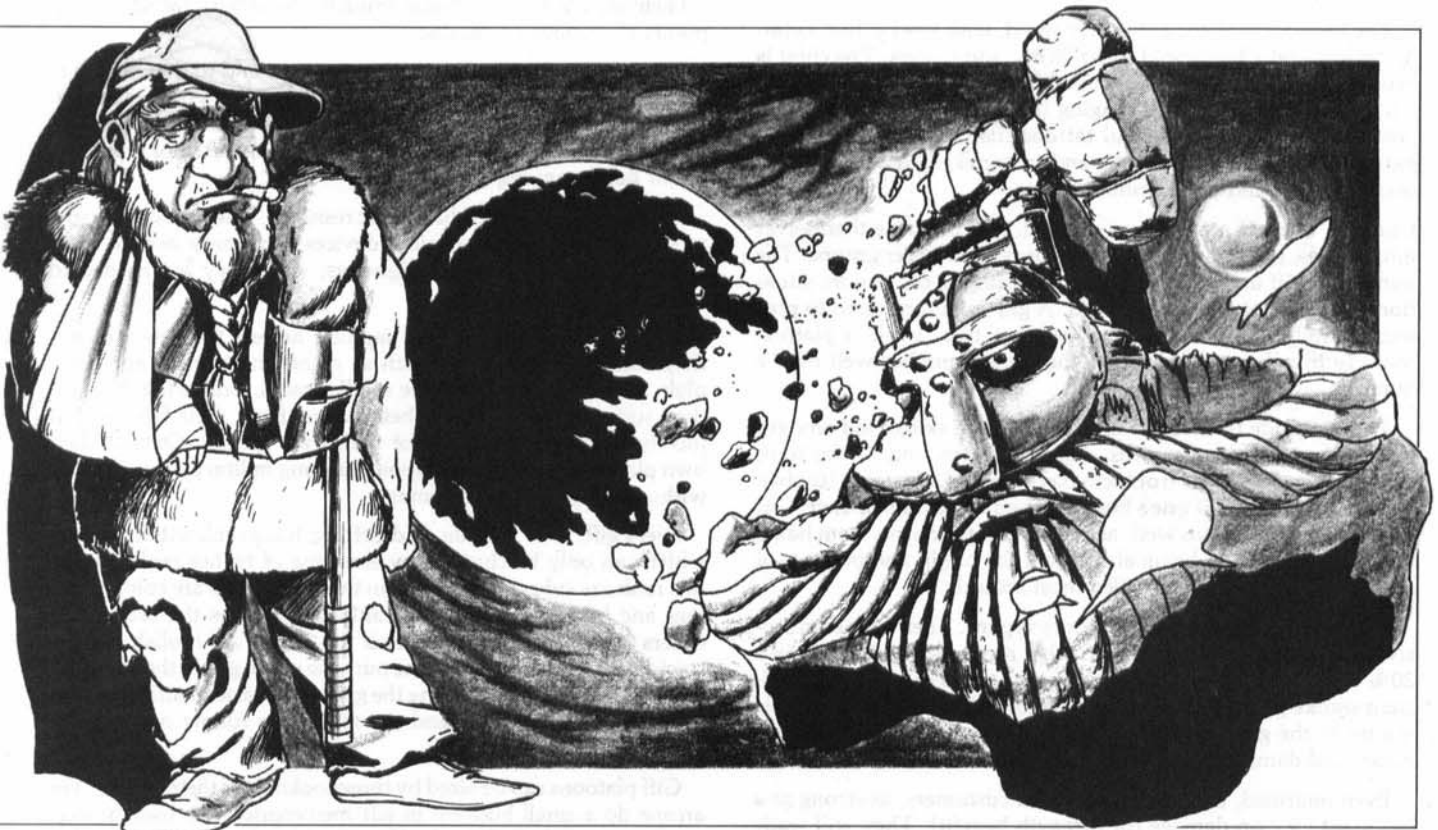

Kindori (*Space Whale*)

CLIMATE/TERRAIN:	Any space
FREQUENCY:	Uncommon
ORGANIZATION:	Pod
ACTIVE CYCLE:	Any
DIET:	Light
INTELLIGENCE:	Low (6)
TREASURE:	Nil
ALIGNMENT:	Lawful neutral

NO. APPEARING:	2-8
ARMOR CLASS:	5
MOVEMENT:	18
HIT DICE:	20
THAC0:	3
NO. OF ATTACKS:	1 (tail)
DAMAGE/ATTACKS:	3-30
SPECIAL ATTACKS:	Blinding
SPECIAL DEFENSES:	Nil
MAGIC RESISTANCE:	5%
SIZE:	G (80')
MORALE:	Elite (13)
XP VALUE:	11,000

Kindori are called *space whales*, and they are among the largest living creatures found in space. They resemble aquatic whales in general shape and are mammals as well. However, they lack any noticeable mouth, and the leading edge of their fishlike bodies is dotted with small eyes.

Combat: The kindori tend to be peaceful except when threatened. In normal conditions, this usually means a direct attack, but during herding periods (see *Habitat/Ecology* below), any individual approaching the herd is seen as a danger.

The kindori's main physical weapon is its massive tail flukes, which it uses to batter its opponents. While kindori recognize the presence of humans, beholders, and other small creatures, they direct such attacks first and foremost against the ships that are almost their size. The kindori work together to batter a single attacker to bits, then go to the next one, until all assailants are defeated.

The leading eyes of the kindori can emit a concentrated blast of light. This light is projected as a cone in the direction of the kindori's choice, with a 500-yard range and a base of 400 yards. All those within the cone must save vs. breath weapon or be blinded for 4-16 rounds. The kindori will use this form of attack against individuals they cannot beat, using the confusion it creates to escape.

Habitat/Society: The kindori travel in small groups, called pods, of 2-8 members. For large (7-8 member) pods, there will be a bull of maximum hit points present. This bull will be the forward line of defense if the pod is attacked.

Every so often (roughly annually, depending on the sphere), several pods will gather together into a larger herd of 3-30 members. There will be 3-6 bulls present in such a herd, and during this time, any ships that pass near the herds will be attacked.

During herding the male kindori are particularly violent, engaging in tail-slapping contests with other young males (and often with ships that come too close). These tail-slappings create a pecking order within the herd, which in turn determines the mating rights of the various members. The oldest bulls always have first rights among the females, followed by the more powerful young.

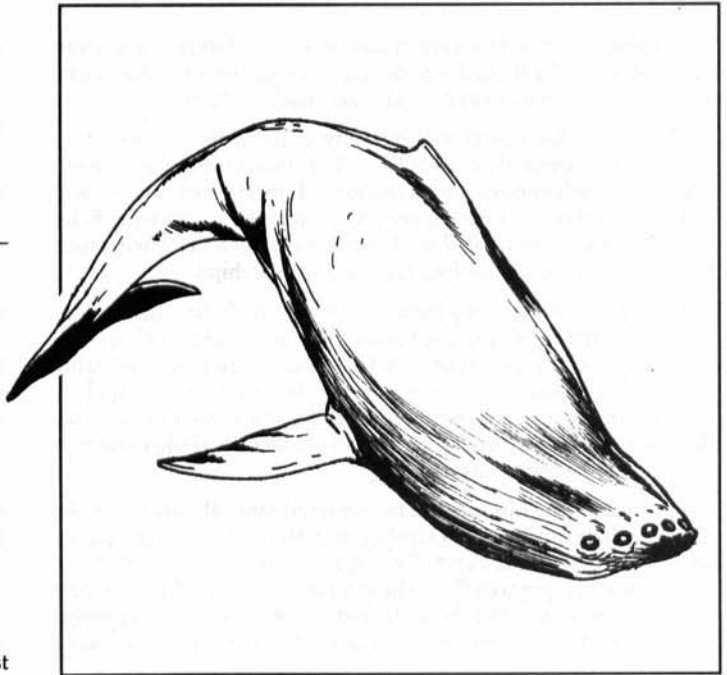

The kindori young gestate for six months and are born live in space. A herd will be extremely protective during this time, since the young are prey to scavvers and other attackers.

With these exceptions, kindori are generally peaceful and have been domesticated by a number of spaceborne barbarians. Such groups either travel short distances, such as within an asteroid belt, cluster, or ring; or are far-ranging space nomads making long voyages. The kindori is large enough to maintain its own gravity plane and air envelope, and has no need for air of its own.

The size of the kindori is such that mosses, molds, and other parasites nest on their large backs, which in turn brings other predators to clean them off. A kindori might (20% chance) have 3-18 gray or brown scavvers working over the growing population on their sides.

Some kindori that have been domesticated (see below) later go feral as their masters die or let them loose. These kindori sometime have the ruins of old buildings (generally called howdahs) on their backs, along with more terrestrial plant and animal life. Such structures and life survive only on the back and sides of the kindori.

Ecology: A kindori does not eat as do most other creatures of space. It instead soaks in the rays of the sun, stars, and other shining bodies in its area of space. The "belly" of the kindori is dotted with tiny white patches, each of which sends energy deep within the creature, to be stored within its large mass.

Keeping this belly clean of parasites is a common act of herd behavior, as the great creatures rub each other to flake off old skin and parasites. They are less concerned with their backs, which is why small islands of life often spring up there.

An extremely old or sick kindori can be spotted by the overgrowth of vines and vegetation on it. Such creatures are near death, and often fall prey to the larger scavvers and other creatures.

Even in death kindori are powerful creatures, as their skeletons do not break up when parasites destroy their flesh. Undead creatures such as lichens and vampires often use skeletal kindori as

Kindori (*Space Whale*)

their ships for slow, leisurely invasions of new lands (the undead have forever). Such dead kindori have 15 hull points, plus whatever modifications (weapons, etc) are made to them.

There have been stories of hitching a spelljamming helm to a kindori. It is generally agreed that the action of moving at spelljamming speeds spooks them, and even domesticated kindori will head off for parts unknown, seeking to scrape the irritating helm from their flesh. Some skeletal kindori have been fitted with such helms by undead marauders and used as warships.

The kindori have many natural enemies, including the krajen, the radiant dragons, and the various humanoid races. Beholders and mind flayers, sensitive to the creature's light-emitting eyes, have a particular dislike of them. The former will avoid kindori whenever possible, while the latter will engage in wholesale slaughter of them, massing armadas to take out whole pods that lie too close to their outposts.

The flesh of the kindori can be rendered into oil, much like the aquatic whale, and it is this kindori flesh that is the source of most greek fire for various races. The lizard men, who use greek fire regularly, often put together whaling parties to hunt kindori, and are working on a mobile base, towed in pieces by multiple wasp-class ships, that can render the flesh of the creature in the field.

Domesticated Kindori

Savage races in space will often use the kindori for short-range travel, usually in the period before they gain enough savvy and

trading goods to deal with the arcane on a regular basis. These "savage races" vary from empires ruled by philosopher kings, to degenerate standard races, to savage marauders who will attack everything in sight.

The kindori can be domesticated, but the savage races will operate in them in pod or herd groups, and will not split the kindori family groups. Only old solitary bulls will be found on their own, and then usually on exploration duty.

The savage races (which can be human, dwarf, elf, gnome, or even halfling) do not cut into the flesh of the kindori, but rather secure buildings, weapon platforms, and the like with short hooks that lightly snag the thick hide of the beast. The savage races will often maintain farms and herd terrestrial beasts on the backs of such creatures, since the kindori have no need of the atmosphere around them.

A typical kindori/savage race group will number some 2-8 kindori, each with a crew of 10-20 warriors. Dress and weapons vary from place to place, from bone spears to bronze armor and short swords. There will be at most one light catapult per kindori, save for the bulls, which can carry heavy catapults. The crew arrangements will be an extension of the savage's native group, with a captain or shaman or chieftain leading the herd.

The savages will trade with spaceborne races (if they are peaceful), but do not like or trust spelljammer helms, which make their mounts mad.

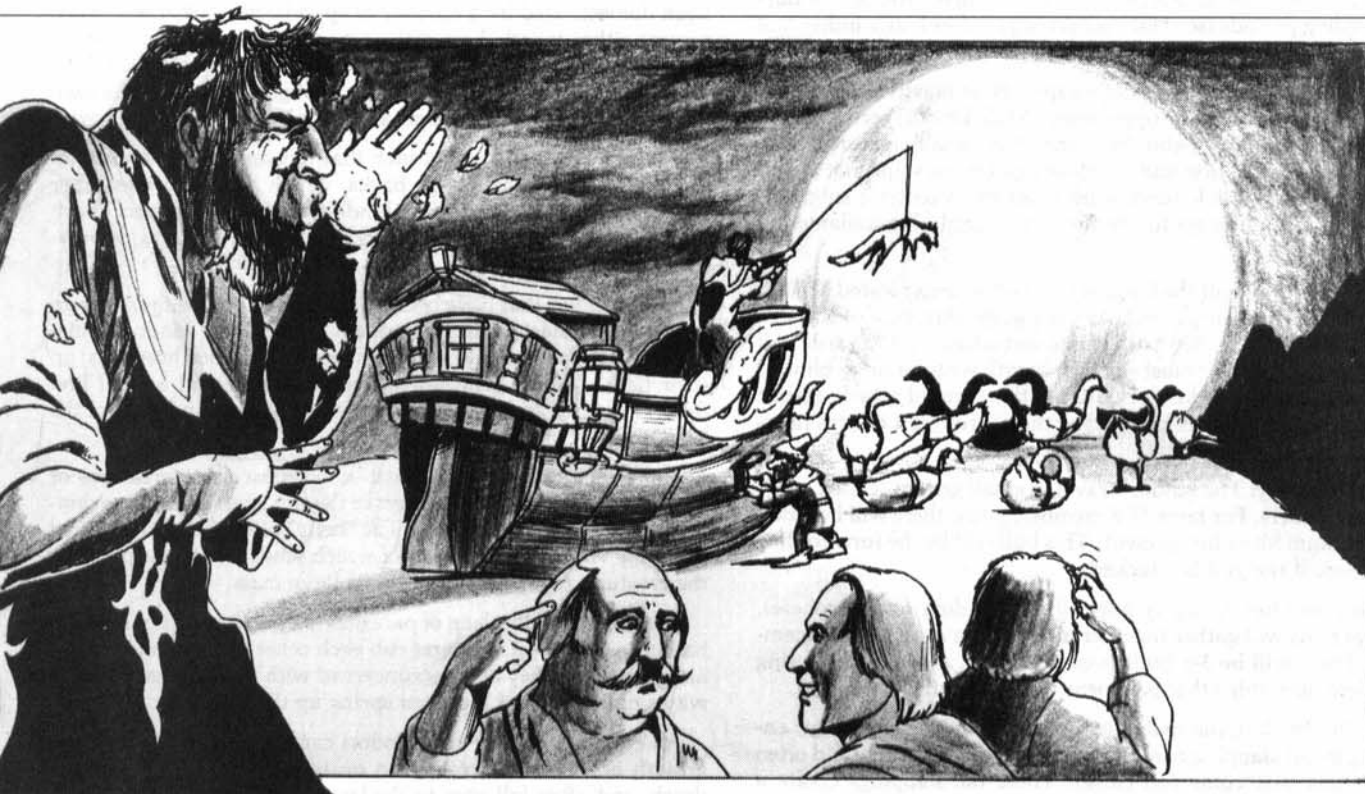

Krajen

	Immature	Adult
CLIMATE/TERRAIN:	Any	Any
FREQUENCY:	Common	Very rare
ORGANIZATION:	Colony	Solitary
ACTIVE CYCLE:	Any	Any
DIET:	Scavenger	Omnivore
INTELLIGENCE:	Non- (0)	Semi- (2)
TREASURE:	Nil	G
ALIGNMENT:	Neutral	Neutral

NO. APPEARING:	10-100	1
ARMOR CLASS:	9	3
MOVEMENT:	3	18
HIT DICE:	1/2	12
THACO:	20	9
NO. OF ATTACKS:	1	1 + 12
DAMAGE/ATTACKS:	1-3	3-18 and 1-3
SPECIAL ATTACKS:	Paralysis	Paralysis, crush
SPECIAL DEFENSES:	None	None
MAGIC RESISTANCE:	None	30%
SIZE:	S (1' high)	G (40' high)
MORALE:	Unsteady (7)	Elite (13)
XP VALUE:	35	8,000

The krajen develops in three stages: small spaceborne spores, a barnaclelike immature stage, and the huge, adult krajen that is the bane of the shipways. In its adult stage, the krajen can grow longer than most ships, and resembles a gargantuan aquatic squid. Its tubelike body is dominated at one end by a thick central tentacle, the base of which is surrounded by a cluster of smaller tentacles.

Combat: Adult krajens are holy terrors, attacking anything that comes within comfortable distance of them with a huge central tentacle and a cluster of twelve lesser tentacles. The krajen's central tentacle can crush objects of more than huge size, inflicting either 3-30 hit points or 1-3 hull points of damage, depending on the target. On a hit of 18 or better, the central tentacle has looped around the target and can crush each round thereafter automatically. Even when not crushing the life out of a victim, the central tentacle can inflict up to 3-18 points of damage in combat.

The smaller tentacles that ring the large central tentacle are called sentries, and act to protect the main shaft. They are thin, snakelike members, tipped with a paralysis poison that causes those hit to save vs. poison or be paralyzed for 3-30 rounds. The adult krajen can use all its tentacles at one time, though no more than two tentacles will engage a man-sized target.

A common krajen tactic is to snare a ship and crush it with the central tentacle, while the smaller sentries deal with the crew and other creatures trying to attack it. Only after all the attackers are paralyzed or slain will the krajen feed, crushing the paralyzed survivors. The krajen will feed over several days, fall into slumber for a few months, then move off for new conquests.

Habitat/Society: The krajen has no real social organization. The monstrous adult krajens are solitary creatures, and should one encounter another, it will treat it as any other creature and probably attack. The krajens are immune to their own paralysis poison and that of their young, and will destroy ships that are carrying their young and consume them as readily as not.

Ecology: In the krajen's youngest form, its spores are harmless, and can be slain by such simple spells as *cure disease*. They drift like windborne seeds in the void, waiting for the approach of a ship or other solid body. They are so small that a spelljamming ship can pass through a cloud of them without stopping and with-

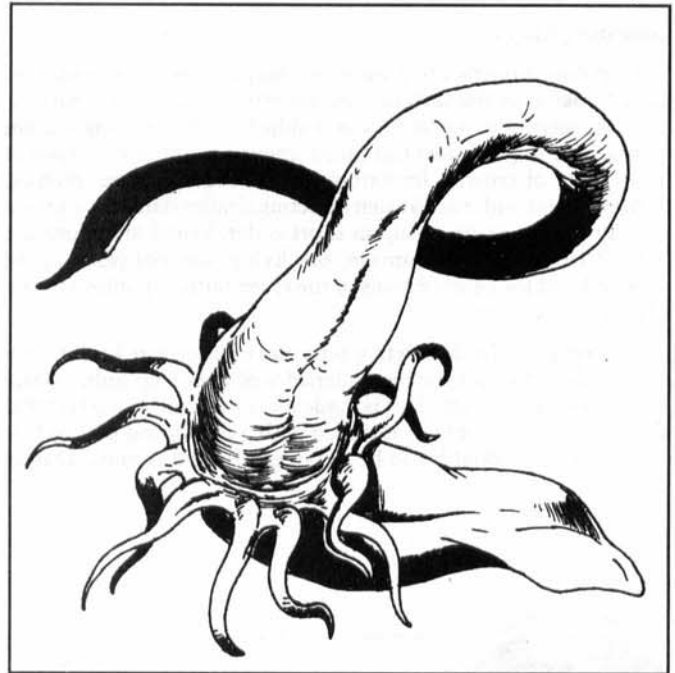

out its crew noticing. It is only when the spores take root in the hull of the ship that they are noticeable.

Krajen spores can take root in any solid object, including asteroids, ship hulls, and large living creatures. Once planted, the base of the spore widens and digs into the surface, while the outer surface hardens into a shell similar to a barnacle's. The central tentacle is nested in an opening at the top of this shell. In case of normal attacks on the immature krajen, the tentacle can whip out to attack enemies in the area, lashing out at random. When dormant, the tentacle is tucked inside the top of the shell.

Immature krajens can survive without air, and in fact prefer the stale air of bad air envelopes over the healthy air of areas replenished by green plants. They do need a solid surface to draw nutrients from, though each one can also absorb nutrients from dead bodies that it and the rest of the colony have destroyed.

When the immature krajens have pulled the equivalent of 2 hull points of material from a surface (i.e. in about two months), they disengage and float into space. At this point the gripping base closes and the sentry tentacles appear. Feeding on the stored, concentrated energy, the krajen attains its adult size and goes hunting. Large groups of immature krajens often hunt other krajens, until only one member of the group survives and reaches full size.

Adult krajens grow throughout their entire lives, such that legends of particularly huge individuals surface from time to time. Krajens feed on ships almost accidentally, as their main prey are kindori, radiant dragons, and other large creatures.

One rumor that has appeared in a number of spheres is of a lesser race of human barbarians who have tamed the krajens through use of alchemic mixtures. They have traded these mixtures to the arcane in exchange for lifejammers, which they have hooked up to the relatively mindless krajen. Using the lifejammer-driven krajen, this lesser race is suddenly appearing as a major menace to shipping, often preying on other pirates and marauders.

Krajen

Immature Krajen

Immature krajen are a bane of shipping, as their continued growth destroys the surface they are moored to. This is particularly dangerous if the surface is a ship hull. Resembling a giant barnacle, a single krajen can inflict about 1 point of hull damage in a month of growth. Immature krajen come in large colonies, however, and with each krajen inflicting similar damage, a krajen colony can break up a ship in short order. Wood and stone are subject to this type of damage, but living material (such as the kindori) and the ceramic hulls of the elven butterfly ships take no significant damage.

As a result of the destructive activities of immature krajen, ship crews must often scrape the undersides of their ship hulls, where the krajen tend to nest. This is made more difficult by the fact that the krajen's main tentacle is tipped with a paralyzing poison that causes an individual hit to be paralyzed for 2-8 rounds. During

this time the krajen will either continue to strike the attacker with its tentacles (if riled or if some of the colony have been slain) or, more likely, shuffle off to a new piece of the ship.

When part of the colony is threatened or attacked, the damaged/dying member releases chemicals that aggravate the other members of colony, so that attacking one immature krajen affects all other krajen in that same air envelope.

Carefully done, freeing a hull of immature krajen is an unpleasant and time-consuming task. Crews will wipe out krajen colonies even on asteroids and other areas, if for no other reason than to prevent them from becoming full-fledged krajen.

Immature krajen have no intelligence, and their colonies grow together by chance rather than as a result of any cogent thought. They grow together because they take root together.

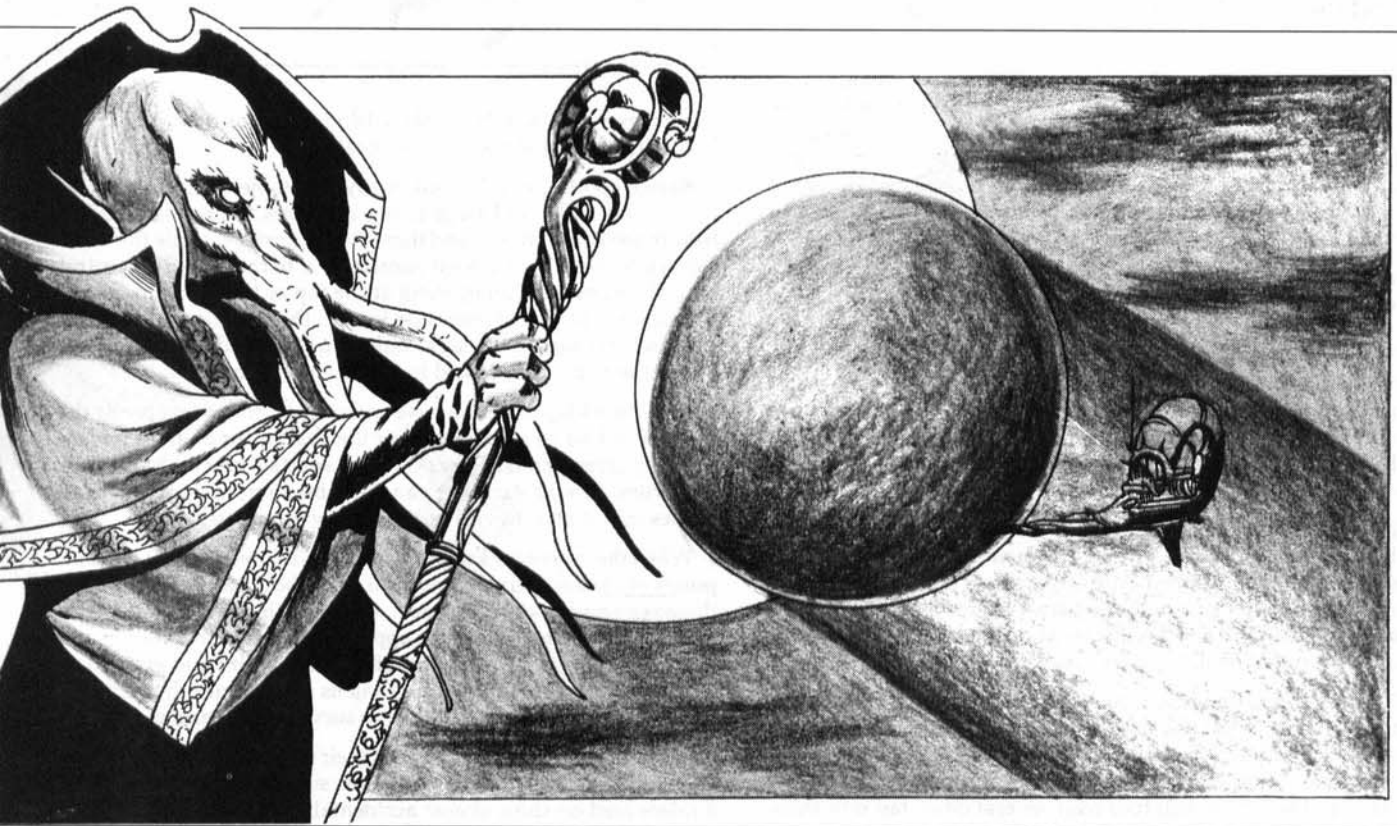

Neogi

	Neogi	Great Old Master
CLIMATE/TERRAIN:	Any space	Any space
FREQUENCY:	Rare	Very rare
ORGANIZATION:	Tribal/ship	Solitary
ACTIVE CYCLE:	Any	Any
DIET:	Carnivore	Carnivore
INTELLIGENCE:	Highly (13-14)	Low (5-7)
TREASURE:	Q each	Nil
ALIGNMENT:	Lawful evil	Lawful evil
<hr/>		
NO. APPEARING:	1-8	1
ARMOR CLASS:	3	5
MOVEMENT:	6	3
HIT DICE:	5	20
THACO:	15	Nil
NO. OF ATTACKS:	3	0
DAMAGE/ATTACKS:	1-3/1-3/1-6	Special
SPECIAL ATTACKS:	Slowing poison	Young
SPECIAL DEFENSES:	See below	See below
MAGIC RESISTANCE:	Nil	10%
SIZE:	S (3' high)	H (20' high)
MORALE:	Steady (12)	Unsteady (6)
XP VALUE:	270	500

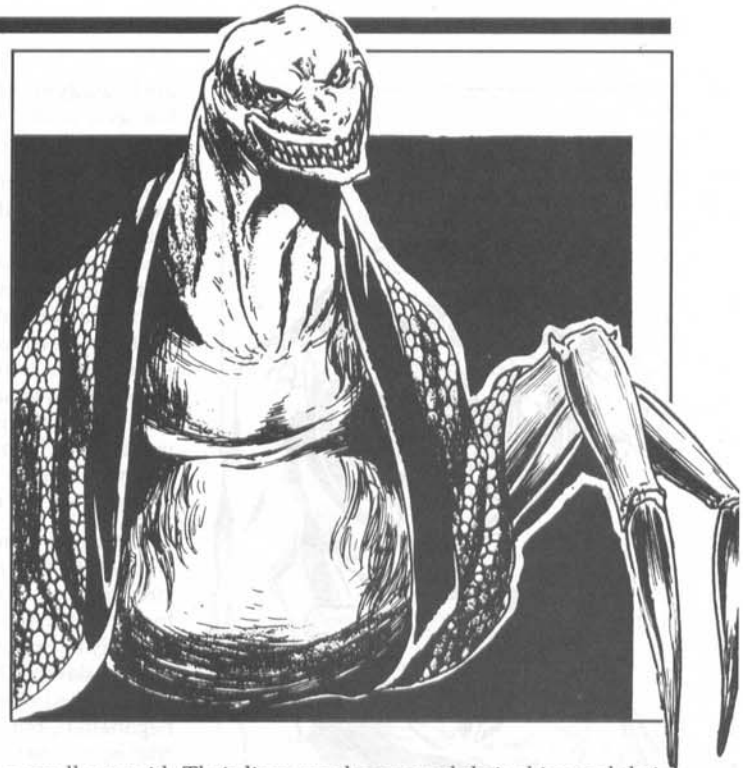

The neogi appear as a cross between a wolf spider and a moray eel. The short, furry, eight-limbed body is topped by a lithe, bare, fleshy neck with a serpentine head, its mouth filled with needle-sharp teeth. The ends of its limbs are tipped with small claws. The fur of the neogi is a light tan, but dyed a variety of colors to signify power, rank, accomplishments, and warnings to other neogi. The older a neogi is, the more colorful its hide becomes. A neogi with a bare pelt has no status.

The neogi are hated throughout the Known Spheres, and their spiderships are often attacked without giving them the chance for provocation. The reason is that neogi are ruthless slayers and plunderers to the last being, and think nothing of eating their enemies, servants, or fallen comrades. In all the variety of the universe, one truth remains: the Neogi are a hateful, xenophobic race that has no friends.

The neogi can communicate in their own language and in common as well—this is the language that they use to command their umber hulks and other slaves. Many speak 1-4 other languages to help facilitate their slaves taking orders correctly. A slave that does not understand its orders is good for nothing except the next meal.

Combat: With the universe against them, the neogi have a number of defenses. The first, and most obvious, is their enslavement of umber hulks (see *Monstrous Compendium 1* for umber hulk stats). Each neogi has a personal umber hulk slave that he rules over all other slaves, who is a combination bodyguard, manservant, and useful set of hands. A neogi without an umber hulk does not survive long, and the profusion of umber hulks on many worlds is ascribed in part to their spreading at the hands of the neogi.

Second, the bite of the neogi is a slowing poison. Those bitten and failing their saving throw vs. poison will be affected as by a *slow* spell. This lasts for 1-8 rounds, and multiple bites will extend this period by an additional 1-8 rounds per bite.

Third, 1 in 10 neogi has some magical ability, equal to human spell use of levels 1-8. This ability is used by the neogi to gain an advantage in combat against opponents.

Habitat/Society: The neogi are apparently a spaceborne race: No viable colonies of them have been found on any planet larger than

a small asteroid. Their lives revolve around their ships and their slaves.

The neogi have hairy, ugly bodies that they dye with colorful pigments. These cause them to look at times like exploded rainbows. The colors signify rank, achievement, and power within the neogi organization. The most colorful neogis are usually (but not always) captains and/or overmasters of neogi ships.

The neogi also tattoo their slaves with symbols of ownership, usually on the left shoulder in the front and back. These tattoos identify the individual as property, and should a slave survive to have more than one master, an additional tattoo will be placed below the first. Any tattooed creature is considered property of the neogi. If found wandering alone, it will be claimed and its immediate return to the owner demanded.

The neogi are a slaving race with an inborn sense of property: everything is either owned or owner, slave or neogi. Even neogis are slaves to other neogis, but these slave-neogis may have their own slaves and eventually establish themselves as full masters in their own right.

The most important slaves (from the aspect of the neogi) are the umber hulks. These creatures are trained from birth to follow their "small lords," caring for their every need. They provide the strength, the combat ability, and even the raw muscle power and dexterity that the neogi lack. Each neogi has at least one personal lordservant, though any neogi can command another umber hulk (the effect of this command is akin to those of the *charm monster* spell).

A neogi who loses his only umber hulk slave(s) is considered an outcast, and must regain such slaves or be in danger of losing all status and becoming a full slave himself. A captain or overmaster losing his personal slave can still call upon the slaves of his neogi followers, choosing a replacement from these numbers. For this reason, the neogi on a ship are inclined to see that the captain's umber hulk is kept in relative safety, since its loss would likely lead to the loss of one of their own slaves.

All other slaves are just so much dross, fodder for battle, extra sets of muscles for heavy tasks, and, ultimately, food. Their lives

Neogi



are brutally short in the hands of the neogi, but as a result, the "small lords" are constantly seeking to replenish their stocks.

The neogi worldview of "own or be owned" has resulted in a paranoid outlook that borders on xenophobia, and their relentless attacks on any ships result in their being hated throughout the crystal spheres. Neogi ships are attacked on sight when possible, and evaded otherwise. Even the arcane, who will deal with the most scum-ridden space nations in the universe, will only deal with the neogi through intermediaries. The only "normal" race with extensive ties is the mind flayers, who make a fat profit on the neogi slave trade.

The neogi have no nation per se, though ships of the race will cooperate under certain circumstances. This cooperation is hindered by the fact that in any neogi gathering, there can only be one overmaster, to whom all others are slaves. Determining the overmaster for a limited objective can be done through negotiation, but is most often the result of a trial by combat held in the cargo pits of the ship. The contending neogi, each with his personal umber hulk slave, battle for domination. The losers are eaten. In a similar fashion, if the overmaster of a ship dies, those neogi interested will fight to determine who is the new overmaster.

The most common ship is the neogi deathspider, a huge hulking craft powered by a major helm. The ship contains blessed few neogi for something of that size. In space the deathspiders will attack smaller ships using their grappling rams, and the umber hulk servants will scramble across, ripping holes in the opponent's ship and carrying off slaves and the bodies of any they slay.

A new ship making its appearance is the mindspider, and indicates a new approach to ownership, in that a fleet's overmaster does not have to be physically on board any of the deathspiders he controls, but instead works from a central command post. The mindspider has only appeared in the last 50 years, but is becoming more common in neogi space. The mindspider operates from minor helms and lifejammers supposedly acquired from the arcane. The arcane themselves are at a loss to explain this new development.

Ecology: The neogi live according to an ugly life cycle that is characteristic of their race. As a neogi grows older and his mind fades, his orders become confused and his slaves

become disobedient. His fellow neogi may then choose for him to become a Great Old Master. The "small lords" then poison the older one at once. The different poisons moving through its body overload the old neogi's system, and begins its change into a Great Old Master.

The neogi making the transformation swells to a 20-foot height and a similar girth. Its legs and arms become useless, and the last of its intelligence fades: It lives now only to eat.

During this time the other neogi begin to hunt exclusively for the new Great Old Master. Slaves, captives, anything that comes across their path and can be captured is fed to the master. Live flesh is preferred, but dead will sustain it. A Great Old Master will inflict 1d12 hit points of damage per round to any creature fed to it.

After 2 months of such activity, the skin of the Great Old Master bursts and a new crop of mature neogi spill forth. These are unmarked and barely sentient upon their birth, and for the next week the brood area resounds with combat as the young neogi kill each other for food. Of the 20-40 neogi that eat their way out of the master, only about 3-6 survive. These are considered slaves of the entire ship, to be killed or risked in combat, until such a time as they claim and command an umber hulk as their personal slave. At this point they are officially part of the neogi community.

If a Great Old Master is attacked and its flesh pierced, it will release 2-8 neogi to defend itself. These are taken from the future brood, and if slain, will not be replaced. Blunt weapons will not pierce the skin and therefore will not bring the young forth. Edged or piercing weapons, or magical spells that pierce or burn, will produce this defensive reaction.

The remains of the Great Old Master are consumed by the surviving young. Most neogi consider this fate to be the equivalent of a human dying of old age.

Reaver

These are rogue neogi that have rebelled and are seeking to escape the other neogi and their poisons that will transform them into Great Old Masters. These rogue neogi are little better than their fellows, and are if anything more desperate, due to being pursued by their former fellows, all eager to start the process of producing more neogi.

Scavver

	Gray	Brown	Night	Void
CLIMATE/TERRAIN:	Any space	Any space	Any space	Any space
FREQUENCY:	Common	Uncommon	Uncommon	Rare
ORGANIZATION:	Pack	Pack	Pack	Solitary
ACTIVE CYCLE:	Any	Any	Any	Any
DIET:	Scavenger	Scavenger	Omnivore	Carnivore
INTELLIGENCE:	Animal (1)	Animal (1)	Animal (1)	Semi- (4)
TREASURE:	Nil	Nil	Nil	Nil
ALIGNMENT:	Neutral	Neutral	Neutral	Neutral
<hr/>				
NO. APPEARING:	3-30	2-20	1-10	1
ARMOR CLASS:	7	5	3	1
MOVEMENT:	12	12	18	18
HIT DICE:	3	4	6	10
THACO:	17	17	15	11
NO. OF ATTACKS:	1	1	1	1
DAMAGE/ATTACKS:	1-3	1-4	1-10	2-20
SPECIAL ATTACKS:	None	Swallow	Swallow	Swallow
SPECIAL DEFENSES:	None	Poison gas	None	None
MAGIC RESISTANCE:	Nil	Nil	Nil	Nil
SIZE:	M (6' long)	L (10')	H (15')	H (20')
MORALE:	Unsteady (5)	Unsteady (7)	Average (9)	Elite (13)
XP VALUE:	65	420	975	3,000

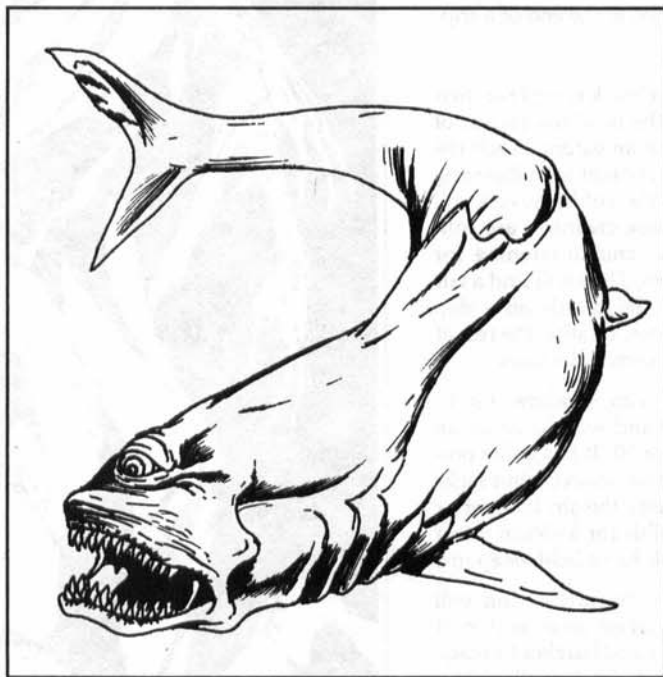

Scavvers are long, fishlike creatures of space, dominated by a single huge, humanlike eye at the leading edge of the head, and a wide, sweeping mouth. General body details such as number of fins vary depending on the origin of the creature, but their behavior and general coloring divide them into four basic groups: gray, brown, black and void scavvers.

Scavvers trail ships, asteroids, and larger creatures for droppings and refuse. They drift inside the air envelopes of these large bodies, so that as they move (often at high speeds) the scavvers move with them. The lesser scavvers are nuisances, their worst traits being that they suck up needed air. The larger scavvers are more deadly, in that they will often not wait for their meals to come to them. The eyes of the scavvers glow when they are awake.

Combat: The scavvers are built along the lines of minimum effort—they are little more than gullets with enough brains to point themselves in the right direction. Combat details are given for each type.

Habitat/Society: Most are lazy by nature, such that they will be found at the trailing edge of a small celestial body or ship, along the plane of gravity. Most scavvers travel in packs, drifting between the planets waiting for a free meal. Unless repelled, they will follow a ship until a better or larger target presents itself. Many large cities, like the Rock of Bral, have a permanent scavver crew whose job it is to kill scavvers that come onto the Rock from arriving ships. The scavver crew is usually made up of ship captains and crews guilty of bringing these creatures in.

Ecology: In deep space, all scavvers can shut down their basic body functions, so that they require no air or food for long periods of time. In this fashion they drift until their paths collide with a passing ship or solar body.

The scavvers tend to avoid large planets, since flying against gravity is too much work. They are found in every known sphere and in the phlogiston as well.

Gray Scavver

The gray scavvers are the smallest and the least dangerous of the lot, though they travel in large packs. The appearance of grays in a ship's air envelope is usually dangerous only because the grays will be using (and fouling) the air at a rate equivalent to an additional man per scavver. Usually they can be driven off by an armed party. The meat of gray scavvers is drab, but nutritious for those on long voyages.

Brown Scavver

The brown scavvers, which range from a sun-dappled gold to a dark rusty umber, are larger and only marginally brighter than the grays. The browns are pure scavengers, and will flee a particular bit of trash if challenged, only to return later. They have two abilities that make them less desirable than their smaller cousins. The first is that they can swallow a creature up to man-sized whole on an attack roll of 19 or 20. The gullet can hold a single man-sized creature (or two smaller than man-sized creatures).

Scavver

Once a victim is swallowed, the poisons in the gullet cause the victim to save vs. poison or die in three rounds. A victim who survives can attack from within the scavver, provided a short (less than 3') edged weapon is used. The scavver will take 1-6 points of such damage before returning its attacker to the outside world. Unfortunately, the scavver does not learn from experience, and will try to swallow the same reluctant piece of food several times before giving up or dying. One weaponless mage who was swallowed by a scavver returned to the living world by using a *potion of growth*, splitting the creature's gullet.

The other ability of the brown scavver is a small cloud of poison gas evacuated from the gullet against an attacker. Outside the gullet, the droplets of poison are less potent (+3 on saving throws), but no less deadly (save or die within three rounds). The brown scavver can do this once per day to a single target in front of it. Brown scavvers cannot be affected by their own poison, though the poison of other species of scavvers *can* affect them.

The flesh of the brown scavver is laced with its gullet poison; as a result, it is not eaten, but saved and used as poisoned bait for other scavvers. Most other space life will avoid dead browns, but gray scavvers will eat and die whenever the flesh is offered. A company of Shou dragonships has declared the brown to be perfectly palatable if prepared properly, and one captain swears to have served the scavver to the Emperor himself. Cynics believe that the Emperor had priests with *detect*, *slow*, and *remove poison* spells on hand, and that the captain was run back out into space as a result.

Night Scavver

The night scavvers are generally black with spots of white along their length. With its dark flesh and white spangles, the night scavver fades in with the background of the void. This omnivorous version of the common scavver has the distressing habit of not waiting for food to come to it. It will sneak onto the deck of a ship and cruise about looking for loose food and other items. As a result, the belly of the night scavver is often littered with small but valuable debris, ranging from a few gold coins to perhaps a magical ring. The DM can determine the belly hoard of the scavver by using a randomly determined treasure type from J to U (roll 1d12), with a 1% chance of a magical item.

The night scavver is relentless in its quest for food, once committed, and while one

will not attack an obviously crowded ship, it will slip on during the night watches and refuse to budge from its new location, even if threatened with superior physical force.

The night scavver can swallow creatures of up to man-sized in the same fashion as the brown scavver (an attack roll of 19 or 20). However, it lacks the gullet poison of the brown that pacifies that type's prey. The night scavver makes up for this lack by its unusual reaction to efforts by swallowed creatures to carve themselves out of its belly. It brings the victim forward to its mouth, chews on it a while (one attack at +4), then sends it back down again. The interior wall of the night scavver is AC 7, and the night scavver will use this "cud-chewing" instinct whenever it takes any internal damage.

Night scavvers are considered delicious, and crews will often use open fires on the deck to roast them in celebration of planet-fall or a good voyage. As a result, they are considered a good omen at the end of a trip.

Void Scavver

Void scavvers are jet black except for their single eye. They are the most dangerous of the breed, as they are man-eaters. While the other scavvers will be content with digesting a few kitchen scraps, the void scavvers will go after the cook. These creatures are solitary and have a fine, animal cunning for preying on their targets. They will find a lair hidden from most of the guards on a ship and use that as their base, treating the rest of the ship as their own personal icebox.

The void scavver can swallow up to large-sized creatures, and will do so on an attack roll of 18, 19, or 20. It has gullet poison similar to the brown scavver, but lacks the ability to expel it into the air. Its interior is AC 5, and it is possible for a victim to cut his way out with small hand-held weapons.

The void scavver is relentless, and will strip a ship clean if it can get away with it. It will batter down doors and hatches to reach its prey. Its sight, touch, and smell are superb, such that invisible creatures can be detected and attacked by the scavver without penalty. Legends tell of rare gargantuan void scavvers attacking full ships, ripping the hulls apart in search of food.

The void scavver is a solitary hunter, and will drive off other scavvers that threaten its prey. The void scavver will attack any of the other scavver types, and it will kill but not eat the brown scavver.



A Brief Tour of the Known Spheres

The following is a very brief description of the Known Spheres of the SPELLJAMMER™ universe, which are the homes of the AD&D® campaigns of TSR: Krynnspace, the home of the DRAGONLANCE® epics; RealmSpace, the system containing Toril and the FORGOTTEN REALMS™ campaign; and Grey-space, the home of Oerth and the WORLD OF GREYHAWK® campaign. These descriptions are included as a primer for DMs using these systems, and as an example to DMs creating their own space campaigns.

The asteroid settlement known as the Rock of Bral (see the *Concordance*, appendix 4) can be set around any of the planets in these spheres.

Krynnspace

Krynnspace is the most primal and untouched of the spheres in that the influence of the Powers That Be is much stronger here than in most spheres. The gods are fewer than in many other spheres, and tend to regularly use natives as their pawns in missions against each other. The main inhabited planet, Krynn, has long been a hotbed of this contention, which has in recent memory resulted in the destruction of most of their civilization in what was thought to be a god-related meteor strike.

Despite the fact that Krynnish clerics had been deprived of their spells for a long time following this strike, religion remains a deep part of the Krynnish sphere. The constellations represent many of the major gods, and their actions cause these constellations to rearrange themselves, disappear, or often appear in new patterns. Similarly, the planets that orbit the sun with Krynn are named after the gods venerated by the peo-

ple, and they reflect the attitudes and attributes of these deities.

Krynnish space is cooler than typical space, and clouds of freezing vapor can be encountered. If an individual falls into such a cloud, he must save vs. breath weapon or be frozen solid, taking 5-50 points of cold damage. Such ice clouds are often found in orbit around Krynn and the outer planets of the solar system. Traveling at spelljamming speeds, however, protects the passengers aboard a ship against these extreme temperatures. Only characters adrift are affected.

Primary: Sun

Type H ● Fire Body

For all the mysticism that surrounds the rest of the system, the sun is taken for granted, treated as a mountain range or other natural feature would be, and not invested with any magical, mystical, or godly abilities. There are sun-worshiping cults among the various peoples, but the sun is not considered a god or the home of a god.

Sirion

Type D ● Fire Body, Inert

Sirion is an inert fire body, its central flames cool enough to let a thick earthen crust form on the surface. This crust is large chunks of basalt floating on the molten sea beneath. The continents are like giant rocky icebergs, continually colliding with each other, sinking beneath the surface, and reforming in the cooler regions around the poles.

The only "permanent" land is at these poles, which provide a home for a wide diversity of azer, efreet, salamanders, and other flame-using and flame-loving creatures. Sirion himself is said to dwell at the center of the orb.

Reorx

Type D ● Earth Body, 1 Moon

Reorx is almost completely covered with sheer mountains and deep chasms. The few large bodies of water are thin, narrow seas of incalculable depth. The polar areas are covered in continual icecaps, but in the temperate latitudes there are huge forests of pines clinging to the lower reaches of the mountains. The equatorial regions have a few high mesas, which are barren, rocky deserts.

The mountains and mesas are incredibly tunneled and mined by the native population, which is dwarves and (non-Krynn) gnomes. There are no elves on Reorx, and only a smattering of humans, who have been reduced to barbaric states similar to the orcs and goblinoids of other planets. The dwarves of Reorx have regular traffic with spacefaring dwarves that happen by, and are aware of the crystal shells and the phlogiston which lies beyond their solar system. Dragons survive here, in particular red dragons, as well as other mountain-dwelling beasts.

There are colonies of both mind flayers and Krynnish gnomes on the planet. The mind flayers operate slaving operations in the depths and are continually hunted by the dwarven kingdoms, while the Krynnish gnomes are engaged in an evangelical effort to awaken their ground-dwelling brethren to the wonders of space and invention, and as such are politely tolerated. Finally, far beneath the surface is rumored to be the Halls of the Golden King, the lair of Reorx himself, where the dead dwarven kings craft and revel at a continual banquet.

Reorx has a single moon, called Ora or The Hammer, which is capable of supporting life but is uninhabited. Voyagers through the Krynn system in need of air, water, and



Homeworlds

Modern thinking indicates that all life should come from a single point, that one orb is the center from which all others descend. While it is true that relatively new races in space such as Krynnish gnomes, dracon, and the giff seem to come from one homeland, whether this applies to other races remains to be seen.

With the spread of space travel as well as interdimensional travel, the routes of the various races are muddled and lost in a confusion of origins and creation myths. That there was once a primal beholder is certain, but since every beholder nation regards itself as the linear descendant of that primal beholder, all such investigation usually ends in a cloud of disintegrating dust.

The idea of a human homeworld has sparked lively debate within a small group of sages. For the bulk of the populations of wildspace, such discussions are fluff and nonsense.



other supplies stop here, as there is less danger of attacks by monsters and humanoid races. The interior of the moon has not been explored.

Krynn

Type D ● Earth Body, 3 Moons

The most populous planet in the system, Krynn is the center of much of the human activity and godly interference in its shell. At one time the planet sustained a highly advanced, mystically endowed, but morally decadent civilization. This civilization was eliminated by the intervention of the Krynnish deities, in the presumed form of a meteor strike on the city of Istar in the continent of Ansalon. The word "presumed" is used since records of the event are very sketchy and conflicting—legends also mention a solar flare at the time, and the intervention of Sirion of the Flowing Flame.

The strike against Istar destroyed most of Krynnish civilization, both in Ansalon and in the other parts of the planet. Combined with the refusal of the gods to answer their people, the loss of life was enormous, and the nations sank into a warring savagery that they are only recovering from today. The reappearance of dragons in Ansalon, long thought extinct, made matters even worse. After a protracted war between good and evil forces on Ansalon, a balance has been struck, and the world is beginning to recover fully with the return of its deities.

Krynn is primarily a human world, with a large number of elves and dwarves. There are no halflings on Krynn; in their place are the childlike kender. Most importantly for a space traveler, Krynn is the home of the Krynnish gnome, also called the tinker gnome, an inventive race that long ago escaped to space and found it to their liking. Tinker gnomes are now found throughout the Known Spheres. Suggestions that Krynn

should suffer *another* meteor strike to deal with these creatures have been made, but this is closing the barn door after the horses have escaped.

Krynn has three moons: Nuitari, Lunitari, and Solitari. All are thought to be uninhabited, and some have been reached by early Krynnish space explorers (primarily gnomes) using a variety of means.

As the Krynn system's sun is not the home of any deity, neither are there gods' abodes on the planet's surface. However, all the major deities have followers and churches in the world. Paladine and Takhisis have both fought in the Dragonlance Wars in Ansalon.

Chislev

Type E ● Earth Body

Chislev is referred to in some spelljamming texts as a liveworld, and Shou Lung explorers consider it to be an example of this planetary type that conforms with their "Five Elements" theory of the universe. Other star voyagers list Chislev as an earth-type body.

Chislev is covered with a thick, stormy atmosphere, such that there are never any clear days on the planet; ignore any planetary weather conditions better than Favorable on the weather tables. Gales, storms, and heavy rains are common.

Chislev is a huge jungle from pole to pole, with few open patches of water. What water does exist is choked with vegetation.

Plants grow all over Chislev, including on other plants. There is a yearly cycle from swamp to jungle tangle to rain forest and climax growth, which is swept by firestorms during the summer, reducing the land to a swamp, which starts the full cycle over again.

Humanoid and animal life on Chislev is rare but large, with giants

succeeding as a dominant species with the rudiments of civilization. The rest of the humanoids are little better than barbarians, with wild versions of dwarves, elves, humans, and kender found in tiny pockets throughout the sphere. Dragons do well, in particular green dragons, who are continually warring with the various giant factions.

Chislev the Feathered Cleric is reputed to make his abode on the planet of the same name, though no legends surrounding him exist on that world among its scattered peoples.

Zivilyn

Type F ● Air Body, 12 Moons

Zivilyn is Krynnspace's solitary air-world, and as such is the least populated world of the system, despite the fact that it is the largest planet in the Krynn system. A few continent-sized boulders spin through its atmosphere, but the vast majority of the planet is open space.

Life is not abundant on Zivilyn, and that which is there tends along avian lines. No native sentient creatures live on Zivilyn, though there are a number of lost colonies on the various islands from previous spelljamming explorers. There are no current colonies on the planet, and the world has the reputation of being cursed. Whether this is because of the influence of the god for which the planet is named or some natural occurrence in the world is unknown.

There are no dragons on Zivilyn, surprisingly, for the terrain is ideal for them. It is possible that the lack of other food to support their great bulk accounts for their scarcity.

In old logbooks found in the area, there are notes of using magical powers to control the gods themselves. If this was attempted, it may account for the lack of sentient life

on the planet, and show that the gods of Krynnspace have learned restraint in later dealings with Ansalon in its cataclysm.

Zivilyn's moons are all earth-type bodies of size A. Some have been settled by star voyagers seeking to open trade with the various inner planets, but such movements have been slow in light of the recent Wars of the Lance and the involvement of the gods.

Greyspace

The wildspace of the Oerth system has the widest variety of planetary shapes and types. In addition to the common spherical planets, there are elongated, irregular, and flat worlds, as well as belts and cluster formations. The Oerth system is geocentric, its primary being Oerth itself, all other bodies moving around it.

The gods of Greyspace are many and diverse, with different gods holding sway and fealty over differing sections of the individual planets. As such, the interference of these gods on a system-wide scale is less than that in Krynn and the Realms. Large regional effects do occur, such as the Great Devastation in the southwest of the Flanaess, but these tend to be man- or magic-made as opposed to deity-created.

Primary: Oerth

Type E ● Earth Body

The center of the Greyhawk system, Oerth is the most diversely and heavily populated planet in the system, with every sentient race in the shell being represented to one degree or another. Native mapmakers of the Free City of Greyhawk place their land literally at the center of the universe, with all of the Flanaess and Oerth rotating about them, and the planets and sun passing across the sky that surrounds them.

The centralized location of Oerth accounts for the superior attitude of its people, but there is another factor. Oerth is a very competitive world with very powerful mortal entities, at times contending with the gods themselves and besting them. A long string of such incidents increases the self-confidence (and ego) of the natives of Oerth, in particular those in the "adventuring" areas—wizards, warriors, priests, and rogues. This self-centered nature tends to make Oerth groundlings insular.

The natives of Oerth have a passing interest in spelljamming and spelljamming technology, though they put it in the same general area as extradimensional travel. It matters little if a traveler is from the next world or another plane; he is an outsider and is treated as such.

Trade is erratic and best confined to singular items that individuals find useful—artifacts, specialized magical items, and relics. Oerth itself, with its ancient civilizations, has a bumper crop of such items, and often is all too willing to export such dangerous items elsewhere.

Smoke powder does not function on Oerth, though it does in wildspace and on other planets in the system. Whether this is due to the chemical makeup of the Oerth atmosphere or some interference by gods who already fear the growing power of mortals is unknown.

Kule

Type B ● Earth Body

Kule (also known as Celene) is the smaller of Greyhawk's two moons. Technically, everything that spins about Oerth is a "moon," but only Kule and its sister planet, Raenei, are close enough for an observer to discern planetary features. As they lie within the orbit of the Greyspace sun, Liga, they are the only planets to cause eclipses and for these reasons



Types of Worlds, Part 5: Liveworlds

The four types of worlds are defined according to the four basic elements: earth, air, fire, and water. The "oriental" philosophy of Kara-Tur, however, adds a fifth element: plant, or liveworlds. There have been a number of worlds that the "western" scholars have defined as Earth or other types, which Kara-Tur wu jen put down in their charts as liveworlds.

Liveworlds are very similar to earth-type worlds, being a densely packed solid wrapped in an atmosphere. The liveworld's heart, however, is made of living material, such as plants, and the entire planet has a general aura and combined



are referred to as the only moons of Oerth.

Kule is a voidworld, lacking even the vestige of an atmosphere on its surface. Advanced ruins, towers, and minarets indicate that there was once civilization on the surface long ago of some bipedal type, but it has vanished with the air. Some magical agent, as opposed to the work of gods, is presumed.

Kule is tidally locked, showing only one face to Oerth. The side facing Oerth is littered with debris of ruined cities, while the opposite face has mostly intact towers and citadels exposed to the open space. The entire surface of the planet is scored by extensive underground passages and cities. These are occupied by humans and other savage races, but as on Oerth, the dominant underground races are mind flayers, drow, kuo-toa, and similar evil creatures. There is some speculation that dimensional links exist between the ruins of Kule and the Oerthian underdark.

Kule is rarely visited by star voyagers, except for those adventurers who are looking to loot the wonders of the past from this place.

Raenei

Type D ● Earth Body

Raenei (also known as Luna) is the larger of Oerth's two moons, and the farthest away. It is half the size of its primary, but still large enough to spawn a wide variety of terrestrial habitats and niches: mountains, forests, plains, open seas, and the like. The difference between Raenei and Oerth is that there is no native sentient life on Raenei. Whatever brought the rise of men, elves, orcs, and dwarves and half a hundred other races on its primary has passed this world by. There are no social creatures here, nor any with intelligence above Average.

There are many "monsters"—purple worms, carrion crawlers, ankhegs, and even some large and stupid dragons, but nothing that would build a city or even a fortress for its own protection.

Visitors from Oerth have arrived on Raenei, and some have settled. These are those that prefer solitude and hermitage over cities and trade. Many spelljammers pass by the planet entirely for better pickings on Oerth itself.

Liga (the sun)

Type G ● Fire Body

Liga is a good-sized body orbiting around Oerth, taking 365 days to make its passage. The fire body burns with a deep golden glow, but its surface is dotted with pinpricks of blue. These blue areas are cooler, and are thought to be "lakes" of elemental water maintained in Liga to keep it from burning too hot. Investigation of these sun-lakes has been hampered by the extreme heat of the surrounding territories.

Ancient legends from before time mention two fire bodies in this orbit. This may or may not be true, though the location of the missing sun is unknown.

The Grinder

Type B † Earth Bodies

The Grinder is a very dense asteroid belt found within the first orbit beyond Liga. The Grinder may be a planet that never formed, or the wreckage of a god-invoked war from long ago. It forms a secondary shell around Oerth itself, slowing ships down and making them vulnerable to attack. Rocks from the Grinder are arrayed in a sphere surrounding Oerth—it is not possible to avoid them on the way to the primary.

The Grinder has a wide variety of space civilizations (the Rock of Bral

may be found here if the DM so chooses). Much of the business with the outer planets and other spheres occurs here, with merchants traveling to and from Oerth for their supplies.

Parts of the Grinder support spell-jamming civilizations, while others are reported to be dominated by monsters, and still others haunted. A recurring theme in Grinder concerns are clusters of stone golems that take on the appearance of small asteroids, drift close to and then attack humanoid ships.

Edill

Type G ● Air Body

Edill is a "typical" air world, with a large number of other elemental bodies spinning through its clear atmosphere—fireballs, earth islands, and clusters of water droplets all rise and fall through its area. Edill provides a wide variety of life, both avian and reptilian, with dragons very prominently represented. Dragons will often gather into large hatcheries on the floating islands to keep their eggs safe, and behave in a more social fashion than is known in other part of Greyspace.

Gnibile

Type G ● Air Body

Edill's sister planet in general size and consistency only, this gas giant is dark red in color as seen from space, and is wracked by hellish storms and strong winds. Its earth islands tend to be semi-molten in nature, and its water clusters shards of ice. Gnibile is a planet of undead creatures, with strong ties to the negative material plane. Those who have survived the experience state that there are disc-like creatures within that provide immediate (and often fatal) passage to the negative quasi-elemental planes for those passing through them.

Conatha

Type C 0 Water Body

Conatha is a small elliptical water world with two large earth bodies at its center. These are separated by a few thousand miles, which accounts for the planet's elliptical appearance. Conatha spins end-over-end around Oerth, and the heat of Liga creates strong currents running from the sunward surface to the cool side and back again.

Conatha has a strong aquarian environment, with fish, whales, mer-men, and other aquatic creatures. The dominant life form on the planet is sahuagin, whose savagery dominates the other creatures, and whose continual undersea wars between kingdoms reduce much of the planet to a war zone. There are reports of the arcane seen among these sahuagin, though the wise believe that even they will not deal with these creatures who make the neogi look good.

There are no islands or other land surfaces on the Conathan surface, so that only ships with water-landing abilities may land there.

Ginsel

Type C ✧ Earth Body

Ginsel is a crescent-shaped planet. It looks like a crescent moon, or a spherical planet with a huge bite taken out of it. It retains its atmosphere and gravity along the line of the crescent, so there are civilizations along the inside of the crescent and on the outer surface.

Ginsel has a low number of "typical" monsters of the rampaging type, but has a large number of advanced kingdoms, similar to Europe during the late Middle Ages. The leaders of these kingdoms are aware of the spacefaring technology around them, and often ally with outside forces to further their own ends (usually de-

stroying the neighboring kingdoms). Politics are fluid in Ginsel, and treachery very, very common. Aside from Oerth, Ginsel is the most "civilized" world in the system.

Borka

Type A ✦ Earth Body

Borka is a cluster of several thousand rocks linked together by a common atmosphere. It was once a single small planet, but was destroyed by extradimensional magic by the elves in the Unhuman War. The planet was a stronghold of orcs, goblins, and other evil humanoids, which the elves wiped out with the assistance of their gods. The method is unknown, since soon afterward the elven armada in Greyspace was eradicated through a systematic series of accidents and attacks. This was the only planet wiped out by elven attacks, and the event has not been repeated.

Many of the orcs and other humanoids fled Borka on its destruction, fleeing to Oerth and into the deeper regions of space. Some remained, and these are rebuilding their cultures along planetary and racial lines. Most of the new construction is within the clustered asteroids themselves, not leaving outside clues to the elves that they are attempting to mass their forces.

This secrecy, well-reasoned though it is, verges on the paranoid, and orc and goblin ships will attack strangers in order to preserve their secrecy. The orcs can also move their rocky homes slowly among the others, so that if an attack force does come, it will likely not be able to find the same rock as before.



cooperative ecology, or so claim the wu jen.

The dangers of the live-world are the same as for any other earth-type world: falling and crashing. The surface, however, is overrun with plant and animal life, but never sentient creatures such as men, elves, or mind flayers. The dominant life form, says the wu jen, is the planet itself, and it will brook no competition.

The most western-oriented sages of space marvel at the fact that otherwise sane and rational easterners will take such a flight of fancy just to make their own cosmology fit the real universe. They point out that the hearts of most of the liveworlds are earth, and they, except for the abundance of life, function



Greela

Type E ♦ Earth Body

Another cluster-world linked by a common (though thin) atmosphere, the Greela Cluster is much larger than Borka and much, much older. Most of the cluster planets are a few hundred miles across, and rounded into elliptical shapes.

The primary vegetation in the Greela system is grass, though there are planets closer to the core that have rich forests. It is in these forests that colonies of men and elves live, and the elves of Greyspace fashion their living ships. The less-civilized races move from one part of the cluster to another on the wind, in great, ornate balloon colonies.

Though larger than Oerth, Greela has half the mass and a quarter of the total sentient population of the Greyspace primary.

The Spectre

Type B ▸ Earth Body

The Spectre is also called the Wink, because it seems to twinkle and disappear from the sky in a regular fashion. In reality, the Spectre is a flat, circular disk that spins along the line of its orbit, so that the faces turn toward Oerth in a regular fashion. The "winking" is the illusion created by observers from outside seeing the planet edge on, then full face, then edge on again.

The Spectre has an atmosphere but no life. It is the closest planetary body to the shell, and this makes it an ideal way station for the various star voyagers that visit Greyspace.

The lands of the Spectre include seas, mountains, and prairies. The mountains are highest toward the center of the disk, and are icecapped on both sides. At the feet of these mountains are the large, shallow seas of the planet, and finally the plains themselves form a rim around

the disk, forcing water back into the center. The disk itself is about 200 miles thick at the edge.

The various spelljamming races have outposts on the Spectre. Human trading groups, the elven armada, a dwarven nation, and even a gnomish outpost are found on one side; a mind flayer station, three competing beholder lairs, and a neogi settlement lie on the other. All such settlements are widely spaced, as the various races do not trust each other. Raiding and sabotage is common among the natives of the Spectre.

Realmspace

Realmspace is the crystal shell that contains Toril and its sister planets. Like Krynn, the Realmspace system is solarcentric—everything orbits about a central point. Like in Greyhawk, there are a wide variety of gods and revered powers operating in the Realms, who are often more concerned with each other than in the actions of spacefarers. This, plus the tolerance of travelers and new ideas, makes Realmspace a common stop for traders and a base for adventurers.

Realmspace is slightly warmer than Greyspace, such that travelers can often voyage in light garments and summer outfits without fear of catching cold.

Recent events on Toril may change that, as the gods have been forced by circumstance to be more involved with their followers. This may result in a Krynnish tendency to meddle and punish, or the Powers That Be may leave the contention over truth and worship to their mortal followers alone. This has yet to be seen. However, if the gods become as active in daily affairs in Realmspace as they have become in Krynnspace, there will be a marked decrease in star-faring visitors to the region.

Primary: The Sun

Type H ● Fire Body

Sun, Sol, and variant definitions of a fire-body primary are common through half a hundred known spheres. This is an indicator that the dominant human civilizations may come from a common root. The surface of the Realmspace's sun is dotted with entries into the plane of elemental fire, and there are a large number of fire-using and elemental fire creatures living among its flames.

Anadia

Type B ● Earth Body

Anadia is a barren wasteland, a twisted collection of badlands and dry washes, except at its poles. There the land flattens out into rolling, fertile hills dotted with trees and pastoral fields. Anadia is dominated at both poles by halflings. Those of the north pole are organized into a humanlike nation, with an emperor, various subject kings, princes, and local lords. Non-halflings are kept on special reservations and in patrolled sections of the cities for their own protection—everyone knows that simple humans on their own would be easy prey for industrious halflings. The halfling civilization at the south pole is more chaotic, with no local power structure and a tendency to recognize everyone from outside its home city, halfling or no, as a target.

The wastes that make up the bulk of the planet are inhabited by monstrous creatures—including a large percentage of umber hulks. These are the result of attempts by the neogi to set up a "slaving colony" preying on the halflings. The umber hulks are free but communal, and bands tend to raid outlying farms in the polar reaches.

Coliar

Type G ● Air Body

Coliar is a large gas giant with a large number of earth and water islands orbiting through its turbulent winds. Mammalian sentient races—men, elves, orcs, etc.—are missing from these islands. Instead, the dominant races are lizard men, aaracokra, and dragons.

The lizard men benefit from the relative closeness to the sun and the warmth of the area, and have a semi-advanced civilization, capable of organized thought and collective agreement. The former shamans have become priests of various lizard gods, and the former war leaders are now kings of small empires. Like the human races, the lizard men vary in their wisdom and their abilities, such that there are evil, good, smart, and foolish lizard men operating in the world. The lizard men of Coliar have an organized militia in most cases, and can move on the winds by use of large gliders.

The lizard men are in competition with the aaracokra, more numerous here than on Toril, and organized into tribal bands. Wars similar to those between dwarves and orcs have erupted in numerous areas. The planet is so large, however, that no one side gains an advantage.

The dragons play on both sides, the aaracokra seeing them as fellow fliers and the lizard men as similar reptiles. They will ally themselves as they see fit.

Numerous spacefaring races have been trading with the lizard men, and some have opened similar trade with the aaracokra. The lizard men are interested in ships to take their eggs closer to the sun, guaranteeing the superior attributes of their race.

Toril

Type E ● Earth Body, 1 Moon

Toril is the most populous planet in the Realmspace system, and the home of some of the most powerful individuals in this system. It has regular and prosperous ties with the various nations and factions of wildspace, and has sent out a number of adventuring parties, forays, and survey groups into the wild. The number of spelljamming helms found in the area indicate that more ancient civilizations had a higher degree of contact with space, and this is reinforced by the existence of long-standing civilizations in the cluster that orbits the planet.

Like on Oerth, Torilian leaders and natives recognize the existence of extraplanetary natives much the same way as they recognize extra-planar creatures. The difference is that the Realms tend to be more tolerant to newcomers, and as such, unless the newly arrived individual makes trouble, he will be accepted. The slow trickle of smoke powder and arquebuses into the Realms is a result of that toleration, though those who have tried massive imports have failed spectacularly.

Toril has a wide variety of habitats and a large number of terrestrial, aquatic, and avian life forms, with new species and localized variants being discovered continually. Some of these are space-related, some are native, and some are the product of other dimensions and planes. Collectors of interesting and unique life forms find Toril an excellent setting for discovery, as well as magical creation.

Toril has a single large moon, Selune, which is inhabited by pale-skinned humanoids. Unlike on the Krynnish planets, there is no legend or record that Selune the Goddess lives on Selune the moon, though there may be gateways there from her extradimensional home.



like standard earth-type worlds.

The controversy continues, and the Seekers, backed by Shou researchers, are a group trying to prove their point by communicating with these supposed living planets. In their favor, there do exist huge living creatures that survive without air or food—the starbeasts that support many planets. Whether these starbeasts are live-worlds in their own rights has yet to be determined.



Toril's spacial civilizations tend to congregate in a cluster of asteroids which follow Selune in their orbit. This cluster, called the Tears of Selune, has a number of settlements for human nations, beholder factions, elven outposts, and other races. The Rock of Bral can be fit easily in one of these areas.

Karpri

Type D ● Water Body

Karpri is a fair-sized water world with icecaps at its northern reaches and vegetation-choked equatorial waters. This divides the world into five bands—two polar regions, two “clear sailing” regions, and the equatorial seaweed jungle.

The polar reaches are similar to those on other planets, and inhabited by cold-using and cold-loving creatures. Most tend to be predators, since nothing grows on the ice.

The clear sailing regions have no islands on the surface, but are populated below by a number of civilizations who use the seaweed and other water plants from farther south to weave huge nets and colonies for their people. They have yet to discover the nature of spelljamming.

The equatorial sargasso is a huge bed of floating kelp and seaweed dense enough to support other life. Large spiders and insects make their homes here, preying on fish and other creatures they may catch. Some of the water plants have leaves wide enough to support the weight of a ship, so that damselfly and dragonfly class ships can land there.

Chandos

Type F ● Water Body

Chandos, like Karpri, is a water-type world, but Chandos has the greatest number of earth bodies floating in it of any known water-type body. It has been compared to a box

of marbles filled with water—the water is the bulk of the box, but the marbles, resting on each other, occupy a great deal of the space.

Irregular chunks of rock, resting on each other, form a crust for the upper 100 miles of Chandos's surface. Explorers beneath that level report a stygian liquid darkness where everything operates from its own bioluminescence.

The northern reaches of Chandos are covered with snow and riddled with narrow passages between the rocks. Those farther south support low aquatic plants that are immersed in the salty waters of the ocean. In the equatorial areas, forests of fast-growing, low trees survive.

The rocky islands of Chandos are on no firm base, and as such shift in the regular storms that sweep the continent. As a result, most native life is nomadic, since both ground and undersea housing can be easily destroyed by the grind of the rocks. Similarly, caverns and tunnels can be flooded or inverted in the course of a single storm. Humans, dwarves, and orcs are found on Chandos.

Glyth

Type E ● Earth Body

The atmosphere of Glyth is foul but not poisonous. Visitors are reminded of a charnel house or a dead forest after a fire. The land itself is swept by regular fires, and what forests survive are under the control of the masters of the planet.

Glyth is ruled by underground colonies of mind flayers, and is a fitting example of what may happen if other worlds are dominated by them. All races are servants of the illithids, as are any who violate the territorial rights of the rulers. “Land on Glyth and become property” is the rule of thumb.

Mind flayer cities dot the underground, with work-numbered slaves sent out to gather those above-ground resources still available or to war with other mind flayer cities. The mind flayers of Glyth have engaged in an enthusiastic building campaign, and are always looking for more spelljamming helms to pilot them.

The mind flayers do have a central meeting ground above the surface of Glyth (outside of anyone's territorial space). This hollow asteroid, called Haven, is a neutral ground for warring factions, and for those foolish or brave enough to deal with Glyth.

As with any tyranny, there are rebels, lurking in the shadowy sub-tunnels and seeking to overthrow the majority rule. They are portrayed in the same light here as orcs and kobolds are on Toril—destructive vermin who deserve only a quick and sudden death.

Garden

Type A ❖ Earth Body

Garden is a cluster of small asteroids linked together by a common atmospheric envelope and by the roots of a single huge plant. The northmen call the plant Yggdrasil's Child, while the Shou Lung note in their books that Garden is a live-world, not a cluster of earth bodies.

Garden is used by a number of races as a place to restock food, water, and air. It is also a pirate haven, as the maze-work of passages foils many large pursuing ships.

H'Catha

Type C ▀ Water Body

H'Catha is a disk of water floating in space, with a single large mountain (called the Spindle) sticking out at its hub. The water disk tapers at

the edge to form a rim. The Spindle is 200 miles across at its thickest.

H'Catha is the home of no less than five different subspecies of beholders, who maintain bases in the watery reaches of H'Catha and war over control of the Spindle. The edges of the spindle stick out of the air envelope surrounding H'Catha, making it an excellent "stepping off" point for spelljamming craft.

Various factions have controlled parts of the Spindle, but no one has achieved control of the mountain. There are no other native sentients, though there are refugees from the various mercenaries hired over the eons for the wars.

There are some native aquatic life forms on H'Catha, but with the exception of the eye of the deep, most have fallen prey to the warfare between the various beholder races.



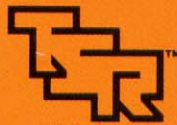
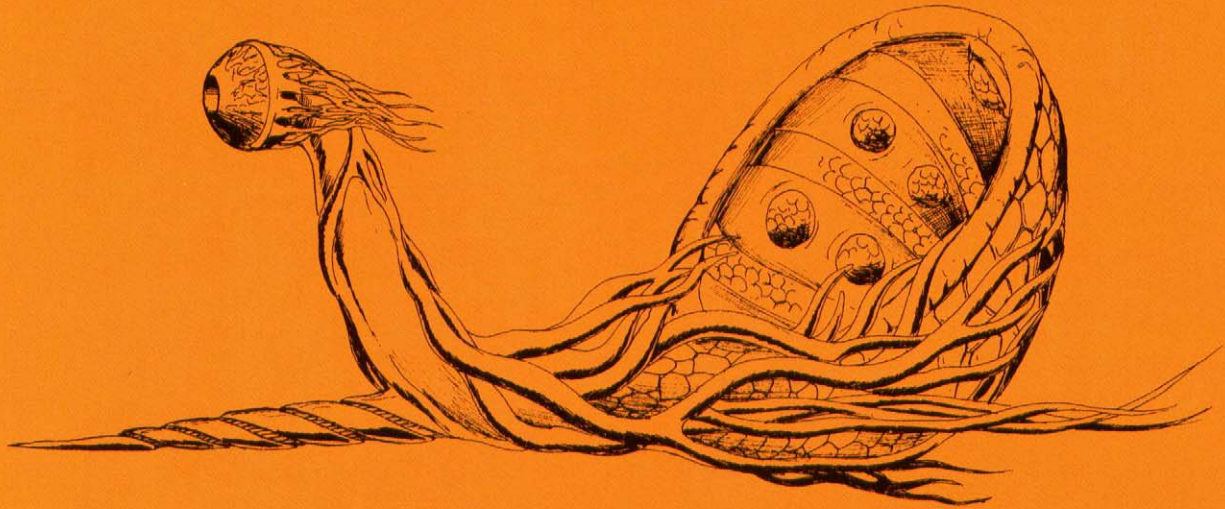

TSR, Inc.
PRODUCTS OF YOUR IMAGINATION™

ADVANCED DUNGEONS & DRAGONS, AD&D, SPELLJAMMER, PRODUCTS OF YOUR IMAGINATION,
and the TSR logo are trademarks owned by TSR, Inc.

©1989 TSR, Inc. All Rights Reserved. Printed in the U.S.A.

1049XXX1901

Advanced Dungeons & Dragons
2nd Edition

SPELLJAMMER™

AD&D® ADVENTURES IN SPACE



Concordance of Arcane Space

Advanced Dungeons & Dragons
2nd Edition

SPELLJAMMER™

Supplement

The Concordance of Arcane Space

by Jeff Grubb



Ad astra per aspera
("To the stars through hardships")
—Latin proverb

*Ah, but a man's reach
should exceed his grasp,
Or what's a heaven for?*
—Robert Browning

Design: Jeff Grubb
Editing and Development: Steve Winter, Jim Lowder, Jon Pickens,
Karen Boomgarden, Eric Severson, Kim Mohan
Spiritual Guidance: Jim Ward
Box Painting: Jeff Easley
**Book Cover Paintings,
Illustrations, Ship Concepts:** Jim Holloway
Cartography: Diesel
Color Inking, Counter Silhouettes: Roy Parker
Graphic Design: Stephanie Tabat
Typography: Angelika Lokotz, Gaye O'Keefe

A product such as this is the result of much cross-fertilization.
To those friends and associates who contributed and are not
listed above, we extend our thanks and apologies.

TSR, Inc.
POB 756
Lake Geneva,
WI 53147 USA



TSR Ltd.
120 Church End, Cherry Hinton
Cambridge CB1 3LB
United Kingdom

SPELLJAMMER, ADVANCED DUNGEONS & DRAGONS, AD&D, PRODUCTS OF YOUR IMAGINATION, and the TSR logo are trademarks owned by TSR Inc. All Rights Reserved.

Printed in the U.S.A.

© Copyright 1989 TSR Inc. All Rights Reserved.

Everything you know about space is wrong.

Infinite space; stars as flaming spheres of super-heated plasma; movement through space as a balance of scientific forces, thrust providing acceleration and maneuverability; scientific fact backing up natural phenomena; life on other planets built along blocks of carbon or silicon elements.

Forget all that. It's wrong.

You can get out of the atmosphere on the back of a roc; fly between the planets through a breathable ocean of air; sail between the crystal spheres that surround the inhabited worlds on a river of magical energy; encounter roving mind flayers and beholders. The stars are living things in some areas, great bowls of fire in others, and pinpoints of light painted inside a sphere in others.

Welcome to the SPELLJAMMER™ universe. It is a magical universe.

The SPELLJAMMER supplement treats the AD&D® game world, with its magic, myriad races, and dimensional gates as the "real" world, and builds outward from there. This is a universe postulated on magical, not scientific, laws. There are universal laws and they must be obeyed, but they are the laws of magic, not physics—the laws of Mordenkainen, Elmin-

ster, and Fistandantilus rather than Galileo, Newton, and Einstein. They sometimes appear strange and random to us, who are accustomed to the workings of science. But to the characters who have lived their entire lives in this environment, nothing could be more familiar and logical.

This SPELLJAMMER supplement extends the AD&D® 2nd Edition game into space, and does so without violating existing campaign material. This includes Greyhawk, the original AD&D game setting; Krynn, land of the Dragonlances; Toril, home of the Forgotten Realms; and every individual campaign in existence.

Introducing this material in your campaign will work some changes, certainly. It will produce an entertaining and far-ranging version of the AD&D game which can exist alongside the standing campaign, mixing with "earthbound" adventures without overshadowing them.

The text in this set is divided into two books: *The Concordance of Arcane Space* and *The Lorebook of the Void*. The *Concordance* (this book) should be read first. It lays out the rules for conducting AD&D games in space as well as the magical science behind space travel, the building and handling of space craft, new spells and items of equipment, and the

"discovery" and creation of new worlds. *The Lorebook of the Void* discusses the races, monsters, and myriad other unusual things that can be encountered "out there."

Full-color heavy sheets give deck plans and other details on the most common space-going ships.

Finally, four maps are included in the SPELLJAMMER box. These include a full layout of the *Spelljammer*, a huge, powerful ship of legend. It is the *Flying Dutchman* of the space lanes, the ultimate goal and dream of many a space pirate and adventurer. Also included is a map of a typical space citadel, the sort used as a port and base by many different races; a hex grid and stand-up counters for playing tactical space battles; and an overview map of typical solar systems and planetary orbits for diagramming new systems and tracking the planets in a campaign.

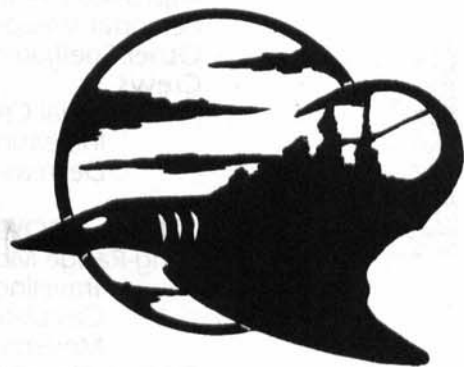

Table of Contents

Foreword	3
CHAPTER 1 ARCANES SPACE	6
Celestial Bodies	6
Wildspace	7
Gravity	7
The Helm	8
Crystal Shells	9
The Phlogiston	10
Breathing in Space	11
Air Quality	11
Matters of Gravity	13
Temperature	15
Time	15
CHAPTER 2 AD&D® RULES IN SPACE	16
Ability Scores	16
Character Races	16
Lizard Men	16
Special Races and Classes	17
Magic Use in Space	17
Spelljamming	18
New Wizard Spells	19
New Priest Spells	21
CHAPTER 3 SHIPS OF WILDSpace	25
Spelljammer Architecture	25
Outfitting	27
Ship Hulls	27
Caravel, Coaster, Cog, Drakkar, Dromond, Galleon, Great Galley, Longship, Nautiloid, Squid Ship, Hammership, Dragonfly, Damselfly, Mosquito, Wasp, Deathspider, Citadel, Tyrant Ship, Dragonship, Man-o-War, Flitter, Tradesman, and Sidewheeler Hulls	
Power Sources	33
Spelljammer Helms, including Major & Minor Helms, Series Helms, Pool Helms, Orbus, Forges, Gnomish Helms, Crown of the Stars, Furnaces, Artifurnaces, Lifejammers, and Nonmagical Engines	
Armaments	39
Catapults, Ballistas, Sweepers, Rams, Bombards, Jettisons, and Greek Fire Projectors	
Turrets	43
Hull Armor	43
Improved Maneuverability	44
Personal Weapons and Ammunition	45
Other Spelljamming Equipment	47
Crews	48
Initial Crew Status	49
Increasing Crew Status	49
Decreasing Crew Status	49
CHAPTER 4 MOVEMENT & COMBAT	51
Long-Range Movement	51
Traveling in Wildspace	52
Calculating Travel Times in Wildspace	53
Movement in the Flow	54
Tactical Movement	55
Facing	55
Movement	55
Speed	55
Stacking	56

Table of Contents

Combat	56
The Turn Sequence	56
Initiative	56
Long-Range Combat	57
Hit Points & Hull Points	58
Critical Hits	59
Breaking Up	60
Effects of Crew Losses	60
Debris	61
Fire	61
Fields of Fire	61
Morale	61
Short-Range Combat	63
Missile Fire at Close Range	63
Magic at Close Range	64
Ramming	64
Size and Ramming	65
Ramming and Ship Positions	65
Ramming Gargantuan Creatures	65
Crashes	65
Shearing Attacks	66
Grappling and Boarding	66
Rapid Resolution of Small-Scale Combat	67
Towing	69
Encounters, Evasion, and Running Away	69
Pursuit	69
Repair	70
CHAPTER 5 CELESTIAL MECHANICS	71
Laying Out the Planets	71
Moving on the Planetary Display	72
Encounters and Evasions on the Display	72
Universe Building	74
Preplanned Universes	74
DM-Created Universes	74
Randomly Generated Systems	74
APPENDIX 1 SPELL EFFECTS	78
Spells in Space	78
Wizard Spells	78
Priest Spells	85
Magical Items	88
APPENDIX 2 TRAVEL TIMES	90
APPENDIX 3 PLANETARY DISPLAY	92
APPENDIX 4 THE ROCK OF BRAL	94
A Guide to Sidebar Subjects	
Ships and Gravity Planes	6
Multi-Sphere Churches	14
Castaways in the Flow	28
Celestial Body Classification	34
Crew Positions	44
Ship Names	52
Why Are Crystal Shells Round?	58
Common Ship Commands	62
Nonstandard Systems	68
Krynnspace	74
Greyspace	78
Realspace	82
The Flow	86



Ships and Gravity Planes

Since the gravity plane of a ship runs through its two horizontal axes, it is possible to stand on the "bottom" of the boat, facing the opposite direction of the rest of the ship. In fact, it is feasible to build a ship with two decks, one topside, the other on the bottom.

The fact that this is not done is a reflection of both human (and other sentient) nature and common sense in space. The human nature part is the tendency to want all things "right-side up" when working with them, and while space-born races deny any such similarity with the groundlings they are as much creatures of habit as their ancestors were.

The more practical reason is what happens when two large bodies meet in space. The larger gravity plane takes over the smaller gravity plane, and its direction of "up"

(Continued)

Many of the details about fantasy space can be different from campaign to campaign and from world to world. All fantasy space, however, shares certain, universal basic properties and capabilities. This allows ships to fly between the planets and to voyage between the crystal spheres. This chapter discusses the nature of wildspace and the many facets and intricacies of travel and adventure in this new arena.

Space can be divided into two types: wildspace and the phlogiston.

Wildspace is what comes to mind when we talk of "space." It is the vast emptiness that lies between the planets and the stars. All space inside a crystal shell is wildspace. It is mostly vacuum. (More correctly, most regions of wildspace are vacuum. But the cosmos is a big place and there are exceptions to almost every rule, as shall be shown later.) Wildspace is not truly a void, however, even though it is often referred to that way. The simple fact that there is "space" rules out its being a true void.

The phlogiston is a turbulent, unstable, multicolored, fluorescent gas (or gaslike medium) which fills the regions between the crystal spheres. Very little is known for certain about the phlogiston or this region.

Every planetary system known is encased within a crystal sphere. Essentially, the crystal sphere keeps the wildspace in and the phlogiston out (this, of course, is a tremendous simplification, but it is easy to grasp). Like the phlogiston, crystal spheres are a great mystery; their origins and substance are unknown.

Within wildspace are the celestial bodies: planets, suns, moons, asteroids, and a host of other items collectively lumped together under the heading "planetoids." Most celestial bodies have an atmosphere of some sort although it is dangerous to assume that this is an inviolable rule.

Celestial Bodies

The celestial body that is most familiar to typical player characters is their home planet, be it Krynn, Oerth, Toril, or any one of hundreds of others that populate the universe.

Celestial bodies extend upward in size to that of the sun, and downward to the size of asteroids and planetoids. The tremendous variety that is possible (and proven) in celestial bodies mandates that the only accurate definition for the term is any significantly large conglomeration of matter that is wheeling about in wildspace. In general, however, a celestial body is a planetary mass. Most have a regenerating atmosphere. Celestial bodies can have any shape, though the most common is spherical. Still, there are flat worlds, elliptical worlds, cubic worlds, amorphous worlds, ring-shaped worlds, hollow worlds. Astronomers from Calimshan have even theorized the existence of a möbius world.

Celestial bodies usually, but not always, have an atmosphere which is usually, but not always, breathable. The depth, or thickness, of the atmosphere is directly related to the size of the body. The larger the body, the deeper the atmosphere. Again, these are general rules and exceptions abound. Voyagers may encounter large worlds without atmospheres, small worlds with thick atmospheres, and otherwise habitable worlds with poisonous atmospheres.

Some celestial bodies are aflame, fueled either by internal reactions or by significant access to the elemental plane of fire. Such bodies are called suns and provide most of the heat and warmth for the celestial bodies within any particular crystal shell.

Wildspace

All the celestial bodies within a crystal shell float in an airless void called wildspace. Conventional (meaning "those that take place on the prime material plane") interplanetary journeys around a solar system take place within wildspace. It is the first obstacle that must be conquered by would-be space travelers.

As an adventurer moves higher (whether climbing a mountain or on the back of a roc), the atmosphere becomes thinner and thinner until at last it becomes vacuum. The climber can still breathe, however, because as he moves upward, an envelope of air clings to him. When he reaches the point where the planet's air is no longer breathable, he is breathing his own air, held near him by his body's own gravity. This air envelope attaches to everything that passes

through the atmosphere and allows normal survival in wildspace, at least for a short time.

The disadvantage to such an envelope is its small size. The envelope of breathable air that attaches to any body has an all-around depth equal to the cross-sectional diameter of that body.

Example: A spherical beholder 5 feet across has an air envelope 15 feet in diameter. Similarly, a block of wood which is 1 foot by 2 feet by 3 feet is surrounded by a more-or-less rectangular envelope of air which is 3 feet by 6 feet by 9 feet.

A creature will exhaust the air in its personal envelope in 2d10 turns. Since this is barely enough time to get anywhere, most crossing of wildspace is done with larger vessels which have correspondingly larger atmospheres. The amount of air

which a vessel can bring along limits the minimum size of most space-going ships to no less than 100 feet in length (this measurement is called the *keel*). The cost of moving this amount of mass limits the upper size of the ship.

Gravity

The reason everything drags its own atmosphere around through space is gravity. This is also the reason why people can stand on a space-sailing ship without falling off its deck and can stand on a spherical planet without falling off the bottom side.

Every body in space has its own gravity. Gravity is an accommodating force in that its direction seems to be "that which is most convenient." In an object the size of a planet, gravity is directed toward a point at the center

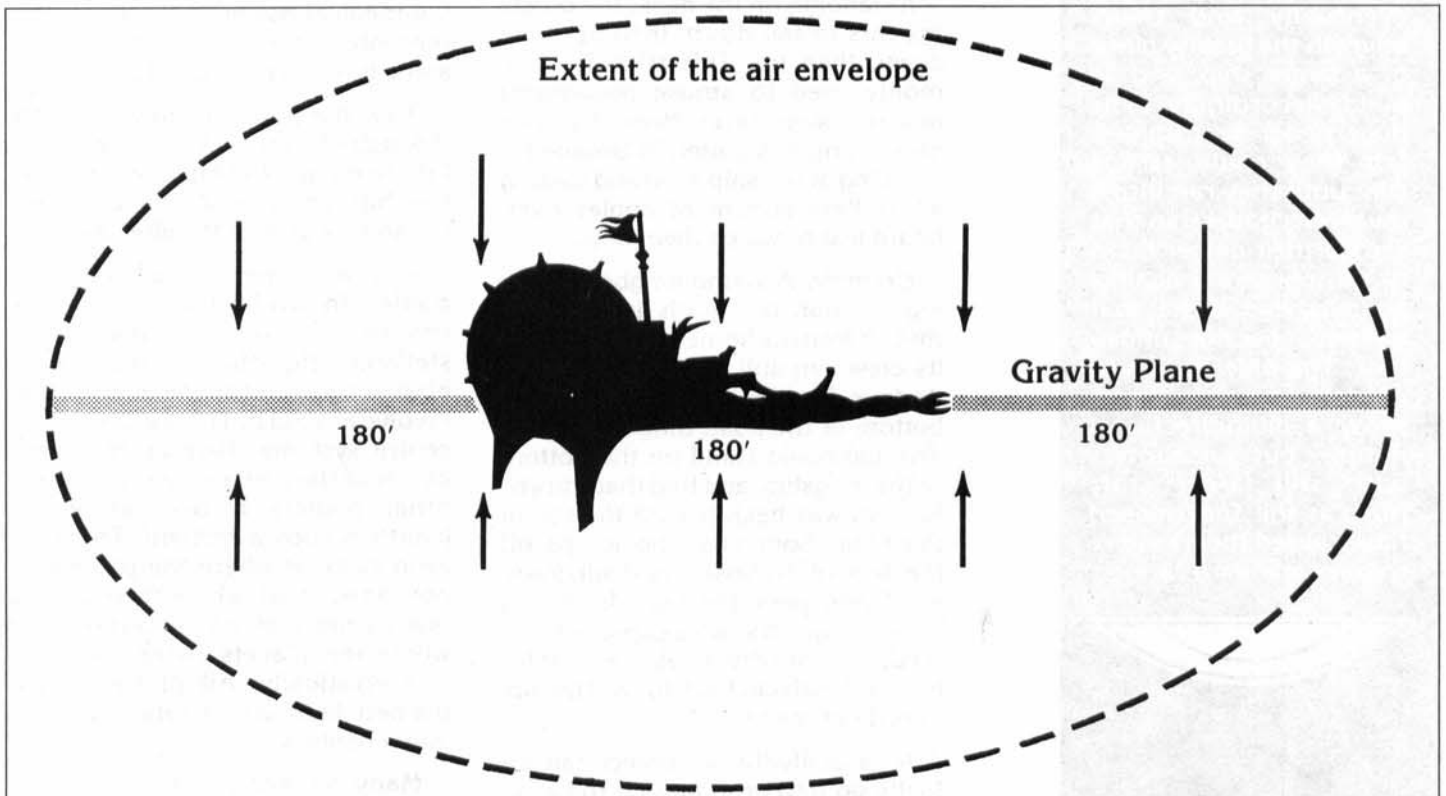



becomes the other's as well. A ship that has a standard "up" direction can more easily adjust to this new situation, while one with multiple "ups", such as our double-decker, will be caught in a situation where one side will go spilling off the deck toward the newly established gravity plane.

This situation results in most ships having a definite "up." Whether they can land on a planet or asteroid or not, they will eventually find themselves in the gravity plane of a larger ship, and so build accordingly. The huge neogi deathspiders felt they could escape this, until they ran into a dwarven citadel ship that caused their umber hulks to go splattering against an overhead dome that suddenly became underfoot. The older dwarven citadels, now abandoned, show a multidirectional nature, but encounters with still larger craft (such as the *Spelljammer*) have caused them to reintroduce standard facing.



of the planet so that people can stand anywhere on the surface and dropped objects fall perpendicular to the surface. In smaller objects, like space craft, gravity is not a central point but rather a plane which cuts horizontally through the object.

Significantly, this gravity plane is two-directional; it attracts from both top and bottom. A sailor can actually stand on the bottom of the ship's hull and move around as easily as if he was walking on deck. In this case, "down" is actually "up," back toward the plane of gravity that cuts through the ship.

One of the stranger side effects of all this is that an object falling off the side of a spelljammer can oscillate back and forth across the plane of gravity, falling first in one direction until it crosses the plane, then reversing direction and falling back across the plane again, and so on until something causes it to stop. To a person standing on the deck, the object appears to fall down, then up, then down, then up. This trick is commonly used to amuse passengers new to space travel. More than one groundling has gotten in trouble for standing at the ship's rail and tossing an endless stream of apples overboard just to watch them bob.

Example: A viking longboat cruising through the fjords is suddenly thrown from its home into wildspace. Its crew can still stand normally on its deck. Down for them is toward the bottom of the boat. Similarly, an individual could stand on the bottom of the longship, and find that "down" for him was back toward the top of the boat. Someone who jumps off the deck of the boat would fall downward and pass through the boat's plane of gravity, whereupon the direction of gravity would reverse for him and pull him back toward the underside of the hull.

A carefully-thrown object can actually go into orbit around the ship. Such orbits do not last long; the ob-

ject quickly collides with the ship's rigging or oars, or slows down in the air envelope and crashes into the ship. One of the favorite pranks of experienced spellsailors is to toss an apple or similar light object off one side of a ship in such a way that it curves around and strikes someone standing at the other rail.

The Helm

Ships travel through wildspace by means of the helm—a magical device which converts mystical energy into motive force, the push that moves the spelljammer. This allows rapid movement from planet to planet. Some of the specifics vary from race to race. In general, however, most ships are equipped with a magical device known as a spelljamming helm.

A mage or priest sits at the helm and acts as a living engine, providing the magical power to move the ship through wildspace and to perform some basic maneuvering as well.

Any magic can move a ship through wildspace. The more powerful the magic, the faster and further the ship can move. Again, check under ship design for the effects of this.

The arrangement of celestial bodies in wildspace varies from sphere to sphere. Many are stellarcentric—that is, the central body is a sun and all the other bodies revolve around it. There are also geocentric systems where a planet is the center of the system and the sun and other planets revolve around it (Oerth is such a system). There are even systems where the planets do not move at all, where there is only one planet and no sun, and some where the planets move randomly and erratically. All of this is explained in much greater detail in later chapters.

Many voyagers roam randomly through wildspace, looking for the

remains of lost civilizations, ghost ships, treasure rocks, and other objects that are not normally found closer to civilization. There are also space pirates and their bases floating off the beaten tracks, usually near dead worlds which would not otherwise attract attention. Finally, there are a surprising number of monsters living in wildspace, surviving by being so large that they carry a significant air supply with them wherever they go (such as space dragons), by retaining air within their bodies (gas fish), or by not needing to breathe at all (the neogi).

Crystal Shells

All wildspace is bounded by crystal shells or crystal spheres. Inside the crystal sphere is the vacuum of wildspace, the planets, and stars. Outside the crystal sphere is the rainbow ocean of phlogiston and more crystal spheres.

The size of a crystal sphere is determined by the size of the planetary system inside. Usually a sphere has a radius at least twice as big as the orbital radius of the outermost celestial body in the system (i.e., the distance from the shell to the outermost body of the system is the same as the distance from that outermost body to the center point of the system).

Because of their great size, the outside of a crystal sphere appears perfectly flat. The curvature is so gradual that it is completely undetectable to anyone who is close enough to see the crystal sphere through the obscuring phlogiston.

The spheres consist of an unbreakable, dark, ceramic material of unknown origin. Some legends state (and various theologians agree) that the smooth-surfaced shells were created and positioned by the gods themselves to protect their worlds from the ravages of the phlogiston,

which is held to be the prime matter of the universe. Less charitable philosophers maintain that such shells were placed by an even higher authority to keep gods and men in and confine their activities.

Whatever their origin, the crystal shells are uniform throughout space. All appear as great, dark, featureless spheres of unidentifiable matter.

The crystal spheres are definitely solid. They have no gravity along either their interior or exterior sides (an exception to the rule that all large objects have gravity). No magic has been found that can damage or alter the surface of a shell, except for those spells which cause portals to open. Even this, however, is believed to be nothing more than an artificial triggering of a natural phenomenon, since portals also occur naturally and seemingly at random. They are apparently immune to the effects of *wishes* and even the wills of the outer planar powers (though this does not rule out the possibility that the outer planar powers created them—perhaps they were wise enough to prevent even their own tampering).

The crystal shell is an impassable barrier to space voyagers unless they are properly prepared or very fortunate. Five methods are known for getting from one side of a crystal sphere to another:

1) It can be bypassed entirely with a *teleport* or *dimension door* spell. The traveler blinks from one side of the shell to the other without physically crossing the shell. Only a magical item or magical spell can effect such a transfer.

2) A *phase door* spell or magical device which duplicates that spell allows a ship or a portion of the shell to become immaterial so the ship can pass through.

3) Naturally occurring portals pierce the shell in various locations at random and unpredictable inter-

vals. Looking for such a portal can be a time-consuming task.

4) In some systems, stars are located around the fringes. Occasionally, such stars are themselves portals to other locations which can be accessed by diving into the heart of the star. Such portals are very rare; voyagers definitely should check local listings before incinerating themselves in an unknown situation.

5) The legendary *Spelljammer* and creatures such as space dragons seem to have an innate ability to open portals to the phlogiston. These portals close slowly over a long period, so other ships can sometimes pass through them. From outside a sphere, these portals are easily visible.

Note that portals as discussed here are merely simple doors allowing passage from one side of a crystal shell to the other. They are not gates and they do not allow transit between dimensions. Magic that relies on other planes or other dimensions is notoriously unreliable when cast in close proximity to a crystal shell.

The crystal sphere itself represents the outer limit of the influence of gods and other-dimensional creatures. Magic that summons or draws power from such beings or creatures does not function outside these bounds. Much of the decision as to what will and will not work is left to the individual DM, but this restriction definitely does not apply to priest spells of levels 1 and 2.

Those fantasy systems with stars in the night sky often have these stars mounted along the inside of the crystal sphere. The nature of stars varies from sphere to sphere, however. Within some spheres the stars are small portholes looking out on the phlogiston, in some they are painted lights along the interior, in some they are great cities inhabited by alien creatures, and in others they



In combat, a larger ship can use its ability to turn an opponent off-balance by passing close in a shearing or ram attack, forcing the smaller ship to reorient itself (often pulling its weapons out of range) or risk crashing on the larger vessel. Dwarven ships, with greater hull points, often prefer this method to ramming.

It is relatively easy for a ship to reorient itself while under the command of a spelljammer. If attempting to do so without a spelljammer at the helm, each character on deck must roll his Dexterity or less or fall toward the other ship. Both ships involved in such maneuvers carry nets to allow the crew to save themselves, or to keep unwanted clutter from other ships from dropping on them.



are great bowls of fire held aloft by huge statues of forgotten gods.

The Phlogiston

Outside and between the crystal spheres is a turbulent, rainbow ocean of flammable ether called the phlogiston. The phlogiston is a multicolored sea upon which float the various systems within their crystal shells. The term phlogiston is applied equally to both the multicolored medium and to the entire region surrounding the crystal spheres.

Phlogiston has varying thicknesses in space and forms dense rivers between planet-sized objects (such as the spheres themselves). Voyagers moving along these paths of concentrated phlogiston discover that the greater the density of the flow, the faster a ship can move. A ship can speed up and slow down by penetrating deeper into or raising itself out of these phlogiston rivers. Stellar distances can be covered quickly in such areas. Further, the speed of the ship is at least partially dependent on the surface area it presents to the flow, so many ships carry sails to increase their speed in the interstellar ocean.

Gravity works in phlogiston the same way it does in wildspace. Down is directed toward the major axis of the ship.

Phlogiston is none of the recognized four elemental matters. It is neither air nor earth, fire nor water. It cannot be reproduced or brought inside the bounds of a crystal sphere. If an attempt is made, whether by physical or magical containment, the phlogiston inexplicably dissipates, leaving no trace. Phlogiston simply cannot exist within wildspace or on the surface of a planet.

Finally, phlogiston is dangerously flammable, much like oil-soaked cotton, which poses its own problems. Any flame exposed to phlogiston

causes the surrounding area (including the phlogiston-laden air envelope of the ship) to burst into flame. This flame expands immediately to three times its normal diameter and inflicts three times its normal damage. For this reason, fireballs, bombardments, arquebuses, and any other weapons which rely on a spark or flame are not used in the phlogiston.

The effects of various types of flame exposed to phlogiston are as follows:

Candle (lit)	1 die fireball 4" across
Lantern (lit)	3 die fireball 1' across
Oil Flask (lit)	3 die fireball 3' across
Cooking Fire	4 die fireball 10' across
Fireball	3 times size and effect
Match (fuse)	1-2 points (plus immediate misfire if arquebus)

These effects occur immediately. For example, lighting a flask of oil to use as an incendiary weapon will cause it to explode immediately. (Actually, a character would have to be extremely tricky and careful even to get that far. The phlogiston would ignite as soon as a flame was created with which to ignite the oil.) The fire resulting from a *fireball* or other fire-related spell is centered on the wizard casting the spell.

Because of the nature of phlogiston, all flaming light sources are extinguished by the crew before entering the flow. Phlogiston is radiant, so no other lights are needed on the exposed decks. Below decks, or in rare (and haunted) Dark Regions of space, cold natural lights (moths or fireflies, fluorescent moss) or magical lights are used for illumination. The heart of dwarven mountain-craft are without running lights, since dwarves have infravision.

Voyagers can move along the riv-

ers of phlogiston at random or according to a planned course. Many of these rivers flow in both directions between two crystal shells. In some cases, a river flows in one direction only, forcing the voyager to follow a different course when returning home.

The crystal spheres bob in the phlogiston like corks in an ocean (mind-boggling, enormous corks, but they do bob). As a result, over time the spheres actually shift their positions relative to each other. This almost never changes the courses of the rivers, however, so navigation is possible. But just because a ship passed certain landmarks on its way from A to B does not mean the ship will pass those same landmarks on its way back to A from B. Fortunately, when crystal shells drift too close, the phlogiston between them thickens to the point where the two massive spheres are moved apart and a collision is prevented.

The spheres containing Toril, Oerth, and Krynn form a stable triangle. Travel is possible in both directions between Toril and Oerth, and between Oerth and Krynn. Toril and Krynn are not connected by a river, however, so while a direct trip from one to the other is feasible, it is impossibly slow. From Toril, Krynn can be reached quicker by passing through Oerth than by taking a straight-line path.

Breathing in Space

As a character ascends a mountain, the air becomes thinner and thinner, until finally it becomes the unbreathable vacuum of wildspace.

Fortunately, all bodies take an envelope of air with them, and this provides some breathable atmosphere. Unfortunately, this envelope is rarely

large enough to support life for very long.

A single, human-sized body drags along with it enough air to last 2-20 turns. If that human-sized body is standing on a rock 100 cubic yards in size (roughly 40 feet in diameter), it may have enough air to survive for several months.

Larger-than-man-size creatures (ogres and giants, for example) drag along enough air to last twice as long (4-40 turns).

Larger objects, such as ships, are rated for their tonnage. Each ton represents 100 cubic yards of space, which brings along enough air to support one human-size crew member for four to eight months. A 30-ton frigate, therefore, could support 30 crew members for four to eight months under normal circumstances, and double that under reduced circumstances. This is explained fully in the chapter on Ship Design. The minimum size for a usable ship in space is 1 ton (100 cubic yards). The limitations on moving a ship through space determines the upper limit of ship size.

Air Quality

The air envelope around a body or ship can be one of three classes or qualities—fresh, fouled, or deadly. Air can change from one quality to another over time.

Fresh air is completely breathable. The air around an individual body remains fresh for 2-20 (2d10) turns. Air around a larger body (one ton or more) remains fresh for four months if the vessel carries a normal crew.

Fouled air is stale and partially depleted. It is humid and smells bad. Air becomes fouled after the first 2-

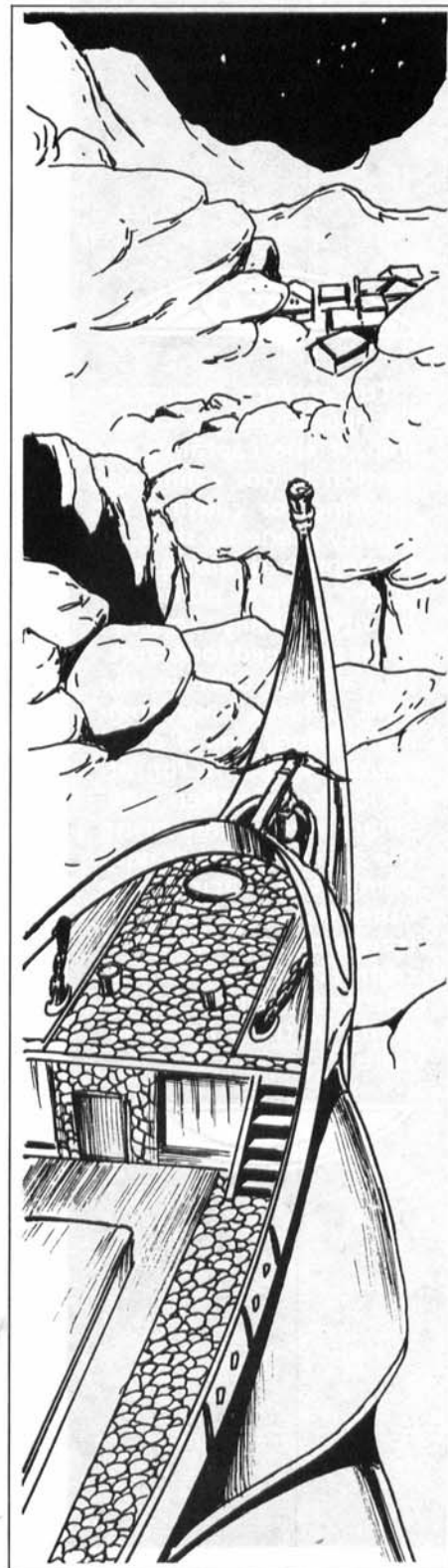



The correct procedure for approaching a larger ship, if the captain's intention is not ramming, shearing, or causing its gravity plane to shift, is to approach along the larger ship's plane of gravity initially. This negates the need for corrective actions once in the field, allows easy communication, and a good launching point for attacks from either side. Smart-alecks can bring the ship in on the gravity plane but facing the other direction, but this is regarded as a breach of courtesy in diplomatic entreaties and relationships with other captains.



20 turns around a single body and remains fouled until the 30th turn. For example, if the air was fresh for 12 turns, it would be fouled for 18 turns, for a total of 30 turns. The air around a ship is fouled from the beginning of the fifth month until the end of the eighth month. All attack rolls and ability checks made by characters or creatures that must breathe air have a -2 penalty if the air is fouled.

Deadly air is completely depleted and filled with carbon dioxide. It cannot support life. The air around an individual becomes deadly at the beginning of the 31st turn, that around a ship becomes deadly at the beginning of the ninth month in space. Anyone trapped inside a deadly atmosphere must make a saving throw versus poison each turn. Failure means the character passes out. A second failure brings death. Only fresh (or fouled) air can revive the character after he passes out.

Most trips aboard ship take less than four months to complete, or at least present the opportunity to replenish and refresh the air supply within four months. Air usually is not a problem except in extreme cases and emergencies.

Changes aboard ship can affect how long the remaining air will last. There are two ways for the DM to handle this: a fast method that involves some necessary simplifications and an accurate method that involves considerably more math.

Method 1: A ship's air is fresh for four months. This is altered only if the number of crew aboard is at least 25% high or low. For each 25% over the standard crew, the air supply is reduced by one month. For each 25% under the standard crew, the air supply is extended by one month. These adjustments are made at the beginning of the trip. From that point on, the air supply cannot be extended by losing crew members, but it can be shortened by adding crew

members. The crew must be increased by at least 25% of its standard limit to reduce the air supply by one month. For example, a 30-ton frigate sets sail with 30 characters aboard, the standard limit. It has air sufficient for four months. After six weeks, 10 characters are lost in a battle. Even though this represents more than 25% of the crew it has no effect on the air supply because the air supply cannot be extended. Three weeks later (nine weeks total, or 2.25 months) 20 characters are rescued from a drifting hulk. This raises the current crew to 40, which is at least 25% greater than the standard limit of 30, but not 50% greater. The air supply is reduced by one month, so it will now be fouled at the end of three months.

Method 2: This method is entirely mathematical. The DM redetermines the ship's air supply every time the number of characters aboard changes. The air supply can increase or decrease. To determine the ship's new air supply when it changes, multiply the current air supply by the number of people that air was for, and then divide that product by the new number of crew. Round fractions down. For example, a 30-ton frigate sets sail with 23 characters aboard. It carries enough air to remain fresh for four months (16 weeks) if breathed by 30 people. With 23 crew, the air will last $(30 \times 16 / 23 =)$ 20 weeks. Seven weeks into the trip, five crew are lost fighting a monster. The remaining air will now last $(23 \text{ crew} \times 13 \text{ weeks} / 16 \text{ remaining crew} =)$ 18 more weeks before becoming fouled.

When two bodies meet in space, their atmosphere is exchanged. The class of the air in the smaller body becomes that of the larger body. If the smaller body is at least two-thirds the size of the larger, both get one-half as much air as the larger had remaining. If the smaller is less than two-thirds the size of the larger, both

get the larger's full supply of air, minus one week. For example, if a 30-ton frigate with fouled air encounters a 60-ton man-o-war with 12 weeks of fresh air, the frigate gets 11 weeks of fresh air and the man-o-war loses one week. If the frigate had been 40 tons or more, both ships would have gotten six weeks of fresh air.

The same thing applies to two individuals exchanging atmosphere. An individual has no effect on a ship's atmosphere, however, unless the individual is at least huge.

A number of creatures can survive in space without air (undead or magical creatures such as golems, for example). They are unaffected by the status of the air envelopes around them. Certain spells and magical items provide additional protection to the star traveler who may find himself in deep space without a ship.

Classes of atmosphere operate in the same manner in the phlogiston as they do in wildspace. However, when the atmosphere goes dead, a special property of the phlogiston takes over. Instead of dying, the individual lapses into suspended animation until the atmosphere around him is recharged. Living flesh turns gray and stonelike and remains that way until the individual is rescued. By following along the flow, a ship or individual will eventually drift near a sphere, where recovery is at least possible. Note that rescue is not necessarily by someone with good intentions. The neogi and mind flayers do excellent business in robbing and enslaving the unfortunate individuals they find adrift in the phlogiston.

Crystal shells usually have no atmosphere of their own, either inside or outside. There are many asteroids and planets that lack atmosphere as well, in contradiction of normal physical laws.

Matters of Gravity

In space, whether in the flow or in wildspace, gravity performs the same way. A plane of gravity runs through the long axis of any large body. Any structure or creature with an axis at least 25 feet long has a plane of gravity sufficient to attract other objects. A person could walk on the back of a 25-foot-tall giant floating in space as if the giant was a planet.

Every body with a plane of gravity (including asteroids, most standard ships, and some huge or larger monsters) exerts a pull identical to that on a standard planet ("Earth-normal" gravity). A body without a plane of gravity still maintains an envelope of air but exerts no pull on other, solid objects.

Gravity is an all-or-nothing proposition. Either it is there at full strength or it is not there at all. Gravity always exerts the same force whether the body creating it is the size of a whale, the planet Toril, or a massive gas giant planet.

The gravity of a body extends to the same distance as the air envelope—that is, to the edge of the object's atmosphere. Within those bounds gravity functions normally toward the gravity plane; outside that limit, gravity is not present in any degree. A body in that region is weightless.

Since gravity is represented by a plane running through the long axis, any large body has a "top" and "bottom." It is possible to walk along the bottom of a ship, as gravity is still pulling the character down toward that long axis. Technically, a ship could be built with two decks, both parallel to the gravity plane. In practice, this is almost never done because such a ship cannot land. Some deep space craft and asteroid bases have equal housing on the top and bottom.

The plane of gravity runs out beyond the edges of the body to the fringe of the air envelope. Therefore, a character stepping off the deck of a ship falls toward that plane. He passes through the plane, at which point the direction of gravity reverses and then he falls in the opposite direction. There is no damage from falling off a ship in this fashion.

Drifting

There is a problem for unrestrained objects resting on the plane of gravity of another large object, however. Along the plane an object is weightless, but it is pushed slowly out toward the edge of the gravity field. Therefore, a man overboard would eventually come to rest at the ship's plane of gravity, then begin drifting away from the ship along that plane toward the edge of the air envelope. On reaching the end of the gravity plane he is pushed outside the air envelope and then left behind as the ship moves away.

Because objects at the level of the gravity plane itself are weightless and undergoing a small but definite push toward the edges, this center plane is often used to launch heavy missiles or prepare boarders to attack other ships.

Aside from this slight push, there is no relative motion of a ship within its air envelope, aside from turning. A ship's air envelope does not turn with the ship when it turns, but objects in the ship's air envelope do not drift toward the rear of the ship simply because the ship is moving forward.

Overlapping Gravity

When gravity planes intersect (such as when two ships pass each other at close range and different angles), the gravities of both ships remain in effect, regardless of size, up to the point where they physically intersect. An object is under the influence of whichever gravity plane it is



Multi-Sphere Churches

Most faiths are limited to a few crystal spheres where their sense of worship is strong. A lawful good war god may be known under several different names on one planet, or different aspects of a nature deity may be venerated on a single continent, but in general all come together under one general group heading. A cleric of Tyr or St. Cuthbert or Kir-Jolith may expect to receive his normal spells as long as he is in the wildspace of, respectively, Toril, Oerth, or Krynn.

Once out of one's native sphere, however, the chances of encountering fellow followers of one's deity are greatly reduced. In different spheres different powers rule, and while some have agreements with other beings of similar portfolio (see *detect powers* spell), some are strangers and/or actively hostile to the cleric's faith.



closest to. A character could leap between two passing ships, altering his down direction as he crosses the midpoint between the two.

When two ships come into direct contact (one rams the other or lands on the other), the gravity of the ship with the higher tonnage is dominant and becomes the gravity for both ships. For example, an elvish light scout has its own gravity until it lands on its parent ship, at which point it adopts the down direction of its parent. Or, as another example, a large mind flayer vessel could ram a smaller ship from directly above and spin the smaller ship's gravity plane by 90 degrees, causing everything on the rammed ship to tumble toward the larger ship's plane of gravity, probably with disastrous results.

Falling

A weightless character who enters the air envelope of a larger body is immediately affected by the pull of gravity of that body. He will, in effect, fall the distance from where he entered to the surface of the body, or to the plane of gravity, whichever is nearer. Normal falling damage applies if the character hits something solid at the end of the fall.

In cases where the drop is more than one mile, there is also danger of the subject heating up and igniting from friction with the air (becoming a shooting star). This happens after one mile of uncontrolled descent. The falling object catches fire and takes normal damage from fire for the remainder of the plunge. Flight, levitation, or any sort of control over speed and descent can negate this effect.

Characters who are weightless can move under the familiar laws of physics. Any force has an opposite force. A drifting fighter can move (slowly) by throwing equipment in the opposite direction. Maximum movement in this fashion is 3 per round.

Combat

Combat in weightless conditions is considered a foreign combat environment to those who are not accustomed to the situation. Nonnatives of space have a +6 penalty on their initiative rolls and a -2 penalty on all attack rolls. Nonnatives are those characters and creatures who are originally from campaigns that are not oriented around space adventure, or are unfamiliar with weightless conditions and fighting in three dimensions. Characters who are native to space, or have the Weightless Combat proficiency (see *New Proficiencies*) can fight without these negative modifiers.

Missile fire functions normally within gravity fields. Once outside those fields, however, there is nothing to slow down the objects once fired. For this reason, missiles will continue to travel forever, with no limit, until they encounter something. All missile weapons in space have an extreme range which extends from the limit of long range to the limit of the character's vision. There is a -10 modifier to hit at extreme range. A missile travels the equivalent of twice its long range each round.

For example, imagine a character firing a long bow at a target that is 2,000 yards away. The long bow's long range is 210 yards. The attacking character's THACO is 15 and the target's AC is 7. The attacker needs to roll an 8 or higher to hit. With the -10 modifier for extreme range this is adjusted to an 18 or higher. After being fired, the arrow will travel 420 yards per round. It will reach its target five rounds after firing.

This applies to normal hand-held weapons only. Siege machinery, catapults, and ballistas mounted on ships suffer no such limitation, as they are designed with such long distances in mind.



Weightless conditions apply to both wildspace and the phlogiston with no differences. Despite their size, crystal spheres have no gravity, inside or out.

Temperature

Due to the activity of the planets, the spheres, and various gates to the plane of elemental fire, temperature in wildspace is not a problem for adventurers. The ambient temperature in most space is about the same as a moderate summer day in the temperate regions of most worlds.

Some crystal shells, however, have surprisingly higher or lower temperatures, and those should be noted on any star chart worth reading. A shell that is little more than an opening into the plane of elemental fire will have a higher temperature than one

without any such openings. Krynn space has a very low natural temperature (about 16 degrees fahrenheit) and is plagued by small, lethal clouds of ice particles.

The phlogiston maintains a similarly comfortable temperature, but with the added danger of explosive fire, as described above.

There are no seasons in the phlogiston or wildspace. Of course, as a ship approaches a star, the temperature increases. Landing on a body of fire creates problems similar to entering the elemental plane of fire. A water body could conceivably be cold enough to be nothing but a ball of ice.

Time

Local time often varies from planet to planet and sphere to sphere, depending on rotational per-

iods, custom, and a host of other factors. Spelljammers often rely on what is considered the standard day for time-keeping aboard ship.

A standard day is 24 hours, and is broken into three watches of eight hours each: first, second, and night (also called graveyard) watch. A standard week is seven standard days, a standard month is four standard weeks (28 days).

There is no standard time period beyond the month. The typical method of determining the length of a year—the time that passes during a complete cycle of the seasons—has no meaning for a group that spends most of its time in space. Anything from 10 to 15 months can be considered a year, depending on the people who are keeping track of it.



Given the effects of clerics having variable abilities from sphere to sphere, or even from world to world, the civilizations of space have evolved their own faiths that take into account the wide variety of beliefs. These faiths are recognized wherever there is space civilization in the Known Universe. Where there are no such civilizations, these sects are not recognized, and their priests are limited as are the groundling clerics—they cannot gain spells above second level.

THE POLYGOTS: The Polygots are a pantheistic faith that worships entire organizations of Powers as opposed to a particular Power. A priest of the Greek mythoi, or the Norse gods, would qualify as a polygot priest. If any members of a particular polygot priest's pantheon are present in the sphere, then that cleric regains his spells normally. For example, Tyr of Toril is originally a native of the



The bulk of the AD&D® game rules are unchanged by the move into space, but there are some changes, additions, and new options available to players. This section summarizes all the major additions to the core rules of play laid out in the *Player's Handbook* and *Dungeon Master's Guide*.

Ability Scores

AD&D ability scores are unaffected in play in space. A high Strength means the same thing in space as it does on the ground. There are new devices that require a certain ability score to function properly, and these limitations are noted with each item's description.

Character Races in Space

Most spacefaring character races are similar to their more familiar, terrestrial counterparts as far as abilities and capabilities are concerned. A void elf may have a different societal background than a valley elf from Oerth, a moon elf from Toril, or one of the Qualinesti from Krynn, but all elves obey the basic rules of their character classes. Similarly, dwarves retain their character class distinctions, as do humans, halflings, and half-elves.

The level restrictions and any special abilities of a particular race are dictated by their home world. If their home world has high-level elven clerics, then natives of that world who happen to be clerics should not be limited even if they move to other solar systems that have no elven clerics.

There is also the spaceborne race of lizard men. On most worlds, lizard men are little more than savages. In space, they have full capabilities as a player character race.

Finally, there are a number of lesser races found in space, such as

kender, hengeyokai, and spirit folk. All these individuals have the restrictions and abilities accorded to them on their native worlds.

Lizard Men

Lizard men are humanoid lizards who walk on their hind legs and have three-fingered hands with opposable thumbs. While not among the more brilliant races found in space, they are on a par with halflings and humans. Depending on their world of origin, they vary from five to seven feet tall. Their scaly reptilian skin is normally brownish green to light green, but in space societies they decorate themselves with extensive tattoos and body paints.

Lizard men tend to be short-tempered and emotional, with little patience for warm-blooded beings of other races. Their name for others is "BreK/qq/zz," which is derived from the lizard man word for "prey." Lizard men are usually neutral, tending towards chaotic behavior, but there are lawful and good members of the race, as well.

Lizard men have appetites that rival the halflings' legendary love of food. Unlike halflings, they are more omnivorous and less choosy about cooking their meals. Lizard men in space generally do not kill other sentients for food, but are not above scavenging among the dead for interesting tidbits.

Lizard men benefit from their own naturally strong hides, which provide them with AC 5. A lizard man gains no additional protection from armor, unless that armor raises the AC to a level better than 5. Thus, a lizard man gains no benefit from normal leather armor, but does gain a benefit from wearing plate mail. Lizard men gain benefits from magic that enhances armor class, but from magical armor only if that armor raises the AC above 5. Lizard men gain no benefit to AC for exceptional Dexter-

ity, though they do gain the benefit from Dexterity for using missile weapons.

Lizard men naturally inflict 1-2 points of damage with each of their clawed hands and 1-6 points of damage with their large tails. Lizard men also carry weapons, but when they attack with both a weapon and a tail, it is considered an attack using two weapons and all effects of such an attack are applied (*Player's Handbook*, page 96).

Lizard men can be fighters (maximum 12th level), thieves (maximum 11th level), or clerics (maximum 7th level). They may not be multi-classed. There may be lizard men wizards on some worlds, but they are not dealt with in this product.

Lizard men can speak their native language as well as common. They have infravision extending up to 60 feet. Their base move is 6, and an unarmored or lightly encumbered lizard man can swim 12.

Racial Ability Requirements

Strength:	8/18
Dexterity:	3/18
Constitution:	6/18
Intelligence:	3/17
Wisdom:	3/18
Charisma:	3/16

Average Height & Weight

Base Height	60/60
Modifier	2d12
Weight	150/140
Modifier	3d10

Age

Base Age	10
Variable	2d6
Max. Age	350

Note that lizard men mature quickly, but like many reptiles, have very long possible lives. Their violent style of living, however, means that very few reach middle age, much less venerable status.

Special Races and Classes

Many worlds have special player character classes and/or player character races: samurai, hengeyokai, minotaurs, and other "specialty" classes and races unique to particular campaigns. These classes function normally in wildspace, within the void's physical limitations. They are not normally used for player characters in space.

Player Characters Native to Space: All the character classes and races presented in the *Player's Handbook* are represented in space.

Magic Use in Space

The effects of certain magical and clerical spells and spell-like abilities are limited in the phlogiston that lies between the crystal spheres. However, those limitations are offset by the availability of new spells for mages and clerics in space. Individuals with magical abilities may also use their powers to operate a spelljamming helm, allowing them to move their ships across the stars.

Clerics in Space: Clerical magic operates normally within the crystal shell that surrounds a cleric's native world, but is severely hampered once that cleric enters the phlogiston. A cleric receives his spells through the offices of his deity, and his deity's effectiveness ends at the crystal shell. The phlogiston is impenetrable to extra-dimensional magics, and as a result the "gods" and other powers have no sway there.

A cleric entering the Flow may use those spells he brought with him (with normal restrictions for the physical nature of phlogiston). However, a cleric may not regain spells above 2nd level while in the phlogiston. This is because he remains out of direct contact with his deity. Loss of such

spell abilities does not affect a priest's spelljamming ability (see below).

A cleric who enters a foreign crystal shell is similarly restricted. The only exceptions to this occur when a cleric's deity (or a similar power) is recognized in the foreign shell or the cleric casts a successful *gate* spell, affording his deity access to the foreign shell.

Any god or power is considered "recognized" within a sphere if he has worshipers and/or an organized church anywhere within that system. This does not mean that a PC cleric can move into a shell and automatically establish a base of worship for his god. For a deity to be a recognized power in any shell, he has to have an *established* group of worshipers somewhere in the system.

Characters native to space may worship the deities of the sphere they are in or may follow a number of faiths found in many space civilizations. These faiths are:

- The Polygots
- The Path & The Way
- Ptah (the traveler's god)
- Various planar churches

These faiths are represented wherever there are space civilizations.

Conjuration/Summoning Spells: Spells that call upon beings from the surrounding area will not function if none of those creatures are located within the spell's range. A *call animals* spell will not work in wildspace if there are no animals present there.

Conjuration/Summoning spells will not work in the phlogiston if they summon extra-dimensional monsters or powers. No power, god, elemental, or other meta-planar creature can be summoned in the phlogiston, and any spell that attempts to do so will fail.

In addition, any spells that place the caster in contact with an extra-



Norse mythos (though Thor, Odin, and Loki have never made beachheads on the planet or attracted a large following). A cleric worshipping the Norse polygot (all the Norse gods) would regain spells on Toril since Tyr is a native. With the expansion of the Polygot's in space civilization, representatives of the various polygot sects can be found in most organized shells. Polygot priests are not popular on the ground, however, because it is there that the various gods struggle one against the other for worshipers. A polygot priest of the Lendore Isles of Oerth would find himself under increasing pressure from the various faiths of Oerth to "choose sides" if he spent any amount of time in those isles. Most nonhuman (elvish, gnomish, dwarvish, etc.) priests found in space are polygot clerics of their racial mythoi.



dimensional power fail in the Flow.

Planar Travel: Travel between the planes of existence functions normally within the various crystal shells. A character in wildspace may go ethereal, enter the astral plane, or open a gate into one of the outer planes.

In the phlogiston, however, the dimensions cannot be accessed. Therefore, devices and spells, including *armor of etherealness* and *portable holes*, will not function in the Flow. A device or spell that holds objects in external dimensions will still hold them, but the items cannot be accessed with anything short of a *limited wish* spell.

For example, a particularly nasty efreet is trapped in a *portable hole* in Waterdeep, in the Realms, then carried to the edge of that system's crystal shell and thrown into the Flow. A passing ship finds the portable hole but cannot open it until it makes landfall inside another crystal shell. Once the portable hole is opened within the new system, the very irritated efreet can leave.

Fire and Wildspace: Within the air envelope that surrounds a planet, fire burns normally. Outside that envelope, however, there is a vacuum that will not support fire.

Magical fire (such as fireballs) will work in the vacuum of space, as it is the sudden creation of fire that requires no air. Magical fire will not cause other objects to burst into flame, however, because there is no air to support a non-magical reaction.

Fire and Phlogiston: Fire works all too well in the phlogiston. As noted in Chapter 1, the entire area is permeated with an explosive mix. This makes both magical and non-magical fire extremely dangerous.

The effect of the Flow on non-magical flame is discussed in the section on the phlogiston. Magical

fire used in the phlogiston will cause an automatic detonation of the spell on the user. A wizard trying to cast a 12-hit dice *fireball* will find himself at the center of a ball of flame. This may be advantageous to a powerful spellcaster with resistance to fire. In general, though, such dangerous displays are frowned upon since they prove to be damaging to ships.

Spelljamming

Spelljamming is the conversion of magical energy directly into motive force for ships in space. Spelljamming can be accomplished either by spells or through a magical device known as the *spelljammer helm*. Both priests and wizards can spelljam, as can creatures with spell-like abilities. Character classes such as paladins and rangers gain spelljamming abilities at the point that they may cast spells, but cannot spelljam until that time. Wizards of specific schools or specialty clerics may spelljam normally, though they may also be able to use certain specialty spells to accomplish it.

The *spelljammer helm* is a device formed like a great chair, with recesses for the head, feet, and arms of the person using it. The styles of helms vary from simplistic and functional to ornate and gothic. In all its configurations, the helm is designed to pull magical energies from the user and convert them into full-fledged spelljammer power to move and maneuver space ships.

A major helm converts magical ability to energy at a 1 per 2 level rate. Round fractions up. A 1st- or 2nd-level wizard provides a ship's spelljamming rating (SR) of 1, while a 20th-level cleric provides a spelljamming rating of 10. (SR = level/2 rounded up.) Chapter 4 details the importance of the SR number.

A minor helm converts magical ability to energy at a 1 per 3 level

rate. Round fractions up. (SR = level/3 rounded up.) Therefore, a 1st-, 2nd-, or 3rd-level wizard provides a spelljamming rating level of 1, while a 20th-level priest provides one of 7. Ships often maintain a minor helm as a back-up system. Some ships even use minor helms as relatively inexpensive primary systems.

Another magical item that can provide spelljammer power is the *crown of the stars*. This device is worn over the head and creates a spelljamming rating as a minor helm. (SR = level/3 rounded up.) It has the advantage of portability and allows the spelljammer to move about while using it.

Both major and minor helms require "fresh" and well-rested spellcasters to function at their best. A spellcaster that has cast any of his possible complement of spells before activating a spelljammer helm loses one spelljamming rating for each spell cast (minimum SR of 1).

Using a major or minor helm even for a short period removes all spellcasting ability from the spell-user until the individual rests long enough to recover spells.

Humanoid spellcasting races normally use spelljammer helms to travel through space. Other creatures use a variety of methods to propel their ships. Mind flayers, who have powerful mental blasts, use several specially designed helms in series. Beholders use a mutated version of their race known as an orb to move their ships. Dwarves, who are by nature nonmagical, use devices called forges to journey through space. All these alternate spelljamming techniques are discussed in Chapter 3.

In addition to the various magical items that can propel a ship, there are several new magical spells that provide spelljamming powers for limited duration.

Wizard Spells

Second-Level Spells

Locate Portal (Divination)

Range: Special
Components: V, S, M
Duration: 1 round
Casting Time: 1 turn
Area of Effect: Special
Saving Throw: None

The caster of a *locate portal* spell can find the nearest portal through a crystal shell either into or out of the Flow. The spell indicates direction and distance (either in miles or in travel time, should the cleric know the particulars of his own ship).

In general, from any point on a crystal shell, the portals for a normalized ship are from 2-20 days away from any location. At the moderator's option, there may be more portals than normal available, less, or none at all. This is up to the DM to determine.

The spell may only be cast within 100 yards of the surface of a crystal shell.

The material component of this spell is a conch shell.

Third-Level Spells

Chill Fire (Alteration)

Range: 10 yards
Components: V, S, M
Duration: 1 turn/level of caster
Casting Time: 2
Area of Effect: 40 yard radius
Saving Throw: None or Neg

The *chill fire* spell functions only in the phlogiston, and casting it in other surroundings is useless. In the phlogiston, however, the spell reduces the flammable nature of the phlogiston for one full turn per level of the caster. A 15th-level wizard could reduce the flammability of an





THE PATH & THE WAY. Referred to either as a single grouping, or as either of its parts, The Path and the Way are a terrestrial gathering of faiths which made the leap full-blown into the stars. A teaching used primarily by the Oriental groundling nations, it sets forth not one particular deity as worthy of all worship, but rather a celestial bureaucracy, well-managed and organized, with various Powers taking on particular duties, with each of the Powers recognizing the place of the others in the cosmic whole. The differences in the various branches of the Path and the Way come from the organized teachings of those faiths as opposed to the Powers they venerate. The different schools may disagree (violently) about the true nature of the Path or the inner nuances of the Way, but the organization of regaining spells for clerics is unaffected. This grouping of faiths transferred very easily



area the size of his ship for 15 turns.

When this spell is in effect, the flammable nature of phlogiston is reduced. Though a *fireball* spell will still center on the spellcaster who created it, the damage caused by the fire will be normal. This applies to both magical and nonmagical fire.

The material component of the *chill fire* spell is a sliver of glass or ice.

Enhance Rating

(Alteration)

Reversible

Range: 10 yards

Components: V, S, M

Duration: 1-4 rounds plus
caster's level

Casting time: 3

Area of Effect: 1 individual using a
spelljammer helm

Saving Throw: None or Neg

This spell can only be cast upon an individual using a major or minor spelljammer helm, whether existing or created by the wizard or priest spell. This spell will raise the SR of the ship using the helm by 1-2 points for the duration of the spell. Only one *enhance rating* spell may be used at a time, and the caster may not use it on himself.

The reverse of this spell, *decrease rating*, reduces the SR of the spelljamming helm and its user by 1-2 points for the duration of the spell. The occupant of the helm has an opportunity to save versus magic against the spell, with the effects negated if the save is made.

The spellcaster must be able to see the person he is throwing either *enhance rating* or *decrease rating* on. Neither spell will work if the intended target is hidden.

The material component of this spell is a small ivory arrow. It is pointed upward for the *enhance rating* spell or broken for the *decrease rating* spell.

Fifth-Level Spells

Create Portal

(Alteration)

Range: 100 yards

Components: V, S, M

Duration: 2d6 turns

Casting Time: 5

Area of Effect: Area of crystal shell
100 feet in radius

Saving Throw: None

This spell may only be cast when under 100 yards from a crystal shell. The spell causes a large area of the shell to become temporarily insubstantial and ethereal, allowing a ship (or anything else) of the correct size to pass through. The effect lasts for up to 12 turns, during which time any other ships or items may pass through.

The opening does not weaken the crystal shell, and any objects resting physically on the shell are unaffected by the portal. It takes but a fraction of a round for a ship to pass through a portal opened in this fashion. However, if the portal is dispelled or otherwise prematurely closed, roll 1d10 to determine the fate of the object passing through the opening as it closes:

- 1-5 Portal closes before ship reaches shell. Ship must turn or ram the shell.
- 6 Portal closes on the ship. Ship is cut in half.
- 7-10 Portal closes after ship passes through.

Portals created by this spell are magical and temporary, so they can be dispelled. Portals that occur naturally in the crystal shell may not be dispelled.

The material component of the *create portal* spell is a piece of wire wrapped about a bit of amber.

Enhance Maneuverability

(Alteration)

Reversible

Range: 10 yards

Components: V, S, M

Duration: 1-4 rounds plus
caster's level

Casting time: 5

Area of Effect: 1 ship of up to 10
times the caster's
level in tonnage

Saving Throw: None or Neg.

This spell may be cast on any ship to either increase or decrease its maneuverability class (MC). A ship MC may only be increased or decreased by one class using this spell. No ship can have its MC increased or decreased more than one class above its initial MC, regardless of the number of *increase maneuverability* or *decrease maneuverability* spells cast upon it.

The material component for this spell is a vial of wind from an air-based world.

Sixth-Level Spells**Create Minor Helm**

(Enchantment/Charm)

Range: 10 yards

Components: V, S, M

Duration: 1 week/level

Casting Time: 1 turn/level of caster

Area of Effect: 1 item

Saving Throw: None

By casting this spell, the wizard may transform a normal chair or seat into a minor spelljammer helm suitable for powering a ship through space. This spell does not replace the need for a permanent magical helm onboard, and is used primarily as a back-up system or in emergency situations.

The minor helm may power a ship of no more than two times the caster's level in tonnage. A 20th-level wizard may therefore create a helm capable of powering a 40-ton ship. In opera-

tion, a minor helm created in such a fashion is identical to a regular, permanent spelljammer helm, with one exception. If a helm created by this spell is successfully dispelled, it will disappear and must be created anew.

The material component for this spell is a chair, stool, or other seat suitable for use as a helm.

Seventh-Level Spells**Create Major Helm**

(Enchantment/Charm)

Range: 10 yards

Components: V, S, M

Duration: 1 day/level of caster

Casting Time: 1 turn/level of caster

Area of Effect: 1 item

Saving Throw: None

By casting this spell, the wizard may transform a normal chair or seat into a major spelljamming helm suitable for powering a ship through space. This spell does not replace the need for a permanent magical helm onboard, and is used primarily as a back-up system or in emergency situations.

The major helm may power a ship of no more than three times the spellcaster's level in tonnage. A 20th-level wizard may therefore create a major helm capable of powering a 60-ton ship. In operation, a major spelljamming helm created in such a fashion is identical to a regular, permanent helm, with one exception. If dispelled, the helm created by this spell will disappear for a single round, then reappear.

Creating a helm—major or minor—counts as the casting of one spell, and therefore reduces the caster's effectiveness in using the helm for that day. Of course, this does not mean another spellcaster cannot act as the helmsman, using a helm created by another person.

The material component for this spell is a chair, stool, or other seat

suitable for use as a helm.

Priest Spells**First-Level Spells****Create Air**

(Alteration)

Reversible

Sphere: Elemental (Air)

Range: 30 yards

Components: V, S, M

Duration: Permanent

Casting time: 2 rounds

Area of Effect: 1 person per
two levels

Saving Throw: None

By means of this spell a priest may generate a bubble of fresh, breathable air around a person. This air will drive out the stale air around a person and restore it to the "fresh" state. In cases of individuals adrift in space, this permits another rolling of the die to determine duration of the fresh air.

Within a larger envelope of air (such as the deck of a ship or the atmosphere of a planet), the freshened air will drift off, combining with the existing air.

The spell can replace air that may be stale or befouled, including air that is poisoned or tainted by a *cloudkill* or *stinking cloud* spell.

For every two levels over first, the priest may create sufficient air for an additional person. At 3rd level he may create air for two human-sized individuals, at 5th level sufficient air for five, and so on.

Creating additional air around a single individual does not create a larger envelope; the excess air will simply drift off. The caster can refresh the air within his own personal air envelope and that of others within the range of the spell, without needing to touch those individuals.

The reverse of this spell, *destroy air*, immediately reduces the air around one target to "fouled," with



early in the exploration of the various spheres, and there are worshipers of all races throughout the known universe. For most groundling clerics, however, only those from a background which respects the Path and/or the Way may benefit from the pan-spherical power of the faith.

PTAH: This Egyptian god is one of the few Powers to dwell in the ethereal plane, and as a result of this, plus his background (he is venerated as a "creator" of the universe, an opener of doors, a god of travelers and of inventors), he is known in practically every major sphere in the universe. His faith exists only in space, and on those worlds where the Egyptian mythos is fully recognized. On planets where this is not the case, his clerics are as limited as those of other faiths are in wildspace or in strange new spheres.



all effects of that change. See Chapter 1 for more on this topic.

If the *create air* spell is used within a gravity field, inside otherwise hostile surroundings (such as inside a *cloudkill* or *stinking cloud*), it will allow the recipient a single clean breath before the created air bubbles to the surface.

The material component for the spell is a small, stoppered flask.

Second-Level Spells

Contact Home Power (Conjuration/Summoning)

Sphere: All
Range: Unlimited
Components: V, S, M
Duration: 1 week
Casting Time: 1 turn
Area of Effect: The caster
Saving Throw: None

The user of this spell establishes a tenuous link through the Astral Plane between his present location and that of the power he venerates. This link permits the priest to regain his spells as if the god is recognized and venerated within the sphere.

Distance has no effect upon the priest's attempt to contact the home power, but dimensional *gates*, antimagical fields, and the effects of *dispel magic* will prevent the use of the spell. Also, the spell will not function in areas that the power has been specifically banished from (whether from death of an avatar, banishment, or some voluntary action of the god).

The cleric attempting to uplink with his power in such locations will be informed through the spell that such contact with his god is forbidden. The priest will not be given the reasons, however, as gods are noticeably reticent to explain why they cannot exert their power, preferring instead to look all-powerful to their worshipers.

The duration of the spell is one

week, as long as the cleric remains in the same crystal sphere in which he cast the spell. Passage into another plane (even the ethereal) will break the spell, as will a *dispel magic* (if the correct die roll is made). While the spell is in effect, the cleric will respond positively to a *detect magic* when he or she is receiving new spells. This spell cannot be cast in the phlogiston.

The material component of this spell is a small horn. When winded, the horn calls the attention of the deity to its servant. Of course, it also attracts the attention of others within earshot.

Detect Powers (Divination)

Sphere: Divination
Range: 240 yards
Components: V, S, M
Duration: 1 turn
Casting Time: 1 round
Area of Effect: 1 crystal shell
Saving Throw: None

Casting this spell outside a crystal shell allows the cleric to determine if there are friendly gods and/or other powers so that he may recharge his higher-level spells within its borders. The *detect powers* spell will also reveal if the gods revered by the cleric are worshiped within that sphere.

If the sphere is one known to the DM, or one which has its major powers already designed, then the spell will reveal if the priest's deity, or deities related to the one involved (either members of the same pantheon or with similar attributes and portfolio) exist. Two different war gods from two separate fantasy campaigns are probably sufficiently similar to justify a "related" status. However, a god of smithing may have no parallel in a world without developed metalcraft. In that situation, a cleric devoted to the smithing god would not find a power to recharge his spells.



If the sphere is new to the DM (ie, the characters just discovered it), and he has no clear idea what lies within, then roll on the table below for a possible response to the spell.

Die Roll Response

- 01-10 Power is known in this sphere. The cleric can recharge spells normally.
- 11-50 Power is unknown in sphere, but a related power exists. The cleric may regain spells normally after contacting clerics of the related deity.
- 51-90 Power is unknown in sphere. The cleric may not regain spells above second level until contact is restored with venerated power.
- 91-00 Power is unknown in

sphere. There is a related power, but his relationship is not good with the cleric's power (whether through lack of knowledge, some ancient insult—imagined or real—or some other mysterious reason). The cleric may not regain spells above second level until either contact is restored with his original power, or the cleric performs a great task for the new power.

While many powers will have similar portfolios and areas of interest (war, healing, agriculture, death, and so on), they are often at varying alignments. In one fantasy world, a war god might be a positive figure, and therefore good and lawful. On another world, war might be regarded as a destructive force, and its

deity is evil and chaotic.

A cleric will be able to tell the alignment of the power closest to his deity through the *detect powers* spell. Accepting spells from a power of similar outlook but opposite alignment is dangerous, and any cleric that does so must regain favor with his chief deity (through quest or atonement) before further advancement in his class is possible.

There are a number of specialty faiths that exist only in space fantasy campaigns, including the Polygots, the Path & the Way, Ptah, and the Planar Churches. If there exists a space civilization of any sort in the crystal sphere, then these faiths will be represented somewhere in that system.

The material component of this spell is a handful of sand, which the priest casts onto the crystal shell.



PLANAR CHURCHES:
A fractious merging of both the Path and the Polygots, the planar priests respect and venerate *all* the powers of a particular inner or outer plane. A planar priest venerates the Seven Heavens and *all* the Powers who dwell within, regardless of portfolio, position, or attributes. A planar priest of Arvandor/Olympus would venerate both the Greek and elvish mythoi which live in that plane.

Characters which are generated particularly for a space fantasy campaign may choose to be any of these multibranch faiths, or to be of a "groundling" sect recognized in the sphere where the campaign begins. Characters from various campaign worlds may join the various multi-sphere sects *only* with the permission of their first deity. A *commune* spell is in order at the very least, likely



Fourth-Level Spells

Softwood (Alteration)

Sphere: Plant
Range: Touch
Components: V, S, M
Duration: Permanent—see below
Casting Time: 1 round
Area of Effect: 1 man-sized target
per 3 levels
Saving Throw: Neg.

The recipient of a *softwood* spell immediately has his body surrounded by soft, spongy wood, similar to that of a rotting stump. The soft wood is a living entity that inhabits the air envelope of the individual, sustaining that individual's life at a lower level than normal. The character is placed in suspended animation in a manner similar to that of individuals lost in the Flow.

The softwood surrounding a body is extremely resistant to heat and cold, and while the form within is unconscious, it cannot be harmed. A character in a softwood cocoon could fall to earth and the heat and impact of the fall would be absorbed by the spell.

Softwood dissolves in open air. If a character enters and stays in a new envelope of fresh air for longer than three turns, the softwood will dissolve, letting the individual loose. A softwood spell cast in the open air will be effective for three turns, cocooning the target for 30 minutes, then dissipating in a single round.

The *softwood* spell was created as a defensive measure, to preserve those cast adrift in space. For each three levels of experience, a priest can effect an additional individual. Enterprising and aggressive priests have turned the spell into both a handy method of containing enemies, as well as a way of sending both foes and mutinous friends into wildspace (and off their ships) without having to slay them.

The material component is any bit of bark. The softwood will become that type of bark covering the body. (If maple is used, then the covering will appear as maple, if pine, it will appear as pine.) If the bark of a sentient or "monster"-type plant is used, the softwood will be of similar physical features, but will lack any special abilities of the original plant.

Fifth-Level Spells

Create Minor Helm (Enchantment/Charm)

Sphere: Creation
Range: 10 yards
Components: V, S, M or V, S
Duration: 1 week/level or 1 day/level
Casting Time: 1 turn/level of caster
Area of Effect: 1 item
Saving Throw: None

By casting this spell, the priest may transform a normal chair or seat into a minor spelljammer helm suitable for powering a ship through space. This spell does not replace the need for a permanent magical helm onboard, and is used primarily as a back-up system or in emergency situations.

The minor helm may power a ship of no more than two times the caster's level in tonnage. A 20th-level priest may therefore create a helm capable of powering a 40-ton ship. In operation, a minor helm created in such a fashion is identical to a regular, permanent spelljammer helm, with one exception. If a helm created by this spell is successfully dispelled, it will disappear and must be created anew.

The material component for this spell is a chair, stool, or other seat suitable for use as a helm. A *create minor helm* spell may be used without a suitable material component, but in such cases, the spell lasts for a matter of days as opposed to weeks.

The ships of wildspace must fulfill a variety of needs. They must be able to retain enough atmosphere within their envelope to support a crew and passengers, and be able to handle both the vacuum of wildspace and the glittering rainbow ocean of the Flow. In some cases, they must be able to land on the surface of a large planet and later be able to leave the planet.

The primary restriction in ship design for all races is to make the ship large enough to support its crew, but not so large that it cannot be moved by a spelljamming mage or priest. This double restriction sets the top and bottom limits for normal ship design.

Note that the *Spelljammer* is a unique craft whose very existence breaks some of these limitations—it is incredibly large, but it can still move itself normally. It is described following this section.

Spelljammer Architecture

Ships in space have a number of attributes and statistics that describe their performance and capabilities. Below is a short overview of common terms.

A ship's size is defined in **tonnage** (T)—literally the amount of displacement the ship takes up. Since this displacement also influences the amount of breathable air surrounding the ship in space, a ship's tonnage is also a reflection of both its crew capacity and requirements. One ton is not a measure of weight; instead, it is arbitrarily set to equal 100 cubic yards. A mass that large will allow a single man to breathe comfortably for 4 to 8 months.

A **ship's rating** (SR) is a reflection of the ship's speed and relative power, and to a lesser extent its maneuverability. A ship with a high SR can move faster in a single round

than one with a low SR. The ship's rating is dependent on the level of the individual piloting the ship (called the spelljamming mage or priest) and on the power of the ship's helm or other spelljamming device. In general, a ship with a high-level wizard or priest at the helm will have a higher SR than a similar ship with a low-level helmsman.

Each ship has two **crew numbers**. The first is the number of individuals needed to run the ship under normal circumstances. The second is the number of individuals that the ship can carry without dangerously overloading its atmospheric envelope. For example, a ship with a crew rating of 10/35 requires 10 men to run the ship properly but it can carry up to 35 without endangering its atmosphere.

When talking about maximum crew numbers and the air requirements of various races, man-sized races are assumed. Tiny and small individuals require only half as much air, while large and huge creatures need twice as much. Gargantuan creatures need five times the normal

amount (though these creatures are large enough to maintain their own gravity plane and atmospheric envelope).

Maneuverability class (MC) refers to the tactical maneuverability of the craft. This is a factor of sails, oars, fins, and other controlling devices over and above those provided by the ship's rating. In general, the hull design of a ship determines its MC, with the quickest being the graceful ships of the elves and the most sluggish being sea vessels that have been converted into spacecraft. A ship can be powered by a low-level mage and therefore have a low ship's rating, but a high maneuverability class can still allow it to function well in tactical combat.

Spaceship maneuverability classes are similar to those of flying creatures, because their behavior once in an atmosphere is similar. They are rated A to F, with A being the most maneuverable. An F rating for a ship indicates that it is below minimum maneuverable standards. Such ships are usually converted sea craft modified for space travel and are out-

ITEM SAVING THROWS

Item	Acid	Crushing Blow ¹	Disin.	Fall	Magical Fire	Normal Fire ³	Cold	Light	Elec.
Bone	11	16	19	6	9	3	2	8	2
Cloth	12	—	19	—	16	13	2	18	2
Glass	5	20	19	14	7	4	6	17	2
Leather	10	3	19	2	6	4	3	13	2
Metal ²	13	7	17	3	6	2	2	12	2
Ceramics	4	18	19	11	3	2	4	2	2
Crystal	3	17	18	8	3	2	2	14	2
Stone	3	17	18	8	3	2	2	14	2
Rope	12	2	19	—	10	6	2	9	2
Wood, thick	8	10	19	—	7	5	2	12	2
Wood, thin	9	13	19	2	11	9	2	10	2

¹ Crushing blow includes all crashes.

² Metal includes *glassteel* spells.

³ Normal fire includes greek fire.



coupled with a major quest, and an atonement when that cleric returns to his home world. *Oriental Adventures* characters who already follow either the Path or the Way (such as sohei and kinsai) suffer no effects on their abilities in space, since their religion has preceded them into a number of different spheres and thrived.

All "space clerics" have spells as for standard priests—they cannot become special mythos priests while following these various pan-deity groups. A specialty cleric who goes into space retains the benefits of his faith, but cannot join a pan-deity organization.



classed by all craft built especially for space.

Hull points (HP) are a method of assessing damage to a ship, as well as damage inflicted by individuals in space combat. Initially a ship has hull points equal to its tonnage (a 30-ton ship has 30 hull points). Some ships are fortified and armored, sacrificing maneuverability and crew for protection.

Hull points are similar to hit points for a character. In addition to hull points, there are many attacks that force the ship to make a saving throw (such as a *disintegrate* spell cast on the bow) which will cause the ship to save or be damaged or destroyed. In general, use the Item Saving Throw chart (below or on page 39 of the *DMG*) for determining effects. Most ships are "Thick Wood" for general saves, but there are also stone and metal ships in use, along with reports of ceramic, leather, bone, and even ships of glass strengthened by the *glassteel* spell. A ship that has lost half its hull points has many rents and holes in it, while one that has lost all its hull points has been destroyed.

Most ship exteriors are considered to be thick wood, though there are other types in use by various races. These are noted in their descriptions.

Power type defines the type of helm, engine, or other motive force that causes the ship to go through space. Most helms gather and concentrate magical or other mystical energy and convert it into motive force. In other words, the ships run on magic. Different power types have different limitations and capabilities. A ship with no power is adrift, unable to control its motion. A ship can have multiple power sources. The one "on-line" is the primary power source, while the others (including any spells) are back-ups. The common power types (discussed in more detail under Power Sources) are:

- Major Helms
- Minor Helms
- Serial Helms
- Pool Helms
- Forges
- Furnaces
- Artifurnaces
- Lifjammers

Armament varies from ship to ship. In a typical ship description, the standard armament (SA) is provided. Additional armament may be provided, though this cuts down on cargo space (the room that would normally be used for cargo is instead used to provide space for large weapons and their ammunition). The initial armament number reflects the number of armaments that can be built directly into the ship—further additions can be made with each weapon eating up one ton of cargo space. Additional armament cannot exceed half the ship's total tonnage. This limitation allows some room for the crew's needs and provides enough breathable air for long voyages.

Armament falls into a number of categories, along the lines of the siege machinery it developed from:

- Catapult: blunt stone thrower;
- Ballista: extremely large crossbow;
- Ram: punches holes in ships;
- Bombard: very rare, expensive, and dangerous to use;
- Jettison: scatters debris;
- Greek Fire Projector: shoots liquid flame.

Further information on each of these weapons is given under the individual entries.

Cargo space is the amount of stuff the ship can contain. Each ton of a ship's size reflects 50 cubic yards of space that may be used for carrying (nonliving or nonbreathing) cargo. A 30-ton frigate will carry 15 tons of cargo. The remaining interior space is needed for crew, armament, and other necessities. For each large

weapon added to a ship over and above its standard ordnance, one ton is subtracted from the total amount available for cargo (the weapons and their ammunition occupy that space).

Keel length (KL) is the long dimension of the ship, usually but not always measured along the ship's keel. This is the long dimension of the gravity plane.

Beam length (BL) is the width of the ship, measured at the ship's widest point but not counting any oars, poles, or sails that may widen the ship without effectively contributing to its real tonnage.

Armor rating (AR) for a ship is similar to the Armor Class of a character. Armor reflects the difficulty that an attacker has in causing significant damage to the ship because of its construction or maneuverability. In general, small, light ships have poor ARs while large, heavier-built ships have excellent ARs, trading maneuverability for protection.

Outfitting

Most ships of space were captured, refitted, or inherited by their present owners. Large communities in space tend to build their own distinctive ships, which in turn are copied, stolen, or bought by others in space, accounting for both the wide variety found throughout the space lanes as well as the existence of a good group of "typical" ships.

The following section discusses the various types of hulls, power sources, armaments, and other magical and nonmagical equipment that may be helpful in space. Prices are given, but the general rule is "what the market will bear" (which often translates into "how much have you got?").

All ships and ship equipment are rare in space; there are a few "used spaceship shops" in the known

spheres, but they are few and far between, and seldom do they have more than one or two ships available. Often initial adventurers hire on for some trading cartel or as emissaries for some powerful wizard or enterprising faith, and take the ship in trade of some heroic deeds. Such ships are usually bottom of the line, little more than tubs, but can be converted into suitable adventuring vehicles with sufficient time and gold.

In general, there is a 10 percent chance that an item listed here is available at any large space civilization. There is an additional 20 percent chance that there is a rumor that the needed item can be found somewhere else in the system (either as treasure or part of a hulk or belonging to someone else). This 20 percent chance increases by 5 percent for every week spent in one location, so that an individual looking for a major helm on Cooper's Rock has a 30 percent chance of coming up with a lead on it in three weeks' time. The nature and details of such items are left to the DM (DM—check out the *Lorebook of the Void* for ideas on what to include in such scavenger hunts).

Ship Hulls

There is a wide variety of ship hulls, ranging from converted ocean-going ships to the spaceborne beholder tyrant ships to the organically grown ships of the elves.

The types listed here are the most common ships in use. There are others, including those that DMs themselves come up with. Also listed here are the various groundling ships that are sometimes converted and taken into space. They are normally used by first-time adventurers, as their poor armor ratings and hard handling (low MCs) make them undesirable to more experienced voyagers. Note that there is a difference between "tons" when describing the





Castaways in the Flow

When dealing in terms of space, there is always the chance that an individual or ship will find itself adrift without a way back to civilized space. In wildspace, an individual is likely up the creek without sufficient atmosphere. Roll for normal encounters until the air runs out. Items such as a beacon will affect how much and what type of attention is drawn.

In phlogiston, the preserving nature of the flow is such that an individual lost in space may return—weeks, months, and/or years down the road. Roll a ten-sided die; that is the number of standard weeks that will elapse before someone discovers the preserved character. On a "10", roll another 1d10, and add that. If that roll is a 10, add it to the total, and continue, until a final sum total is reached. A character can literally



displacement of an ocean-going ship and tonnage in SPELLJAMMER™ game terms, where a spacial ton equals 100 cubic yards of atmosphere.

Costs of ships are given on the gold piece standard found throughout most of space. Some regions use other means of counting money, but these can be converted to the gold standard (for example, Krynn bases its monetary system on steel, not gold, and a character looking for supplies in Ansalon will have to negotiate in steel pieces at their listed conversion rate).

Listings for crew and standard armament (SA) indicate the capability to support these men and weapons. They are not included in the purchase price of the hull.

Crew listings are also less than those listed in the *Player's Handbook* and other sources. This is because the spelljamming helm frees up a lot of manpower otherwise needed (such as sailors and rowers). If a converted groundling ship is returned to earth, it will need its full crew to function normally.

The landing entry indicates whether the ship can stand up to a landing on water or on the ground. Several ships never land, and their crews reach the ground by shuttles, magic, or other methods.

Caravel

Cost: 10,000 gp
 T: 10 tons
 Crew: 8/10
 MC: F
 AR: 9
 HP: 10
 Saving Throw: Thick wood
 KL: 70 feet
 BL: 20 feet
 SA: 1 large weapon
 Ram: none
 Landing:
 Land—No
 Water—Yes

A groundling ship of late medieval design. A versatile cargo carrier.

Coaster

Cost: 5,000 gp
 T: 10 tons
 Crew: 8/10
 MC: F
 AR: 9
 HP: 10
 Saving Throw: Thick wood
 KL: 60 feet
 BL: 20 feet
 SA: 1 large weapon
 Ram: none
 Landing:
 Land—No
 Water—Yes

A groundling coastal trader. Its SR is always reduced by 1 because of its clumsy handling.

Cog

Cost: 10,000 gp
 T: 20 tons
 Crew: 10/20
 MC: F
 AR: 9
 HP: 20
 Saving Throw: Thick wood
 KL: 90 feet
 BL: 20 feet
 SA: none
 Ram: none
 Landing:
 Land—No
 Water—Yes

A groundling ocean trader, popular with merchants.



Drakkar

Cost: 25,000 gp
 T: 10 tons
 Crew: 20/10
 MC: F
 AR: 7
 HP: 10
 Saving Throw: Thick wood
 KL: 100 feet
 BL: 20 feet
 SA: 1 large weapon
 Ram: none
 Landing:
 Land—No
 Water—Yes

A large longship used by viking peoples. It requires more people to operate it than its tonnage can comfortably support, and therefore is not a good ship for long voyages (but is good for raiding the moon).

Dromond

Cost: 15,000 gp
 T: 16 tons
 Crew: 10/16
 MC: E
 AR: 9
 HP: 16
 Saving Throw: Thin wood
 KL: 175 feet
 BL: 15 feet
 SA: 3 large weapons
 Ram: piercing
 Landing:
 Land—No
 Water—Yes

A Byzantine ship—its cost and size make it a relatively good choice for initial star voyagers, but its fragile nature leaves much to be desired.

Galleon

Cost: 50,000 gp
 T: 40 tons
 Crew: 20/40
 MC: E
 AR: 7
 HP: 40
 Saving Throw: Thick wood
 KL: 130 feet
 BL: 30 feet
 SA: 3 large weapons
 Ram: optional
 Landing:
 Land—No
 Water—Yes

One of the most advanced sailing vessels of its era, found only on a handful of worlds. Best of the groundling vessels for the leap into space, and those earthbound nations that recognize space traveling tend to use such ships.

Great Galley

Cost: 30,000 gp
 T: 20 tons
 Crew: 15/20
 MC: F
 AR: 7
 HP: 20
 Saving Throw: Thick wood
 KL: 130 feet
 BL: 20 feet
 SA: 3 large weapons
 Ram: piercing
 Landing:
 Land—No
 Water—Yes

A groundling ship powered by slave or freeman rowers. Often experimental wizards take an entire galley team into space in initial experiments. This leads to no later experiments, since the crew quickly exhausts the air and dies.

Longship

Cost: 10,000 gp
 T: 4 tons
 Crew: 4/4
 MC: E
 AR: 8
 HP: 4
 Saving Throw: Thin wood
 KL: 75 feet
 BL: 15 feet
 SA: 1 large weapon
 Ram: optional
 Landing:
 Land—No
 Water—Yes

An ideal carrier for small numbers of adventurers in space, but as with the galleys, taking full crew beyond the atmosphere of the planet will result in the air quickly becoming fouled and the voyage ending.

Mind Flayer Nautiloid

Cost: 40,000 gp
 T: 35 tons
 Crew: 10/35
 MC: D
 AR: 4
 HP: 35
 Saving Throw: Thick wood
 KL: 180 feet (including ram)
 BL: 30 feet
 SA: 5 large weapons
 Ram: piercing
 Landing:
 Land—No
 Water—Yes

Embodiment of several illithid ideals, including staying out of the sun and striking hard and fast from armored safety. Found throughout the Known Spheres of wildspace, though there are many spacefaring nations that will attack a mind flayer ship on sight and worry about details (like who really owns it) later.



be "on ice" for years or decades, given a nasty situation and bad luck, but most will float back into circulation after a few standard months.

The nature of the rescue is up to the DM, but for those looking for a quick response, use the following table. The DM may modify the table or create his own as he sees fit for his section of space.

- D10 Rescuers
- 1 Neogi-Slaver
- 2 Mind Flayer Trader
- 3-4 Normal Merchantman
- 5-6 Pirate Ship
- 7-8 Elvish Military Ship
- 9 Dwarvish Ship
- 10 Scavengers

Most of the ships of space follow a "Code of the Deep," where lost bodies are recovered and returned to life unless obviously hostile to the individuals involved. The neogi will definitely bind the character and sell him or her into slavery at the next stop, as will 50% of



Squid Ship

Cost: 45,000 gp
 T: 45 tons
 Crew: 12/45
 MC: D
 AR: 5
 HP: 45
 Saving Throw: Thick wood
 KL: 250 feet (including ram)
 BL: 25 feet
 SA: 3 large weapons
 Ram: piercing or grappling
 Landing:

Land—No
 Water—Yes

A common ship among pirates, traders, and other spacefarers. Its effective length is increased by the 50-foot-long triple spears at the front.

Hammership

Cost: 50,000 gp
 T: 60 tons
 Crew: 24/60
 MC: D
 AR: 6
 HP: 60
 Saving Throw: Thick wood
 KL: 250 feet
 BL: 25 feet
 SA: 3 large weapons
 Ram: blunt
 Landing:

Land—No
 Water—Yes

Another common spacefaring ship used both by traders and those who prey on them. Uses a blunt ram at the front, so that its ram is included in total keel length of the ship.

Dragonfly

Cost: 40,000 gp
 T: 10 tons
 Crew: 3/10
 MC: C
 AR: 8
 HP: 10
 Saving Throw: Thin wood
 KL: 100 feet
 BL: 20 feet
 SA: 1 large weapon
 Ram: none
 Landing:

Land—Yes
 Water—No

An excellent ship for small groups and for planetary exploration, the dragonfly is capable of touching down on most planets.

Damselfly

Cost: 50,000 gp
 T: 10 tons
 Crew: 2/10
 MC: D
 AR: 4
 HP: 10
 Saving Throw: Metal
 KL: 100 feet
 BL: 20 feet
 SA: 1 large weapon
 Ram: none
 Landing:

Land—Yes
 Water—No

A version of the dragonfly hull so heavily modified as to qualify as its own separate hull type. The damselfly hull uses metal plates (and in some cases, ceramics, shells, or bones) to cover all external decks to create a battle-ready scout ship.

Mosquito

Cost: 15,000 gp
 T: 6 tons
 Crew: 1/6
 MC: C
 AR: 5
 HP: 6
 Saving Throw: Thin wood
 KL: 100 feet
 BL: 15 feet
 SA: none
 Ram: none
 Landing:
 Land—Yes
 Water—Yes

Smaller than the dragonfly, and less expensive, this ship is not as good for long voyages, but is often employed as a scout ship in civilized space.

Wasp

Cost: 20,000 gp
 T: 18 tons
 Crew: 8/18
 MC: D
 AR: 6
 HP: 18
 Saving Throw: Thick wood
 KL: 80 feet
 BL: 20 feet
 SA: 1 large weapon
 Ram: none
 Landing:
 Land—Yes
 Water—No

Designed along the lines of the dragonfly by the lizardmen tribes of space, this ship responds to the needs of that race with its pitched decks and wide passages. The ship has found common use among other races as well.

Neogi Deathspider

Cost: 75,000 gp
 T: 100 tons
 Crew: 30/100
 MC: E
 AR: 5
 HP: 100
 Saving Throw: Crystal
 KL: 175 feet (not including arms)
 BL: 50 feet
 SA: 6 large weapons
 Ram: grappling
 Landing:
 Land—No
 Water—No

One of the largest ships in Known Space, the deathspiders are feared and hated wherever they appear. One can likely be had for the listed price, but the individuals buying it will be attacked on sight. The deathspider uses a grappling ram that allows it to trap its prey. It requires a major helm to operate. Not recommended for new adventurers.

Dwarven Citadel

Cost: 100,000 gp
 T: 300 tons
 Crew: 100/300
 MC: E
 AR: 0
 HP: 300
 Saving Throw: Stone
 KL: 250 feet (from prow to forge)
 BL: 200 feet
 SA: 10 large weapons
 Ram: blunt
 Landing:
 Land—Yes
 Water—No

Dwarven ships are carved-out asteroids and flying mountains. Many are found adrift in space, abandoned by their people, and used as bases by other fell races. Like the deathspiders, citadels are too large to be moved by normal spelljamming means. The dwarves use a device known as the *Forge* (see Power Types, below) for motive power.

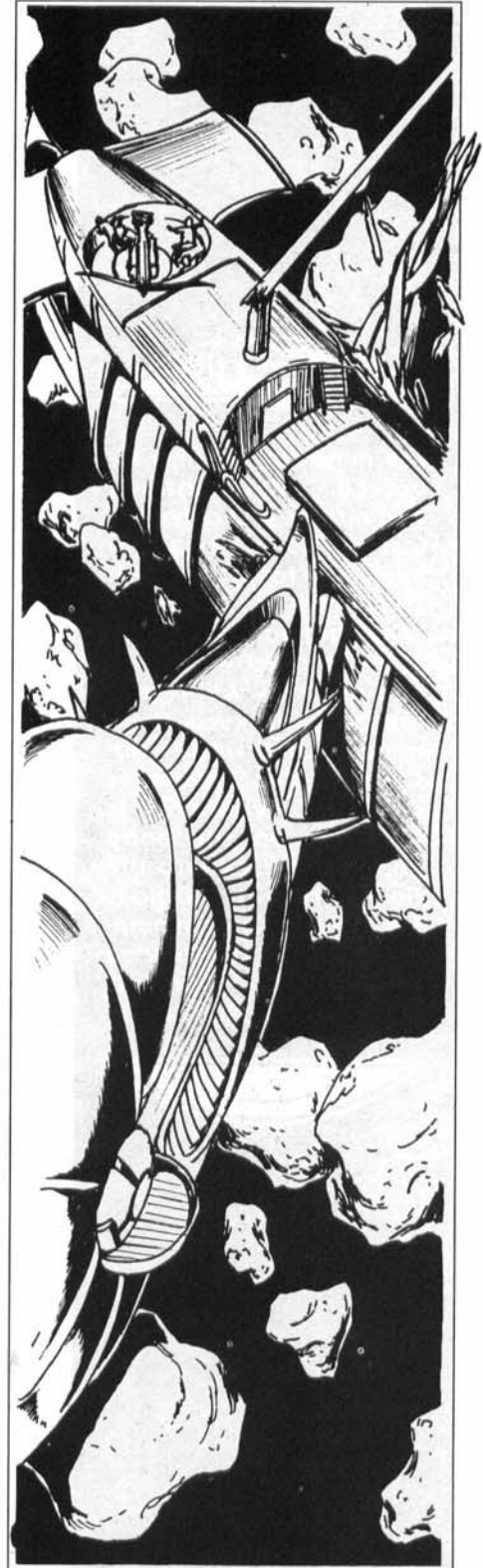



the mind flayer ships involved. Merchantmen and pirates will offer the lost individual passage in exchange for work, with the pirates tossing those unwilling to serve back into the deep. The elves and dwarves will rescue humans but keep them under watch until land-fall is made. Scavengers will loot whatever is available on the body and toss it back into the flow, where it will float for another random number of weeks, determined by the "1d10+" process described on page 28.



Beholder Tyrant Ship

Cost: 100,000 gp
 T: 23 tons
 Crew: 15/23
 MC: C
 AR: 0
 HP: 23
 Saving Throw: Stone
 KL: 100 feet (front to back)
 BL: 100 feet (radius)
 SA: none
 Ram: none
 Landing:
 Land—No
 Water—No

Beholder tyrant ships are only used by the various beholder races, and serve as home for up to 40 such creatures at a time. They are shaped like walnuts and have their own form of spelljamming power, using the beholders within. While an individual may be a guest (or prisoner) on a tyrant ship, it is unlikely anyone other than a beholder would want such a hull.

Oriental Dragonship

Cost: 60,000 gp
 T: 45 tons
 Crew: 20/45
 MC: D
 AR: 5
 HP: 45
 Saving Throw: Thick wood
 KL: 150 feet
 BL: 20 feet
 SA: 3 large weapons
 Ram: optional
 Landing:
 Land—No
 Water—Yes

A common ship among individuals from Kara-Tur and other oriental lands. A cross between a dhow and a dragon, it is used by ground-based nations of that region that seek to go into space.

Elven Man-o-War

Cost: 100,000 gp
 T: 60 tons
 Crew: 10/60
 MC: C
 AR: 7
 HP: 60
 Saving Throw: Ceramic
 KL: 200 feet
 BL: 20 feet
 SA: 4 large weapons
 Ram: none
 Landing:
 Land—No
 Water—No

The oddly curved, graceful ships of the elves are grown and twisted into their shapes, much like bonsai trees. As a result, their plane of gravity is not linear; each ship is a large, delicately fluted vessel with a lot of potential firepower. The crystalline wings of the elven ship reach 300 feet from tip to tip, brushing the edge of its own atmospheric envelope.

Elven Flitter

Cost: 10,000 gp
 T: 1 ton
 Crew: 1
 MC: B
 AR: 8
 HP: 1
 Saving Throw: Ceramic
 KL: 20 feet
 BL: 5 feet
 SA: none
 Ram: none
 Landing:
 Land—Yes
 Water—Yes

At the opposite end of the scale for elven ships, the 1-ton flitter is among the smallest of the ships of wildspace. Though it can be equipped with a spelljammer helm, these ships are more often carried on larger ships and let loose when the large elvish ship enters the atmospheric envelope of another ship. The flitters then glide and board the other ship.

Tradesman (fish ship)

Cost: 15,000 gp
 T: 25 tons
 Crew: 10/25
 MC: D
 AR: 5
 HP: 25
 Saving Throw: Thick wood
 KL: 120 feet
 BL: 30 feet
 SA: 2 large weapons
 Ram: none
 Landing:
 Land—No
 Water—No

The workhorse of space, this ship is found in every sphere that has a healthy trading and raiding society.

Gnomish Sidewheeler

Cost: 40,000 gp
 T: 30 tons
 Crew: 20/30 (double that in gnomes)
 MC: E
 AR: 7
 HP: 30
 Saving Throw: Metal
 KL: 120 feet
 BL: 25 feet
 SA: none
 Ram: none
 Landing:
 Land—50 % likely
 Water—50 % likely

Also known as "the ship of the desperate," the gnomish sidewheeler represents the pinnacle of gnomish technology. Most intelligent creatures avoid these vessels like the plague. They operate with all manner of gizmos and devices. Price does not include gnomes needed to run things, or the giant hamsters that power the side wheels and wind the giant rubber band.

Power Sources

The chief method of moving through space is through *spelljamming*—converting magical energy into motive force. This section deals with the required equipment: spelljamming helms.

Spelljamming helms are the easiest way to get a ship moving, but not the only one. The dwarves use their forges to propel their great stone citadels, while the beholders use a mutated version of their own species, called an orbis, to provide the power. The mind flayers, who have spell-like ability but do not cast true spells, use series helms to maintain their power. All of these are described below.

Most helms and other magical "engines" have a limitation of how large or how small a mass they can move. This, in turn, sets the limit on the size of most space vessels. There are large citadels carved out of asteroids, but these are not mobile in the same sense as a hammership. They only drift, with occasional (and expensive) midcourse corrections. The *Spelljammer* itself is also an exception, and will be dealt with separately (see the display map, included).

Helms can be acquired through a number of means, the most usual being discovery in old ruins or raiding an enemy ship for its helm. They may be researched and built by high-level wizards at great expense in both gold and time. Or they may be purchased from the Arcane, a group of humanoid traders who do business in helms and other magical equipment.

No one knows the Arcane's home world, nor have ships of the Arcane ever been spotted. They seem to exist to sell. The prices listed in this book reflect the purchase price from the Arcane. The chance of an Arcane being found in a large space civilization are about those for finding any other piece of necessary equipment.





Celestial Body Classification

Celestial bodies are divided into various types and classifications for easy reference by celestial engineers and cartographers. When referring to a celestial body or bodies, a three-character code is used. First is a definition of size, second a symbol indicating shape, and lastly a word describing the type of celestial body being dealt with.

SIZE CLASSES:

- Size A Less than 10 miles across
- Size B From 10-100 miles across
- Size C From 100-1K (1000) miles across
- Size D From 1-4K across
- Size E From 4K-10K across
- Size F From 10K-40K across
- Size G From 40K-100K across
- Size H From 100K-100K (1M) across
- Size I From 1M-10M across
- Size J 10M across or greater

Earth, and most earth-like fantasy campaigns, are Size E.



Spelljammer Helms

Cost:

- 100,000 gp (minor helm)
- 250,000 gp (major helm)

Each minor and major spelljammer helm allows the individual seated upon it to move a large mass through space by means of channeling spell energy directly into a motive force. This energy is somewhat useful for maneuvering the ship, but primarily it provides the push that makes the ship move forward (or backward). Maneuvering comes primarily from the ship's sails and oars.

The power of the force is known as the ship's rating. A minor helm converts such energy at a rate of 1 point of SR for each three levels of experience. A major helm converts at a rate of 1 SR for every two levels of experience.

At low levels, the difference between using a minor and major helm is small. A third-level mage will give his ship an SR of 1, regardless of whether a minor or major helm is used. The higher level the mage, however, the more important the difference between using major and minor helms. A tenth-level wizard, for example, can give his ship an SR of 5 with a major helm, but only an SR of 3 with a minor helm. A quick summary of levels is included below.

SHIP'S RATINGS USING MAJOR AND MINOR HELMS

Level of Wizard or Priest	Major Helm	Minor Helm
1	1	1
2	1	1
3	1	1
4	2	1
5	2	1
6	3	2
7	3	2
8	4	2
9	4	3
10	5	3
11	5	3
12	6	4
13	6	4
14	7	4
15	7	5
16	8	5
17	8	5
18	9	6
19	9	6
20	10	6

Using a helm prohibits any spell use by that character within that 24-hour period. As soon as a wizard or priest sits on the helm and becomes aware of the ship, he can cast no spells of any sort until after he has had a chance to rest and regain spells. In effect, the helm "drains" the helmsman of all his spells the moment it is activated.

(In fact, this is not precisely what happens. The helm attunes itself to the brain patterns of the character who activated it. Once in synch, the helm siphons away any magical energy the moment it begins taking shape, not all at once. But until the character can rest, thereby breaking the link, the energy invested in any spell he tries to cast is immediately drawn away by the spelljamming helm. This effect occurs regardless of range. Oddly, the helm can utilize the energy only if the character is seated in the helm. Why the helm can draw power from any range, yet gains benefit only from a helmsman actually in contact with it, is one of





the foremost unsolved puzzles of spelljamming magic.)

An individual can use either type of helm for 12 hours without tiring. For each hour afterward, the SR drops by 1, to a minimum of 1. After 24 hours, the individual using the helm will pass out and not be able to use the helm again until fully rested.

An individual seated upon a helm can talk and act normally. The sensation of using the helm is akin to being immersed in warm water. As a result of the magical nature of the helm, the spelljamming mage or cleric using the helm can see things around the ship as if he were standing on the deck. The ship becomes an extension of his body, and responds to his demands in movement and maneuverability. The maneuverability of a craft is a reflection of both the spelljamming

mage's ability and the maneuverability class of the ship.

A minor helm can move a ship of up to 50 tons. A major helm can move one of up to 100 tons. In reality, most ship designers keep their craft under the 50-ton range, though there are large men-o-war and juggernauts that are larger than 50 tons.

Only one helm may be in service at a time, though often a minor helm is kept as a back-up, should something happen to the major helm.

Helms draw their magical energies directly from the user, and the speeds they can attain are determined by the level (or HD) of the individual. All helm-equipped ships travel at the same rate of speed over long distances, but their differences are apparent at the tactical level. In general, given two similar helms, a

ship with the more powerful spelljamming mage or priest is the faster ship.

Helms can be easily installed in any ship, primarily by lugging them aboard and bolting them to the deck. The minimum hull size required for a helm is 1 ton.

If an individual is slain while using the helm, the ship loses all power until a new spelljamming mage or priest takes command. The ship will drift (at tactical speed—see Chapter 4) in a straight line until someone else takes the helm or the ship hits something.

Major and minor helms are nearly (but not completely) indestructible. Their saving throws against all attacks are 2. Unfortunately, this protection does not extend to the individual seated in the helm. Diligent and crafty characters may find



SHAPE CLASSES:

The symbol following the size letter denotes the general shape of the celestial body as it appears from space.

- ✱ Amorphous or flexible shape
- † Belt of smaller objects in a single orbit
- ❖ Cluster of smaller objects within a small area
- Spherical shape
- Cubic shape
- ▷ Flatworld—edges may be irregular, sharp, or rounded
- Elliptical shape
- △ None of the above, but Regularly shaped (such as a tetrahedron)
- ◇ None of the above, but Irregularly shaped

TYPE CLASSES:

The final entry in defining a celestial body is the Type, which is usually determined by the most abundant substance of the object, in terms of the four elements (five in some cultures). If a body is defined as primarily fire in nature, it does not pre-



ways to destroy helms, but the process is not easy or quick.

The effect of a helm on tactical and long-range movement can be found in Chapter 4.

Series helms

Cost: 75,000 gp (per linked helm)

Series helms are the invention of the illithids (mind flayers), but the idea has been adapted for a number of races with spell-like abilities and no levels of experience. Series helms look like the gamut of major and minor helms, running from simple-looking to ornate, but unlike the spelljamming helms, the series helms can be linked together, one to another, to increase their power.

For each helm in a series manned by a mind flayer (or whatever creature the helm is designed for), the ship has an SR of 1. If there are three mind flayers in a series, then the ship has an SR of 3. In general, mind flayer ships will have between two and five series helms, though they may not all be occupied. Empty helms in a series are ignored in figuring SR.

If a mind flayer in a series helm is slain, then the series is broken for one round and the ship loses all power and movement. Further, all mind flayers in the series must save against magic or be slain as well.

Series helms vary from species to species, but in general are inferior to spelljammer helms, at best able to move 50 tons, on par with a minor spelljammer helm. Their lower limitation is a 5-ton ship; they cannot move items smaller than that.

Series helms save against all damage on a 3; they are not quite as tough as spelljammer helms, but almost. Spelljammer helms cannot work on the same ship with operating series helms and vice versa, but a spelljammer helm can be installed

on a ship that previously used a series helm without problem (as long as the two do not co-exist on the same ship. If they do, neither functions at all).

Series helms were developed either by the illithids or by the Arcane with the illithids in mind (accounts vary according to the situation). There are other series helms for those social creatures with spell-like abilities, except for the beholders, who have found their own solution.

Pool Helms

Cost: 500,000 gp (mind flayers only)

A recent development of the illithid collective mind, the pool helm uses the natural life-pool of the mind flayers to power the ships, as opposed to illithids themselves. Such ships have an automatic SR of 5 and are used primarily as transports for illithid Great Old Ones. The pool counts as two crew members. Several nautiloid ships have been equipped with pool helms and there are rumors of larger mind flayer ships, as the pool allows larger ships to be powered. Current rumored maximum size of such a ship would be 200 tons, but this is hearsay and speculation.

Orbus

Cost: 300,000 gp (beholders only)

The orbus is a living being that functions much like a series helm on the beholder tyrant ships. For each living orbus (maximum of five for the typical tyrant ship), the ship has an SR of 1.

The orbi are usually found near the center of a beholder ship, surrounding the Great Mother or Hiveleader of the ship. If an orbus is slain, the SR is diminished by 1, and if all orbi are lost, then the ship loses all power.

Orbi appear as blind beholders, with milky skin over all their eyes.

They are pale and practically helpless on their own. They have been bred by the spacefaring beholder factions to serve and serve well—they have almost no will of their own.

A single orbus can create spelljamming energy for 20 tons of ship, two to a limit of 40 tons, and three or more to a limit of 60 tons. If insufficient orbi exist, then the SR of the ship is 1.

Given the simplicity of beholder ships, it seems possible that humanoid races could make use of the orbus as well, either as a primary or back-up system. The beholders guard their orbi carefully, and would rather disintegrate them than see them turned over to other races. The above price is what an Arcane or beholder of another faction would pay for an orbi.

Forges

Cost: 500,000 gp (initially)
100,000 gp (per year)

Dwarves are, by nature, non-magical, yet they have large asteroid ships greater than those used by humans, elves, or gnomes, powered by magical engines they call forges. These forges are huge foundry rooms at the base of the ship where dwarves work around the clock, building, carving, creating, and forging.

The basic idea of the forge is the same as the spelljammer helm: the conversion of energy into movement. In the dwarves' case, the energy is not magical as much as it is creative. By building items with the forges, the dwarves generate the energy necessary to literally move mountains across the sky.

A forge requires at least 200 cubic yards (2 tons) for every 50 dwarves involved. For every 100 dwarves at work, the ship has an SR of 1. The fastest dwarven ships, therefore, are the ones that give up the most space to their forges.

The minimum size of a dwarven ship is 100 tons, with a maximum size of 700 tons (though these are rare). Attempts to transplant forge-based technology into human ships have failed miserably. The best that can be accomplished is that humans can command a dwarven mountainship with a full crew of dwarves. Both mountain and hill dwarves can be found in space. Apparently, no other race produces this type of energy.

A side effect of this industry is a large amount of tradable goods, as the dwarves mine their own home to produce new energy and items. These range from small metal handicrafts and jewelry to swords, armor, and other weapons. A dwarven ship almost always has an incredibly well-stocked armory and is very well defended. For every month spent in space, the dwarves produce enough goods, metal, coins, and swords to bring in 10,000 gp at the next landfall.

A negative side effect is that dwarven ships often become "finished," with no new things to mine, chip, form, or shape. At this point, the colony abandons the mountainship and sets up home in a new asteroid, stripping the forge in the process. Such abandoned mountainships become the lairs of monsters.

Gnomish helms

Cost: 50,000 gp

Gnomish helms should not function. That is, their very construction seems to defy the nature of thaumaturgic law. They are impossible. Of course, being gnomish, they work anyway. Like most products from gnome ideas, they include a large number of bells and whistles and very little substance. Those that do work usually have a minor helm contained within, always hidden away so as to appear to be innocuous and unessential.

Gnomish helms are large, gaudy, ornate, and overblown. They occupy at least 1 ton of space, and their SR (for those that work) is determined solely by the level of the priest or mage at the helm.

Only about 60 percent of Gnomish helms work (because they've had a real spelljammer helm built into them somewhere). The remaining 40 percent are so much bunk and hokum. Let the buyer beware.

Those foolish enough to purchase a Gnomish helm that works should also hire two to eight gnomes to serve as repairmen. There is a 20 percent chance at any time (usually when you need it most badly) that the helm will malfunction and become inoperative for 2 to 8 turns.

Gnomish helms are treated with a well-deserved derision among the space-dwelling community, and are often unloaded on the unsuspecting newcomer.

Crown of the Stars

Cost: a king's ransom, at least

This magical item distills the abilities of a minor helm into a portable item that can be worn, allowing the helmsman to move normally in addition to commanding his ship. Despite its name, a *crown of the stars* is not necessarily a crown; it may be a torq, or a necklace, or a girdle, or any other item which can be worn. It cannot be a ring, however. The only known *crowns of the stars* are significantly larger than rings, and all contain at least some silver.

If the crown is used to power a ship for one week or more, it becomes bonded to that ship. It cannot be used to power a different ship unless it has been away from its bonded ship for at least one week, thereby severing the bond.

The *crown of the stars* is effective up to one mile away from the ship it



clude the existence on its surface of earth, water, and air. All that the type declares is the general make-up of the planet.

The official name used by cartographers is provided first, followed by the common name used by space voyagers (the name used in conversations is often an idea of whether the speaker is a voyager or a groundling).

Fire (Sun): These celestial bodies provide both heat and light within their shells, and are often (but not always) at the center of the system.

Earth (World): These celestial bodies are the common homes of most fantasy campaigns—the solid earth below, the sky above, etc.

Air (Gas Clouds): These celestial bodies tend to be amorphous in nature, and are viewed as oases where the traveler can regain air and supplies.



is bonded to, so a helmsman can operate the vessel even if he is not on board.

A *crown of the stars* will not affect a ship with an active helm (or equivalent) on board. It can provide spelljamming ability to ships that would otherwise lack it (such as a viking longship). Often a crown is discovered on the ground where they befuddle the local sages, who do not know of the worlds spinning above their heads.

Furnaces

Cost: 100,000 gp

An early and primitive form of spelljamming helm still used in some areas, furnaces take their power not from living spell energy but from magical items. The items are fed into the furnace (and destroyed) to power the ship. Items which cannot be destroyed by fire are unaffected and retain their spells and spell-like abilities.

As a rule of thumb, for every 1,000 xp an item is worth, the furnace will function for one week at SR 2. On long voyages this becomes an expensive proposition. The SR can be boosted to 3 by sacrificing more than one item simultaneously but there is a 25% chance that the furnace will explode and cause 10-100 points of damage in a 30-foot radius.

Furnaces are old devices, found mostly on ghost ships and crashed hulks. They are thought to be an early version developed by the Arcane, then abandoned. They are limited solely to travel within a crystal sphere, as exposure to phlogiston causes an immediate explosion (20-200 points of damage, 45-foot radius). A *chill fire* spell will reduce this to normal devastation.

Artifurnaces

Cost: priceless

An artifurnace is the ultimate stage of the development of the furnace—a magically-powered spelljamming device which draws its power from a magical artifact. Each is a custom-made device tailored to contain and siphon energy from a specific artifact. Because an artifact is practically eternal, the power derived from it is equally so.

Once installed, an artifurnace provides SR 5 for as long as needed. Both artifurnace and artifact are undamagable as long as they remain together (though the ship they are in is not). The artifurnace is destroyed if the artifact is ever removed, however.

Artifurnaces are extremely rare, on the level with artifacts themselves. They also have the difficulty of attracting the attention of those powers tied to the Artifact being used. Should an artifurnace be hooked up to the Eye of Vecna, Greyhawk's immortal lich will likely come looking for it (or send friends in the various spheres where the ship visits in order to recover it). No more than a double handful of artifurnaces are recorded as having existed, and almost all of them are destroyed or hidden. Where they have appeared, they have created insurrection as every captain in the area attempts to seize it for himself.

Lifejammers

Cost: 80,000 gp

The lifejammer is a very specialized and evil type of spelljamming helm which feeds off the life energy of an individual placed inside (usually against his will). The lifejammer can function on any creature with hit points, but drains the life out of the creature placed within.



For every day of operation, the lifejammer sucks 1-8 hit points from the target. These hit points cannot be regained by healing while the individual is within the lifejammer. In addition, for every day of operation (or fraction thereof) the lifejammer's victim must save versus death or perish. An individual with good hit points and saving throws is preferred, but a ready supply of weak characters can be just as useful.

A lifejammer engine gives the ship an SR as if the creature placed within was a wizard using a minor helm. A lifejammer drawing energy from an 8th level fighter, for example, will operate as if an 8th level mage was at the helm.

Lifejammers are believed to be an invention of the neogi, who use multiple lifejammers in powering their mindspider ships. Other evil races,

including undead, have been known to use lifejammers as well. Good races and characters are very reluctant to use a lifejammer except in emergencies, and then are careful to remove the character from the device before his life is endangered.

Nonmagical Engines

Cost: varies, but approx. 10,000 gp

There are a number of ways of moving through space—gnomish engines, chemical propellants, even explosive mixtures ignited in a closed space. These are sometimes used in space to travel through magic-dead areas (called "Sargassos") as well as for lifeboats and shuttles that are too insignificant to merit a full-blown minor helm. Nonmagical movement is used as a backup system for larger ships when all other options fail.

All nonmagical engines share one feature—they are slow compared to helms. Their movement is never more than 17 mph and their SR is 1. At such rates, it would take years to reach even a nearby planet.

Further, they cannot be used to lift off from celestial bodies larger than class A due to their limited power. Little research has been done in expanding this "weak sister" to the spelljammer helms (because the helms provide such a good alternative), but there are situations where they are useful.

Armaments

Weapons in space have followed along the lines of their ground counterparts, and are the descendants of siege machinery and large naval weapons. In addition to the wide variety of personal weapons and magical



Water (Water Worlds): These celestial bodies are rare, and are usually liquid all the way through (though some have solid cores or clusters at their hearts, like gas clouds).

There is one debatable type, put forward by natives of Kara-Tur and other areas influenced by oriental extradimensional Powers.

Plant (Live Worlds): Considered Earth type by other scholars, these refer to living (if not sentient) planets, where the entire body is alive. The existence of Liveworlds creates problems for scholars, as there are a number of other large bodies (such as space dragons) which could be considered celestial bodies as a result.

In addition to the main three categories, supple-



abilities, there is a collection of catapults, ballistas, trebuchets, and scorpions available to the buyer, as well as a variety of rams. Bombards and other "cannon" are used, but are not common—their effectiveness is doubtful, their powers change from sphere to sphere, and the explosive nature of the phlogiston makes carrying them dangerous at best.

All of the standard ships are capable of carrying a base number of large weapons. The weapons themselves are not included in the cost of the ship—these are merely places where the buyer can install weapons without eating up living or cargo space. For each weapon added beyond that, some cargo space must be sacrificed. Some weapons count as two or three for this purpose, and these are noted accordingly.

A ship can have only a single ram. If the ram is listed with the ship's hull description, then it is an integral part of the ship. Otherwise it must be bought and installed.

Damage for each of the weapons is listed in terms of hit points and hull points, depending on how the weapon is used.

The rate of fire (in number of shots per round) assumes a full crew manning the weapon. A "1/2" rating means that the weapon fires one shot every two rounds. For every man less than the required minimum manning a weapon, reduce the rate of fire to the next slower level. For example, a medium catapult with a crew of three and a rate of fire of 1/2 would have a rate of fire of 1/3 with a two-man crew and 1/4 with a single man trying to operate the weapon. A weapon cannot fire without at least one crew member.

The weapons of space are designed for space and make use of its unique properties. A light catapult dismantled from a ship and used on a planet will function like a normal

light catapult under AD&D® rules as opposed to the items listed here.

Catapults

The general category of catapults are large, stone-throwing devices operated by springs, cranks, or flywheels.

Light Catapult

Cost: 500 gp
 Range: 5 Hexes (2,500 yds)
 Damage: 2d10 hit points
 1d2 hull points
 Crew: 1
 Rate of Fire: 1/2
 THAC0: 16
 Critical hit on 20

Medium Catapult

Cost: 700 gp
 Range: 4 Hexes (2,000 yds)
 Damage: 3d10 hit points
 2d2 hull points
 Crew: 3
 Rate of Fire: 1/2
 THAC0: 17
 Critical hit on 19 or 20

Heavy Catapult (Trebuchet)

Cost: 1,000 gp
 Range: 3 Hexes (1,500 yds)
 Damage: 3d10 hit points
 2d4 hull points
 Crew: 5
 Rate of Fire: 1/3
 THAC0: 18
 Critical hit on 18, 19, or 20
 Counts as two large weapons for installation.

Catapults are fixed in position once mounted and can fire in only one direction. A catapult firing forward is permitted to fire at any target across its three forward hexes (see Chapter 4).

All ranges take into account the nature of wildspace and the Flow. Within normal atmospheres and gravities, weapon ranges are as listed in the *Player's Handbook* and

Dungeon Master's Guide, and damage is halved (these weapons are less effective in continual atmosphere).

Catapults can be loaded with stone shot instead of large rocks. Stone shot is most effective as an antipersonnel weapon and will not affect a ship. It inflicts the listed damage to every target within a 10-foot radius of the spot where it hits (make a separate attack roll against each target in the area). Catapults armed with stone shot can also function as jettisons (q.v).

Ballistas

Ballistas include all devices which throw large bolts, javelins, and spears with greater force than possible by human (or inhuman) strength. Most are built along the lines of the crossbow, and are mounted on pivots on the ship's deck to fire at any targets.

Light Ballista

Cost: 400 gp
 Range: 6 Hexes (3,000 yds)
 Damage: 2d6 hit points
 no hull damage
 Crew: 1
 Rate of Fire: 1/2
 THACO: 16
 No chance for critical hit

Medium Ballista

Cost: 600 gp
 Range: 4 Hexes (2,000 yds)
 Damage: 3d6 hit points
 1d3 hull points
 Crew: 2
 Rate of Fire: 1/3
 THACO: 14
 Critical hit on 20

Heavy Ballista

Cost: 800 gp
 Range: 2 Hexes (1,000 yds)
 Damage: 3d10 hit points
 3d2 hull points
 Crew: 4

Rate of Fire: 1/4
 THACO: 12
 Critical hit on 19 or 20
 Counts as two large weapons for installation

Gnomish Sweepers

Cost: 800
 Range: 3 Hexes (1,500 yds)
 Damage: 1-8 points, Special
 Crew: 3
 Loading Time: 1/4
 THACO: 16
 Critical hit on 20

The saying goes, there is nothing in the universe that a gnome cannot make more dangerous, and when the small creatures turn their attention to weaponry, most intelligent species (except perhaps the Giff) move to another sector of space. Occasionally, the gnomes come up with an invention that works most of the time, which they then release on an unsuspecting galaxy, usually cheapening the quality in order to bring the price down.

Gnomish sweepers are an example of such a device. Still experimental, they are nothing more than a pair of light ballistas with a common mount so that they can be fired in the same direction at the same time. The two bolts are linked with a heavy chain. The intention of the chain is to be used as an antipersonnel weapon against enemy crews.

Early versions of the sweepers used chains long and thin enough to capture a couple of gnome-sized opponents, but they soon worked out the bugs to the point that they could use them against human opponents. The other problem with the sweepers remains uncorrected—when the chain strikes something heavy, like a mast, weapon turret, or other piece of deck furniture, the chain tangles and is useless.

A gnomish sweeper affects all tar-

gets in a 10-foot square. It will continue on into the next 10-foot square away from the ship firing it unless it meets with large, unmovable objects, which cause it to drop to the deck. In addition, every target within the 10-foot square are forced to make a Dexterity check to remain standing, the same as if a Ship Shaken critical hit had occurred.

The gnomish sweeper does not inflict any hull damage but can be used as a light ballista in a crunch, with the same requirements for crew and reload time (the weapon does not fire unless both bolts are loaded).

The gnomish sweeper's use as a weapon can be argued by military sages, but it should be noted that after an initial outpouring that saw most gnomish ships carrying a sweeper, practically no new gnomish ships carry the weapons.

Rams

The effects of ramming are covered in combat. They depend on the relative sizes of the ship doing the ramming and its target. There are several different types of rams, however.

Piercing Ram

Cost: 100 gp per ton of ship

A piercing ram is a long, sharp prow used to break open and break apart an enemy ship. An attack with a piercing ram can sometimes result in the two ships being locked together.

Blunt Ram

Cost: 100 gp per ton of ship

This is a flattened ram designed to inflict internal damage by shaking up the smaller ship. It can also break up other ships, but there is no chance the ships will become locked together after ramming.



mental notes are often added. These include:

- Presence of moons
- Lack of atmosphere
- Lethal atmosphere
- Hollow planets
- Large extradimensional gates
- Xenophobic natives (marked by an X)

These supplemental notes are like a hobo's code of marking, symbols, and etchings on the starcharts, and often clutter the situation more than they help the user.

Using these definitions, the Earth/Sol system would be as follows:

- Type H ● Fire Sun
- Type D ● Earth Mercury
- Type E ● Earth Venus
- Type E ● Earth Earth
- Type E ● Earth Mars
- Type A † Earth Asteroid belt
- Type G ● Air Jupiter
- Type G ● Air Saturn
- Type F ● Air Uranus
- Type F ● Air Neptune
- Type D ◆ Earth Pluto
- Type A † Air Cometary Belt



Grappling Ram

Cost: 200 gp per ton of ship

The grappling ram incorporates one or more movable arms which attach themselves to an opponent's ship after ramming, locking the ships together. Very useful during boarding situations. A grappling ram can also inflict damage on smaller ships.

Bombards

Also called cannon, these items are very rare in the Known Spheres, for a variety of reasons. They tend to be unreliable, both from the standpoint of being physically untrustworthy and, more importantly, because the chemical or magical reactions they depend on sometimes vary from one world to another. Gunpowder may work perfectly inside one shell, only to be inert in another, and is a magical jewelry polish in a third. These differences are often written off as the whims of the gods themselves, to keep mortals in their place, but the result is that bombards are rare.

The other reason that bombards are rare is that fire travels poorly through the phlogiston, and many a ship has exploded as the result of a poorly protected powder magazine. If the DM chooses to allow bombards and other cannon to operate in a particular sphere, any critical hit has a 10% chance of igniting the powder magazine, inflicting 2d10 x 5 hull points of damage.

Typical Bombard

Cost: 20,000 gp
 Range: 2 Hexes (1,000 yds)
 Damage: 2d10 hit points
 1d6 hull points
 Crew: 3
 Rate of Fire: 1/3
 THACO: 17
 Critical hit on 20

Bombards are fixed in position once mounted, though they can be

remounted in 1d4 turns in a new position.

Bombards use magical *smoke powder* to function. One shot uses 10 charges of powder. The scarcity of *smoke powder* (which is a magical item in fantasy space) makes bombards impractical compared to ballistas and catapults.

Jettisons

A jettison consists of a series of small catapults loaded with stones, trash, debris, iron spikes, and garbage, and used as an anti-personnel weapon to clear the enemy's decks. Any type of catapult can be converted into a jettison of the same size by loading it with small rocks instead of a single stone. A jettison, however, cannot be converted into a catapult.

Light Jettison

Cost: 400 gp
 Range: 3 Hexes
 Damage: 1d6 hit points
 no hull damage
 Crew: 2
 Rate of Fire: 1/2
 THACO: 15
 Radius: 5'
 No chance for a critical hit

Medium Jettison

Cost: 600 gp
 Range: 2 Hexes (1,000 yds)
 Damage: 2d6 hit points
 no hull damage
 Crew: 3
 Rate of Fire: 1/3
 THACO: 15
 Radius: 10'
 No chance for a critical hit

Heavy Jettison

Cost: 800 gp
 Range: 1 Hex (500 yds)
 Damage: 3d6 hit points
 no hull damage
 Crew: 4
 Rate of Fire: 1/4

THACO: 14
 Radius: 15'
 No chance for a critical hit
 Counts as two large weapons for installation.

Jettisons are mounted in place and cannot be moved. When fired, they hit a spot on the ship and may affect every target within the weapon's radius (make a separate attack roll for every potential target). Saving throws to avoid missile fire can also be used to affect jettison fire, if applicable.

Many spelljammers use catapults as temporary jettisons when they need to. Often jettisons are mounted at the rear of ships to deter pursuers.

A jettison can be fired at an empty hex. This automatically sets up a field of debris in that hex (see Combat).

Greek Fire Projectors

These devices shoot a thin stream of flaming, explosive liquid. Though they can be devastating in combat, like bombardments they are not popular with ships that cross between the spheres because of the flammability of the Flow. In fact, they are a recipe for disaster in the phlogiston. They are popular, however, among crews that do not leave their spheres.

Cost: 1,000 gp
 Range: 1 Hex (500 yds)
 Damage: 3d10 hit points
 1d3 hull points
 +Fire

Crew: 3
 Rate of Fire: 1/4
 THACO: 16
 Critical hit on 18, 19, or 20

Greek fire projectors are only effective when two ships are close enough to share a common air envelope, as any range of more than one hex is sufficient to snuff out the flaming chemicals.

Projectors affect the target and all other targets within a 5-foot radius. A

successful save against Breath Weapon halves the damage.

Ships carrying greek fire projectors are more vulnerable to critical hits, and ships attacking them add +1 to their die roll to determine whether a critical hit occurs. For example, a medium catapult causes a critical hit with a modified attack roll of 19 or 20. Against a ship carrying a greek fire projector, a medium catapult causes a critical hit with a roll of 18, 19, or 20.

Greek fire projectors start fires where they hit, even on stone and treated wood; flammable materials nearby will catch fire and feed the flames. See Fire in the next chapter.

Turrets

Cost: medium 500 gp,
 heavy 1,000 gp

A turret is a rotating platform. Weapons mounted on turrets can be turned to face different targets quickly. For example, a heavy catapult mounted on a turret can be swung to attack any ship in a 360 degree range.

Turrets can also provide partial protection for the crew. Protected turrets are available at double the initial cost, and provide 50% cover (improves AC by 4) to the crew manning that heavy weapon. Small weapons can be moved easily without a turret, but they can benefit from the cover a turret provides.

Hull Armor

All ship's hulls come with a standard Armor Rating (AR), determined by the ship's shape and construction. All ships also have a standard saving throw based on their construction: A ship made of heavy lumber saves as thick wood, while one carved from rock saves as stone.

A hull's armor rating can be improved by increasing either the





Crew Positions

A spelljamming ship has a number of staff positions onboard. These vary from place to place and from race to race, but usually include the following:

OWNER—The one who owns the ship, and signs documents in the ship's name. Usually but not always the captain.

CAPTAIN—Ultimate authority on the ship when it is under sail. May or may not be the owner as well.

FIRST OFFICER—Captain's second-in-command. Serves if captain is not present or is incapacitated. Often responsible for boarding parties.

HELMSMAN—Mage or cleric currently linked into the helm, whose abilities determine the speed and movement of the craft. There may be several helmsmen aboard a ship, with different



thickness of the hull or by plating the hull with other materials (usually metal). The options and costs are:

Increased Thickness

Cost: 100 gp per ton of ship

Increasing the thickness of the hull improves the ship's AR by 1 (from 7 to 6, for example). However, this thickening also reduces available cargo space by 20 percent. If no cargo space is available, the ship may not utilize this method to increase its AR. An elven flitter, for example, cannot increase its hull thickness because it is only a one-ton ship; it has no cargo space to turn into a thickened hull.

A ship can have its hull thickness increased only once.

Plating

Cost: 300 gp per ton of ship

Also called barding, plating a ship consists of covering it in metal plates or scales. This increases the AR of the ship by 1 (from 3 to 2, for example), but downgrades the maneuverability class (MC) of the ship. (A ship with a maneuverability class of B is downgraded to a C) A ship's maneuverability class cannot be reduced below F.

Further, it is obvious to anyone looking at it that the ship is plated. Plating can only be performed once per ship. A plated ship still uses its original saving type—a ship made of thick wood still saves as thick wood, even if it has copper plating.

Stronger Materials

Cost: 5,000 gp per ton of ship

It is possible to rebuild a ship entirely with other materials, such as transforming a ship of wood to one of metal, of glassteel, or of stone. This does not change the maneuverability, hull points, or AR of the ship, but does give the ship the saving throw

of the new material in combat.

Netting

Cost: 3 gp per ton of ship

Ships with large, open decks are often covered with thick, twisted ropes bound into a net. These nets serve to protect the crew partially from catapult fire and boarding from other ships. Attacks coming from above must destroy the nets first before hitting crew members.

Ships with netting gain a +2 on saving throws for their crews against missile weapons or magic which creates solid objects.

In addition, the presence of netting allows those personnel hit by catapult stones a saving throw against death magic to avoid the effect of being hit by such a weapon.

The netting is destroyed once it is hit by a heavy catapult shot, or two medium catapult shots. Greek fire destroys the netting in two rounds. Light catapults, jettisons, and ballistae cause no damage to netting.

In a boarding action, boarders must cut through the netting before they can attack the enemy crew. Netting can be cut the same as grappling lines; it has five hit points and AC 10. Defenders under the netting can attack boarders above the netting if the defenders are armed with P (piercing) type weapons.

Improved Maneuverability

Each ship has a maneuverability rating determined by the shape of the ship's hull and such standard features as sails, balloons, oars, outriggers, and other physical accoutrements that can help shape the helmsman's spelljamming abilities. A ship owner can add to these existing features to improve his ship's dexterity and handling. This additional maneuvering equipment

is called rigging, and requires both an addition of manpower and cost.

A second way to increase maneuverability is to reduce the armor rating of the ship, cutting the amount of mass that needs to be hauled about. This is called stripping.

Rigging

Cost: 100 gp per ton

All spelljammers have rigging of some sort. Rigging a ship beyond its standard results in an increase in the ship's maneuverability class. A ship with an MC of D can be upgraded with improved rigging to MC C.

Additional rigging also means there is more for the crew to do. The minimum number of crew required to operate the ship increases by half the original number (50%). If it normally takes 10 crewmen to operate the ship, the same ship with improved rigging requires a crew of 15.

Rigging can be added only once per ship. It can be used to offset the effect of plating.

Rigging is many things, but never subtle. A nautiloid with additional steering oars or a Shou Lung dragonship with multiple sails will attract attention and enemies will know (if they are familiar with the hull) whether a ship is fully rigged. Such ships are referred to as being "topped out."

Stripping

Cost: 100 gp per ton

Removing nonessential weight can increase the MC of a ship by one rank as well, raising, for example, MC B to MC A. This results in dropping the armor rating by 2 points (from 4 to 6, for example). A ship is considered the same base tonnage despite the loss, and the missing pieces are not obvious to the casual observer.

Multiple Modifications

Such modifications are cumulative, though they can be self-defeating. A ship can be topped out, stripped, and plated simultaneously, with the result of an increase of 1 in MC, a decrease of 1 in AR, and a requirement of half again the basic crew. Most captains would rather have a ship perform one task well than many tasks poorly.

Personal Weapons and Ammunition

Wheel Lock Pistol

Cost: 700 gp
 Weight: 5 lbs
 Size: S
 Type: P
 Speed Factor: 10
 Damage: 1d4/1d4
 ROF: 1/3
 Range: Short—3
 Medium—6
 Long—9

Like the arquebus, the wheel lock is not available in all campaigns. Check with your DM before purchase. The wheel lock is the furthest advancement of gunpowder technology, a further development of the arquebus. As with the arquebus, the range penalties for the wheel lock are doubled.

The wheel lock is as untrustworthy and erratic as the musket. On an attack roll of 1 or 2, the weapon backfires, inflicting 1d6 points of damage to the user and becoming fouled. It will not fire again until cleaned, a process which takes 30 minutes.

When the wheel lock does hit, it inflicts 1d4 points of damage. On a 4, another 4-sided die is rolled, and so on. Thus it is possible for a pistol to inflict large amounts of damage to a target (though it's even more likely that it will explode and injure its user).

High Strength never modifies the attack roll or damage from a wheel lock pistol.

Smoke Powder

Cost: Whatever the market will bear

Smoke powder is a magical mixture of two inert substances which, when combined, form an explosive mix. This mixture is used in arquebuses, wheel locks, and (in large doses) bombards.

A single charge of smoke powder inflicts 1d2 points of damage. Two charges inflict 2d2, 3 charges 3d2, and so forth.

Any *smoke powder* explosion which causes 30 points of damage or more affects everything within a 5-foot radius. Any explosion of at least 50 points affects a 15-foot radius. Divide points of damage by 10 to determine how many hull points are lost to an explosion. Even one point of hull damage, however, is automatically accompanied by a Fire critical hit (q.v.).

Smoke powder is more common in space than on the planets. It is a good seller for the Arcane, who will sell 10 charges (a bombard shot) for 3,000 gp. They may also throw in two to five bombard charges free to anyone who purchases a bombard from them.

Grappling Hook

Cost: 8 sp
 Weight: 4 lbs
 Size: M
 Type: P
 Speed Factor: 9
 Damage: 1d3/1d3
 Range: Short—2
 Medium—4
 Long—6

These are the grappling hooks described in the *Dungeon Master's Guide* with slight modifications so they can be used as weapons and slightly increased range so they are



levels of ability and additional duties as well.

SHIP'S MAGE—Highest level wizard not currently involved in spelljamming.

SHIP'S CLERIC—Highest level priest not currently involved in spelljamming.

SHIP'S SPELLMASTER—Usually most powerful mage or cleric onboard, regardless of class or whether spelljamming or not.

NAVIGATOR—Responsible for long-distance movement and tactics, keeps star charts.

QUARTERMASTER—or QM, is responsible for supplies, including food, air, and weapons. A boring job until ship runs out of something.



more useful for boarding ships. Grappling hooks tend to be large and clumsy and cause damage to characters more by accident than intention.

Boarding Pike

Cost: 5 gp
 Weight: 7 lbs
 Size: L
 Type: P/S
 Speed Factor: 8
 Damage: 1d8/1d6

This is a common, hooked pole arm used in space, primarily for repelling boarders and cutting grappling lines. It is of very little use when trying to board an enemy ship.

Greek Fire

Cost: 100 gp per shot
 Weight: 4 lbs

Greek fire is a slightly corrosive liquid. It usually is stored in stone or ceramic jugs, each jug containing enough greek fire for one shot. Loaded into a greek fire projector and lit, it fires a stream of flame which can set almost any target ablaze. No one has yet refined it to the point where a hand-held projector is feasible.

Greek fire is always flammable. If a cask is opened and comes in contact with fire, it will explode automatically, causing 3d10 points of damage to everyone within a 15-foot radius. Any other greek fire containers exposed to this explosion will also explode with identical results unless their containers save versus fire. Exploding greek fire also causes a fire in the hold.

(The largest gnomish ship ever built—so far as is known—the *Dreadnever*, was destroyed in this fashion when improperly stored greek fire was touched off in the ship's magazine. The captain's last recorded words were "It's awful dark in here.")

Greek fire is sometimes called bannapple gas.

Ballista Bolts

Cost: 5 sp
 Weight: 4 lbs
 Size: L
 Type: P
 Damage: As listed for ballista
 As spear in hand-to-hand combat

A ballista bolt is a large arrow used in all the standard ballistas. A standard ballista bolt will fit a light, medium, or heavy ballista. The difference in damage is caused by the power of the ballista's mechanism.

Catapult Stones

Cost: 3 sp
 Weight: 3-10 lbs
 Size: M
 Type: B
 Damage: As listed for catapult

Unlike ballista bolts, three types of catapult stones are available, one for each type of catapult: light, medium, and heavy. Only the proper sort of stone is really useful in each type of catapult. A copper-pinching captain can use any type of similarly-sized and readily available rock to inflict similar damage, and some combats have involved tossing tables, dead bodies, cows, and other items through space as shot.

Stone shot and Jettison shot

Cost: 2 sp per load
 Weight: 20 lbs per load
 Size: M
 Type: B
 Damage: As listed for catapult or jettison

A bundle of stone shot or jettison shot can fit any catapult or jettison. Usually this type of shot is stored as packages of rocks in thick bags which burst when fired. Almost any

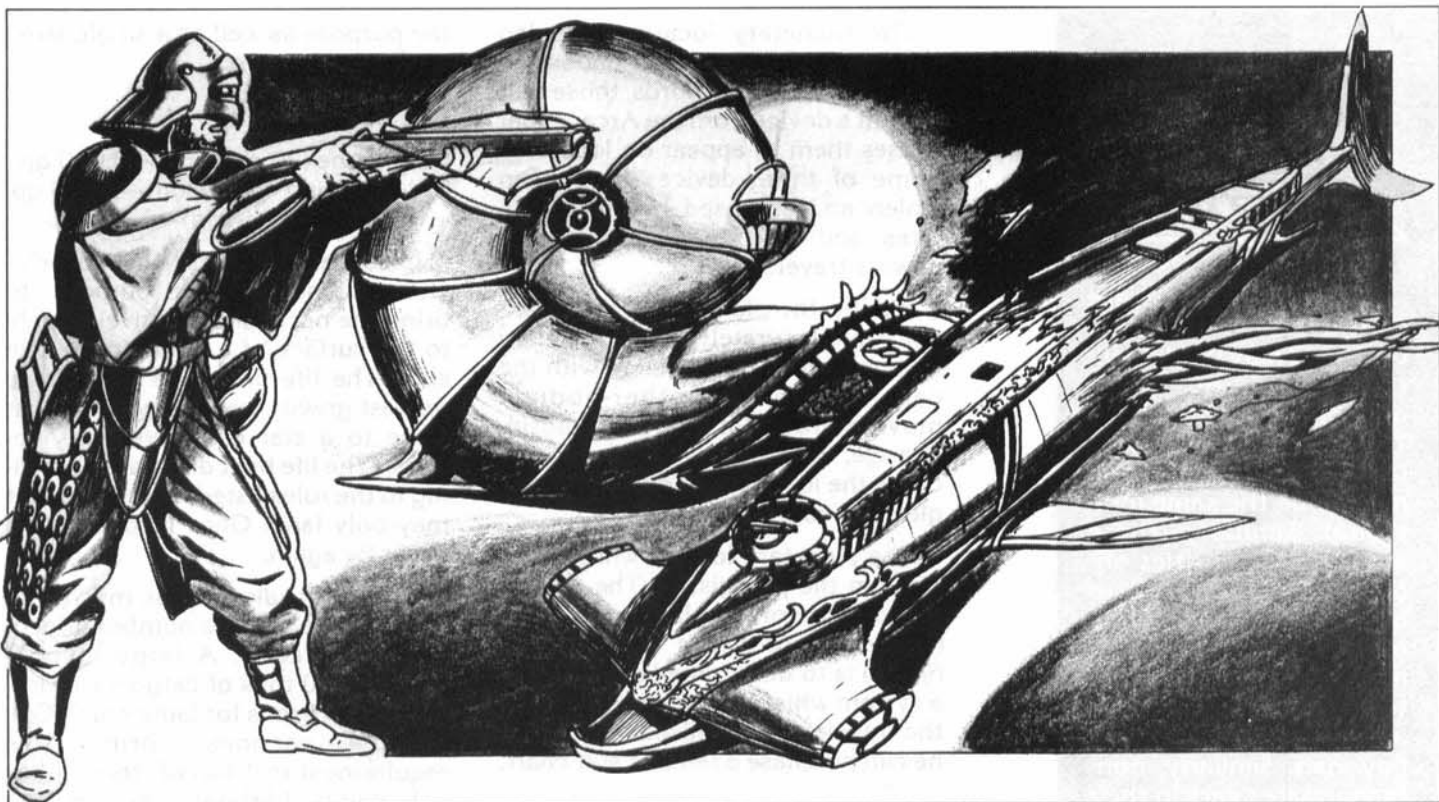

sort of stuff can be substituted in an emergency.

Bombard Shot

Cost: 1 gp (stone),
2 gp (iron)
Weight: 10 lbs
Size: S
Type: B
Damage: As for bombard

Two types of shot are used in bombards: large, round stones and cast iron "cannonballs." Using the latter increases the bombard's damage against a ship but not against crewmembers. (Stone shot often breaks up on impact, scattering sharp fragments, while iron is less likely to do so.) Bombards using iron shot have a +2 modifier to hit.

Other Spelljamming Equipment

There are a few other items that may be useful to the star voyager in his travels, some magical, some not.

Passage Device

Cost: 10,000 per ton of the ship

The passage device is a creation of the Arcane, who use it to create portals through the crystal shell between the phlogiston and wildspace. It functions in the exact same way as the wizard spell *create portal*, but does not require the presence of a mage.

Portal Locator

Cost: 5,000 gp

Another device of the Arcane, This one mimics the wizard spell *locate*

portal. The device is fairly reliable (90% accurate in pointing a direction to the portal) and is often "thrown in" by Arcane salesmen as a giveaway.

Planetary Locator

Cost: 2,000 gp

An arcane device often tossed in as a bonus to purchasers of an Arcane hull, this desk-sized device contains a map similar to the System Display included with this product. When a ship carrying a locator enters a crystal shell, the device immediately tracks the major celestial bodies in that sphere and displays them.

The planetary locator will not track planets or celestial bodies smaller than size B, but should these be encountered the information can be entered manually and displayed thereafter.



All of the above are considered "The Officers" and may hold duplicate titles or share multiple responsibilities. The helmsman, spelljammer, and chief mage may all be the same individual. Similarly, there may additional titles on-board. A ship that makes boarding its primary way of saying "Howdy" might have a battlemaster, or one that carries archery troops a chief Bowman. Similarly, non-human races vary in their positions, from the elves, who add a battlepoet to their officers, to the mind flayers, who keep a "faith officer," to the beholders, who lack any real organization save for that based on subspecies.

Below the officers are the crew—often called the expendables (but never by a wise captain within earshot of them). The crew may be broken up into various tasks (maintenance, weapons, boarding, etc.) or handled in a random fashion.



The planetary locator will also show asteroid bases that choose to be located (in other words, those that bought a device from the Arcane that causes them to appear on locators). Some of these devices have been stolen and are used by Neogi, pirates, and other marauders to trap unwary travelers.

Finally, the planetary locator cannot show accurately those planetary systems which do not align with the central-body-with-other-bodies-moving-around-it type. Chaotic, strange, or other types of systems cause the locator board to turn a single solid color, or go black.

The planetary locator will not operate in the phlogiston. The recommended use of the planetary locator (according to *Volo's Big Book of Space*) is to determine landmarks in a system which can be used to guide the traveler to a civilized area where he can purchase a reliable star chart.

Star Charts

Cost: 100-600 gp

The star charts of a system vary in price according to how well that system is known and visited. Star charts indicate the location and relative position of the various planets in the system, but do not indicate current positions. They are not magical but are very useful for determining things like hostile forces, mean temperature, and spaceborne powers operating in the region.

Anchors/Tethers

Cost: 10 gp per ton of ship

Anchors are used to moor a ship to a larger body such as an asteroid or tie together two ships. Anchors and tethers are also used at space docks to secure ships and keep them from drifting off in difficult situations. In general, a larger ship will require a greater anchor, but for very large ships, multiple tether/anchors serve

the purpose as well as a single large anchor.

Life Boats

Cost: large (20 person)—10,000 gp
 medium (5 person)—5,000 gp
 small (2 person)—1,000 gp

Life boats are hard-shelled vehicles designed for one purpose: to bring the occupants relatively safely to the surface of a planet or rescue ship. The life boat falls toward the nearest gravity well (using a lifeboat close to a star can have nasty results). The life boat descends according to the rules listed for landing, but may only land. Once landed, it will never fly again.

A lifeboat takes up as much tonnage as one-half the number of people it can carry. A large lifeboat occupies 10 tons of cargo space (including jettisons for launching). Collapsible versions shrink this requirement to 1 ton of storage, but collapsible lifeboats require 2d4 rounds of setup before they can be launched. Collapsible versions cost three times the listed price.

Crews

Because so much of the glossy and important work of a spelljamming ship rests with the captain and helmsman, the place of the normal crew is often glossed over. However, the careful captain who trains his men well and treats them as more than dragon fodder will be rewarded with a ship that can handle itself well in tactical situations. While the gross motive power of the ship is determined by the helmsman, its tacking, heeling, and spinning is controlled by the men who man the rigging and the oars.

Crews are divided into four classifications: green, average, trained, and crack. Their costs per man are below:

Green: 2 gp per standard month
 Average: 4 gp per standard month
 Trained: 6 gp per standard month
 Crack: 6 gp per standard month

Payment is usually in advance for the first two months, with any extra money accrued payable on landfall. In addition, crews which are going into hazardous situations (such as when hiring privateers or adventurers) may in addition demand a crew's cut of plunder—a share equal to that of the leaders, to be distributed among the surviving crew. Such a crew's cut will not improve their sailing ability but will affect their morale in combat situations.

Green sailors are those that can be picked up anywhere—everyone from groundlings eager to get into space to ex-mercenaries drowning their troubles in the bars. They barely know the difference between a hawser and a ballista. They are warm bodies to fill the ranks, but little more.

Average sailors are usually found around space citadels, asteroids, and other pockets of civilization. They have had sailing experience before in space, and are competent to run a ship fairly well. In any city of respectable size (such as the Rock) they can be found in sufficient numbers to crew a vessel.

Trained sailors are the veterans of many voyages, often on a number of ships. They are numerous, but that does not mean they are easy to find. In any large city area in space, about 3d10 trained sailors can be found for hire. Of course, arrivals of new ships, ship crews mutinying or abandoning people may change that number.

Crack sailors are not so much rare as very specialized. They are the best at what they do for a particular captain and aboard a particular ship. Taking a crack crew from a nautiloid and putting it on a squid ship reduces it to trained status. The "crack" crew

designation gives greater benefits than a trained crew.

Initial Crew Status

Initially a crew has the rating of the majority of its members. A crew of 10 with one trained, six average, and three green recruits is considered average while one with two trained and eight green members will be considered green. This is for determining the initial crew rating only, when a ship is just starting out in play.

Increasing Crew Status

A green crew becomes average after one month of travel. This reflects one month of total travel, so that two days of travel, a week of hanging around in a dock, and two more days of travel add up to only four days of travel. Thirty standard days are needed to break in a green crew.

An average crew becomes trained after two more months of travel, including at least one trip into the phlogiston. For unindoctrinated crews, the Flow is a spook-house filled with nasty creatures, a belief which is too easily confirmed by beasts such as the ephemerals.

A trained crew becomes crack after three more months, including at least one trip into the phlogiston and one battle with another ship (known as "bleeding the crew"). If during all three of these months, the crew served under one captain, on the same ship, they attain crack status.

Decreasing Crew Status

Crew members will be lost through the normal wear and tear of combat and travel in space. As long as at least 20% of the original crew is still on board, the ship's crew status stays the same. For example, if a ship with a trained crew of 10 men loses eight to a krajen and then hires eight green replacements at the next stop, the ship still has a trained crew. The old-





ion ("Hey, we need someone to scrape off the barnacles!").

The crew is usually (but not always) non-player characters, brought along for the ride or hired for a particular voyage. A ship's crew has a morale of 11 in most situations. As an option, the DM may assign higher or lower initial values depending on the situation, for example:

Crew is	Morale Value
Complete novices in space	9
Above, but military or mercenaries	10
Have been in space before	12
Above, but military or mercenaries	13
Elite space veterans	14
Mainly pirates	11

Crew losses can be replaced at civilized bases or on various planets.



timers teach the ropes to the newcomers.

The exception to this is crack status. If a crack crew loses more than 50% of its members, it slips to trained status until the new crew passes through the three-month process to regain its status.

Crews, regardless of their status, can man large weapons. The status of green, average, trained, or crack does not affect combat ability.

Effects of Crew Status

A crew that works together smoothly can increase the speed at which a ship reacts to enemy maneuvers. This has no effect on the ship's maneuver rating, but does modify its initiative rolls.

If the Crew is:	Then Initiative is:
Green	+1
Average	Unmodified
Trained	-1
Crack	-2

Morale is also affected by the crew's status.

If the Crew is:	Then Morale is:
Green	-1
Average	Unaffected
Trained	+2
Crack	+4

Weapon Teams

Any crewman or character can operate a large weapon such as a catapult, ballista, or jettison. There are specialists who have been trained in their use, however, and they tend to be more valuable in combat. If player characters wish to invest, they may be able to get special hirelings for these shipboard positions.

Any good-sized city will have a few large-weapon specialists available for hire. One to 10 will be available in any standard month, and their hiring rates are usually 6 gold per month per specialist.

A single specialist will affect the firing of one large weapon onboard ship. Multiple specialists are needed to maintain many weapons. A weapon specialist can help in the repair and operation of any of the large weapon types that he is versed in, but can only give his bonuses to one weapon at a time.

The large weapon assigned the weapon specialist has a +1 bonus to hit as long as the weapon specialist is able to communicate with the other crewmen on the weapon team. Further, the weapon team may suffer the loss of one member (who is not the specialist) and continue to operate with no ill effect on its rate of fire.

A weapons specialist is usually versed in one type of weapon: catapult, ballista, bombard (where available), greek fire projector, or jettison. Five percent of those encountered will be knowledgeable in two weapons, and five percent of those will be versed in three.

A character with proficiencies in any of these weapons can hire on as a weapon specialist or use his proficiency to provide a bonus to hit from a single turret. A character doing this cannot be engaged in another position on the ship (such as captain, navigator, or helmsman) or leave his position or the benefit is lost.

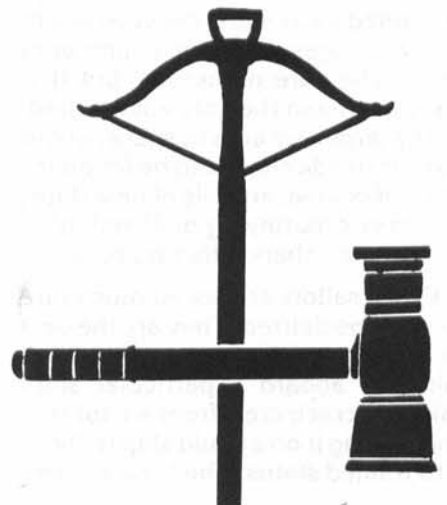

Ship movement can be treated under two categories: long range and tactical. Long range movement is used for traveling over the great distances of space between the planets, and along the rainbow ocean called the phlogiston that runs between the crystal shells. Tactical movement deals with shorter ranges between objects in space and is the theatre of ship-to-ship combat.

The magic behind the spelljammer helms allows them to travel great distances in little time, but also causes them to slow down when they draw near other large objects, including other ships. For this reason movement is divided between long range, high speed movement (such as is used when ships travel between planets) and short range, tactical or maneuver speed. Because tactical movement often is triggered by (or followed by) combat, the rules for fighting from ship to ship are covered in those same sections.

Long-Range Movement In Atmosphere

A flying ship in the SPELLJAMMER™ universe moves 500 yards per round for every point of its ship's rating. This translates into about 17 miles per hour or 400 miles per day, *per ship's rating point*. This is a wonderful number when compared with most ground movement, which is measured in tens of miles. Few characters who spend their lives on the ground travel 400 miles in their entire lives.

Taking Off and Landing

Only ships capable of landing on water or land can do so and take off safely. Any ship can crash onto a planet or its ocean, but then taking off again is guaranteed to be a problem (see *Crashes*).

When taking off from a celestial body, some time is required to over-

come the force of the body's gravity. When taking off from a body of class A or greater, a certain amount of time is required to allow the energies contained within the helm to overcome the force of normal gravity and take off. It takes 1d8 rounds from the time a spelljamming mage sits upon the helm to when takeoff is ready. Once this random warm-up period is over, the magics of the helm automatically correct the force of gravity. Smaller celestial objects (such as other ships) do not have this warm-up requirement.

A ship's maneuverability class (MC) in atmosphere (that is, for flying combat) is the same as when the ship is in space. Treat class F vessels (usually modified sea vessels) as MCE for airborne combat. In general, a spelljamming ship's high speed allows it to evade all but the fastest and most maneuverable opponents.

For each point of a spelljammer's ship rating, a ship has a movement factor of 24 for movement in air. A ship can move slower than 24 per

round or hover in place. Bear in mind, however, that a slow-moving ship hanging in the air is an enormous, easy-to-hit target (+4 to hit at least, up to +8 if the ship is hovering). Further, ships with poor maneuverability classes in space have equally bad MCs in atmosphere.

A hovering ship is considered to have no MC, and is treated as a levitating body.

The amount of time that it takes to get out of a planet's "gravity well" and attain full wildspace movement is determined by the planet's size:

Size Class A:	10 rounds (1 turn)
Size Class B & C:	2 turns
Size Class D:	3 turns
Size Class E:	4 turns
Size Class F:	6 turns
Size Class G:	12 turns
Size Class H:	24 turns (4 hrs)
Size Class I:	48 turns (8 hrs)
Size Class J:	96 turns (16 hrs)

The time required to get out of a planet's gravity well from its surface is the same regardless of the planet's

TYPICAL WEATHER CONDITIONS IN ATMOSPHERES

2D6 Roll	Spring/Fall	Summer	Winter
2	Becalmed	Becalmed	Becalmed
3	Becalmed	Becalmed	Light Breeze
4	Light Breeze	Becalmed	Light Breeze
5	Favorable	Light Breeze	Favorable
6	Favorable	Light Breeze	Strong Winds
7	Strong Winds	Favorable	Strong Winds
8	Storm	Favorable	Storm
9	Storm	Strong Winds	Storm
10	Gale	Storm	Gale
11	Gale	Gale	Gale
12	Hurricane*	Hurricane*	Hurricane*

* Hurricanes occur only if the previous day's weather was "Gale." Otherwise treat as gale force winds.

As a rule of thumb, precipitation (rain and snow) occurs on a 1 in 6 chance in summer and winter, and 2 in 6 in spring and fall, subject to local conditions. Storms and hurricanes always include precipitation (which is already figured into their modifiers on the table below).

In the above situations, movement is reduced by a modifier and the time required to lift off or land is increased.



Ship Names:

There are as many names for the various ships as there are races and inhabited worlds. Each culture brings its own names into space, and a ship that qualifies to one group as a "free frigate" because of its size and purpose might be to another a "system rock" since it lacks a spelljamming helm or other inboard motive power.

Names by Size:

BOAT—less than 10 tons and unarmed—a derogatory term versus any actual ship name.

FIGHTER—Less than 10 tons and armed. Elven fighters are often called flitters.

GALLEY or **COG**—10-20 tons, taken from their earthbound analogies but ignoring the difference in the ship types. Also called a **SLOOP**.

SCHOONER—20-30 tons.



composition and/or whether it has an atmosphere.

This assumes that the ship is moving in a straight line upward. Time spent jetting about at the same level or in mundane activities such as dog-fighting is discounted from the total time.

In general, landing takes the same amount of time.

Atmospheric conditions may create difficulties in both in landing and taking off.

Condition	Landing/ Takeoff Time	Modifier
Becalmed	Normal	x 1
Light Breeze	Normal	x 1
Favorable	Normal	x 1
Strong Winds	Time x 2	x 1/2
Rain or Snow	Time x 2	x 1/2
Storm	Time x 4	x 1/4
Gale	Time x 4	x 1/4
Hurricane	No takeoff or landing possible	

Effects on movement time and movement factor are cumulative. For example, a ship trying to lift off from a class E planet normally takes four turns to get out of the planet's gravity well. If it is trying to do so in strong winds, this time is doubled to eight turns and the ship's tactical movement speed is halved. If the strong winds are accompanied by rain, this time is doubled again to 16 turns and the ship's speed is quartered.

Traveling in Wildspace

Traveling in a straight line, spelljamming ships can attain high velocity relatively quickly, spanning the great emptiness between the planets in a short time. The operative phrase, however, is "straight line." Upon making a turn, or coming into the gravity field of another large body, the spelljammer helm automatically decelerates to a more manageable speed described under *Combat*. This

is a function of all spelljamming, regardless of the type of helm or owning race of the ship. Mind flayer serial helms and pools, major and minor helms, and even arcane devices all function under this limitation. A "large body" is any body of 10 tons or greater space displacement (100 cubic yards, or a cube slightly less than 14 feet on a side), which includes most spelljamming ships, planets, stars, and other worthwhile celestial bodies. Small items such as boats and elvish flitters which rate under 10 tons do not have this effect.

A ship can travel 100 million miles per day regardless of its SR rating. This is the speed of all spelljamming ships over long distances, regardless of the size of the ship or the level of the spellcaster manning the helm. As long as a ship has a functioning spelljamming device of any type, and an individual who can use it, a ship can move 100 million miles in a single standard day (about four million miles per hour).

Four million mph sounds like a lot, and in "real terms" means that a ship with SR 1 can travel from Earth to the Sun in a single day. However, space is incredibly large, and that same ship would take 36 days to reach Pluto. Given that the crystal shell is as far from the orbit of the furthest planet as is the primary star, a trip from the Sun to the crystal shell girding Earth's system would take 72 days.

Therefore, movement between the planets is time-consuming when dealing with the outer bodies, and relatively rapid among the inner spheres. Again, using the Earth/Sol system as an example, a ship from Earth with a spelljamming device could reach as far as the orbit of Saturn in a single week. (Of course, the planet may not cooperate by being there, but that is another matter. See *Celestial Mechanics* for information on planetary placement.)

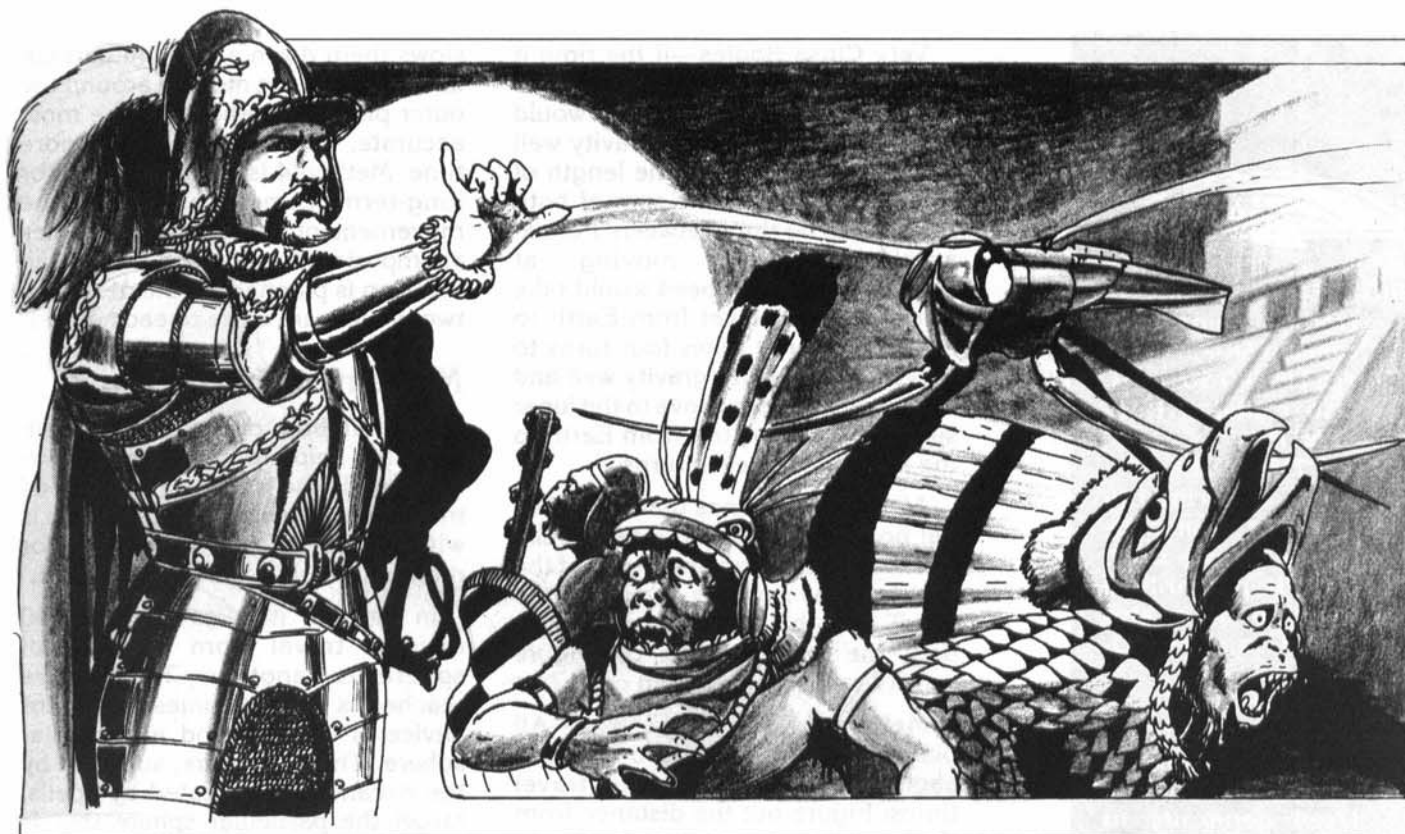

What slows movement among the more crowded inner planets is the presence of multiple, occasionally overlapping gravity wells. Once a ship moves within the gravity well of a large body (10 tons or greater), it immediately drops to "normal" (500 yards per SR) speed. It can descend to the planet's surface, or move around in the planet's outer atmosphere, or leave the area again, after 1d8 rounds of warming up the spelljammer helm.

This "sudden stop" when moving at high speeds does not affect anyone riding on the ships. The effortless deceleration is believed to be created primarily as a safety factor to prevent spelljamming ships from colliding with other ships, meteors, asteroids, and planetary bodies. In reality, this often means that a ship enroute from one point to another in a (relatively) more crowded section

of space may have more encounters than a ship moving through an emptier area (out near the shell, for example) so the ship has to continually slow down between locations.

Calculating Travel Times in Wildspace

This is dealt with in more detail in the chapter on Celestial Mechanics, which adds the movement of the spheres themselves. But in general, the time between two planetary bodies can be figured as:

- Time to take off (in rounds) +
- Time to escape the gravity well (in turns) +
- Time to cover the distance to the next planet (in rounds, turns, or days, as appropriate) +
- Time to land (in turns, reverse of time to reach edge of gravity field).

As an example, a trip from Earth to Mars, assuming that they were as near as possible (about 50 million miles), would take:

- 1d8 rounds for warm-up on Earth;
- 4 turns to reach edge of a class E world;
- Travel time = 50 million miles/100 million miles per day = .5 standard days or 12 hours (72 turns);
- 4 turns to reach surface of a class E world.

So, total travel time is about 80 turns. Not bad for wooden ships.

Earth and Mars are rarely close to each other, however. If they were as far apart as possible, the travel time between them would be 2.3 days.

This number crunching is for players who are interested. An easier method is provided in the Celestial Mechanics chapter.



FRIGATE—30-40 tons. In trading ships, also called a **SKIPJACK**.

CORVETTE—40-50 tons, also called a **BAR-KENTINE**.

SHIP OF THE LINE—50 + tons. If primarily cargo, it is also referred to as a **CLIPPER**. If primarily a warship, it is also called a **MAN-O-WAR**.

DREADNOUGHT—rare ships of 100+ tons.

ROCK—a ship lacking a spelljamming helm. Used generally in reference to dwarven ships.

Further, a ship may be referred to by appearance, and ownership. Dwarven ships are regarded as rocks primarily for their appearance, though any ship adrift is considered as a rock. A ship used primarily by a single race is referred to by that in general descriptions of the ship types (such as a mind flayer nautiloid, or a beholder tyrant-ship). Ships that owe allegiance to



Very Close Bodies—If the time it would take to travel between two bodies is less than the time it would take to move out of one gravity well and into another, then the length of the trip is equal to the sum of both times, with no time between. For example, a ship moving at spelljammer-class speed would take three turns to travel from Earth to the Moon. But it takes four turns to move out of Earth's gravity well and three more turns to move to the lunar surface. Thus, the trip from Earth to the Moon takes seven turns.

All of this assumes that the celestial bodies remain at the same relative distance during the course of the trip. In many systems, including the "real" one, this is not the case. How does the Spelljamming DM figure travel times without going crazy?

Method 1: The Short Way—All planets are considered to be close to each other when figuring travel times: Figure out the distance from the Primary, subtract the two, and divide by 100 million. This gives the number of days it will take. Round all fractions up to the nearest day.

Method 2: The Long Way—All planets are considered to be at the furthest distance apart. Add the two distances from the primary and divide by 100 million. For each .04 of the remainder add an hour to the final time.

Method 3: The Average Way—All planets are assumed to be at their average separation. Determine the distances using method 1 and method 2 and use their average. Round fractions up to the nearest day.

Method 4: The Starcharter's Way—Check out the Celestial Mechanics section and use the Celestial Display for movement of the bodies.

Method 1 is the fastest method, and lets the characters move about the system very quickly. Method 2

slows them down a little, in particular when they are moving around the outer planets. Method 3 is the most accurate, but takes slightly more time. Method 4 is recommended for long-term campaigns where the movement of the planets becomes an important factor (such as when an invasion is planned for the next time two planets are close to each other).

Movement in the Flow

The rainbow ocean allows spelljamming ships to attain greater velocities. These speeds have defied measurement since the phlogiston is without permanent landmarks or markers. Time is the only constant.

In general, it takes from 10-100 days to travel from one crystal sphere to another. The sphere reached is random unless a locator device is used to find a particular sphere. These locators, supplied by the Arcane or duplicated by spells, target the particular sphere that is sought. Some spheres are unreachable from others due to the Flow itself, and travelers must go through a third or fourth sphere in order to reach their goal. These anomalies are noted under the individual spheres—which spheres are nearby and can be reached regularly, and which ones are not. Some spheres drift into and out of proximity with each other, so that just because you reach an area once does not mean that you will find it again.

A ship's last port of call determines which spheres it can move to. Port of call is the sighting or landing within a crystal sphere. If a ship heading for Krynn from Greyhawk accidentally ends up at the Realms, the Realms becomes its new port of call.

Ships in the Flow slow down when they encounter other bodies, such as ships and rogue planets, but this does not affect total travel time.

Tactical Movement

Tactical movement occurs when a ship encounters another large body, usually another ship. Such tactical encounters can occur either in the Flow or in wildspace, and both are handled similarly.

One of the maps in this product shows a hex grid against a star background, suitable for marking ship locations in ship-to-ship combat. Each hex is 500 yards across. A round of combat in space is the same as a standard round—one minute.

Movement and combat are handled in a two-dimensional format despite the fact that space (even fantasy space) is three-dimensional. This is purely for the sake of simplicity. Three-dimensional rules are very slow and add little or nothing to the flavor of the game.

Players and referees will do well to remember that this product is intended for use as a role-playing aid. The SPELLJAMMER™ supplement is not a board game of ship-to-ship combat. It provides a framework for playing the AD&D® game in space. The game will be far less interesting if played without the personal involvement of player characters aboard ship.

Ship-to-ship combat flows along the same lines as standard AD&D combat. Initiative is determined for the turn, then one side moves and fires, then the other. The chief difference is the sense of scale involved. Missiles can travel through space several miles before finding a target, while magic spells require a closer approach, and ramming and boarding closer still.

Also, ship-to-ship combat poses danger to the characters involved of losing their ship and being stranded in space. Many (but not all) enemy ships will rescue survivors (as slaves if nothing else), but some, particu-

larly during war, will leave the survivors to fend for themselves.

Each ship is represented by a stand-up playing piece and a card-stock sheet, listing its capabilities and normal crew. Players who are piloting their own ships should note their ship's abilities and those of significant passengers—like player characters—on board. A ship with a variety of player characters on board has an advantage over one manned merely by NPCs, even if those NPCs are mind flayers.

Facing

Each ship has a facing. It is pointed in a particular direction on the map. The playing piece should be placed with its front crossing one of the six sides of the hex it is in. For typical ships, the ship is in the hex where its base is. Large objects, such as asteroids, the Rock, and the *Spelljammer*, are in all the hexes that their pieces cover.

A ship can change its facing as part of its movement. How often it can do this depends on its maneuverability rating.

Movement

A ship's movement is determined by its SR. A ship may move one space or change its facing direction by one hex side at the cost of 1 SR. For example, a ship with an SR of 3 can move one hex, turn in a new direction, then move another hex in its turn; or move three hexes in a straight line; or move two hexes, then turn one hexside; etc.

A ship can always change its facing by one hex side at the end of its movement for free, in addition to any other facing changes.

When a ship changes direction, it uses one SR for every hex side it turns. The maneuverability class of the ship affects how often and when the ship can change facing:

- Ships of class F cannot change facing as their first action. They must move into the hex they are facing at the start of the turn before any turning is allowed.
- Ships of class D and E cannot change facing by more than one hex side within a single hex in a single turn. They can change facing as the first action of their move and can change facing as often as desired during the move, but no more than one hex side per hex moved.
- Ships of class B or C can change facing up to two hex sides in a single hex.
- A ship of class A may change its facing at will in the direction of choice, even 180 backwards. A ship of class A does not expend SR when changing facing.

Speed

The total number of hexes moved and hex sides changed in a move is a ship's speed. A ship controlled by a spelljammer helm or similar mystical engine can move as far as its SR permits. However, how fast it can accelerate or decelerate depends on its previous move, its maneuverability, and the type of helm used.

A ship with a major helm may set its SR each turn, up to its maximum. A major helm onboard means that the ship can move one hex one turn, then seven (if a sufficiently powerful mage is available) the next, and so on. All facing changes and forward movement counts against the current speed of the craft. Speed can only be changed at the beginning of the move, never during the move.

All other devices for spelljamming are limited according to the MC of the ship involved: A ship with an MC of F may, in one round, increase or decrease its speed by one. A ship with an MC of E or D can in one round increase or decrease its speed



no particular race or nation are referred to as "Free." A free trader out of Krynnspace owes no allegiance beyond its own ship and crew, while a Krynnish trader can be counted on acting in the best interest of its home sphere, and eventually to return there. If a ship is confined to a particular crystal shell, whether by choice or not, it is referred to as a **SYSTEM SHIP**.

Finally, a ship that resembles little more than a terrestrial galley or galleon hopped up with a spelljammer helm and taken into space is called a **GROUNDLING** craft. Groundling is a general term used in space to refer to the Earth-bound nations and their peoples. It is not derogatory per se, but is often used by those seeking to embarrass a newcomer to the various parts of wild-space.



by two. A ship with an MC of C or better can increase or decrease its speed by three.

Full Reverse. A ship can reverse its direction and move backward, subject to the limitations on its speed according to its MC. Maximum reverse speed for most ships is two hexes per turn.

Stacking

Any number of ships can be in the same hex at the same time. Ships in the same hex have the option to board, ram, grapple, or engage in missile fire and magic.

Combat

There are two general types of combat in space: long range and close combat. Long range combat occurs when the ships are in different hexes. This is beyond the range of most magical effects and is the province of missiles and heavy armaments. Close combat occurs when two ships are (however briefly) in the same hex. Then spell attacks occur, in addition to other missiles. It is also at such times that boarding and ramming can occur between ships.

The Turn Sequence and Initiative

The turn sequence for battling in space is similar to that for fighting on land:

- 1) The DM determines what actions the monsters or NPCs will take, including attempting to ram, spells, etc.
- 2) The players indicate what they and their ships are doing.
- 3) Initiative is determined.
- 4) Movement and attacks are made in order of initiative.

Movement is performed one ship at a time. One ship takes its full normal move, then the next, and so on.

Long range combat can occur at any time. Short range combat (including boarding and ramming) can occur only when two ships are in the same hex.

No weapons can be fired while a ship is moving. As soon as a ship completes its move, the owning player announces whether it will fire any weapons. If it fires, those attacks are resolved immediately. After that ship has had the opportunity to fire (regardless of whether it fired or not), any other ship may fire its weapons at the ship which just moved, or any other ship.

Each weapon can only be fired once per turn. The moving ship always has the opportunity to declare and resolve its attacks first. After it does so, other ships can attack. If there is more than one other ship attacking, resolve their attacks in the order of their initiative.

Many large weapons take more than one round round to reload between shots.

Initiative

The winner of the initiative die roll can choose whether he wants to move first or last that round. The player with the second best initiative roll can choose whether to move second or second to last, and so on.

Unless optional initiative rules are used, there are no initiative modifiers in space for space ships. Individuals fighting on the decks of a ship may fight with standard initiative modifiers.

Optional Initiative Modifiers

Players may wish to use the optional modifiers to initiative for situations involving ships and individuals. Ships are considered in the 25-foot + category of gargantuan figures, and therefore suffer the +12 modifier. Their weapons are considered an integral part of the ship and share the

same initiative roll. All other optional modifiers apply, including those for proficiencies if they are in use.

Modifiers for crew quality are as follows:

Green	+1
Average	0
Trained	-1
Crack	-2

Optional Turn Sequence: Players who want a slightly more realistic flow of events at the expense of a slightly slower game can try this turn sequence.

- 1) The players and DM roll to determine initiative;
- 2) The side with initiative chooses whether it wants to move first or last;
- 3) All ships on the side that is moving first perform their move. No combat of any sort is allowed, including ramming;
- 4) All ships on the side that is moving second perform their move. No combat of any sort is allowed, except ramming;
- 5) The side with initiative fires its weapons and resolves all other combat;

- 6) The side without initiative fires its weapons and resolves all other combat.

Long-Range Combat

The large weapons onboard ship, along with normal missile weapons, fire further in space than within atmospheres. Therefore it is often a tactic for crews to fire volleys from a long distance before closing to attack.

Large onboard weapons (catapults, bombards, ballistas, projectors, and jettisons) all have a typical

Weapon	Range	Hull Damage	Personal Damage	ROF	#Per	THAC0	CH
Light Ballista	6	0	2-12	1/2	1	12	—
Medium Ballista	4	1-3	3-18	1/3	2	14	20
Heavy Ballista	2	3-6	3-30	1/4	4	17	19+
Light Catapult	5	1-2	2-20	1/2	1	14	20
Medium Catapult	4	2-4	3-30	1/2	3	15	19+
Heavy Catapult	3	2-8	3-30	1/3	5	16	18+
Bombard	2	1-6	2-20	1/3	3	17	20
Light Jettison	3	0	1-6	1/2	2	14	—
Medium Jettison	2	0	2-12	1/3	3	15	—
Heavy Jettison	1	0	3-18	1/4	4	16	—
Greek Fire Projector	1	1-3	3-30	1/4	3	16	18+
Missile Weapons							
Arquebus	1(l)	0	1-10	1/3	1	U	—
Comp Long Bow							
Flight Arrow	1(l)	0	1-6	2/1	1	U	—
Sheaf Arrow	0	0	1-8	2/1	1	U	—
Comp Short Bow							
Flight Arrow	0	0	1-6	2/1	1	U	—
Longbow							
Flight Arrow	1(l)	0	1-6	2/1	1	U	—
Sheaf Arrow	0	0	1-6	2/1	1	U	—
Short Bow							
Flight Arrow	0	0	1-8	2/1	1	U	—
Heavy Crossbow	1(l)	0	1-4+1	1/2	1	U	—
Light Crossbow	0	0	1-4	1	1	U	—
Sling							
Bullet	1(l)	0	1-4+1	1	1	U	—
Stone	0	0	1-4	1	1	U	—

No other missile weapons are significant enough to rate at this scale, though they are useful in ramming, boarding, and melee situations. The hand-held missile weapons marked 1(l) are capable of hitting at a range of one hex, but this is considered long range. Missiles marked with a range of 0 can be used only if the target ship is in the same hex as with the attacker.

U = User's level used to figure THAC0.



Why are Crystal Shells Round?

The systems of the SPELLJAMMER™ universe are all held in bubbles which drift in a rainbow ocean called the phlogiston. Whatever the shape of the system within, whether a collection of clusters, or a single flat plane, or a chaotic bundling of planets, the sphere that it all fits into is round.

Why?

No one knows, but there are several theories by way of explanation:

The sphere is the most natural shape for such things, much like bubbles in amber or champagne.

The sphere is the easiest shape for the gods (or whomever built these things) to construct.



range and amount of damage they inflict, summarized on the table below. A large weapon inflicts either hull damage or personal (hit point) damage, but not both. The attacker must specify whether the weapon is aimed at the ship or a character before firing.

Choosing Targets

Larger weapons (any weapon that is not hand-held) may inflict damage on crew targets (in hit points) or enemy ships (in hull points). The attacker chooses which type of target he wishes to attack.

A large weapon may always attack ships in other hexes.

- Catapults cannot attack ships in the same hex;
- Any weapon attacking the crew (hit point attacks) may attack any character on deck or partially exposed. A player may not simply specify "I'm attacking the captain," however. If he wants to attack the captain, he must tell the DM how he will identify the captain. If the attacker has no clear idea of what the caption looks like, the DM should assign the shot randomly among the potential targets;
- Attacking the crew other than from in the same hex with a missile weapon means that the attack hits a random individual on the deck (all those on exposed decks are targets—if 10 individuals are available to attack, then any of the 10 may be hit);
- Large weapons modify their THACO by the AC of the target they hit. For crew hits it is the AC of the crew or creature. All ships have an AC equal to their armor rating. A crew member gets a one-point bonus to his armor class for the turn if the ship's armor rating is better than the character's and that character's ship

has the initiative that turn (presumably, the helmsman or captain will maneuver the vessel so that its bulk provides some protection against enemy fire);

- A large weapon (catapult, ballista, etc.) that misses a human target can still inflict damage on the ship. Roll for a hull hit, but damage is always 1 hull point maximum;
- Magical armor, Dexterity, and circumstance can affect crew THACOs as in normal combat.

Hard and soft cover rules, if being used by the campaign, may also affect damage.

Hit Points

When a bolt or volley of fire hits a living target, damage is inflicted as per normal AD&D® rules. If the damage is severe enough, then the "instant death" rule is applied, forcing a saving throw against the attack.

Hull Points

A ship's hull points are like a character's hit points—when they are reduced to 0, the ship begins to break up. Large weapons inflict their listed damage. Damage can be repaired given time and money (see Repairs).

Small weapons can inflict hull point damage as well. For every 10 cumulative hit points of damage inflicted on a ship, the ship takes one hull point of damage. The damage must be to the same exact location (a volley of 20 arrows that sticks in the side of a ship and inflicts a total of 60 points of damage causes no damage to the ship's hull; each arrow hit a different spot. A character chopping at the hull with an axe, however, could inflict hull damage).

When a ship's hull damage exceeds half of its hull points, the ship immediately suffers a critical hit.

Critical Hits

Critical hits vary from ship-threatening results of combat to less-dangerous situations which impair the functioning of the ship. Only large weapons can inflict critical hits outright, but sufficient application of small weapons (the dwarf on the hull with a battle axe) could weaken a ship sufficiently to push it past the 50% damage point and thereby cause a critical hit.

When a critical hit is called for, roll on the table below and apply the result. If the result is inapplicable ("Hah! You can't destroy the spelljammer helm! You blew it up last turn!") shift up to the next higher entry on the list.

Roll	Result
1	Loss of 5 Hull Points
2	Deck Crew Casualty
3	Interior Crew Casualty
4	Ship Shaken
5	Large Weapon Damaged
6	Deck Crew Casualty
7	Hull Holed
8	Maneuverability Loss
9	Loss of 10 Hull Points
10	Ship Shaken
11	Fire!
12	Loss of SR
13	Deck Crew Casualty
14	Large Weapon Damaged
15	Ship Shaken
16	Hull Holed
17	Maneuverability Loss
18	Loss of 10 Hull Points
19	Loss of SR
20	Spelljammer Shock!

Definition of Effects:

Loss of 5 or 10 Hull Points. This loss is in addition to the initial damage. In some cases it may cause the ship to break up or force another critical hit check. Multiple rolls for the same attack are cumulative.

Deck Crew Casualty. One exposed crew member is struck and suffers the same damage as the ship.

Choose the target randomly from exposed crew. All characters within 5 feet of that individual must make a saving throw against death or suffer the same damage.

Interior Crew Casualty. Same as Deck Casualty, but everyone aboard is a potential target, including prisoners, the captain, and spelljamming mages. This reflects not so much the effect of the missile itself, but shattered parts of the ship's interior bouncing around during combat.

Ship Shaken. Ship rings from the blow of the attack. All characters not sitting or otherwise firmly tied down (the spelljamming mage is considered secure) have a chance to fall to the deck, disallowing any attacks or spell use that round. NPCs have a flat 40% chance of falling as a result of this critical hit, while PCs (and those NPCs important enough to rate their own Dexterity) must make a Dexterity check to maintain their balance.

Large Weapon Damaged. One large weapon (chosen randomly) is inoperable until repaired (see Repairs). Its crew is unharmed.

Hull Holed. The attack punches a hole in the ship where there was none before. The DM chooses which part of the ship is holed (either by random roll, according to the situation between the ships, or whatever would make things most interesting at that point).

Fire! A fire starts somewhere in the ship, determined by the DM. The effects of fire aboard ship are described below. In cases where it is physically impossible for a fire to start (all the lights are magical, there is nothing flammable onboard, and everyone is wearing clothes made of rock), go to the next entry. A fire onboard as a result of this critical hit (as opposed to greek fire or magic) inflicts no damage the first round, but may spread.





The sphere is a perfect shape, the shape that shrinks its plane of gravity to a single point at its heart, attaining a perfect balance.

The simple fact is that no one knows save perhaps the gods, and if they know, they aren't telling. There may be system shells out there that are cubical, or ellipsoidal, or even irregularly or torus-shaped. We just haven't reached them yet.

And when we do, we'll probably start the sages arguing all over again.

—From *Elminster's Musings on Empty Space*, a scroll from *Elminster of Shadowdale* to Lord *Khelben of Waterdeep*.



Loss of SR. The SR of the ship drops by 1 point for the next 1d10 rounds while the helmsman readjusts his balance and senses to the new damage level. Additional losses are cumulative, to a minimum of 1 SR. If a ship with an SR of 1 receives this result, go to the next entry.

Maneuverability Loss. The ship drops one MC for 1d10 turns. An A class becomes B, a B class becomes C, and so on. A class F ship cannot lose any more maneuverability so the next entry is taken instead.

Spelljammer Shock! The spelljamming mage must make a saving throw versus spells or fall immediately into a coma which lasts 1d4 days. In cases of serial helms, all creatures linked up must save. In case of foundries, artifurnaces, furnaces, and "unknown drives" (such as the neogi's), the drive itself is rendered nonfunctional 1d4 days (no saving throw allowed). If no replacement is available and the mage fails his saving throw, the ship immediately becomes SR 0 and can only move in a straight line at its present speed.

Multiple Critical Hits

One attack may cause a critical hit, which in turn causes enough damage to inflict another critical hit. All damage must be applied to the ship, and it is all cumulative.

Breaking Up

If a ship is reduced to 0 hull points, its internal structure is destroyed and it begins to fall apart. Roll a six sided die for every 10 tons of the ship (round fractions up). That is the number of large (atmosphere-retaining) pieces of the ship that are left.

Some victors will sift through such debris looking for prisoners. Others will abandon them. It is possible for survivors to lash up some sort of vessel from the junk to save themselves with a temporary helm or spelljamming mage.

Effects of Crew Losses on Ship Performance

The less manpower a ship has, the less capable it is of fighting and sailing effectively. A ship may still handle itself in "reduced" circumstances, but not with the effect of a full crew.

Large weapons require a minimum crew to fire properly. For each member missing out of a large weapon crew, the weapon takes one round longer to reload and fire. A weapon crewed by three men with a reload rate of 1/3 will take three rounds for three men to reload and fire, four rounds for two men to reload and fire, and five rounds for one man to reload and fire. Men that are lost during the reloading are considered as if lost at the start of the reloading—that is, three men start reloading the above weapon, then one man is lost as a casualty, then the remaining men will need four full rounds (including those that have already passed) to reload and fire.

Large weapons can be reloaded and fired as long as one man remains available to do so. A large weapon without a crew cannot be fired. If a weapon is partially loaded, then the crew is slain and a new crew arrives, the loading must begin again.

Loss of crew affects the maneuverability of a ship as well. The minimum number listed for the crew indicates the number required for operating the ship at its listed maneuverability class and does not include weapon crews. If less than that number are available to operate the ship, set the sails, man the oars, etc., then the ship is downgraded in its maneuverability class. This loss may be from casualties, or may be because handling crew has been reassigned to weapon crews, preparing for boarding, or fleeing the ship.

If the crew is less than its listed minimum but more than half that number, the MC of the ship is downgraded by one class.

If the available crew is one-half or less of its listed minimum but more than one-fourth that number, the MC of the ship is downgraded by two classes from its original value (this usually means it is downgraded one more class, since by this time it is probably operating one class lower than its original class anyway).

If the available crew is one-fourth or less of the ship's listed minimum, the MC of the ship is downgraded 3 classes from its original value.

A ship will operate at three classes below its original class as long as there is at least one crewman left to handle the rigging and someone at the helm. The MC of a ship may not be downgraded beyond F maneuverability class.

When figuring out how many crew members are available, PCs and officers are excluded, though they may be pressed into service to handle things during a battle emergency. Normally, however, their activities prevent them from taking an active role in the more mundane aspects of handling the ship, even in the heat of battle.

When calculating halves and fourths for manpower requirements, round fractions in the players' favor. The breakdowns for a ship with a 10-man minimum crew, for example, would be:

10 crew	Full MC
6-9 crew	Down one MC
3-5 crew	Down two MC
1-2 crew	Down three MC

A ship that is breaking up stops moving. The hex it occupies and all hexes surrounding it are filled with debris. Surviving characters are considered to be in the last hex occupied by the ship.

Debris

Debris is a common consequence of battle, but in addition there are often small asteroids, comets, and other space flotsam that can interfere with the movement of and combat between ships. Debris of sufficient mass will cause a ship moving at high velocity to slip into normal movement.

Ships moving through debris-strewn hexes do so at risk. Those moving one hex per turn can do so normally and without danger. Those moving through at speeds of two or three hexes per turn suffer the attack of a small jettison, while those moving at a speed of four or five hexes per turn suffer the attack of a medium jettison. Anything moving faster than five hexes per turn suffers the attack of a large jettison. These attacks occur once per debris hex entered.

Fire

Whether as a result of a critical hit, a device such as the greek fire projector, or spells such as *fireball*, fires sometimes get started on ships.

Fires inflict their initial damage the round they start. On each subsequent round, the fire inflicts the same damage as on the round before, plus one point.

Putting out a fire requires one person for every point of damage the fire will cause that turn. For example, if a fire will inflict three points of hull damage on this ship this round, then three people working with proper tools (assumed to be present) can extinguish the blaze. If not enough people are available to put out a blaze, they can reduce its severity by their actions. If two people fought out three-point fire, then the fire would be reduced to a one-point fire at the end of the round (and then increase to a two-point fire at the beginning of next round).

The greatest danger from fire is its potential to poison the air envelope. Once a fire has damaged 10% of the tonnage of a ship (total damage, not in a single round), the air is degraded one step (from fresh to fouled, from fouled to deadly). If the damage reaches 40% (without the ship otherwise breaking up) the air envelope degrades again, with all effects of the change affecting the crew.

A ship reduced to 0 hull points by fire breaks up normally to form a field of debris. The surviving debris (if on fire) will continue to burn and break up until the disintegrating chunks are completely consumed. Ships entering the debris field while it is still burning will suffer the effects of the Fire critical hit.

Fields of Fire (Optional Rule)

While the portrayal of combat here is two-dimensional, in reality, a ship could be tilted in any direction without affecting the occupants. As a result, almost any weapon can be brought to bear against an attack from any direction. The limitations on this are for weapons that fire to the bow and stern, including forward-facing catapults and rear-mounted jettisons.

Nonmovable weapons designed to fire toward the front and rear of the ship may only fire at targets that are within the lines set up by the three frontal (or rear) hexes. They in addition receive a +2 to their THACO to hit targets directly in front (for front-mounted weapons) or directly behind (for rear-mounted weapons). This is due to the "stability" of the shooting platform (as much anything whirling through space can be considered "stable").

Morale (Optional Rule)

No one likes to die, particularly in space with a long walk home. For



Common Ship Commands

(Or, things the captain bellows and expects everyone else to understand.)

STEADY—Maintain heading and speed.

FULL AHEAD (number)—Maintain heading, increase speed to given number.

BEAR PORT—Turn one hex side to the left.

HARD PORT—Turn two hex sides to the left as soon as possible.

BEAR STARBOARD—Turn one hex side to the right.

HARD STARBOARD—Turn two hex sides to the right as soon as possible.

FULL ASTERN—Back up as fast as possible.

ALL REST—Stop.

HULL STRIKES—Fire at enemy hull.



this reason, morale can be important in combat. If you can convince a ship's captain (or more importantly, a ship's crew) to either call off their attack or surrender, you are winning a victory without risking your own ship and crew.

A crew of typical seamen has a morale of 11. Monstrous crews can have higher or lower morale and other factors (including how well the captain is liked) also have an effect.

Morale checks are made at the conclusion of a round of battle, after all actions have been resolved.

A morale check is required for a ship's crew when:

- The ship suffers a critical hit.
- The ship has only 5 hull points left (unless the ship started with less than 10, in which case ignore this situation).
- The crew has been surprised (but only on the first turn after being surprised).
- The ship is faced by an obviously superior force.
- An ally or crewman is slain by magic.
- 25% of the crew have been eliminated.
- 50% of the crew have been eliminated.
- A companion or crewman is slain after 50% of the crew is eliminated.
- All officers desert, are slain, or surrender.
- The crew is fighting a creature they cannot harm due to magical protection.
- The crew is asked to perform heroic (and dangerous) tasks.
- The crew is offered a bribe.
- The ship's crew is covering a fighting retreat.
- A member of the crew is asked to use a personal magical device with charges.
- The crew has met the conditions of another morale check and is given the opportunity to surrender.

- It is apparent the ship cannot escape.
- The ship's captain is slain.

Situational modifiers may also affect the morale check itself:

Ship has taken 25% hull damage	-2
Ship has taken 50% hull damage	-4
Ship has taken 75% hull damage	-6
Captain is slain	-2
Spelljamming mage or priest is slain/destroyed	-3
Opponent firing has taken 50% damage	+2
Captain is on deck	+4
First Officer is on deck w/o captain	+2
Ship is on fire	-2
Opponent's ship is on fire	+1
Opponent's ship has been holed	+1
Abandoned by friendly ships	-6
Creature has lost 25% of hp	-2
Creature has lost 50% of hp	-4
Crew losses at 25%	-2
Crew losses at 50%	-4
Crew is receiving a share of plunder	+2
Creatures are fighting hated enemy	+4
Ship's crew was surprised	-2
Crew fighting magical creatures	-2
Creatures have 1/2 HD or less	-2
Creatures have 1 HD or less	-1
Creatures have 4 to 8+ HD	+1
Creatures have 8 to 14+ HD	+2
Creatures have 15+ HD	+3
Defending home (if ship is lair)	+3
Defensive terrain advantage	+1
Multiple checks per round	-1
Captain is of different alignment from crew	-1
Most powerful ally killed	-4
Crew favored by captain	+2
Crew poorly treated	-4
No enemy have been slain	-2
Crew outnumbered 3 to 1	-4
Ship outnumbered 10 to 1 in tonnage	-2
Outnumber other crew 3 to 1	+2
Ship outnumbers opposition 10 to 1 in tonnage	+2
Unable to hurt opponent	-8
Magic-using creature on same side	+2



The effect of a failed morale check is largely up to the DM, but the most common result is to “Strike the Colors”—that is, to surrender. In some situations, the attacker might let the defender limp away. In others the ship will at least be boarded, a ransom will be levied for the ship’s passage or passengers, the ship will be looted of cargo and/or towed back to a base. Civilized races tend to treat their defeated foes honorably. However, there are many creatures who do not.

Because morale is checked at the end of the round, it is possible for all ships on both sides of a conflict to “strike their colors” at the same time. In this case all ships break off and will not resume combat for at least two hours (this is only an average and can vary according to the availability of healing spells, presence of charismatic leaders, or other factors).

If a ship that has struck its colors has PCs aboard, it is up to the players to decide whether to pursue the fight or not. A ship that has struck its colors will not use its NPCs to fire weapons or board, but the PCs may do so. If a player character is at the helm, he may continue moving the ship.

However, be warned. A ship that has struck its colors only to attack again is generally accorded no mercy by other ships. An NPC crew will mutiny immediately against a captain or officers who pursue the fight after a surrender, since this only puts their lives at even greater risk (if they are ultimately defeated, the enemy is likely to simply maroon them in space, or worse).

Short-Range Combat

When a ship enters the same hex as another ship, short-range combat

can occur. The attacker has the option of firing any hand-held weapons or large weapons (except catapults). Following his attacks, the player whose hex he entered has the option of making any missile, large weapon, or magic attacks. Following this, if there are any other ships in the area, they have the option to fire as well.

After all weapons are discharged, the moving player may ram the opponent if he has initiative, grapple, or board the opponent. If he chooses to do none of these, then the opponent has the opportunity to grapple or board. Ramming attacks are allowed only to the side that has the initiative.

Missile Fire at Close Range

For the sake of simplicity, all hand-held missile fire is considered to be at medium range if both ships



CREW STRIKES—Fire at enemy crew.

ALL STRIKES—Fire as all individuals see fit (also used to cover specific pre-planned fire patterns, such as “Everybody fire at the wizard”).

HOLD FIRE—Stop firing.

PREPARE TO RAM—Ship is ramming this turn if it can.

PREPARE TO BOARD—Ship is grappling and boarding this turn if it can.

PREPARE TO REPEL BOARDERS—Ship is about to be grappled or rammed; be ready for it.

HELM DOWN!—We’ve lost the spelljamming mage, either to death or system failure. Someone else get down there right away!

FIRE IN THE HOLD—General term for ugliness below decks: includes fire, being holed, being boarded through a hole, or damage to a nasty section of the ship.



are in the same hex (their air envelopes probably, but not definitely, overlap). When ships come into contact with each other, the range shifts to short.

Short and medium-range combat is resolved the same as long range combat, but now hand-held missile weapons (and not large weapons) can hit individual targets on the opposing deck. (Typical orders for any crew, whether at sea or in space, are “Shoot at anyone who looks like a wizard.” Of course, this often means that the man who looks like a wizard really isn’t.) Large weapons are limited to aiming at areas of the enemy deck and then take their chances at hitting whatever might be there.

Personal weapons cause one point of hull damage for every 10 points inflicted to the same, exact location.

Magic at Close Range

All spells with a range greater than 100 yards can be cast on another ship in the same hex. Spells with ranges less than 100 yards can be cast on enemy (or friendly) ships only when they are obviously within 100 yards (such as when they are grappled and being boarded).

Magic which inflicts damage in points has the same effect as personal weapons. For every 10 points of damage inflicted by a spell that is directed against a ship, it inflicts one point of hull damage. A 10-HD fireball which causes 30 points of damage inflicts 3 points of hull damage (and starts a fire, if possible).

Spells which do not inflict points of damage can still harm a spelljamming craft. A *disintegrate* spell cast on a ship’s bow, for example, results in a Hull Holed critical hit. A *dispel magic* cast on the spelljamming helm causes it to malfunction for one round, temporarily reducing the ship’s SR to 0. A *warp wood* may weaken a few boards but causes no

hull damage; alternatively, it could destroy an enemy ballista.

Ramming

Ramming is a common tactic in space for damaging or breaking up an enemy ship. Ramming is best performed against other ships that are of roughly the same tonnage or smaller.

A ship must announce its intention to ram before initiative is determined. The process of ramming (steering to hit the opponent’s ship, plus battening down all the loose gear for the impact) requires time, and is not something that can be done on the spur of the moment.

A ship cannot ram another ship that is in the same hex at the start of the turn, unless it leaves that hex and reenters it later. A ship cannot ram another ship that is grappled with it.

A ship may only attempt to ram once in its turn. It cannot attempt to ram a vessel once, miss it, then ram another vessel in the same or an adjoining hex.

When ramming, use the helmsman’s THACO (compared to the target ship’s armor rating) to determine if the ramming is successful. In this case it is often better to have a priest at the helm than a wizard because of their better chance to hit (a priest can run a ramming attack even if the ship is equipped with a piercing ram). If a ship has no one individual at the helm (such as the dwarven foundries), then the ship rams with the THACO of its navigator, treated at half his level.

Rams inflict different damage according to their type and size.

Piercing Rams inflict one point of hull damage for every 10 tons of the ramming ship times the number of hexes the ship moved in a straight line prior to ramming (up to its maximum SR). Round fractions up.

In addition, a ship struck by a piercing ram automatically suffers the Hull Holed and Ship Shaken critical hits.

If a piercing ram is used in combat, there is a chance that the two ships will become locked together. This chance equals 5% times the target's tonnage. No additional damage is inflicted, but the ships are considered grappled. They cannot separate until the helmsman from either ship successfully makes an attack roll to pull them apart.

Blunt Rams inflict one point of damage for every 10 tons of the ship making the ramming attack (round fractions up) times the ship's maximum SR. The opposing ship suffers a Ship Shaken critical hit and one other critical hit, determined randomly (more if damage demands it).

Grappling Rams inflict no damage, regardless of size or speed. If a ship with a grappling ram strikes another ship, the two ships are considered grappled (see below).

Movement After Ramming

If the ramming ship misses its target or reduces the opposing ship to 0 hull points (so that the opposing ship begins to break up), the ramming ship may continue its movement up to its regular limits. If the ship hits its target without destroying it or is locked or grappled with the target, its movement stops.

Ship crews may grapple in the same round as a ram, if so desired.

Size and Ramming

Ramming works best against ships that are the same size as or smaller than the ramming ship. In certain cases, an opposing ship may be too large or small to be rammed by a particular ship.

A ship cannot ram another ship that is 10% or less of the ramming

ship's tonnage. For example, a 100-ton ship cannot ram a ship of 10 tons or less. If such a ram is attempted, the smaller ship must check for a crash (see below).

A ship may not ram another ship that is more than three times its tonnage. If it attempts such a move, it must check under Crashes.

The exception to this is when using a grappling ram, which can be used against smaller targets of any size (but only three times larger targets).

Ramming and Ship Positions

In general, a ship ramming another ship will maintain its positional relationship after the collision. That is, a ram from the bow will strike the opposing ship on its bow, a ram from the flank will strike the opposing ship in the flank, etc. Let the situation dictate the relative positioning of the ships.

Head-On Ramming is a special case. Head-on ramming is a dangerous situation, as it exposes the ramming ship to the ram of the opposing ship, should one be carried. If the attacking ship hits its target, the ram is handled normally. If the ramming ship misses its target, the opposing ship has the opportunity to ram its attacker immediately. This is the only time a ship is allowed to ram without having the initiative. In this situation, the original target ship uses its speed from the previous turn when determining damage (this is a reactionary move, so the ship has not had the chance to reach full, ramming speed).

Ramming Gargantuan Creatures

In general, living things cannot be effectively rammed (they are too small). Creatures of gargantuan size, however, are large enough that a ram would have an effect. Gargantuan

creatures take 1d6 points of damage for every hull point inflicted by the ram. Therefore if a ram which would normally inflict 4 hull points was to be used against a space wyrm, the ship would inflict 4d6 dice of damage.

Crashes

When two ships occupy the same hex, there are four possibilities:

- They can crash into each other;
- One ship can ram the other;
- One ship can land on the other;
- The two ships can align courses or simply pass each other.

This section deals with crashes.

Occasionally a ship will make a sudden, unplanned landing (called impact) against a larger object. This impact usually has disastrous results for the ship making the crash and the ship that is being crashed into.

The helmsman makes a save vs. death to avoid a crash and if successful can either fly off (in his part of the turn) or land normally on the other ship or object. A vessel with no one controlling its flight save as a 1st level wizard.

This saving throw is modified according to the ship's maneuver rating, as follows:

Maneuver Rating	Modifier
A	+8
B	+6
C	+4
D	+2
E	0
F	-2

If there is a crash, the smaller ship is always assumed to be crashing into the larger ship, regardless of the overall tactical situation. The hull points of the crashing ship are reduced by half their total original value. If the hull points of the ship are reduced to 0, the ship breaks up (usu-



STRIKE THE COLORS—
Surrender.

HAIL—No hostile moves; we're opening communications.

FULL EVASION—Let's run away from these guys.

BATTLE EVASION—Spin the ship along its long axis. It has a problem in that everything is -1 to hit, but the ship itself is -1 to be hit, and all specific strikes are at -4.

JETTISON AWAY—Fire the jettison (or all jettisons).

CATAPULT AWAY—Fire the catapult (or all catapults).

BALLISTA AWAY—Fire the ballista (or all ballistas).

&%*#\$/—Standard reaction to combat results.



ally all over the gravity plane of the other ship). All on board the crashing ship must make a saving throw vs. death magic or take 6d10 points of damage (save for half).

A ship that is crashed into takes damage equal to the hull points of the ship that crashed into it at the moment when the crash occurred. When a ship with 15 hull points left out of 30 hits a 50-hull-point ship, it inflicts 15 (not 30) hull points of damage. Individuals on the ship being hit suffer the Ship Shaken critical result.

Crashing is not a situation that many captains look forward to, but in combat there is often a need for "fire-ships" and other suicidal tactics where sacrificing a ship may help turn the battle. The crew of such a ship usually abandons it before the crash, hoping to survive a "fall" to the surface of the other ship rather than die in the crash.

Shearing Attacks

A shearing attack is a close pass against an opposing ship with the intention of dragging rigging, steering equipment, and other devices overboard to cripple the ship's maneuverability.

Similar to ramming, the attacking helmsman's THACO is used to determine whether the shear is successful. For ships without a spelljamming helm, the navigator performs the attack at one-half his actual level.

A shearing attack reduces an opponent's maneuverability class by one rating—from B to C, for example. A ship may only have its maneuverability class reduced twice by shearing attacks, though it may suffer additional losses from critical hits and other attacks.

If a shearing attack fails, the opposing ship has the option of immediately launching its own shearing attack against the original attacker.

Shearing attacks inflict no points

of damage to the target ship's hull, but if a 20 is rolled for the attack, a critical hit results.

Grappling and Boarding

Often it is desirable to take over an opponent's ship without inflicting major damage. In cases like this, a side with enough manpower can overwhelm the other side by grappling and boarding. Certain types of ramming may also result in a grappling situation.

Either side can grapple, but the moving ship has the first opportunity. The purpose of grappling is to bring the two ships together to allow either towing or boarding.

The most common method for grappling is a large hook at the end of a long rope or chain. There are also ballista bolts which are similarly equipped and can be fired into the opponent's hull. In either case, once the hooks have caught hold, the two ships can be hauled together.

A grappling hook requires about 5 feet of space from side to side to be thrown at another ship in the same hex. The number of hooks that can be thrown depends on the length of the ship making the attack and how many hooks it can bring to bear.

Two ships are considered grappled when the number of lines between them is at least equal to one-tenth of the tonnage of the smaller ship. For example, a 50-ton ship and a 30-ton ship are grappled if they are connected by three or more grappling lines. If there are fewer lines than this connecting the two ships, either ship can break them all simply by moving out of the hex. (This is a good way to pick up some free grappling hooks.)

A grappling attack inflicts no damage but links the two ships together. Both ships are immobilized once they are connected by sufficient grappling lines (unless one ship tries to tow the other; see Towing).

Cutting Grapples. A crewman must make a normal attack roll to hit AC 10, then roll his damage to cut a grappling line. A line has 5 hit points. Grappling chains are AC 4 and have 20 hit points. Grapples may be cut at any time in the defender's turn, but often the ship has been boarded by then.

A ship may be boarded in the round after it is grappled. Any characters standing at the gunwale at the beginning of the round can swarm aboard the enemy ship (that is, boarders must be standing by and ready to board.)

Combat when boarding is standard AD&D® combat. If players and DM agree, the rapid combat resolution system described below can be used to resolve large numbers of NPCs fighting.

A crew (either side) will fight until defeated or it fails a morale check; then it surrenders. Player characters and important NPCs (determined by the DM) may fight as long and as hard as they wish, even to the death. Morale checks are used only for two-dimensional NPCs.

In very dangerous situations, a morale check should be made to see if the crew will board in the first place (attacking a ship full of mind flayers is a risky proposition even under the best of conditions). Such a morale check would be made after the orders are given but before they are carried out.

In case of a failure of morale, the crew will retreat back to its native ship. If the crew is on its native ship, it will surrender (unless it is checking morale to determine whether it will board, in which case the crew just refuses to attack). In certain cases (such as dealing with villainous neogi, who are merciless), they will fight to the death.

Rapid Resolution of Small-Scale Combat

There will be situations, such as a crew all stocked by PCs, where the actions of every character are important. Similarly, there are situations where a long, large-scale combat between conflicting sides of NPCs will just waste the players' time. The following system can be used to resolve combat between large numbers of essentially featureless NPCs.

It is strongly recommended that player characters not be factored into this procedure, for two reasons. First, PCs should be directly under their players' control. They should not simply be part of a mathematical process. Second, if the PCs are very much superior to their crew members, they will tip the scale toward the high end and throw off the results. This system works best with crew members who are all pretty similar. If the crew contains widely disparate members (minotaurs and hobgoblins, for instance), it is best to treat them as two separate groups and determine their attacks and casualties separately.

Figure out what is the "average" crew member on both sides. There are two ways to do this. The quick way is to look at the NPC stats and see what number of hit dice, armor class, and weapon is most common and then assume that everyone in the crew has those same characteristics. The second is to figure out a statistical average: total all the hit dice and then divide by the number of crew members, then do the same for armor class, and again for weapon damage. Round fractions off toward the nearest whole number (round 1/2 up).

Compare these two "average" crew men and determine their attack numbers.

Then divide the total number of attackers by the average defender's hit





Nonstandard Systems

The system presented, with planets moving around a single central point, is common in 90% of the systems encountered in the phlogiston. There are other types, including:

STATIONARY—The planets and other orbiting bodies are literally fixed points in the sky, unmoving in their relationship with the primary. The planets, once placed, do not move.

CHAOTIC—The planets and other orbiting bodies do not stay in their orbits, but rather move like ships, able to cross orbits and enter new orbits at will. When moving a chaotic planet, choose from the spaces available and roll randomly, starting with the innermost planet and moving outward. A chaotic planet will never move into a square containing another planet (or else there would be



dice. This determines how many d20s the attacker will roll (in effect, how many attacks they get per round). Do the same for the defender, dividing the total number of defenders by the average attacker's hit dice.

Each round, both the attacker and defender roll their attack dice. Every hit kills or incapacitates one character from the enemy ship.

The attack dice can be halved or doubled for special circumstances. Double a side's attack dice if its average maximum damage is greater than 12 or the average crew member has some sort of special attack that can incapacitate with a single hit, like paralysis, poison, a gaze weapon, etc. Halve its number of attack dice if the average maximum damage is less than 6.

As casualties are inflicted, the number of dice that each side rolls must be recalculated. Attacks are resolved in the order of initiative and are not simultaneous.

Example: A privateer manned by a mixed crew of humans and dwarves overtakes a mind flayer nautiloid that has been attacking human outposts in the area. After a pitched space battle, the privateer manages to grapple the nautiloid and a very brave boarding party swarms onto the enemy ship. Sixteen humans and twelve dwarves board the marauder. They charge below decks and are met by a force of seven mind flayers prepared to defend the ship.

Mind flayers: AC 5, HD 8+4, Max Dam 8+death

Humans: AC 4, HD 1, Max Dam 6

Dwarves: AC 4, HD 1, Max Dam 8

The average of the human/dwarf attackers is AC 4, HD 1. Their actual damage per attack does not matter as long as it's between 6 and 12. The mind flayer defenders are AC 5, HD 8+4, with an instant death attack.

Fortunately, the attackers win the initiative on the first round. The DM rules that in the narrow confines of the ship, only three attackers can fight each mind flayer. The attackers get to roll three dice (21 attackers divided by 8 hit dice per defender) and need to roll 14 or higher to hit. They roll one hit and two misses, cutting the defenders down to six. The mind flayers get to roll 12 dice (6 defenders divided by 1 hit die per attacker, doubled because the mind flayer's special attack can kill automatically) and need to roll 9 or higher to hit. The mind flayers roll seven hits and five misses.

Going into the second round, the mind flayers win the initiative. They roll 12 dice again, this time scoring six hits and six misses. The human/dwarf attackers have suffered 13 casualties, reducing their numbers to 25. This is still enough to put three attackers against each of the six remaining mind flayers, so they roll three dice again and score two hits and one miss.

At the end of the second round, the attackers have lost 13 casualties and the mind flayers have lost three. But the attackers knew they were facing mind flayers and expected heavy losses. If the battle continues on its present course it will be a close affair, with the odds slightly in favor of the humans and dwarves.

Casualties: Using this system, casualties can be apportioned however the player sees fit. Losses must be taken from crew members who are actually involved in the fight, however.

At the end of the fight, roll 1d6 for each side and multiply the result by 5%. This is the percentage of casualties from that side who were not killed or mortally wounded, but only incapacitated. Survivors on the winning side can recover. Survivors on the losing side can be taken prisoner or dealt with in some other manner.

Other Considerations: The same procedure works equally well for archery and other light missile fire.

If one side can only be hit with magical and/or silver weapons and the other side does not have such weapons, then only the latter group will suffer casualties.

Fights between very different types of creatures probably should be handled with the normal combat rules. Powerful beings are at a disadvantage under this simplified set of rules.

Towing

A ship that has been grappled may also be towed. Both ships are considered to be part of the same larger ship; their tonnage is added together to determine if a spelljamming helm or other device can move the whole mass.

Only the stronger of the two spelljamming devices will function when the ships are linked, so that the weaker item will be inhibited until all the lines are cut. "Strength" is determined by the ship's current SR. A large ship with a low SR may suddenly find itself being dragged through debris fields by a smaller but more SR-powerful ship. If the SRs are equal, then neither ship may move as long as both helms remain in working order.

Encounters, Evasion, and Running Away

Given the nature of space movement, an opposing craft may appear suddenly in the distance, then slow to combat speed almost immediately. Since it is the nature of the spelljamming helm to stop when it nears the gravity plane of another body, many encounters will occur without the desire of either side.

The opposing ship(s) will appear 11-20 hexes away (1d10+10) in a

random direction determined by rolling 1d6:

- 1 Directly Ahead
- 2 Ahead & Right (Starboard)
- 3 Behind & Right
- 4 Directly Behind
- 5 Behind & Left (Port)
- 6 Ahead and Left

Heading is usually toward the player's ship, though the DM can determine this if he desires.

After the initial placement of the ships, there is no surprise roll. Some ships (such as pirates) which travel with loaded ballistas may have a tactical advantage against opponents. However, there usually are several rounds of maneuver before ships come within effective weapon range of each other.

Use the Encounter Reactions table on page 103 of the *Dungeon Master's Guide* to determine the reactions of the individuals, unless those reactions are previously determined by the DM (for example, a ship filled with raging xenophobes tends to not be friendly under any circumstances). A good rule of thumb to determine intentions is to use the following guidelines:

Friendly: Large weapons unloaded, crew not carrying personal weapons.

Indifferent: One of the large weapons loaded, but crew unarmed.

Threatening: All large weapons loaded.

Hostile: All large weapons loaded, crew packed to the gunwales and armed to the teeth, shouting for blood.

It is possible to make a situation appear less threatening than it is through the use of illusions, concealed weapons or crew, etc. The DM is encouraged to be as devious as necessary.

Sometimes discretion is the better part of valor, and he who fights and

runs away lives to run another day. Unfortunately, when one is close to another large body (such as a ship or planet), the spelljammer helm will not permit the ships to reach sufficient speeds to make high speed travel worthwhile.

The times listed under Takeoffs and Landings reflect the amount of time it takes to clear a planetary surface in order to attain high speeds. For smaller bodies (such as errant asteroids and pirate ships), the "capture" distance is 25 hexes on the map, counted at the start of the ship's movement. That is, if there is nothing within 25 hexes of the ship (including debris fields and asteroids) at the start of its movement, the ship can accelerate to interstellar speed and leave the map. The ship can maneuver before this acceleration, but once the player declares his intention to accelerate he cannot turn the ship again. The ship is simply picked up and removed from the map.

A faster ship can usually outdistance a slower ship so that such escape is possible, but often a slower but more maneuverable ship can put an opponent far enough out of the way that it can reach the 25-hex radius and escape. More likely, the fleeing ship often unloads a few potshots or jettison loads before escaping in the hope of either damaging something that will prevent pursuit or slowing down the pursuer.

Pursuit

A determined pursuer can often follow an evading target even at high speed. Because the SR of a ship matters little when moving at the speed of 100 million miles per day, a slower ship can keep pace with a faster one if the captain is clever enough.

Since both ships are moving at very high speed, when one ship stops the other overtakes it almost immediately and stops as well, if that it passes within 1,200 yards. Aiming



nothing in the sphere but debris).

DEBRIS FIELDS—Chaotic planets which have rammed into each other, leaving an enormous field of cosmic debris. The entire sphere is considered an asteroid belt.

SEMI-RANDOM—When moving a planet, check to see if it moves inward (toward the primary) or outward (away from the primary) in this move. On a 1-2, the move is inward, on a 9-10, outward.

OPPOSING REVOLUTIONS—In most cases, the planets move in the same direction (DM's choice). In systems with opposing revolutions, each planet may move in one direction or the other (roll 1d6 when setting up the system: 1-3, clockwise, 4-6 counterclockwise).

SMALL SYSTEMS and other special worlds—Some systems are smaller than normal planets, contain one planetary body, or otherwise are



the pursuing ship this precisely is the department of the ship's navigator.

Make an Intelligence check for the ship's navigator, modified by +2 if he has the Navigation proficiency. A successful check results in the correct angle being chosen. A failed check results in the pursuer heading off in a slightly wrong direction, but over millions of miles of distance, even a slight error will cause the pursuing craft to miss its prey.

Time is important in pursuit. For every round of delay since the departure of the first ship, add 1 to the navigator's Intelligence check die roll. After two turns of delay, a ship is irretrievably lost.

When pursuing, the trailing craft does not know if it is on the same track as its quarry unless the crew is aided by magical means. Depending on the situation, a pursuing ship may lose interest in the chase quickly or hang on until the lead ship reaches its destination or another encounter which will slow it down.

Small shot like a jettison load will not stop a pursuer, but does have a 5% chance of hitting at high speed. If the pursued ship cuts loose a mass of at least 10 tons, the opposing ship will be slowed by its encounter with the dropped material. A towed ship or one of the elvish moth-ships is often used this way. (Of course, once that mass is free of the towing ship, that ship slows down also. There is a net gain, however, because the lead ship can accelerate once it is 25 hexes away from the mass. The pursuing ship will stop 11-20 hexes short of the mass and must pass it before accelerating again.)

If the fleeing ship slows down for some reason, then the pursuing ship will appear (as a normal encounter) in the same number of rounds as when the pursued ship disappeared. If it took two rounds for the pursuer to follow, it will appear two rounds af-

ter the lead ship stops. Ships trying to evade pursuit will often use such a lead to stop, turn, and flee in a new direction, hoping to be gone on a new course before their pursuer arrives.

Repair

Spelljamming ships are remarkably easy to repair—their only unreplaceable parts are the helm (or other spelljamming device) and the people who crew them.

In most civilized areas, one hull point can be replaced or repaired at a cost of 2,000 gp in one day by a crew of five trained workers. For every additional five workers (and 2,000 gp), an additional point can be repaired.

If a ship is very badly damaged (more than 50% of its hull points lost), the cost goes up to 5,000 gp per hull point repaired. The repairs still require five workers but take three days of work.

Poor (or cheap) characters can repair ships themselves. A crew of five individuals, with the correct materials, can repair one hull point in a week in space. Materials can be acquired by buying them at a groundling city (at an approximate cost of 50 gp per hull point worth of material) or just landing on a vacant stand of timber and taking what is needed.

Such repairs are just as good as the expensive ones, provided that at least one member of each five-man crew has carpentry or some other relevant proficiency (repairing a dwarven flying mountain, for example, would call more for stonemasonry). The chance of scoring a critical hit against a poorly maintained ship increases by 1 until the hull points are repaired again by someone with the appropriate skill.

The ships of SPELLJAMMER™ space normally move very, very quickly, covering a hundred million miles per day in wildspace and even greater distances in the phlogiston. In comparison to these great speeds, the planets move incredibly slowly; so slowly that they can be thought as being fixed points on the firmament. A ready comparison is the continents and islands in an ocean, rather than being fixed in place, moving very slowly in comparison with the ships that move about them. In some cases, the planets are fixed, but as a general rule most have some motion.

Map four shows a planetary display for use with spelljamming ships. Due to the scope of wildspace, it is divided into two sections: an inner track for planets orbiting close to their primary (within 300 million miles) and an outer track (for those more than 200 million miles from the primary). A planet or ship can be represented on both the interior and exterior tracks at the same time if its orbital radius is between 200 and 300 million miles.

Each space on the inner track represents 20 million miles. A standard spelljamming ship can move five spaces on the inner track in a single day. Each space on the outer track represents 400 million miles. A ship must travel four days to cross a single space. This dual scale allows all the planetary orbits to be shown on the map. A map of this sort that used only the inner scale would fill an auditorium if it had to show the orbits of Pluto and Neptune in the same scale as Mercury.

The display shows all orbits being circular around a primary point. There are elliptical, oblong, and even square orbits in the SPELLJAMMER universe but a circular representation is the easiest to use.

The primary of a system is usually but not always a star or other ele-

mental fire body. In the case of Oerth (the Greyhawk campaign), the planet containing Greyhawk is at the center of the system and all other bodies (including the sun) revolve around it.

One of the cardstock sheets is an assortment of counters representing planets and for recording planetary data. These can be cut apart and used to show planetary movement and data on the map.

Whether operating under Newtonian physics, riding on the back of giant turtles, or rolling across the velvet of the gods' pool table, most planets behave in a similar fashion, following the tracks presented in this layout. There are systems where the planets operate in a totally chaotic fashion, as well as those where the planets are truly fixed points in the night sky. There are crystal shells so small that they contain only a single world within their universe. But for most planetary tracking, these charts will suffice.

Given the great difference between planetary speeds and spelljammer speeds, planetary motion is not a major factor in determining travel times and positions. For the Solar system (ours), a planet on the outer track moves an average of one space every four years, while those on the inner display move one space every 12 days. Planets can certainly move faster or slower than this (this is fantasy), but unless the DM wishes to deal in more detail with planetary motion, take these figures as standard for the planets.

The planetary display also shows the orbits of the planets of the three major systems of the AD&D® game: Krynn, Toril, and Oerth. These, along with the planetary data provided, show the relative positions of the planets. Characters moving from planet to planet may choose to use the charts provided in Appendix 2 or they may use the graphic display, whichever is more convenient.

Finally, the planetary display has a holding box for additional planetary data. This is useful in showing the three basic statistics of the various planetary bodies (type, size, and shape) in a system. The known worlds of AD&D space have already been described. This information may be shown on the map by the DM. Similarly, new systems discovered by the players can be developed and displayed on this portion of the map. The DM may keep a separate record on the sample system display sheets.

Laying Out the Planets

When the player characters enter wildspace, whether from a planet's surface or from outside a crystal shell, the planets can be set out in their orbits. If the player characters are operating from a planetary surface in wildspace, then they will usually have an idea of the general location of the planets. If entering from outside the crystal shell, they must discover the relative locations of the planets by exploration.

The following system is for showing the positions of the Known Worlds.

Each of the planetary rings is marked with six "starter points" to help determine the location of the worlds that use those paths. In addition, by the "1" starting point there is a note indicating the type of die used to determine the number of spaces the planet is from that starting point. "1d6" means that a single six-sided die is rolled, "1d10" that a single ten-sided die is rolled, and "1d2" that a six-sided die is rolled with 1-3 meaning 1 and 4-6 meaning 2. "0d" means that no dice are rolled. After rolling this placement die, count that number of spaces from the starting point to show the planet's position.

Example: The planet Griffix, in the third orbit ring of its primary on the inner planetary track, is to be placed.



not represented on the standard solar display. These are special cases which the DM may create on his own. Here are a few hints:

- Single flat world, filling a small crystal sphere. In this case a traveler may walk to the edge of the universe.
- Nested spheres, one small crystal sphere within the next, forming a series of "ringed worlds" around a central, unseen hub. Each ring may have its own environments and physical attributes.
- "Stepped worlds" with rising levels of sphere, one within the next.
- Voids without any set level ground.
- One spherical world, wrapped inside a crystal sphere. The movements of the stars and sun are projected on the inside of the sphere from some interior source.



A 3 is rolled on the six-sided die, placing it at the lower left starting point on the map. For the third ring, a d3 is used to determine starting position. A six-sided die is rolled and the result halved; a "5" becomes a "3" for placement. The planet Griffix is placed three spaces clockwise along the third ring from the "3" starting point.

In some cases, a planet is so close to its primary that it falls within the 20 million mile center area. One such example is the primary moon Kule of Oerth. Such a planet has no effective movement and is readily and easily reached by spelljamming vessels. Similarly, close moons of the various planets are not shown in position because they are so close to their own primaries.

The DM can recreate the planetary positions every time the heroes venture into space or he may use the Planetary Display Form provided at the end of this book to keep track of the planets' positions.

Moving on the Planetary Display

When leaving a planet for wildspace, the ship's marker begins its movement in the same space as the planet it started from. A ship leaving Toril, for example, will appear in the same square Toril is occupying on the planetary display. Being placed on the display is considered a one-space move when calculating distances.

When entering wildspace from the phlogiston (that is, from outside the crystal sphere), the ship is placed randomly at the edge of the system. (This is always as far from the outermost orbit as that orbit is from the system primary.) Place the ship using the same system that is used for placing planets.

While the planets are (usually) limited in their movement to their paths

around the primary, ships can move as they see fit along the display, subject to the limitations of their spelljamming helms. Ships move from space to space on the display as they perform their movement. Ships are not required to move in the same orbit at all times, but can cut between them as they move. A ship may move diagonally between spaces that are joined at a corner.

When a ship moves into the 200-million-mile circle at the center of the outer track, the DM should place the ship on the inner track at the 300 million mile edge. The position of the ship should match as closely as possible its position on the outer track (a ship that enters from the lower right should be placed somewhere along the lower right section of the inner track). The DM chooses the space the ship appears in.

A spelljammer is not required to stop if it enters the same space as a planet unless it has an encounter or the ship is landing at that planet. There is an increased chance of random encounters in spaces that currently contain celestial bodies.

Encounters and Evasion on the Planetary Display

As stated too many times already, space is BIG. The chance meeting of two objects, whether they be ships, asteroids, cast-off magical items, or elder gods in the vastness of wildspace are very slender indeed. Encounters are most likely in areas with large bodies, such as planets and asteroids, and more likely in systems with a high degree of space travel. A ship has a greater chance of encountering other starfaring ships and creatures in the more crowded inner planets than in the void between the outer planets and the crystal shell.

The DM may have planned encounters for particular sections of space: a



group of pirates lurking among the asteroids, for example, or an elven armada seeking to protect their "no humans allowed" planet. Such encounters are left to the DM and override any random encounters.

The planetary display can be used for determining random encounters as well. When using the display, check once for every space (on the outer or inner zones) the ship enters. The base chance of an encounter is 1 in 20, modified as follows:

On the inner planet track	-1
In same ring as a planet or star	-1
In same space as a planet or star	-1
In same space as patrolling starjammer	-1
In same ring as an asteroid belt	-1
In a system with extensive space activity	-1*
In a system with no space activity	+1*

* The level of spelljamming activity is a reflection of the amount of normal space travel found in the sphere. Extensive spelljamming activity means more than one major spacefaring nation or space-based community. Toril has an extensive spelljamming community while Oerth is normal (no modifiers) and Krynn, heavily influenced by gods and recovering from catastrophe, has little or no spelljamming activity.

If the characters are using a time-based process (from the charts) to determine travel time, use the following procedure:

If within 200 million miles of the primary, roll once per day;
 If beyond 200 million miles of the primary, roll once per week.

Roll 1d20, with 1 representing a possible encounter.

- If the ship is within one day's journey of a planet, roll an additional d20.
- If the ship is passing through an asteroid belt, roll an additional d20.
- If the area of space is actively patrolled, roll an additional d20.

In cases where there are multiple encounters on a single day, the DM should determine the time of the encounters relative to each other.

Regardless of the method used to determine encounters, if an encounter is called for, the ship slows to tactical speed to resolve the encounter. (This slowing is the result of passing within the gravity plane of another large object). Evasion and escape are covered in Chapter 4.



Known Space

KRYNNSPACE—
The Wildspace of
Dragonlance

- Sun
Type H ● Fire
- Sirion
Type D ● Fire,
inert
- Reorx
Type D ● Earth,
one
moon
- Krynn
Type D ● Earth,
three
moons
- Chislev
Type E ● Earth,
Liveworld
- Zivilyn
Type F ● Air,
12 moons



Universe Building

As the heroes move out into the phlogiston, they will discover new systems and universes to adventure in. There are three types of these universes: preplanned (the Known Worlds), DM-created, and random.

Preplanned Universes

The Known Worlds of Toril, Krynn, and Oerth are laid out on the planetary display, showing their planetary positions and statistics. The movement of the planets is standard unless the DM institutes an optional rule.

When entering the wildspace of a Known World, either from inside that sphere or from beyond the crystal shell, set the planets in their correct orbits in a random placement as described above.

DM-Created Universes

The DM may create systems both for his own campaign and for those new systems that the characters discover in their travels. He can use the random method below or place the various celestial bodies in the system deliberately. In creating this type of system, the following checklist will be handy:

- 1) Type of System: Is it a standard system (represented by the planetary display) or a special case?
- 2) Assuming a standard system, what is the primary body (star, planet, black hole, etc.).
- 3) What is the number of main planets orbiting the primary body?
- 4) What are the orbit rings of each body?
- 5) For each planetary body:
 - a) What is its size?
 - b) What is its type?
 - c) What is its shape?
 - d) Are there other notes, such as moons or type of inhabitants?

- 6) Do some or all of the civilizations in this area have spelljamming capabilities?
- 7) What is the distance to the crystal shell of the system? (Twice the orbit of the furthest major body.)

Randomly Generated Systems

OK, you're tired of putting brain power into figuring out civilizations and orbits and all that rot. Or, worse yet, your party decides to ignore adventuring in Krynnspace entirely and heads unexpectedly for the phlogiston beyond the walls of the crystal shell. Now what?

Note: the DM may, at his leisure and his option, override any dice roll and choose the result that suits his fancy. If it works out best that all the planets are flat and made of cream cheese, then that's what they are. This system is to aid the DM's creativity, not supplant it.

Part 1: System Type

Roll percentile dice:

- 01-95 Standard system (as shown on system display).
- 96-00 Special system (roll again on following table or choose
 - 01-20 Fixed system
 - 21-30 Random movement
 - 31-40 Semi-random movement
 - 41-70 Single planet (roll no further)
 - 71-95 Void
 - 96-00 Nested spheres

Part 2: Primary Type

- 01-70 Sun (fire body)
- 71-95 Planet (roll again)
 - 01-80 Earth body
 - 81-90 Air body
 - 91-00 Water body
- 96-99 No primary; the planets orbit an empty spot at the center

- 00 Portal to another plane (roll again)
- 01-30 Outer plane
- 31-50 Plane of elemental fire
- 51-60 Plane of elemental earth
- 61-70 Plane of elemental water
- 61-80 Plane of elemental air
- 81-90 Positive material plane
- 91-00 Negative material plane

Note to DMs: If the system has no fire bodies or portals to the positive material plane, then the sphere is in darkness (except for the stars) and the planets in eternal night. Space is colder than normal but the planets are unaffected, as is life on them (in scientific terms, of course, this is impossible, but we are dealing with the land of gods here).

Part 3: Number of Planets

- 01-05 One planet
- 06-10 Two planets
- 11-15 Three planets
- 16-20 Four planets
- 21-30 Five planets
- 31-45 Six planets
- 46-55 Seven planets
- 56-65 Eight planets
- 66-75 Nine planets
- 76-85 Ten planets
- 86-90 1d20 planets
- 91-00 No major planets; entire sphere has small planetoids, debris, etc. (roll no further)

Planetary Movement

- 01-95 Planets are worlds orbiting around a central point.
- 96-00 Planets are carried on the backs of large world-creatures which carry the spheres about.*

* This is only one possibility for a strange system. Others include:

- Planets carried on boats sailing on a sea of wildspace, or even water;
- Planets mounted on the tops of infinitely tall pillars. Anyone who

sails downward can travel indefinitely without ever reaching the bottom;

- Planets mounted on enormous, clockwork gears;
- Planets tumbling eternally downhill. Even after making one complete trip around the primary body, they are still rolling downhill (who can explain such mysteries?);
- The sphere could be divided into two distinct and separate hemispheres with completely different systems in each. The systems could be divided by a flat ocean which stretches to the limits of the sphere, or by an extension of the sphere material itself.

Planetary Motion

- 01-10 No movement—fixed planets
- 11-15 Random movement within sphere
- 16-50 All planets move clockwise in orbit
- 51-90 All planets move counterclockwise in orbit
- 91-00 Each planet moves either clockwise (01-50) or counterclockwise (51-90) or is fixed (91-00)

Again, this list does not exhaust the possibilities. Planets could move up and down instead of around, or they could move in extreme, cometary orbits, creating severe seasonal changes and long winters. The DM is urged to be creative and to not feel restrained by science.

Part 4: Planetary Characteristics

Roll on the following tables for each of the planets involved. At the DM's option, one roll can be made for all the planets, making them all the same shape, or size, or type, in order to simplify the DM's life.



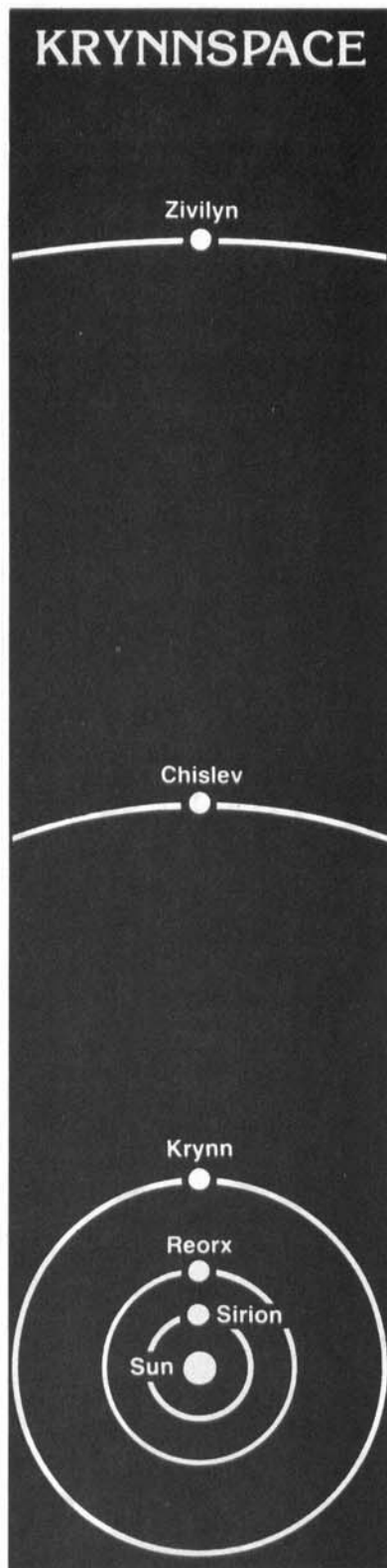

Planet Type

Roll Percentile Dice:

01-40	Earth type
41-60	Fire type
61-80	Air type
81-99	Water type
00	Liveworld (optional)

Planet Size

Fire and Air Types

01-02	Size A
03-05	Size B
06-10	Size C
11-20	Size D
21-35	Size E
36-50	Size F
51-70	Size G
71-85	Size H
86-95	Size I
96-00	Size J

Earth and Water Types

01-05	Size A
06-10	Size B
11-20	Size C
21-40	Size D
41-60	Size E
61-80	Size F
81-90	Size G
91-00	Size H

Shapes

01-05 *	Amorphous
06-15 †	Belt
16-20 ❖	Cluster
21-65 ●	Spherical
66-70 □	Cubic
71-90 ▽	Flatworld
91-95 0	Elliptical
96-99 △	Regular
00 ✧	Irregular

Goodies (optional)

Goodies are moons, rings, strange atmosphere (or no atmosphere), and other unusual features that can flesh out a system's planets. Roll once for each planet.

01-10	Single moon. Also roll again, ignoring a second result of 01-10
11-20	1-4 moons

21-25	1-4 moons and roll again
26-35	Cluster of asteroids
36-45	Ring (earth)
46-55	Ring (fire)
56-65	Ring (water/ice)
66-75	Planet hotter than normal
76-85	Planet colder than normal
86-95	Vacuum
96-99	Civilization—world empire
00	Roll twice

Explanations

Moon: Moons will be no larger than one size smaller than the planet they orbit (moons orbiting size A planets are also size A). Other attributes are set by the DM.

Cluster: Similar to a moon, but consists of a tight bundle of asteroids in a close orbit around the planet. The Tears of Selune in orbit around Toril are an example of a cluster.

Ring: Rings can be asteroid belts, frozen water, or ribbons of fire (which may provide light for otherwise sunless systems).

Planet hotter than normal: The greenhouse effect without science. When laying out the planet, give it lots of baked deserts, steaming jungles, dripping rain forests, and tropical swamps.

Planet colder than normal: Locked in either a permanent or temporary ice age. Wind-swept mountains, drifting snow, and glaciers are the norm planet-wide.



Vacuum: Most worlds have an atmosphere of some type, but there are exceptions. Only water and earth-type worlds can have this attribute. In the case of earth worlds, the planet's surface is exposed to raw, lifeless space, while on water worlds, there is usually a shell of ice covering the water beneath. Any civilization found on the planet is located beneath the surface or behind magical protection.

Civilization—world empire: Most fantasy worlds are mired in the Middle Ages, with a huge number of small, petty states and warlords. Fewer are capable of creating a continent-wide string of nations and very, very few are under the control of a single leader or group of leaders. Such civilizations usually have both spelljamming technology and the desire to use it. Space containing such civilizations will have large numbers of standard starships and be willing to challenge interlopers in space.

Part 5: Planetary Placement

Start at the center of the system on the inner orbital track and roll 1d6. That is how far out (in rings) the first planet is. Repeat the process for each planet beyond the first, counting out from each previous planet.

When the planets being placed move out past the 200-million-mile mark, go to the outer track. The next planet will be in the 400 million mile area. Continue the procedure using a four-sided die until you run out of planets.

The crystal shell of the system will always be as far from the outermost orbit as that orbit is from the primary body of the system. In cases of randomly moving planets, use the outermost planet's set-up location as its orbital distance.

Planetary System Creation Example

Using the tables just presented, we want to create the system of Fungo.

The DM decides Fungo will be a standard system of planets orbiting around a central primary star. It could just as easily have planets carried on the backs of turtles or floating on an ocean between the planets, but he decides to keep it simple.

The primary body is a small, hot star. He marks down on the planetary system sheet that the primary is size H, spherical, fire type.

The DM then rolls 28 on percentile dice and determines the system has five planets. Two of them will be relatively close together, since he already knows he wants the civilizations on them to be engaged in a space war. He decides those will be the second and third planets. Outlining the general layout of the system gives:

- 1 Inner orbital track #2
- 2 Inner orbital track #4
- 3 Inner orbital track #5
- 4 Outer orbital track #3
- 5 Outer orbital track #5

The furthest planet is in outer ring #5, meaning that the crystal shell is at the outer ring #10 position. This is a small system, only a little bigger than Krynnspace.

As stated above, a big fight is going on between spelljamming civilizations on planets 2 and 3 and the DM wants them to be Earthlike (big earth spheres with atmosphere). The rest of the system probably doesn't contain too much choice territory. The DM rolls those planets randomly and gets:

Planet 1	Size A	‡	Earth
Planet 2	Size E	●	Earth
Planet 3	Size E	●	Earth
Planet 4	Size F	●	Air (Rings)
Planet 5	Size D	●	Water (Frozen, Vac)

Neither of the two earthlike planets have moons, but their proximity to the belt probably means that there are a number of small (size A) asteroids in near orbit that can be used as bases.

Since planets 2 and 3 have spelljamming civilizations, they must be inhabited. The DM decides to populate both with variations on the standard, medieval fantasy society. The asteroid belt in the first orbit probably has outposts from both sides. Any civilizations on planets 4 and 5 are beneath the surface.

Beyond this, the details of who these civilizations are and what ships they use is up to the DM, as is the fate of any ship that happens to fall into their picket lines. Both sides may hire dwarves to bring asteroids onto collision paths with the other planet, or may engage in hit and run attacks and occasional slave raids. Both sides may be humanoid, or one may be human and the other centaur, or both may be nonhuman, with humans reduced to slave stock at best. They could be green humans fighting blue humans, or roundish humans fighting squarish humans, or the home world fighting rebellious emigrants, or even fish people fighting bird people. These decisions are up to the DM as he fleshes out his story.





GREYSPACE—The Wildspace of Oerth

Oerth		
Type E	●	Earth
Kule		
Type B	●	Earth
Raenei		
Type D	●	Earth
Liga (sun)		
Type G	●	Fire
The Grinder		
Type B	‡	Earth
Edill		
Type G	●	Air
Gnibile		
Type G	●	Air
Conatha		
Type C	0	Water
Ginsel		
Type C	◇	Earth
Borka		
Type A	❖	Earth
Greela		
Type E	❖	Earth
The Spectre		
Type B	▷	Earth



Spells in Space

In both wildspace and in the Flow, a number of special situations affect various spells (such as, what does a *disintegrate* spell do to an enemy ship in terms of hull points damage). The following listing is meant to clarify those spells used in the game. For spells and situations not listed, and new spells (from various worlds or of the players' own creation), use these rules as a guideline.

Wizard Spells

First Level Spells

Affect Normal Fires: This spell is often used to fight fires that break out on ships, and can completely extinguish all flames in a 10-foot radius, halting any further damage. Increasing the effect of a fire increases its illumination, but not its damage, neither in hull points nor hit points. *Affect normal fires* will not prevent an explosion of open flame in phlogiston, unless used before the fire is exposed to the ether.

Audible Glamer: This spell has no effect in wildspace beyond the borders of the air envelope of a ship. It is possible to cast an *audible glamer* through the empty void between air envelopes (so that a spellcaster on one ship can cause an *audible glamer* spell to function on another ship separated by the void).

Burning Hands: In the phlogiston, casting this spell will cause immediate detonation on the user himself and all within 5 feet of him, inflicting 1d3 points plus 2 points per level of the caster damage.

Cantrips: Cantrips are limited by the physical laws of the area in which they are cast. Cantrips creating flame will have an explosive nature if cast in the Flow, but damage will be slight (1 point at most).

Enlarge: The recipient of an *enlarge* spell increases in size and mass, and

as such increases both in amount of air required and the size of the atmospheric envelope that will hang about him. The size of the envelope will increase with the enlarged figure, if possible. If not possible (the figure was enlarged when floating free in space, say), the amount of time before the air runs out is halved. When *shrinking*, the reverse occurs, in some cases allowing a character cast adrift to hang on a bit longer.

Feather Fall: This spell operates only in gravity fields, and is limited to objects less than 10 cubic feet in size. While it is possible to land on planetary surfaces via this spell, its small area usually makes this impractical for bodies larger than Size A.

Hold Portal: This can be used successfully on portals through crystal shells, provided that the portal is completely within the area of effect of the spell.

Magic Missile: A *magic missile* cannot inflict hull damage.

Mending: This spell can be used to replace hull damage, broken rigging, and effect other ship repairs. For every 10 cubic feet affected, a ship regains 1 hull point, 1 point of AR, or one lost maneuverability class.

Phantasmal Force: This spell can be cast through the void between ships in wildspace.

Protection from Evil: Creatures from another crystal sphere are not considered extra-planar in nature.

Wall of Fog: The *wall of fog* brings air into being, and as such can be used to freshen air that has gone stale, within the limitations of the spell's area. If the area is greater than the ship or individual's ability to hold it, the excess is bled off into space. The *wall of fog* has the disadvantage of reducing sight in its area to two feet for the duration of the spell, but the air freshening effect is permanent until the air is again fouled.



Second Level Spells

Deepockets: In the phlogiston, access to extradimensional space is impossible. Objects within a garment subject to a *deepockets* cannot be reached until the individuals pass within a crystal shell, after which they can be accessed normally. The objects within the *deepockets* are not destroyed, but cannot reappear until brought into an area where extradimensional access works. For long-term travels, a *deepockets* spell duration will not elapse until the garment passes back into a crystal sphere.

ESP: This functions across the void between atmospheric envelopes. It cannot penetrate a crystal shell.

Flaming Sphere: In wildspace, the *flaming sphere* will be extinguished if it passes out of the atmospheric envelope of a ship or planet (compare

with the *fireball* spell). In the phlogiston, the *flaming sphere* spell detonates immediately at the caster's location, inflicting 2d4 points of damage to the caster and 1d4 points to all within 5 feet of the caster. Saving throws apply, and the detonation ends the spell immediately.

Fog Cloud: As for *wall of fog*, this spell can be used to freshen the air within an atmospheric envelope. As with the *wall of fog*, the obscurement effect lasts for the normal duration while the freshening effect is permanent until the air is fouled.

Improved Phantasmal Force: This spell can be cast through the void between atmospheric envelopes without difficulty.

Knock: The *knock* spell (and its opposite, *lock*), can be used upon portals in a crystal shell.

Levitate: The levitating wizard is moving upward from the "down" direction he began in—be it a ship's deck or a planetoid. Once beyond the gravity field (the atmospheric envelope) of the ship, the spell does not function.

Magic Mouth: If the *magic mouth* is in void, or the void separates the mouth and the listener, the listener will hear nothing.

Melf's Acid Arrow: The acid damage of the arrow can affect ship hulls, provided that the hull material is subject to acid damage (a ceramic or glass hull would be immune to the effects of acid). *Melf's acid arrow* reduces hull points as follows: for each 10 points of damage (cumulative) from the spell, 1 point of hull damage is inflicted on the ship. If an *acid arrow* that lasts three rounds is cast, the first round inflicting 8 points, the

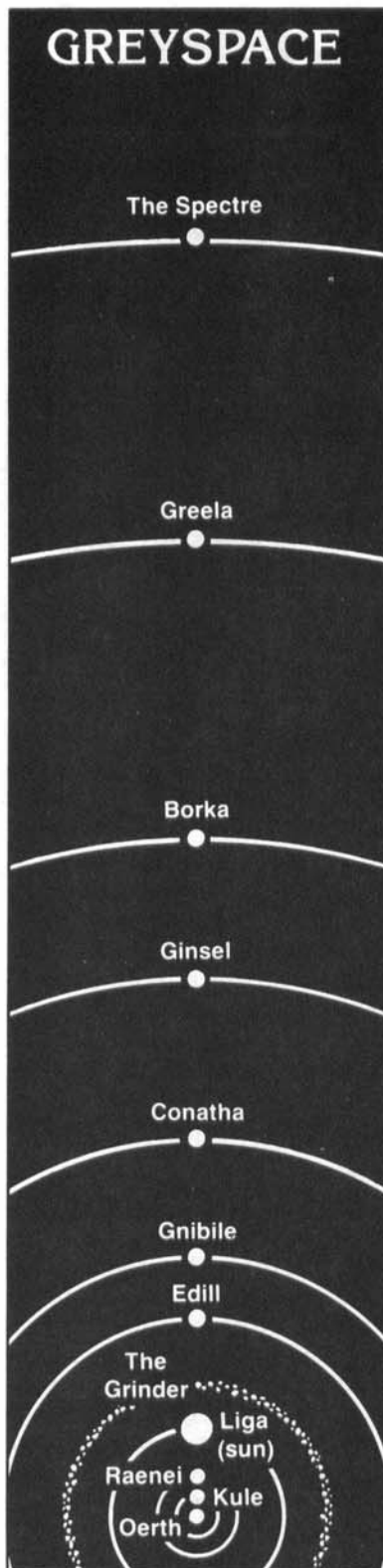

second 4, and third 3, then 1 point of hull damage would be inflicted on the second round of the spell.

Pyrotechnics: The spell does not function outside of an air source for the fire involved. Pyrotechnic *fireworks* on a ship can be used to extinguish an on-board fire (up to a 20-foot cube in size), with the blinding effect listed under its spell description. Pyrotechnic *smoke* fouls the air within its area of effect. This spell will not function in the phlogiston since the required fire source would immediately explode.

Rope Trick: This spell does not function in the phlogiston, as the extradimensional space cannot be accessed.

Shatter: As a sound-based attack, this spell cannot cross the void between air envelopes. If cast within an atmosphere, it can be used to inflict hull damage to ships made of crystal, ceramic, or glass, damaging them as if they were crystalline creatures (1d6 per level to a maximum of 6d6). For every 10 points of damage inflicted, one point of hull damage is taken by the ship.

Stinking Cloud: In addition to its normal effects, this spell leaves the atmosphere of a ship stale if the ship is 10 tons or less per level of the caster. The stale air lasts the duration of the spell.

Summon Swarm: If none of the creature types is available, then this spell does not function.

Web: A *web* spell can be used to link together two ships within range.

Whispering Wind: The effects of this spell rely on the presence of air, and as such cannot cross the void between atmospheric envelopes.

Wizard Lock: Portals through crystal spheres can be *wizard locked*.

Third Level Spells

Blink: This spell relies upon access to extra-dimensional space, and as such cannot function in the phlogiston.

Clairaudience: The effects of this spell can cross the void between ships and planets within the same crystal shell. It cannot cross the phlogiston, so events on Krynn cannot be heard in Toril by this spell. In the phlogiston, the effects of the spell are limited to the atmosphere envelope surrounding the caster.

Clairvoyance: As with *clairaudience*, this spell is limited to the crystal sphere in which the caster is located. In the phlogiston, the spell is limited to the caster's atmosphere envelope.

Explosive Runes: If detonated in the phlogiston, these runes inflict 12d4 plus 12 points of damage to the reader (no saving throw), and either half or none of this damage to those within a 20-foot radius. In addition, the spell will inflict damage to a ship in standard fashion—10 points of damage equals one point of hull damage, with any remainder dropped.

Fireball: In wildspace, this spell can cross the void between atmospheric envelopes, but the spell itself cannot detonate in the void. In phlogiston, the spell immediately detonates at the caster's location for its normal area of effect and damage. If used against ships, 10 points of damage will inflict one point of hull damage to the ship, and starts flammable materials on fire.

Flame Arrow: The effects of this spell cannot pass through the void between atmospheric envelopes. In the phlogiston, the first version of the spell causes the arrow (and the bow it is knocked in) to immolate, inflicting 1d4 fire damage to the user. The second version of this spell causes the spell to detonate immediately, for 4d6 points of damage to the caster.

Fly: The *fly* spell does not require air, and will function normally in wild-space or phlogiston.

Gust Of Wind: This spell cannot cross the void between atmospheric envelopes. It can be used within an atmospheric envelope to increase the maneuverability class of a ship by one (to a maximum of class C) or reduce it by one rank (to a minimum of class F).

Item: Yes, a small ship can be shrunk in this fashion, if within the limitations of the spell's area of effect. The *spelljammer helm*, however, is a magical item and cannot be shrunk.

Leomund's Tiny Hut: The hut created by this spell retains its own breathable atmosphere.

Lightning Bolt: Unlike the *fire ball*, this spell can travel through the void and detonate in the void as well. It inflicts one point of hull damage for every 10 hit points of damage it inflicts, if it hits a ship. Stone and thick wood (more than 6 inches thick) will, at the DM's option, cause the bolt to bounce, though it will still inflict listed hull damage.

Melf's Minute Meteors: The fiery spheres created by this spell will be extinguished if exposed to the void between atmospheric envelopes. In the phlogiston, the spheres will explode in the caster's hands, inflicting 1d4 points of damage per missile being cast. If used against ships, the *minute meteors* inflict no hull damage, but they do start fires.

Non-Detection: This can be cast upon an item as large as a ship of 1000 tons.

Spectral Force: This spell can be used across the void between atmospheric envelopes, although it creates no sound within the void itself.

Suggestion: The subject must be able to hear the caster in order for the suggestion to take place, and as such cannot take place across the void.

Wind Wall: This creates air, and in addition to its other effects, will freshen the stale atmosphere of a ship of up to 10 tons times the caster's level.

Wrathform: The spell fails if cast in the phlogiston. A caster in *wrathform* cannot enter the phlogiston.

Fourth Level Spells

Dig: This spell can be used against ships of earth or similar construction (but not stone) to inflict hull damage as if the ship were an earth elemental (for every 10 hit points inflicted, the ship takes one point of hull damage).

Dimension Door: This spell does not function in the phlogiston, as it requires temporary access to the Astral plane.

Fire Charm: As the spell requires a fire source, it usually cannot be cast successfully in the phlogiston.

Fire Shield: This spell functions normally in the phlogiston, causing the user to burst into flame that is harmless to him. The flame consumes air like a creature twice the caster's size.

Fire Trap: This spell functions normally in the phlogiston. It does not ignite (nor is the spell spent) if somehow opened in the void. The air envelope around a single individual is enough to allow the *fire trap* to explode.

Hallucinatory Terrain: In addition to creating illusory asteroids and similar bodies, this spell can be used to disguise ships in space, either making them appear as part of the background stars, or as an asteroid or small dust cloud, provided the ship is small enough to fit within the area of effect of the spell.

Leomund's Secure Shelter: The shelter comes with its own atmosphere as well, which remains fresh for the duration of the spell.

Magic Mirror: This spell (and the *crystal ball*, which it imitates) can view other crystal spheres, as well as the





REALMSPACE— The Wildspace of Toril

Sun	
Type H	● Fire
Anadia	
Type B	● Earth
Coliar	
Type G	● Gas
Toril	
Type E	● Earth, Moon & Cluster
Karpri	
Type D	● Water
Chandos	
Type F	● Water
Glyth	
Type E	● Earth
Garden	
Type A	❖ Earth
H'Catha	
Type C	▷ Water



phlogiston. If used in the phlogiston, it cannot view other planes.

Minor Creation: In the phlogiston, this spell fails, as the Shadow plane cannot be accessed.

Shadow Monsters: These cannot form in the phlogiston, as the Shadow plane cannot be accessed.

Shout: The effects of this spell cannot cross the void between atmospheric envelopes.

Solid Fog: This spell creates air in the area given, and can be used to freshen a stale atmospheric envelope. The negative effects of the spell, however, still apply if used in this fashion.

Wall of Fire: The spell will not burn in the void, so that if the spell extends beyond the boundaries of the atmospheric envelope, the additional length is lost. If cast in the phlogiston, it becomes a tight pillar of flame centered on the caster, inflicting 2d6 plus 1 point per level damage to the caster, 2d4 to all within 10 feet, and 1d4 to all within 20 feet. The spell only functions one round in this form.

Fifth Level Spells

Cloudkill: A lethal spell within the enclosed atmospheric envelopes, in addition to the effects listed, the spell makes the air stale immediately (if it has not already) after the duration of the spell elapses. It dissipates immediately in the void. As it will not move uphill, it will not usually leave the ship upon which it is cast.

Conjure Elemental: This spell requires contact with the elemental planes, and as a result cannot be cast in the phlogiston. Elementals do not need air, and as a result can be conjured in the void. An air elemental can be conjured to freshen a ship's air envelope.

Contact Other Plane: This spell does not function in the phlogiston.

Demi-Shadow Monsters: These will not form, as the Shadow plane cannot be accessed.

Distance Distortion: This cannot be cast in the phlogiston, as the earth elemental cannot be summoned.

Fabricate: This spell can be used to repair lost hull points or maneuverability class for a ship. For every 10 cubic yards of material repaired, 1 hull point, 1 point of AR, or one maneuverability class is regained, up to the original ratings.

Leomund's Secret Chest: The secret chest cannot be accessed in the phlogiston, as it exists in the Ethereal plane. The chest is not lost or destroyed, but just cannot be reached.

Major Creation: In the phlogiston, this spell fails, as the Shadow plane cannot be accessed.

Shadow Magic: As the Shadow plane cannot be accessed from the phlogiston, this spell will not function there.

Stone Shape: This spell can be used to repair vessels made of stone, such as dwarven mountain ships. For every 10 cubic feet shaped, the ship regains either 1 hull point, 1 point of AR, or one lost maneuverability class, up to the original rating.

Summon Shadow: As this spell calls a shadow from the Negative Material plane, it will not function in the phlogiston.

Teleport: A character can teleport from one planet to another within a crystal sphere, but travel from one crystal sphere to another is impossible by means of this spell.

Transmute Rock to Mud: This spell can be used to inflict hull damage on ships made of rock or stone. For every 20-foot cube affected, 1-6 points of hull damage are inflicted on the ship.

Wall of Force: A ship hitting a wall of force is stopped in its tracks, and might take damage. If the tonnage of

the ship is less than the level of the caster (i.e. the size of the wall in 10' squares), the ship crashes against the wall as if it has struck a foreign body that was too large (see Crashes). If not, the ship is halted in its tracks and must spend 1-4 rounds maneuvering around the wall. This spell is often used to slow or stop pursuers.

Wall of Iron: A ship hitting a wall of iron faces the same problems as one hitting a wall of force (above). Further, the wall is permanent, and will pose a navigation hazard in the future (occasionally gaining its own atmosphere and settlements later). Finally, even if the wall is insufficiently large enough to cause a crash, it still poses the problem of falling on the ship once it enters its air envelope/gravity field. A wall of iron can be used to repair hull damage to metal ships, but at a cost. For each 15 square feet created by the spell, 1 hull point is restored, but for each use of the spell in this fashion, the maneuverability class of the ship diminishes by one.

Wall of Stone: Unlike other walls, a wall of stone requires existing stonework to merge with, so as such cannot be cast in deep space. It can be used to repair hull damage to stone ships, but at a cost. For each 20 square feet of quarter-inch thick stone created, the ship regains one hull point. Such repairs will radiate magic, and can be reversed by a dispel magic spell.

Sixth Level Spells

Anti-Magic Shell: A spelljamming helm does not function within the bounds of an anti-magic shell.

Bigby's Forceful Hand: The hand can be used to slow opposing space ships within range. It can be destroyed either by normal combat, or by ramming (treat the hand as a gargantuan creature for purposes of ramming).

Chain Lightning: This spell can cross the void between atmospheric envelopes.

Control Weather: This spell will not function within the confines of a ship's air envelope, nor on planets of less than size class B.

Death Fog: This spell will affect the hull points of a ship if that ship is affected by acid. Damage is cumulative: for every 10 hit points of acid damage inflicted, the ship suffers one point of hull damage. This damage is taken for every 10-foot cube in contact with the ship.

Disintegrate: If it hits a ship, this will destroy material in a 10-foot cube. It will also destroy either one hull point, lower the armor rating by 1, or reduce the maneuverability class by one. Disintegrating a spelljamming helm will of course cripple the ship.

Glassee: This spell, linked with permanency, is used to provide windows in solid plating for the higher-priced ships.

Invisible Stalker: The invisible stalker can survive in the void, and thus cross it under its own power.

Veil: This spell can be used to hide or disguise ships, provided that the area of effect in 10-foot squares is larger than the tonnage of the ship.

Seventh Level Spells

Bigby's Grasping Hand: All ships of 1 ton or higher fall into the 16,000-pounds-plus category. The hand can be rammed as a gargantuan creature.

Delayed Blast Fireball: The spell will not detonate in the void and if in airless space is wasted. In the phlogiston, it will detonate immediately, with the effect centered on the caster.

Drawmij's Instant Summons: This spell can summon items from other crystal spheres. If the caster is in the phlogiston, then the spell will fail.



REALMSPACE

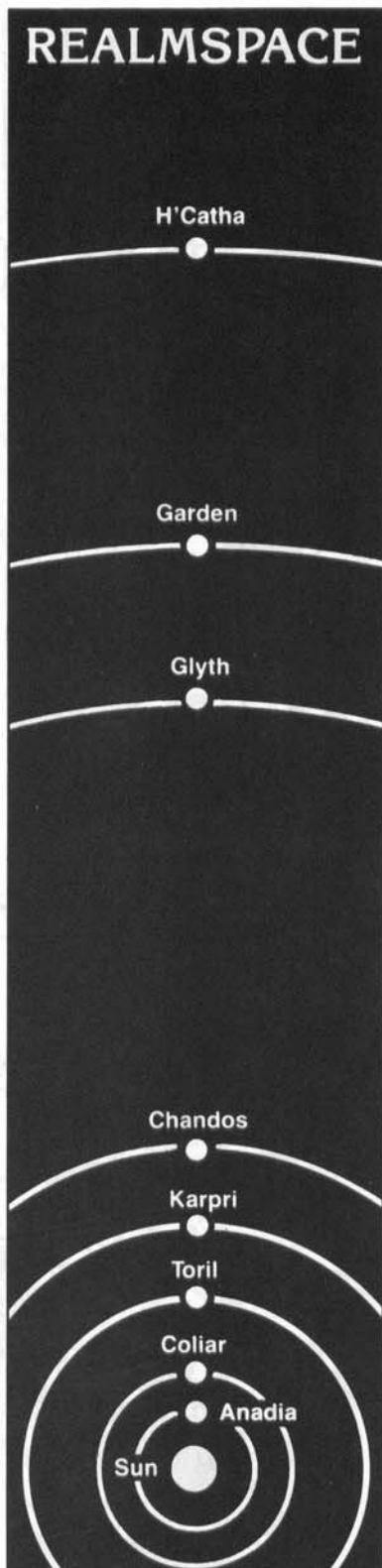

Limited Wish: This can be used to allow access to an extradimensional space for up to one round when cast in the phlogiston.

Mordenkainen's Magnificent Mansion: This spell cannot be cast in the phlogiston, as it requires access to extradimensional space. When otherwise casting the mansion, it will supply air for those inside it as well. As with other spells involving extradimensional spaces, an existing mansion cannot be accessed in the phlogiston.

Power Word, Stun: The word is not effective if the listener is separated by vacuum from the speaker, thus this spell will not cross the airless void between atmospheric envelopes.

Reverse Gravity: A deadly spell in space, it can negate the localized gravity of the ships and throw the subjects into space. The subjects still retain their personal gravities, and will take a small air envelope with them when they go into space. Worse, however, the spell creates a flume of air escaping from the envelope, as if the envelope had spurted a leak. One ton of air is lost for every round the spell is in effect. In this fashion, a ship or small asteroid can become an airless hulk.

One interesting use of this spell is as a heavy bombard to loft stones directly off a platform and into the path (and gravity well) of a passing ship. The damage caused by such an attack is decided by the DM.

Shadow Walk: This spell will not function in the phlogiston, as it requires connection with the Shadow plane.

Teleport Without Error: The user of this spell cannot teleport from one crystal sphere to another. Furthermore, the caster cannot teleport to another plane from the phlogiston.

Vanish: This spell will not function in the phlogiston, as it requires access to the Ethereal plane.

Vision: In the phlogiston, no Power can be contacted.

Eighth Level Spells

Bigby's Clenched Fist: The fist can be used against ships. For each 10 hit points inflicted by the hand, one hull point is inflicted. Damage is not cumulative from round to round.

Glassteel: This spell, used repeatedly in the construction process, can produce ships of glass with an armor rating of 1.

Incendiary Cloud: This spell is limited as the *pyrotechnics* spell.

Maze: This spell cannot be cast in the phlogiston.

Power Word Blind: As for the *power word, stun*, victims separated from the caster by the void will not be affected.

Sink: This spell will only function on solid (earth-based) planets of size A or greater.

Ninth Level Spells

Astral Spell: This spell cannot be cast in the phlogiston, as it accesses the Astral plane. A mage using the *astral spell* whose body is taken out into the phlogiston cannot return to his body until the body is brought back within a crystal sphere.

Bigby's Crushing Hand: This hand can inflict damage on ship hulls, but unlike *Bigby's clenched fist* such damage is cumulative: for every 10 hit points inflicted by the *hand*, one hull point is inflicted.

Crystalbrittle: This spell can be used to reduce hull points of metal ships. For every 10 cubic feet affected by the spell, the hull value of the ship is reduced by one. Alternately, the armor rating of a metal ship can be reduced in the same fashion.

Gate: This spell will not function in the phlogiston.



Imprison: This spell will only function on solid (earth-based) planets of size A or greater.

Meteor Swarm: This spell will not detonate in the airless void beyond the limits of the atmospheric envelopes. If cast in the phlogiston, all the fireballs will detonate immediately, centered on the caster.

Mordenkainen's Disjunction: Spelljammer helms are treated as minor artifacts for the purpose of this spell.

Power Word, Kill: As for the other power word spells, this spell fails if the subject is separated from the caster by void.

Succor: Like the *word of recall*, this does not function in the phlogiston.

Wish: This can be used to gain access to an extradimensional space for up to one turn in the phlogiston.

Priest Spells

Note: As stated in the text, priest spells above 2nd level cannot be regained in the phlogiston. They can be cast in the Flow, but until the links with the Outer Planes are restored, they cannot be regained. The regaining of Priest spells might also be limited by which deities operate within a given crystal sphere.

First Level Spells

Endure Heat/Cold: This spell will protect the user from excesses of heat and cold found within certain crystal spheres.

Protection From Evil: Creatures from other crystal spheres or planets are not considered extraplanar in nature.

Second Level Spells

Augury: This spell works normally in both wildspace and the phlogiston.

Dust Devil: In wildspace, the *dust devil* can move, under the direction of its creator and within the range of its spell, across the void between atmospheric envelopes. The spell cannot be used in the phlogiston.

Fire Trap: This spell functions normally in the phlogiston. It does not ignite (nor is the spell spent) if somehow opened in the void. The air envelope around a single individual is enough to allow the *fire trap* to explode.

Flame Blade: If used in the phlogiston, the *flame blade* will immediately explode, inflicting 1d4+4 points of damage upon the caster.

Obscurement: In addition to its normal effects, this spell creates air and



The Flow

Realspace has one consistent connection with Greyhawk, and is resistant to Krynn. Any other spheres are variable, and may or may not be in phase with Realspace, so its listing is:

REALMSPACE

Travels to: Greyhawk
 Cannot Travel to: Krynn
 Variable Travel: All others (50%)

Voyagers from Krynn, on the other hand, can travel to the Realms but not Greyhawk Space, so its entry is:

KRYNNSPACE

Travels to: Realms
 Cannot Travel to: Greyhawk
 Variable Travel: All others (10%)



can be used to freshen the air, as the wizard's *wall of fog* spell.

Produce Flame: If used in the phlogiston, the *produce flame* spell will detonate in the hands of the caster, inflicting 1d4 + 1 points of damage.

Warp Wood: This spell can be used to damage or affect wooden spelljamming ships. At 10th level, the caster can affect enough wood to reduce the hull value of a wooden ship by 1 hull point, the AR by 1, or the maneuverability class by one. At 15th level the effects are doubled, and doubled again five levels beyond that.

Third Level Spells

Call Lightning: As this spell usually requires some type of storm in the area, it cannot be cast in space (unless of course, someone manages to create a storm in space).

Dispel Magic: The effects of this spell on spelljamming helms are discussed in the section about helms.

Glyph of Warding: Those glyphs that have an explosive fire effect function normally in the phlogiston. In the void, they do not function (but are not negated). The air envelope of but one individual is sufficient to allow the *fire glyph* to operate normally. Other glyphs function normally in both environments.

Pyrotechnics: The spell does not function outside of an air source for the fire involved. Pyrotechnic *fireworks* on a ship can be used to extinguish an on-board fire (up to a 20-foot cube in size), with the blinding effect listed under its spell description. Pyrotechnic *smoke* fouls the air within the area of effect. This spell will not function in the phlogiston since the required fire source will immediately explode.

Stone Shape: This spell can be used to repair vessels made of stone, such as dwarven mountain ships. For every 10 cubic feet shaped, the spell

regains either 1 hull point, 1 point of AR, or one lost maneuverability class, up to the original rating.

Fourth Level Spells

Produce Fire: If cast in the phlogiston, the spell will immediately immolate the caster, inflicting 1d4 points of damage + 1 point per level.

Reflecting Pool: The *reflecting pool* (and the *crystal ball*, which it imitates) can view other crystal spheres, as well as the phlogiston. If used in the phlogiston, it cannot view other planes.

Fifth Level Spells

Air Walk: This spell is usable only where there is sufficient air. The air envelope around a ship is sufficient, but that enclosing a single body is not.

Commune: This spell will not function outside the crystal spheres in the phlogiston, as it requires contact with other planes of existence.

Commune with Nature: The spell can only be successfully cast on planets of size class C or larger.

Control Winds: This spell can be used to reduce the effects of weather on planetary surfaces to allow safe landing. It can also be used to increase or decrease the maneuverability class of a ship in the phlogiston by one.

Flame Strike: In the phlogiston, the *flame strike* detonates upon the caster, inflicting 8 points of damage on him and all within 5 feet of him (saving throws applicable).

Magic Font: The *magic font* (and the *crystal ball*, which it imitates) can view other crystal spheres, as well as the phlogiston. If used in the phlogiston, it cannot view other planes.

Plane Shift: This spell cannot be cast in the phlogiston, as it requires access to other planes to function.



Raise Dead: This spell operates normally in both wildspace and the phlogiston.

Transmute Rock to Mud: This spell can be used to inflict hull damage on ships made of rock or stone. For every 20-foot cube affected, 1-6 points of hull damage are inflicted on the ship.

Wall of Fire: The spell will not burn in the void, so that if the spell extends beyond the boundaries of the atmospheric envelope, the additional length is lost. If cast in the phlogiston, it becomes a tight pillar of flame centered on the caster, inflicting 4d4 points + 1 point of damage to the caster, 2d4 points to all within 10 feet, and 1d4 points to all within 20 feet. The spell only functions one round in this form.

Sixth Level Spells

Aerial Servant: The aerial servant can cross the void between air envelopes under its own power. It cannot be summoned in the phlogiston, as the spell requires access to other planes.

Blade Barrier: A ship that sails into a blade barrier suffers 1 point of hull damage for every 10 hit points the barrier inflicts, provided that the ship can be affected by the blades. Wood, ceramics, cloth, and living material are vulnerable, while rock and steel are immune to its effects. Living subjects on deck can be affected by the spell.

Conjure Fire Elemental: Use of this spell requires access to the Elemental Plane of Fire, and as such cannot be used in the phlogiston. A fire elemental brought into the phlogiston will immediately explode, inflicting its 1d8 of damage for each of

its hit dice to all within 20 feet and causing possible hull damage to the ship as well.

Fire Seeds: Fire seeds can be used in the phlogiston with normal effects.

Wall of Thorns: When cast in the path of a ship, exposed crew will take damage as if crashing into the barrier. Exposed sails and rigging will suffer damage, and the ship's maneuverability class will be worsened by one. Vessels of less than one ton per level of the caster will be stopped.

Weather Summoning: This spell can only be cast on a planetary body of size B or greater.

Word of Recall: This spell will not function in the phlogiston. It can be used to recall the cleric from another crystal sphere to his home sphere.



Finally, a voyager from Greyhawk can move both to Krynnspace and Realmspace, and has a higher chance of visiting a "random world" as well:

GREYSPACE

Travels to: Realms and Krynn

Cannot Travel to: Undetermined

Variable Travel: All Others (60%)

Therefore a voyager on Krynn seeking to make landfall on Greyhawk would best travel first to the Realms, and then to Greyhawk from there. There are spheres other than these three, including probably the DM's own personal campaign, and these may "come into phase" with that campaign.



Seventh Level Spells

Astral Spell: This spell cannot be cast in the phlogiston, as it accesses the Astral plane. A priest using the *astral spell* whose body is taken out into the phlogiston cannot return to his body until the body is brought back within a crystal sphere.

Chariot of Sustarre: This spell cannot function in the the phlogiston, as it requires access to the Elemental Plane of Fire. The *chariot* can move through space, and retain air as if a ship of 7 tons, providing sufficient air for its passengers. If taken into the phlogiston, the chariot explodes, inflicting 10-60 points of damage (save versus spells for half damage) to all within 30 feet of it.

Conjure Earth Elemental: This spell cannot be cast in the phlogiston, as it requires access to another plane.

Control Weather: This spell can be cast only on planets of size class B or greater. It can be used to modify adverse conditions for take-offs and landings.

Earthquake: In space, an *earthquake* can affect ships made of stone, as well as asteroids and small earth-based planets. Stone ships are treated as structures for damage, while various parts of asteroids are treated as normal ground terrain. If the area of an earthquake completely encloses an asteroid or stone ship, make a saving throw versus crushing blow for the stone to see if the ship or asteroid breaks up entirely.

Fire Storm: In the phlogiston, this spell will erupt directly upon the caster, and will extend to the maximum area of effect possible centered on the caster, inflicting 2d8 points of damage plus one point per level of the caster. If used against wooden ships, the spell ignites fires within the entire area of effect, inflicting hull damage as described in the section on fires.

Gate: This spell does not function in the phlogiston, as it creates a portal to another plane. When cast in void, it functions normally.

Holy Word: In the phlogiston, this has all its normal effects, except that it will not return creatures to their home planes.

Resurrection: This spell functions normally in both wildspace and the phlogiston.

Succor: Like the *word of recall*, this does not function in the phlogiston.

Wind Walk: A windwalking individual who attempts to cross the void between atmospheric envelopes does not bring any atmosphere along with him other than that of his own form, and if forced to return to normal shape becomes adrift in the void.

Magical Items

In general, magical items function under the same limitations as related spells. In particular:

Items that summon creatures from other planes (including *rings of djinn summoning*, *horns of valhalla*, and the like) will not function in the phlogiston, as access to the other planes is not possible.

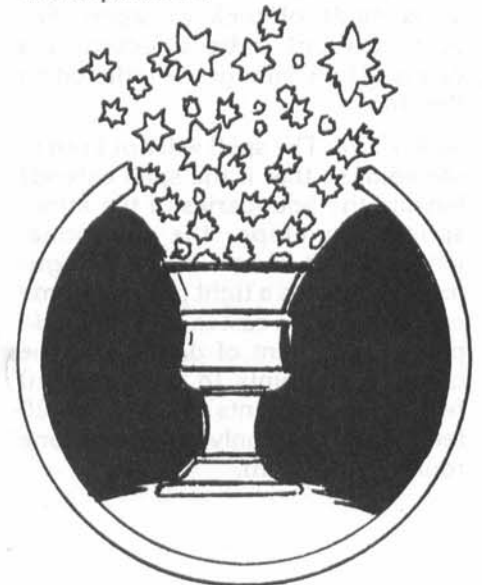

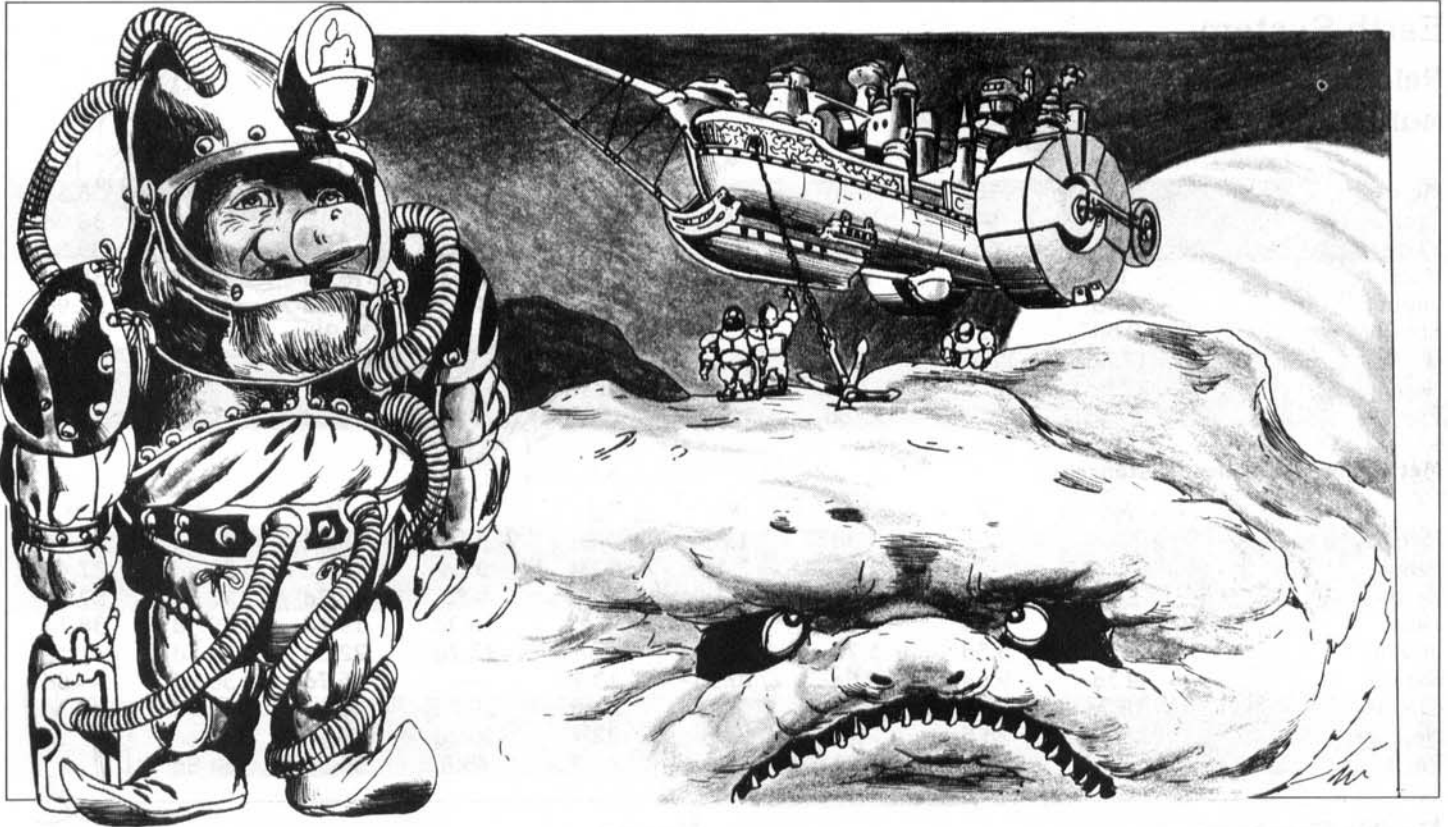

Items that open into or create extra-dimensional space (such as the *portable hole*) do not function in the phlogiston.

Items that create fire (such as a *wand of fireballs*), if used in the phlogiston, will cause the fire to appear suddenly around the caster, inflicting the listed damage. Items that cast flame across a distance will not do so if it requires the flame to leave the atmospheric envelope.

Items that rely on sound for their effects (*drums of panic*) will not function if the subject is separated by the void from the item.

Items that inflict damage in hit points inflict damage to ships in hull points: for every 10 hit points so inflicted, the ship takes one point of hull damage. Certain ship materials may be immune or particularly vulnerable to certain attack forms, at

the DM's option.

Items that permit flight function normally in space, the caster bringing a limited atmosphere with him.

Other Notes

Ring of Shooting Stars: This ring will always function in space normally.

Rod of Cancellation: The spelljamming devices are treated as relics for the purpose of determining the effects of the rod.

Chime of Opening: This can be used to open a portal in a crystal shell.

Lyre of Building: This item can be used to build or repair ships.

Mattock of the Titans: If used against ships made of wood, ceramic, or stone, this item inflicts one point of hull damage for every 10 hit points of damage.

Maul of the Titans: If used against any ship, this inflicts one point of hull damage for every 10 hit points of damage rolled (drop fractions).

Spade of Colossal Excavation: If used against ships made of earth or soil (not stone), the spade inflicts 1-4 hull points of damage each round.

Final Note on Magical Pluses of Weapons and Armor (in regards to planar versus spacial travel): When traveling between crystal spheres, a magical weapon, suit of armor, or shield does not lose any of its pluses or benefits. When traveling in a planar fashion (such as entering the Astral plane and then reappearing in another part of the Prime Material plane within a different crystal sphere), normal planar rules apply and the weapon or armor loses one plus for every plane crossed.

APPENDIX 2: TRAVEL TIMES

Earth System

Relative Travel Times Between Planets

Method One—Closest Approach

	Me	V	E	Ma	J	S	U	N	P
Mercury	—	7h	13h	1d	4.4d	8.5d	17.4d	27.5d	36.3d
Venus	7h	—	6h	18h	4.1d	8.2d	17.1d	27.2d	36.0d
Earth	13h	6h	—	12h	3.9d	8.0d	16.9d	27.0d	35.8d
Mars	1d	18h	12h	—	3.4d	7.5d	16.4d	26.5d	35.3d
Jupiter	4.4d	4.1d	3.9d	3.4d	—	4.1d	13.0d	23.1d	31.9d
Saturn	8.5d	8.2d	8.0d	7.5d	4.1d	—	7.9d	19.0d	27.8d
Uranus	17.4d	17.1d	16.9d	16.4d	13.0d	7.9d	—	10.1d	18.9d
Neptune	27.5d	27.2d	27.0d	26.5d	23.1d	19.0d	10.1d	—	8.8d
Pluto	36.3d	36d	35.8d	35.3d	31.9d	27.8d	18.9d	8.8d	—

Method Two—Farthest Distance

	Me	V	E	Ma	J	S	U	N	P
Mercury	—	1.1d	1.3d	1.8d	5.2d	9.3d	18.2d	28.3d	37.1d
Venus	1.1d	—	1.6d	2.1d	5.5d	9.6d	18.5d	28.6d	37.4d
Earth	1.3d	1.6d	—	2.3d	5.7d	9.8d	18.7d	28.8d	37.6d
Mars	1.8d	2.1d	2.3d	—	6.2	10.3d	19.2d	29.3d	38.1d
Jupiter	5.2d	5.5d	5.7d	6.2d	—	13.7d	22.6d	32.7d	41.5d
Saturn	9.3d	9.6d	9.8d	10.3d	13.7	—	26.7d	36.8d	45.6d
Uranus	18.2s	18.5	18.7	19.2	22.6	26.7d	—	45.7d	54.5d
Neptune	28.3d	28.6	28.8	29.3	32.7	36.8d	45.7d	—	64.6d
Pluto	37.1d	37.4	37.6	38.1	41.5	45.6	54.5d	64.6d	—

Earth System

Distances and Travel Times from the Primary (Sun)

Mercury	36 million miles	9 hours
Venus	67 million miles	16 hours
Earth	92 million miles	22 hours
Mars	141 million miles	1.4 days
Jupiter	483 million miles	4.8 days
Saturn	887 million miles	8.9 days
Uranus	1783 million miles	17.8 days
Neptune	2794 million miles	27.9 days
Pluto	3666 million miles	36.7 days

Krynn

Distances and Travel Times from the Primary (Sun)

Sirion	30 million miles	7 hours
Reorx	50 million miles	12 hours
Krynn	100 million miles	24 hours (1 day)
Chislev	300 million miles	3 days
Zivilyn	600 million miles	6 days

Krynn

Relative Travel Times Between Planets

Method One—Closest Approach

	S	R	K	C	Z
Sirion	—	5h	17h	2.7d	5.7d
Reorx	5h	—	12h	2.5d	5.5d
Krynn	17h	12h	—	2d	5d
Chislev	2.7d	2.5d	2d	—	3d
Zivilyn	5.7d	5.5d	5d	3d	—

Method Two—Farthest Approach

	S	R	K	C	Z
Sirion	—	19h	1.3d	3.3d	6.3d
Reorx	19h	—	1.5d	3.5d	6.5d
Krynn	1.3d	1.5d	—	4d	7d
Chislev	3.3d	3.5d	4d	—	9d
Zivilyn	6.3d	6.5d	7d	9d	—

Greyhawk

Relative Travel Times Between Planets

Method One—Closest Approach

	K	R	L	Gri	E	Gn	C	Gi	B	Gre	Sp
Kule	—	5h	22h	1.9d	3.9d	5.9d	9.9d	14.9d	19.9d	29.9d	39.9d
Raenei	5h	—	17h	1.7d	3.7d	5.7d	9.7d	14.7d	19.7d	29.7d	39.7d
Liga	22h	17h	—	1d	3d	5d	9d	14d	19d	29d	39d
The Grinder	1.9d	1.7d	1d	—	2d	4d	8d	13d	18d	28d	38d
Edill	3.9d	3.7d	3d	2d	—	2d	6d	11d	16d	26d	36d
Gnibile	5.9d	5.7d	5d	4d	2d	—	4d	9d	14d	24d	34d
Conatha	9.9d	9.7d	9d	8d	6d	4d	—	5d	10d	20d	30d
Ginsel	14.9d	14.7d	14d	13d	11d	9d	5d	—	5d	15d	25d
Borka	19.9d	19.7d	19d	18d	16d	14d	10d	5d	—	10d	20d
Greela	29.9d	29.7d	29d	28d	26d	24d	20d	15d	10d	—	10d
The Spectre	39.9d	39.7d	39d	38d	38d	34d	30d	25d	20d	10d	—

Method Two—Farthest Approach

	K	R	L	Gri	E	Gn	C	Gi	B	Gre	Sp
Kule	—	9h	1.1d	2.1d	4.1d	6.1d	10.1d	15.1d	20.1d	30.1d	40.1d
Raenei	9h	—	1.3d	2.3d	4.3d	6.3d	10.3d	15.3d	20.3d	30.3d	40.3d
Liga	1.1d	1.3d	—	3d	5d	7d	11d	16d	21d	31d	41d
The Grinder	2.1d	2.3d	3d	—	6d	8d	12d	17d	22d	32d	42d
Edill	4.1d	4.3d	5d	6d	—	10d	14d	19d	24d	34d	44d
Gnibile	6.1d	6.3d	7d	8d	10d	—	16d	21d	26d	36d	46d
Conatha	10.1d	10.3d	11d	12d	14d	16d	—	25d	30d	40d	50d
Ginsel	15.1d	15.3d	16d	17d	19d	21d	25d	—	35d	45d	55d
Borka	20.1d	20.3d	21d	22d	24d	26d	30d	35d	—	50d	60d
Greela	30.1d	30.3d	31d	32d	34d	36d	40d	45d	50d	—	70d
The Spectre	40.1d	40.3d	41d	42d	44d	46d	50d	55d	60d	70d	—

Greyhawk

Distances and Travel Times from the Primary (Oerth)

Kule	10 million miles	2 hours
Raenei	30 million miles	7 hours
Liga	100 million miles	1 day
The Grinder	200 million miles	2 days
Edill	400 million miles	4 days
Gnibile	600 million miles	6 days
Conatha	1000 million miles	10 days
Ginsel	1500 million miles	15 days
Borka	2000 million miles	20 days
Greela	3000 million miles	30 days
The Spectre	4000 million miles	40 days

Toril

Distances and Travel Times from the Primary (Sun)

Anadia	50 million miles	12 hours
Coliar	100 million miles	1 day
Toril	200 million miles	2 days
Kapri	300 million miles	3 days
Chandos	400 million miles	4 days
Glyth	1000 million miles	10 days
Garden	1200 million miles	12 days
H'Catha	1600 million miles	16 days

Toril

Relative Travel Times Between Planets

Method One—Closest Approach

	A	Co	T	K	Ch	Gl	Ga	H
Anadia	—	.5d	1.5d	2.5d	3.5d	9.5d	11.5d	15.5d
Coliar	.5d	—	1d	2d	3d	9d	11d	15d
Toril	1.5d	1d	—	1d	2d	8d	10d	14d
Kapri	2.5d	2d	1d	—	1d	7d	9d	13d
Chandos	3.5d	3d	2d	1d	—	6d	8d	12d
Glyth	9.5d	9d	8d	7d	6d	—	2d	6d
Garden	11.5d	11d	10d	9d	8d	2d	—	4d
H'Catha	15.5d	15d	14d	13d	12d	6d	4d	—

Method Two—Farthest Approach

	A	Co	T	K	Ch	Gl	Ga	H
Anadia	—	1.5d	2.5d	3.5d	4.5d	10.5d	12.5d	16.5d
Coliar	1.5d	—	3d	4d	5d	11d	13d	17d
Toril	2.5d	3d	—	5d	6d	12d	14d	18d
Karpri	3.5d	4d	5d	—	7d	13d	15d	19d
Chandos	4.5d	5d	6d	7d	—	14d	16d	20d
Glyth	10.5d	11d	12d	13d	14d	—	22d	26d
Garden	12.5d	13d	14d	15d	16d	22d	—	28d
H'Catha	16.5d	17d	18d	19d	20d	26d	28d	—

Outer Planetary Display

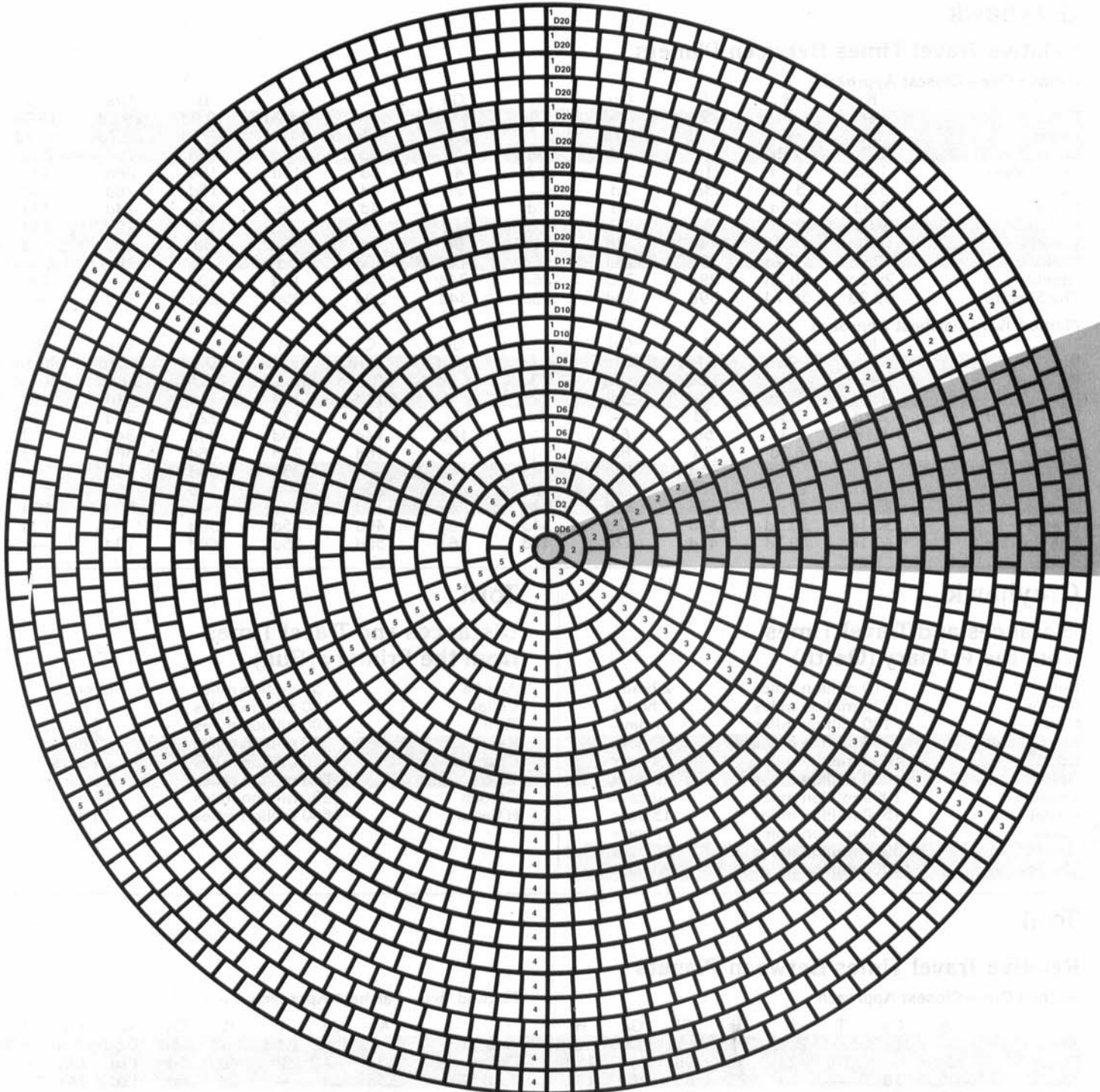

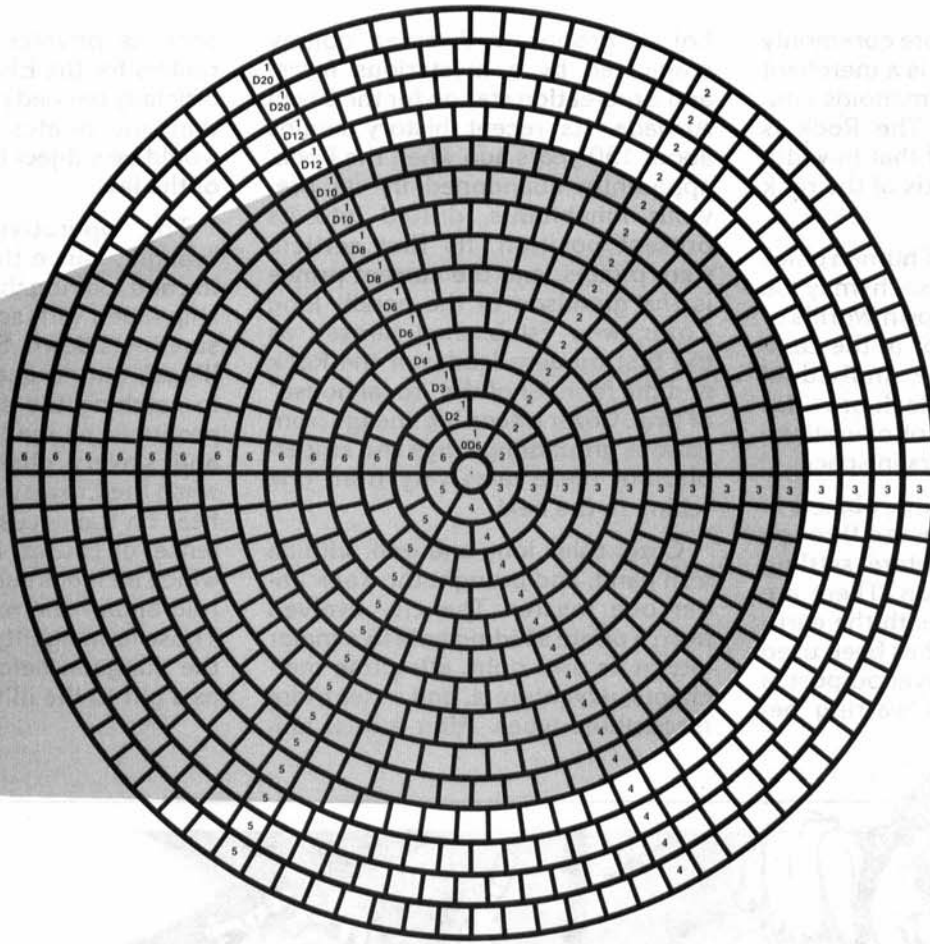

Inner Planetary Display

PLANET	SIZE	SHAPE	TYPE	PLANET	SIZE	SHAPE	TYPE
1				11			
2				12			
3				13			
4				14			
5				15			
6				16			
7				17			
8				18			
9				19			
10				20			

APPENDIX 4: THE ROCK OF BRAL

The Rock of Bral, more commonly just called "The Rock," is a merchant city of humans and humanoids situated on an asteroid. The Rock is about 1 mile long, half that in width and depth. The long axis of the rock is a rough oval shape.

The Rock is typical of human cities in wildspace, and as such may be placed in any of the Known Worlds of our fantasy universe, or in the campaign setting of the individual dungeon master. The Rock provides a hometown and base of operations for the player characters in space.

History: Like most large objects in space, the Rock has passed through a number of hands before settling into its present situation. There are ruins and caverns beneath the earth that indicate the Rock has been used in the past as a mind flayer outpost, a battleground between warring be-

holder groups, a dwarven colony eradicated by a mysterious force, and a recreation station for the Elven Armada. Its recent history begins about 150 years ago when the Rock, apparently abandoned by its previous inhabitants, drifted into its present position. Its first settlers were pirates, and the current prince is the grandson of the bandit king Cozar, who established himself as the first modern leader of the Rock and the founder of the "royal house" of Bral. Cozar traced his lineage from various groundling kings and emperors, but these tales vary from one telling to the next.

Cozar ruled long and well, with an iron hand, and brought the Rock under one master. The city evolved from a pirate's hiding hole to a major city in its own right, attracting merchants, adventurers, and other more respectable types. After a brief alli-

ance as privateers and commerce raiders for the Elven Armada, Cozar officially banned piracy and declared that any pirates that were caught would be subject to the full penalties of the law.

The operative word here is "caught," since there is much winking and looking the other way when a ship laden with someone else's treasures sets down. Similarly, slavery is illegal, but no one is very interested in catching the slavers if there are profits to be made. However, piracy and slavery charges are common when the Crown wishes to turn up the heat on the accused. The capital offense, of course, is betrayal of Bral, which includes endangering the asteroid and/or the royal house of Bral. Those found guilty are imprisoned in the dungeon before being provided as a gift to the illithid embassy.



Cozar ruled long and well, and his heir Frun took over the Rock upon his death. Frun was no pirate, but rather an overweight sybarite who enjoyed the treasures that others brought him. During his reign other factions began to take command of the daily rulership. There was an increase in the noble houses, who, like Prince Cozar, were not too long ago pirates and outlaws themselves. The other nonhuman races opened their own districts and embassies on the Rock as well. Frun became a figurehead, tucked neatly away in his palace.

Frun died festing and drinking, and was in turn succeeded by his son Calar. Calar was of the same stamp as his father, but died under mysterious circumstances within a week of taking the throne. His body was found floating in space just outside the Rock's atmospheric envelope. Calar's younger brother Andru quickly took the throne and rooted out the supposed assassins—a group of moneylenders backed by mind flayer forces. These were quickly dispatched, but rumors have since floated about that the moneylenders and mind flayers were people whom Andru owed money or favors to, and that he and they were all involved in Calar's death. By pinning the murder on the moneylenders and their mind flayer allies, Andru effectively covered his tracks.

Under Frun, various merchants, nobles, adventurers, and other factions increased their power and influence in the city. Now Prince Andru of Bral is merely one more player in a byzantine maze of medieval politics. He has his own agents and forces loyal to him, but must move carefully, as there are those who would rather see the Rock ruled by a more ineffectual adventurer or by a council that could more easily be dominated from outside.

The things that Andru often forgets is that the Rock is not his alone, and there have been others before him and his race arrived. The maze-work of tunnels and dungeon levels beneath the city is extensive and has never been fully explored. Undoubtedly, old artifacts and old enemies still lay within.

The Rock at a Glance

The City: The city of Bral is divided into a High City and a Low City. The High City runs along the trailing half of the asteroid and is dominated by the castle of Prince Andru. A long wall with numerous checkpoints separates High City from Low City.

Gravity Plane: The central plane of gravity runs lengthwise through the Rock. The "Upper" half of the Rock is dominated by the City of Bral itself. The "Lower" half is property of the prince, and used as a base for his private fleet.

Lake Bral: Bral has a large chasm just forward of Prince Andru's citadel, filled with water, which provides most of the water needs of the population. The chasm runs below the gravity plane of the asteroid, so that Lake Bral has two surfaces: one on the "top" of the asteroid, the other in a cavern deep within the heart of the Rock. Active animal cultures and "clean-up crew"-type monsters take care of most of the wastes.

The Edge: The Rock slopes away sharply from its top and bottom, forming cliffs which serve as a barrier from one side to the other. Internal passages often make transit easier, but the would-be rock climber runs the risk of falling off the Rock. Unless he hits a lower outjutting rock (80% chance), the falling individual will come to rest (eventually) at the level of the gravity plane and begin to drift away. Rescue stations are positioned about the Rock to provide lifelines for the unfortunate.

Underside: The "lower" half of the Rock is property of the prince and used both as a station for his naval units and as parkland to provide food and air for the Rock. The bulk of the underside is fields where convicted criminals and "servants of the king" (indentured slaves) do most of the work. Most of the Prince's naval units are found in an underside hangar. The largest buildings on the underside are the Citadel, a large, powerful fortress used in time of war, and the Vanes. The Vanes are huge sails made of the wing-leather of a radiant dragon. Though they provide no propulsion, the Vanes are deployed to provide some steering control to the ship in dangerous situations (like passing too close to a planet).

The Docks: Most ships approach Bral from the leading edge, where a set of wooden docks extends into wildspace to take in new arrivals (landing a ship in the city without the prince's permission is a major offense, good for a few months on underside as a field hand). Caverns at the gravity plane extend into the Rock itself, where storage areas have been established with hoists to the warehouses "upside."

The Caverns and Dungeons: The Rock is laced with caverns as well as carved tunnels and passages. Many of those near the surface are used by the citizenry as hiding holes in times of danger. The passages shown on the map reflect only a small portion



APPENDIX 4: THE ROCK OF BRAL

of the known "underdark" of the Rock.

Drydock: Drydock is a large, flat section of the Rock used by those ships which can land on earthlike surfaces for full repair. The drydock has complete services, and charges standard rates as listed in the section on Repair.

Markets: There are a myriad of shops throughout the Rock, but only two major open markets. The Great Market is at the midsection of the Rock, and carries not only new goods and shipments, but items that are too large to store or display. The Lesser Market, also called the Thieves' Market, is a smaller, more bustling, and more suspect operation. The regulars at the Thieves' Market may be dealing in fraudulent or stolen goods, so let the buyer beware.

Racial Districts: The Rock's population is mostly human, but with a large percentage of nonhuman races apparent as well. Though nonhumans can be found throughout the city, they tend to congregate in certain areas. The various recognized racial districts of the Rock are:

- The Burrows (Halflings)
- The Dwarven District
- The Dracon Enclave
- The Forest (Elves)
- Giff-Town (The Giff)

Gnomes are found throughout the Rock. The Shou have an embassy on the Rock and a community near the warehouses. Beholder tend to be solitary, unloved, and in hidden safehouses. There is a mind flayer embassy near the halfling district, but there are a smattering of the illithids from the lowtown throughout the gentry. There are no (official) neogi representatives on the Rock.

Temple District: There are a number of temples near Lake Bral, devoted to the major faiths and faith-collections of the area of wild-space that the Rock occupies. In ad-

dition to Polygots and Pantheists, there are churches of Ptah and the Oriental Path and the Way. Smaller nonhuman faiths tend to have small shrines in their racial districts.

The Graveyard: Most of the dead of Bral are immolated, composted, or cast adrift in space, in accordance with the wishes of relatives and faiths. Those that can afford to be interred are laid to rest here.

The Donjon: Not to be confused with the dungeon, the Donjon is a large edifice built to contain offenders and malefactors against the Crown. In addition to being used as auxiliary barracks for 200 of the Prince's men, the Donjon is where those judged too dangerous to work the fields of Underside are imprisoned until they are executed (in the open square just in front of the Donjon).

Festival Ground: A large green space tipped by a great arena, the Festival Ground shows Prince Frun's mind at work. When a dwarven mountain citadel was captured by neogi and used as a ram against Bral, a chunk of the city was leveled. Instead of rebuilding, Frun declared the ruined area a park and used the stone of the crashed vessel to build the arena. Official holidays (including the prince's birthday) are celebrated here.

Barracks: Abutting the prince's lands on the trailing edge of the Rock, the barracks house about 500 men. In addition, in times of emergency, the prince may recruit the noble militias (which range from 20 to 100 men each) and the Lower City militias for further aid.

Naval Strength

The full numbers of the prince's defenses are a state secret, but there are continual patrols of four hammer ships and four squid ships around the Rock. Street gossip puts the full

squadron strength at four times that, and in addition there are always ships to be hired at the Rock.

Other Defenses

Walls themselves do not provide much defense against space-based raiders, so instead the Lower and Upper Cities are littered with ballista towers to be used against enemy ships. Maintenance and operation of the towers are left to the district that they operate in, and in the case of the noble houses, possession of smoothly drilled crew is as much a requirement for high society as a worlds-renowned chef. The Palace, of course, has the highest concentration of defenses and includes bombard and greek fire projectors which are illegal elsewhere in the city (though the giff keep trying to bring them in).

Finally, Prince Andru has contracted with a group of independent wizards known as "The Fireball Alliance" for protective services. The Alliance numbers about two dozen, and in exchange for being treated as gentry and put in town houses, act as Andru's magical watch force.



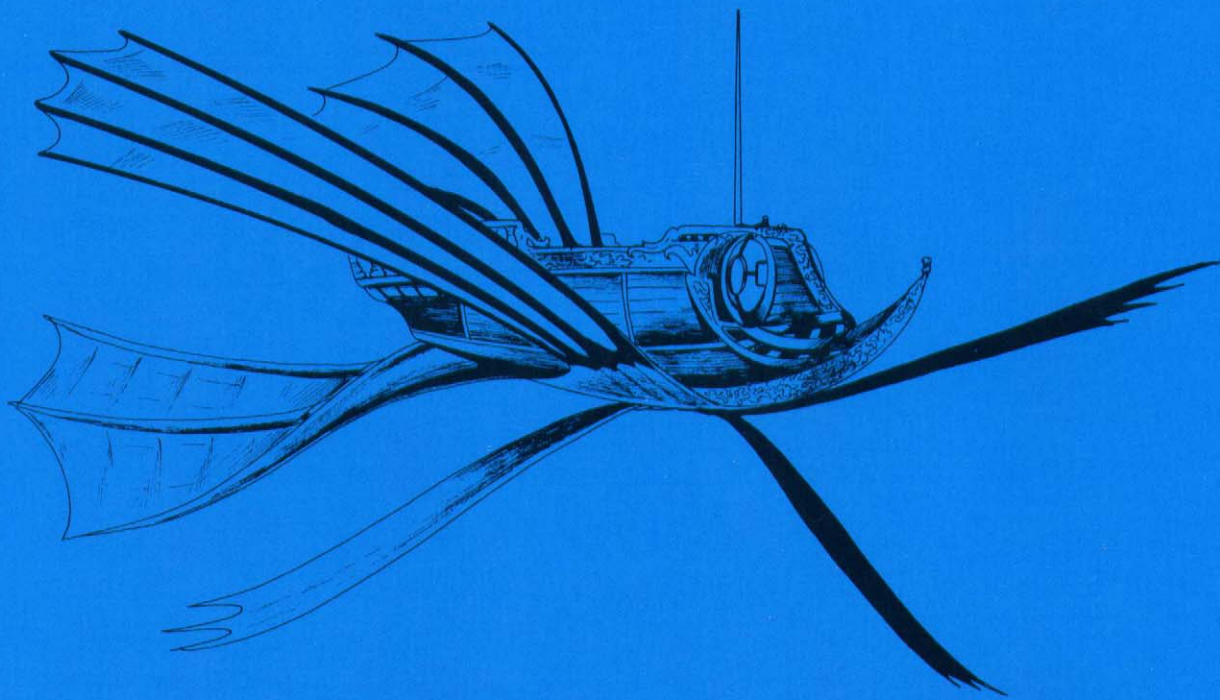

TSR, Inc.
PRODUCTS OF YOUR IMAGINATION™

ADVANCED DUNGEONS & DRAGONS, AD&D, SPELLJAMMER, PRODUCTS OF YOUR IMAGINATION,
and the TSR logo are trademarks owned by TSR, Inc.
©1989 TSR, Inc. All Rights Reserved. Printed in the U.S.A.

SIZE	A	SIZE	A	SIZE	A	SIZE	B	SIZE	B	SIZE	B	1
SIZE	B	SIZE	C	SIZE	C	SIZE	C	SIZE	C	SIZE	C	2
SIZE	C	SIZE	D	SIZE	D	SIZE	D	SIZE	D	SIZE	D	3
SIZE	D	SIZE	D	SIZE	D	SIZE	E	SIZE	E	SIZE	E	4
SIZE	E	SIZE	E	SIZE	F	SIZE	F	SIZE	F	SIZE	F	5
SIZE	F	SIZE	G	SIZE	G	SIZE	G	SIZE	G	SIZE	H	6
SIZE	H	SIZE	H	SIZE	I	SIZE	I	SIZE	J	SIZE	J	7
TYPE	A	TYPE	A	TYPE	E	TYPE	E	TYPE	F	TYPE	W	8
TYPE	A	TYPE	A	TYPE	E	TYPE	E	TYPE	F	TYPE	W	9
TYPE	A	TYPE	A	TYPE	E	TYPE	F	TYPE	F	TYPE	W	10
TYPE	A	TYPE	A	TYPE	E	TYPE	F	TYPE	F	TYPE	W	11
TYPE	A	TYPE	E	TYPE	E	TYPE	F	TYPE	F	TYPE	W	12
TYPE	A	TYPE	E	TYPE	E	TYPE	F	TYPE	F	TYPE	W	13
TYPE	A	TYPE	E	TYPE	E	TYPE	F	TYPE	W	TYPE	W	14
TYPE	A	TYPE	E	TYPE	E	TYPE	F	TYPE	W	TYPE	W	15
TYPE	A	TYPE	E	TYPE	E	TYPE	F	TYPE	W	TYPE	W	16
SHAPE	◆	SHAPE	◆	SHAPE	◆	SHAPE	◐	SHAPE	△	SHAPE	○	17
SHAPE	●	SHAPE	●	SHAPE	●	SHAPE	◐	SHAPE	△	SHAPE	○	18
SHAPE	●	SHAPE	●	SHAPE	●	SHAPE	◐	SHAPE	△	SHAPE	○	19
SHAPE	●	SHAPE	●	SHAPE	●	SHAPE	◐	SHAPE	△	SHAPE	○	20
SHAPE	●	SHAPE	●	SHAPE	●	SHAPE	†	SHAPE	□	SHAPE	○	21
SHAPE	●	SHAPE	●	SHAPE	✦	SHAPE	†	SHAPE	□	SHAPE	✿	22
SHAPE	●	SHAPE	●	SHAPE	✦	SHAPE	†	SHAPE	□	SHAPE	✿	23
SHAPE	●	SHAPE	●	SHAPE	✦	SHAPE	†	SHAPE	□	SHAPE	✿	24
SHAPE	●	SHAPE	●	SHAPE	✦	SHAPE	†	SHAPE	✿	SHAPE	✿	25

	SIZE	SIZE	SIZE	SIZE	SIZE	SIZE
1	SIZE	SIZE	SIZE	SIZE	SIZE	SIZE
2	SIZE	SIZE	SIZE	SIZE	SIZE	SIZE
3	SIZE	SIZE	SIZE	SIZE	SIZE	SIZE
4	SIZE	SIZE	SIZE	SIZE	SIZE	SIZE
5	SIZE	SIZE	SIZE	SIZE	SIZE	SIZE
6	TYPE	TYPE	TYPE	TYPE	TYPE	TYPE
7	TYPE	TYPE	TYPE	TYPE	TYPE	TYPE
8	TYPE	TYPE	TYPE	TYPE	TYPE	TYPE
9	TYPE	TYPE	TYPE	TYPE	TYPE	TYPE
10	TYPE	TYPE	TYPE	TYPE	TYPE	TYPE
11	TYPE	TYPE	TYPE	TYPE	TYPE	TYPE
12	TYPE	TYPE	TYPE	TYPE	TYPE	TYPE
13	SHAPE	SHAPE	SHAPE	SHAPE	SHAPE	SHAPE
14	SHAPE	SHAPE	SHAPE	SHAPE	SHAPE	SHAPE
15	SHAPE	SHAPE	SHAPE	SHAPE	SHAPE	SHAPE
16	SHAPE	SHAPE	SHAPE	SHAPE	SHAPE	SHAPE
17	SHAPE	SHAPE	SHAPE	SHAPE	SHAPE	SHAPE
18	SHAPE	SHAPE	SHAPE	SHAPE	SHAPE	SHAPE
19	SHAPE	SHAPE	SHAPE	SHAPE	SHAPE	SHAPE
20	SHAPE	SHAPE	SHAPE	SHAPE	SHAPE	SHAPE

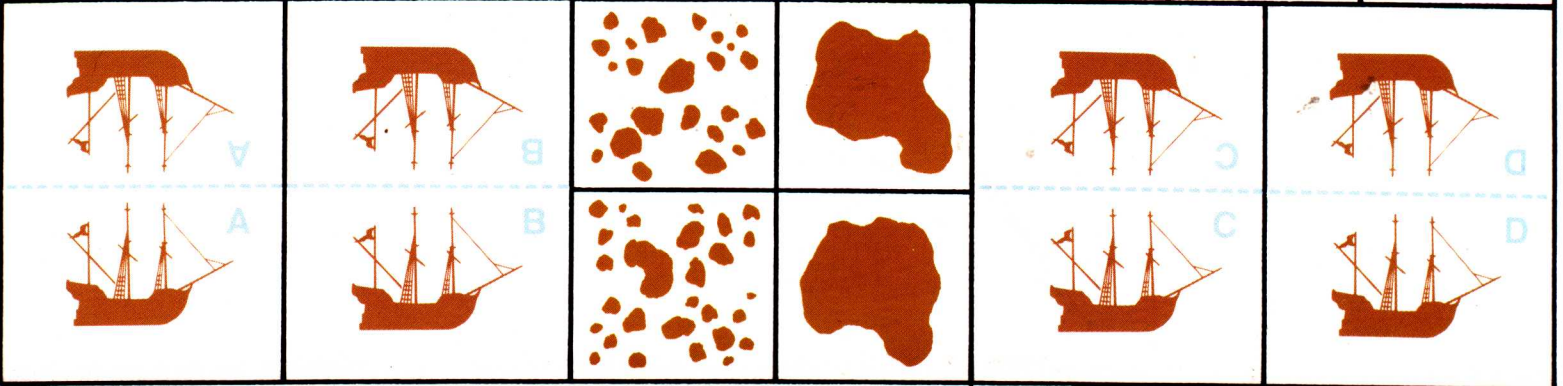
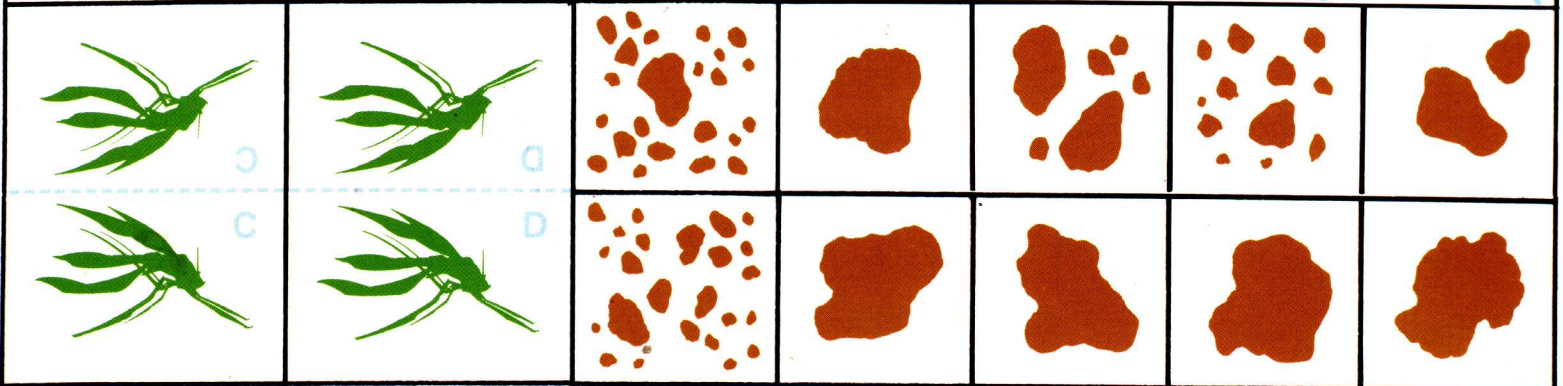
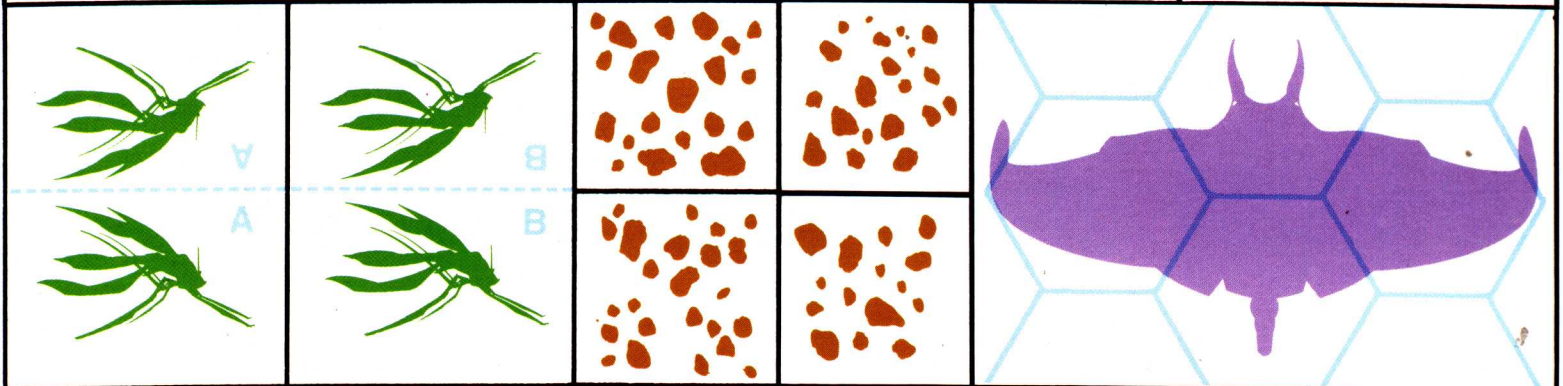
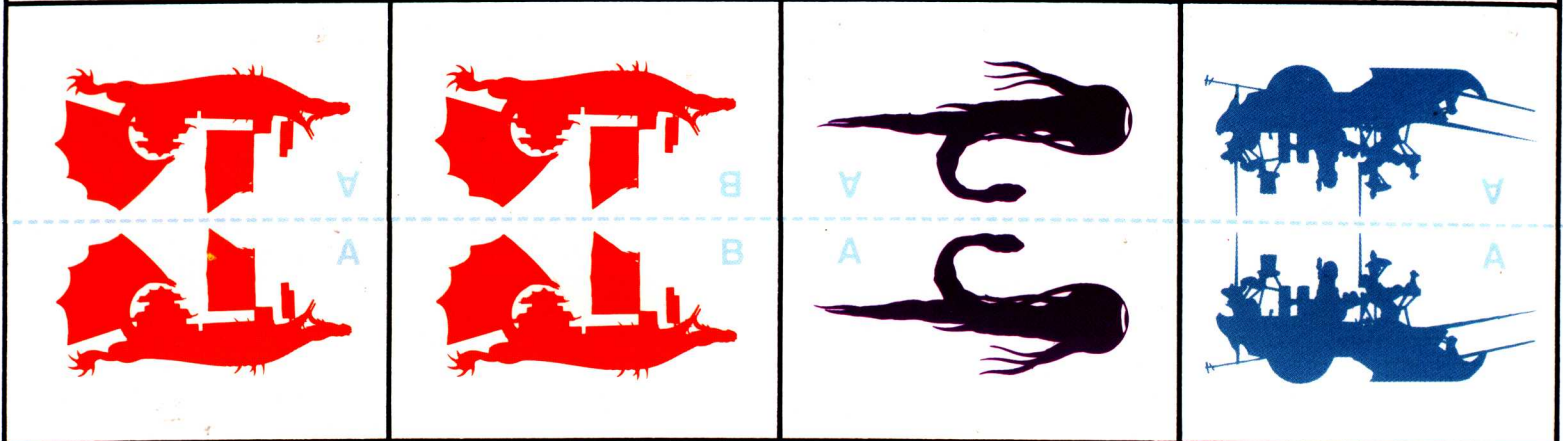
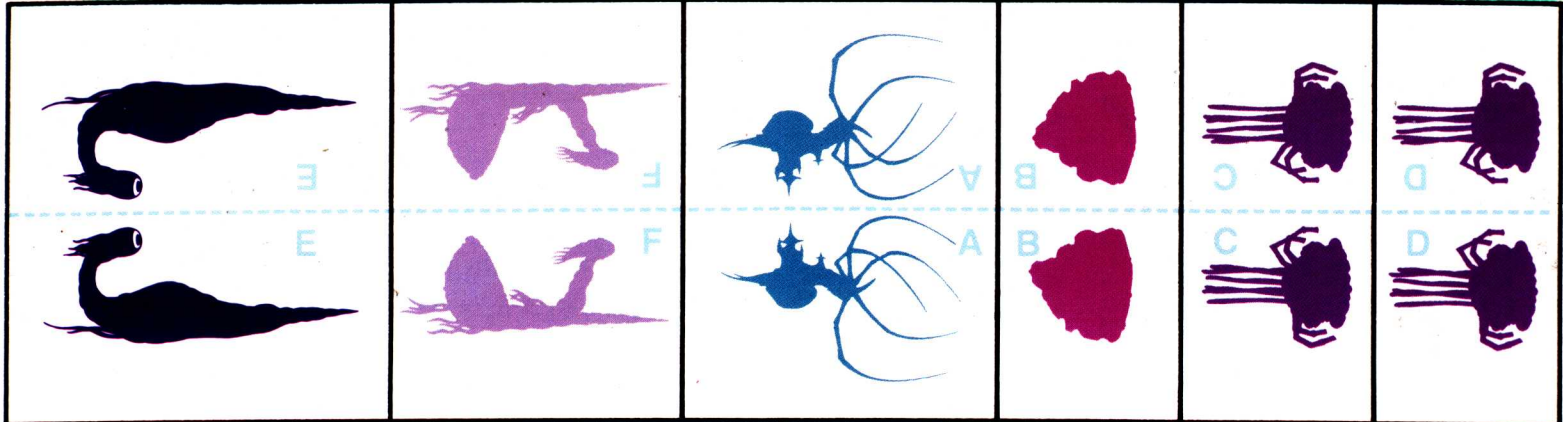

**TYRANT
SHIP**

**TYRANT
SHIP**

**TYRANT
SHIP**

MINDSPIDER

TYRANT SHIP

TYRANT SHIP

GNOME CLIPPER

TYRANT SHIP

DRAGON SHIP

DRAGON SHIP

SPELLJAMMER

DAMSEFLY

DAMSEFLY

DAMSEFLY

DAMSEFLY

GALLEON

GALLEON

GALLEON

GALLEON

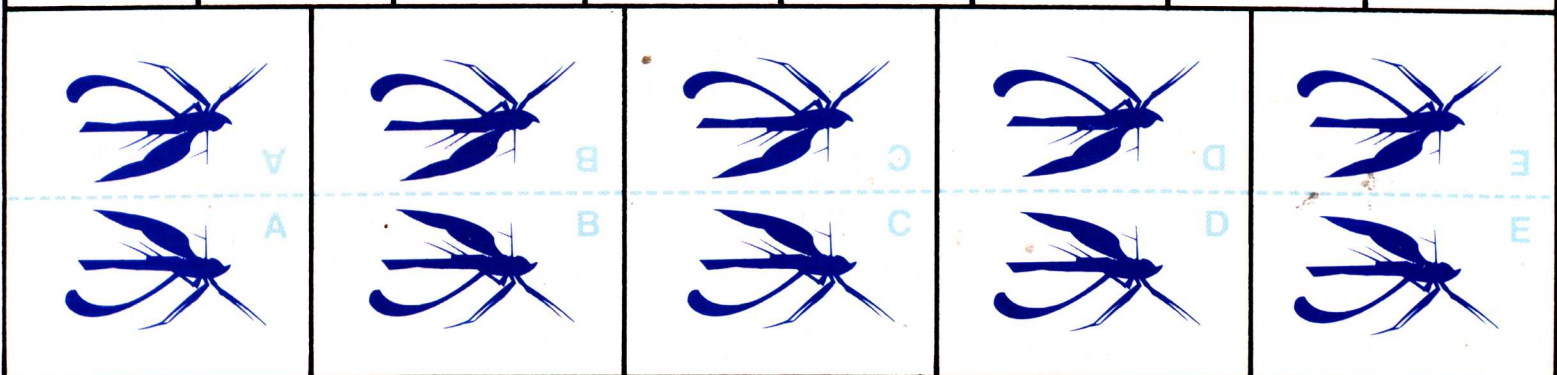
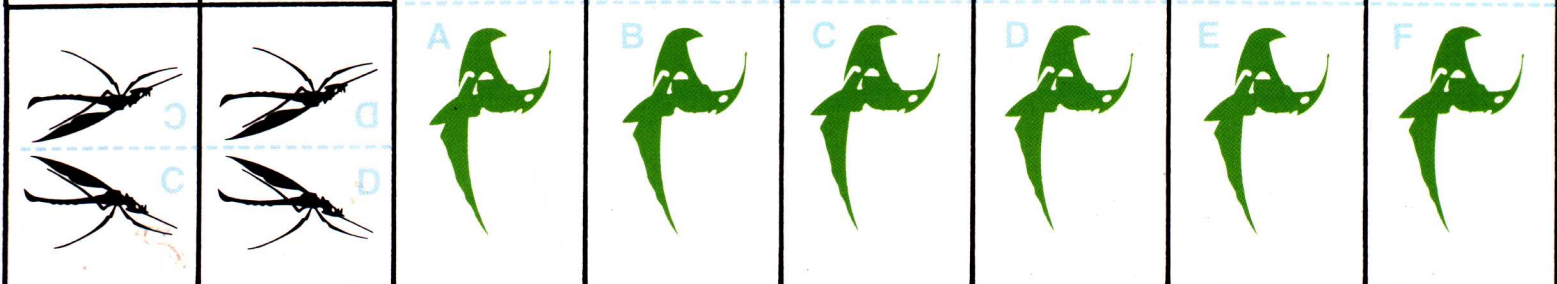
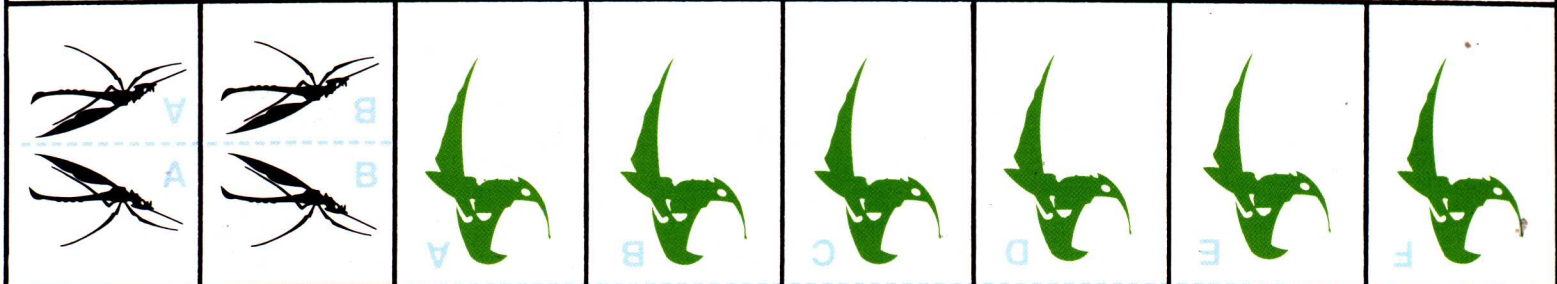
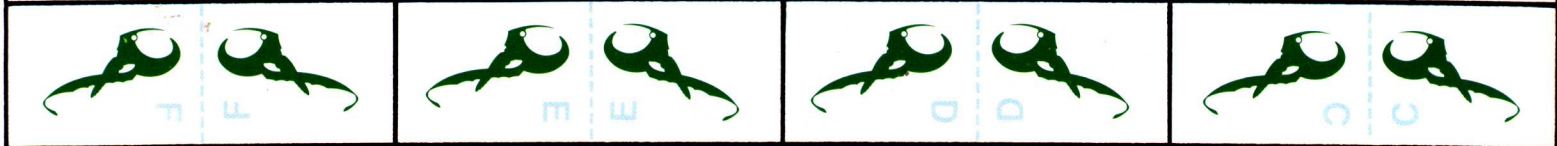
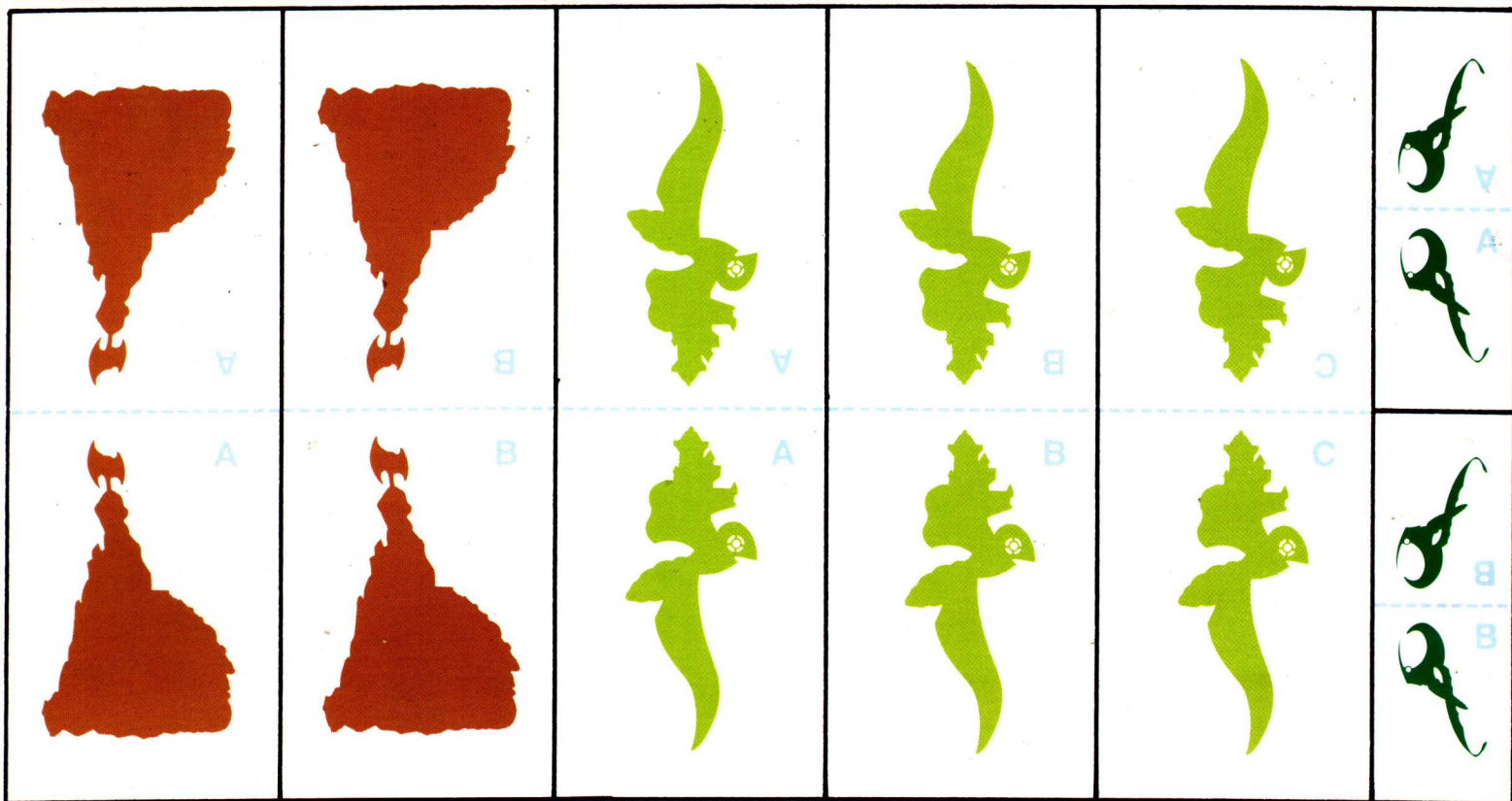

Directions: Cut ship counters out along dark lines. Fold along dotted lines and place in base provided.

FLITTER

ARMADA

ARMADA

ARMADA

DWARVEN CITADEL

DWARVEN CITADEL

FLITTER

FLITTER

FLITTER

FLITTER

FLITTER

MOSQUITO MOSQUITO

MANOWAR

MANOWAR

MANOWAR

MANOWAR

MANOWAR

MANOWAR

MOSQUITO MOSQUITO

DRAGONFLY

DRAGONFLY

DRAGONFLY

DRAGONFLY

DRAGONFLY

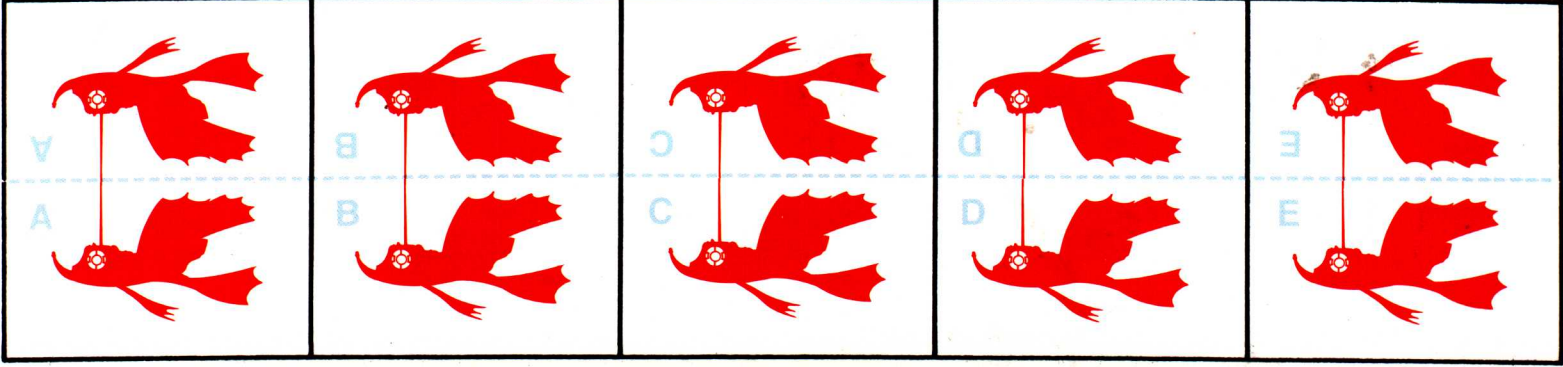
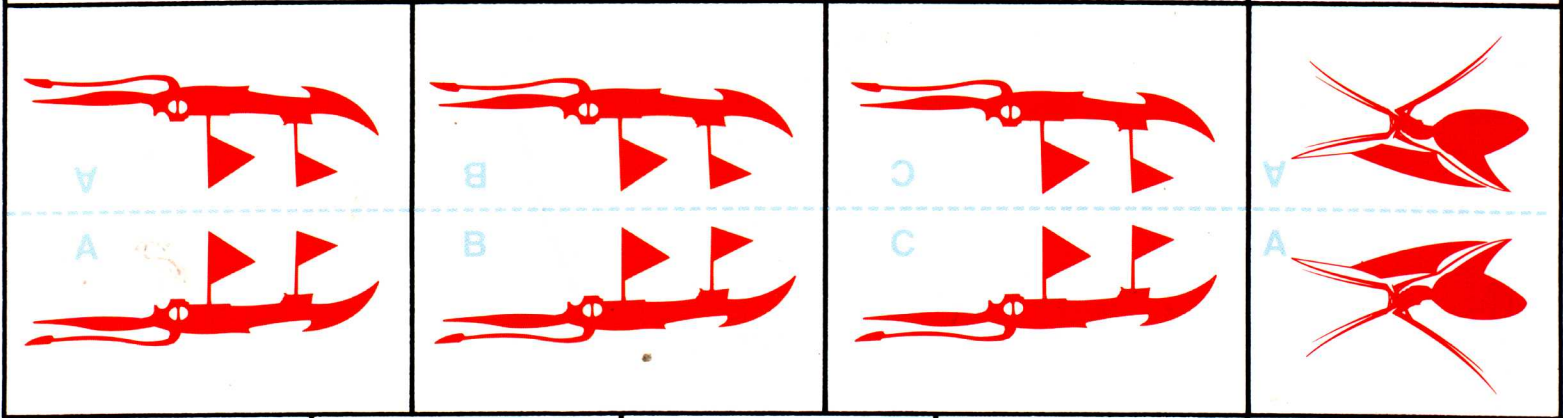
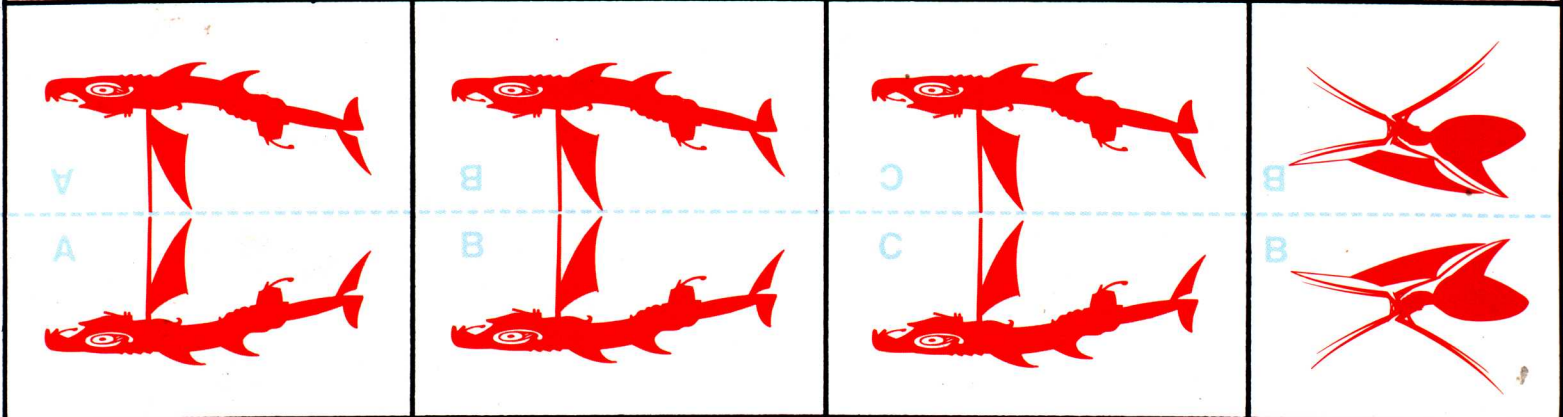
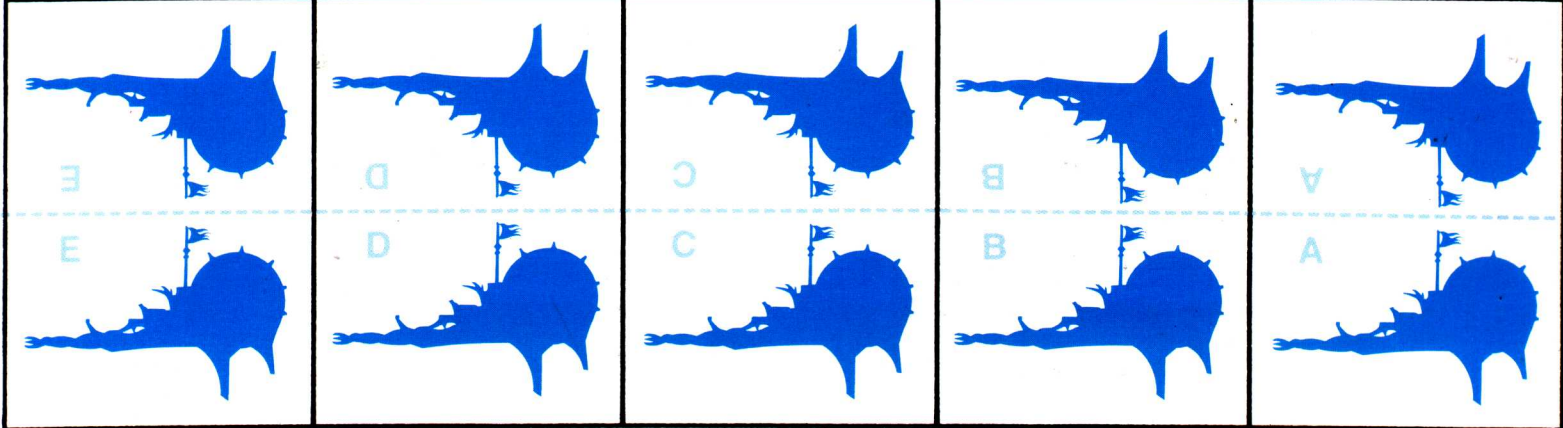
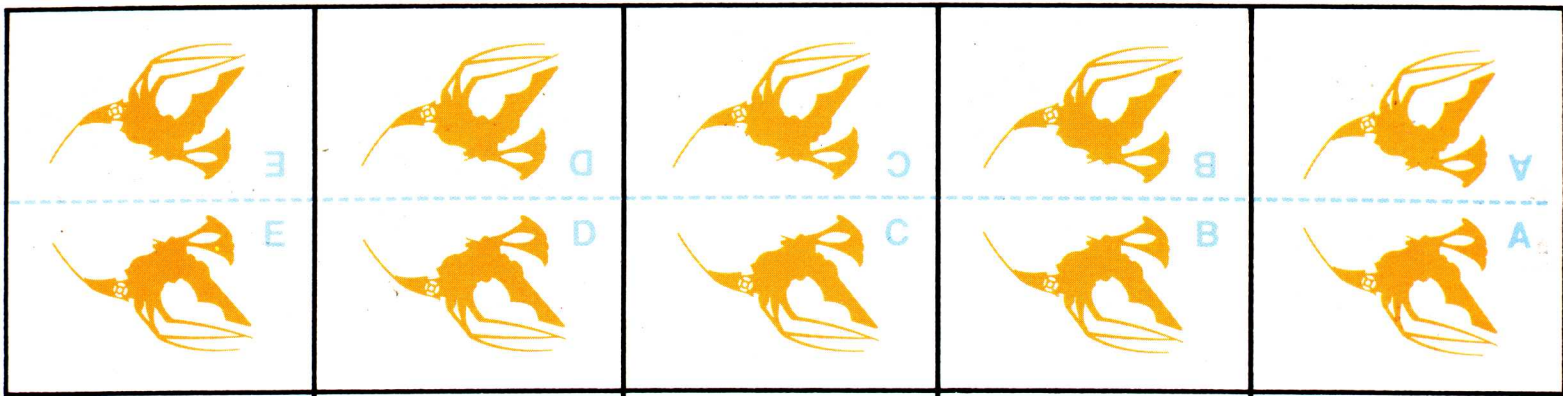

WASP

WASP

WASP

WASP

WASP

NAUTILOID

NAUTILOID

NAUTILOID

NAUTILOID

NAUTILOID

DEATHSPIDER

HAMMERSHIP

HAMMERSHIP

HAMMERSHIP

DEATHSPIDER

SQUIDSHIP

SQUIDSHIP

SQUIDSHIP

TRADESMAN

TRADESMAN

TRADESMAN

TRADESMAN

TRADESMAN

NEOGI DEATHSPIDER

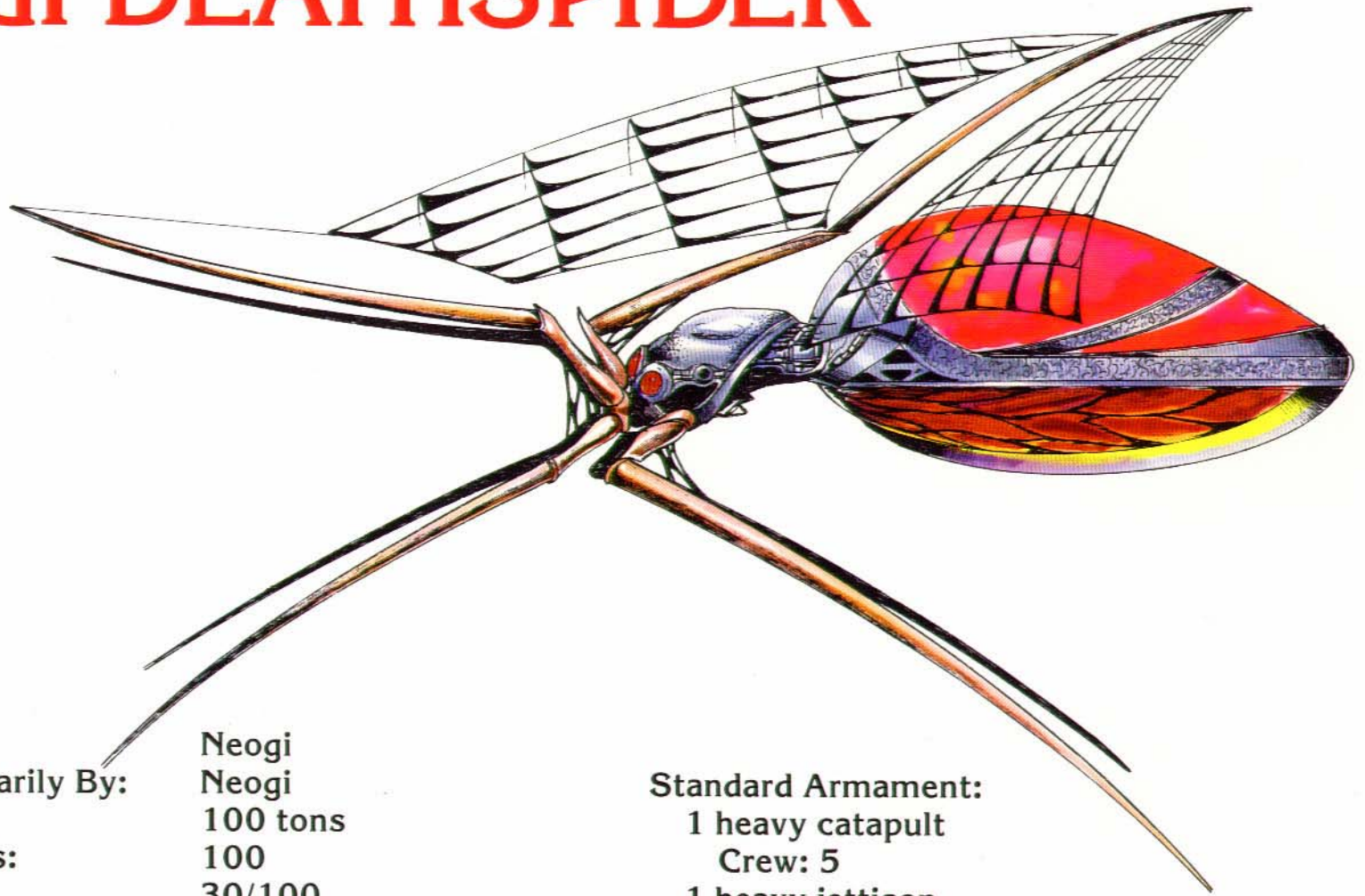

Built By:	Neogi
Used Primarily By:	Neogi
Tonnage:	100 tons
Hull Points:	100
Crew:	30/100
Maneuverability Class:	E
Landing—Land:	No
Landing—Water:	No
Armor Rating:	5
Saves As:	Crystal
Power Type:	Major helm
Ship's Rating:	As for spelljammer

Standard Armament:

1 heavy catapult

Crew: 5

1 heavy jettison

Crew: 4

4 heavy ballistae

Crew: 4 each

1 grappling ram

Cargo: 50 tons

Keel Length: 175'

Beam Length: 50'

DEATHSPIDER

One Square = 5 Feet

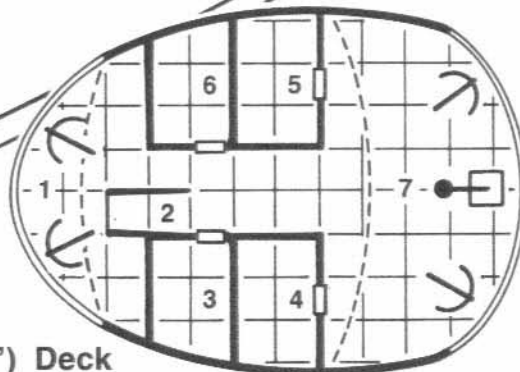

Citadel (or "Battle") Deck

- Primary Deck**
- 1 Bridge & Spelljamming Helm
 - 2 Captain/Owner's Cabin
 - 3 Captain/Owner's Treasures & Charts
 - 4 Helmsman's Quarters
 - 5 Forward Umber Hulk Pens
 - 6 Galley
 - 7 Pantry
 - 8 Sail Locker
 - 9 Helmsman's Locker
 - 10 Lesser Neogi Quarters
 - 11 Lesser Neogi Quarters
 - 12 Passageway
 - 13 Interrogation & Food Preparation Area
 - 14 Open Portal to Hold Deck
 - 15 Cargo Doors
 - 16 Flight Deck: Additional Cargo Area
 - 17 Ramp to Citadel Deck

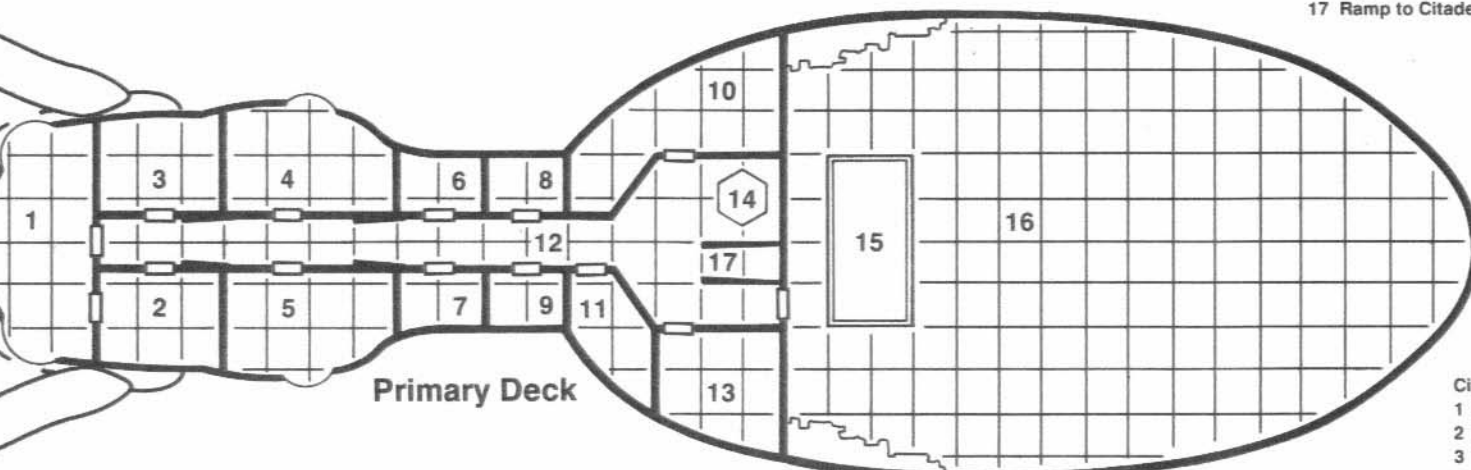

Primary Deck

- Citadel (or "Battle") Deck**
- 1 Forward Weapons Pit
 - 2 Ramp
 - 3 Lesser Neogi Quarters
 - 4 Lesser Neogi Quarters
 - 5 Umber Hulk Pens
 - 6 Armory
 - 7 Aft Weapons Pit

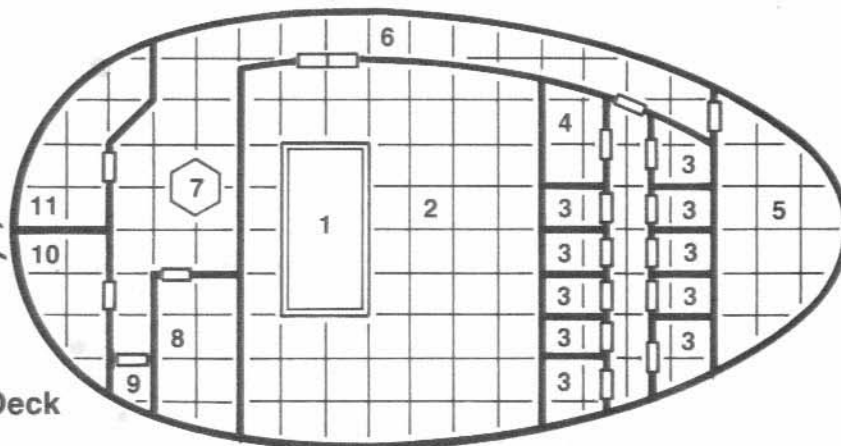

Hold Deck

- Hold Deck**
- 1 Cargo Doors
 - 2 Cargo Hold
 - 3 Slave Quarters
 - 4 Slavemaster Quarters
 - 5 Jettison & Storage
 - 6 Passageway
 - 7 Hatch to Primary Deck
 - 8 Visitors Cabin
 - 9 Head/Storage
 - 10 Lesser Neogi Quarters
 - 11 Lesser Neogi Quarters

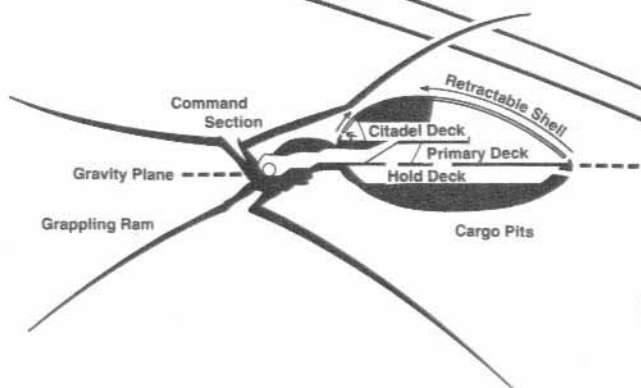

NEOGI MINDSPIDER

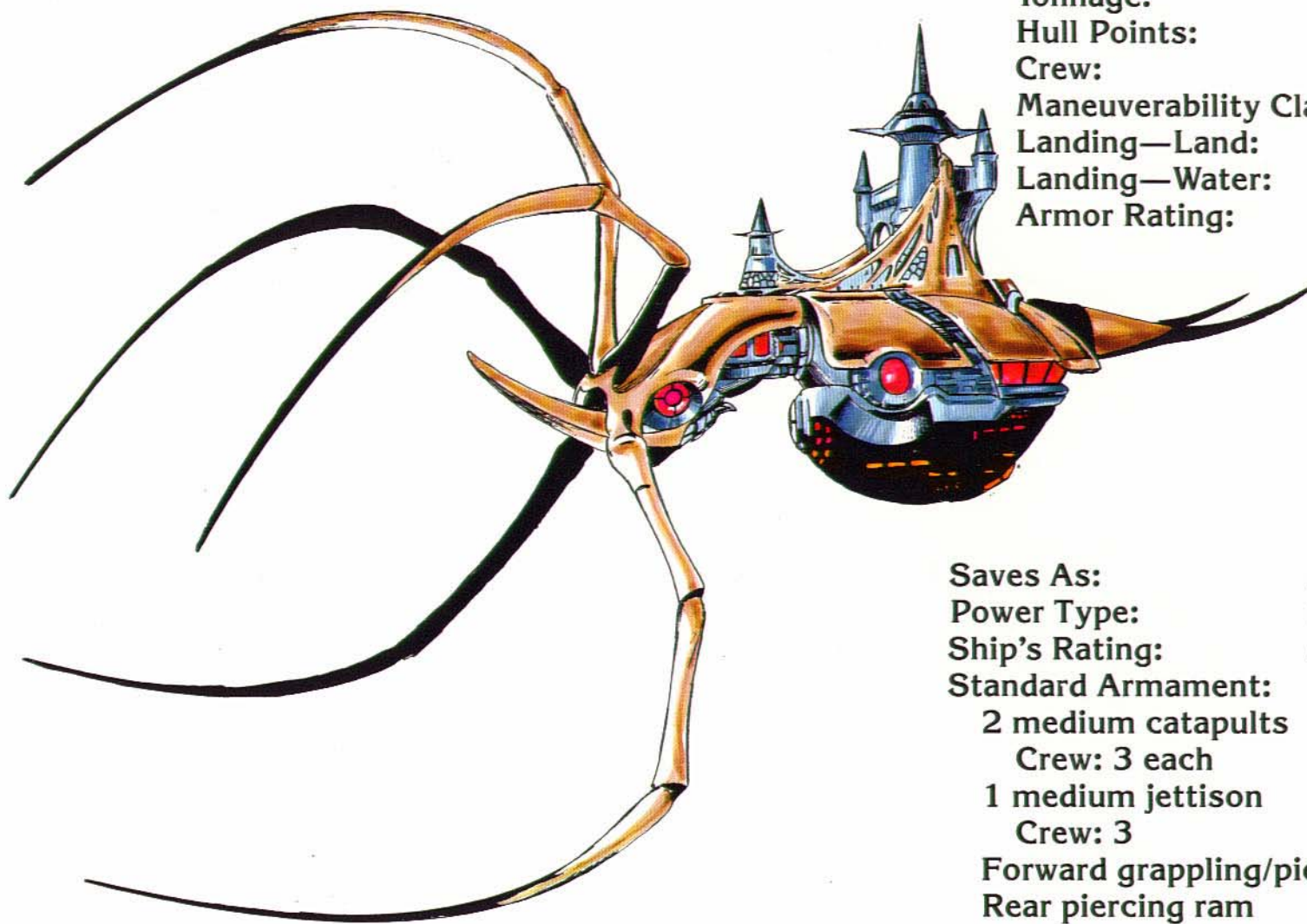

Built By:	Neogi
Used Primarily By:	Neogi
Tonnage:	40 tons
Hull Points:	40
Crew:	3/40
Maneuverability Class:	C
Landing—Land:	No
Landing—Water:	No
Armor Rating:	4

Saves As:	Metal
Power Type:	Lifejammer
Ship's Rating:	As for target
Standard Armament:	
2 medium catapults	
Crew: 3 each	
1 medium jettison	
Crew: 3	
Forward grappling/piercing ram	
Rear piercing ram	
Cargo:	20 tons
Keel Length:	40'
Beam Length:	15'

MINDSPIDER

One Square = 5 Feet

Primary Deck

- 1 Spelljamming Helm
- 2 Chart Room
- 3 Umber Hulk & Lower Neogi Quarters
- 4 Captain/Owner's Quarters
- 5 Open Port to Secondary Deck

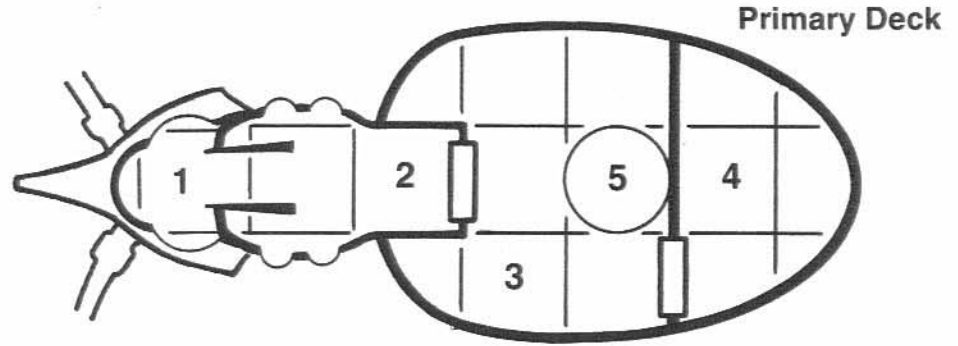

Secondary Deck

- 1 Jettison
- 2 Prisoners & Cargo Area
- 3 Hatch to Weapons Pit
- 4 Open Port to Primary Deck

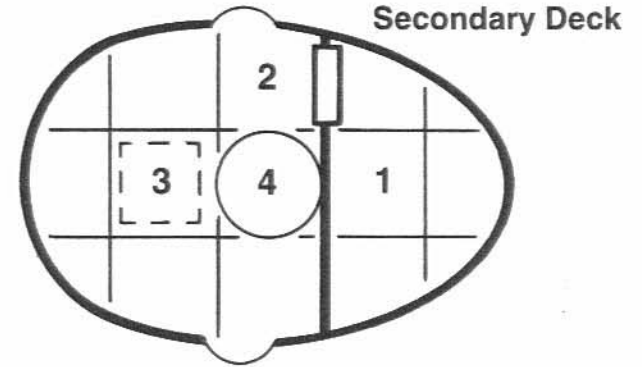

Weapons Pit

- 1 Catapults
- 2 Open Port to Secondary Deck
- 3 Retractable Dome

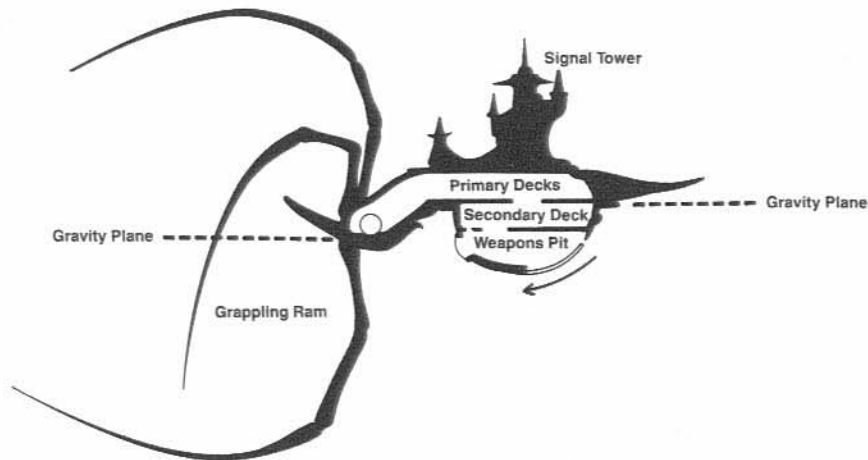
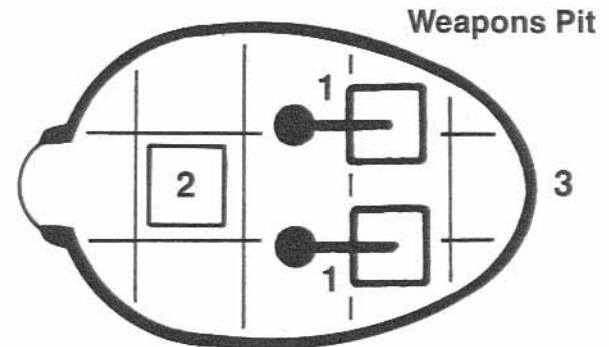

DRAGONFLY

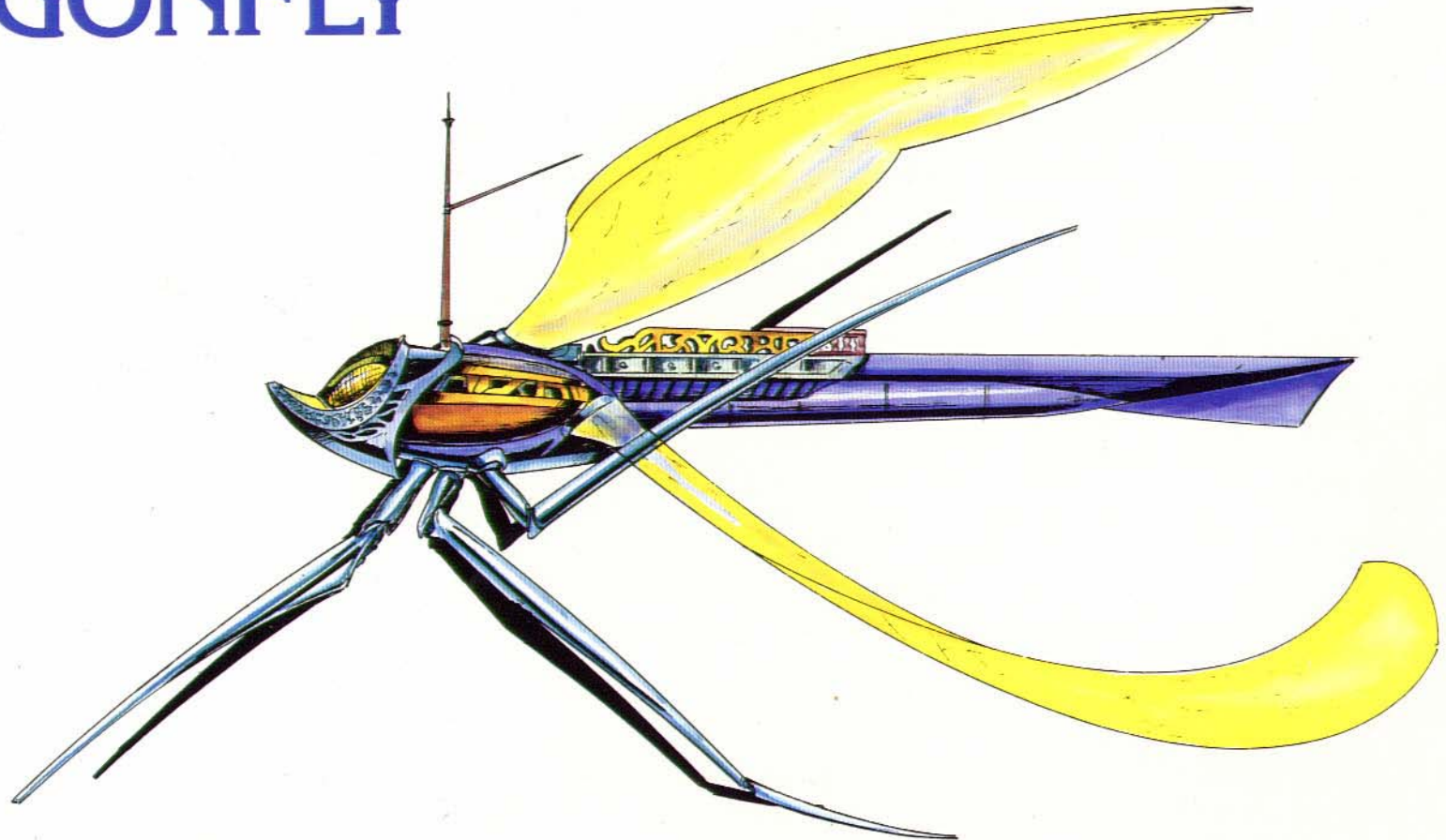

Built By:	Humans	Power Type:	Major or minor helm
Used Primarily By:	Humans, elves	Ship's Rating:	As for spelljammer
Tonnage:	10 tons	Standard Armament:	
Hull Points:	10	1 light ballista	
Crew:	3/10	Crew: 1	
Maneuverability Class:	C	OR 1 light catapult	
Landing—Land:	Yes	Crew: 1	
Landing—Water:	No	Cargo:	5 tons
Armor Rating:	8	Keel Length:	100'
Saves As:	Thin wood	Beam Length:	20'

DRAGONFLY

One Square = 5 Feet

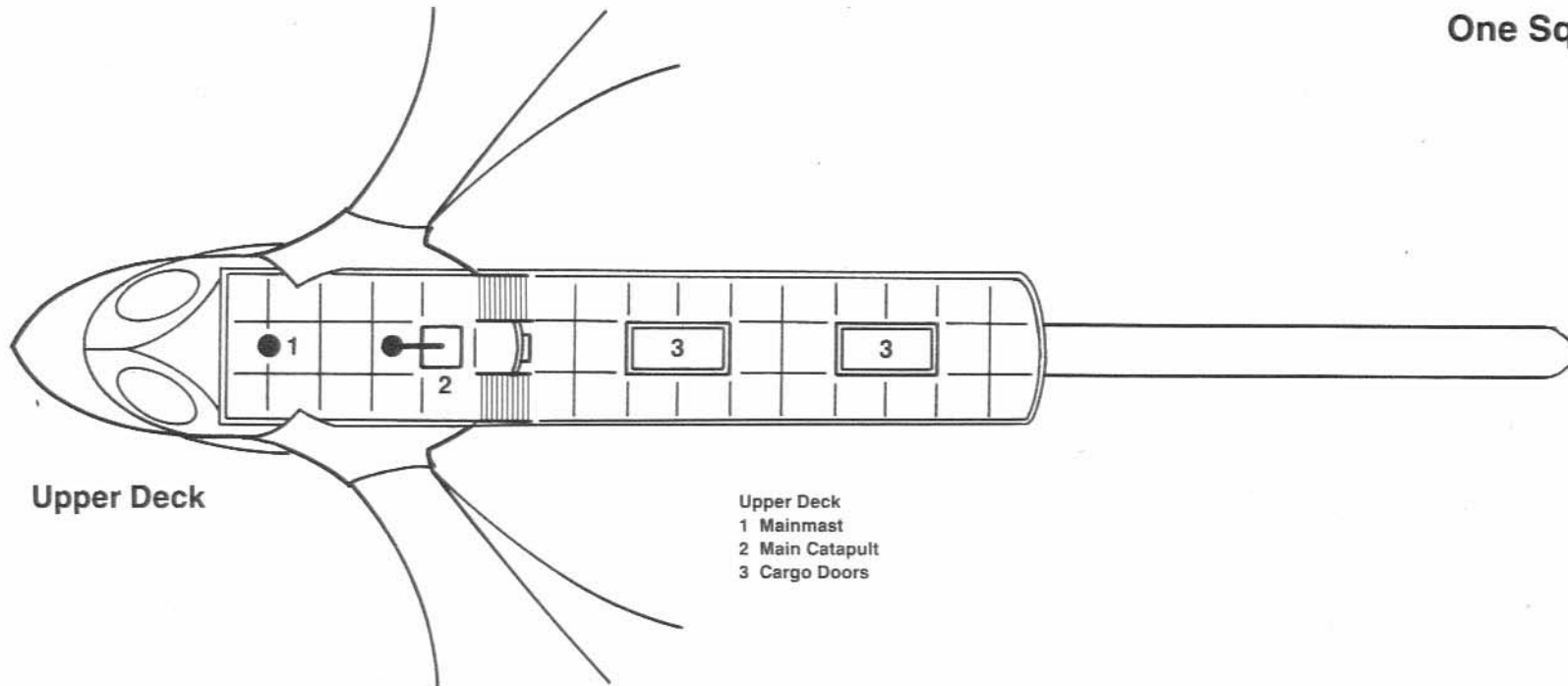

Upper Deck

- Upper Deck
1 Mainmast
2 Main Catapult
3 Cargo Doors

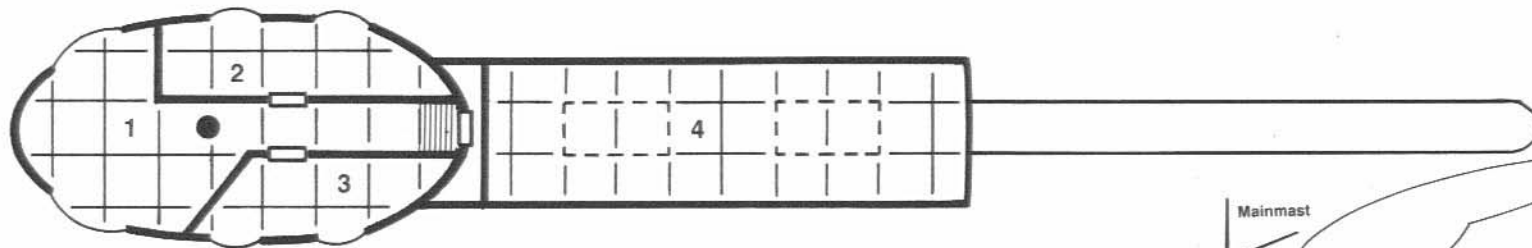

Lower Deck

- Lower Deck
1 Bridge & Spelljamming Helm
2 Captain's Cabin
3 Crew Cabin
4 Cargo Hold

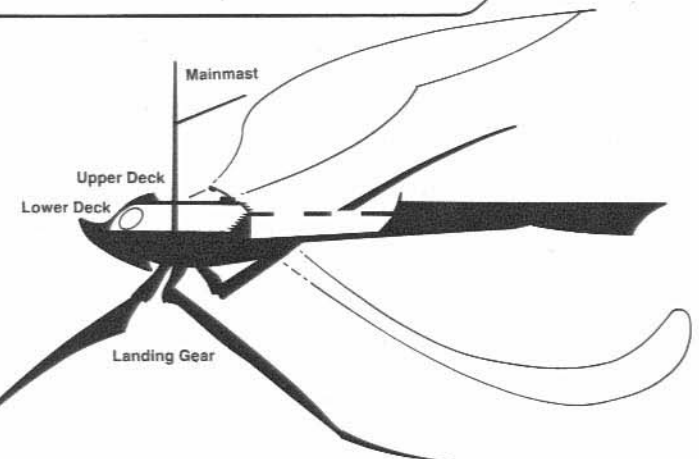

DRAGONSHIP



Built By: Humans
Used Primarily By: Humans
Tonnage: 45 tons
Hull Points: 45
Crew: 20/45
Maneuverability Class: D
Landing—Land: No
Landing—Water: Yes
Armor Rating: 5

Saves As: Thick wood
Power Type: Major or minor helm
Ship's Rating: As for spelljammer
Standard Armament:
2 medium ballistae
Crew: 2 each
Cargo: 22 tons
Keel Length: 150'
Beam Length: 20'

DRAGONSHIP

One Square = 5 Feet

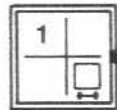

Scout's Deck

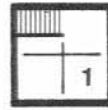

Meditation Deck

Scout's Deck

- 1 Forward Lookout

Meditation Deck

- 1 Captain's Quarters

Drill Deck

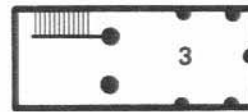
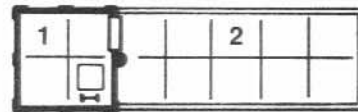

Drill Deck

- 1 Armory
- 2 Parade Deck & Communal Galley
- 3 Open to Shrine Below

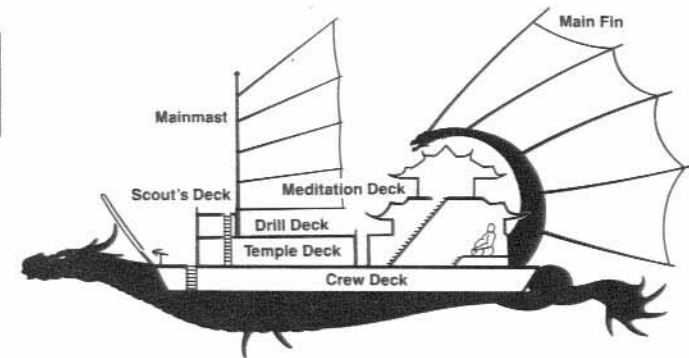

Temple Deck

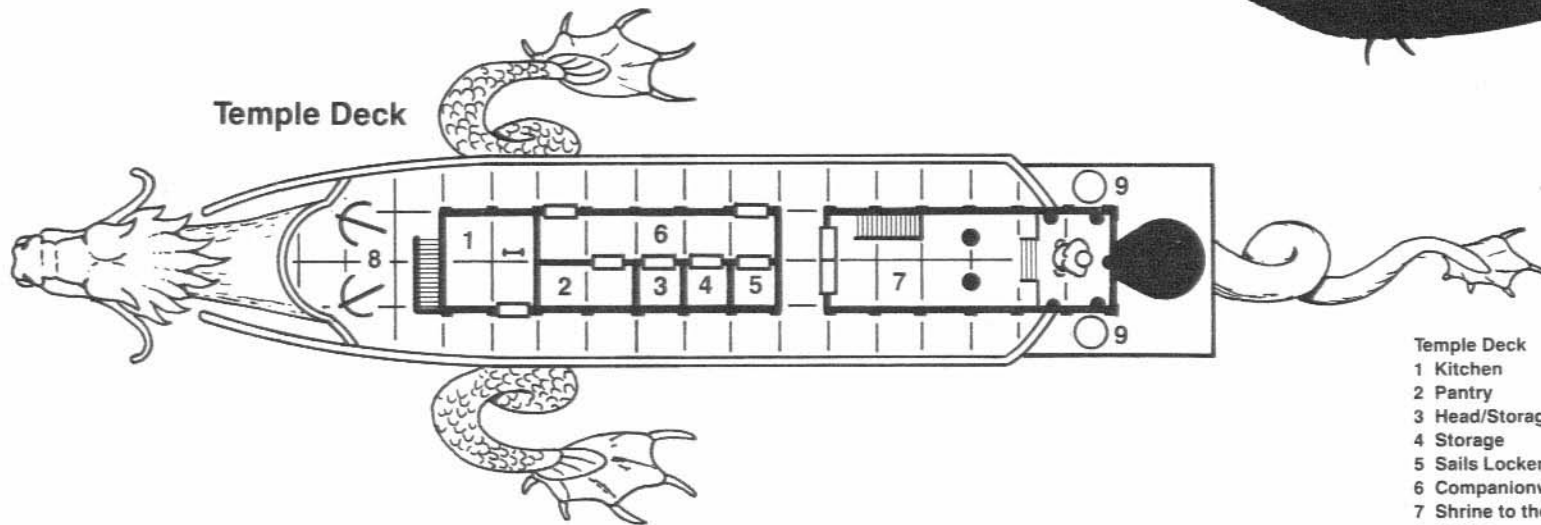

Temple Deck

- 1 Kitchen
- 2 Pantry
- 3 Head/Storage
- 4 Storage
- 5 Sails Locker
- 6 Companionway
- 7 Shrine to the Path & Way
- 8 Ballista
- 9 Dome Over Bridge & Helm

Crew Deck



Crew Deck

- 1 Bridge & Helm
- 2 Companionway
- 3 Officers' Quarters
- 4 Storage
- 5 Crew Quarters
- 6 Storage
- 7 Storage
- 8 Crew Quarters
- 9 Crew Quarters
- 10 Recorder's Quarters
- 11 Recorder's Library & Chart Room

GALLEON



Built By:	Groundling humans	Power Type:	Major or minor helm
Used Primarily By:	Groundling humans	Ship's Rating:	As for spelljammer
Tonnage:	40 tons	Standard Armament:	
Hull Points:	40	1 light catapult	
Crew:	20/40	Crew: 1	
Maneuverability Class:	E	2 medium ballistae	
Landing—Land:	No	Crew: 2 each	
Landing—Water:	Yes	Cargo:	20 tons
Armor Rating:	7	Keel Length:	130'
Saves As:	Thick wood	Beam Length:	30'

GALLEON

One Square = 5 Feet

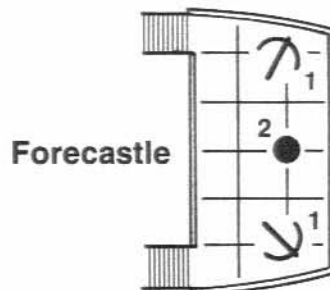
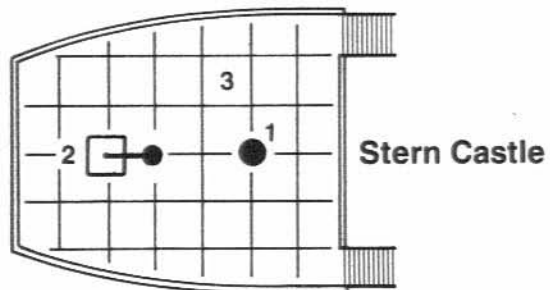

Main Deck

- 1 Rope, Line & Anchor Storage
- 2 Forward Stateroom
- 3 Captain's Cabin
- 4 Spelljammer Quarters
- 5 Spelljammer Helm
- 6 Chart Room
- 7 Galley
- 8 Storage/Hold
- 9 Cargo Doors

Cargo Deck

- 1 Crew Quarters
- 2 Crew Quarters
- 3 Cargo Doors
- 4 Companionway
- 5 Crew Quarters
- 6 Officers' Quarters
- 7 Crew Quarters
- 8 Crew Quarters

Steerage Deck

- 1 Cargo Hold
- 2 Pantry
- 3 Brig

Forecastle

- 1 Ballista
- 2 Foremast

Stern Castle

- 1 Mizzenmast
- 2 Catapult
- 3 Captain's Station

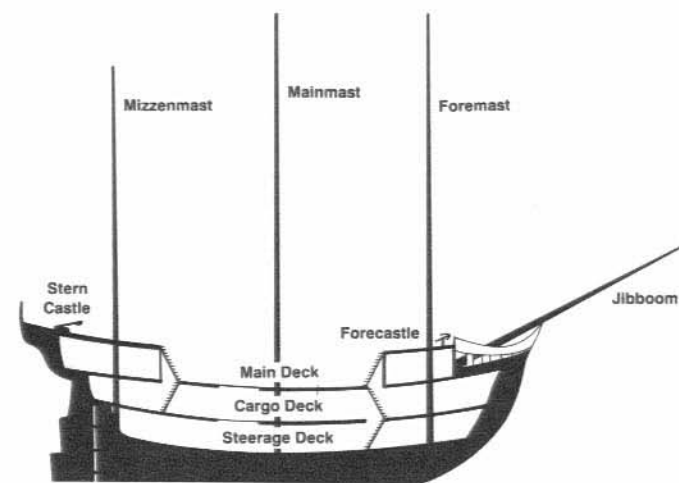
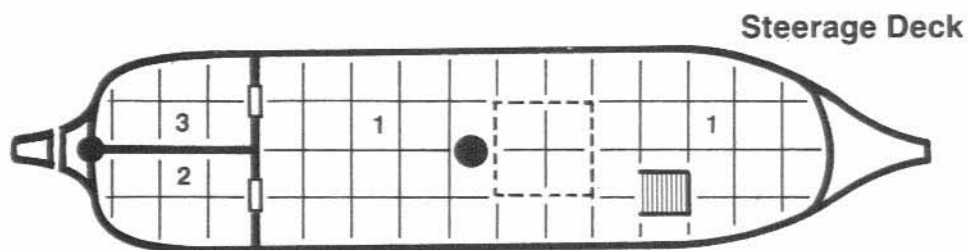
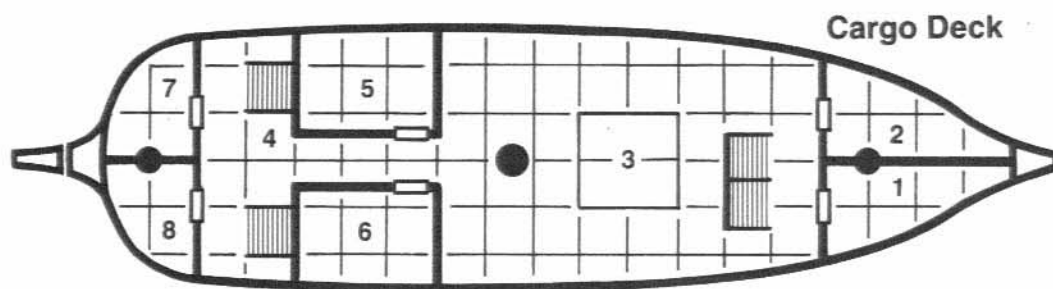
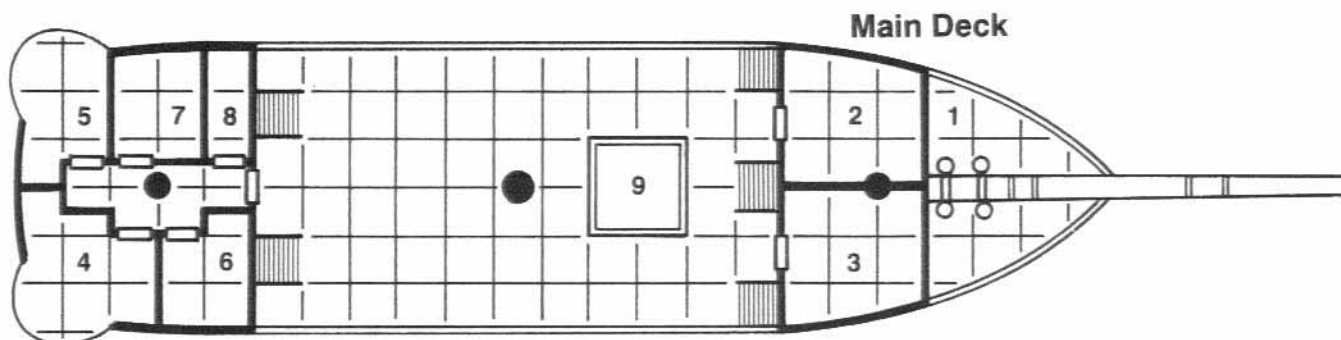

HAMMERSHIP

Built By:	Humans, lizard men
Used Primarily By:	Humans, lizard men, some elves
Tonnage:	60 tons
Hull Points:	60
Crew:	24/60
Maneuverability Class:	D
Landing—Land:	No
Landing—Water:	Yes
Armor Rating:	6

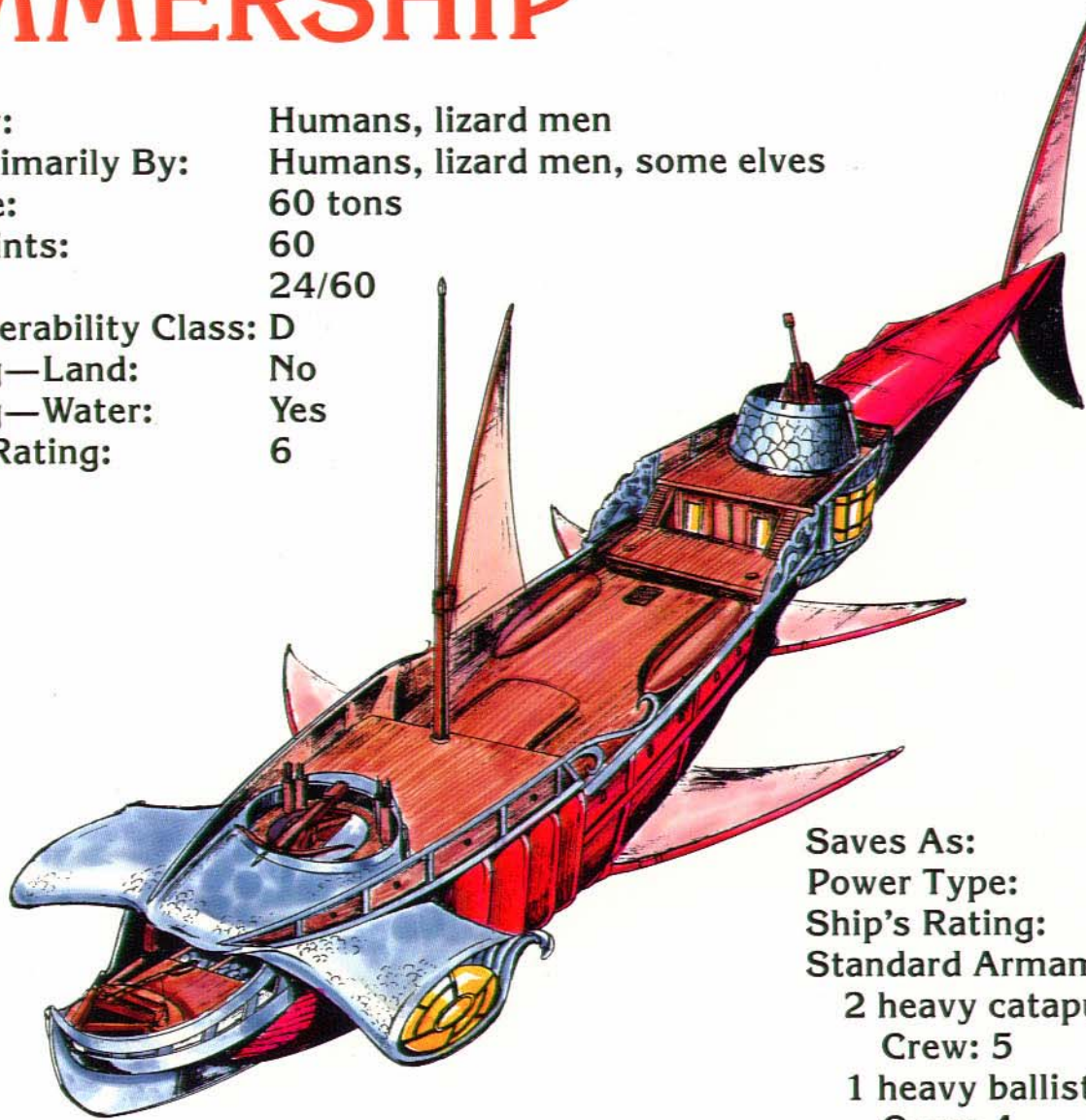

Saves As:
Power Type:
Ship's Rating:
Standard Armament:
2 heavy catapults
Crew: 5
1 heavy ballista
Crew: 4
1 blunt ram

Thick wood
Major or minor helm
As for spelljammer

Cargo: 30 tons
Keel Length: 250'
Beam Length: 25'

One Square = 5 Feet

HAMMERSHIP

Main Deck

- 1 Forward Castle
 - 2 Catapult Shot Container
 - 3 Forward Bridge
 - 4 Officers' Saloon
 - 5 Galley
 - 6 Captain's Cabin
 - 7 Officers' Quarters
 - 8 Officers' Quarters
 - 9 Companionway
 - 10 Head/Storage
 - 11 Sail Storage
 - 12 Aft Crew Quarters
 - 13 Crew Galley & Turret Control
 - 14 First Officer's Quarters
- (Spare Spelljamming Helm if available)

Cargo Deck

- 1 Lower Bridge, Helm, & Chart Room
- 2 Spelljammer Quarters
- 3 Kitchen (Dumbwaiter to Galley Above)
- 4 Pantry
- 5 Crew Quarters
- 6 Stateroom
- 7 Head/Storage
- 8 Stateroom
- 9 Bosun's Locker
- 10 Companionway
- 11 Cargo Hold

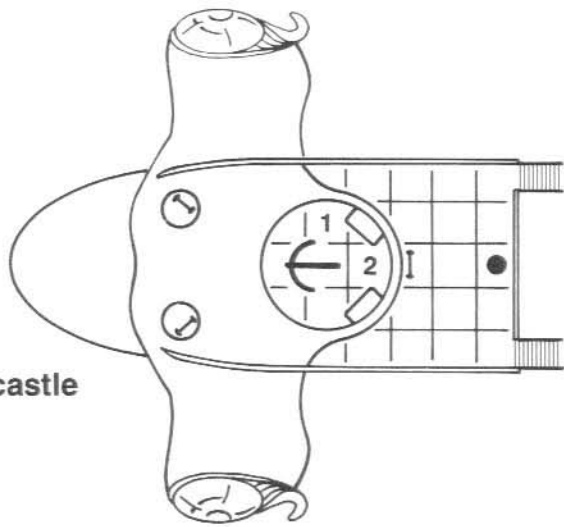

Forecastle

Stern Castle

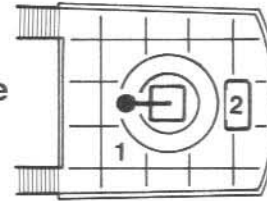

Forecastle

- 1 Forward Ballista
- 2 Ballista Shot Storage

Stern Castle

- 1 Aft Catapult
- 2 Catapult Shot Storage

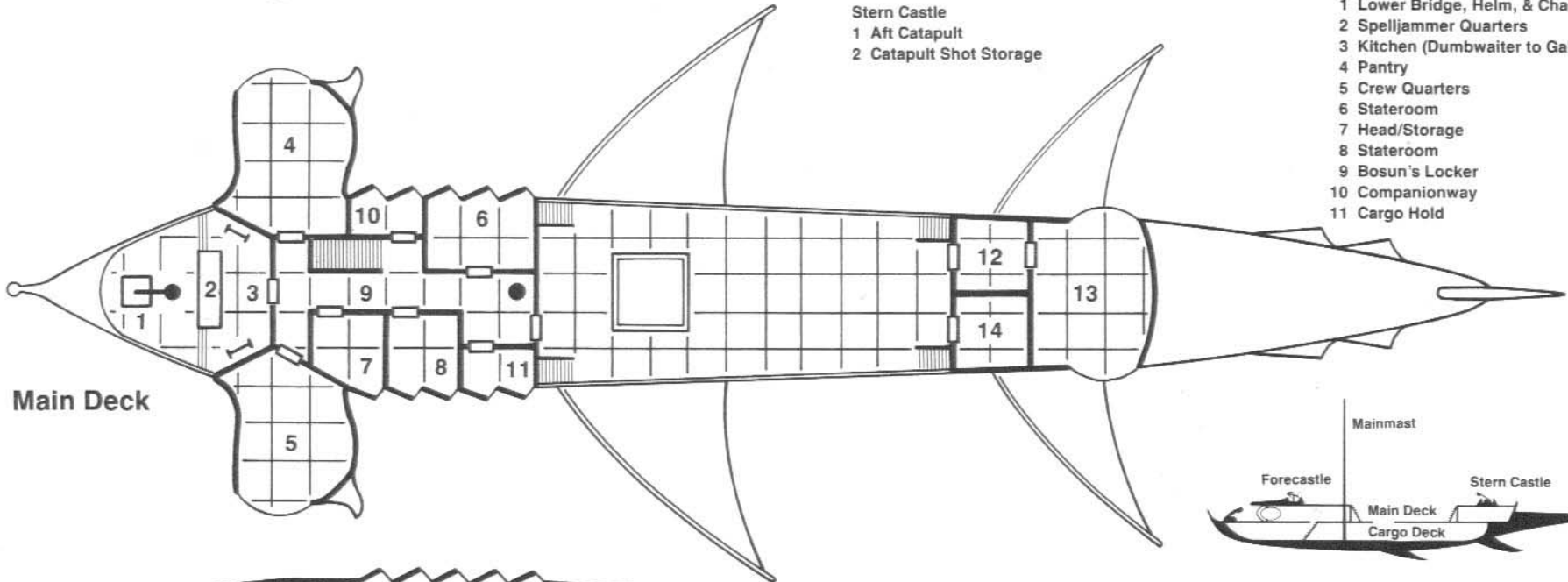

Main Deck

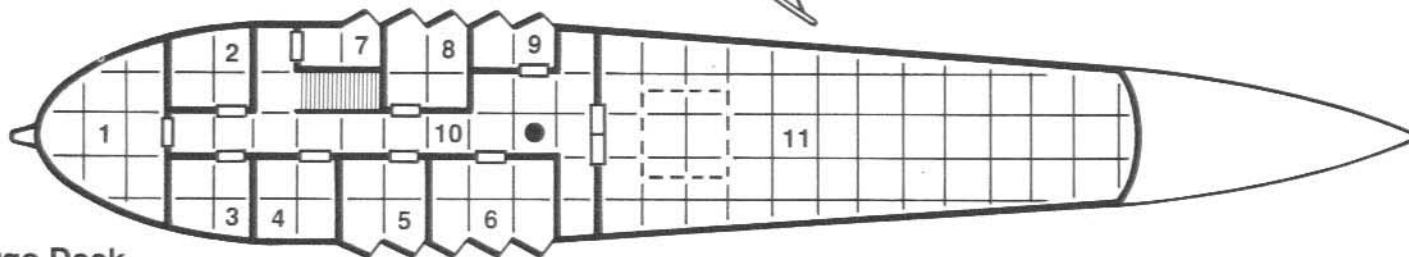
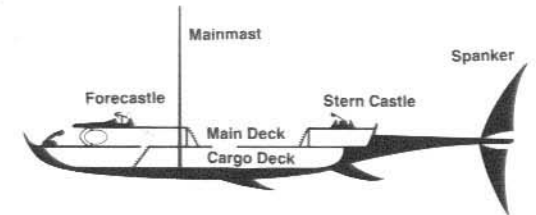

Cargo Deck

MAN-O-WAR

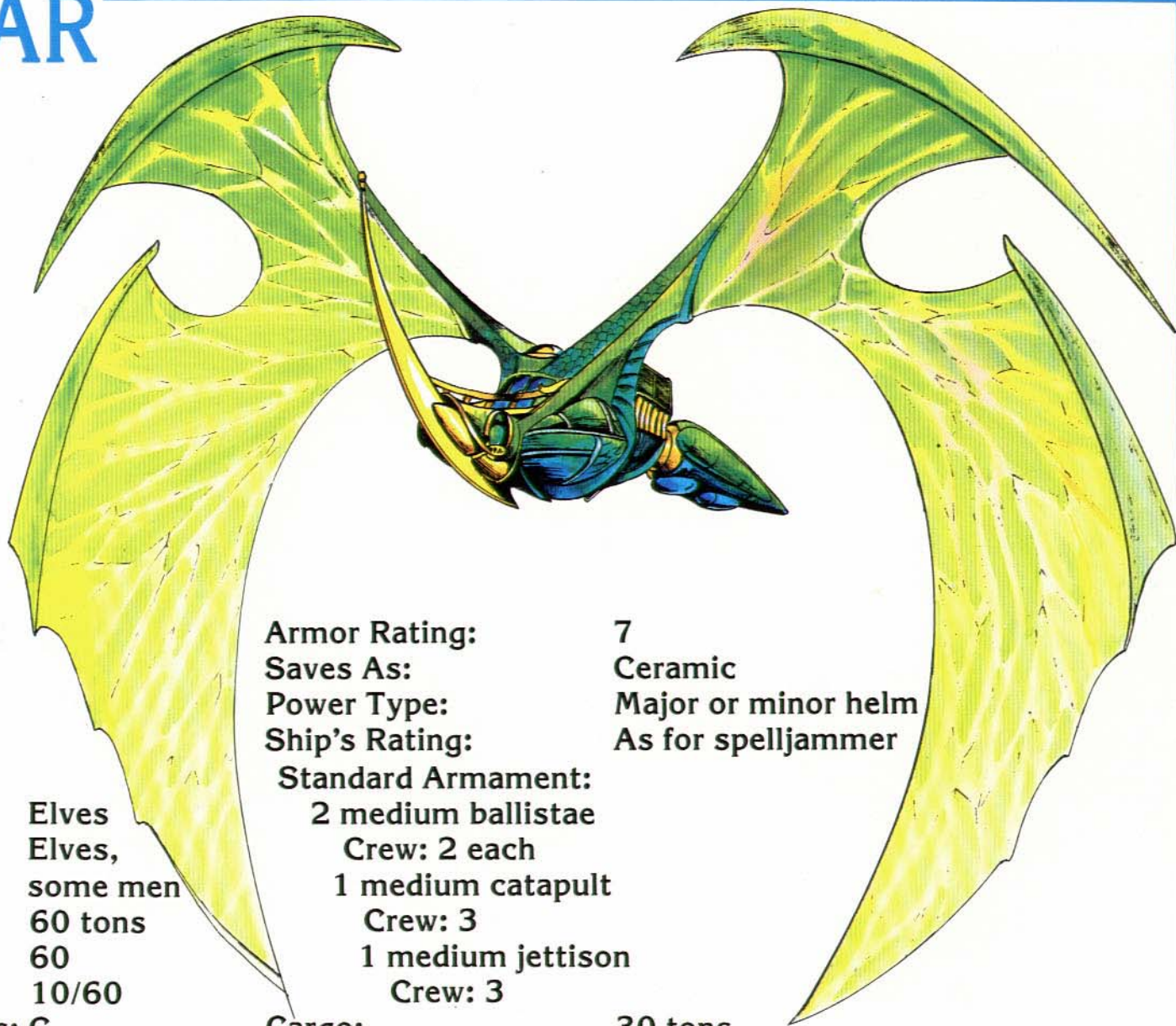

Built By: Elves
Used Primarily By: Elves, some men
Tonnage: 60 tons
Hull Points: 60
Crew: 10/60
Maneuverability Class: C
Landing—Land: No
Landing—Water: No

Armor Rating: 7
Saves As: Ceramic
Power Type: Major or minor helm
Ship's Rating: As for spelljammer

Standard Armament:
2 medium ballistae
Crew: 2 each
1 medium catapult
Crew: 3
1 medium jettison
Crew: 3

Cargo: 30 tons
Keel Length: 200'
Beam Length: 20'

MAN-O-WAR

One Square = 5 Feet

Main Deck

- 1 Jettison
- 2 Companionway
- 3 Cargo & Detention Area
- 4 Crew Cabins
- 5 Crew Cabins
- 6 Galley
- 7 Helm & Spelljammer's Cabin
- 8 Chart & Navigation Command
- 9 Ballista (Weapons Pit)
- 10 Hatch to Forward Deck
- 11 Retractable Dome/Eyes

Castle Deck

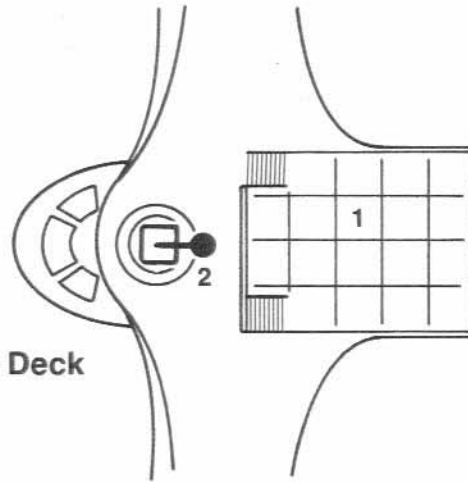

Battle Deck

- 1 Bridge
- 2 Forward Deck
- 3 Hatch to Weapons Pit
- 4 Companionway
- 5 Storage: Grapples & Munitions
- 6 Storage/Head
- 7 Officers' Quarters
- 8 Captain's Cabin

Castle Deck

- 1 Lookout Station & Flight Deck
- 2 Catapult

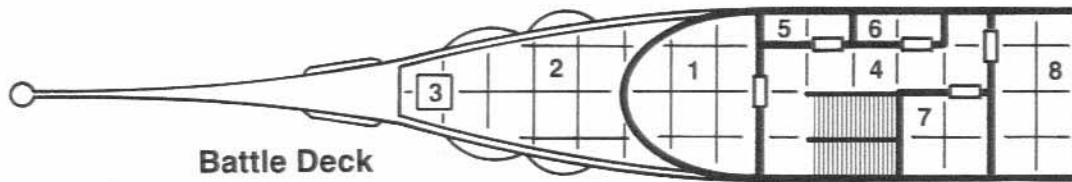

Battle Deck

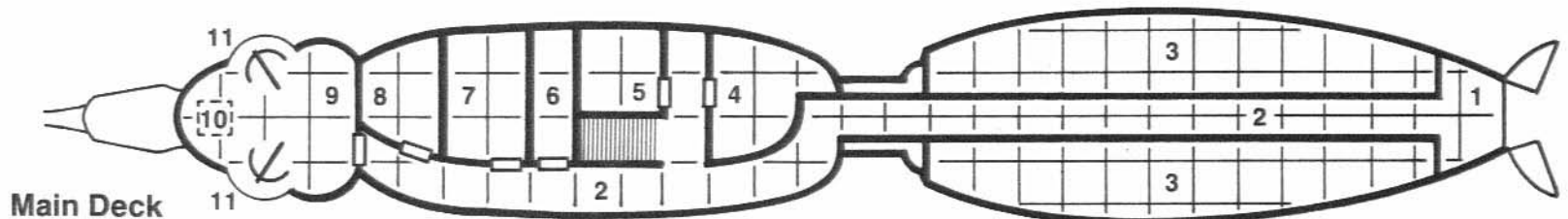
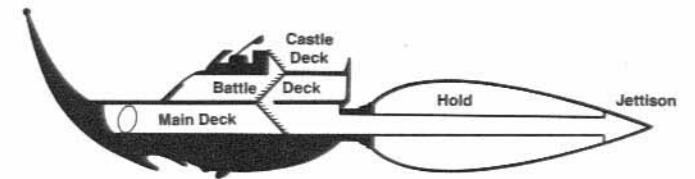

Main Deck

NAUTILOID

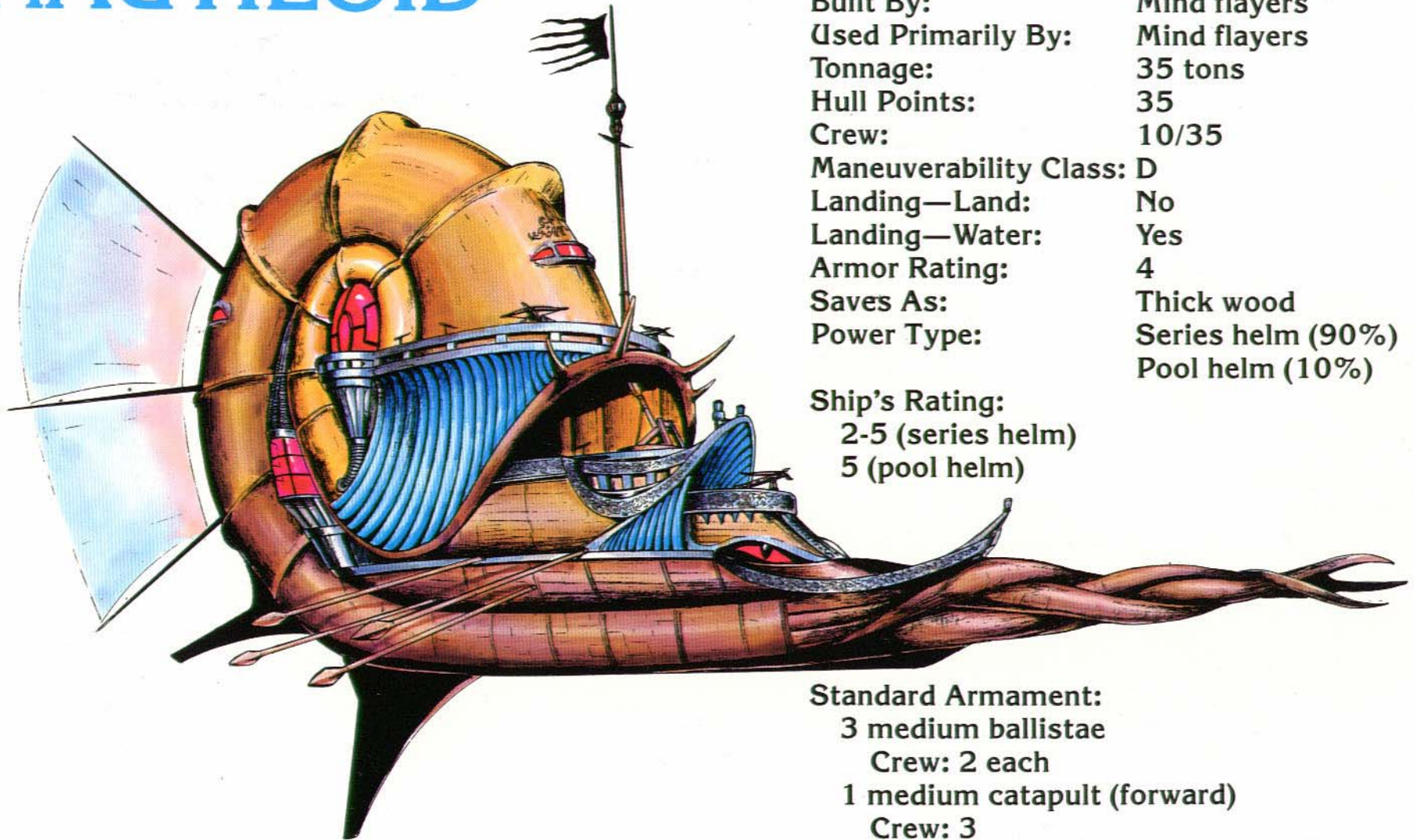

Built By:	Mind flayers
Used Primarily By:	Mind flayers
Tonnage:	35 tons
Hull Points:	35
Crew:	10/35
Maneuverability Class:	D
Landing—Land:	No
Landing—Water:	Yes
Armor Rating:	4
Saves As:	Thick wood
Power Type:	Series helm (90%) Pool helm (10%)

Ship's Rating:
2-5 (series helm)
5 (pool helm)

Standard Armament:
3 medium ballistae
Crew: 2 each
1 medium catapult (forward)
Crew: 3
1 medium jettison (rear)
Crew: 3
Piercing ram

Cargo:	17 tons
Keel Length:	180'
Beam Length:	30'

NAUTILOID

One Square = 5 Feet

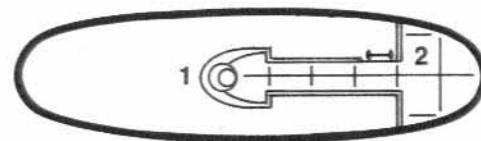
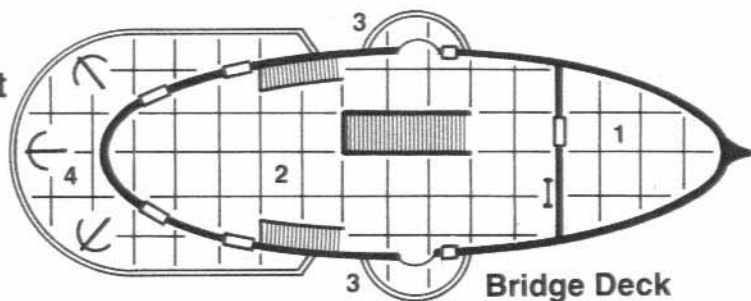

Command Station



Scout Deck

Lower Battle Station

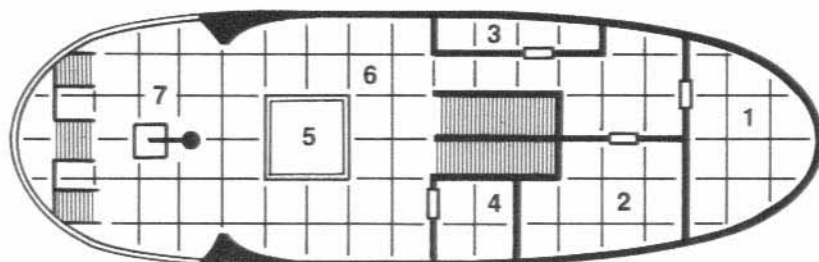
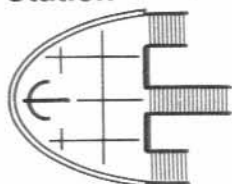

Battle Deck

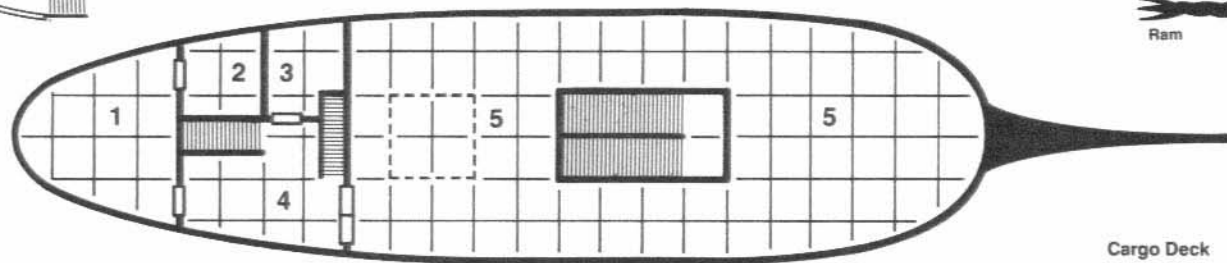
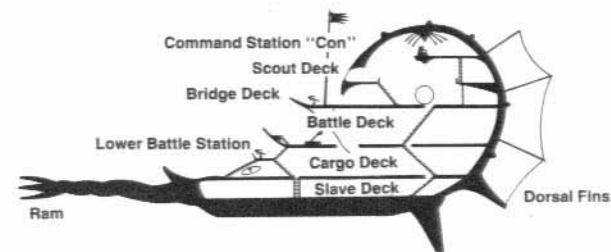

Cargo Deck

- Command Station
1 Captain's Chair
2 Captain's Day Room

- Scout Deck
1 Forward Observer
2 Series Helm

- Bridge Deck
1 Main Saloon
2 Bridge Floor
3 Ventral Observers
4 Upper Battle Station

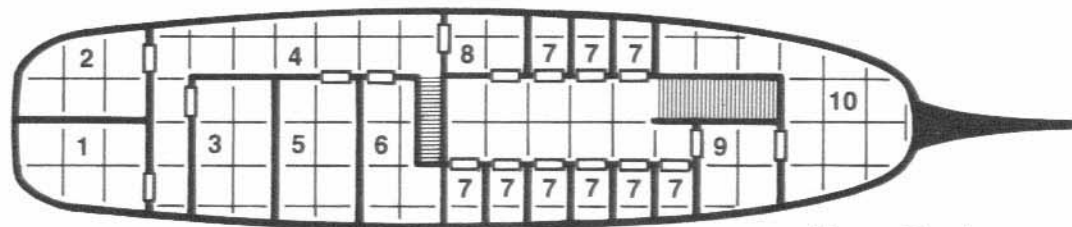

Slave Deck

- Cargo Deck
1 Captain's Cabin
2 Captain's Chart & Treasure Room
3 Crew Quarters
4 Galley
5 Cargo

- Slave Deck
1 Stateroom
2 Stateroom
3 Stateroom
4 Passageway
5 Stateroom
6 Crew Quarters
7 Slave Quarters
8 Guard Post
9 Guard Post
10 Jettison & Storage

- Battle Deck
1 Officers' Quarters
2 Officers' Quarters
3 Sail Storage
4 Chart Room
5 Cargo Bay
6 Assembly Deck
7 Middle Battle Station

SQUID-SHIP

Built By:	Humans
Used Primarily By:	Humans, lizard men
Tonnage:	45 tons
Hull Points:	45
Crew:	12/45
Maneuverability Class:	D
Landing—Land:	No
Landing—Water:	Yes
Armor Rating:	5

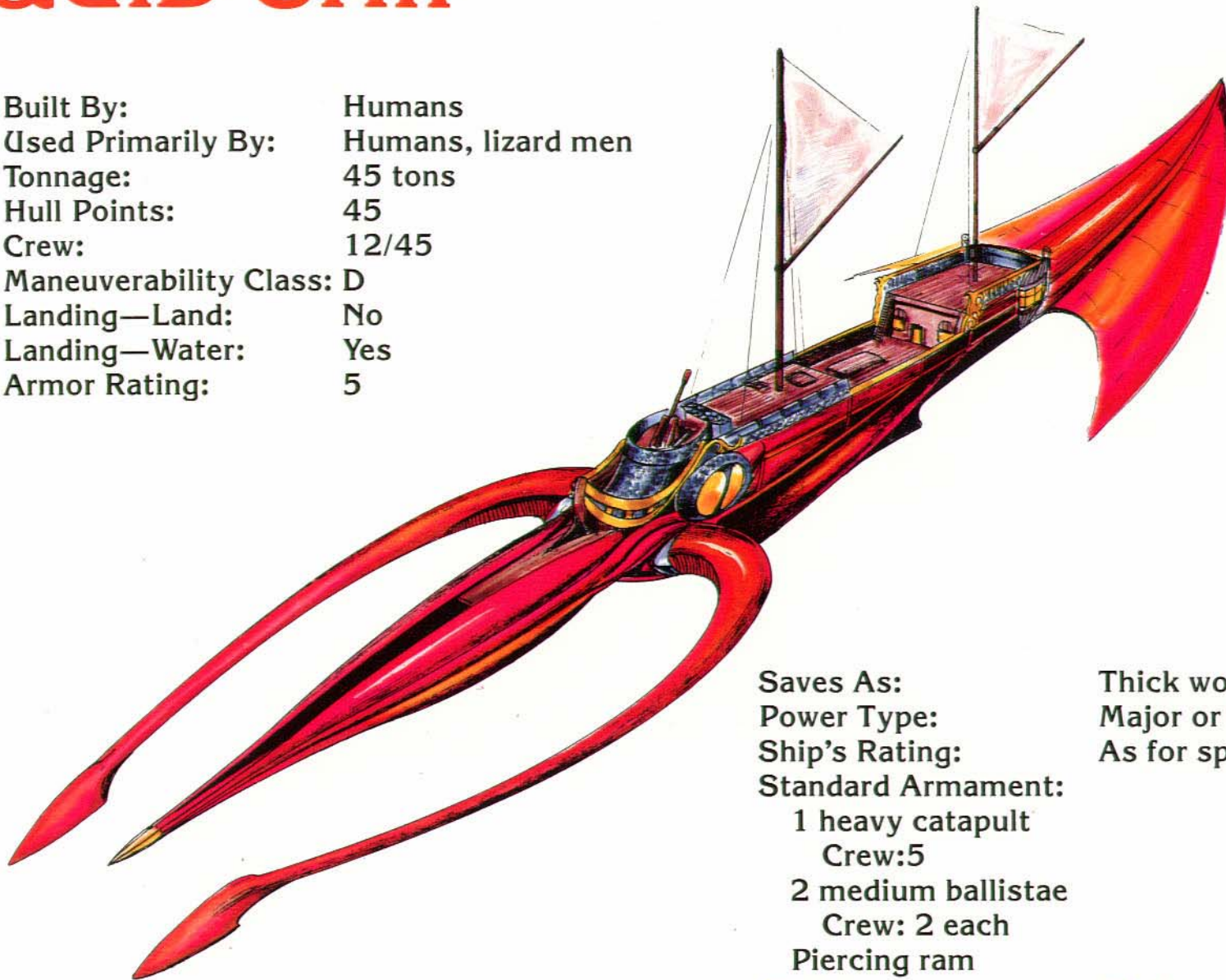

Saves As:	Thick wood
Power Type:	Major or minor helm
Ship's Rating:	As for spelljammer
Standard Armament:	
1 heavy catapult	
Crew:5	
2 medium ballistae	
Crew: 2 each	
Piercing ram	
Cargo:	23 tons
Keel Length:	250'
Beam Length:	25'

SQUID SHIP

One Square = 5 Feet

Main Deck

- 1 Spelljammer Helm & Chart Room
- 2 Cargo Door
- 3 Saloon/Galley
- 4 Captain's Quarters
- 5 Storage
- 6 Head/Storage

Cargo Deck

- 1 Cargo Bay
- 2 Crew Quarters
- 3 Bosun's Locker
- 4 Head/Storage
- 5 Crew Quarters
- 6 Officers' Quarters
- 7 Companionway

Forecastle

- 1 Catapult
- 2 Catapult Shot Storage
- 3 Mainmast

Stern Castle

- 1 Mizzenmast
- 2 Stern Ballista
- 3 Captain's Station

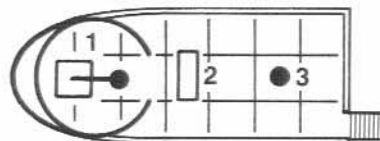

Forecastle

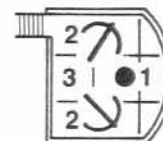

Stern Castle

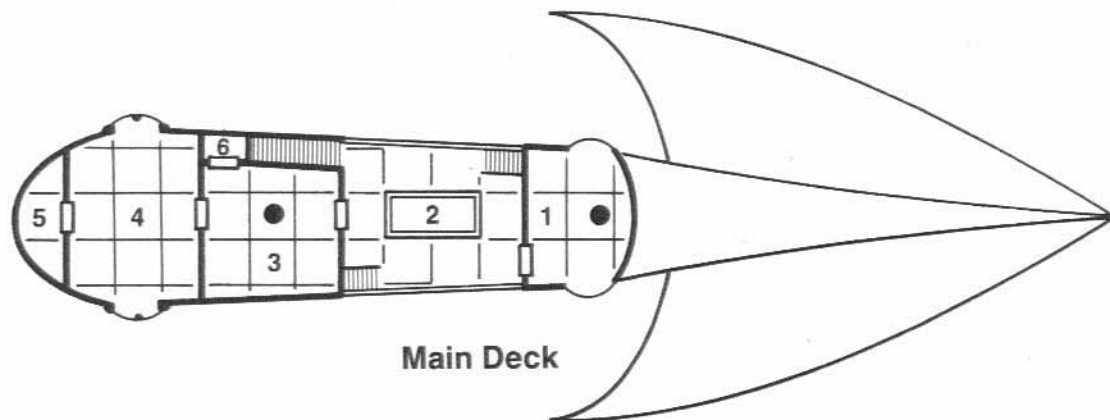
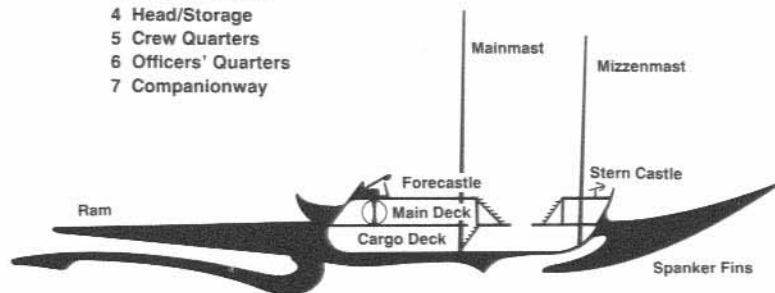

Main Deck

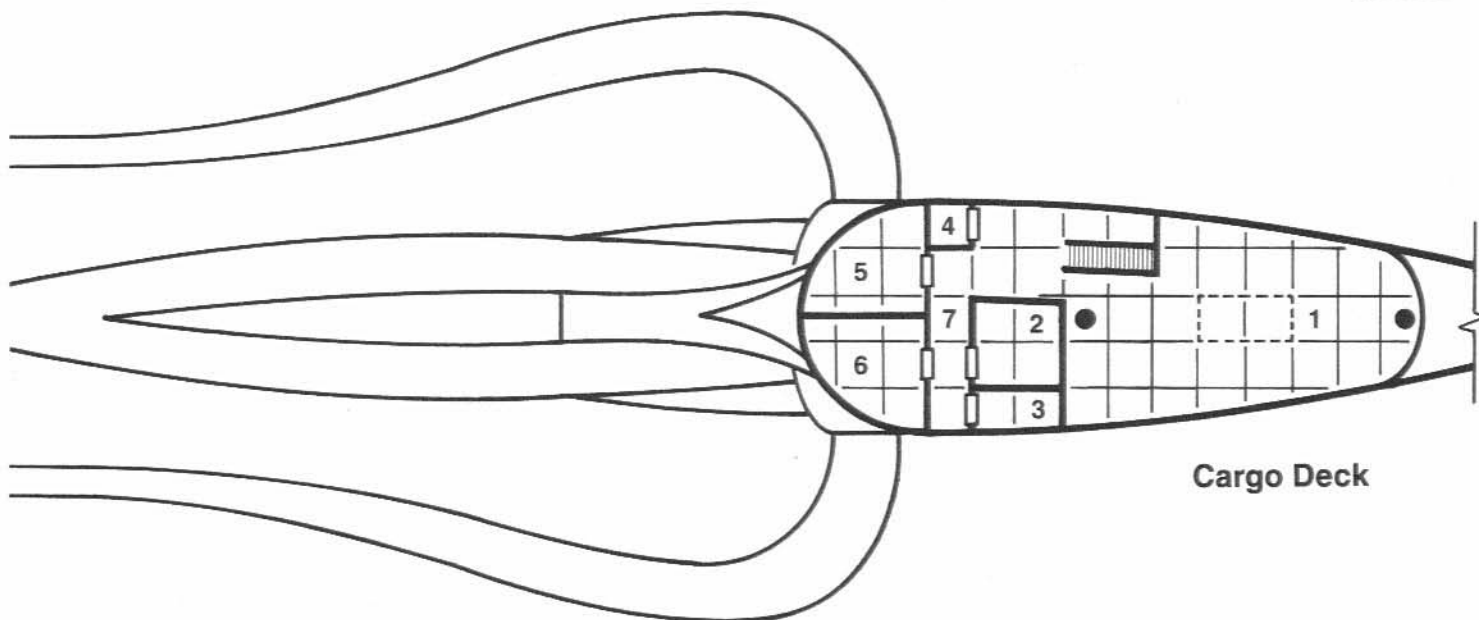

Cargo Deck

TRADESMAN

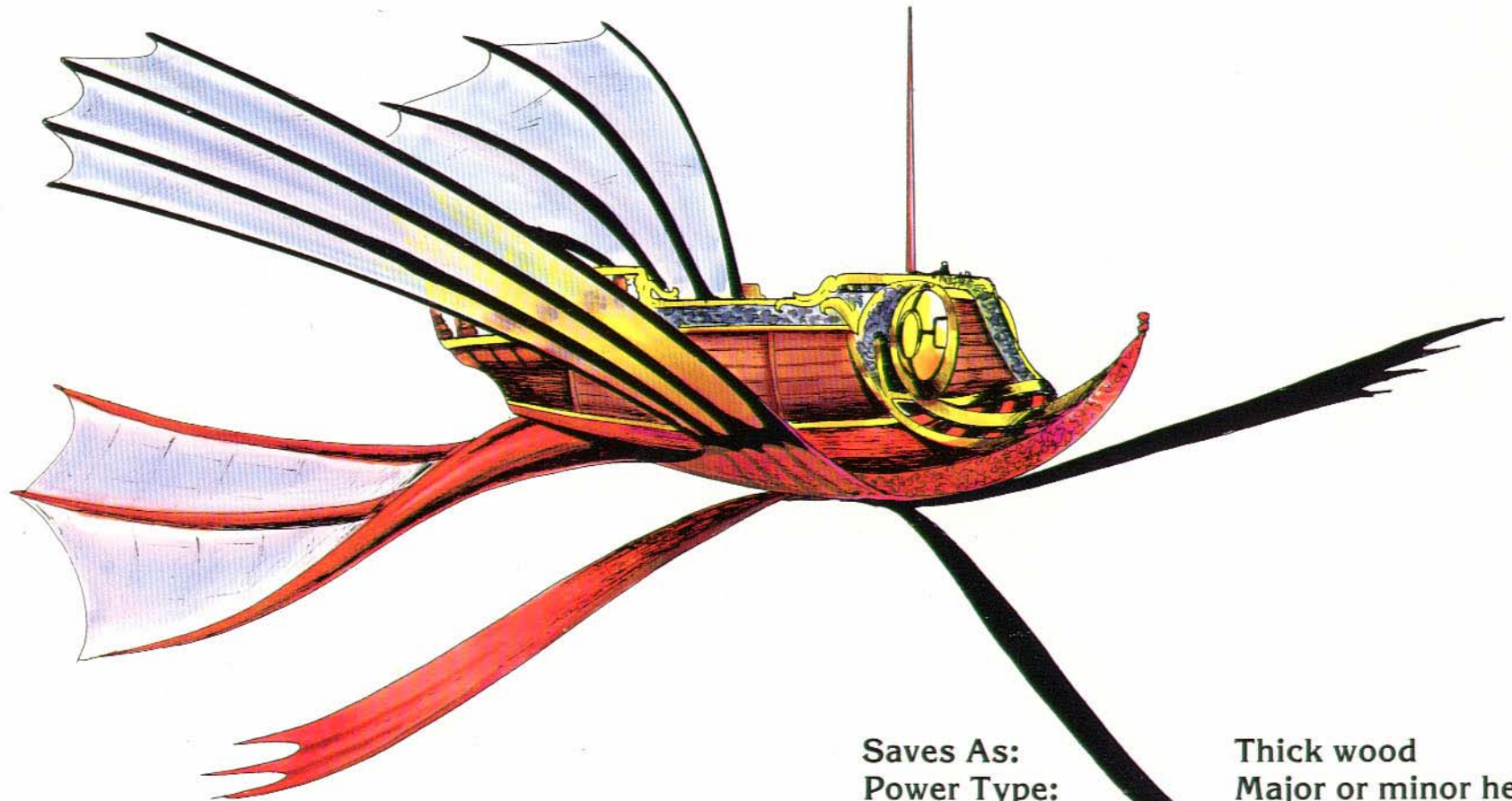

Built By:	Humans
Used Primarily By:	All races
Tonnage:	25 tons
Hull Points:	25
Crew:	10/25
Maneuverability Class:	D
Landing—Land:	No
Landing—Water:	No
Armor Rating:	5

Saves As:	Thick wood
Power Type:	Major or minor helm
Ship's Rating:	As for spelljammer
Standard Armament:	
	1 light catapult
	Crew: 1
	1 medium ballista
	Crew: 2

Cargo:	13 tons
Keel Length:	120'
Beam Length:	30'

TRADESMAN

One Square = 5 Feet

Main Deck (Sailing Deck)

- 1 Forward Catapult
- 2 Cargo Deck
- 3 Ballista Mount
- 4 Forward Passage
- 5 Aft Passage
- 6 Mizzen Fin
- 7 Mainmast

Cargo Deck

- 1 Bridge
- 2 Companionway
- 3 Chart Room
- 4 Captain's Quarters
- 5 Locker
- 6 Head/Storage
- 7 Cargo Holds
- 8 Sail Locker
- 9 Crew Quarters
- 10 Crew Quarters/Stateroom
- 11 Galley/Kitchen/Pantry
- 12 Spelljamming Helm and Quarters

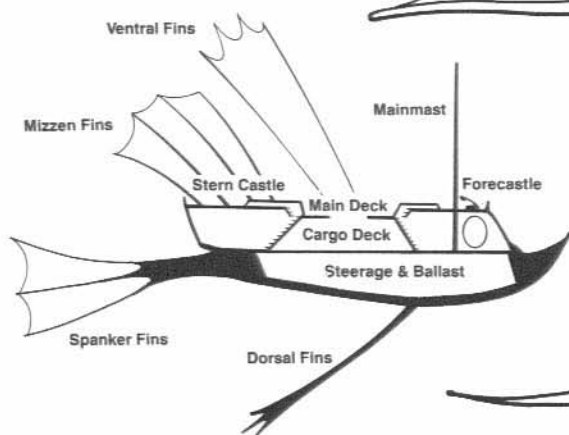

Main Deck (Sailing Deck)

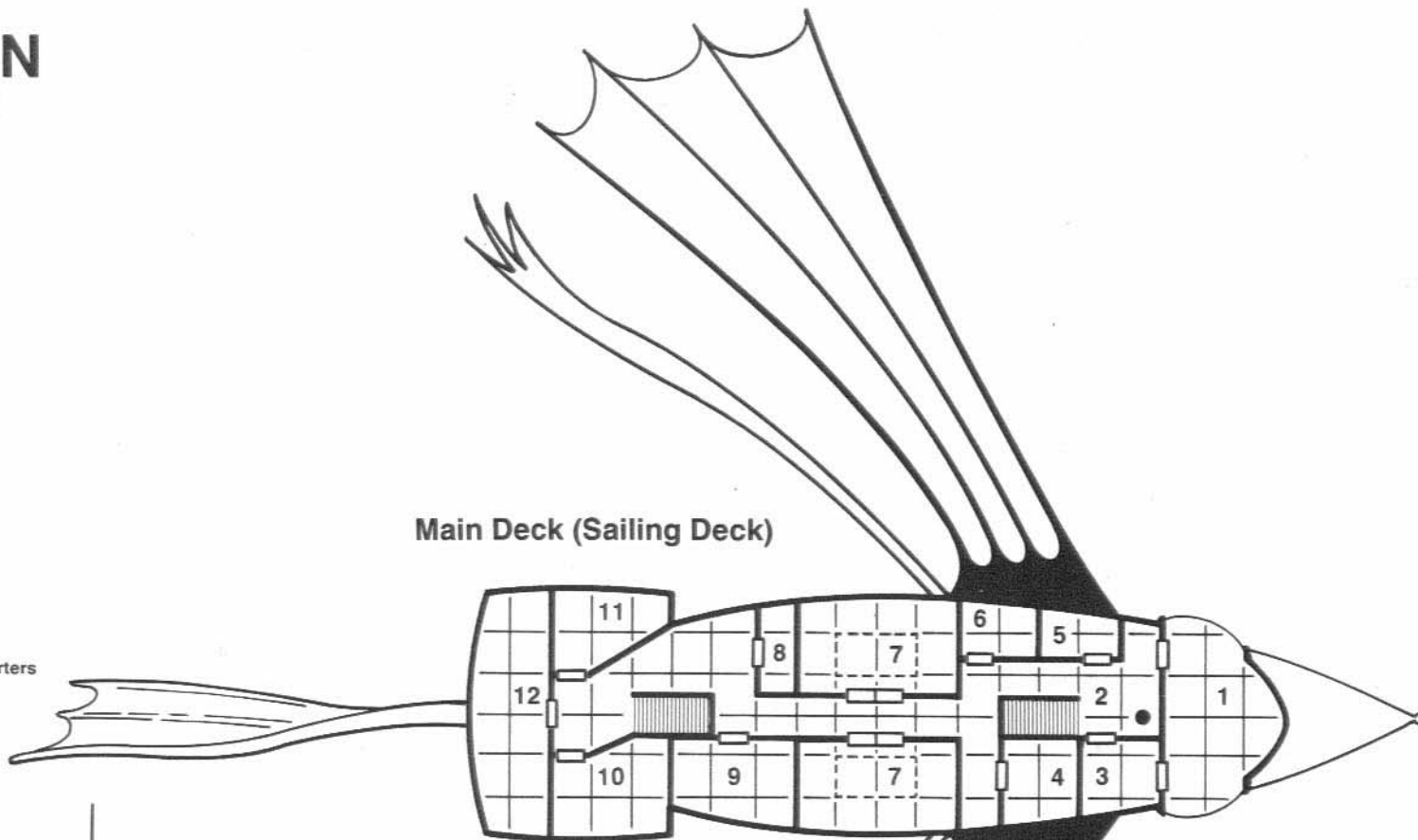

Cargo Deck

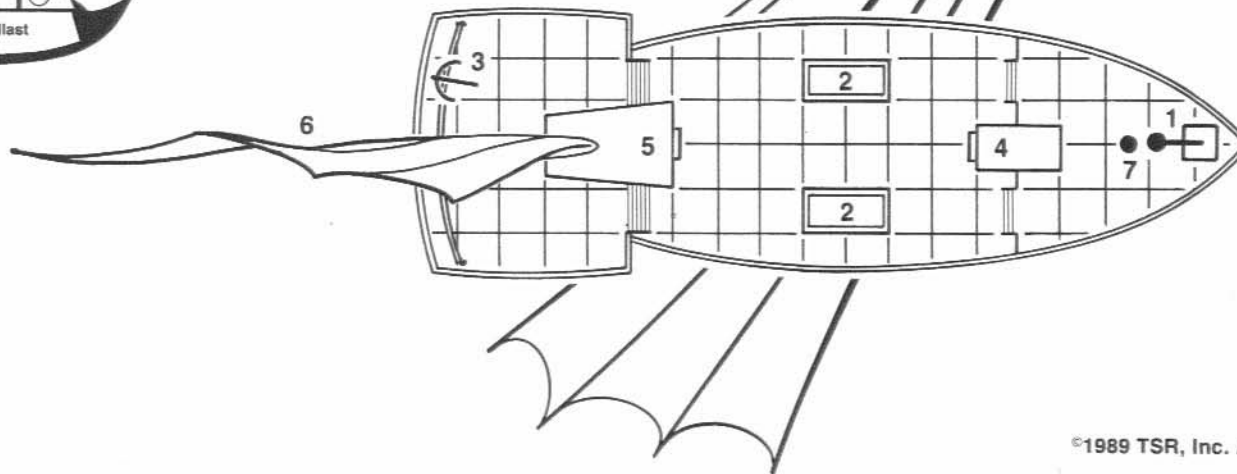

WASP

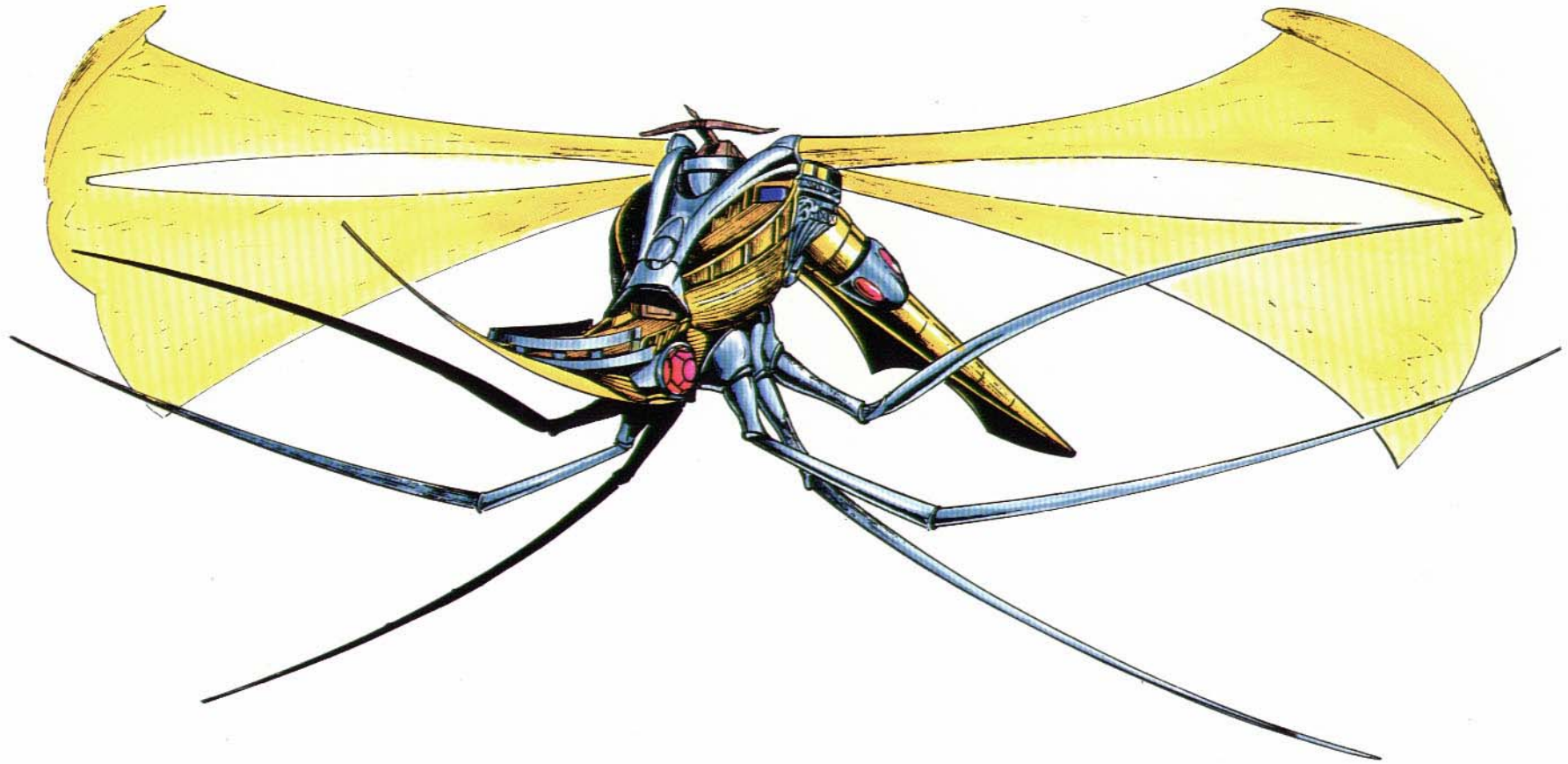

Built By:	Lizard men	Saves As:	Thick wood
Used Primarily By:	Lizard men, humans	Power Type:	Major or minor helm
Tonnage:	18 tons	Ship's Rating:	As for spelljammer
Hull Points:	18	Standard Armament:	
Crew:	8/18	1 heavy ballista	
Maneuverability Class:	D	Crew:	4
Landing—Land:	Yes	Cargo:	9 tons
Landing—Water:	Yes*	Keel Length:	80'
Armor Rating:	6	Beam Length:	20'

WASP

One Square = 5 Feet

Main Deck

- 1 Forward Station
- 2 Crew Quarters
- 3 Galley
- 4 Cargo
- 5 Additional Cargo (often flooded)
- 6 Hatch to Foredeck
- 7 Hatch to Weapons Deck
- 8 Companionway

Foredeck

- 1 Bridge & Helm
- 2 Hatch to Forward Station

Weapons Deck

- 1 Ballista
- 2 Wing Stations & Pivots
- 3 Hatch to Main Deck

Weapons Deck

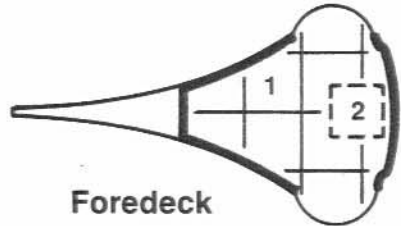
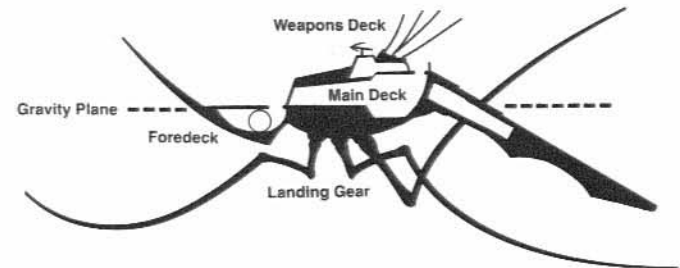
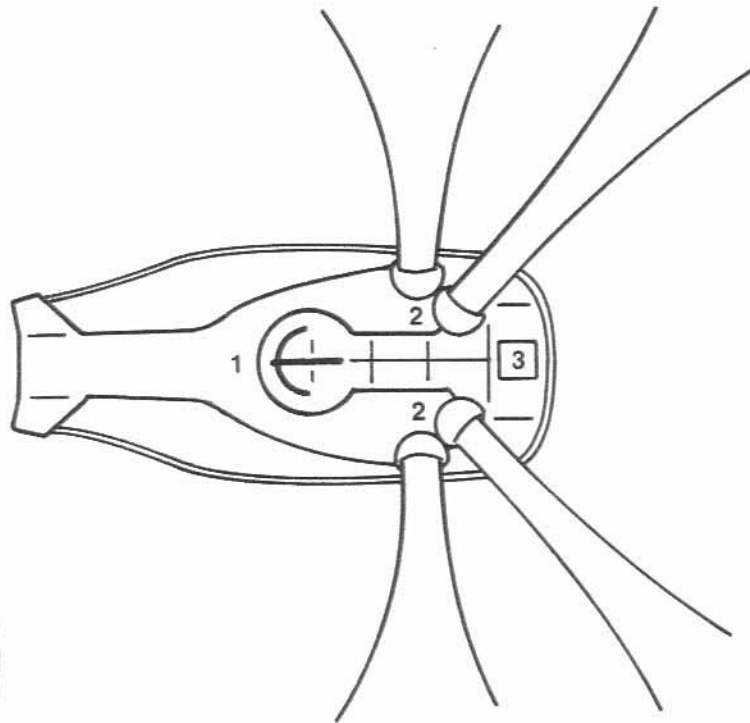

Foredeck

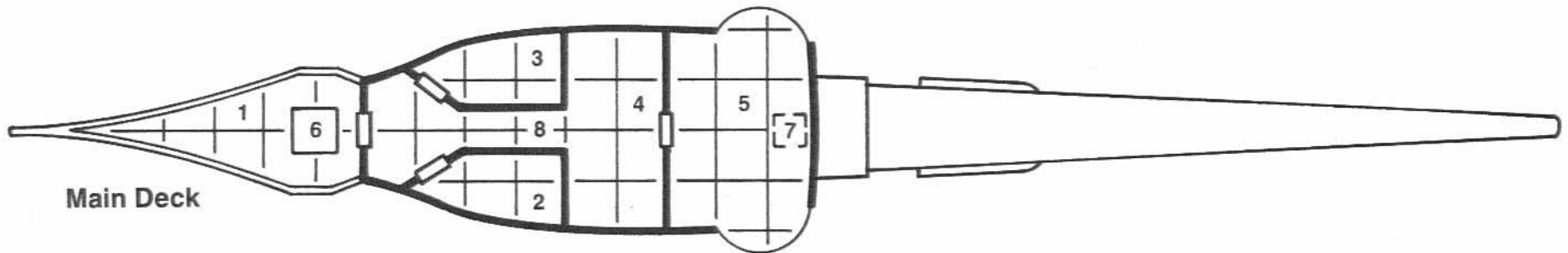

Main Deck

The Spelljammer

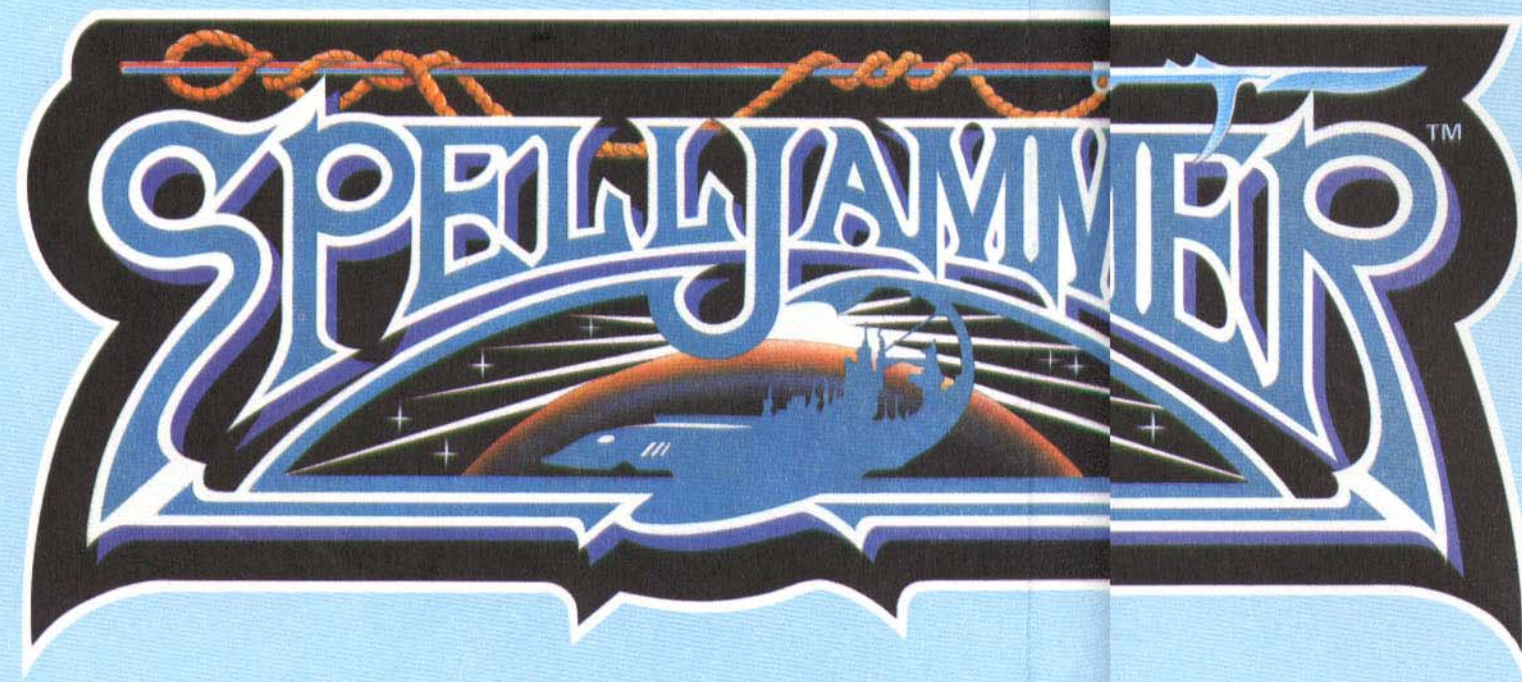

The *Spelljammer* is an enigma of space. It is obviously a constructed item, but its great size (three-quarters of a mile across) should prevent it from attaining the speeds and maneuverability that are always attributed to it. There apparently is only one, but it has been reported destroyed on several occasions only to reappear again later, like a phoenix rising from its ashes. It has been said to have been commanded by men, elves, illithids, and beholders, yet usually when encountered it has no master and no central control, but speeds along aimlessly on its own course.

The *Spelljammer* is the size of a small city, its surface dotted by huge castles and citadels. The interior of the *Spelljammer* is hollow as well, and laced with huge decks, storage areas, even internal greenhouses under magical illumination. Different creatures make their homes in the *Spelljammer's* various parts, and there is a continual war between the various factions. At least three beholder nations are currently aboard the ship, along with a mind flayer outpost, several pirate ships, a small herd of umber hulks who escaped from the neogi, and other, even stranger creatures. These wars take the form of small raids against the other sides, while each faction searches for their ultimate goal.

The ultimate goal aboard the *Spelljammer*, of course, is the helm which controls the actions of the ship. Bringing another standard helm onboard the *Spelljammer* does no good; the *Spelljammer* is too large for standard helms to have any effect on it. The *Spelljammer* is even immune to the *Crown of the Stars*, though several of the factions on board state that it is a similar magical artifact which controls the ship. This "ultimate helm" which controls the *Spelljammer* may even have a versatile and changing form, which could explain its differing appearance in different tales.

The gods themselves are silent when it comes to matters of the *Spelljammer*; commune and contact higher plane spells produce negligible or misleading information (the gods hate to admit that they do not know about something, but some sages have suggested (quietly) that the *Spelljammer* itself is outside the limit of the gods' knowledge). Such spells operate normally on board the *Spelljammer* when dealing with other objects, but when the subject turns to the *Spelljammer* itself and its elusive helm, the gods grow strangely quiet.

The *Spelljammer* is an erratic beast, often going unseen in the Known Spheres for generations, then making a rapid series of appearances throughout the spheres. In some worlds its appearance is connected with dark times and upcoming tragedy, in others it is a symbol of the involvement of the gods, and in still others merely a pretty astronomical occurrence, no more sinister than the northern lights or a lunar eclipse.

The listed weapons are those that are known to be on board the *Spelljammer*. There are stories of great armories deep within its hull, protected by magical guardians. The armories include all manner of additional equipment, including the rumored bombard, as well as other, even more powerful weapons. The listed weapons are those currently mounted on the ship. Many of these are already in the hands of one faction or another. Those approaching the *Spelljammer* with intention to land may find themselves the target of a group effort of the established factions who are not looking for any further competition for the helm.

Where did the *Spelljammer* come from? Who built it? And for what purpose? How does it move through space like some huge radiant dragon? Who steers it now? These are unknown and unanswerable questions that surround the *Spelljammer* like a great fog, making the monstrous ship the great mystery of the spheres, an enigma of space.

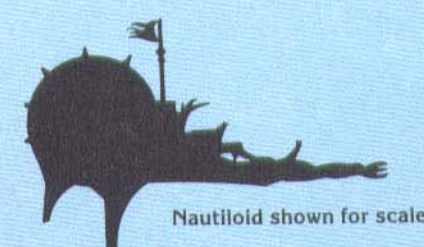

Nautifield shown for scale

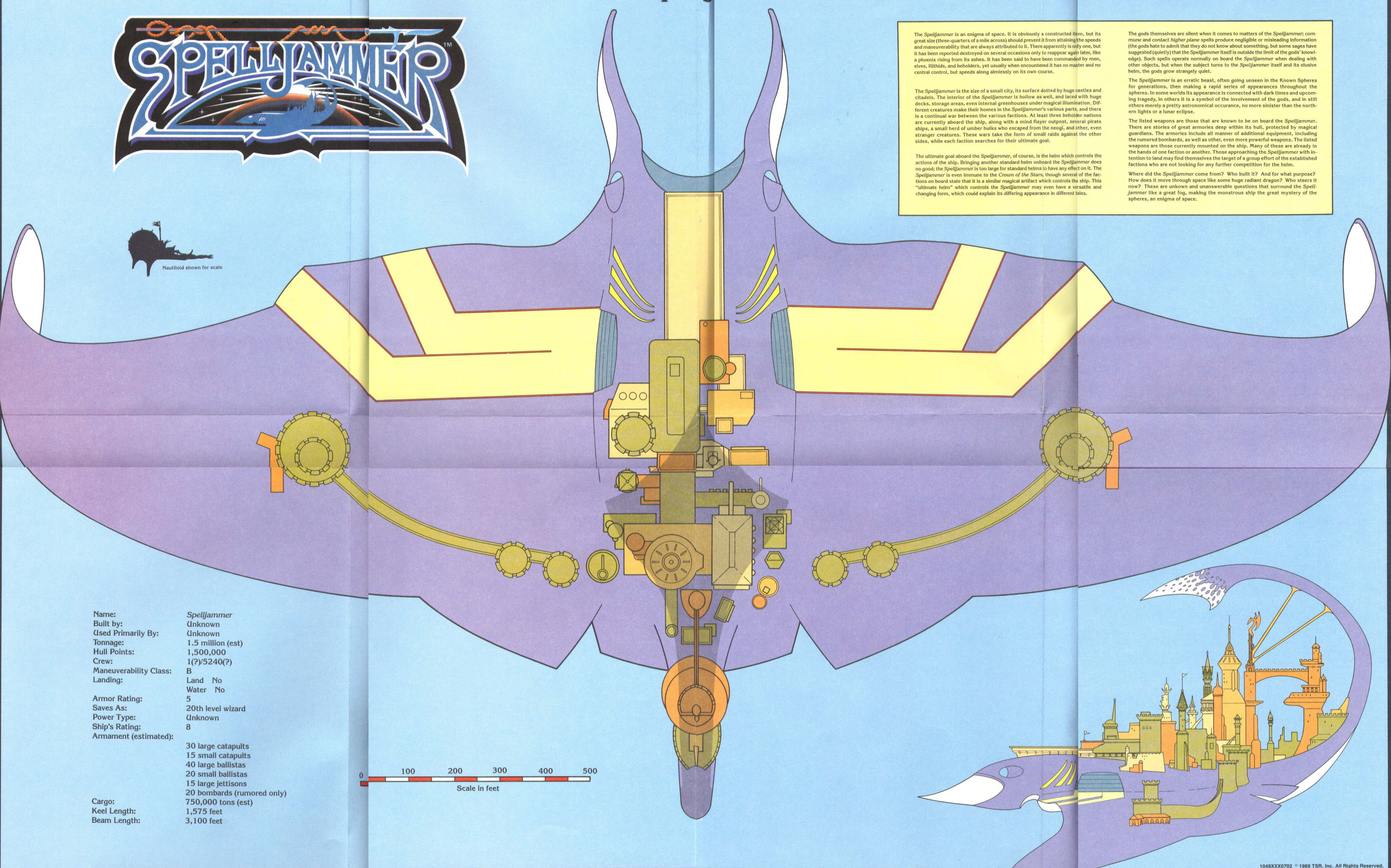

Name:	<i>Spelljammer</i>
Built by:	Unknown
Used Primarily By:	Unknown
Tonnage:	1.5 million (est)
Hull Points:	1,500,000
Crew:	1(?)5240(?)
Maneuverability Class:	B
Landing:	Land No Water No
Armor Rating:	5
Saves As:	20th level wizard
Power Type:	Unknown
Ship's Rating:	8
Armament (estimated):	30 large catapults 15 small catapults 40 large ballistas 20 small ballistas 15 large jettisons 20 bombard (rumored only)
Cargo:	750,000 tons (est)
Keel Length:	1,575 feet
Beam Length:	3,100 feet

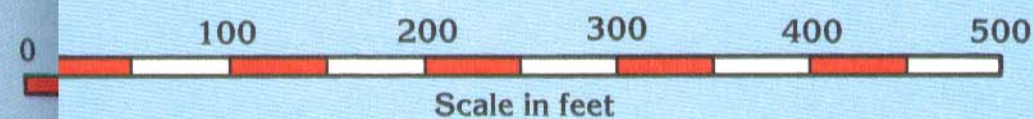

The Rock of Bral

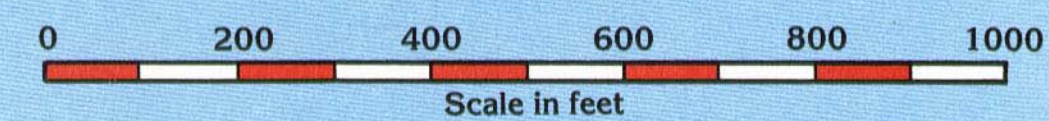

- | | |
|------------------------------------|---------------------------------|
| 1) Docks | 15) Arena of Frun |
| 2) Drydock | 16) Festival Ground |
| 3) Shou Embassy | 17) Greater Market |
| 4) Warehouses | 18) The Forest (Elven District) |
| 5) Lesser Market (Thieves' Market) | 19) Dungeon |
| 6) Illithid Embassy | 20) Graveyard |
| 7) The Burrows (Halflings) | 21) Noble Estates |
| 8) Dwarven District | 22) Lake Bral |
| 9) Dracon Enclave | 23) Barracks |
| 10) Giff-Town | 24) Castle of Prince Andru |
| 11) Temple of Ptah | 25) Upper Lake |
| 12) House of the Path and The Way | 26) Monument to Prince Cozaf |
| 13) Polygot Shrines | 27) Royal Docks |
| 14) Pantheist College | |

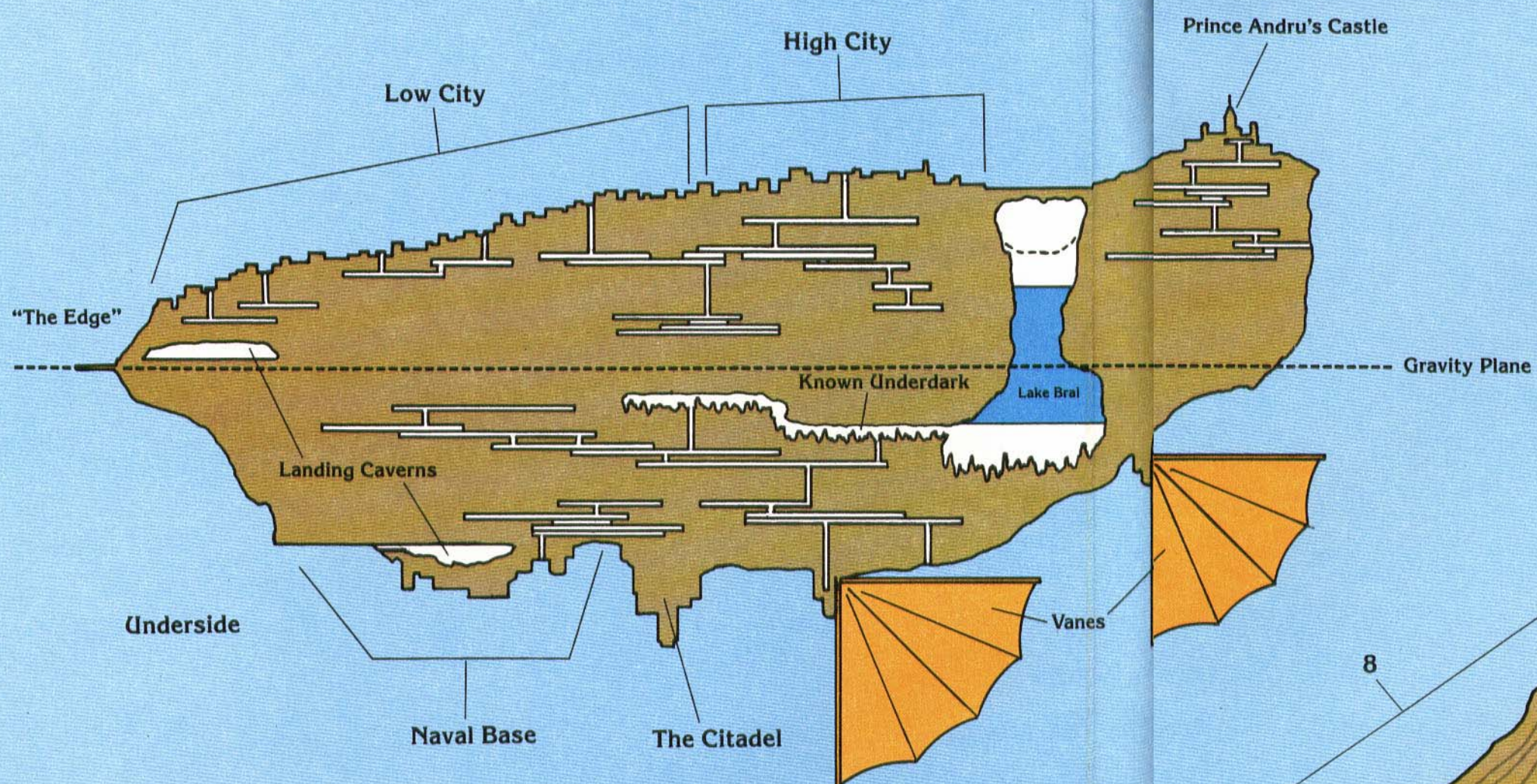



REALMSPACE

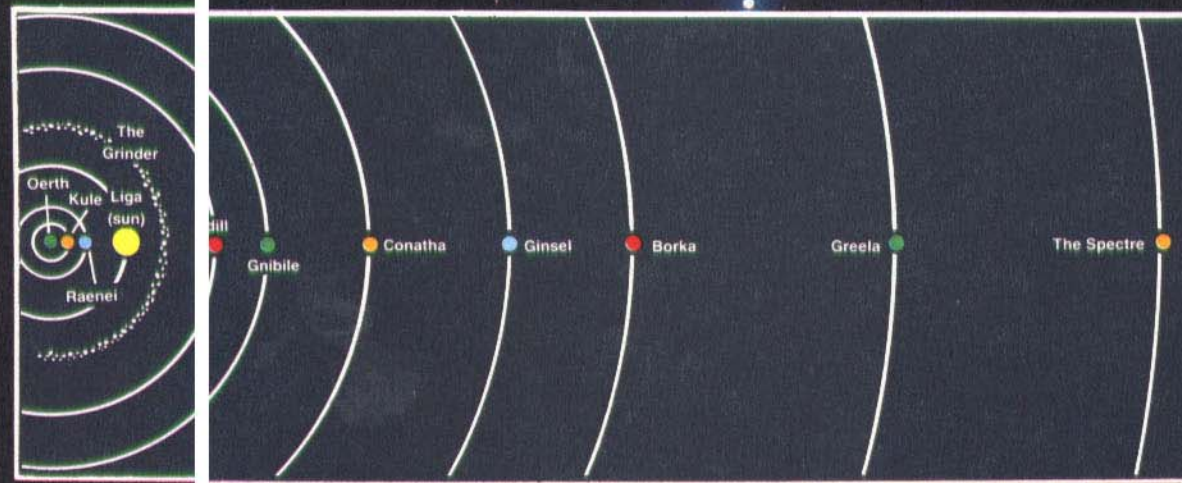

GREYSPACE

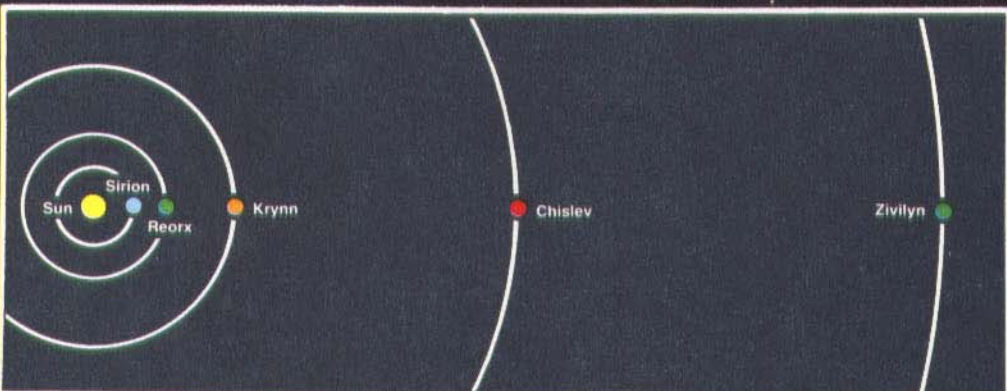
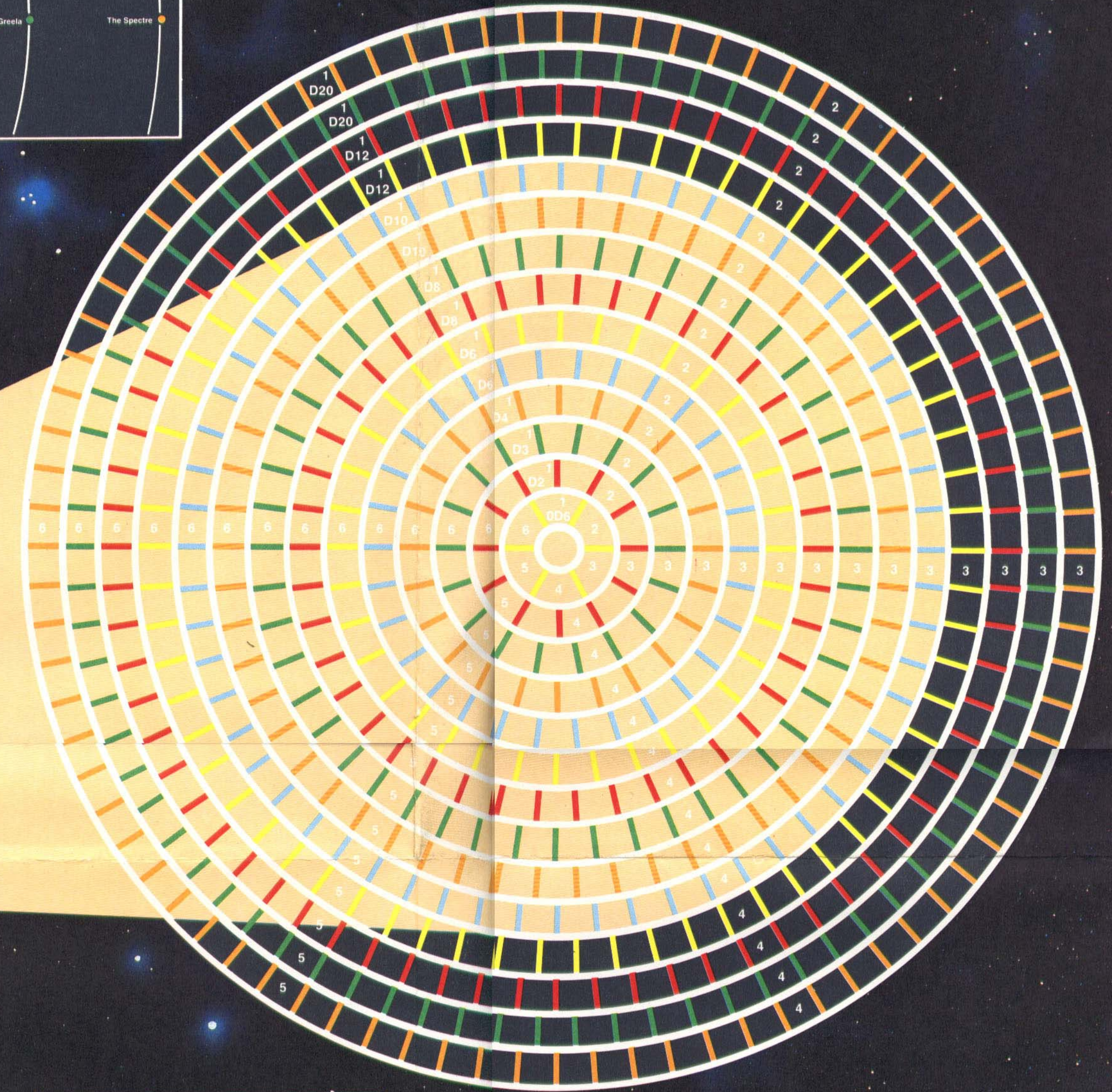
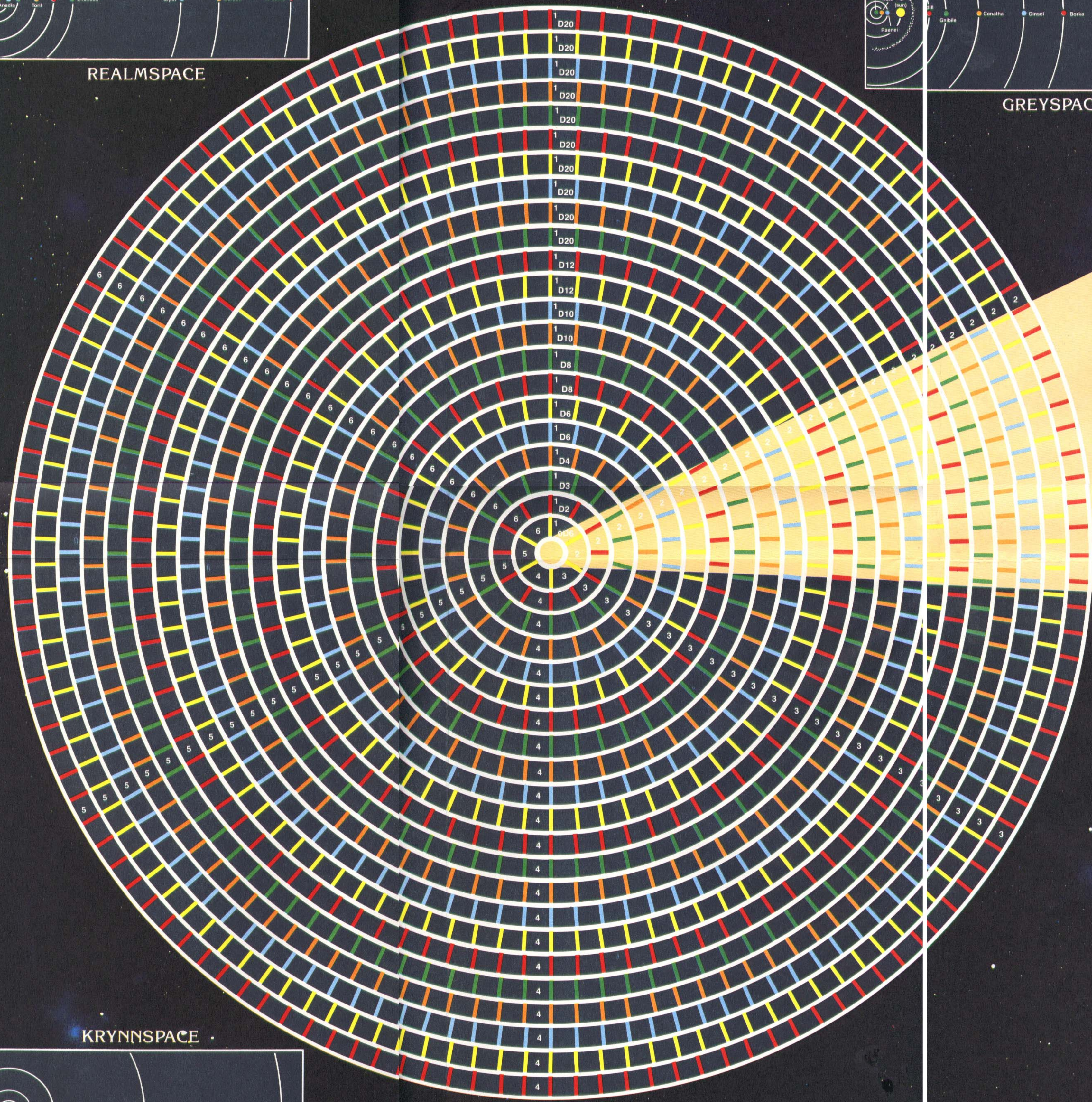

KRYNNSPACE



Planetary Display Map

PLANET	SIZE	SHAPE	TYPE	PLANET	SIZE	SHAPE	TYPE
1				11			
2				12			
3				13			
4				14			
5				15			
6				16			
7				17			
8				18			
9				19			
10				20			

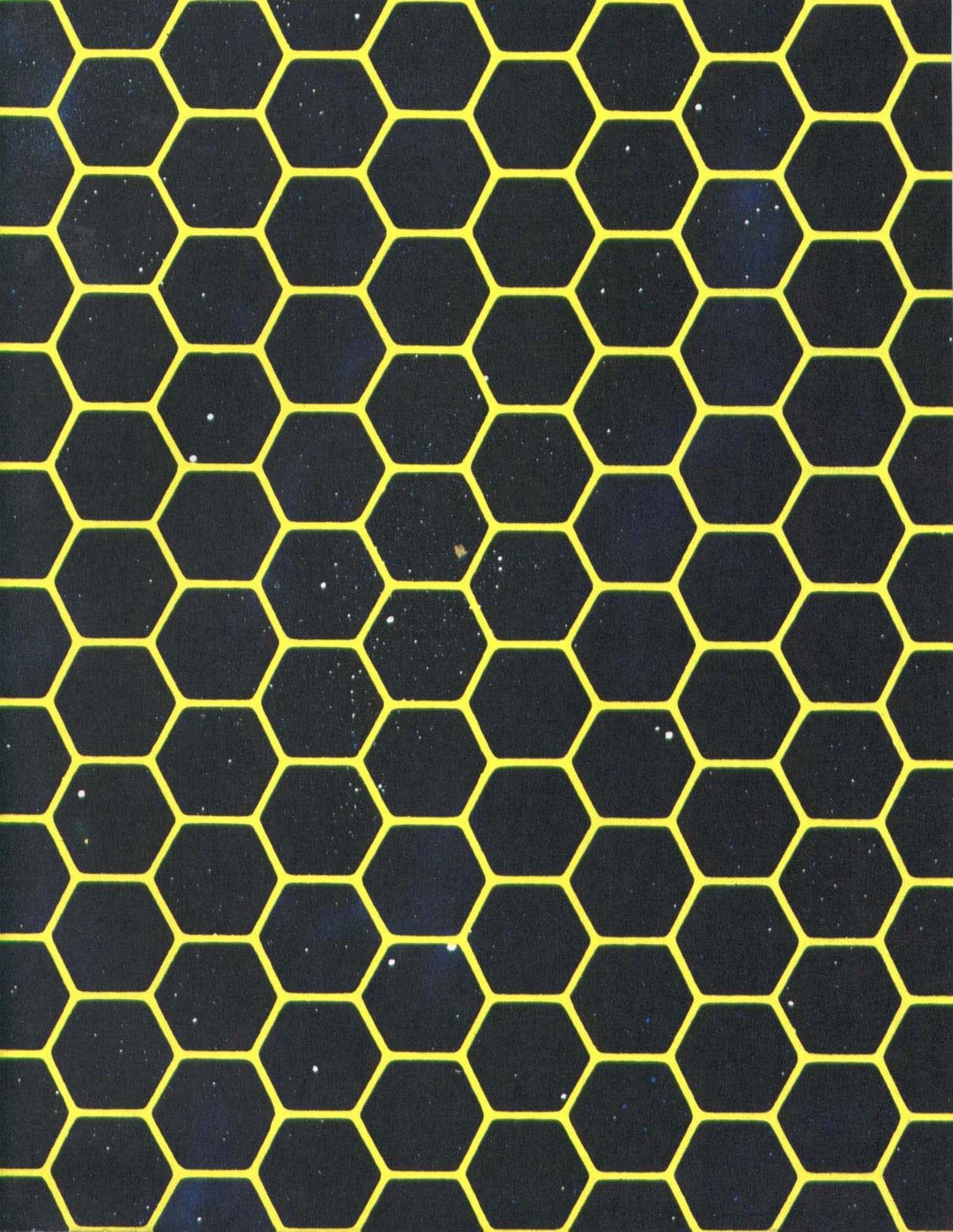

Advanced Dungeons & Dragons[®]
2nd Edition



AD&D[®] ADVENTURES IN SPACE

Multitudes of worlds wheel through Wildspace. The crystal shells that encase them bob and drift in a turbulent, rainbow ocean which fills all the cosmos. Sturdy merchants, bold pirates, and daring explorers venture into the great, unknown vastness of the universe, seeking wealth and adventure.

The SPELLJAMMER™ Game puts you in command of a fantastic ship capable of spanning the tremendous distances between planets. Graceful elven flitters, stately illithid galleys, deadly beholder tyrants, and the awesome *Spelljammer* itself carry trade, emissaries, and heroic action throughout all the worlds of the AD&D[®] game.

The SPELLJAMMER Game includes:

- Two 96-page books describing the mysteries of travel through wildspace, how to design ships for your adventurers, new spells, space monsters, intelligent, star-spanning races, and the lore of wildspace;
- Four maps showing planetary orbits, the gigantic *Spelljammer*, an asteroid city, and a tactical grid for space battles;
- Full-color cardstock sheets showing deck plans of the most commonly encountered space-going ships;
- Full-color, stand-up pieces for playing out tactical battles and encounters in space.

Designed by Jeff Grubb

\$18.00 U.S.
1049

ISBN 0-88038-762-9
46363 01049

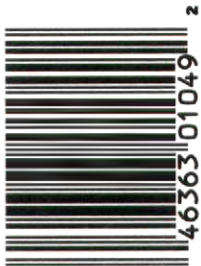

TSR, Inc.
POB 756
Lake Geneva,
WI 53147 U.S.A

TSR Ltd.
120 Church End, Cherry Hinton
Cambridge CB1 3LB
United Kingdom