

# Advanced Dungeons & Dragons®

2<sup>nd</sup> Edition

Game Accessory

## Strongholds

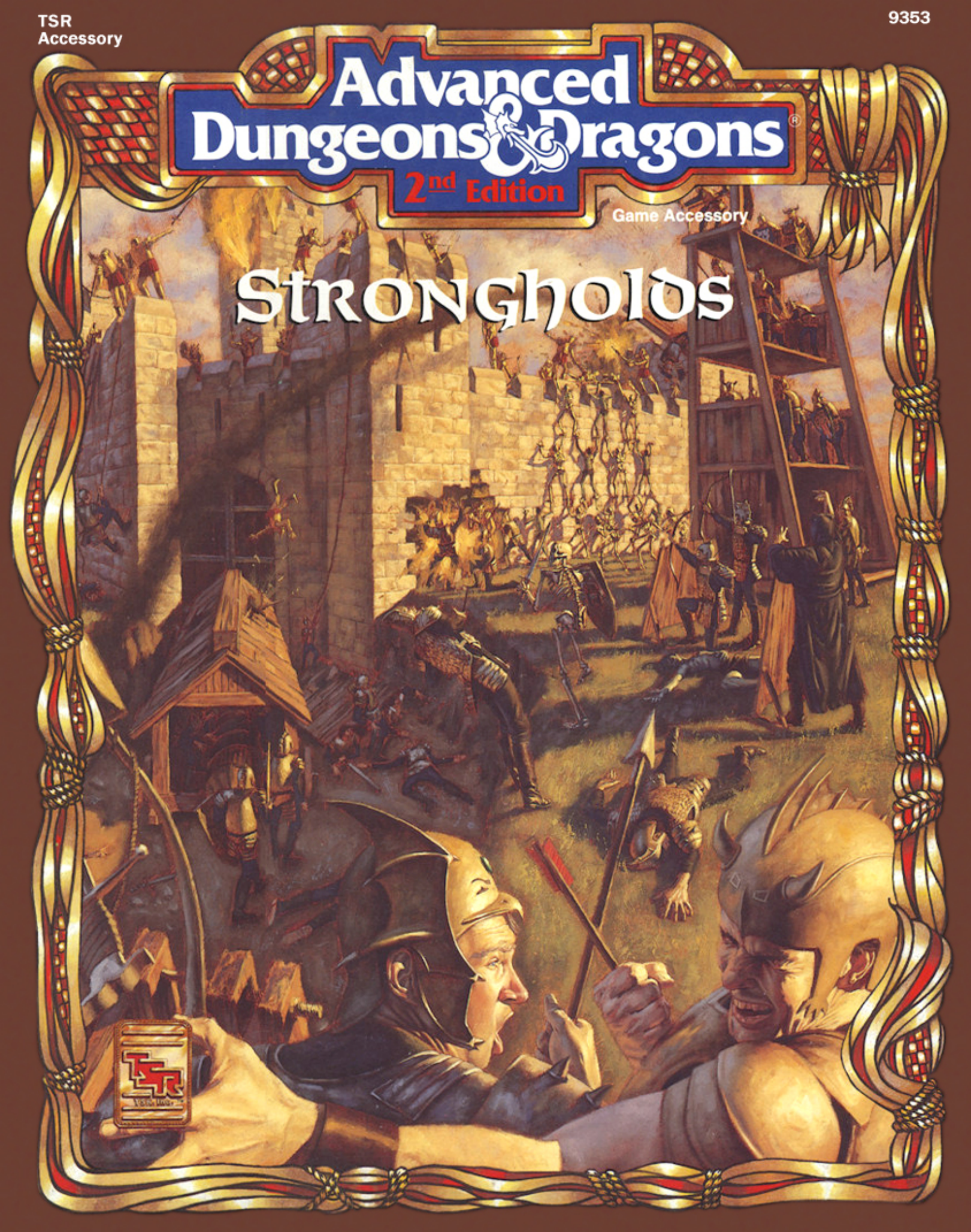

## STRONGHOLDS

### 3-D Assembly Instructions

#### What You'll Need

- White glue (such as Elmer's brand)
- Pencil (a new one, with no sharpened point, is best)
- Cloth or paper towel (for wiping excess glue from your fingers)
- Scissors (only for some battlements)
- Straightedge or ruler (for some battlements and conversions)
- Razor knife (for conversions)

#### Getting Started

Lay out some newspaper to work on. This will protect your table from spilled glue and small nicks.

Check the assembly diagrams and pick a building to assemble. The basic building illustrated on page 3 is recommended (four walls, peaked roof). Its simple design makes it a good starting project. Carefully separate all the pieces for that building and lay them out on your work table.

Before gluing, gently flex all the pieces of your building back and forth along the fold-lines (called "score lines" or "scoring") to be sure they fold in the proper way.

#### Gluing

Use white glue to join the pieces together as shown in the assembly diagram. Follow the sequence as it's illustrated. For a strong bond,

follow these tips:

- Apply the glue carefully. A single, thin strip along the length of the joint is best.
- Put the glue on the smaller of the two surfaces being joined (usually a tab); this way, you don't get glue on areas that don't need it.
- Spread the glue evenly with your finger to cover the entire tab or gluing surface.
- Wipe away excess glue with your finger so only a thin, shiny layer remains. This layer of glue will become sticky in seconds.
- Position the pieces and press them together with your fingers. Then lay the assembled piece on your table and use the pencil to apply even pressure all along the joint.

If you did all this properly, the bond should be strong enough to handle in seconds.

If your buildings sometimes pop apart after they should be dry, try this: Before putting any glue on, use a small penknife to scrape away the shiny coating on the colored side of the gluing tab to expose some paper. White glue bonds to the paper more strongly than to the varnish.

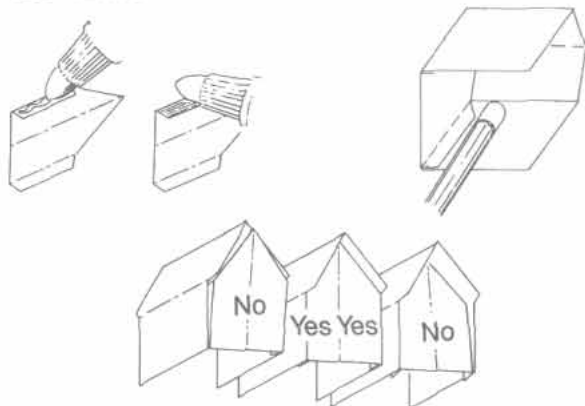

# What You Get

		Qty.	Finished Size
<b>1</b>	Peaked-roof buildings	3	2×2
		2	2×3
		3	2×4
		4	3×3
		4	3×4
<b>2</b>	Flat-roofed buildings	2	2×2
		4	3×2
		4	3×3
		4	3×4
<b>3</b>	Wall Sections	3	1×3
		6	1×4
		3	1×5
<b>4</b>	Battlements	3	3
		6	4
		3	5
<b>5</b>	Gatehouse	1	1×2
<b>6</b>	Gables	8	
<b>7</b>	Balconies	6	
<b>8</b>	Large Spires	6	
	Small Spires	8	
<b>9</b>	Large Chimneys	4	
	Small Chimneys	6	

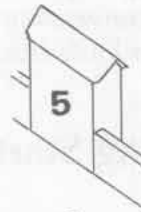
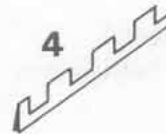
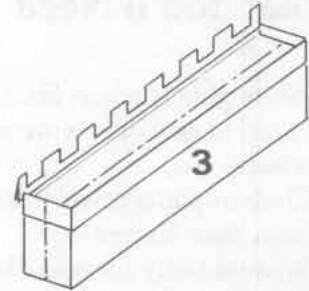
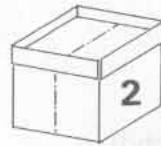

## Peaked-Roof Building Assembly

The peaked-roof building is the most basic building block, and the simplest to assemble. Use the basic assembly instructions to put together the pieces shown below.

When assembling gables, be sure to fold the gluing tabs outward, not inward. The window should be set back under the roof overhang, so it lines up properly with the first-floor wall.

Your buildings can be stored flat if you don't glue the chimneys and gables in place.

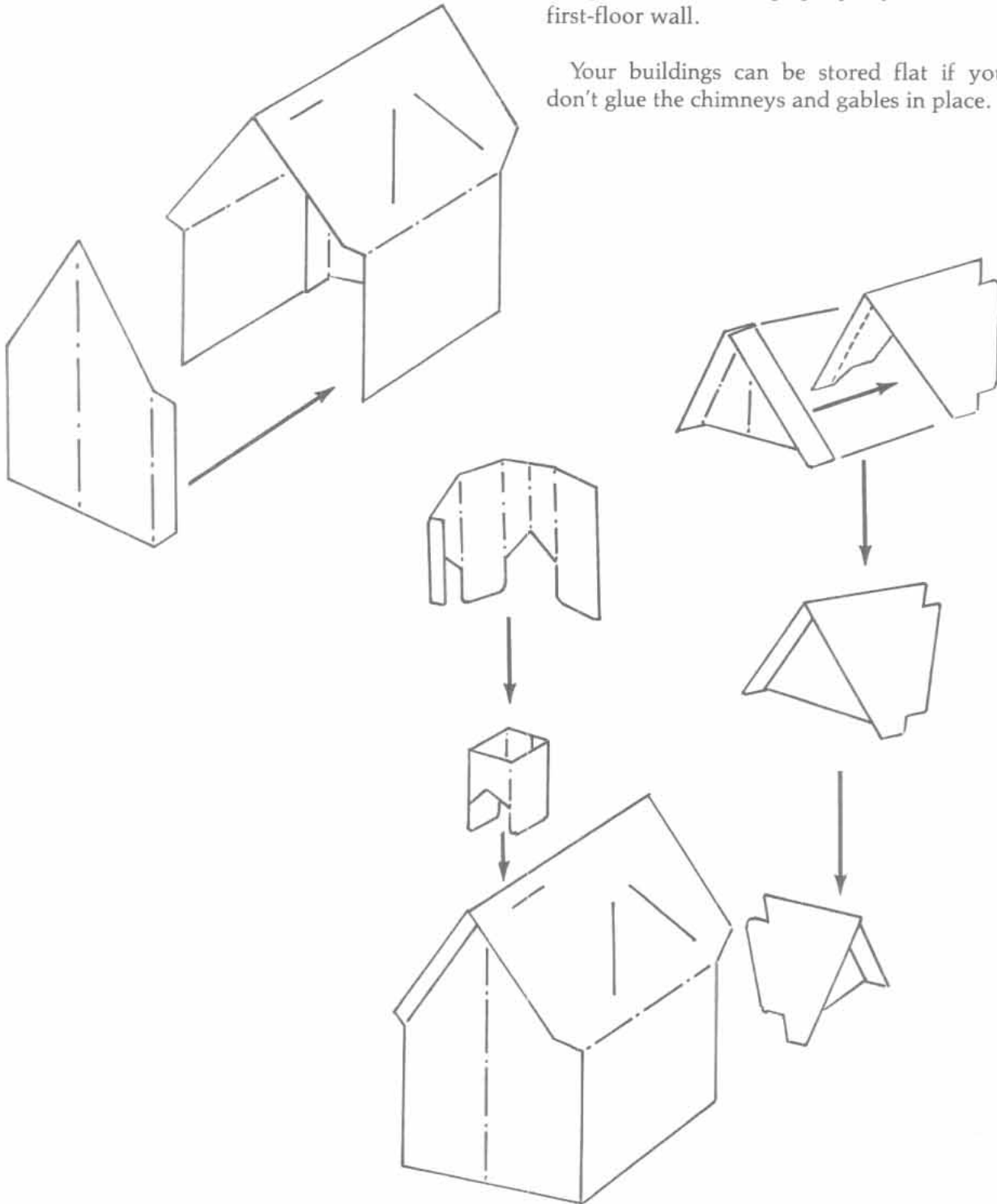

## Flat-Roof Building Assembly

A flat-roof building is basically the same as a peaked-roof building, with the addition of collar pieces which attach around the upper edge. These collars hold upper story pieces in place. It is important to apply glue only to the bottom half of the collar pieces, and leave approximately half of the collar extending above the top of the building.

Some collar pieces have small corner tabs. These reinforce the joints above the top of the building, where the collars aren't joined to anything. Finishing the corner by attaching

this tab to the adjoining collar piece makes the collar stronger, but the building will be easier to assemble and collapse if these tabs are removed.

Several balconies are included. These can be placed in front of doors which wind up on upper floors (so the doors don't just open onto empty space). Slots for the balconies, however, are not pre-cut; you must cut your own slots to position the balconies where you want them.

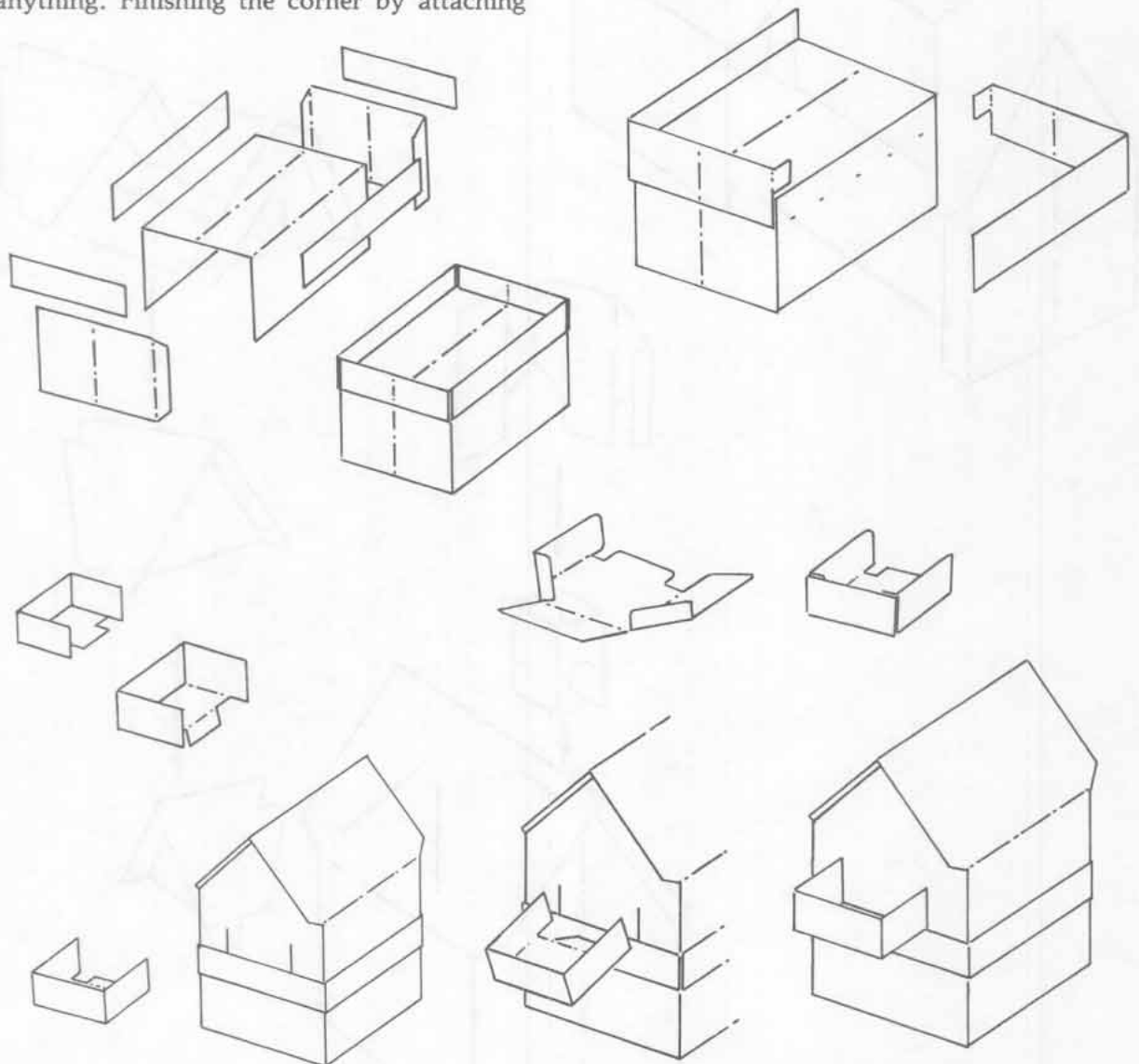

## Simple Combination Techniques

Once you have some basic buildings assembled, they can be combined to form larger structures.

To join two peaked-roof buildings, slide the eave of one roof under the eave of the other roof. The roof of the first building will fit snugly between the roof and end wall of the second building. The same thing can be done to join one building to the gable of another in a T-shape. When combining buildings this

way, two paper clips attached at the bottom corners will hold the buildings together snugly.

To create an overhanging second story so typical of medieval towns, simply place a larger building atop a smaller one—a 3×4 building on a 3×3, for example. To make a veranda, do the opposite—put a smaller building on top of a larger one.

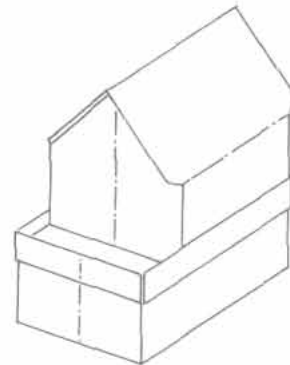
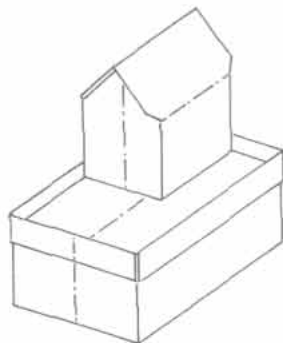
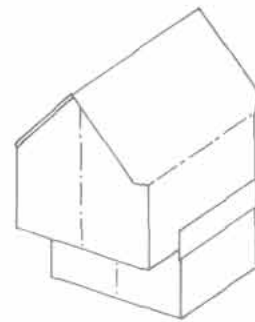
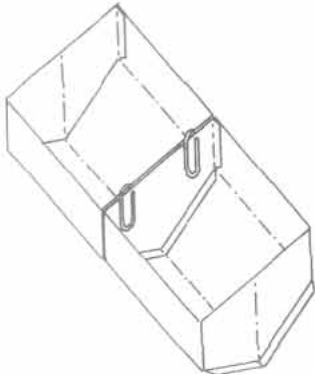
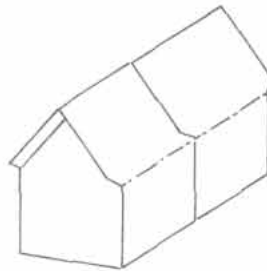
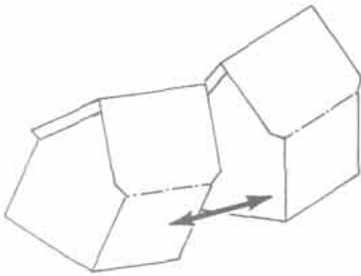

## Manor House Assembly

The manor house is the largest single assembly in this set. The house itself consists of 12 separate buildings. Two outbuildings, a gate, and four stone wall sections complete the manor.

This particular structure can be assembled

many different ways besides the one shown here. By removing one floor from the manor house, the complex can be spread out more, forming a much larger enclosed courtyard. Numerous other arrangements are also possible.

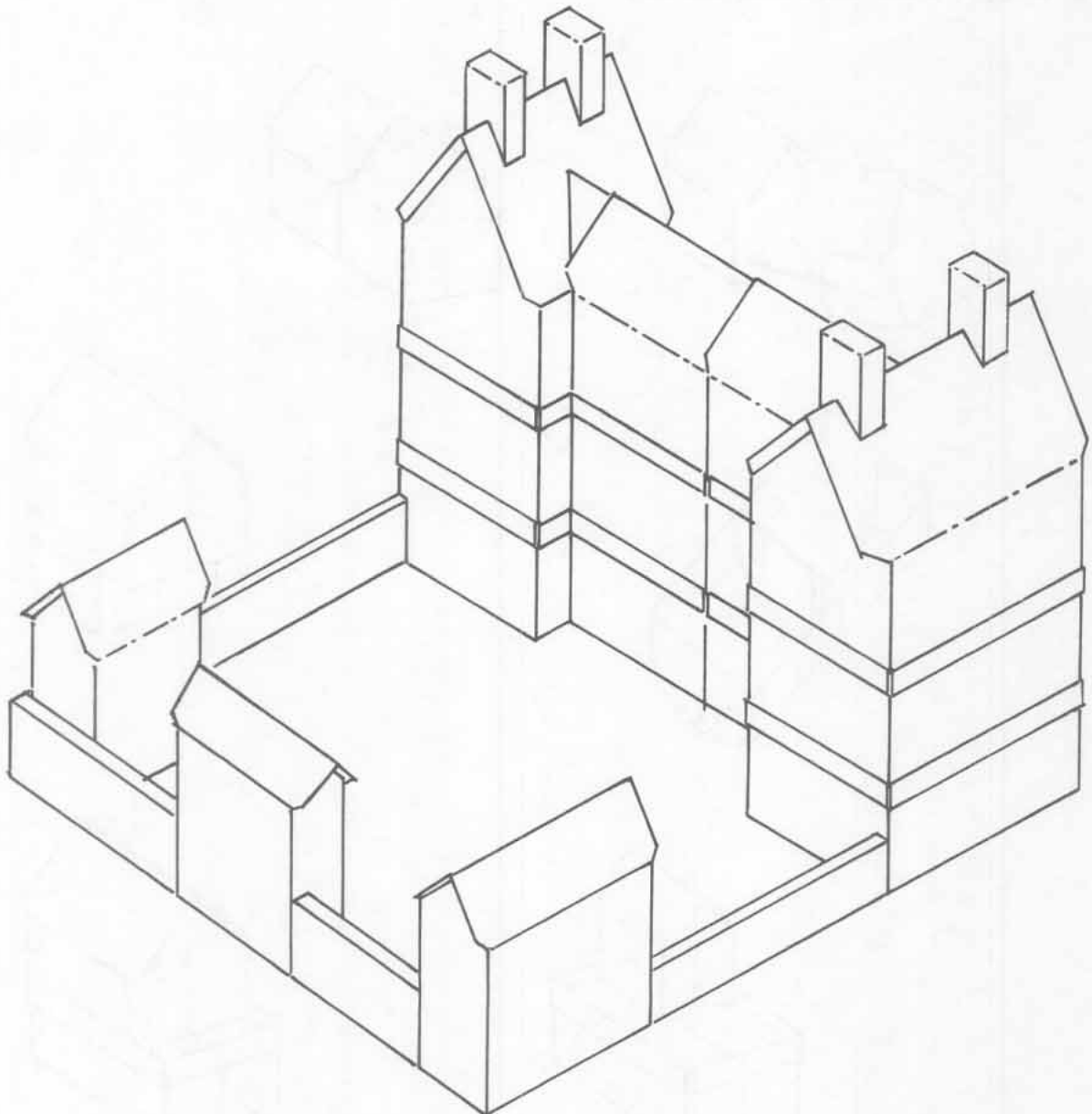

## Spired Temple Assembly

The four temple buildings included can be combined to form one large temple complex, or used individually to represent small chapels

or shrines (or large mausoleums). The spires attach at the corners, much like chimneys.

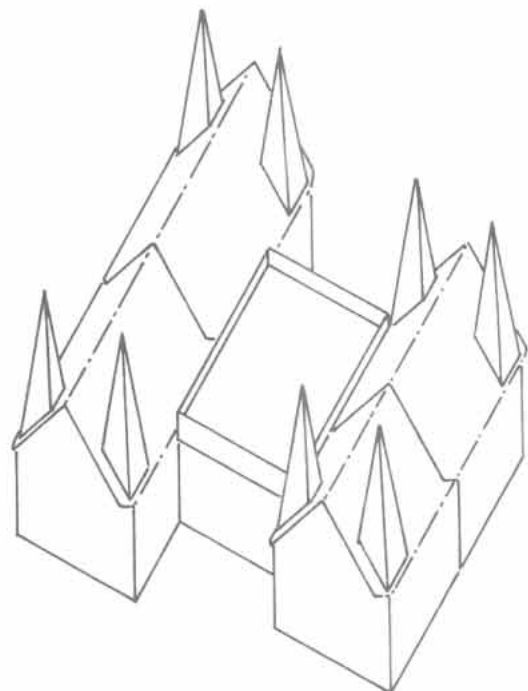
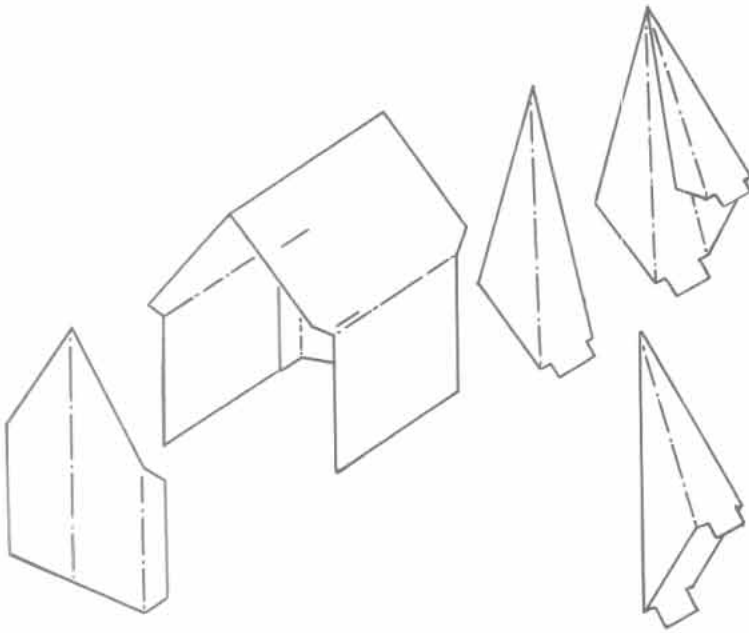



## Assembling a Gate from Houses

Five (or more) buildings can be assembled to form a gate or entryway into a walled courtyard. Assemble the pieces as shown below to give your stronghold a dramatic entrance. The central building is suspended from the gables of the two flanking towers. Alternately, it can be suspended from the collars of the two ground-floor buildings.

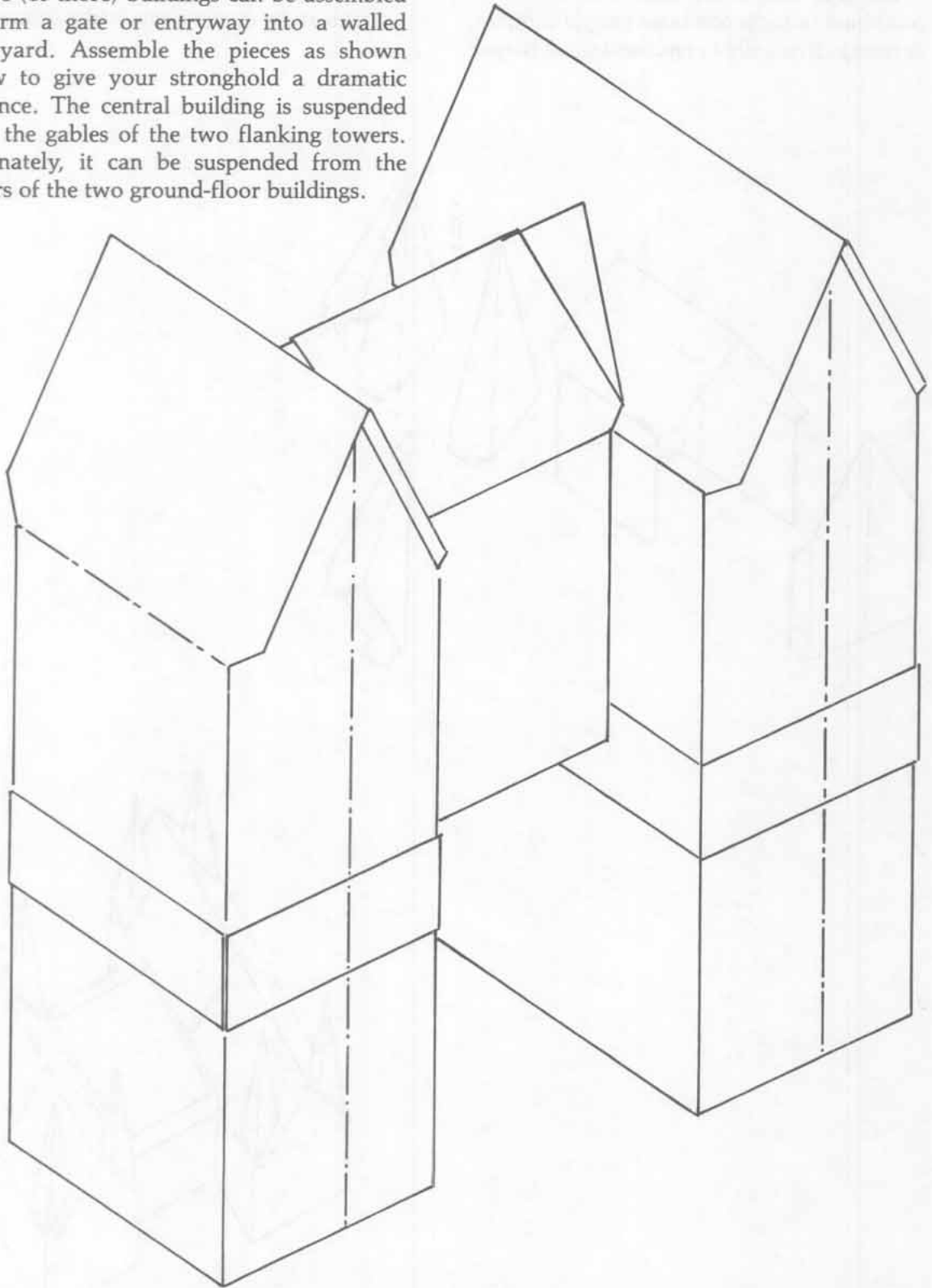

# Fortified Walls and Crenellations Assembly

The basic wall is assembled just like a flat-roof building. Then the crenellations are added separately. Don't glue the crenellations to the building, so you can remove them or switch them to another building if you change layouts.

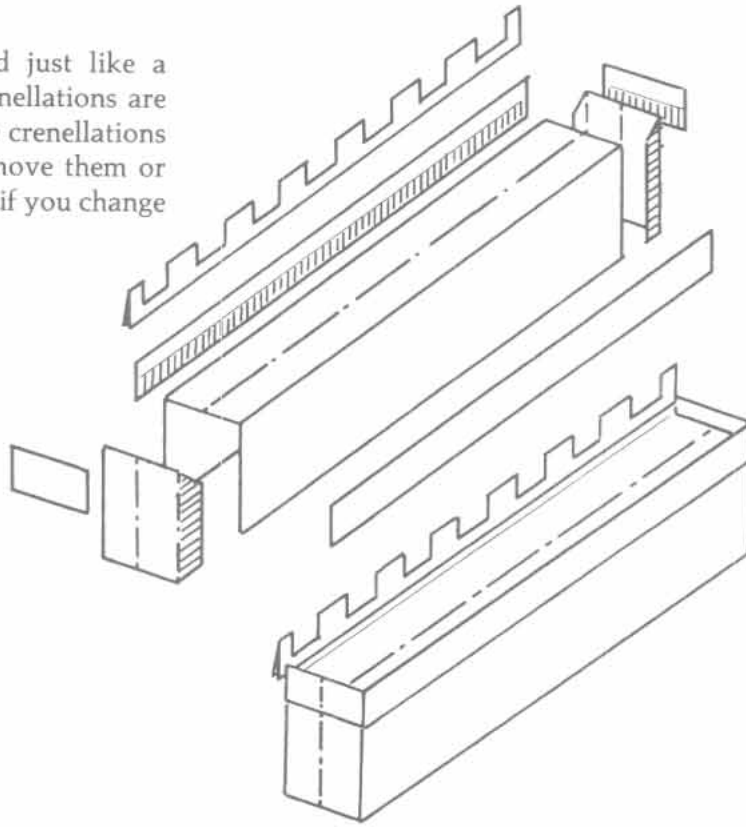

Battlement

Punch out and remove areas above dotted line.

DO NOT punch out small tabs

a. Swing tab open like gate;

b. Apply glue to back (white) side of tab;

c. Glue tabs in place;

d. Apply glue to front (stone) side of folded and glued tabs;

e. Fold entire battlement and press together.

Bottom of battlement splays open (DO NOT glue shut!).  
Battlement sits on collar of wall or building.

## Assembling a Gate from Fortified Walls

A gateway can also be assembled from stone fortification walls, or from a combination of outer walls and buildings. In some cases, this may require a bit of extra cutting along the collars. Plan the effect you want, then locate your cuts carefully.

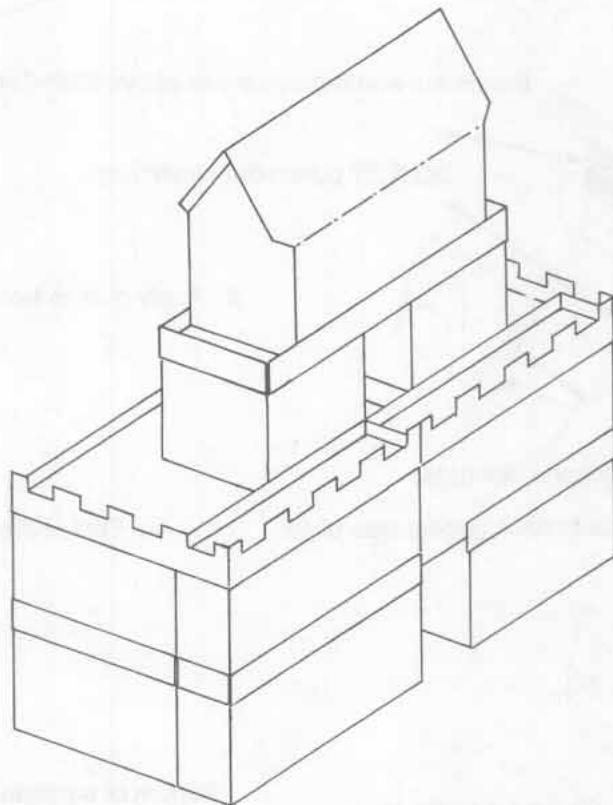
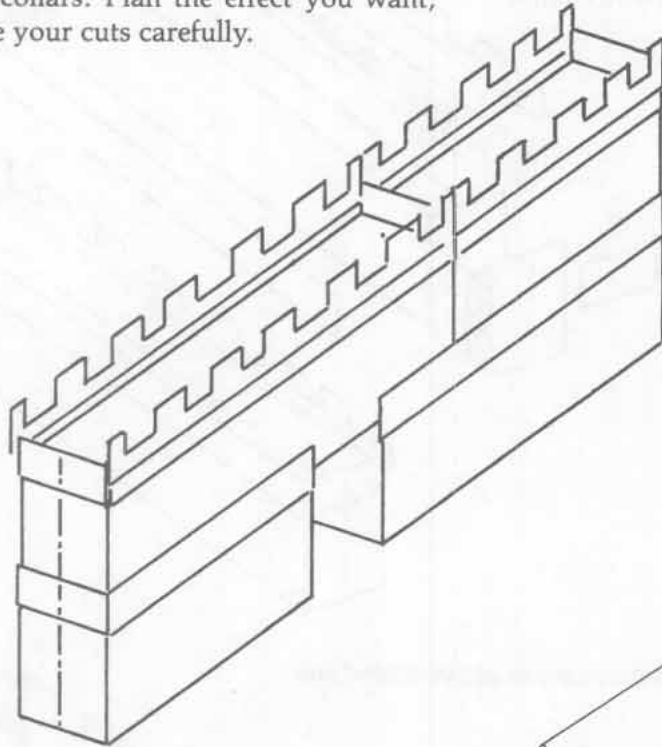

## Stacking Peaked-Roof Buildings

An upper floor can be added to a peaked-roof building. The upper building should be smaller than the lower one. Using a razor knife, make two slices across the peak of the roof of the lower building as shown below. Carefully slide in the walls of the upper building.

These cuts are easiest to make before either building is assembled. To figure out how long the cuts should be, measure across the end piece of the lower building until you find the point where it is as wide as the upper building. Measuring along the outer edge of that triangle shows how far down the roof the slits should extend, while the side wall of the upper building shows how far apart the slits must be.

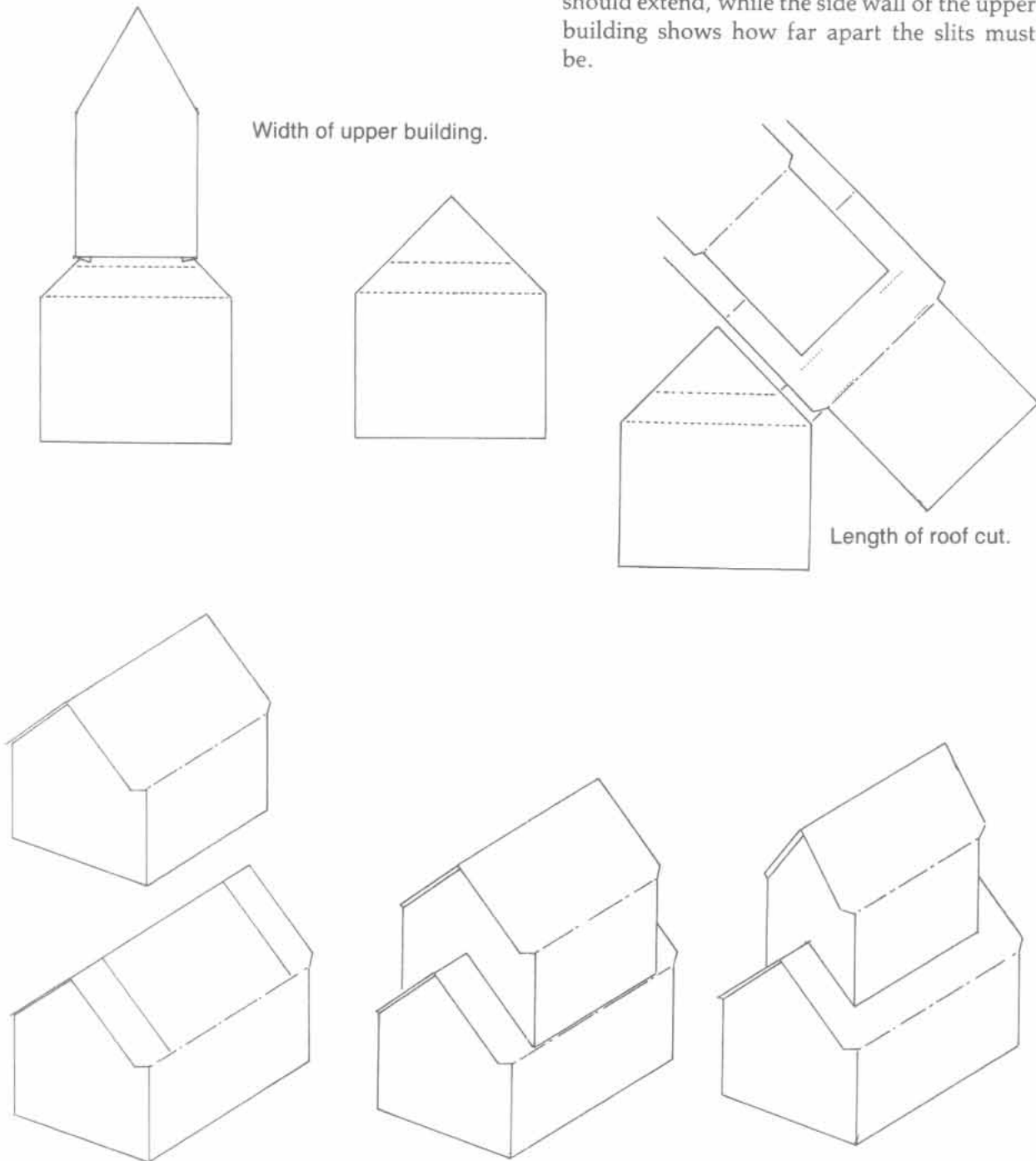

## Stone and Half-Timbered Ruins

Very interesting ruined buildings can be made easily with a razor knife.

To make a ruined flat-roofed building, start by slicing off the roof about  $\frac{3}{16}$  of an inch below the top; this leaves the roof with gluing flaps on two sides. Next, glue all four wall sections (two ends, and the two walls created by removing the roof) into one long strip. Use paints or a gray pencil to color the inside surfaces of the wall gray, to look like stone. Now, with the razor knife, carefully cut away the top portion of the walls along an irregular line, following the stone pattern to give the wall a natural appearance. Doors can be re-

moved or cut and swung open. Windows can be wholly or partially taken out, leaving some or all of the arched frame in place. Be sure the wall is the same height at both ends, and then glue it together into a bottomless box. Finally, turn the roof (which was removed earlier) inside-out and glue it in as a floor so the building will keep its shape.

To make a ruined half-timbered building, follow basically the same steps, but make at least some of your cuts along the timbers. Be sure to paint or color the inside walls to match the outside pattern.

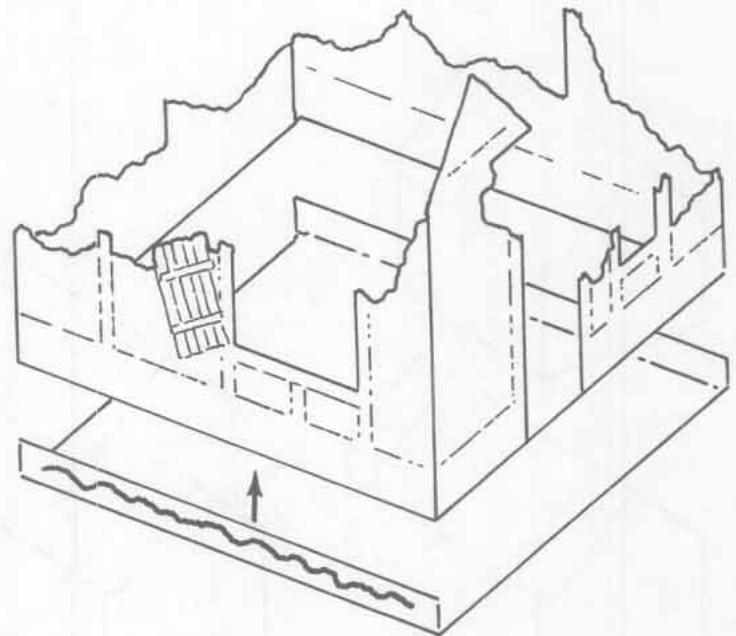
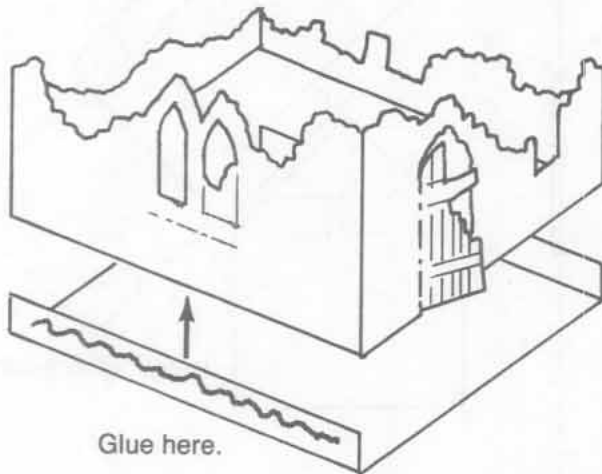

## Roofed and Two-Story Ruins

The same procedure can be followed to make larger ruined buildings with partial roofs or partially intact upper floors.

Don't cut the roof off; leave it on the top of the building and it will still keep the building rectangular, as long as it connects two opposite walls. When cutting away chunks of roof, be sure to follow the shingle lines for a natural-looking breach. Don't forget to knock out part of the chimney, too.

Even if the building is not in ruins, cutting a few holes in the roof will make it look aban-

doned or neglected. Slicing out a portion of a window along a jagged break line has the same effect, as does cutting open the door and making it sag on its hinges.

An especially impressive ruin can be made by knocking out one wall and part of the adjoining walls on the first floor, and adding a mostly-ruined second floor. If the roof is still on the first floor, it will be exposed through the collapsed wall. Scatter a few shingles on the lower floor to create the look of a collapsed roof.



## Mounting Buildings on Sturdy Bases

Your strongholds will be much sturdier if you mount them on temporary bases.

The best material for making bases is foam-core. This is a sheet of foam, approximately 1/4-inch thick, sandwiched between two layers of stiff paper. It can be purchased inexpensively at most art supply or business supply stores.

Slice your mapsheets into thirds as indicated on the maps. Select the map you want to mount and carefully cut out the building floors printed on it, keeping them slightly smaller than the full size of the building. (Obviously, this prevents you from using both sides of the map, so choose carefully.)

With the floors cut out, mount the map on a piece of foam-core using spray adhesive or rubber cement (also available in most art supply stores). Mount your cut-out floors on another piece of foam-core the same way, then cut them out, trimming right up to the edges of the floors. Color the edges of the foam gray with a marker. Then glue these raised floors onto the original map in the spaces where they were cut out. Be sure to leave a gap of at least 1/16-inch between adjacent buildings so the walls can slide in.

Now, when your buildings are put on their bases, they won't jostle and slide around, and the whole thing can be picked up and moved if necessary.

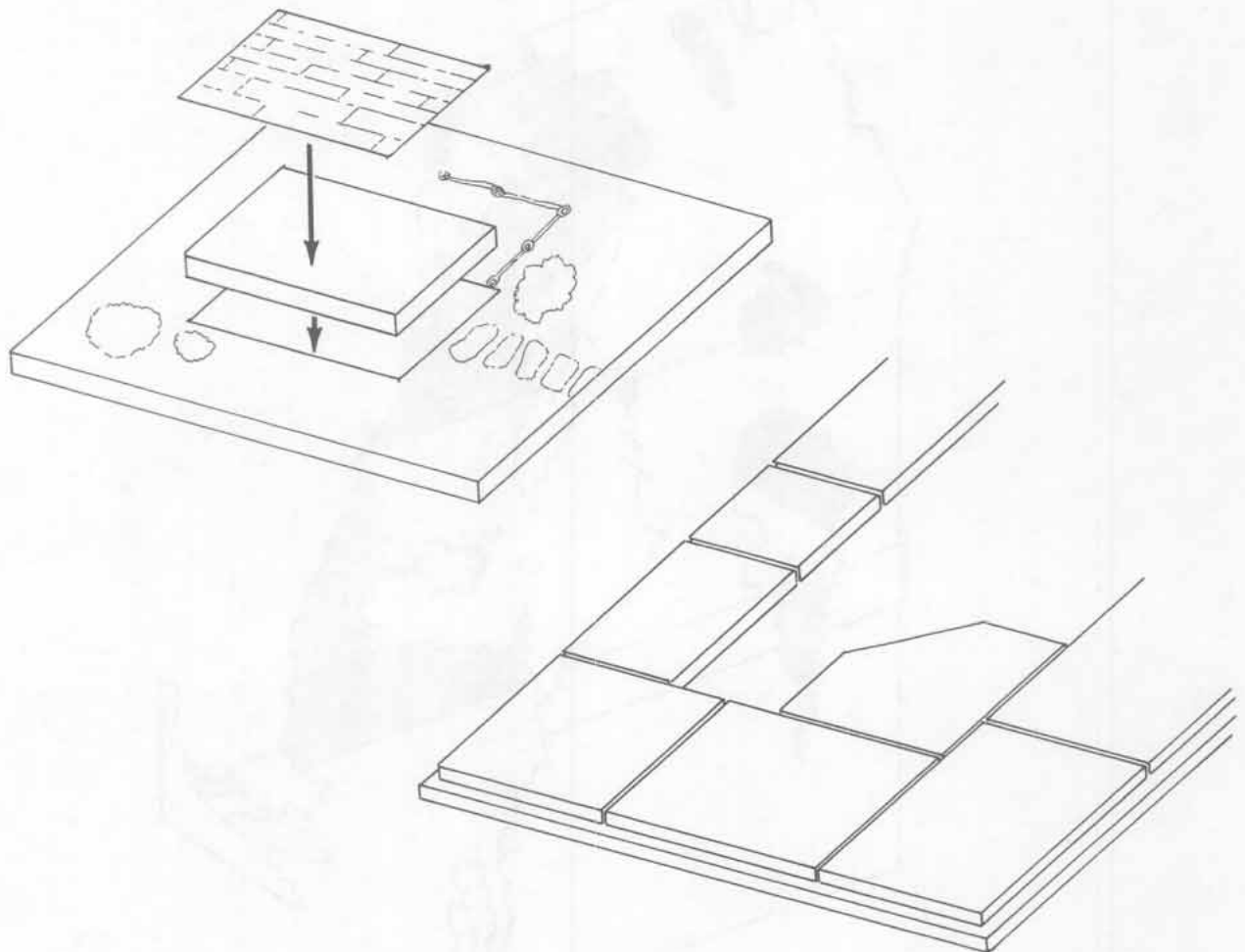

## Adding Three-Dimensional Detail

For a truly impressive-looking building, adding surface details is especially effective. This requires a handful of thin balsa wood strips or some stiff card (either material should be about  $\frac{1}{16}$ -inch thick).

Using a razor knife, cut the balsa or card into strips which are the same width as the timbers, doorframes, and windowframes on the building. Taking your measurements directly

from the building, cut strips of wood or card to the proper lengths. Stain, paint, or color the pieces to match the building timbers. Then glue them onto the building, replacing the printed timbers.

You can do the same thing to the shutters and doors, but note that a door will look more natural if it is thinner than the doorframe.

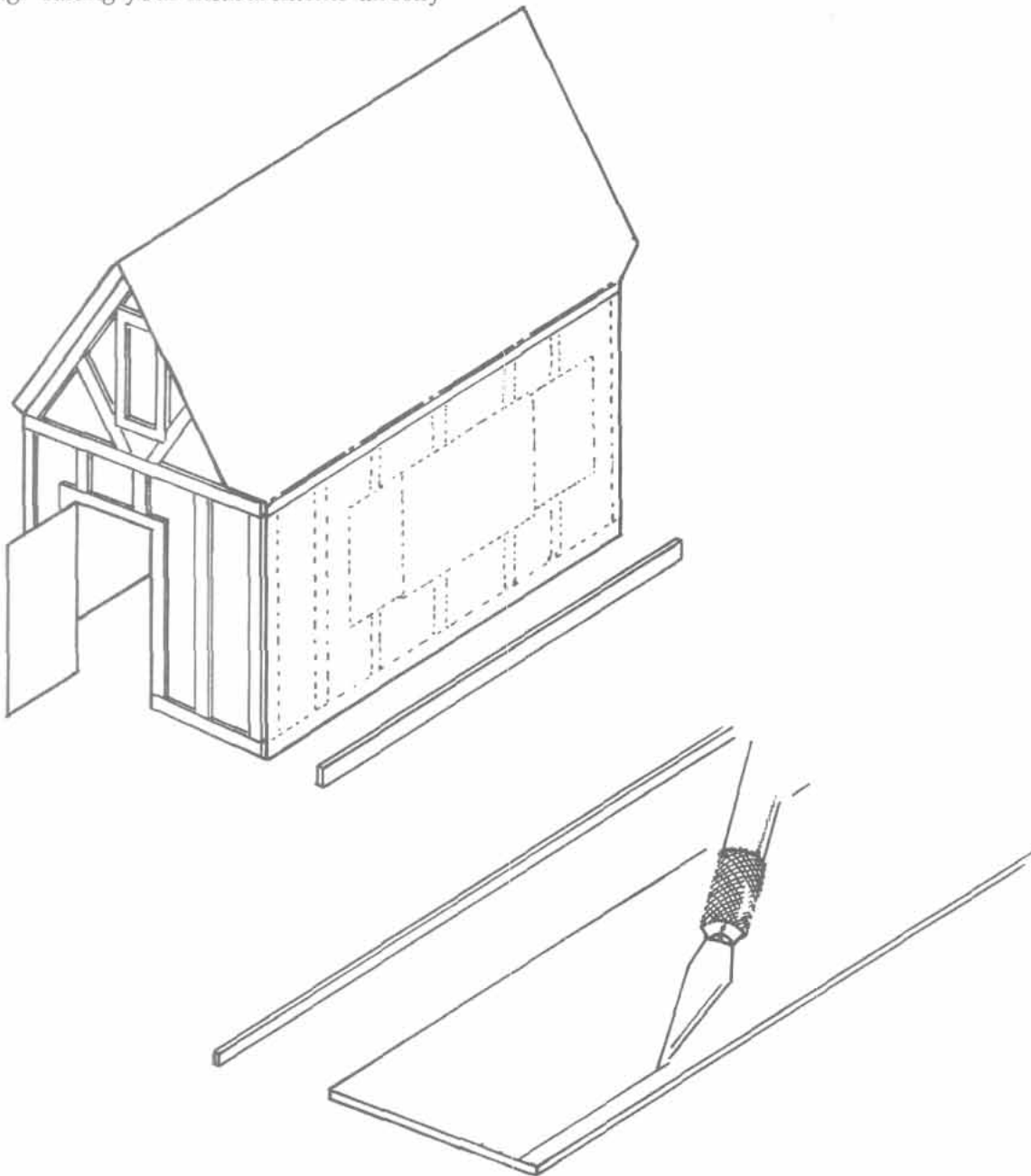



## Collapsing the Buildings for Storage

To keep your finished buildings looking as good as possible, store them upright in a sturdy box. If space is limited, however, most of the buildings can be collapsed and stored flat in very little space.

All peaked and flat-roof buildings can be folded flat as shown below. Gables and chim-

neys can also be folded flat, but must be removed first. Garden walls, spires, and balconies cannot be flattened.

If you intend to store buildings this way, it is best to flex the walls along the collapsing fold lines before assembly, to reduce stress on the glued joints.

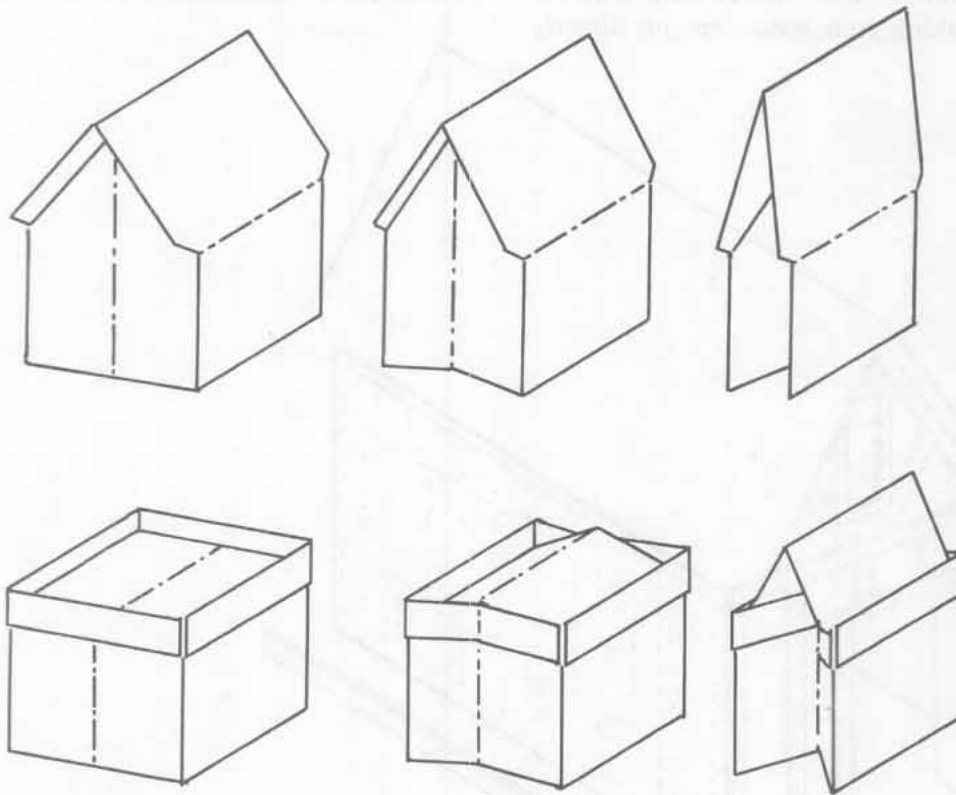

Building designs and diagrams by Dennis Kauth and David C. Sutherland III.  
Editing by Steve Winter.  
Cartography by Dennis Kauth and Frey Graphics.

ADVANCED DUNGEONS & DRAGONS is a registered trademark owned by TSR Inc.  
The TSR logo is a trademark owned by TSR Inc. All rights reserved.

This product is protected under the copyright laws of the United States of America. Any reproduction or unauthorized use of the material or art contained herein is prohibited without the express written permission of TSR Inc.

Random House and its affiliate companies have worldwide distribution rights in the book trade for English language products of TSR, Inc.

Distributed to the book and hobby trade in the United Kingdom by TSR Ltd.

Distributed to the toy and hobby trade by regional distributors.

©1992 TSR Inc. All rights reserved. Printed in the U.S.A.

09353

TSR, Inc.  
POB 756  
Lake Geneva  
WI 53147 U.S.A.



TSR Ltd.  
120 Church End, Cherry Hinton  
Cambridge CB1 3LB  
United Kingdom

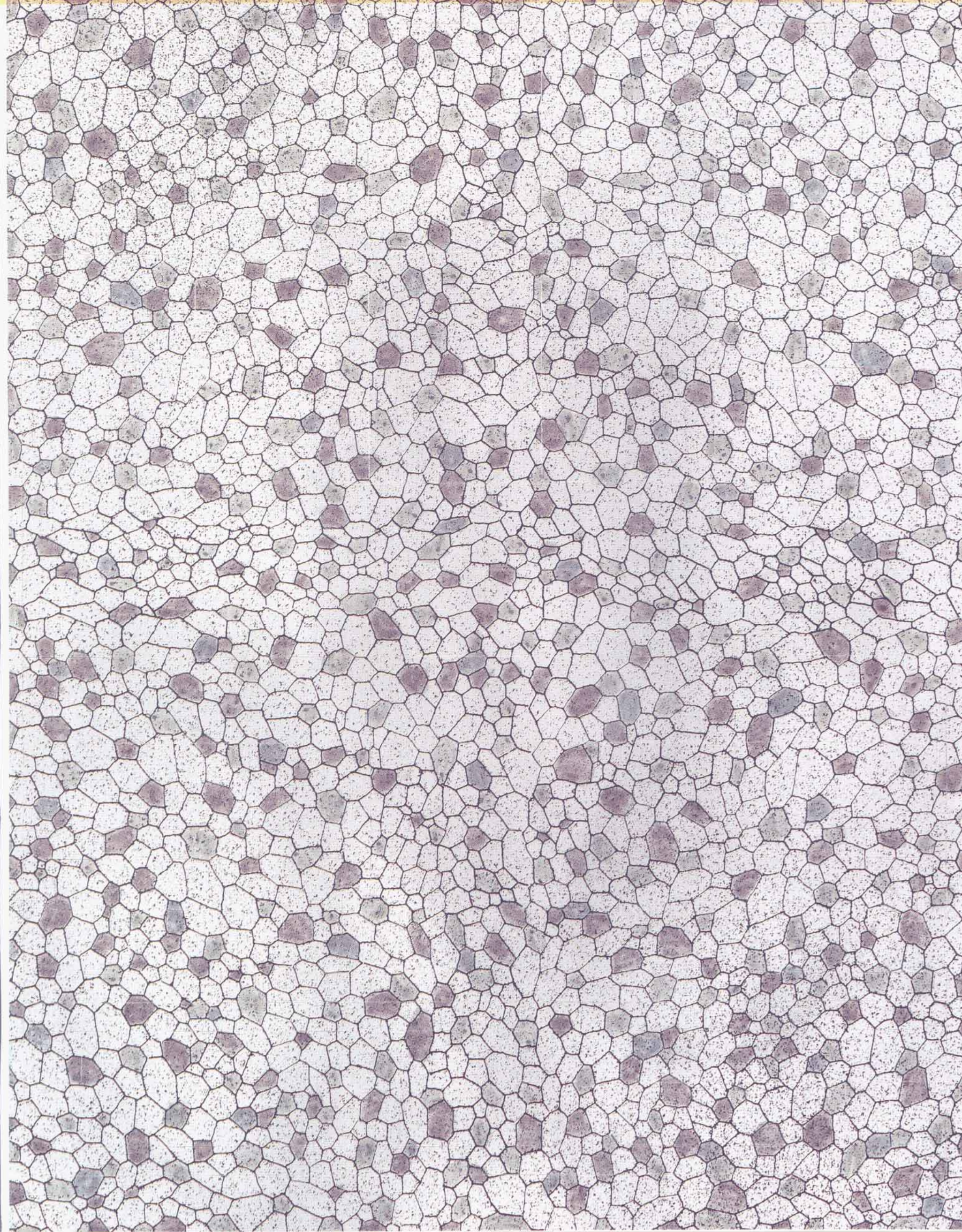

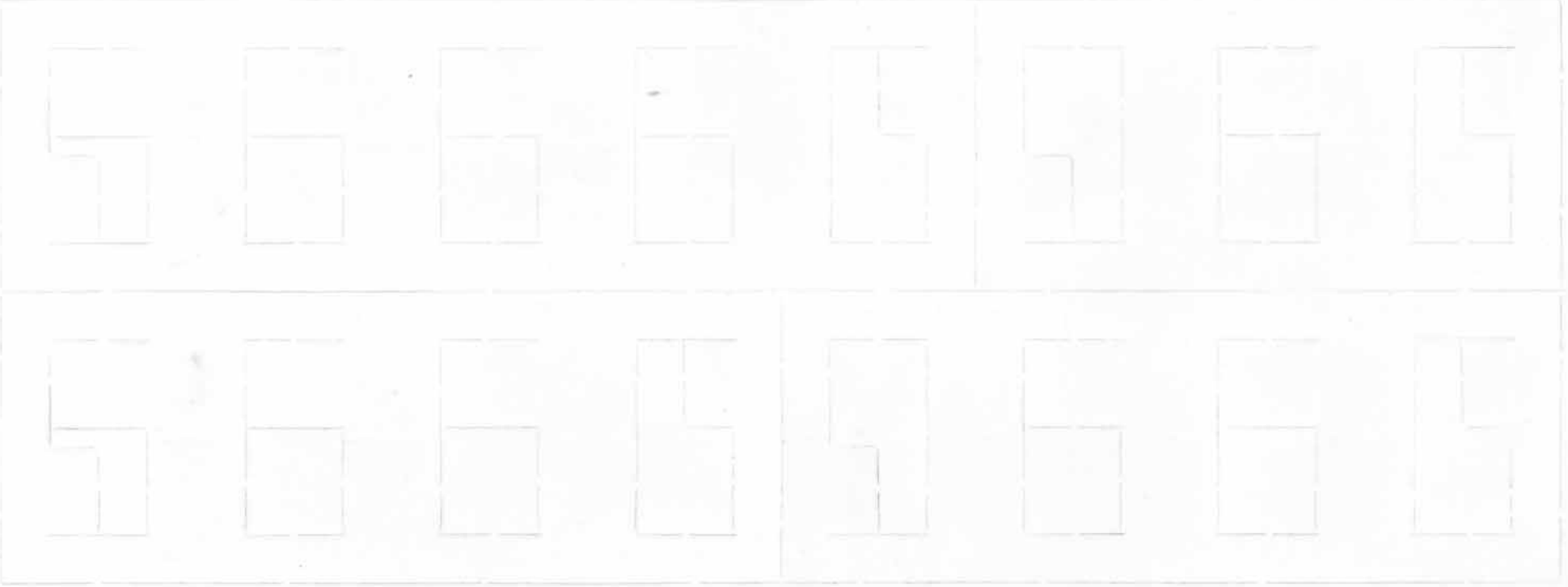
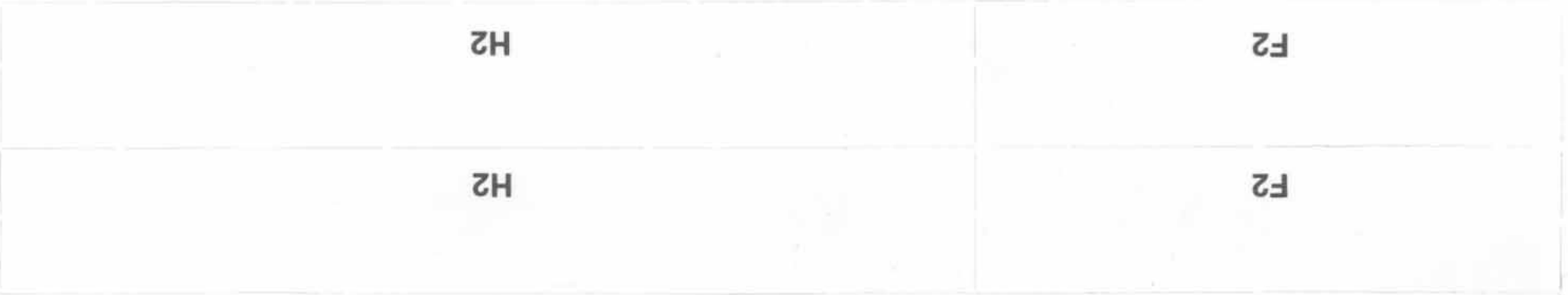
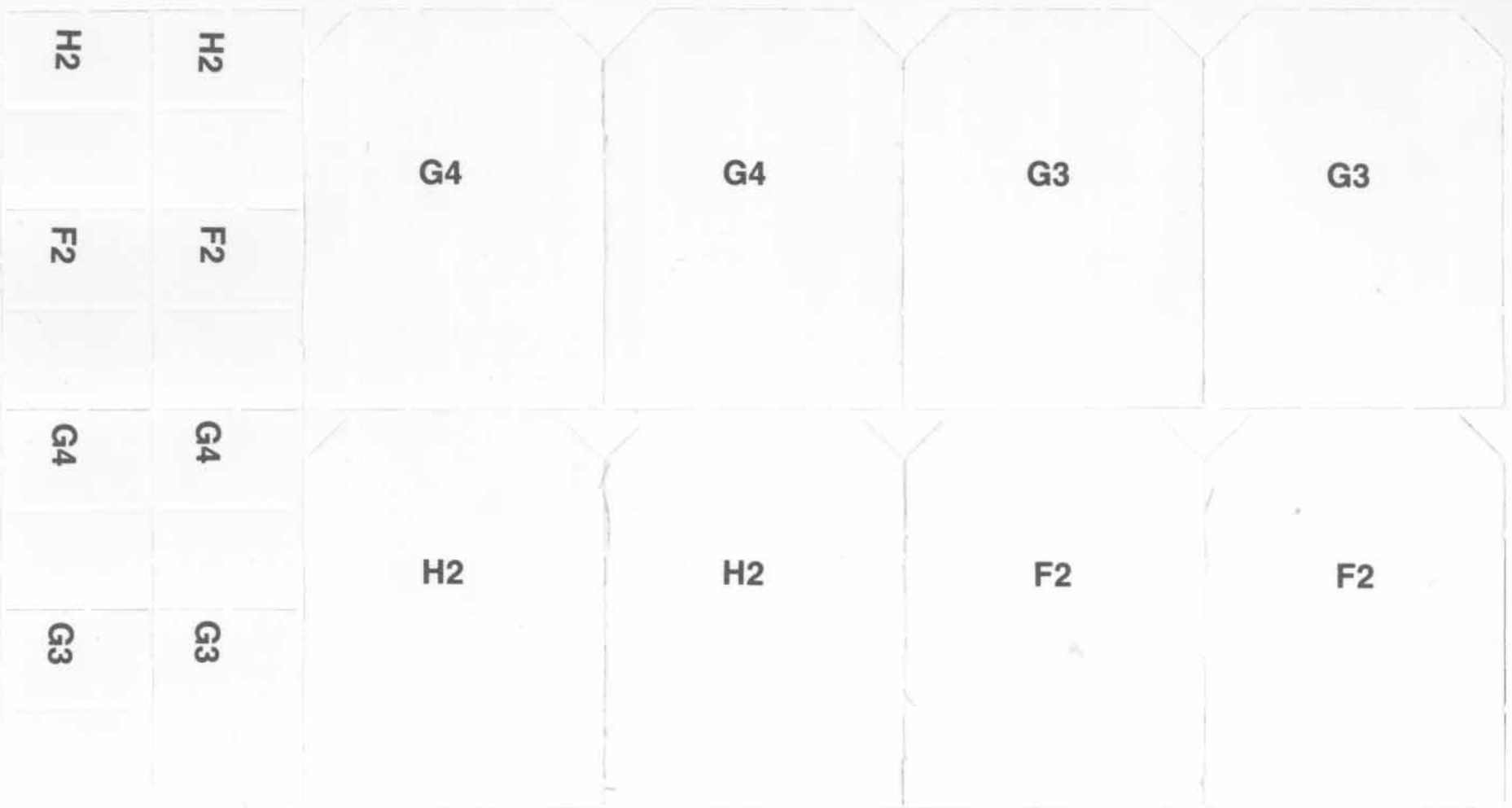

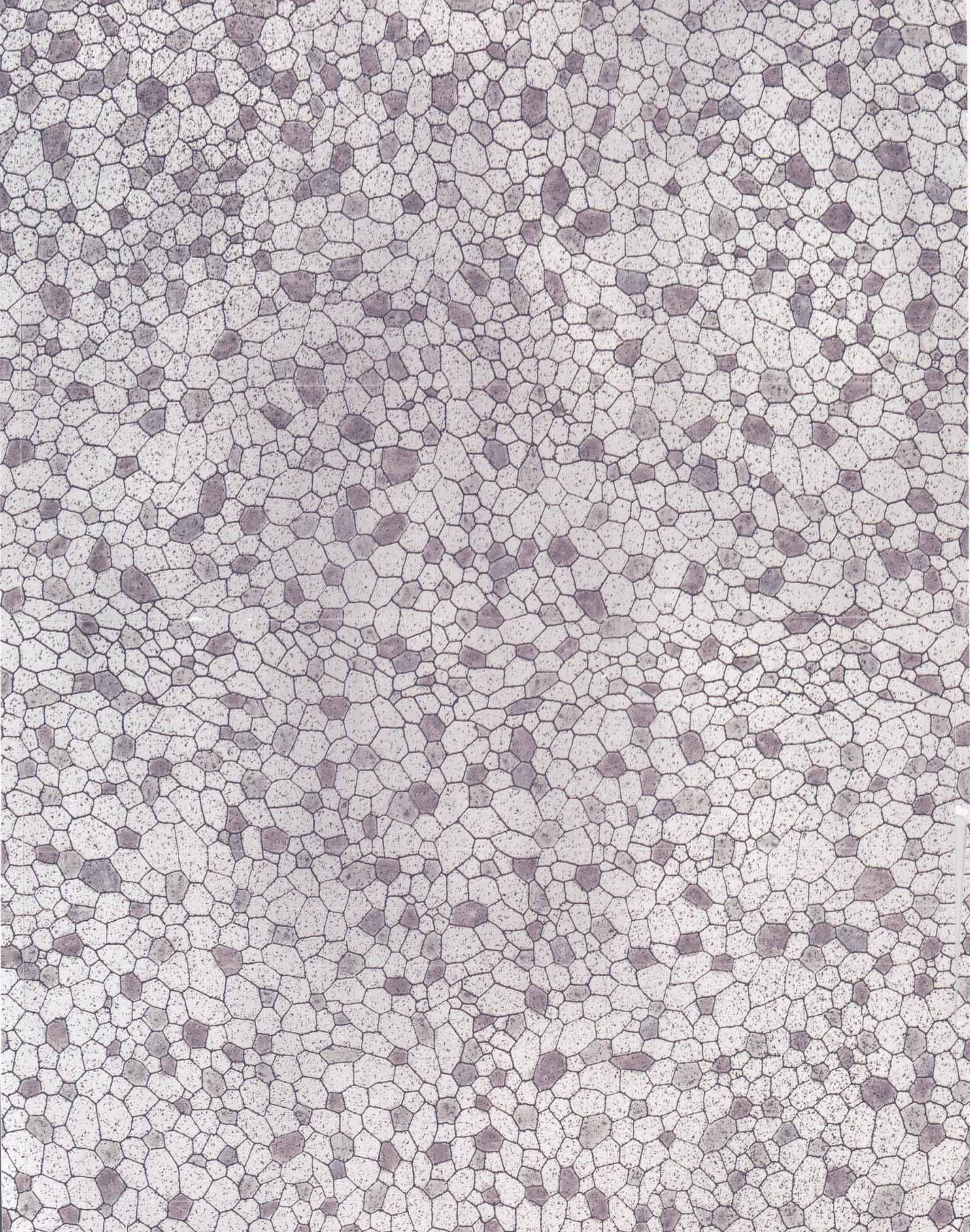

**G2**

**1" x 4"**

**G1**

**1" x 4"**

**F1**

**1" x 3"**

**H1**

**1" x 5"**

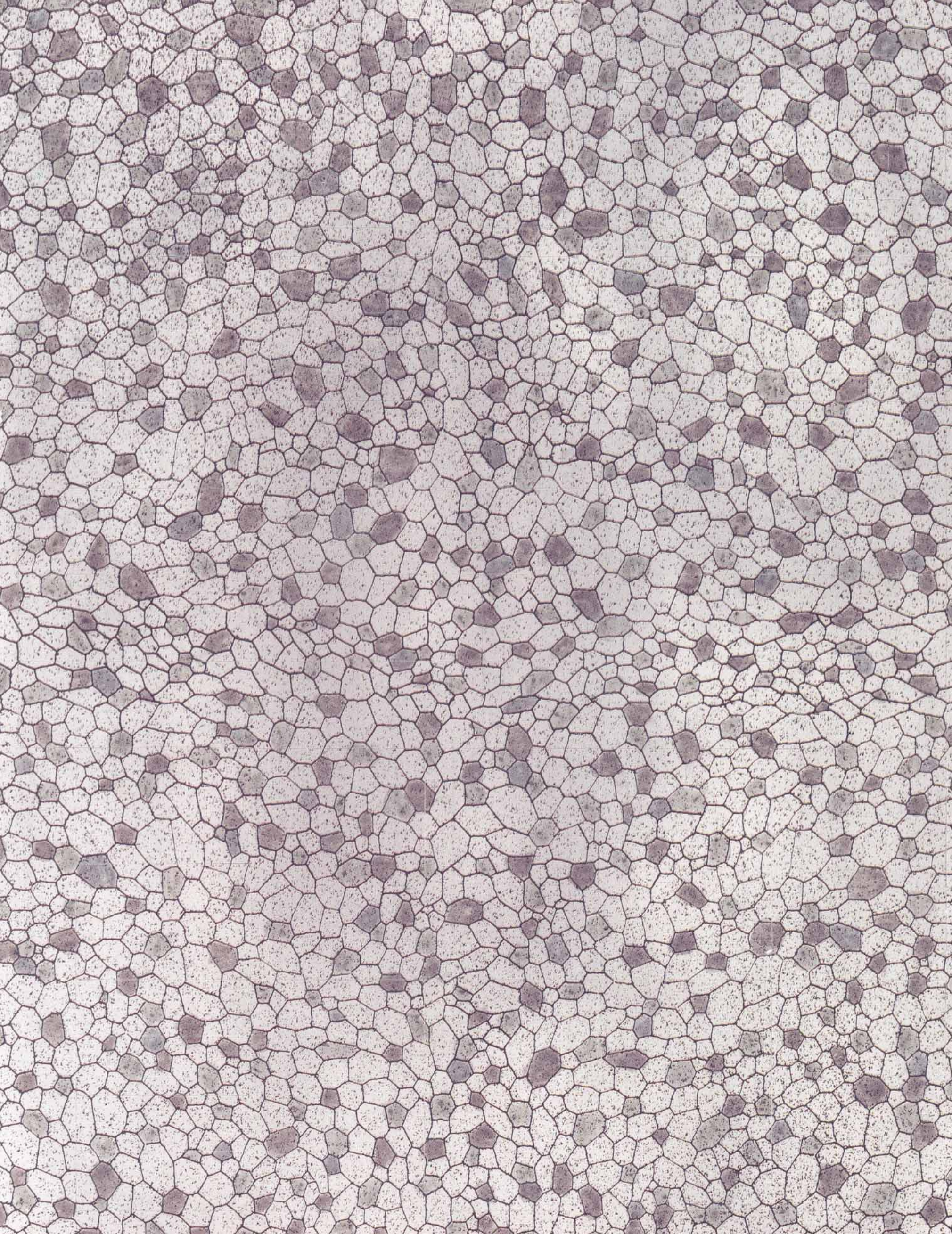

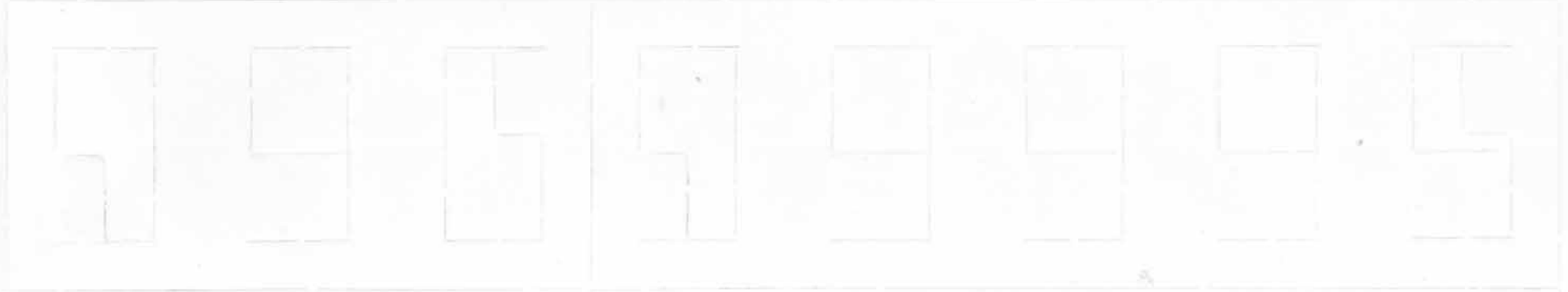
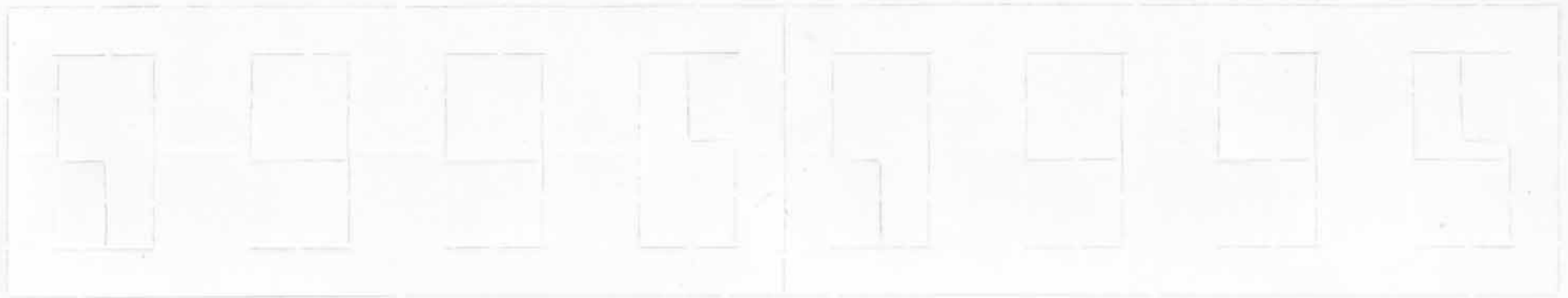

F1

H1

F1

H1

G2

G1

G2

G1

F1

F1

H1

H1

G1

G1

G2

G2

G1

G1

G2

G2

F1

F1

H1

H1

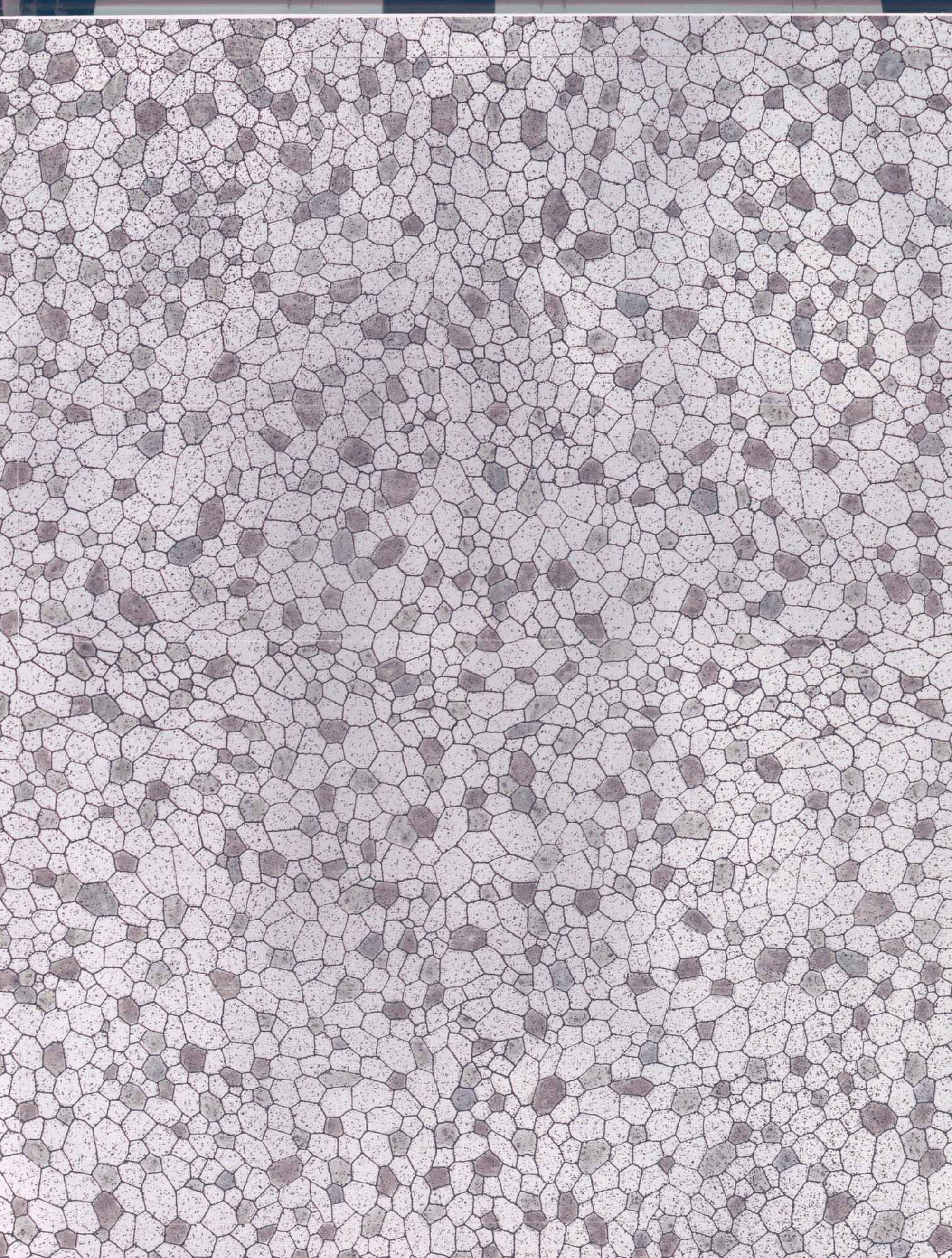



**G4**

**1" x 4"**

**G3**

**1" x 4"**

**F2**

**1" x 3"**

**H2**

**1" x 5"**

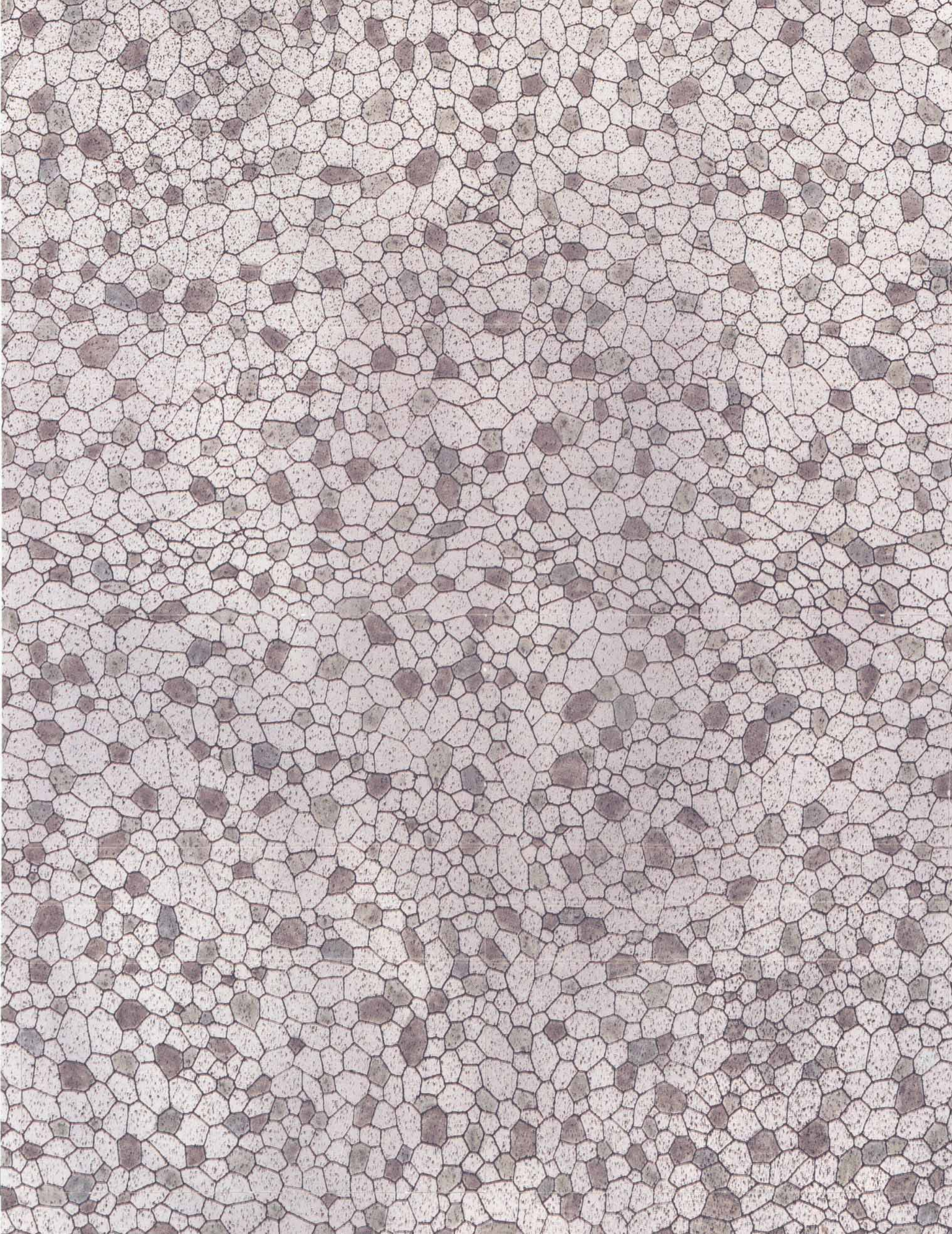

G6

1" x 4"

G5

1" x 4"

F3

1" x 3"

H3

1" x 5"

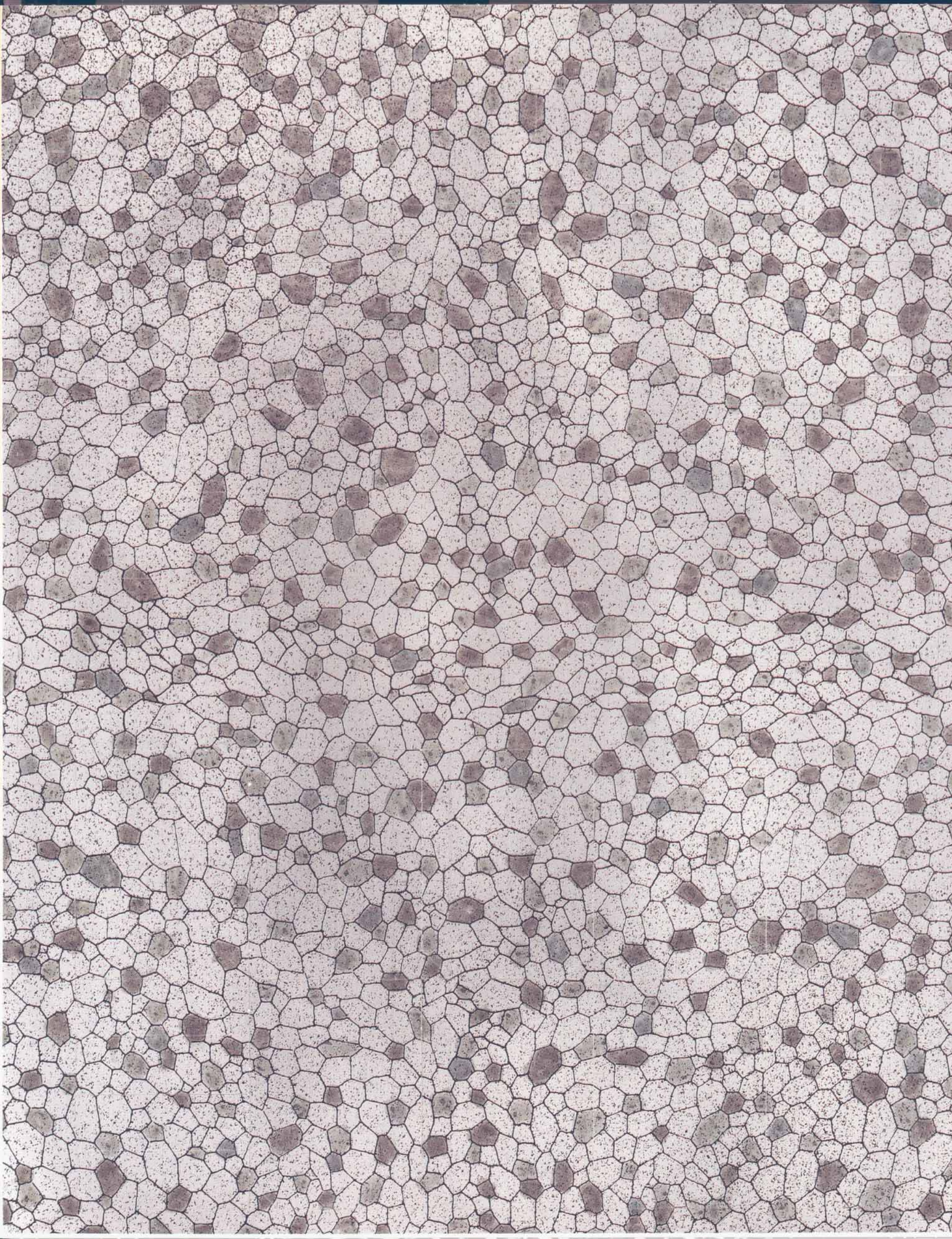

H3	H3	G6	G6	G5	G5
F3	F3				
G6	G6	H3	H3	F3	F3
G5	G5				

G5				G6			
G5				G6			
H3				F3			
H3				F3			

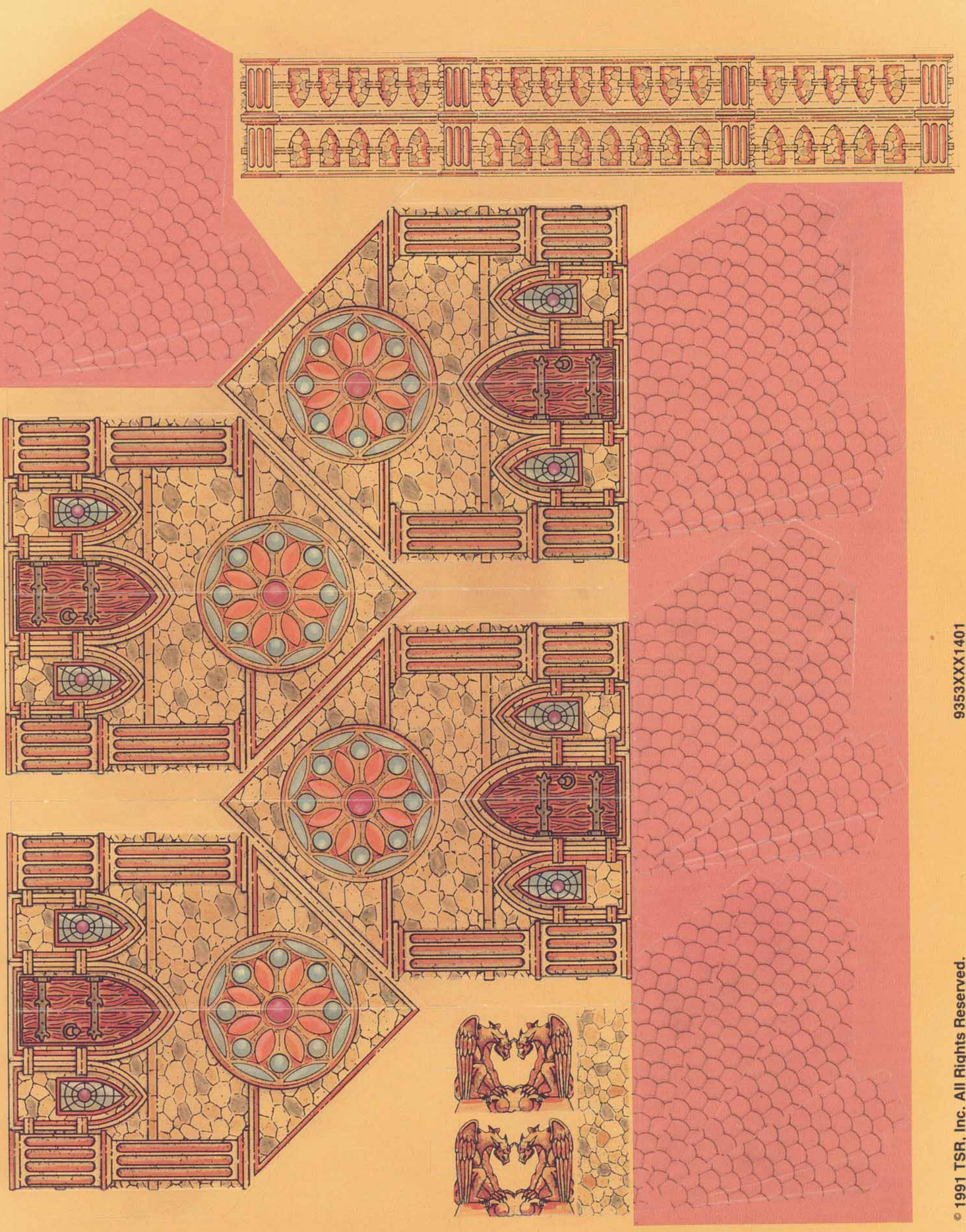

9353XXX1401

© 1991 TSR, Inc. All Rights Reserved.



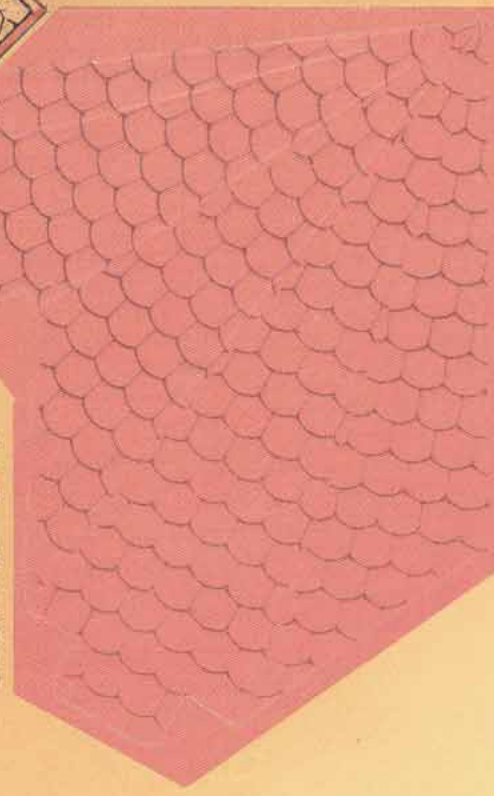
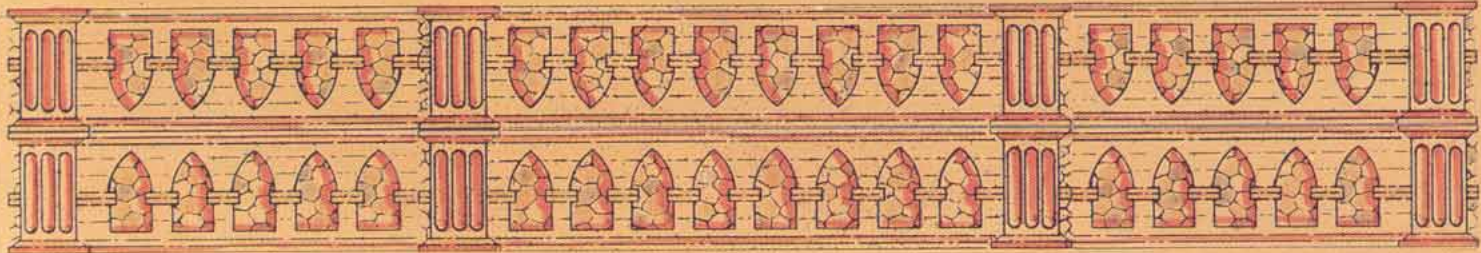
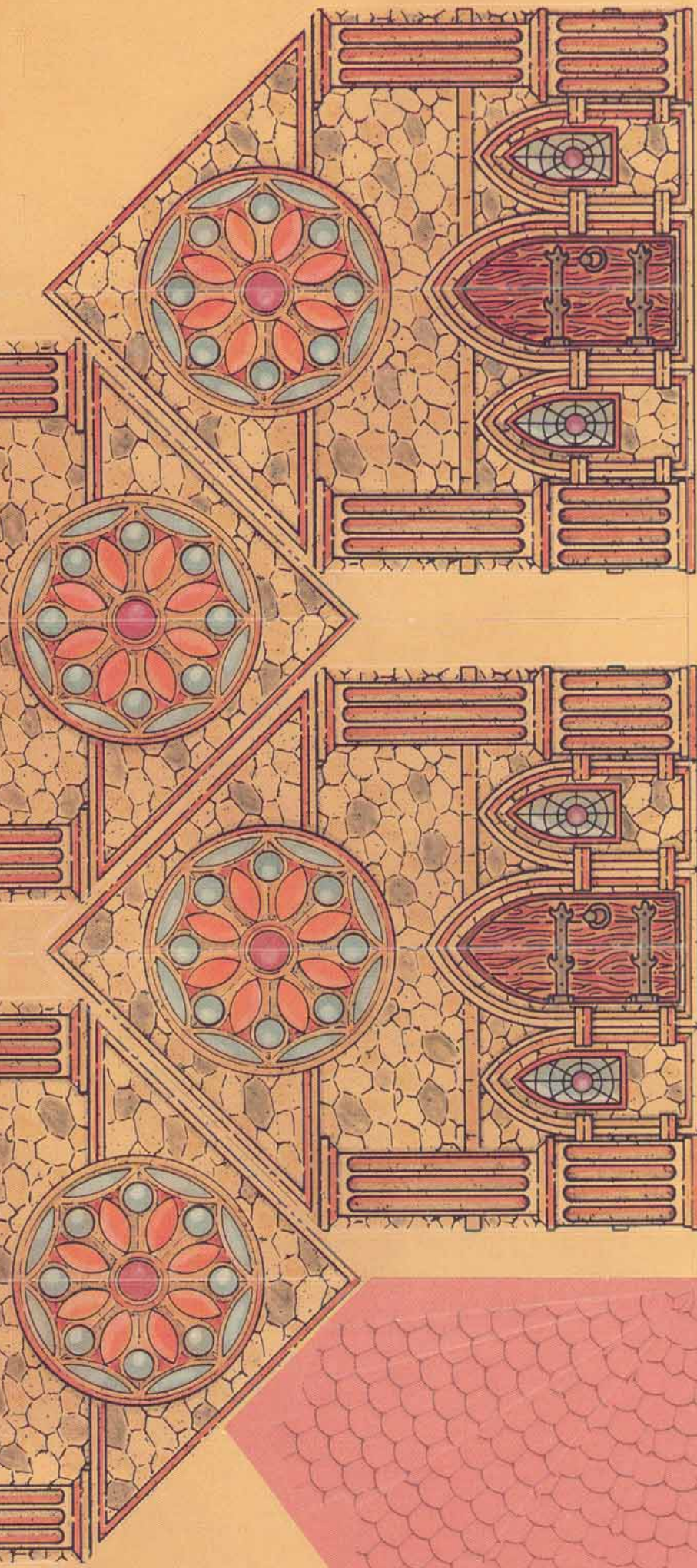
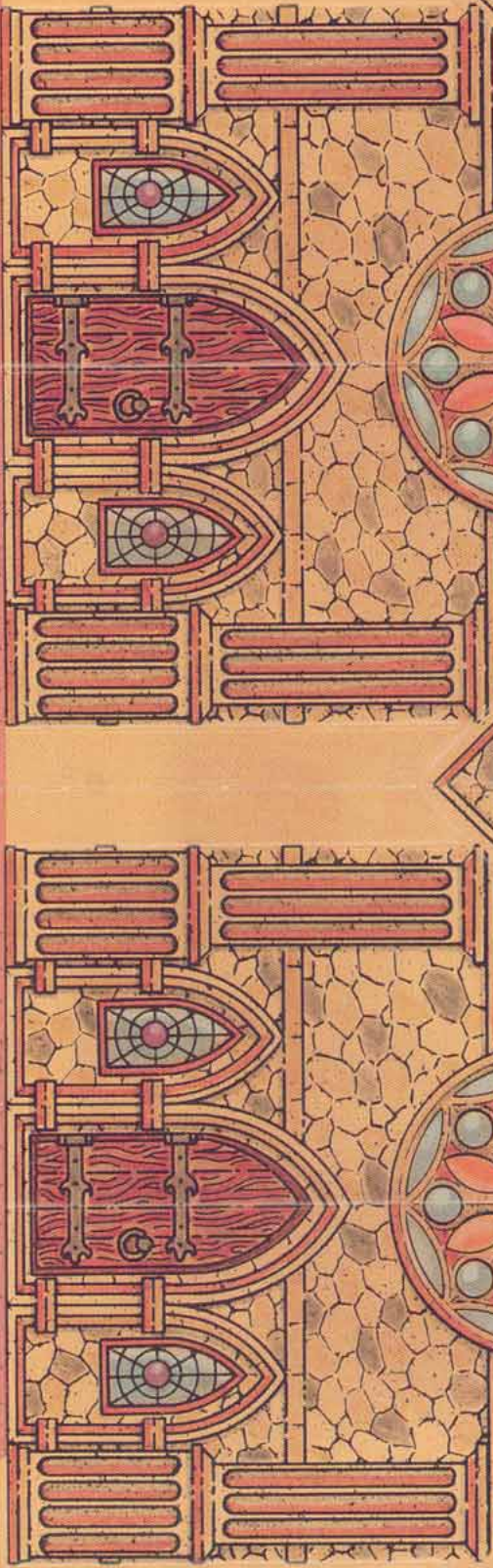
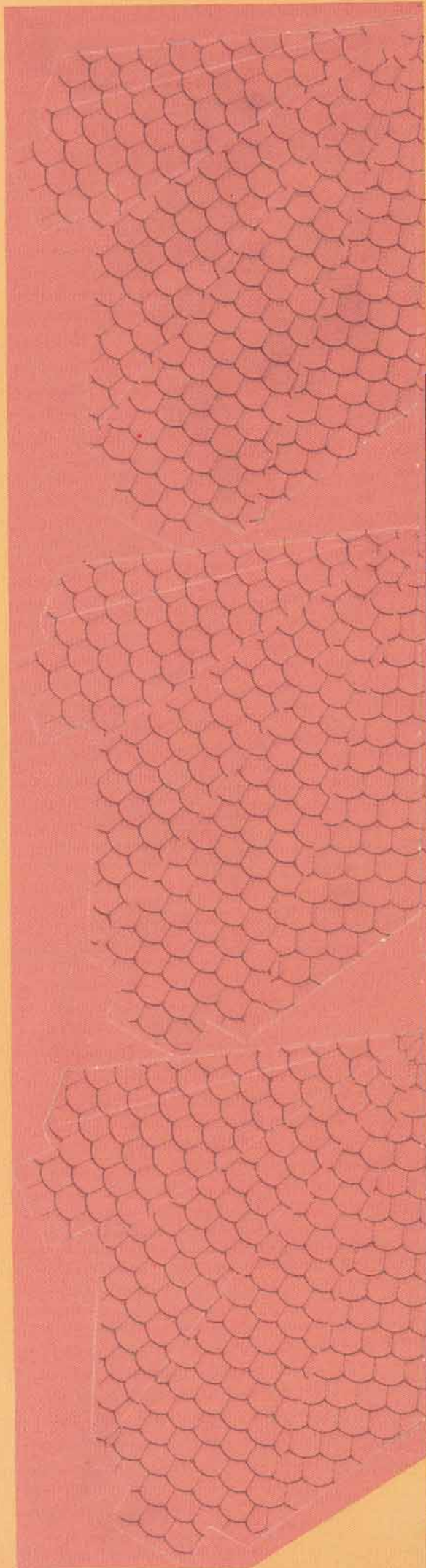



23

22a



22a

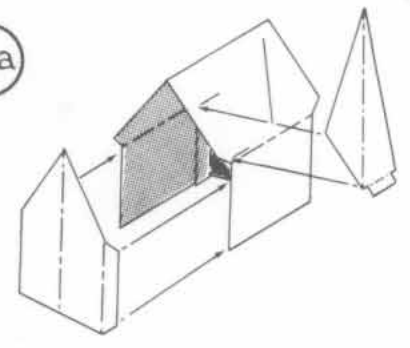

22b

22c

22c

22b

22d

22d

25

25

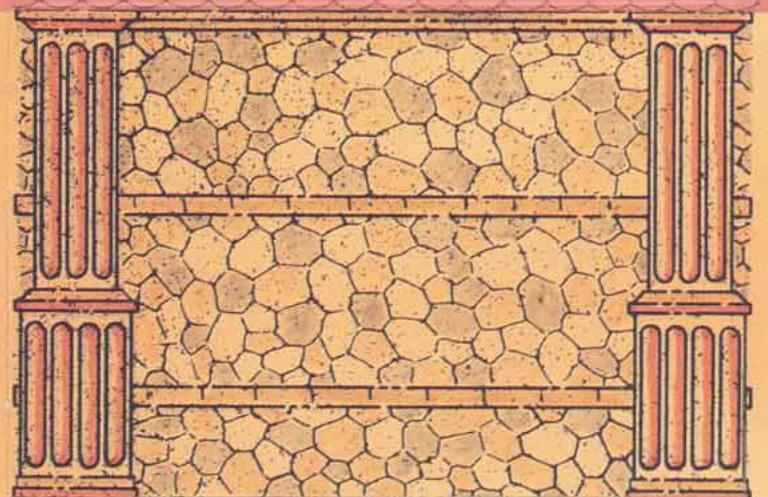
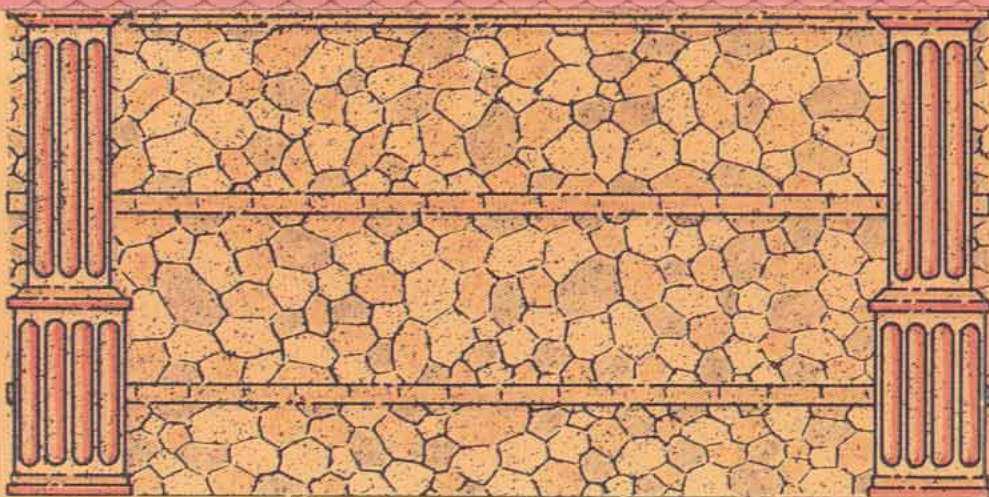
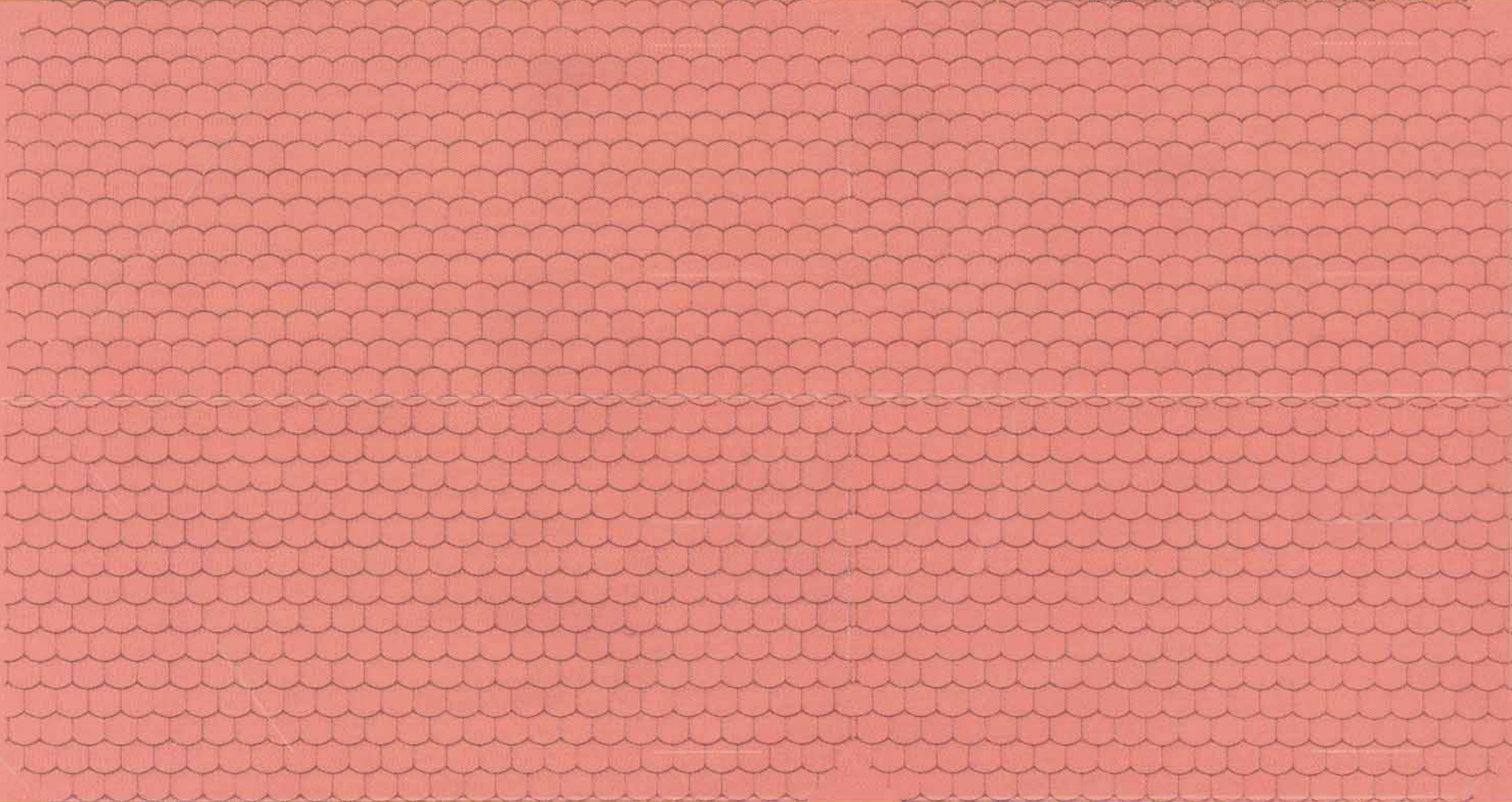
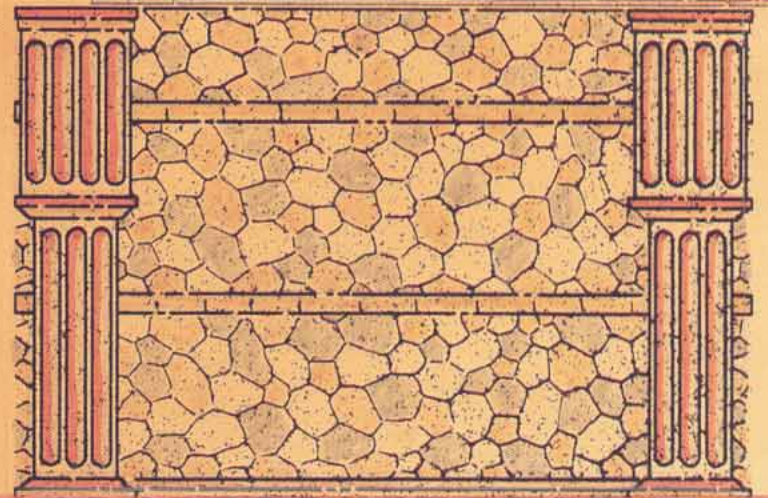
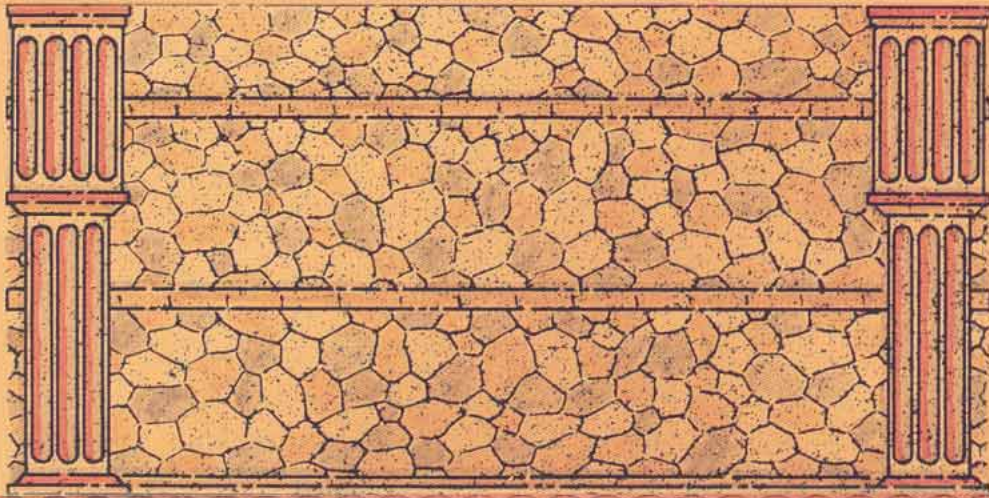
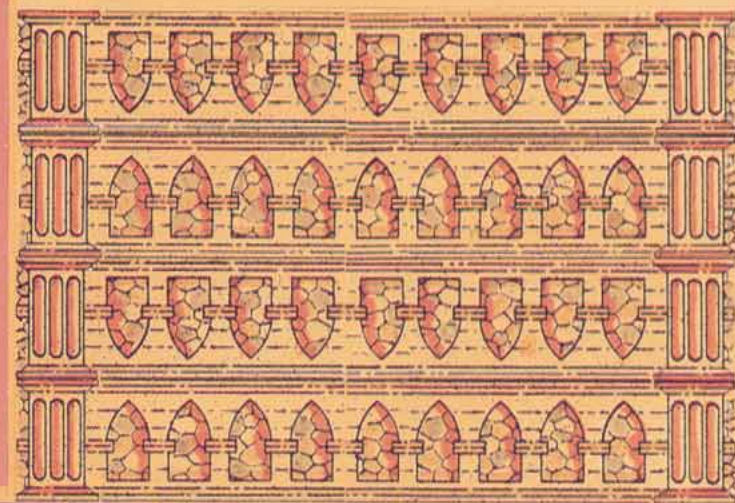
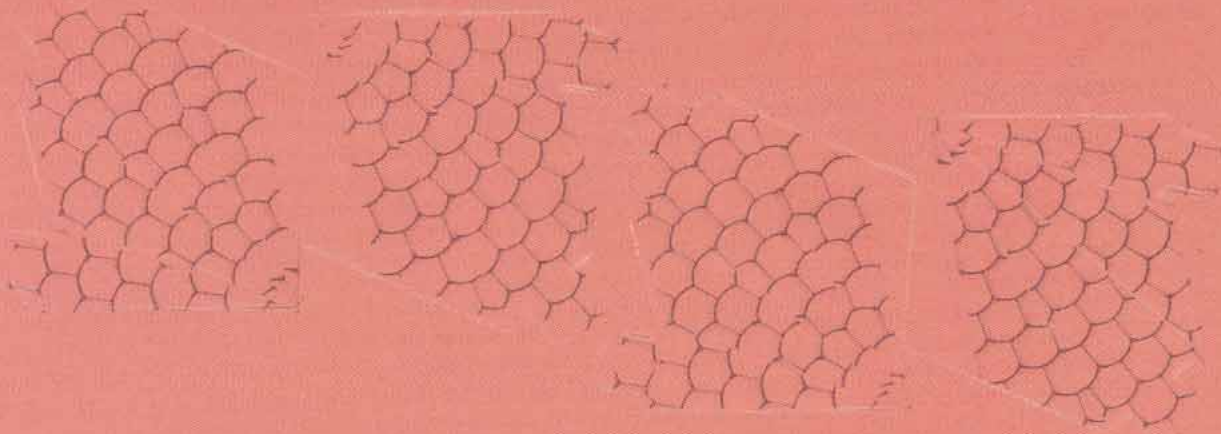

22C / 22D

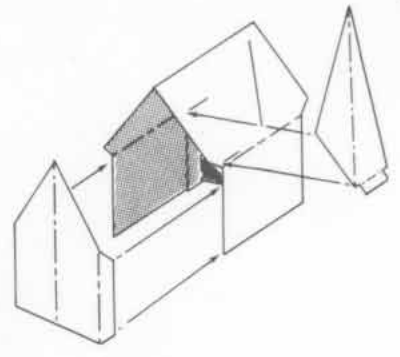

22A / 22B

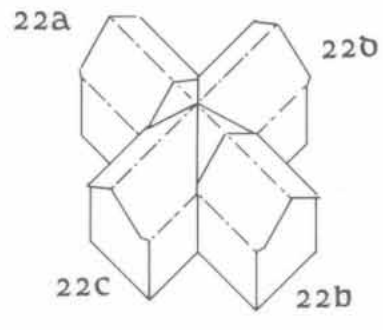

23



23



23

23

17

17

18

18

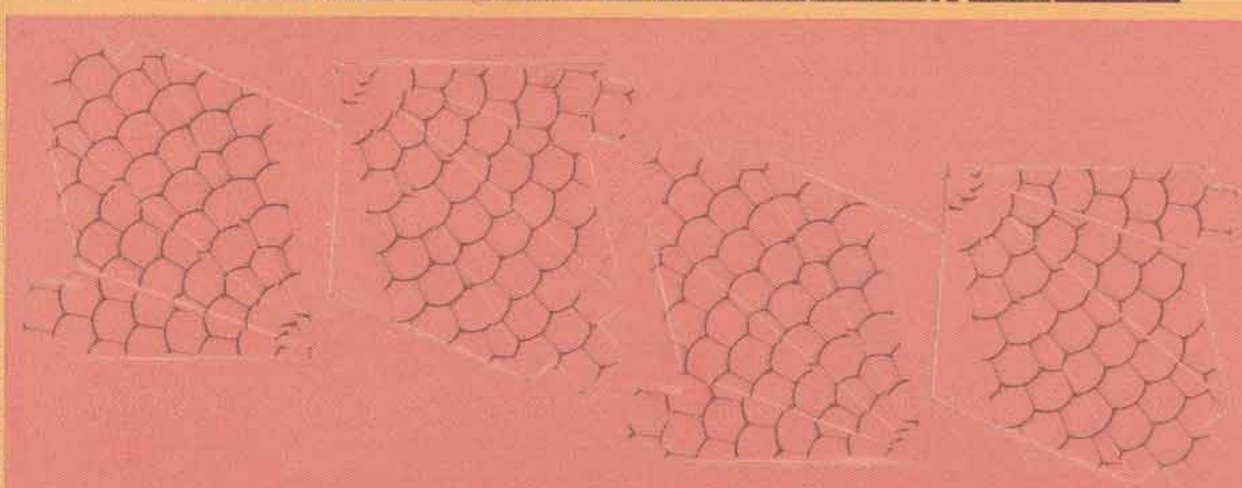
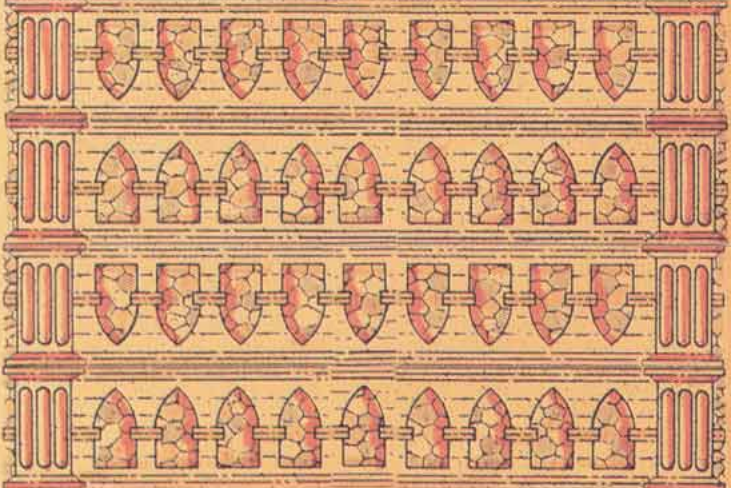
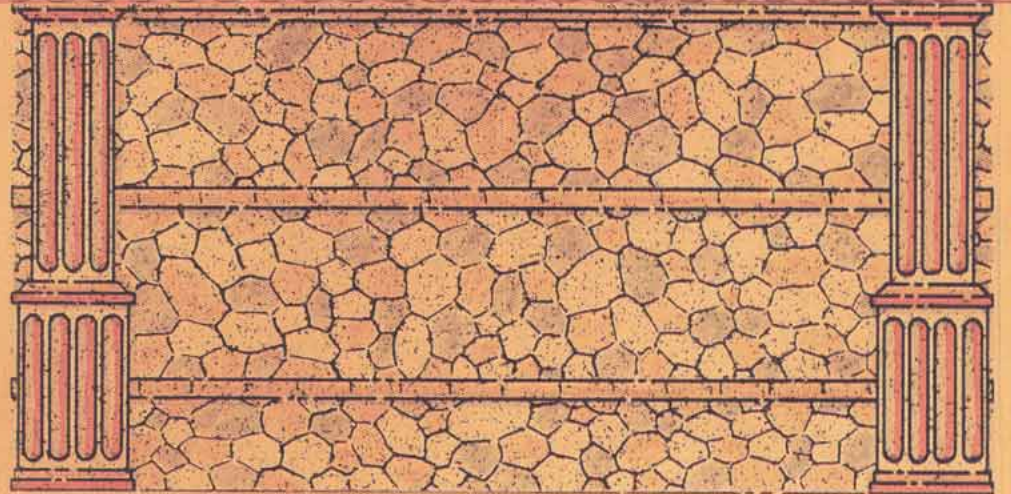
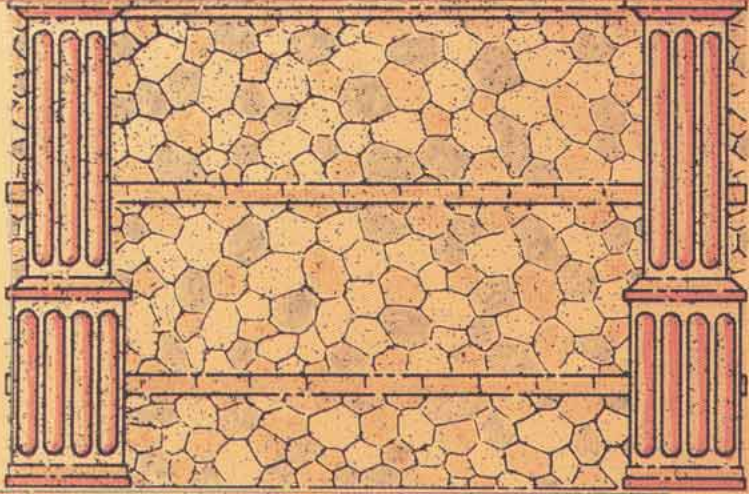
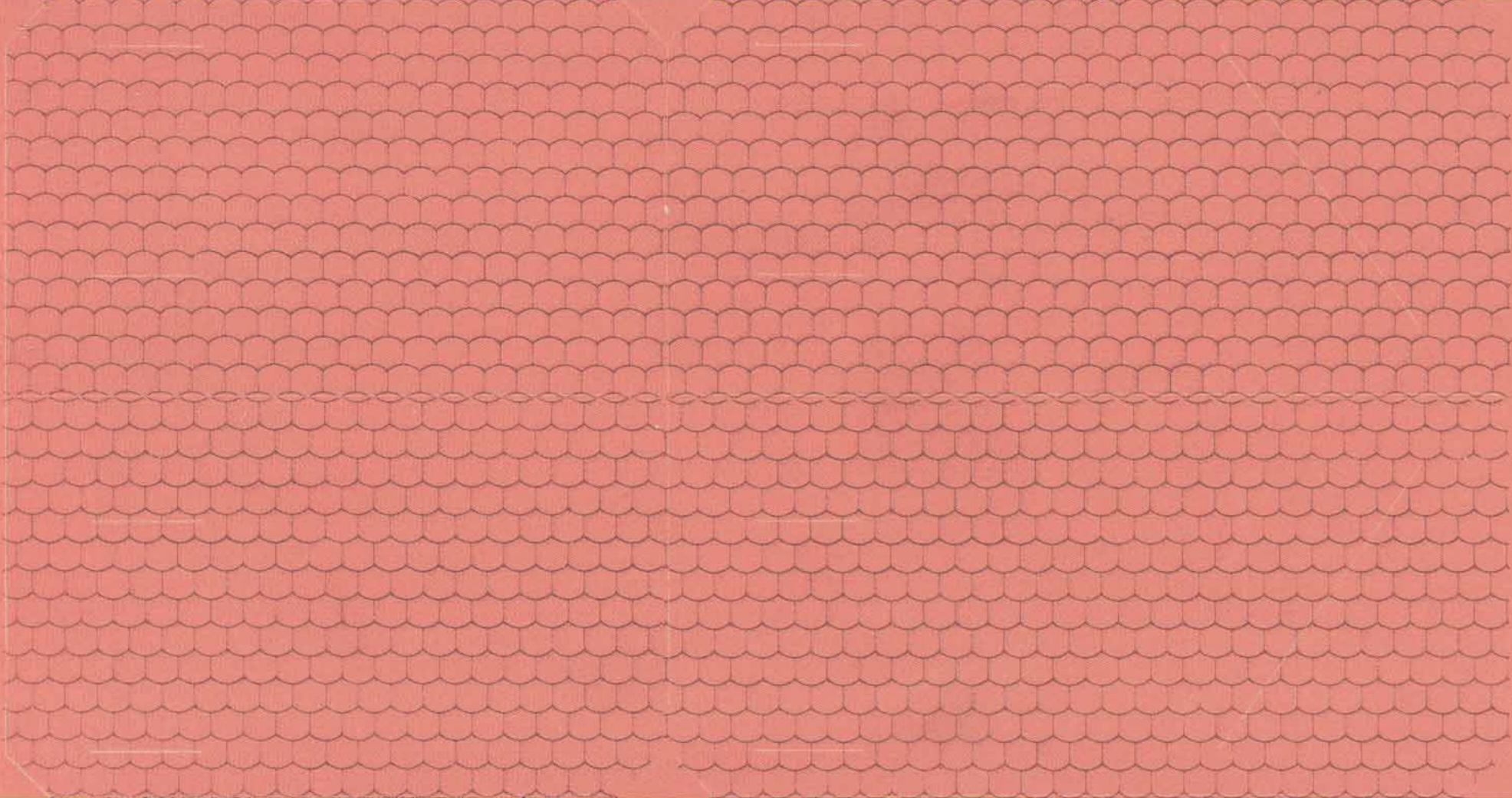
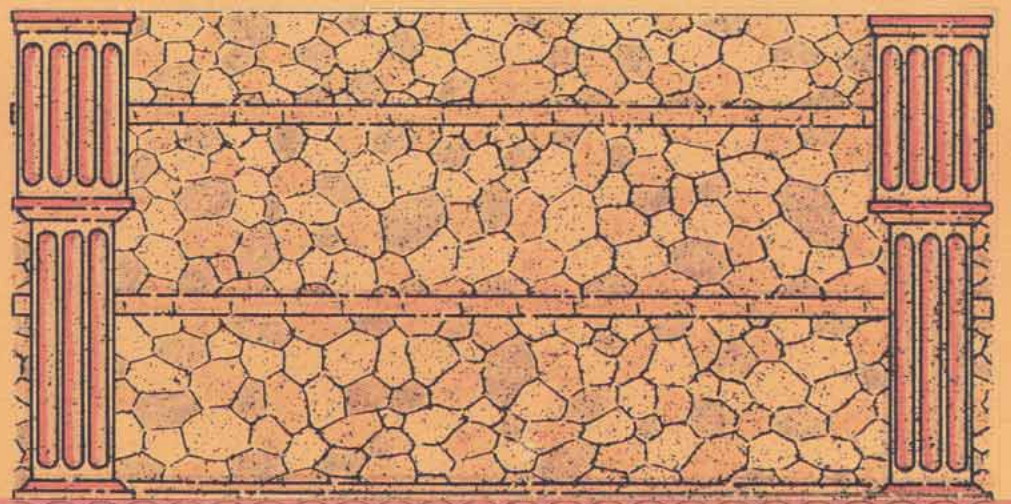
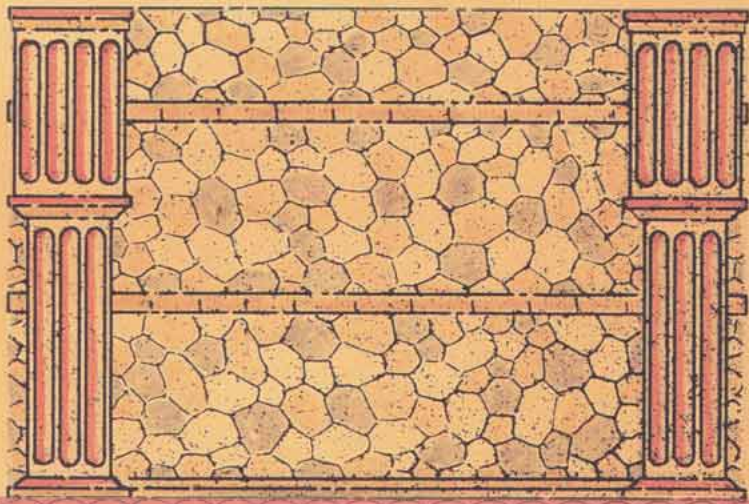

18

18

17

17

23

23

23

23

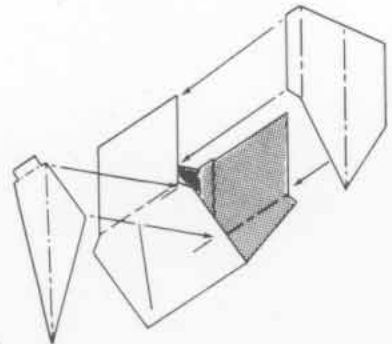
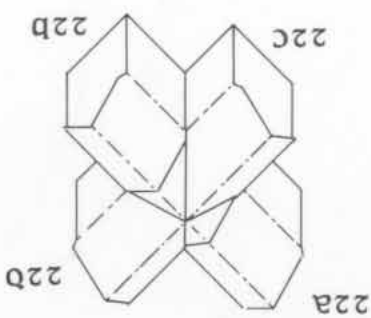

22b

22c

22b

22a

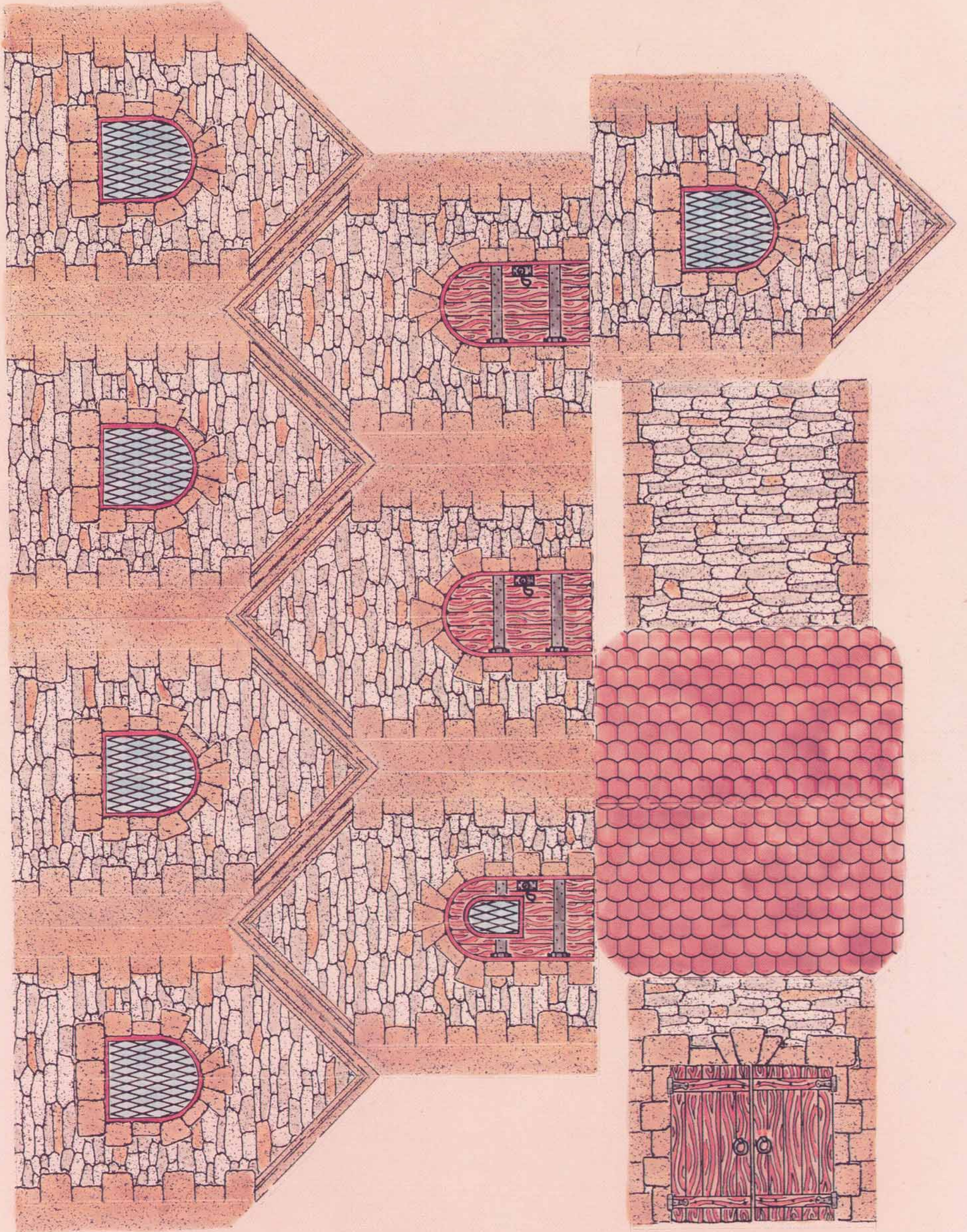

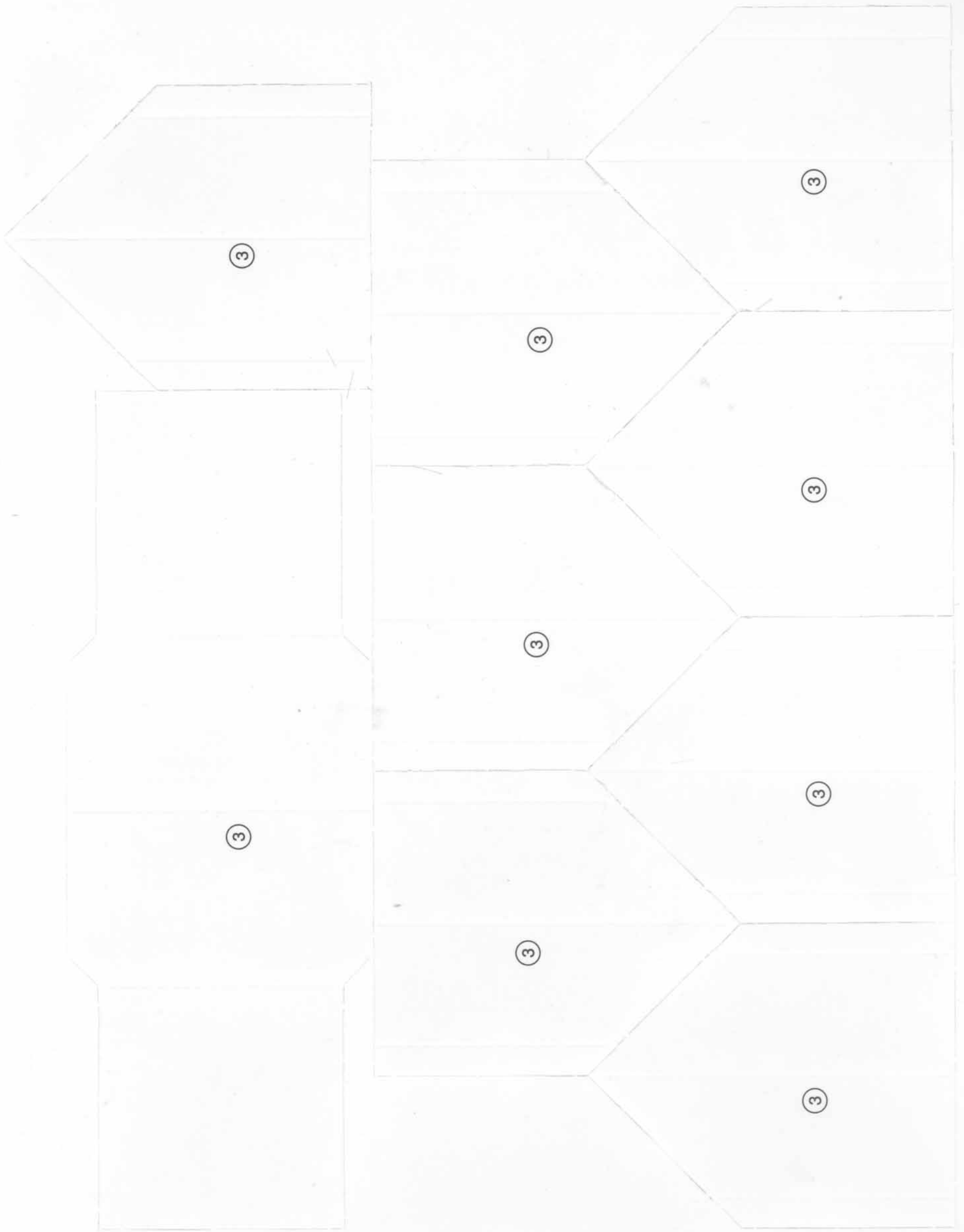

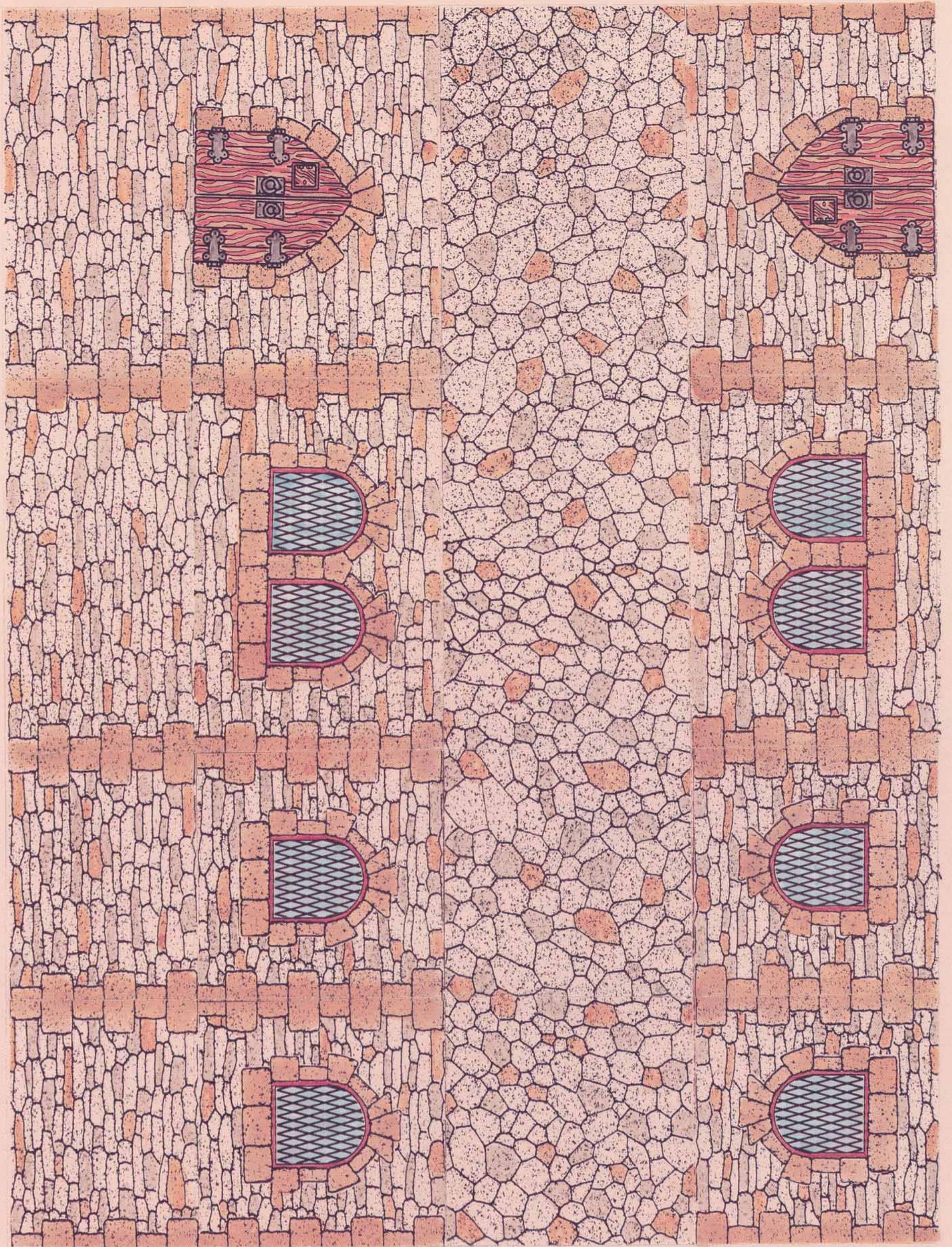





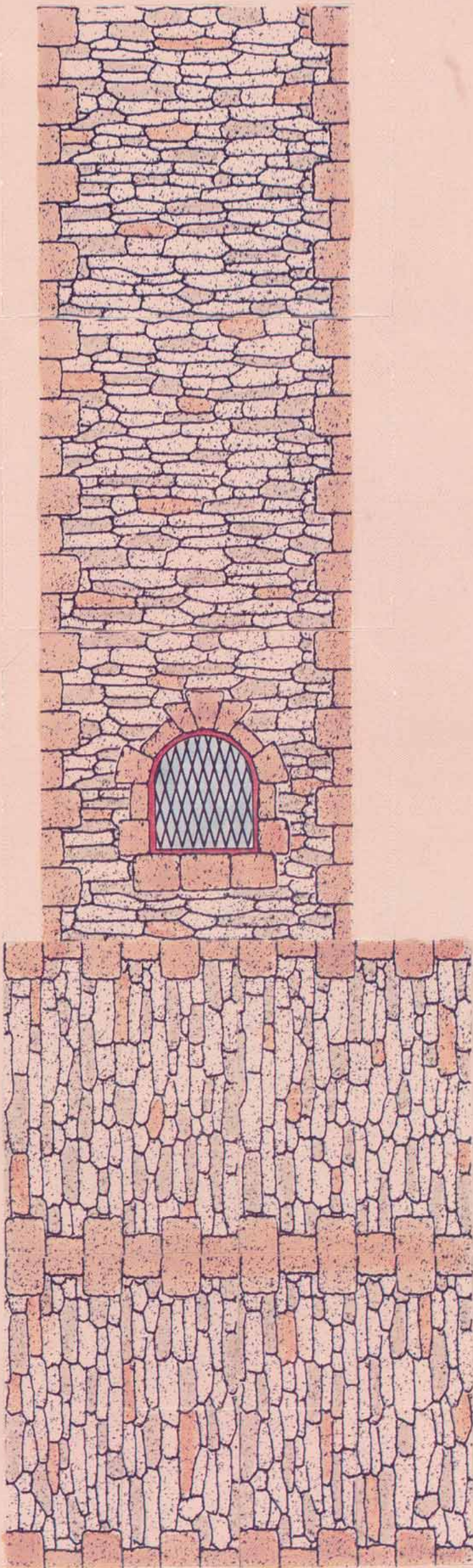
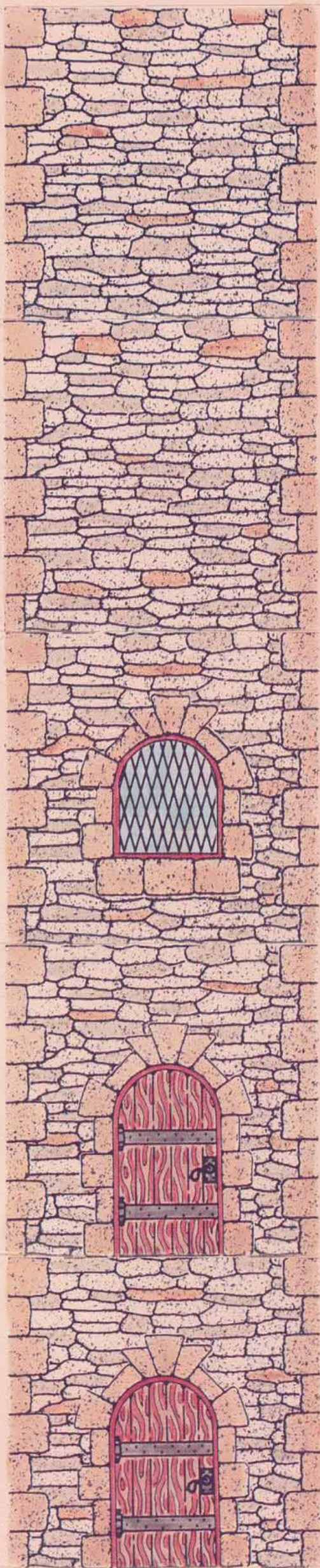



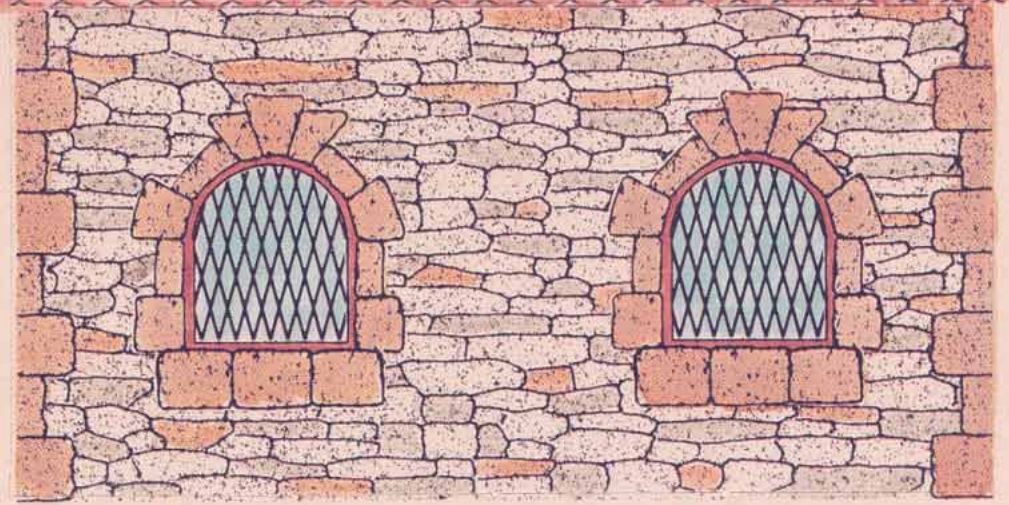
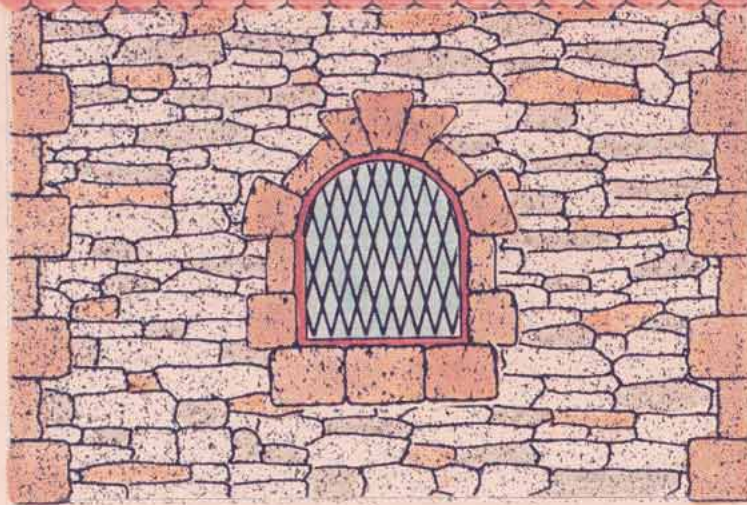
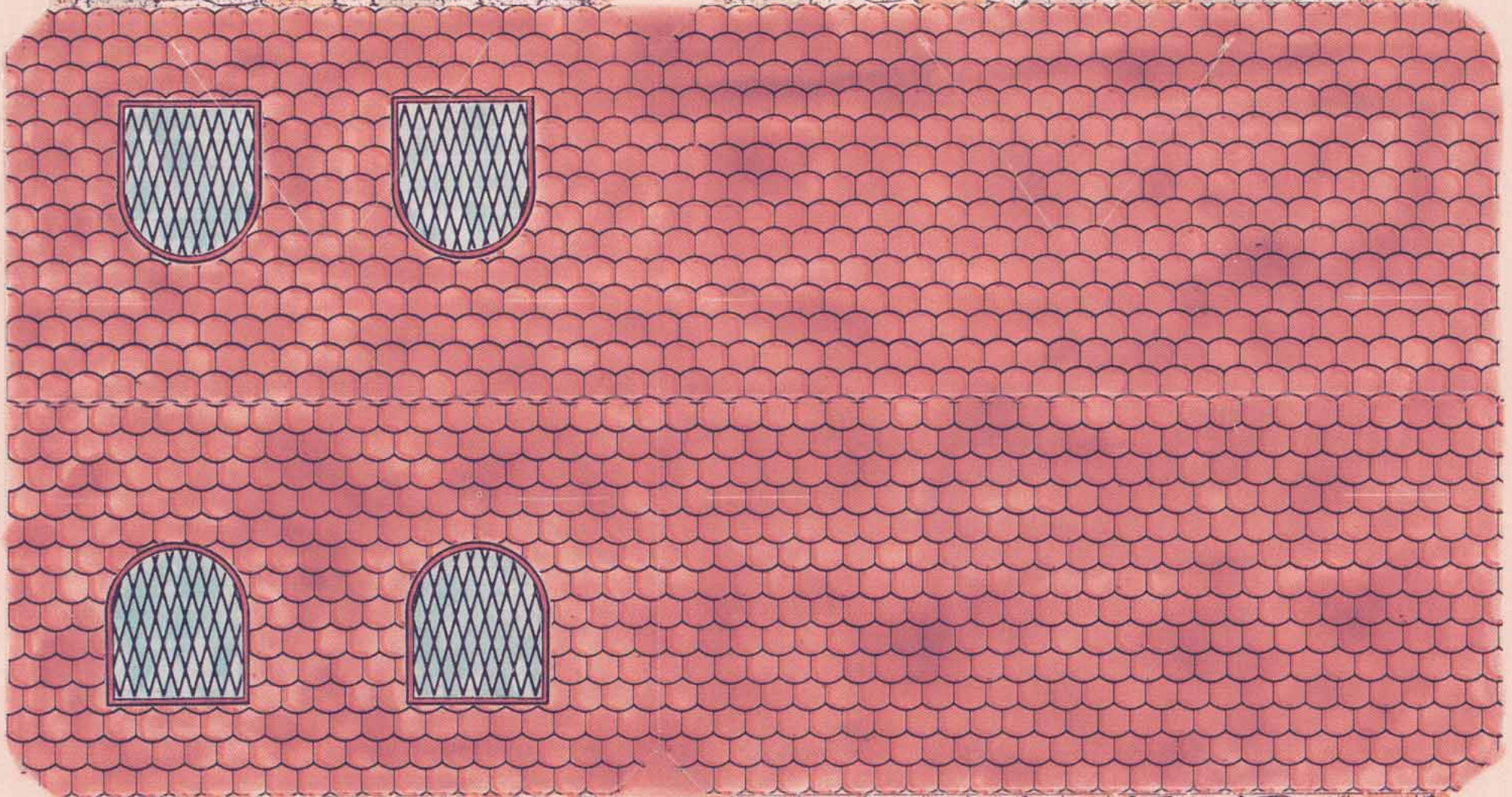
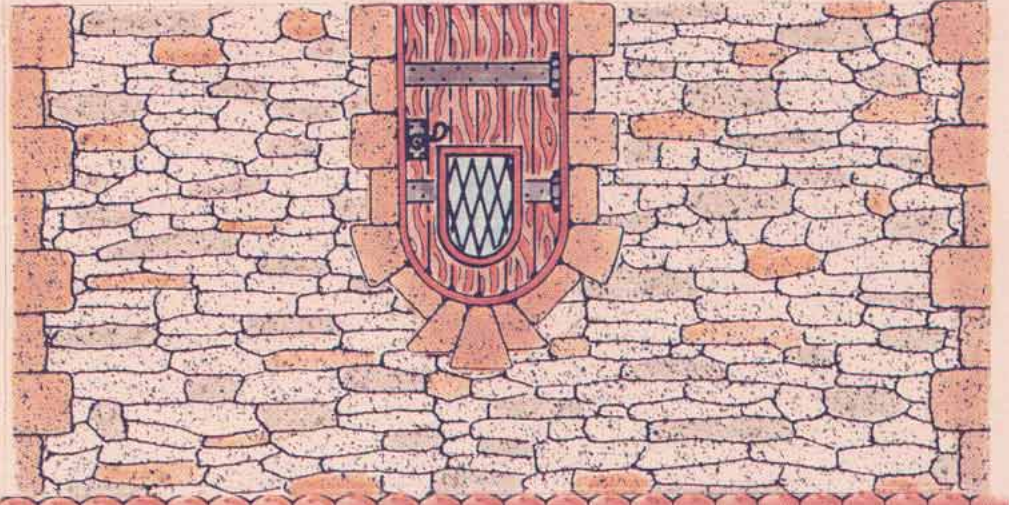
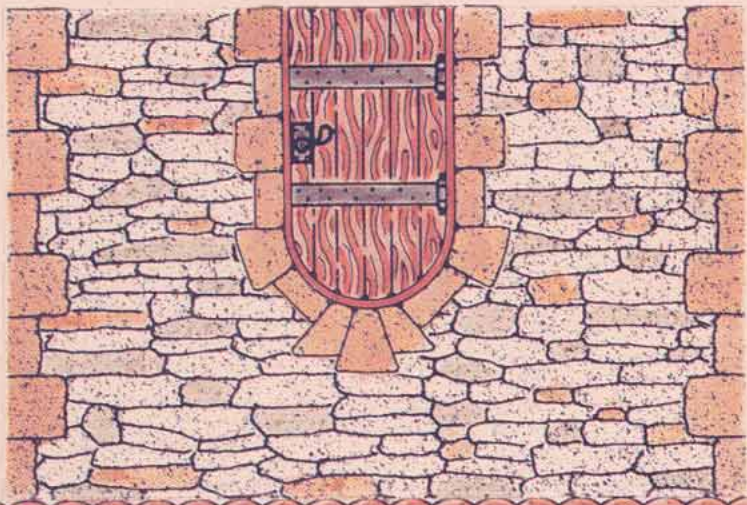

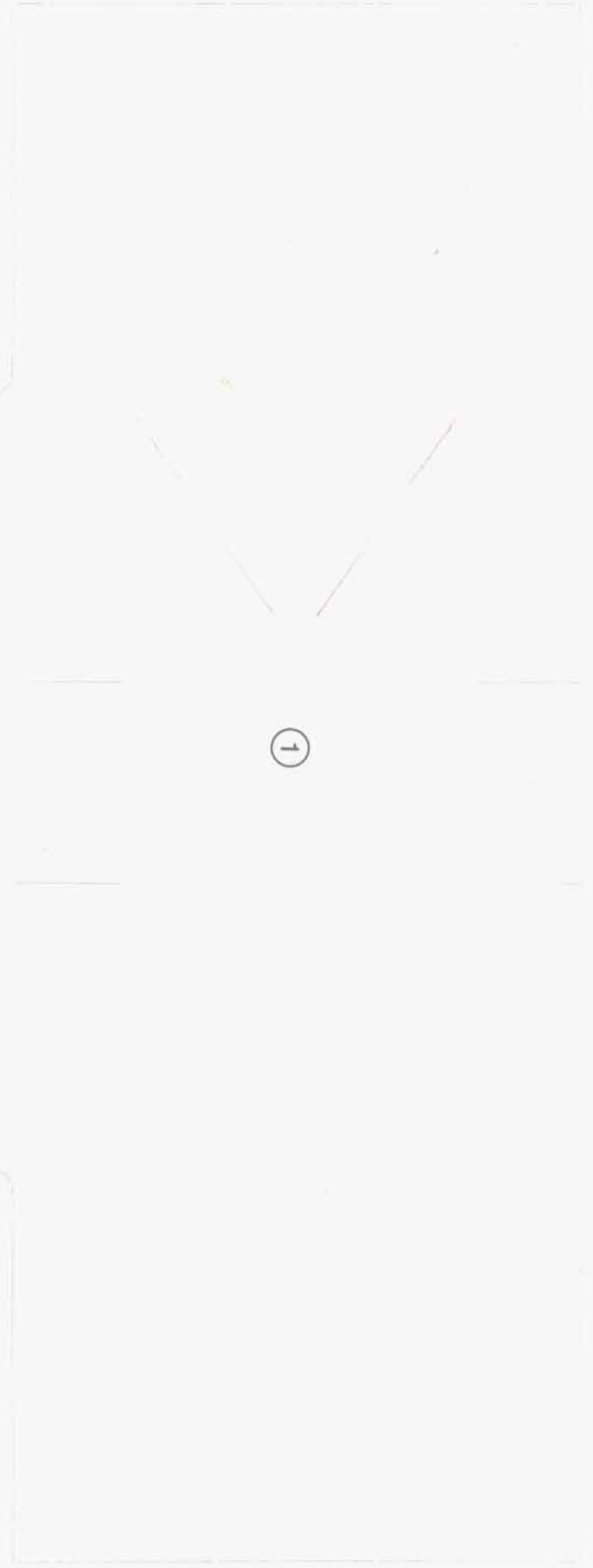

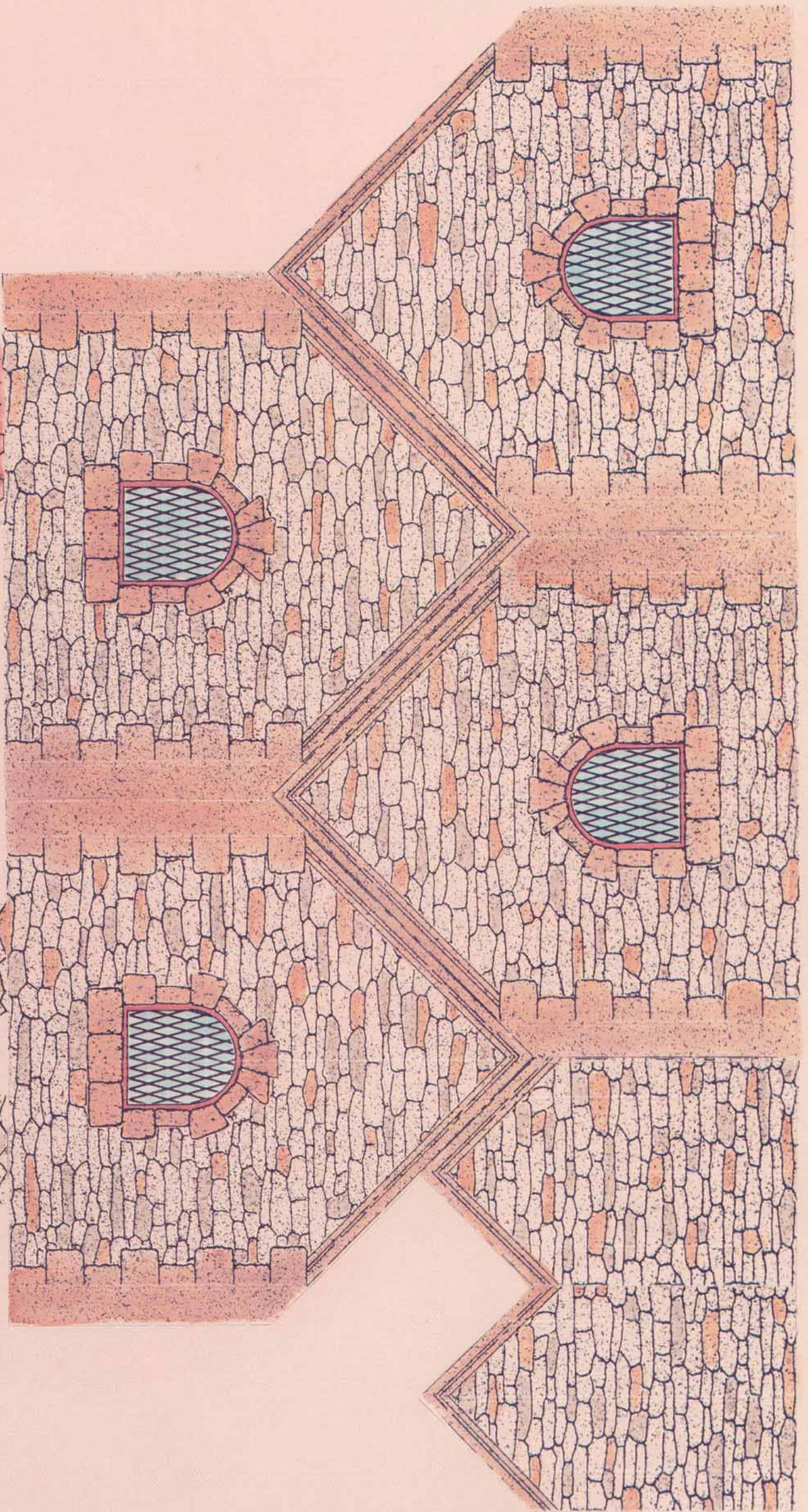
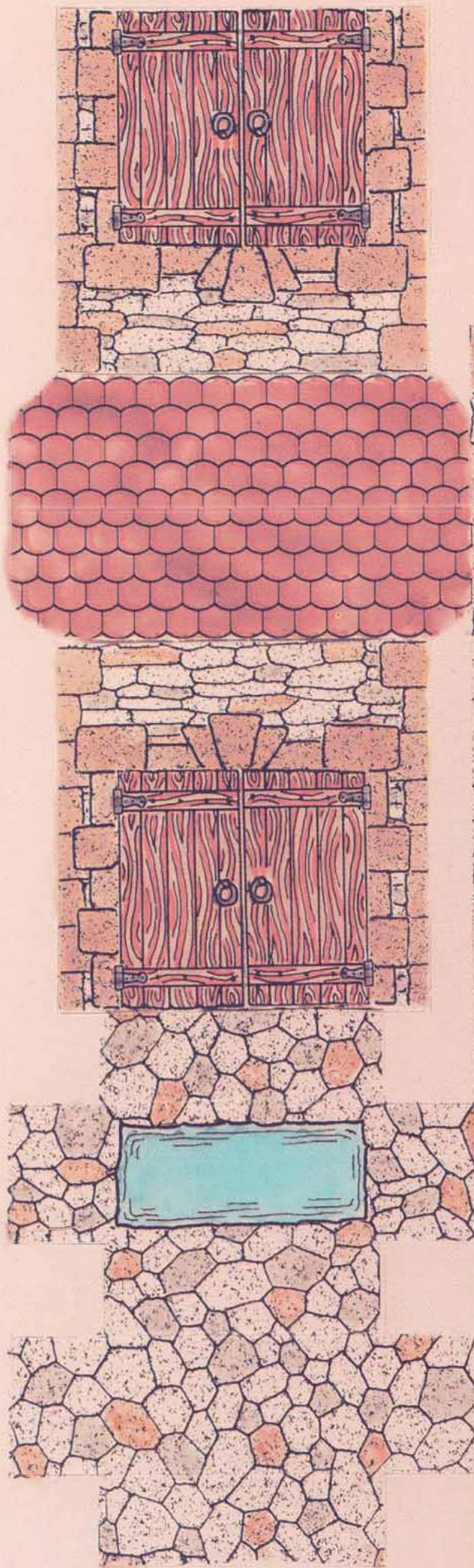



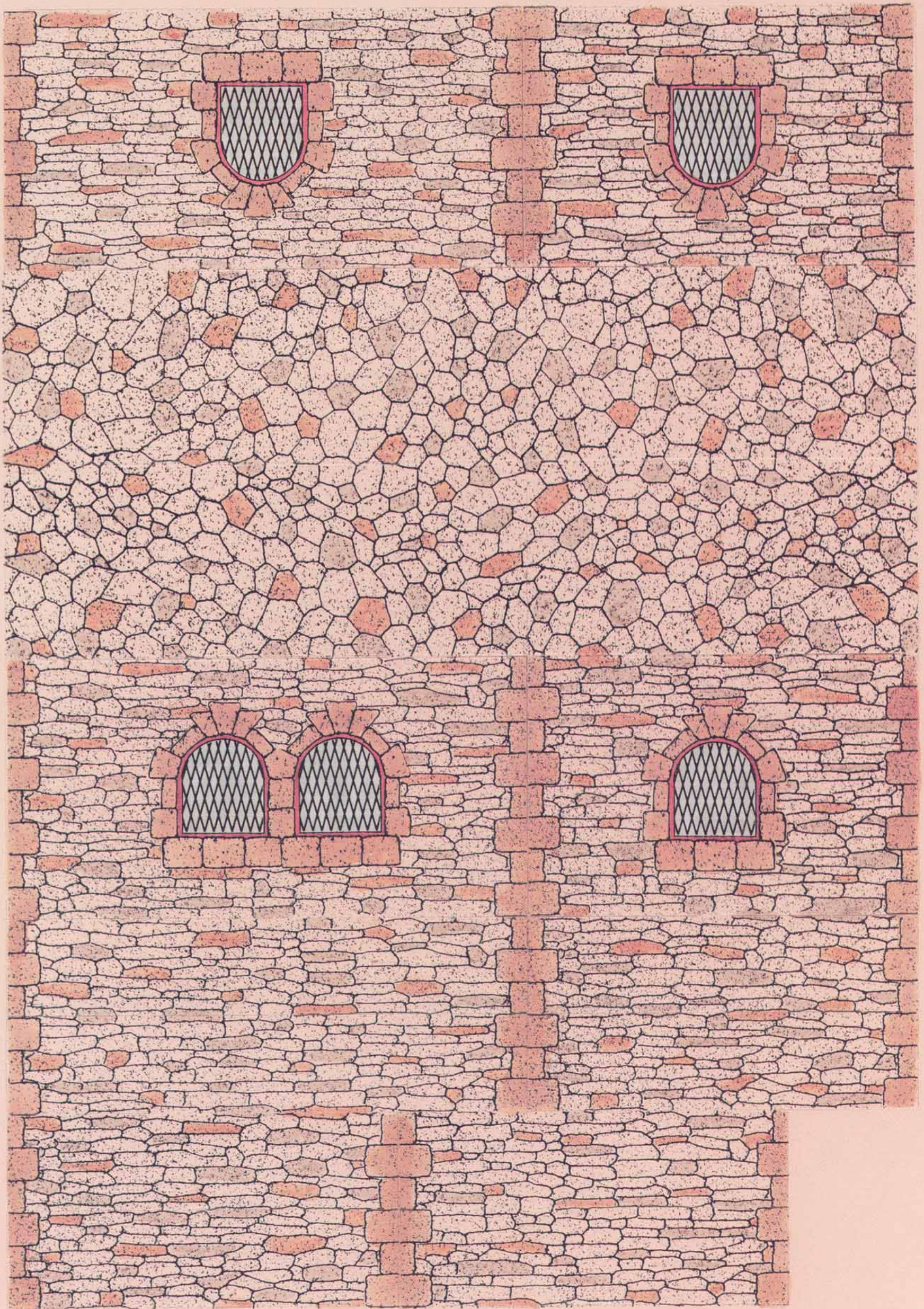





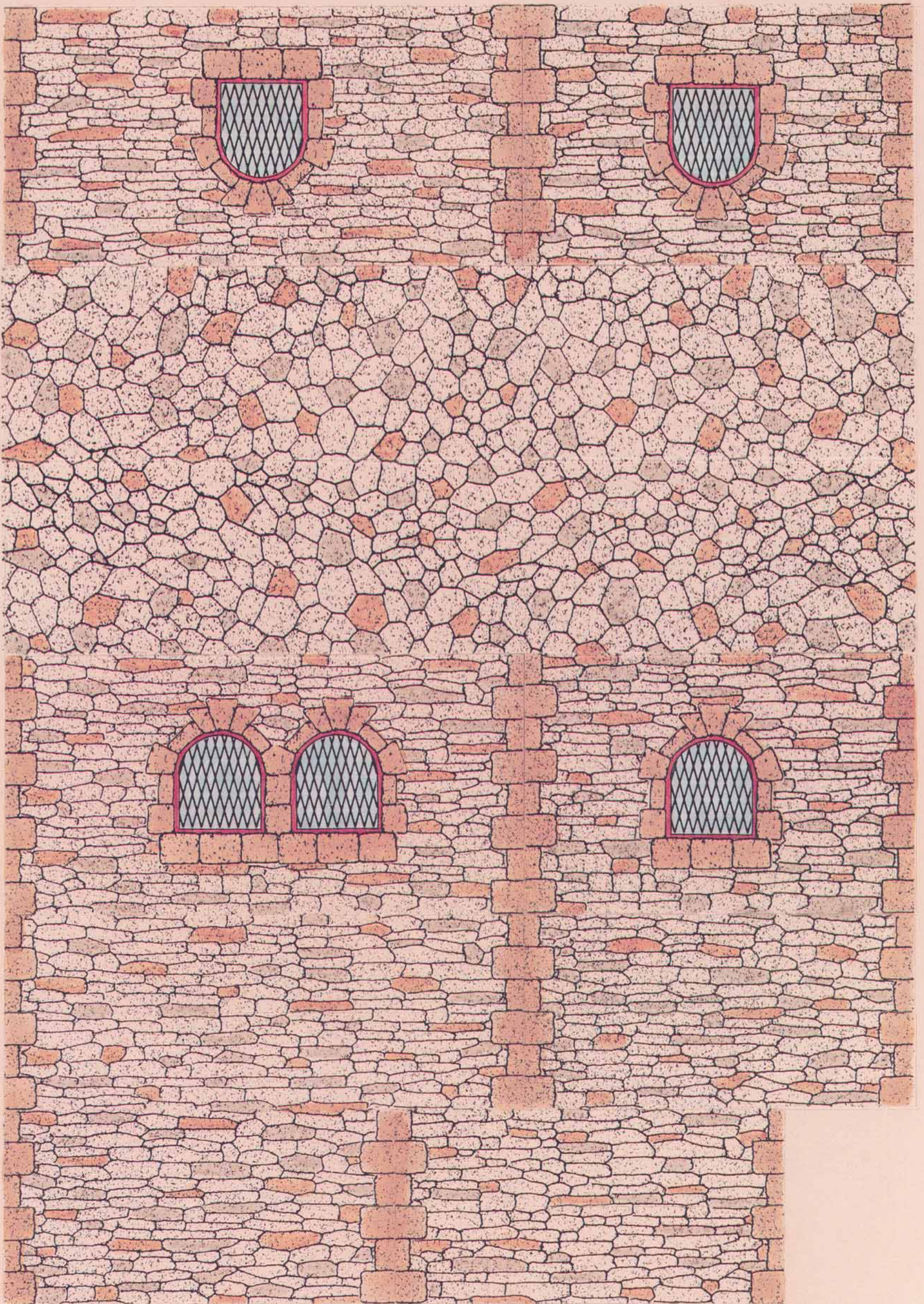



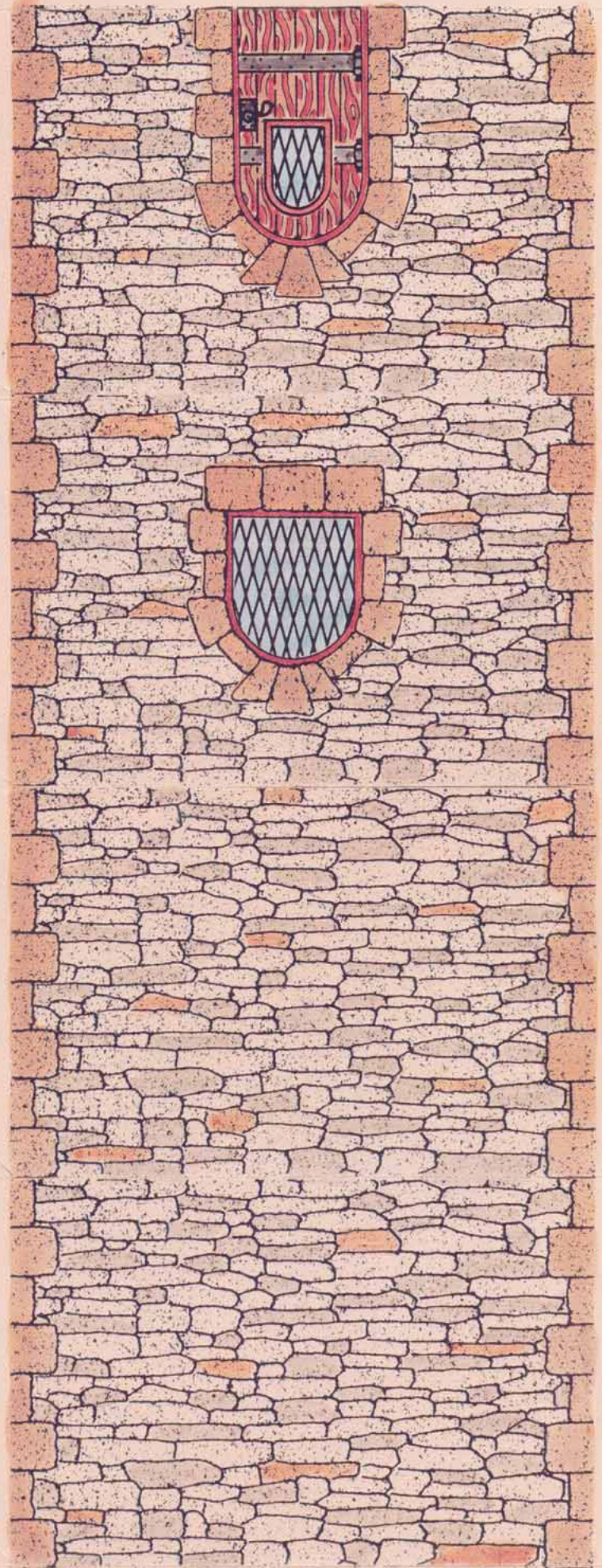
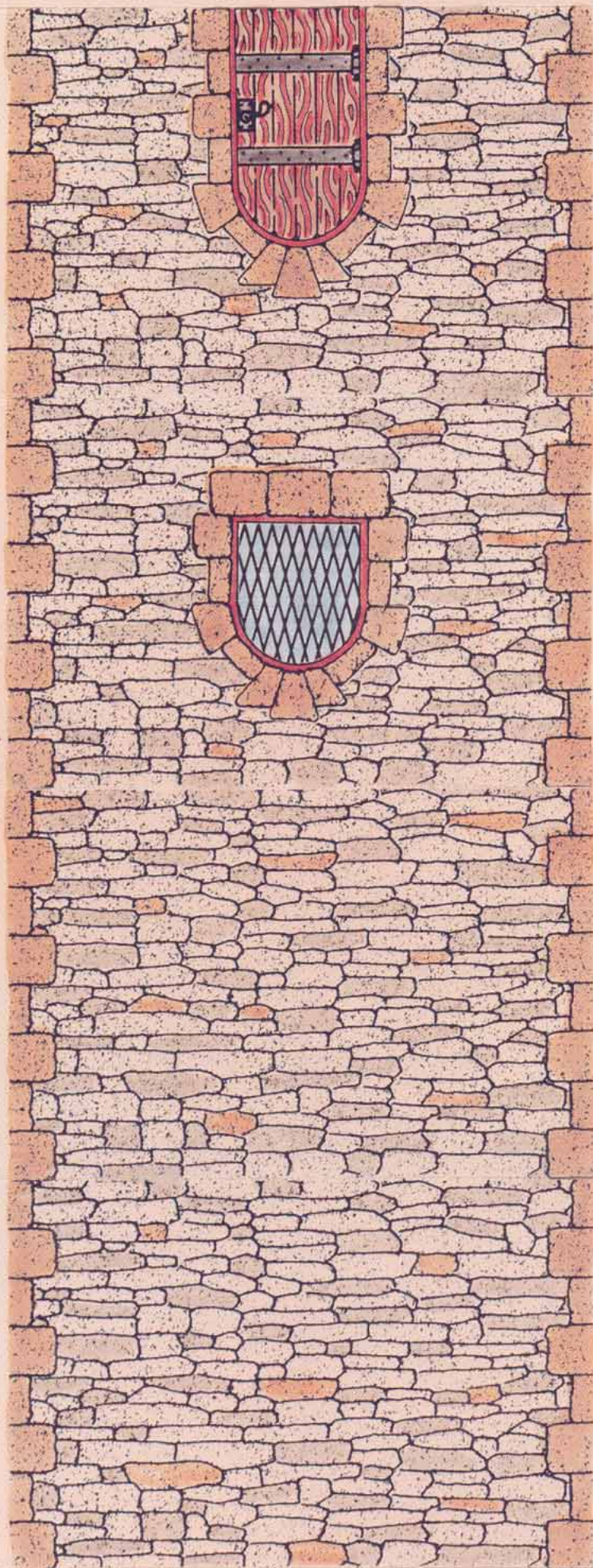
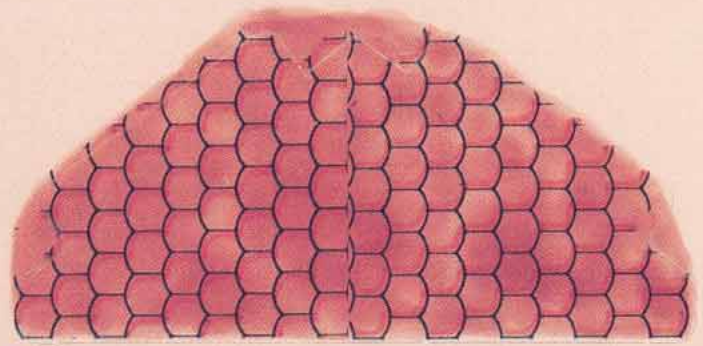
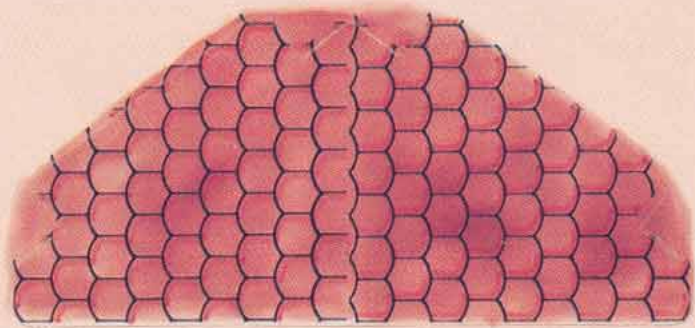

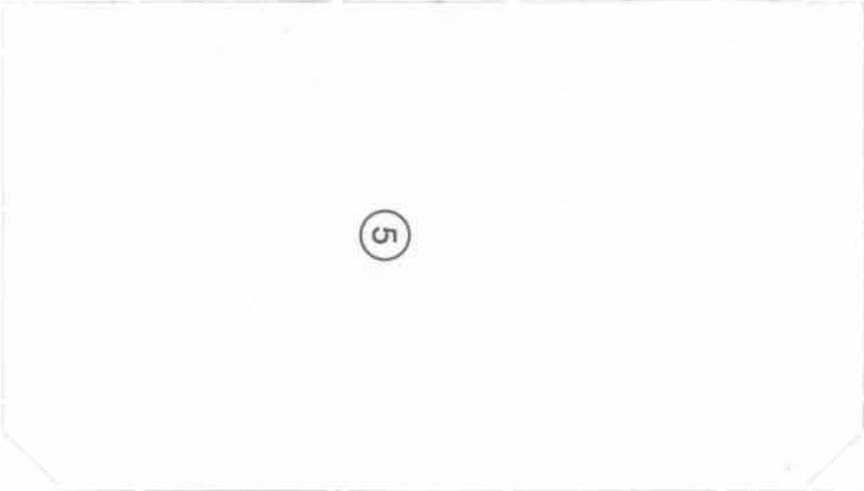
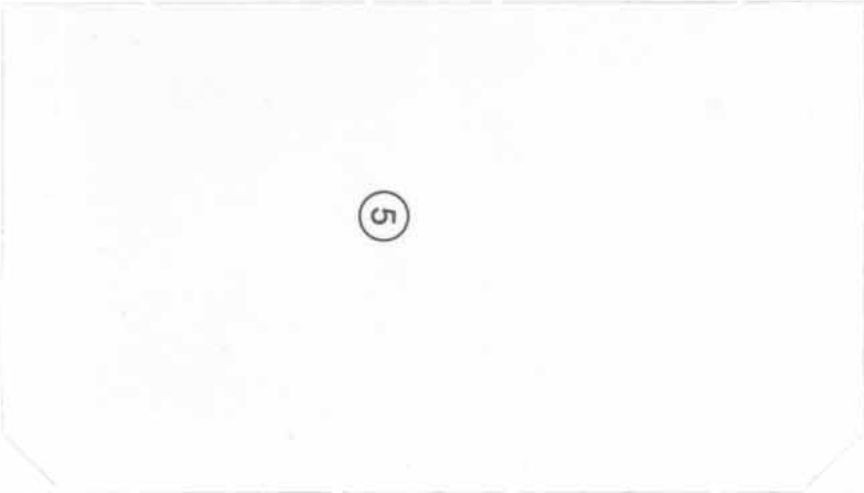

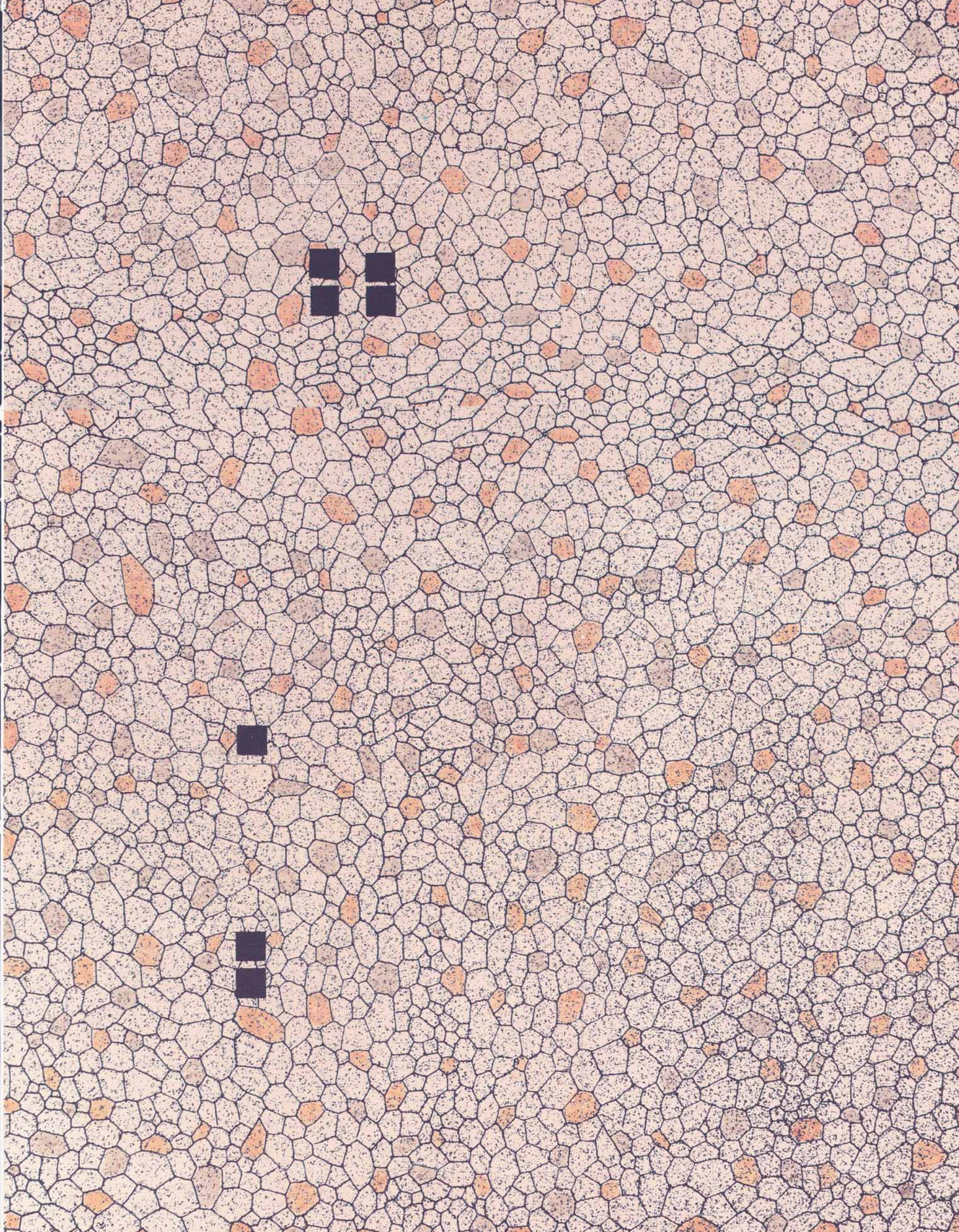

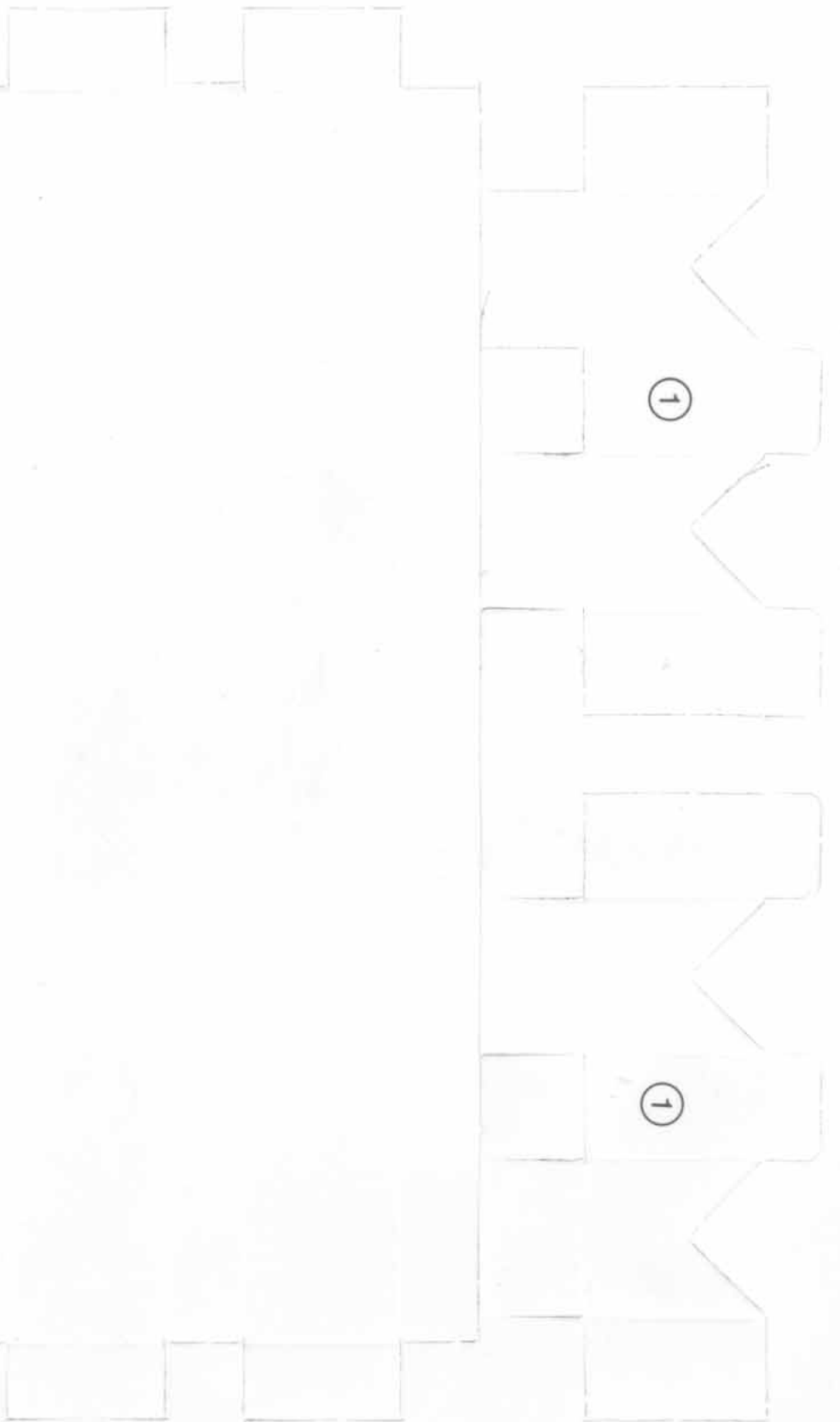
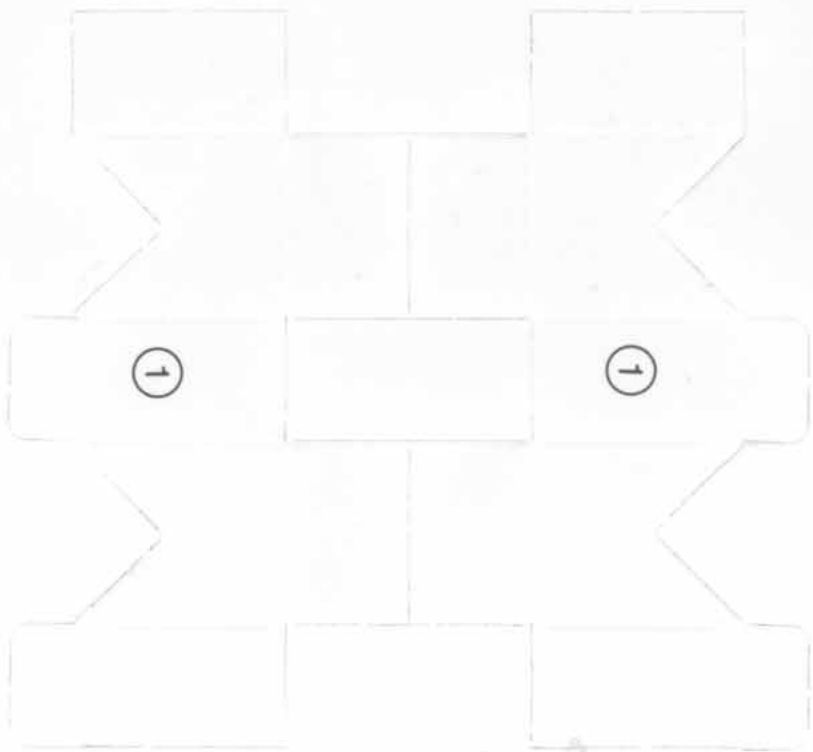
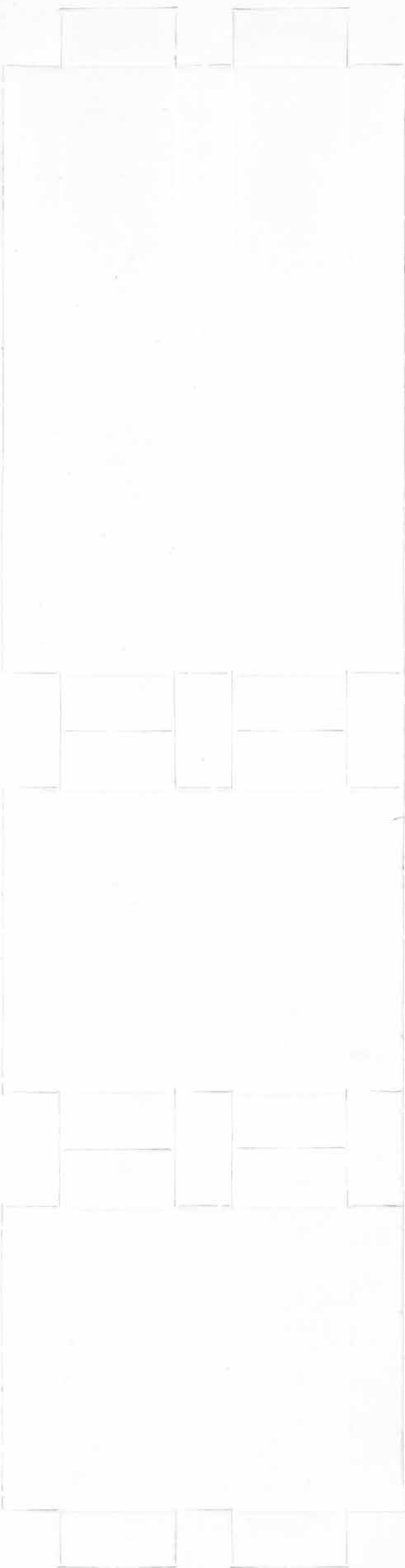

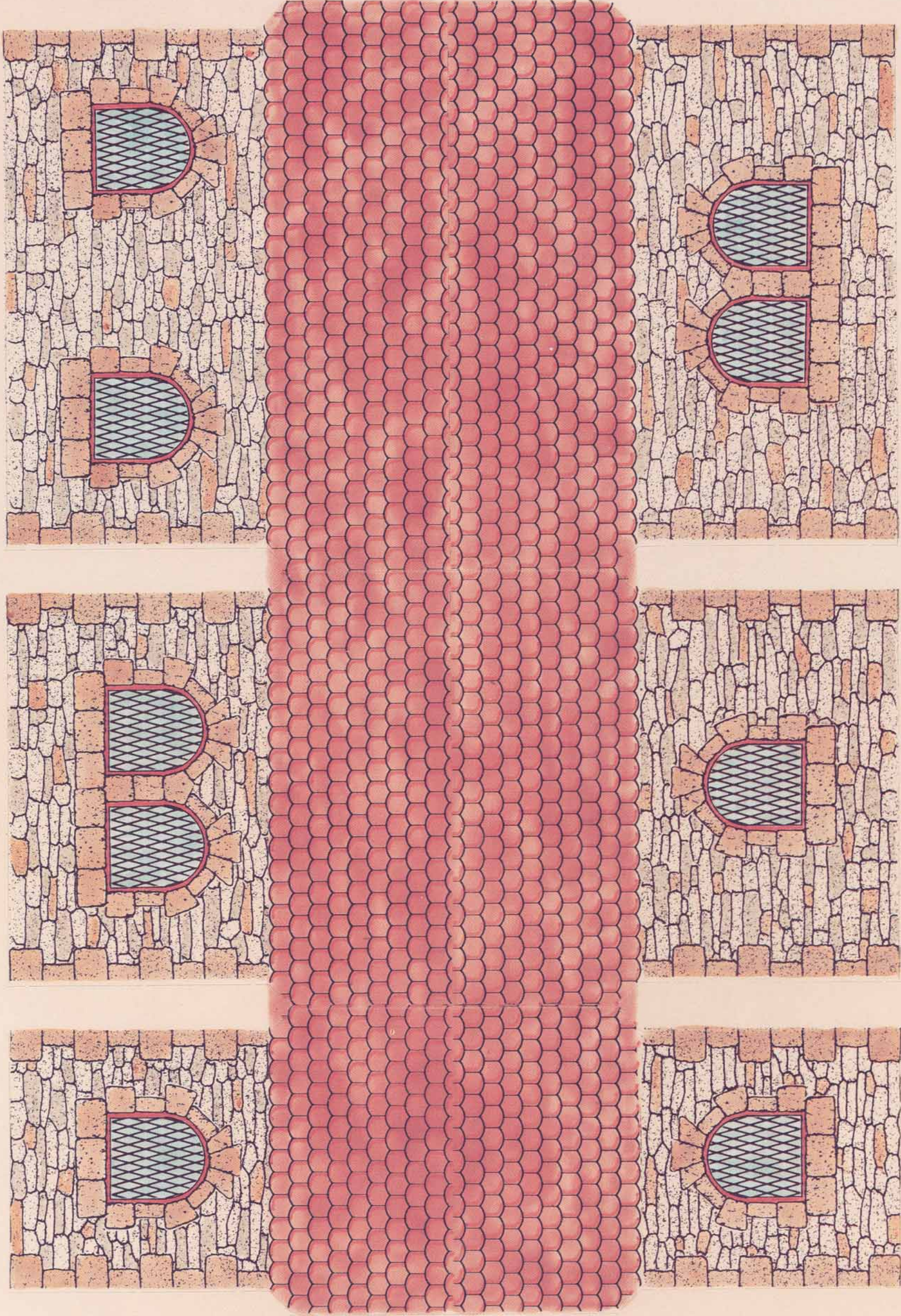



3

3

3

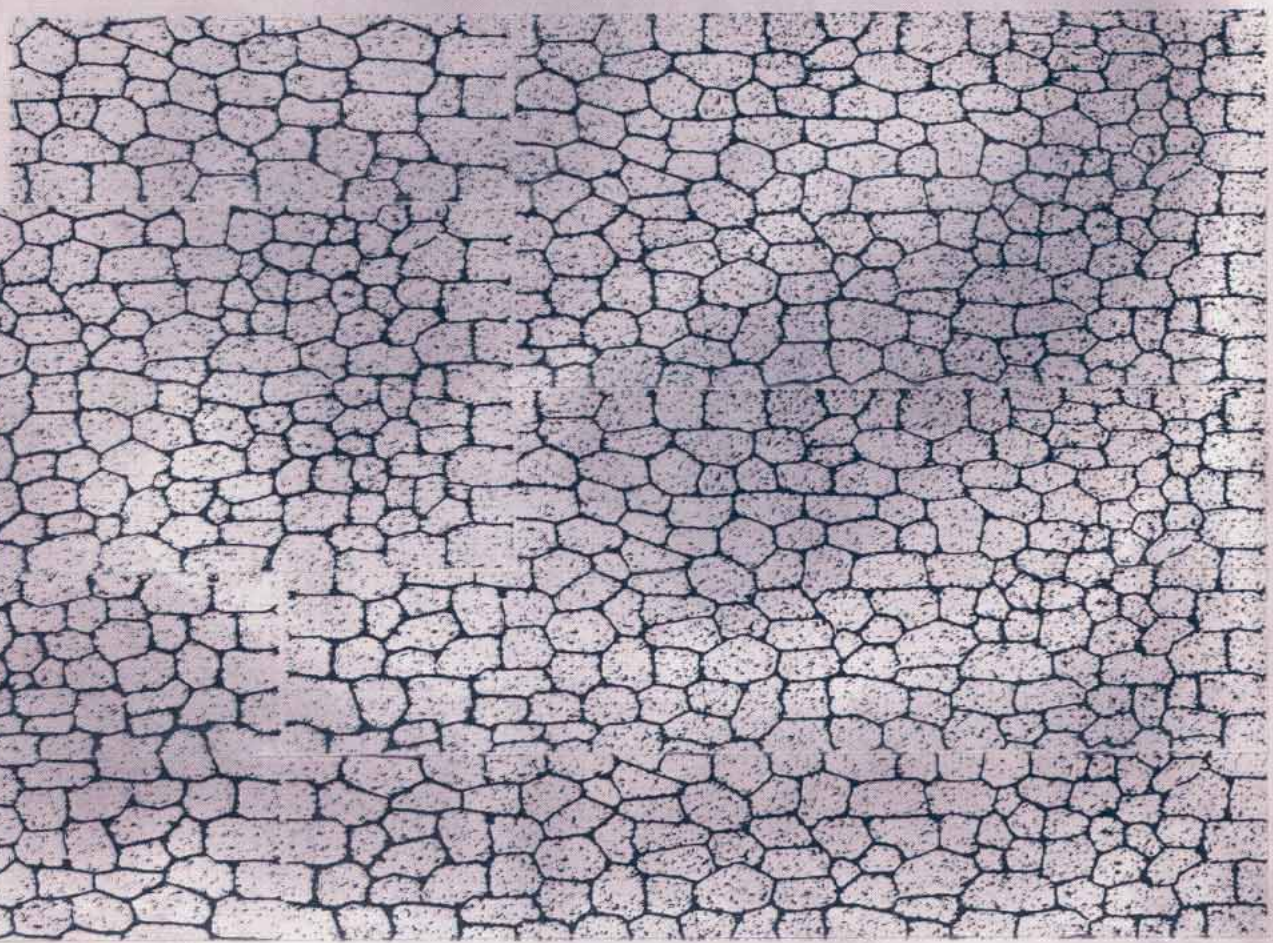
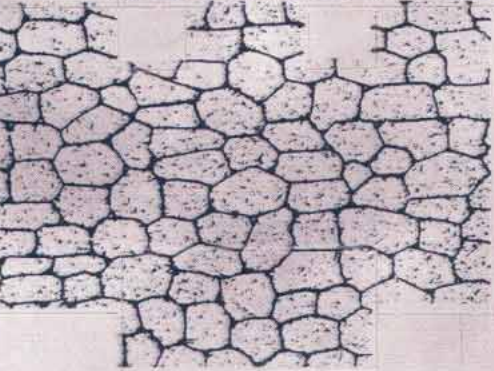
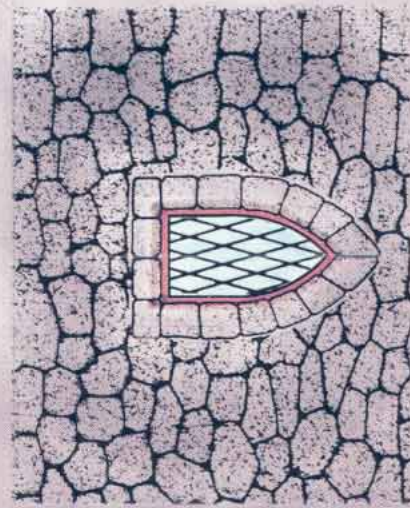
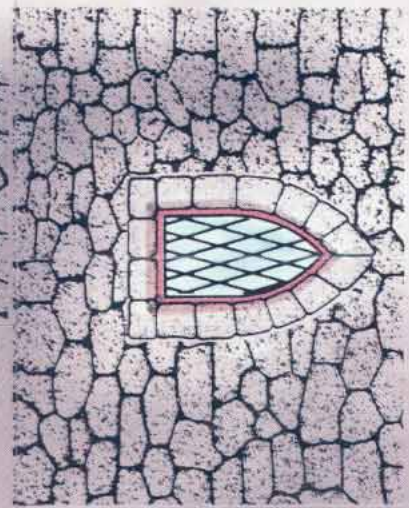
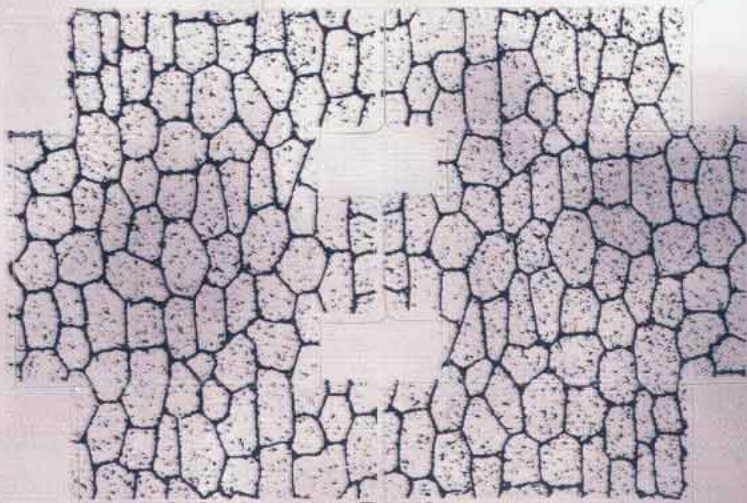
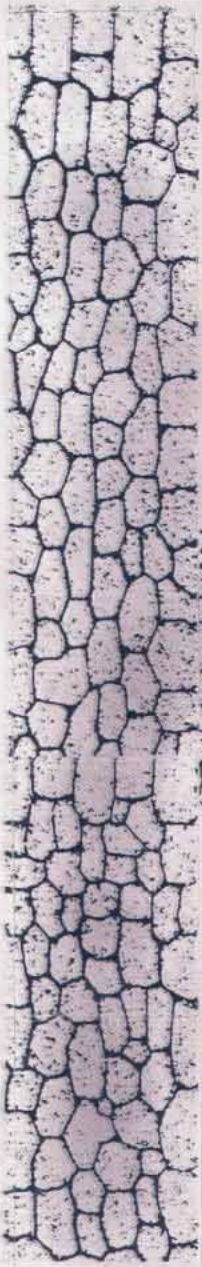
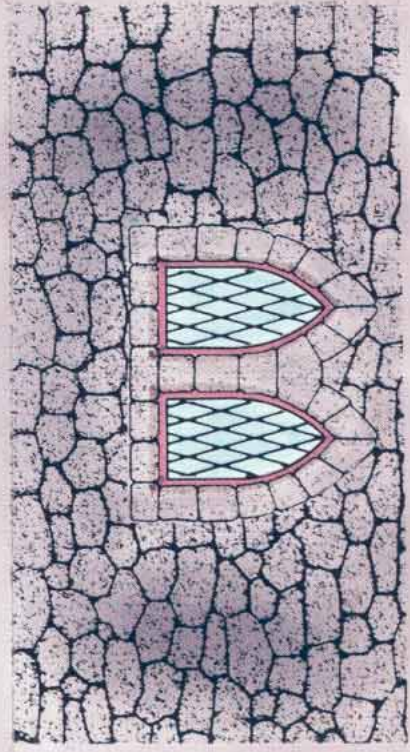
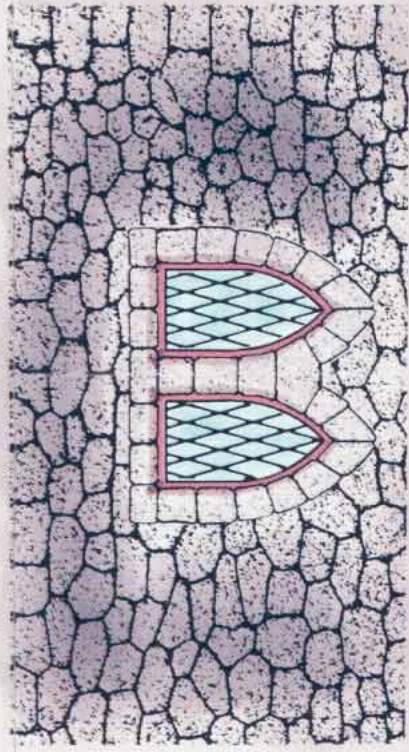
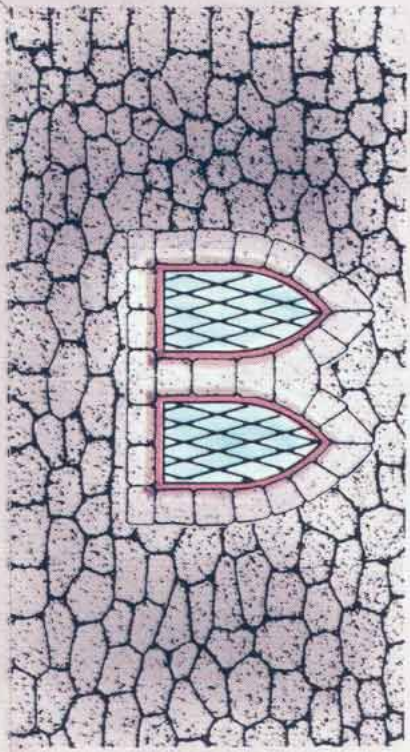
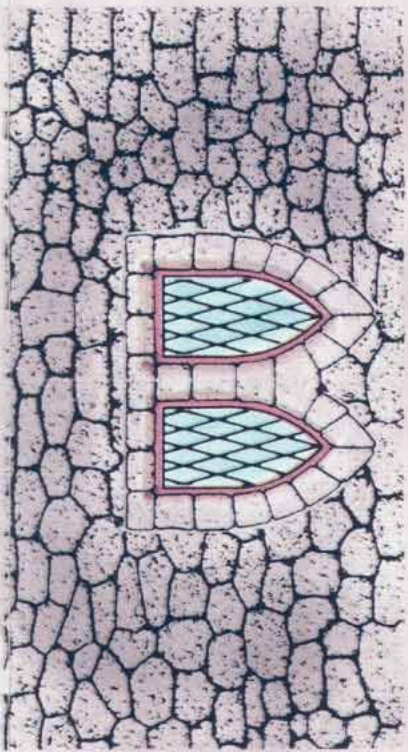

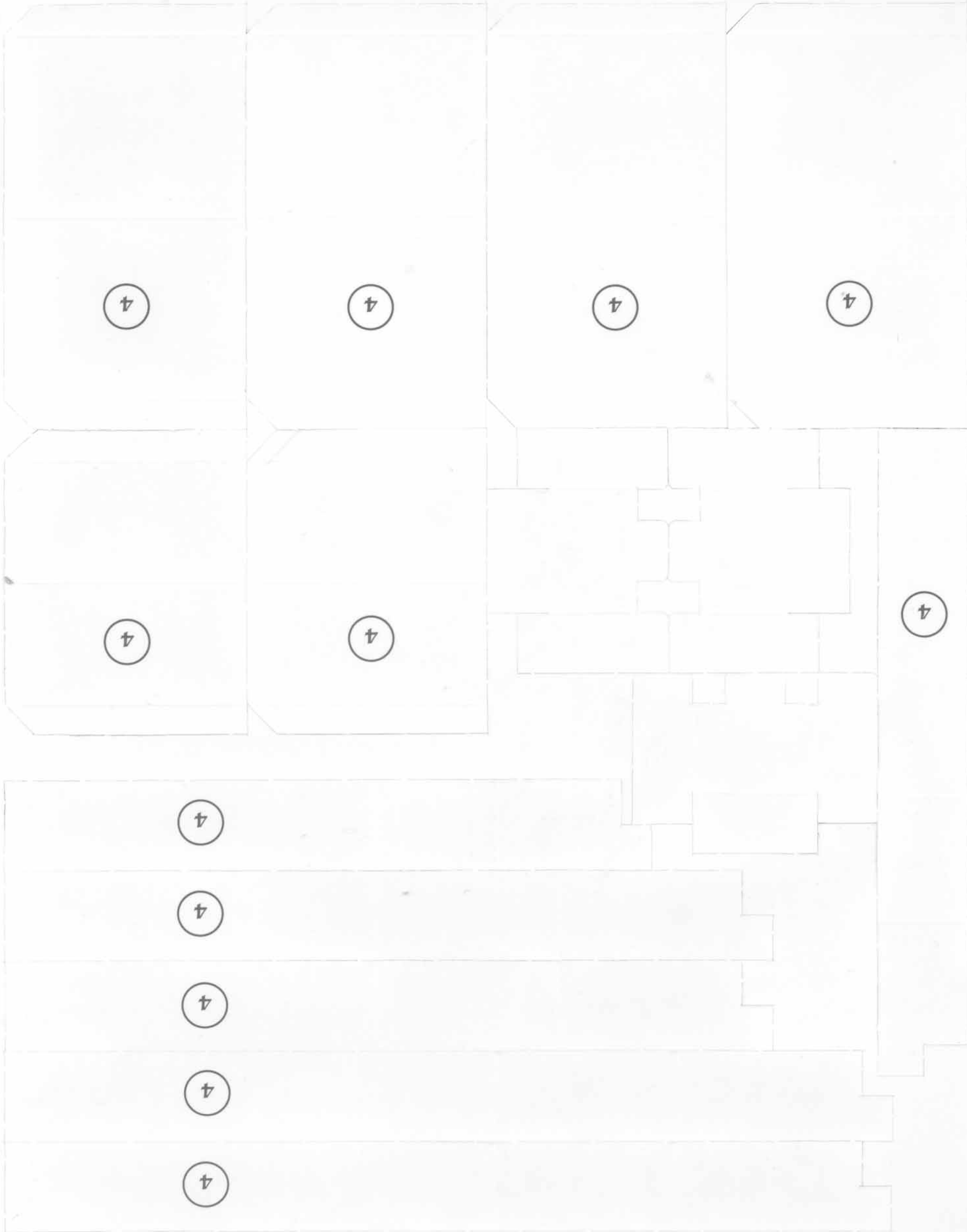

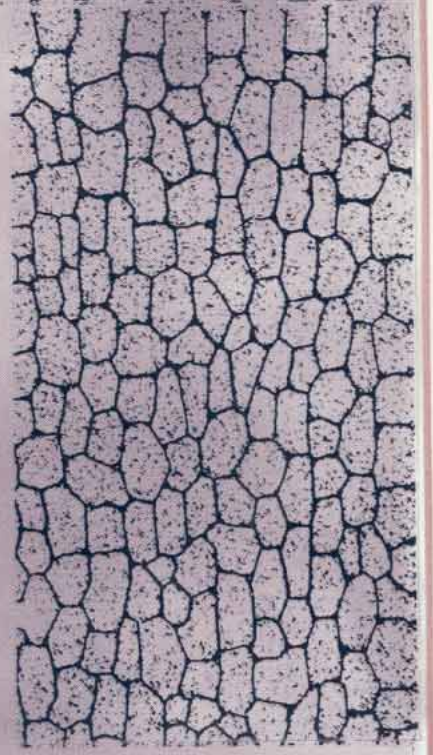
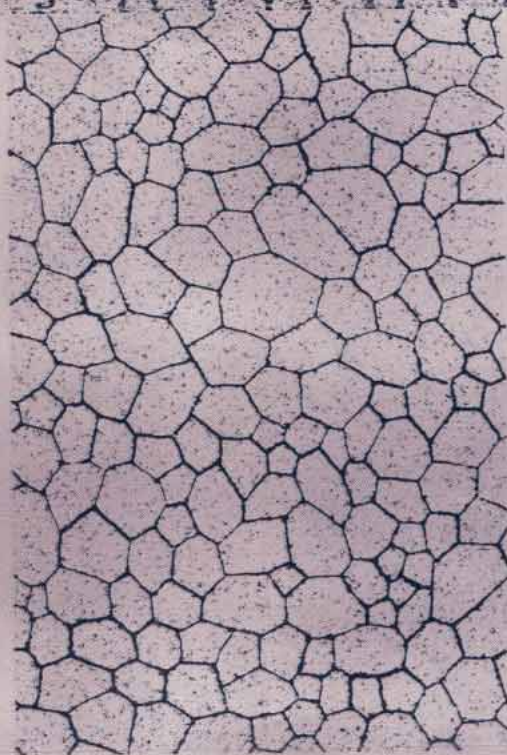
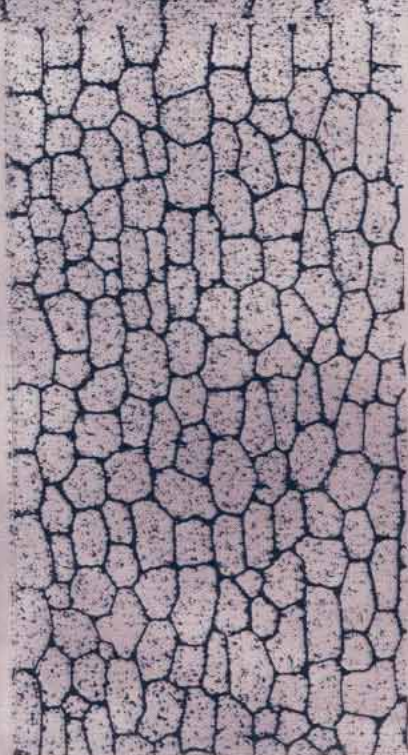
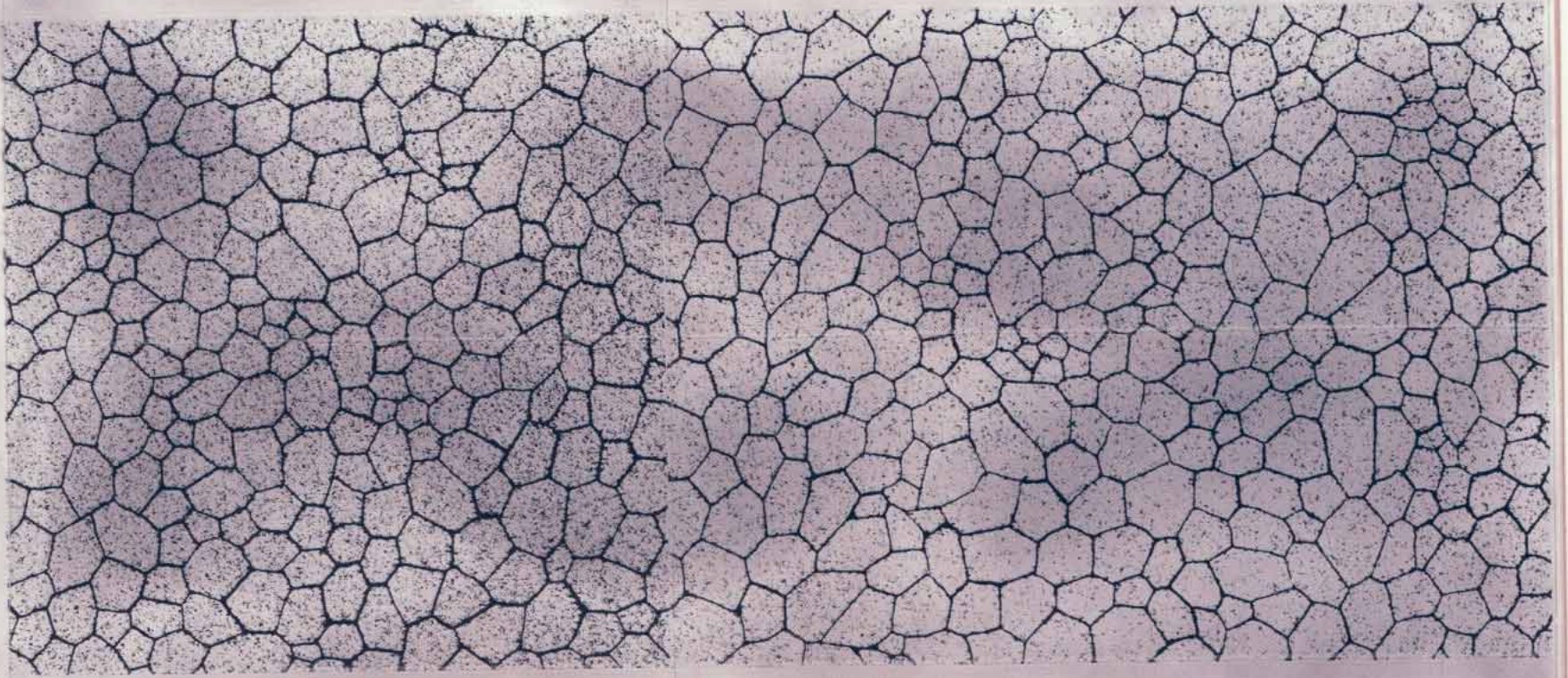
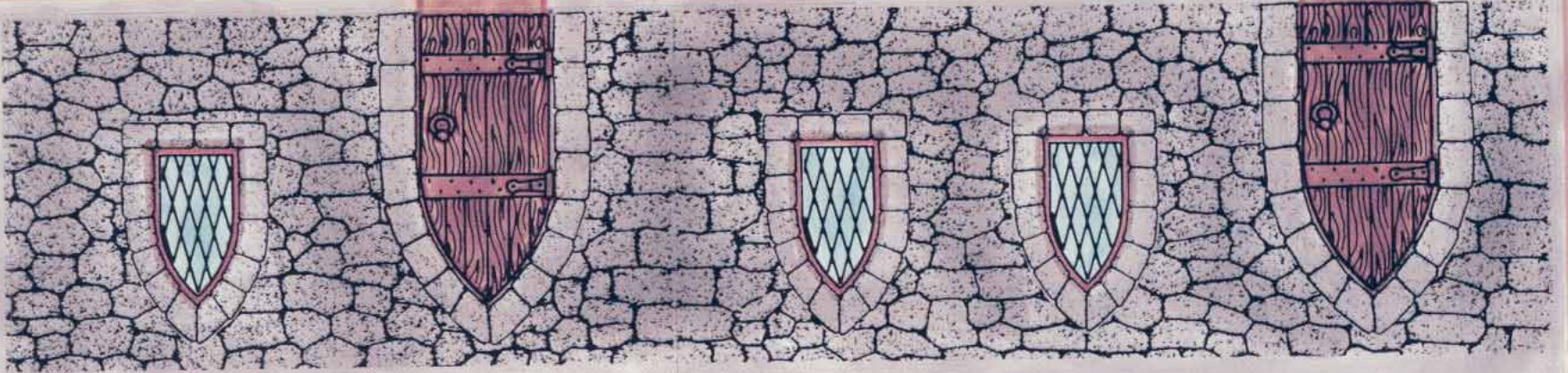

4

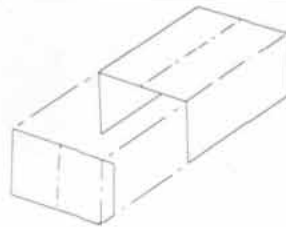

Each flat-roofed building is a box made of three pieces. When the box is finished, add the two pieces that form a collar around the top. To make a tall structure, fit another completed building inside the collar and down onto the roof (which now becomes the floor of the upper story).

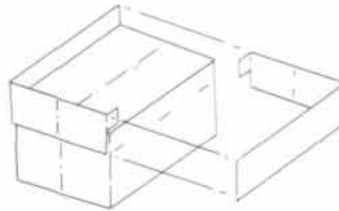

To make a balcony, fold up the front panel and tape or glue the side-panel tabs to the inside of the front panel. Slots for the balconies are not pre-cut; to use these parts, you'll have to cut slots in your buildings where you want to put them.



4

4

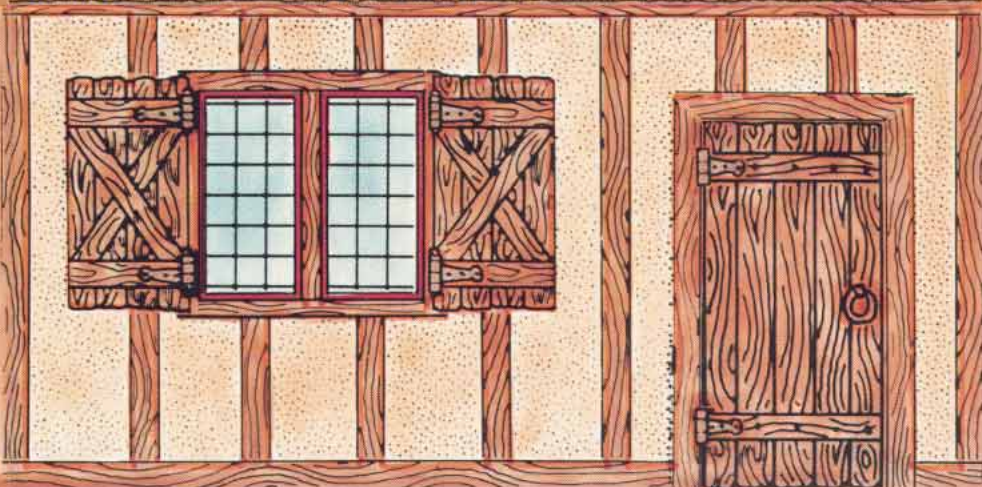
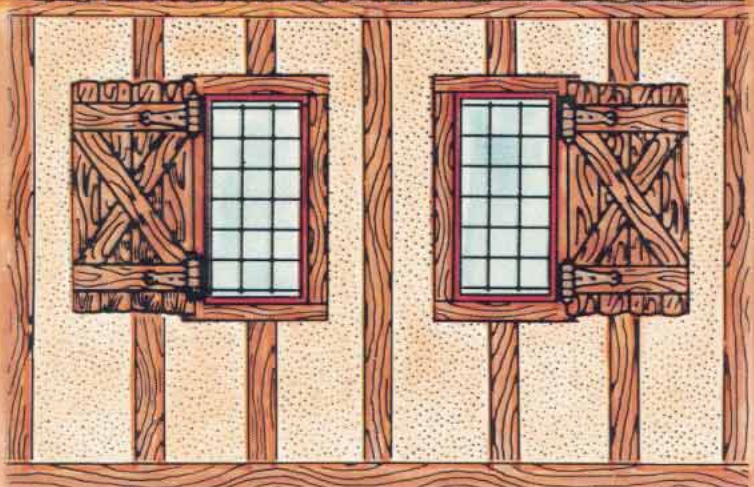
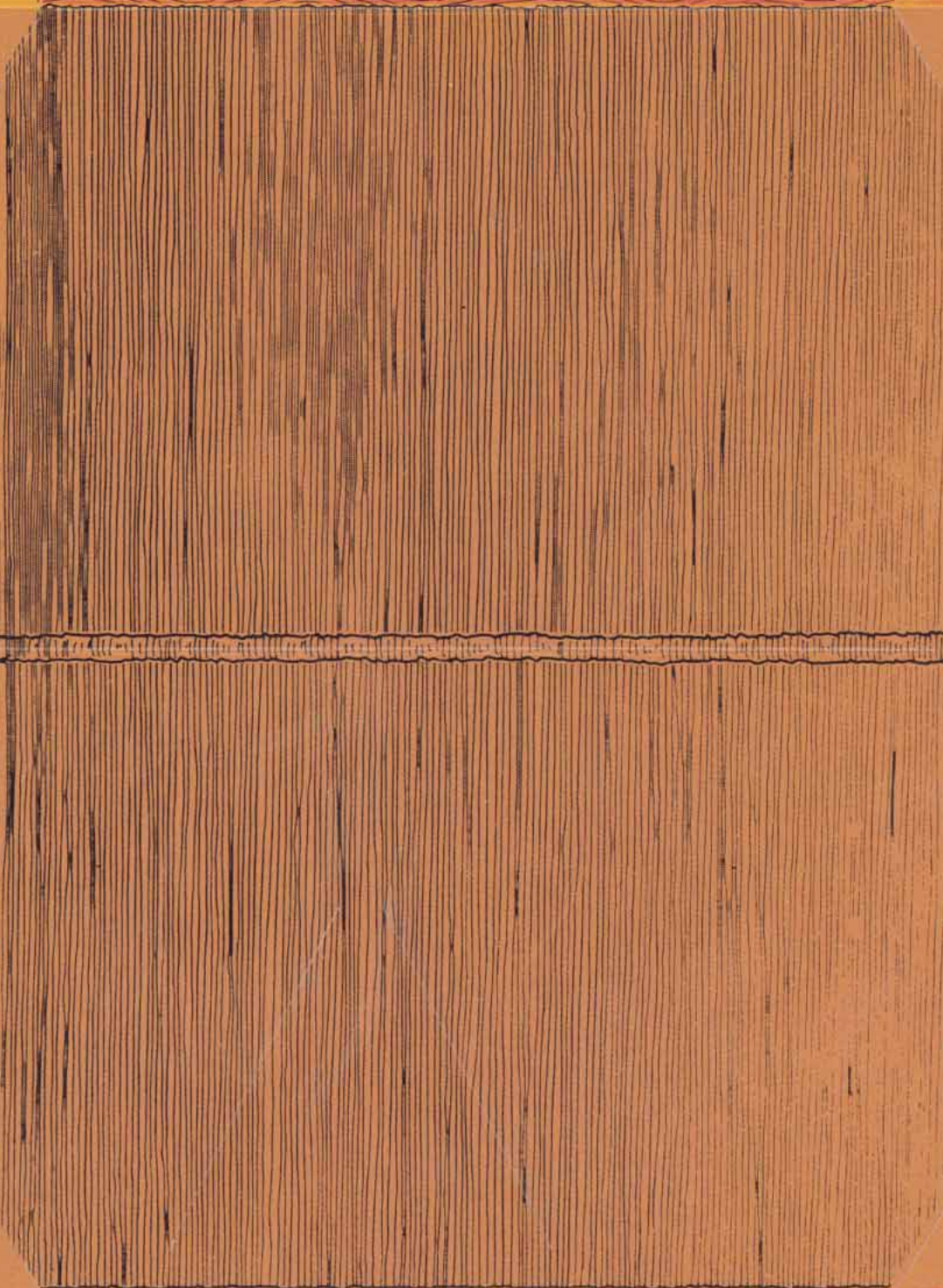
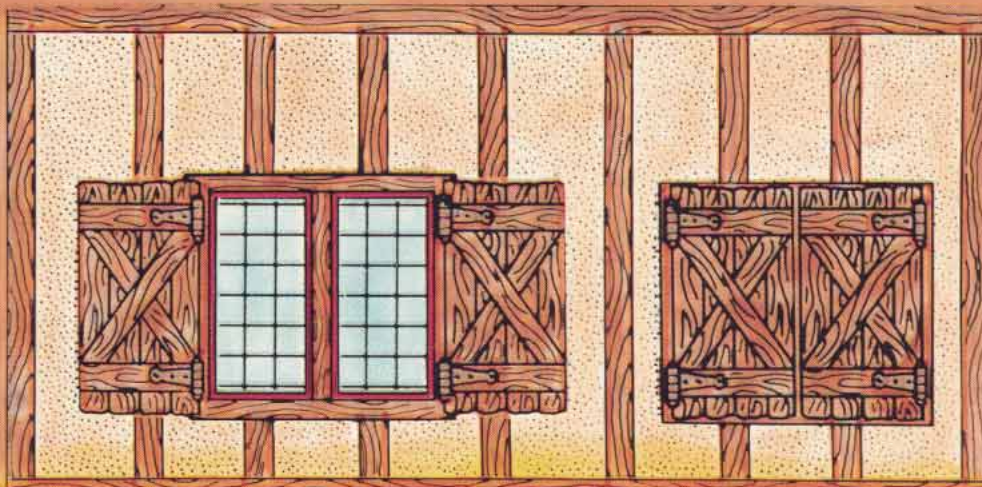
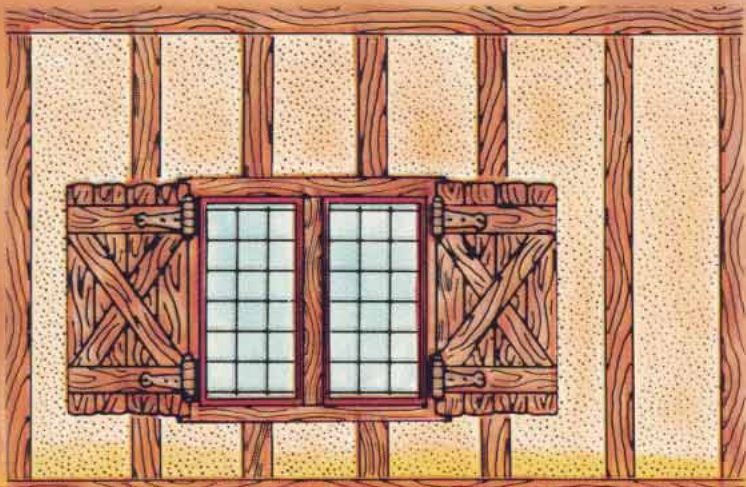

The basic shape of each building is composed of three large pieces. Tape or glue the side walls onto the roof section, and then add accessories (dormers and chimneys) as indicated. A dormer that fits into a roof is made of two pieces fastened together; a dormer that fits into a wall is made of two separate pieces. A chimney is one piece; fold it into a square cylinder and glue the tabs to the inside of the adjacent surface. When you're ready to add the accessories, just slip the tabs into the slots.

Many of the building and accessory pieces have crease lines that make it possible for you to collapse them for efficient storage between playing sessions. If storage space is not a problem and you want to construct the buildings permanently, you can use tape and glue to fasten the accessories to each building and to fit the side walls rigidly against the underside of the roof.

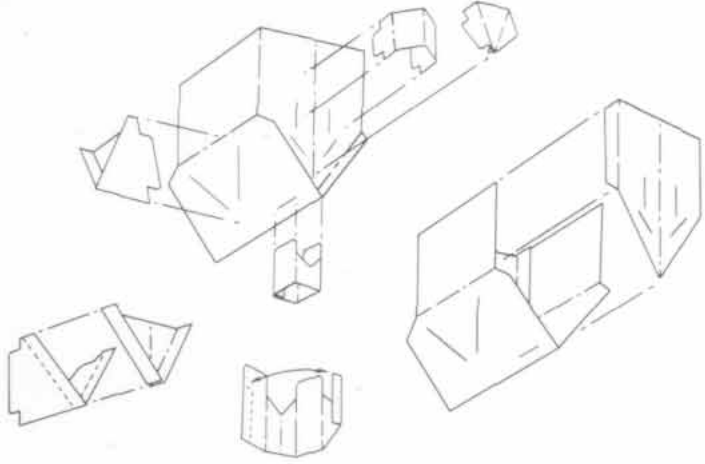

2



2

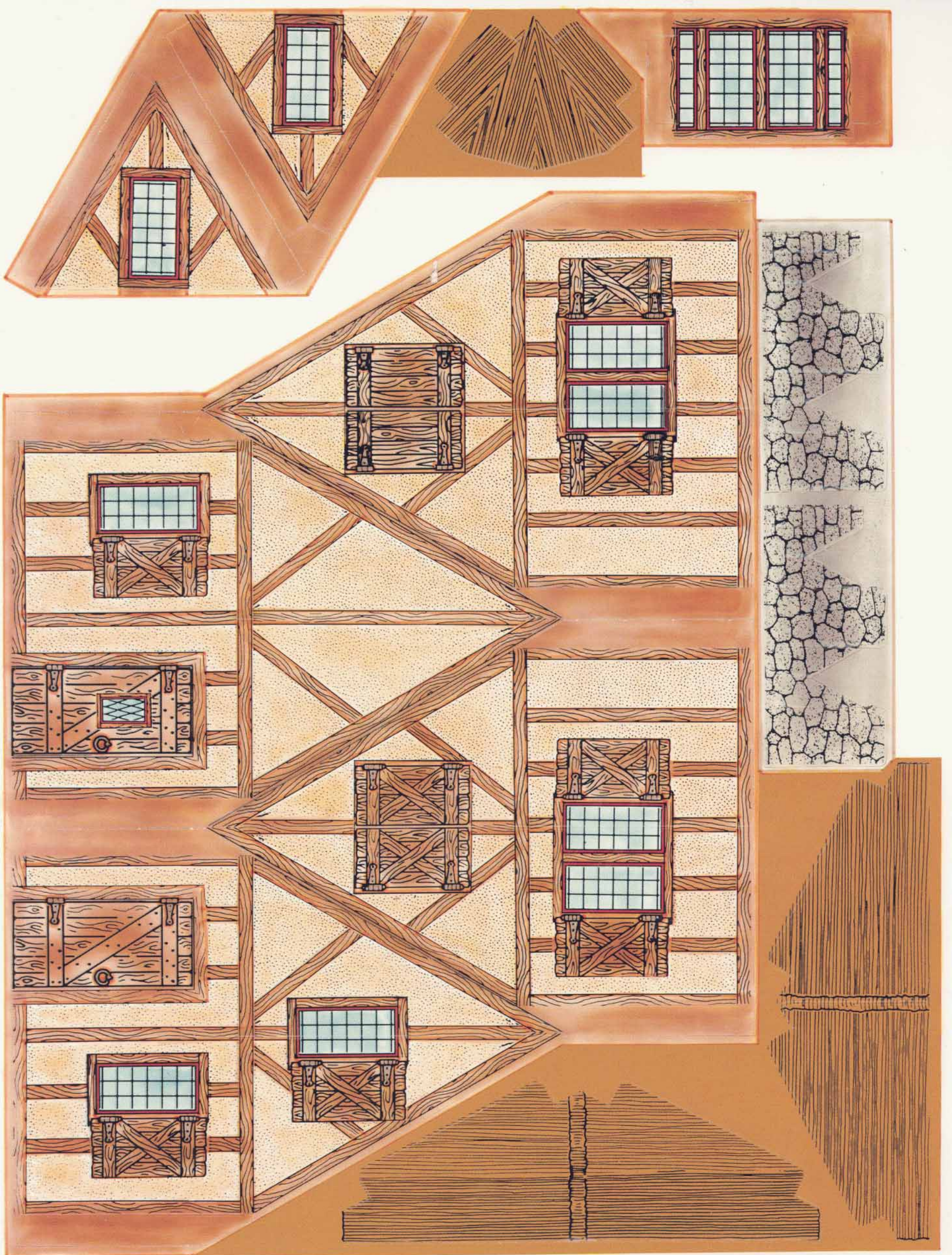



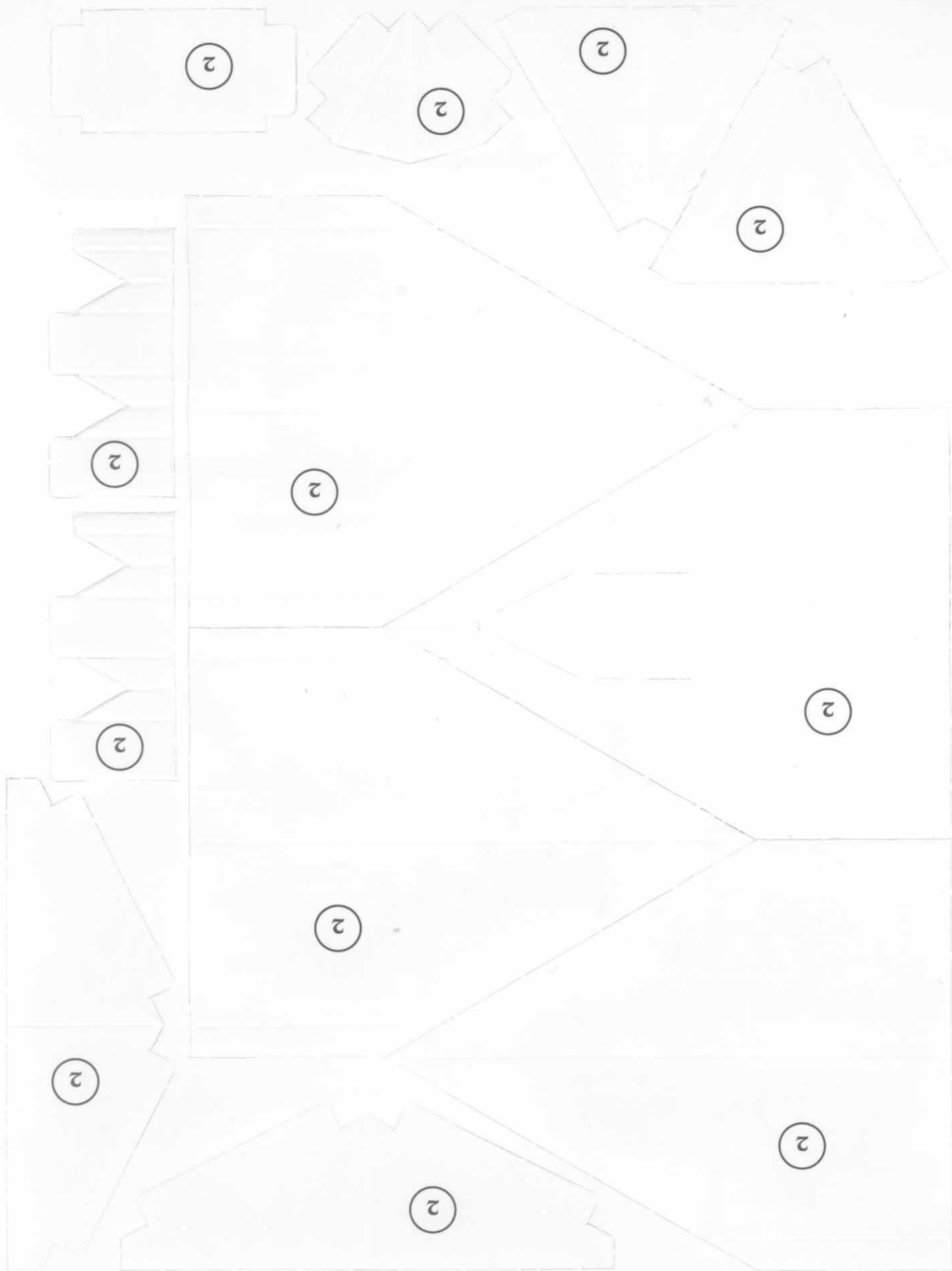

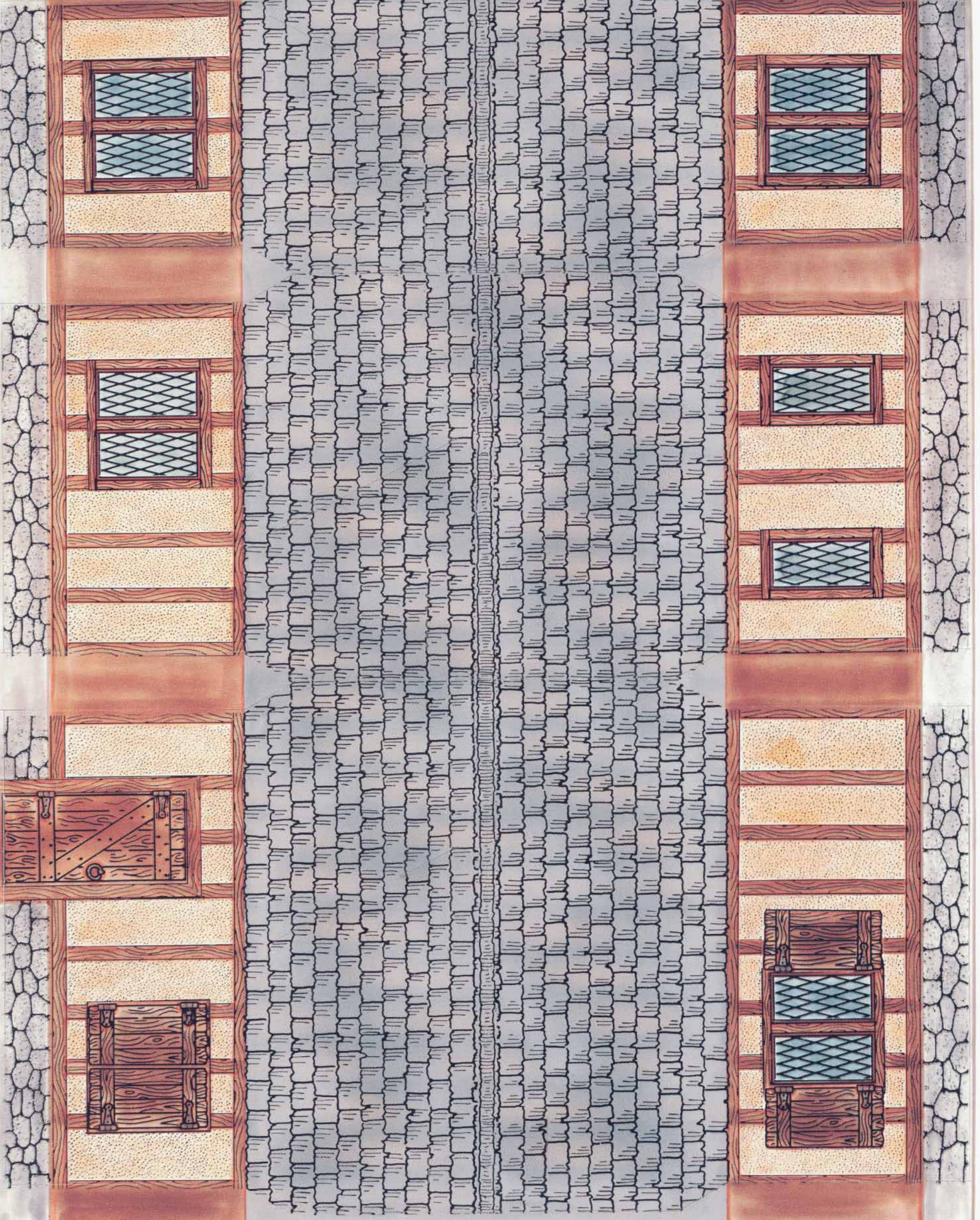

5

5

5

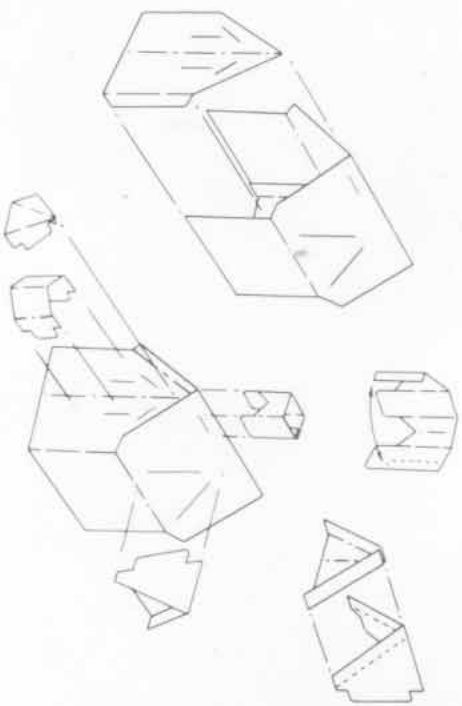

The basic shape of each building is composed of three large pieces. Tape or glue the side walls onto the roof section, and then add accessories (dormers and chimneys) as indicated. A dormer that fits into a roof is made of two pieces fastened together; a dormer that fits into a wall is made of two separate pieces. A chimney is one piece; fold it into a square cylinder and tape or glue the tabs to the inside of the adjacent surface. When you're ready to add the accessories, just slip the tabs into the slots.

Many of the building and accessory pieces have crease lines that make it possible for you to collapse them for efficient storage between playing sessions. If storage space is not a problem and you want to construct the buildings permanently, you can use tape and glue to fasten the accessories to each building and to fit the side walls rigidly against the underside of the roof.

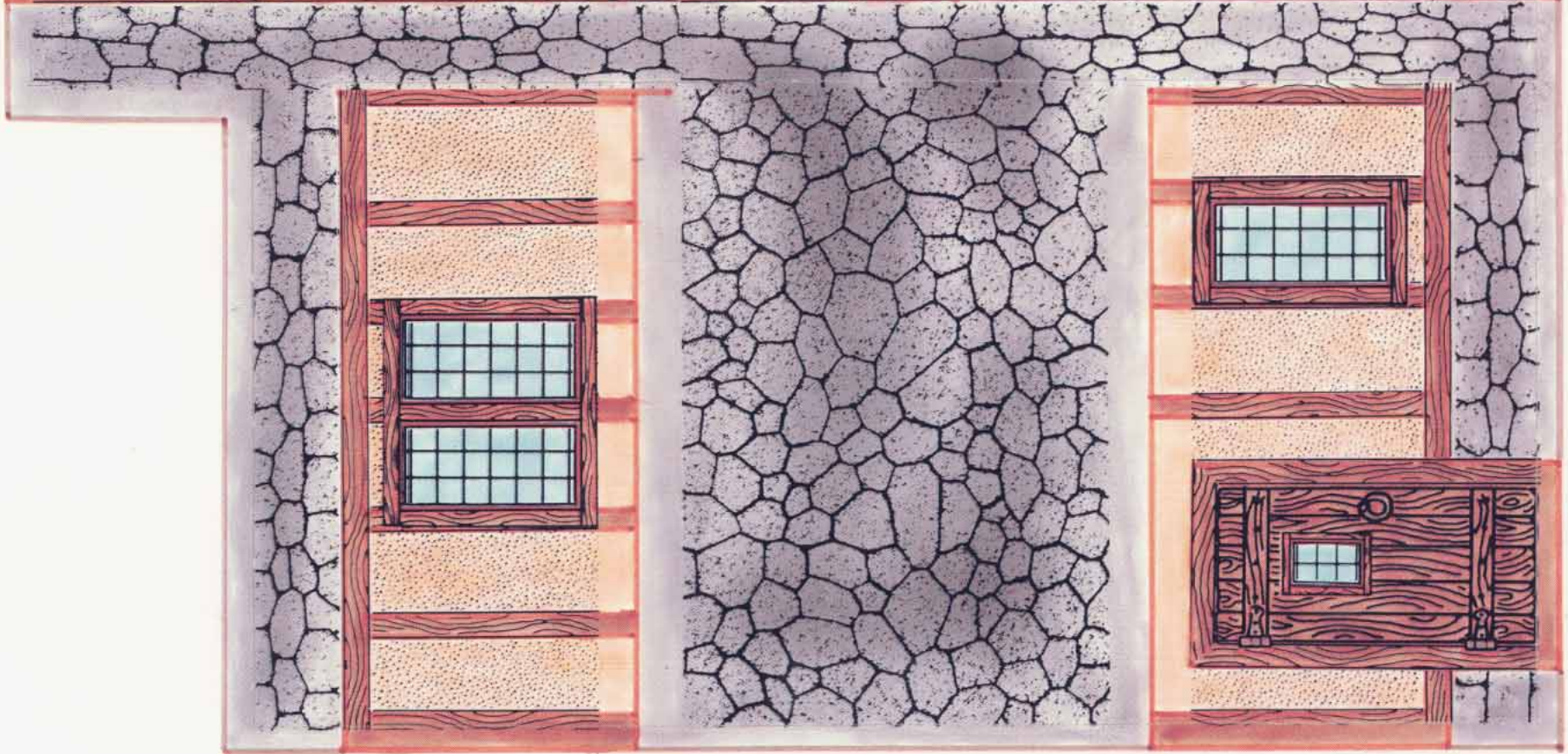
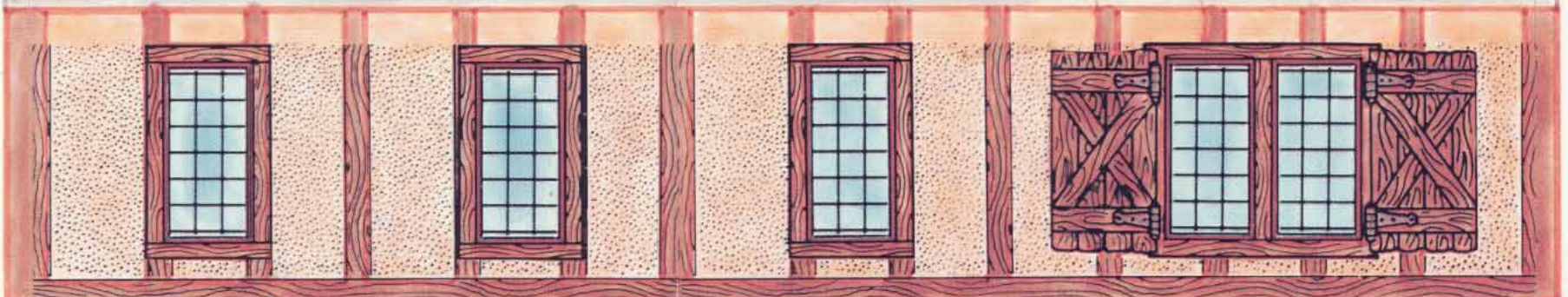
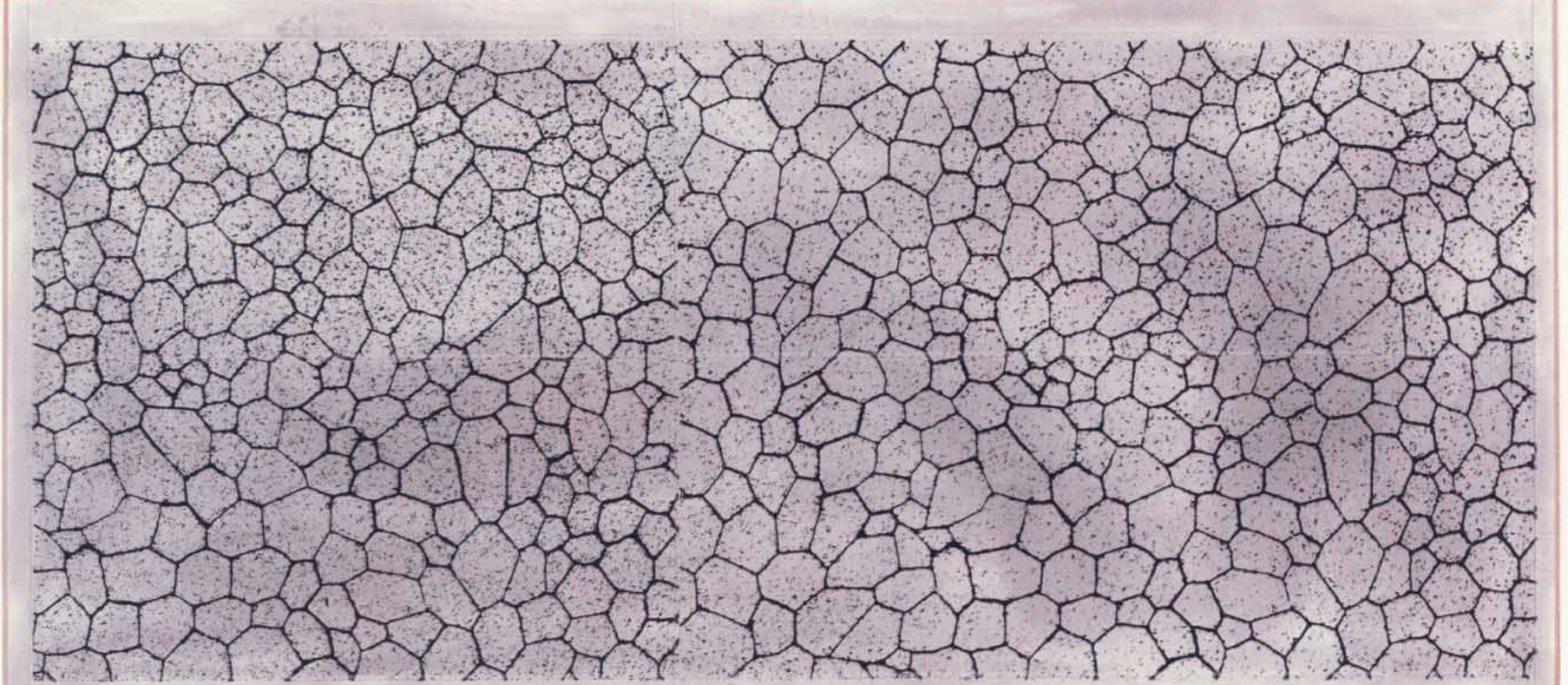
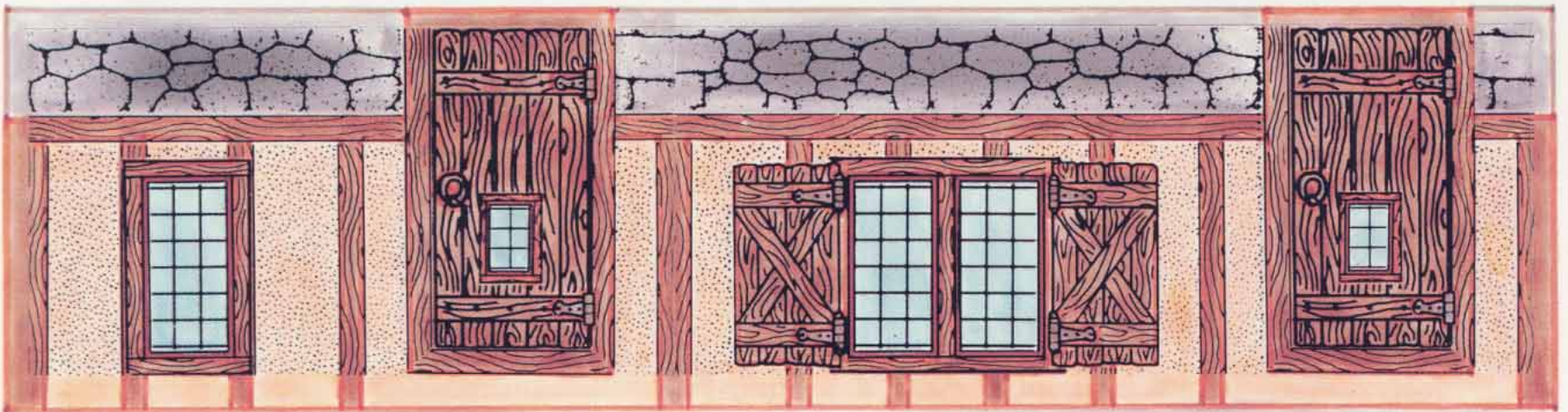

3

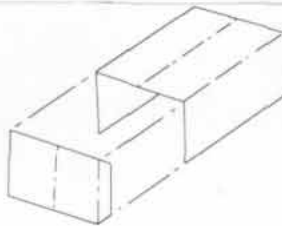

Each flat-roofed building is a box made of three pieces. When the box is finished, add the two pieces that form a collar around the top. To make a tall structure, fit another completed building inside the collar and down onto the roof (which now becomes the floor of the upper story).

To make a balcony, fold up the front panel and tape or glue the side-panel tabs to the inside of the front panel. Slots for the balconies are not precut; to use these parts, you'll have to cut slots in your buildings where you want to put them.

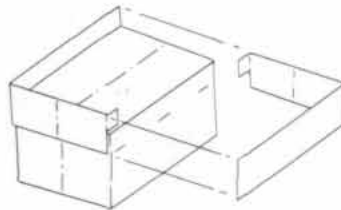

3

3

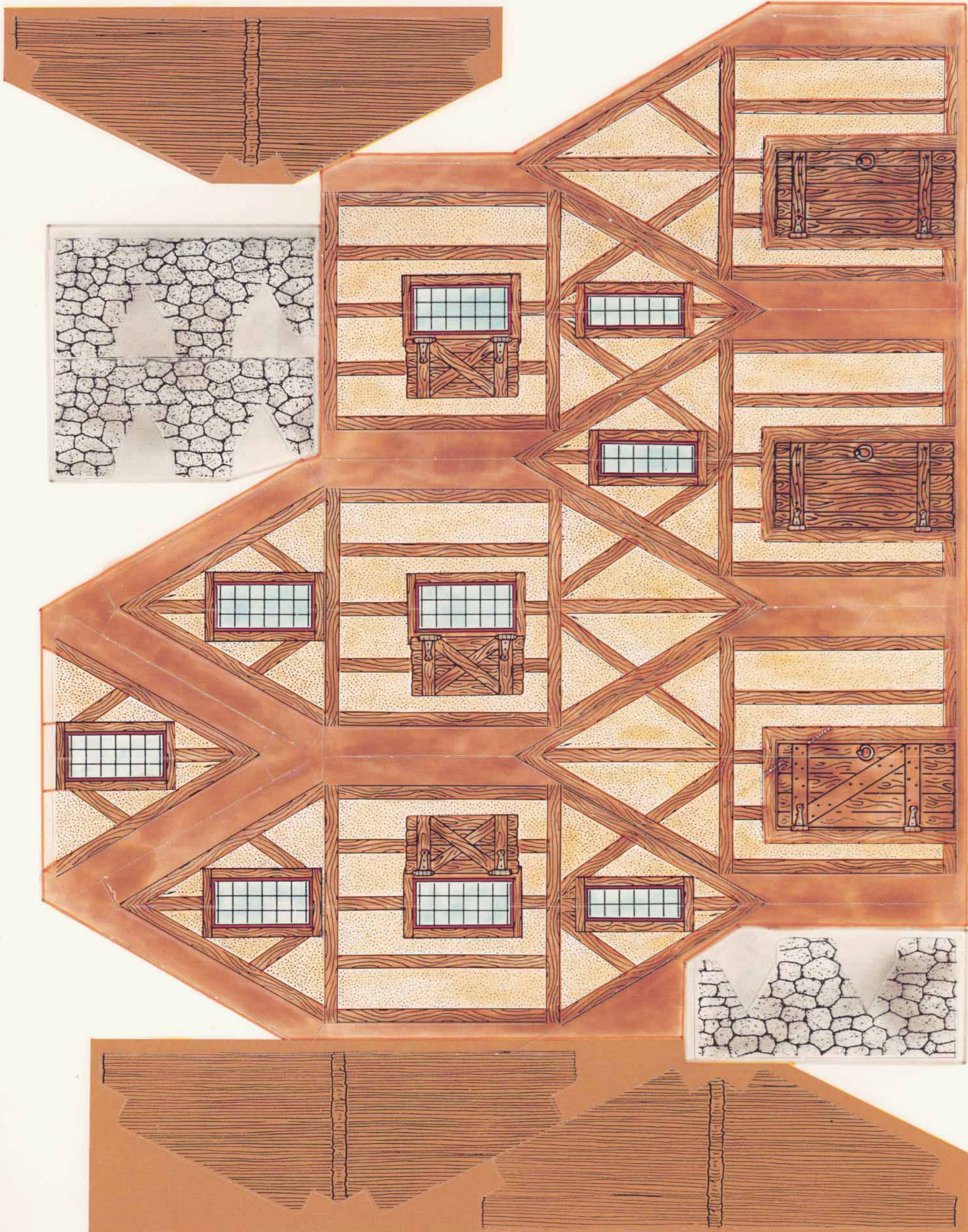



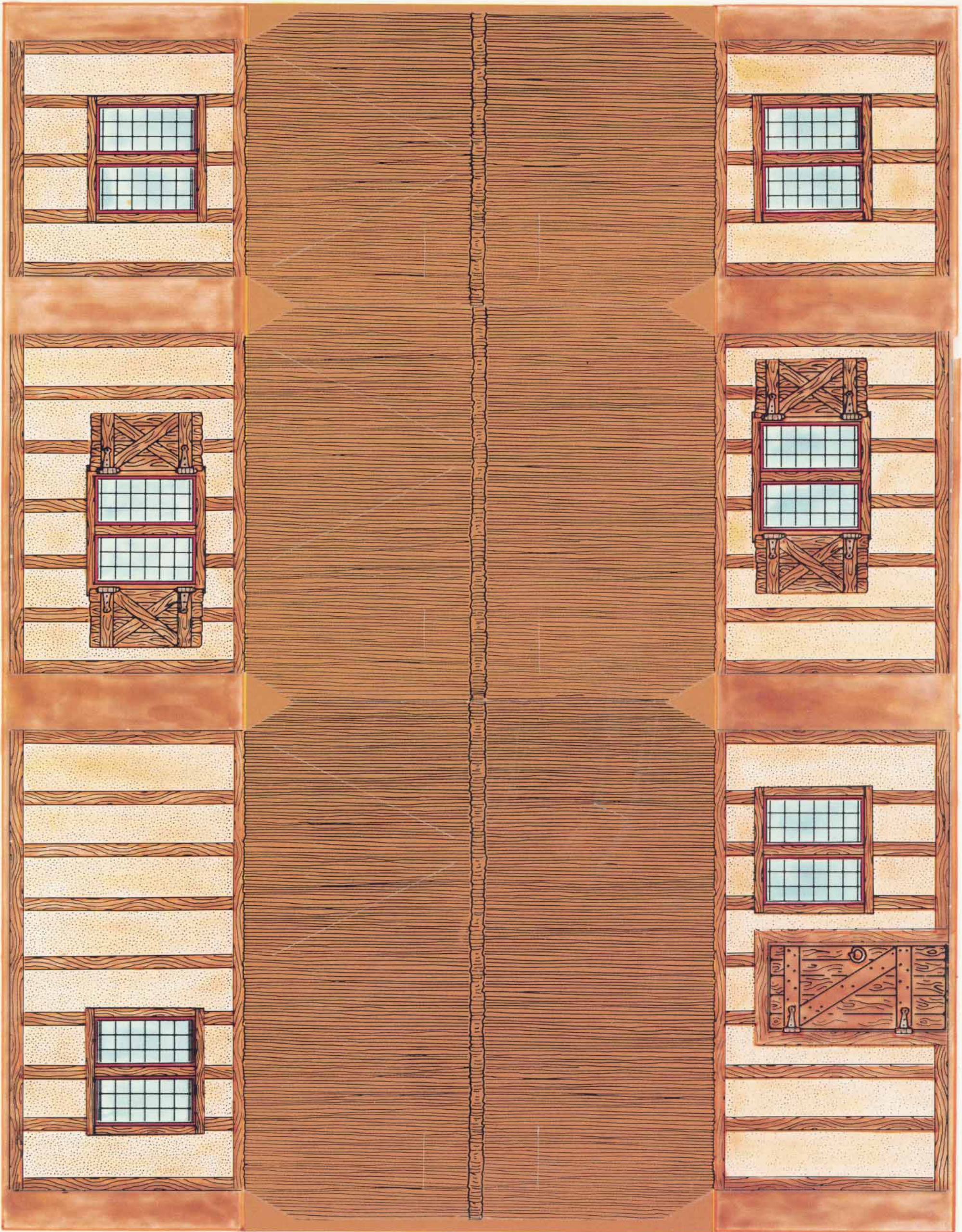



9

9

9

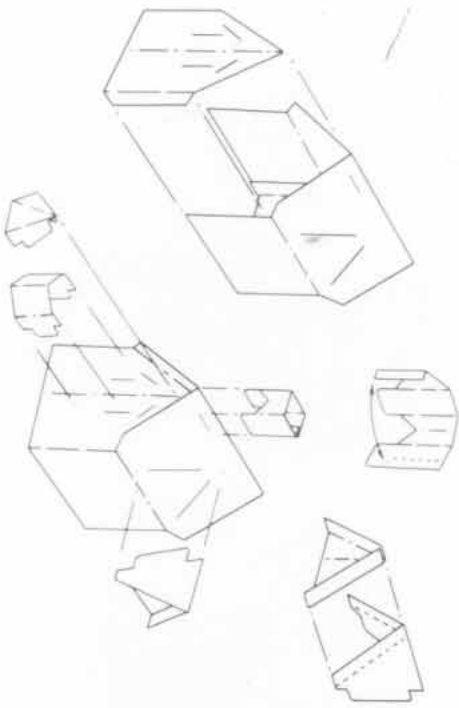

The basic shape of each building is composed of three large pieces. Tape or glue the side walls onto the roof section, and then add accessories (dormers and chimneys) as indicated. A dormer that fits into a roof is made of two pieces fastened together; a dormer that fits into a wall is made of two separate pieces. A chimney is one piece; fold it into a square cylinder and tape or glue the tabs to the inside of the adjacent surface. When you're ready to add the accessories, just slip the tabs into the slots.

Many of the building and accessory pieces have crease lines that make it possible for you to collapse them for efficient storage between playing sessions. If storage space is not a problem and you want to construct the buildings permanently, you can use tape and glue to fasten the accessories to each building and to fit the side walls rigidly against the underside of the roof.

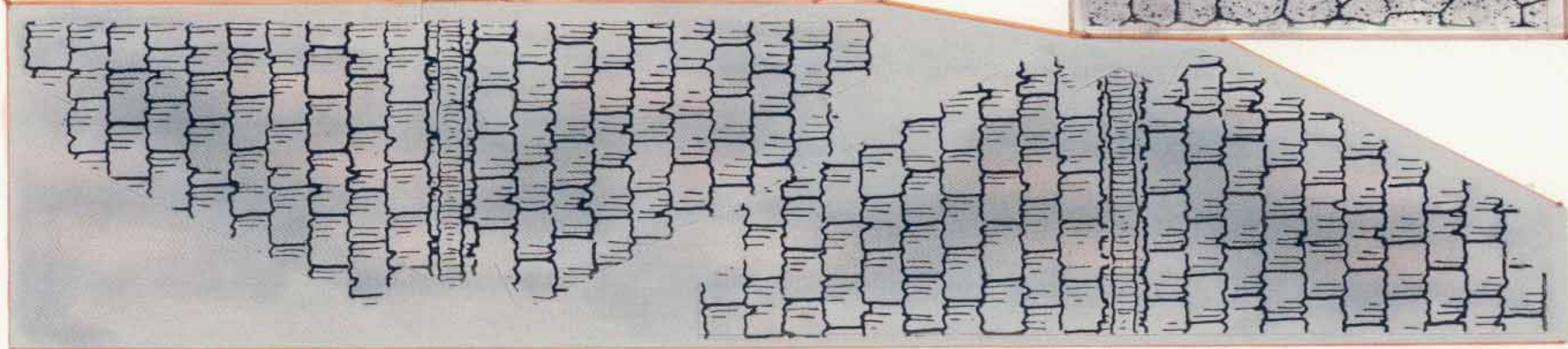
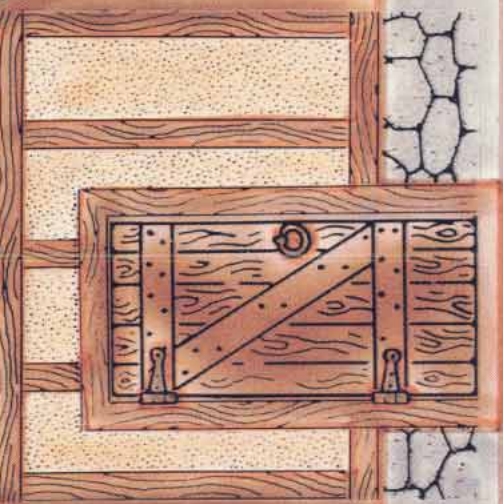
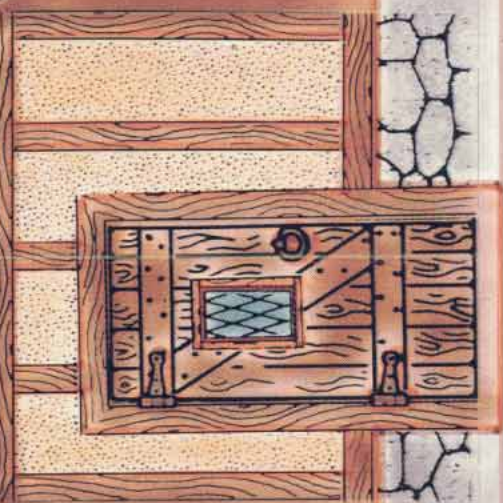
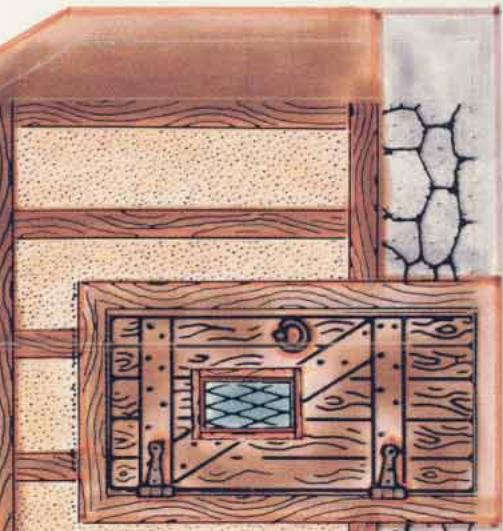
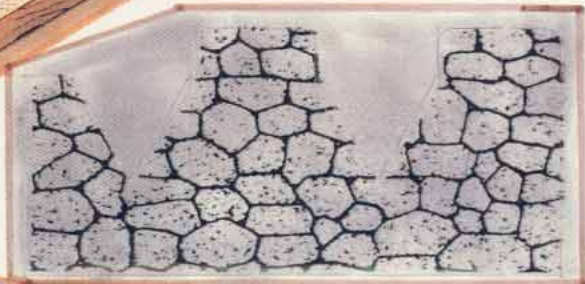
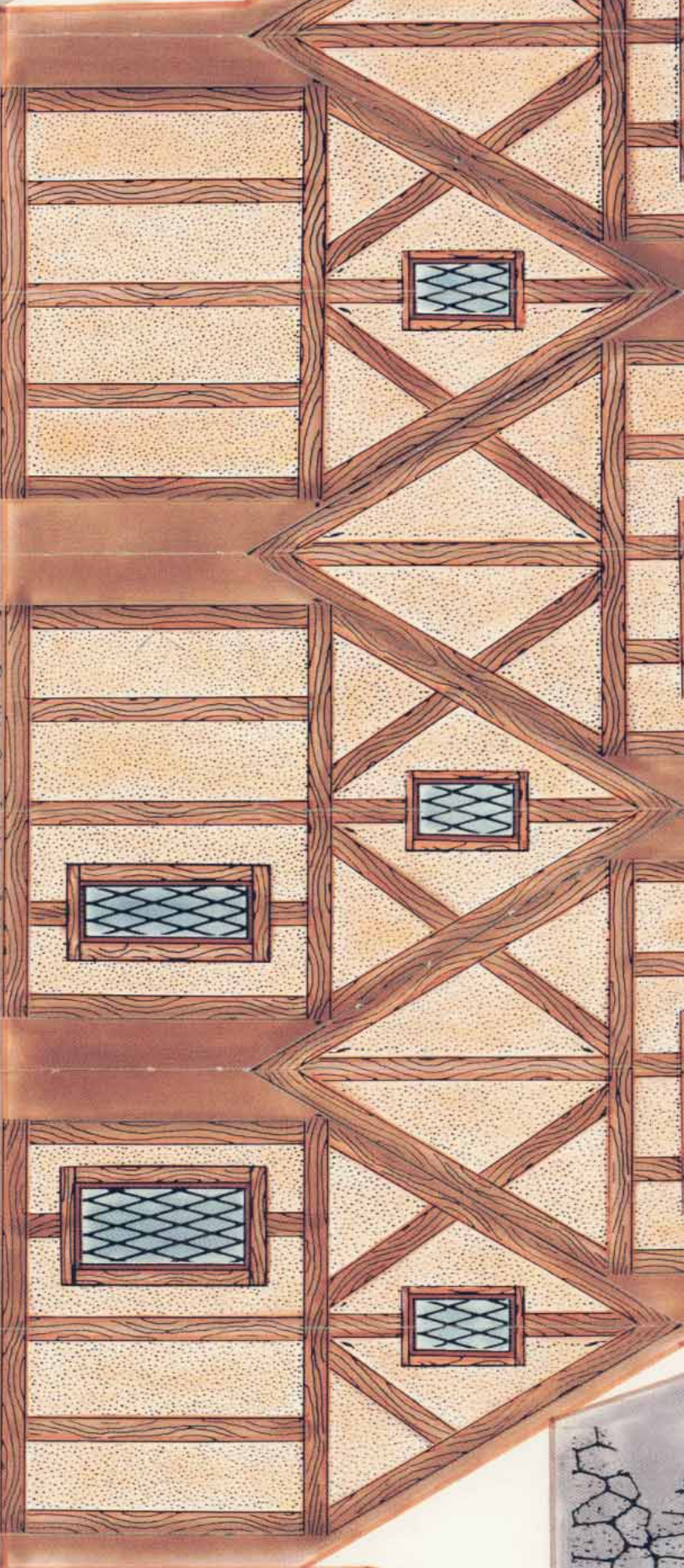
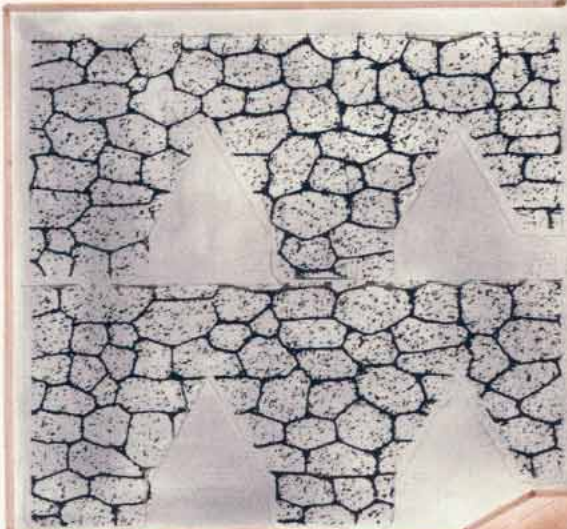
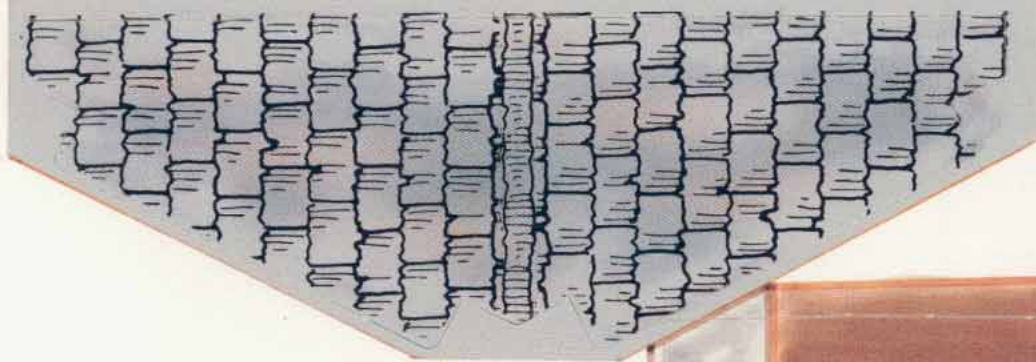



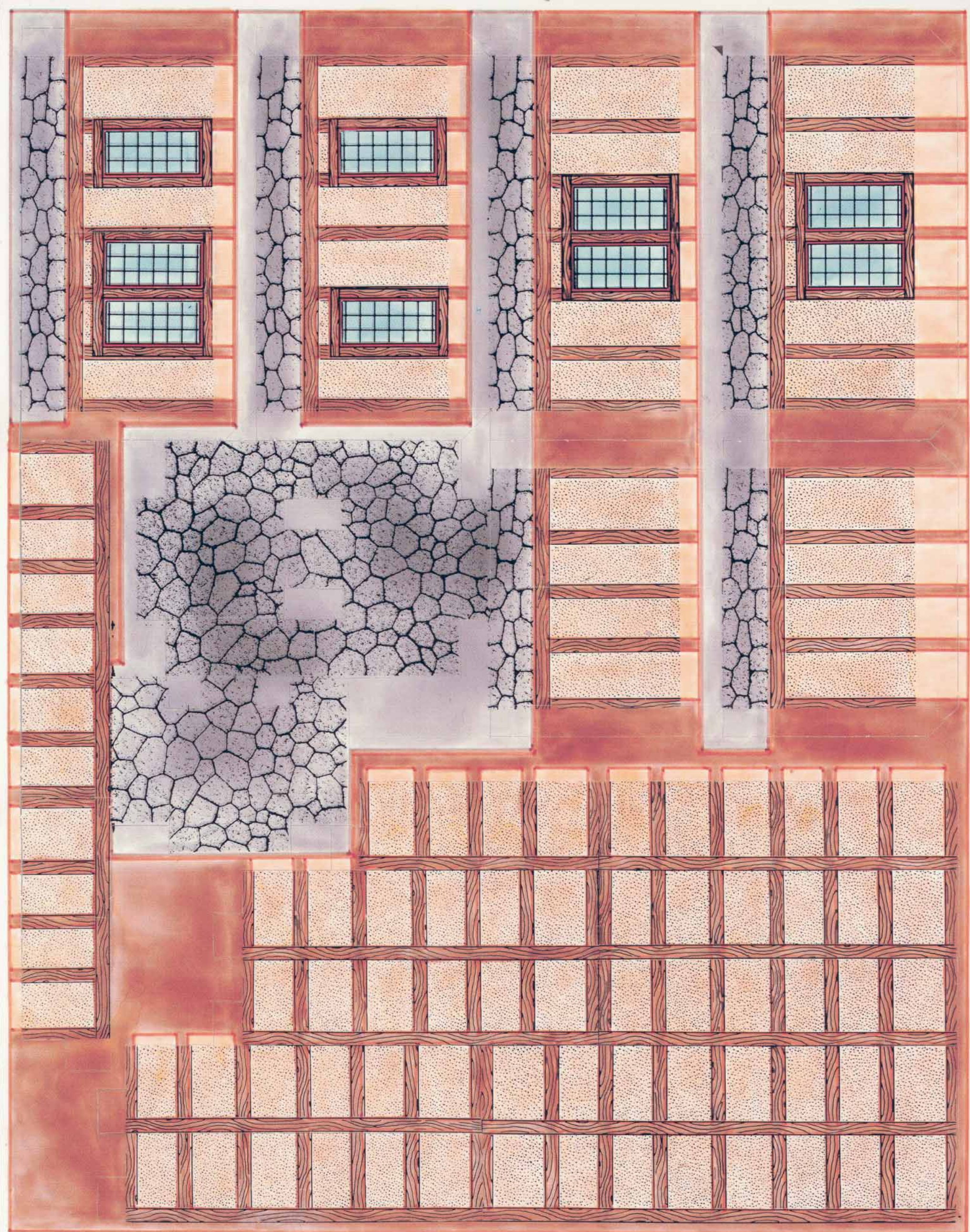

3

3

3

3

3

3

3

3

3

3

3

3

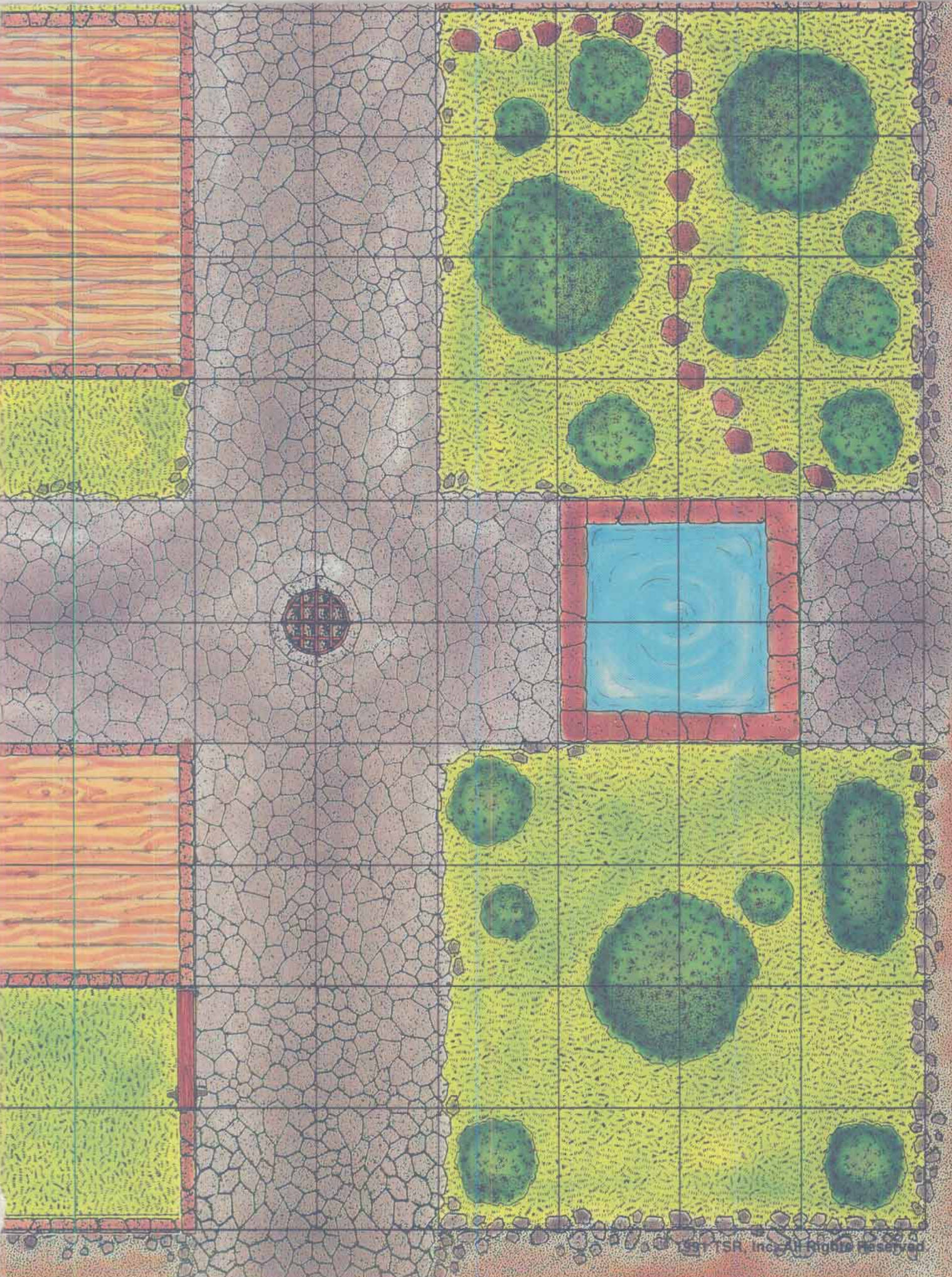







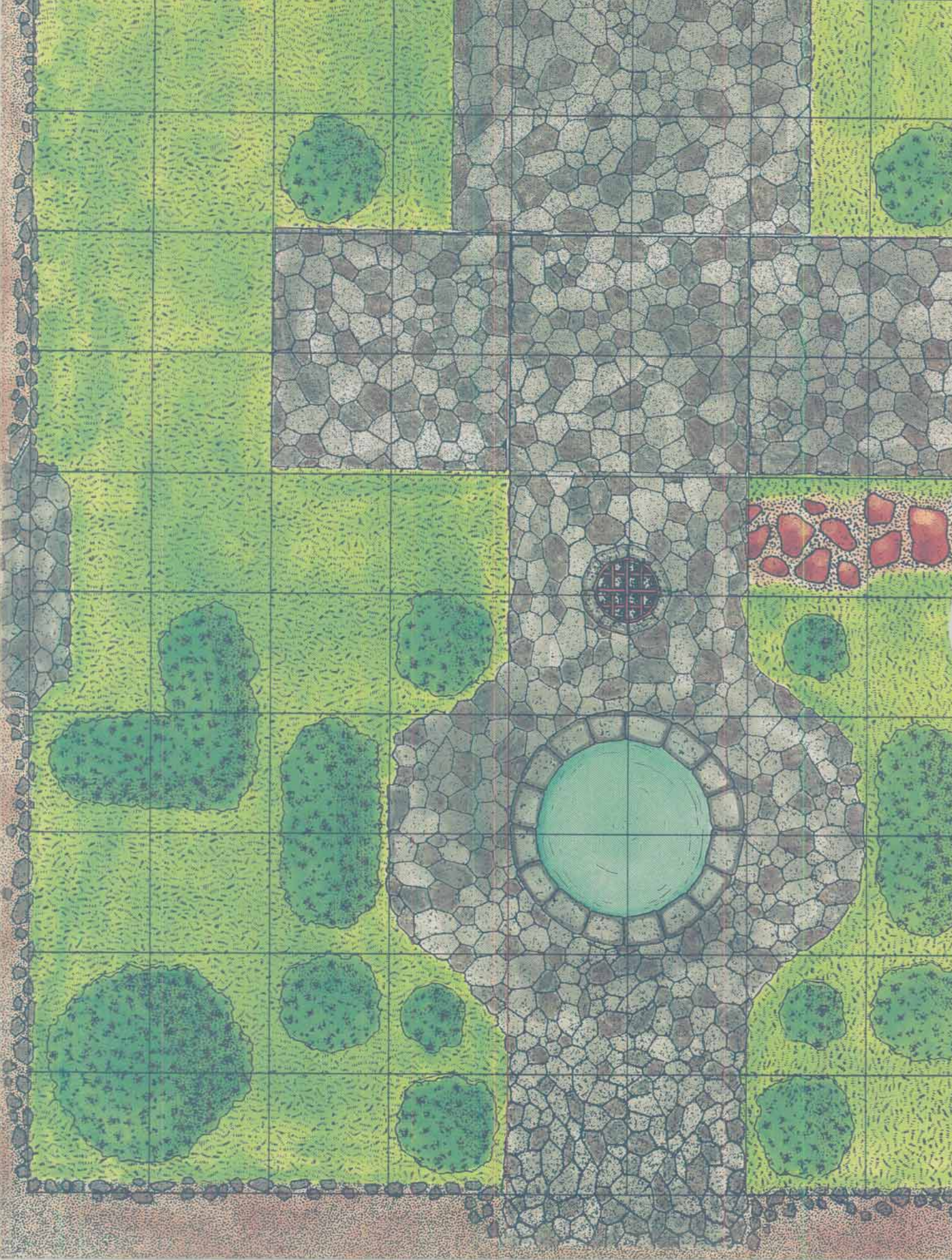

R



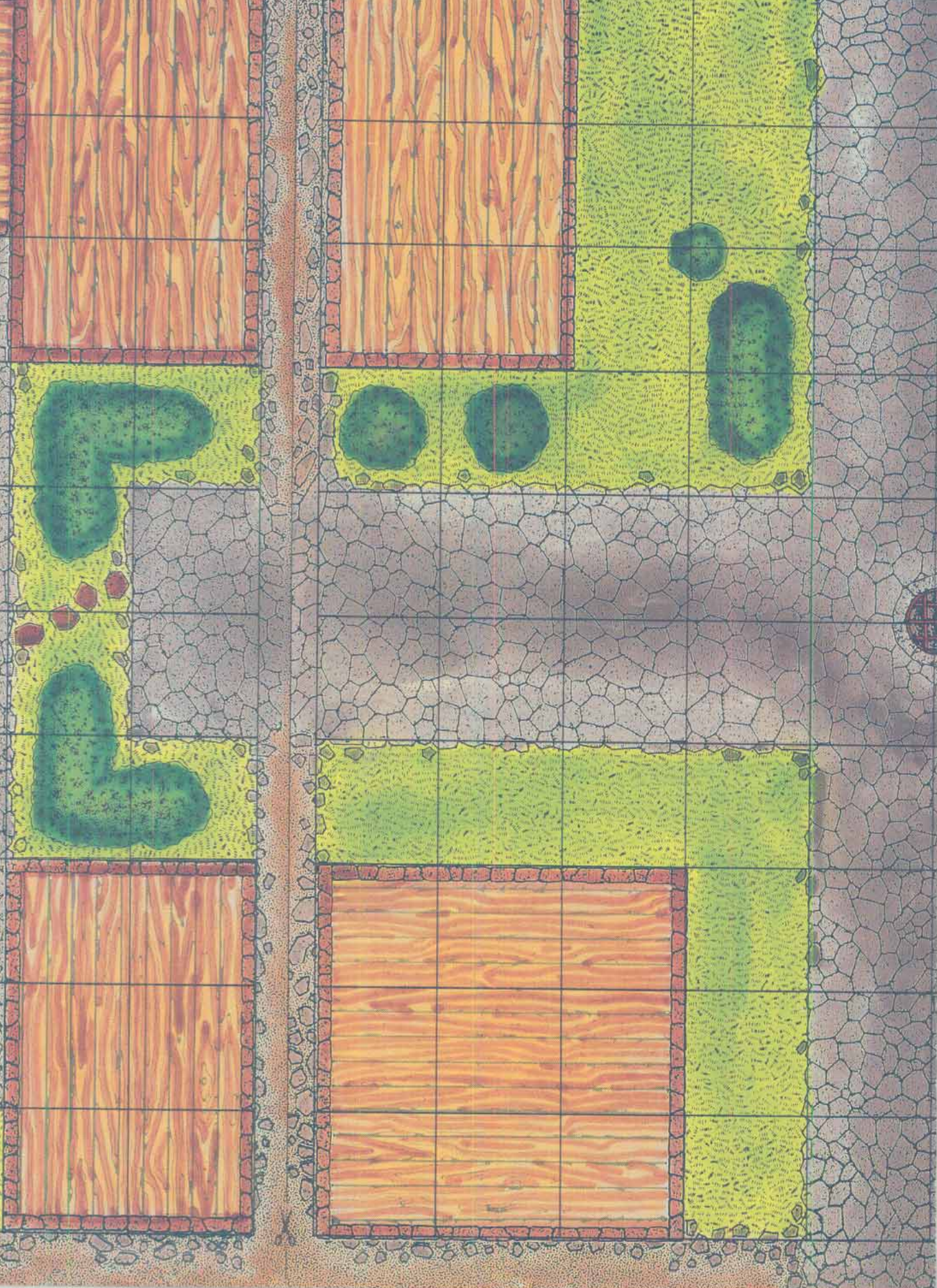

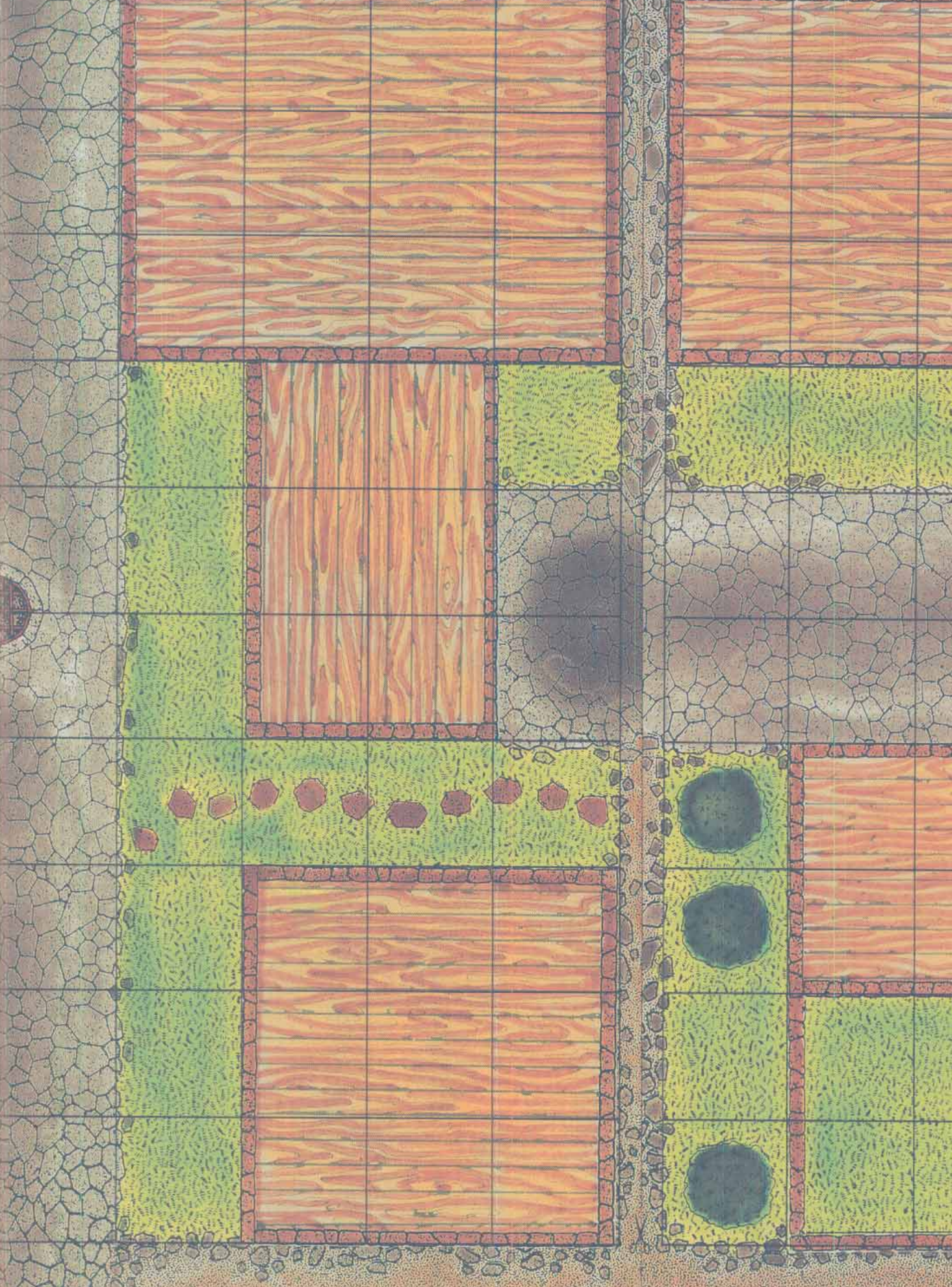

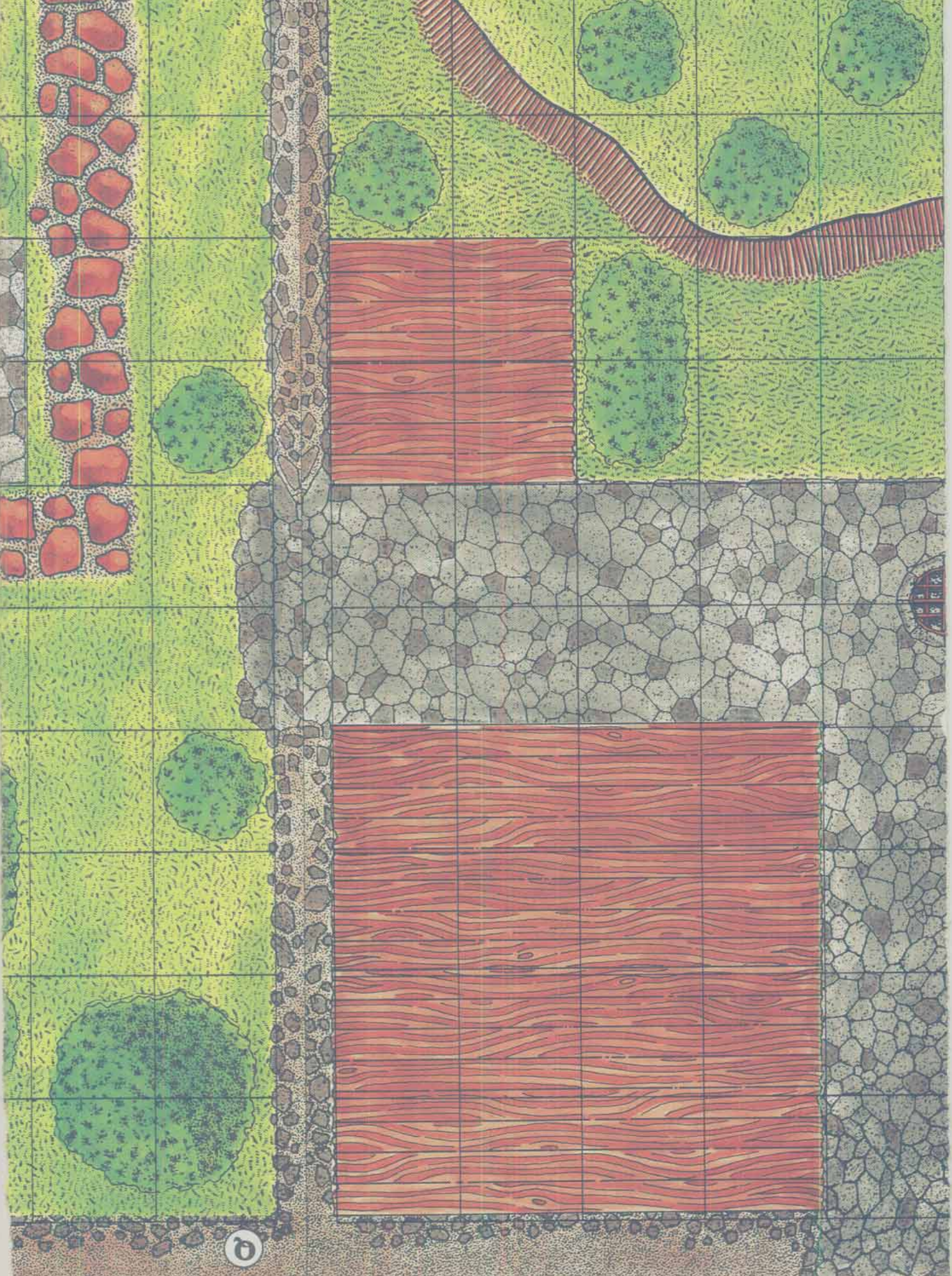

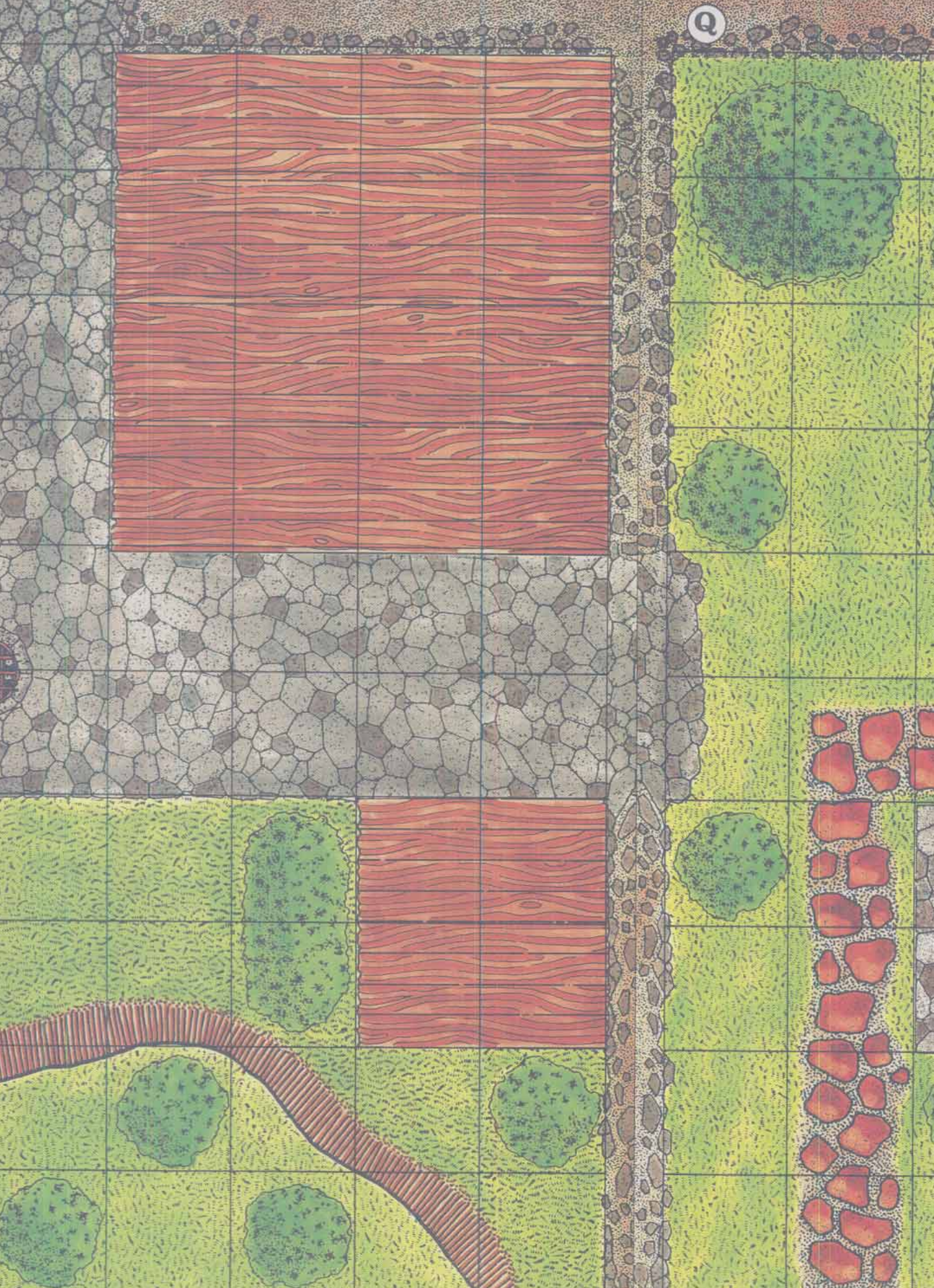

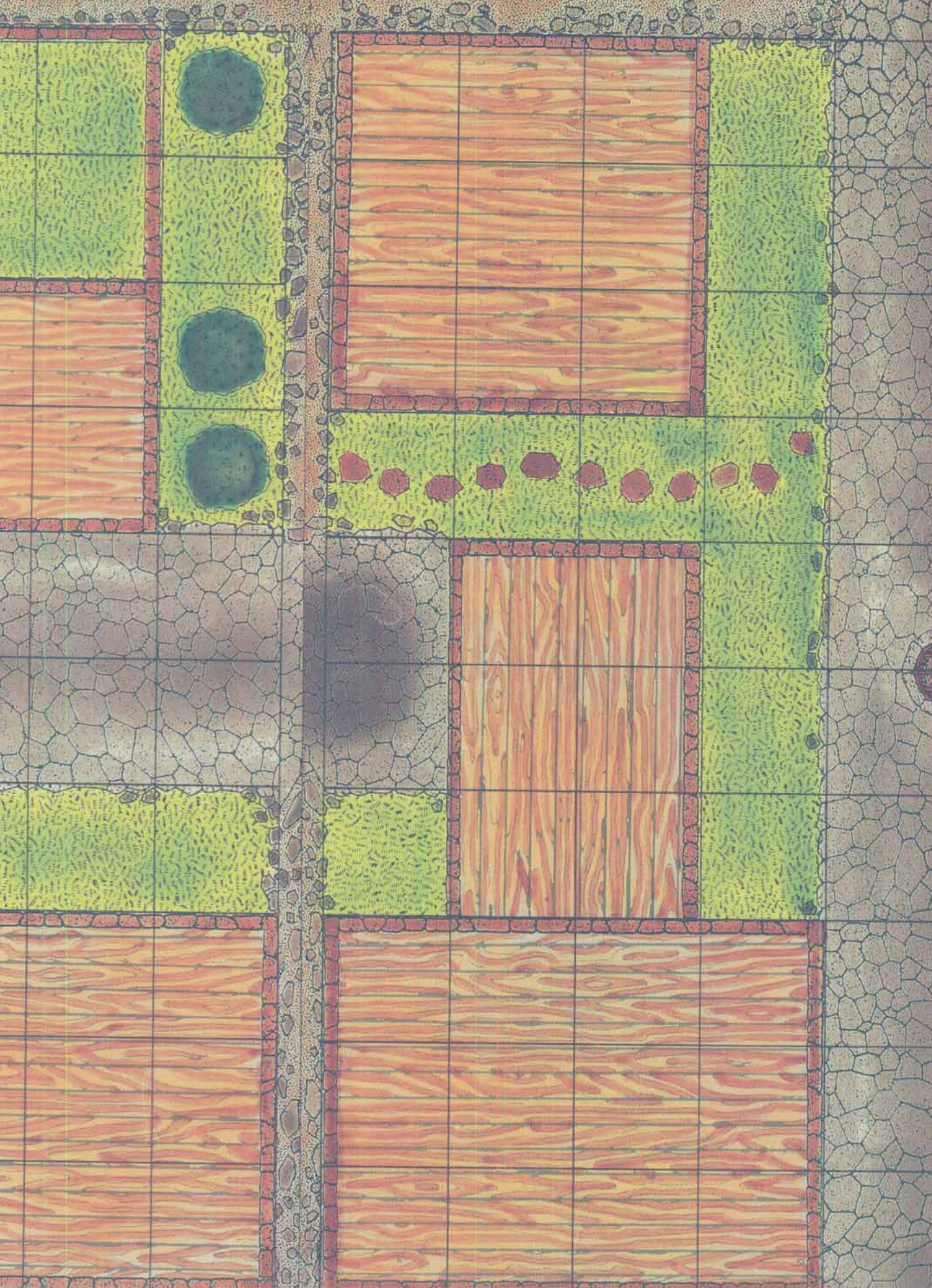







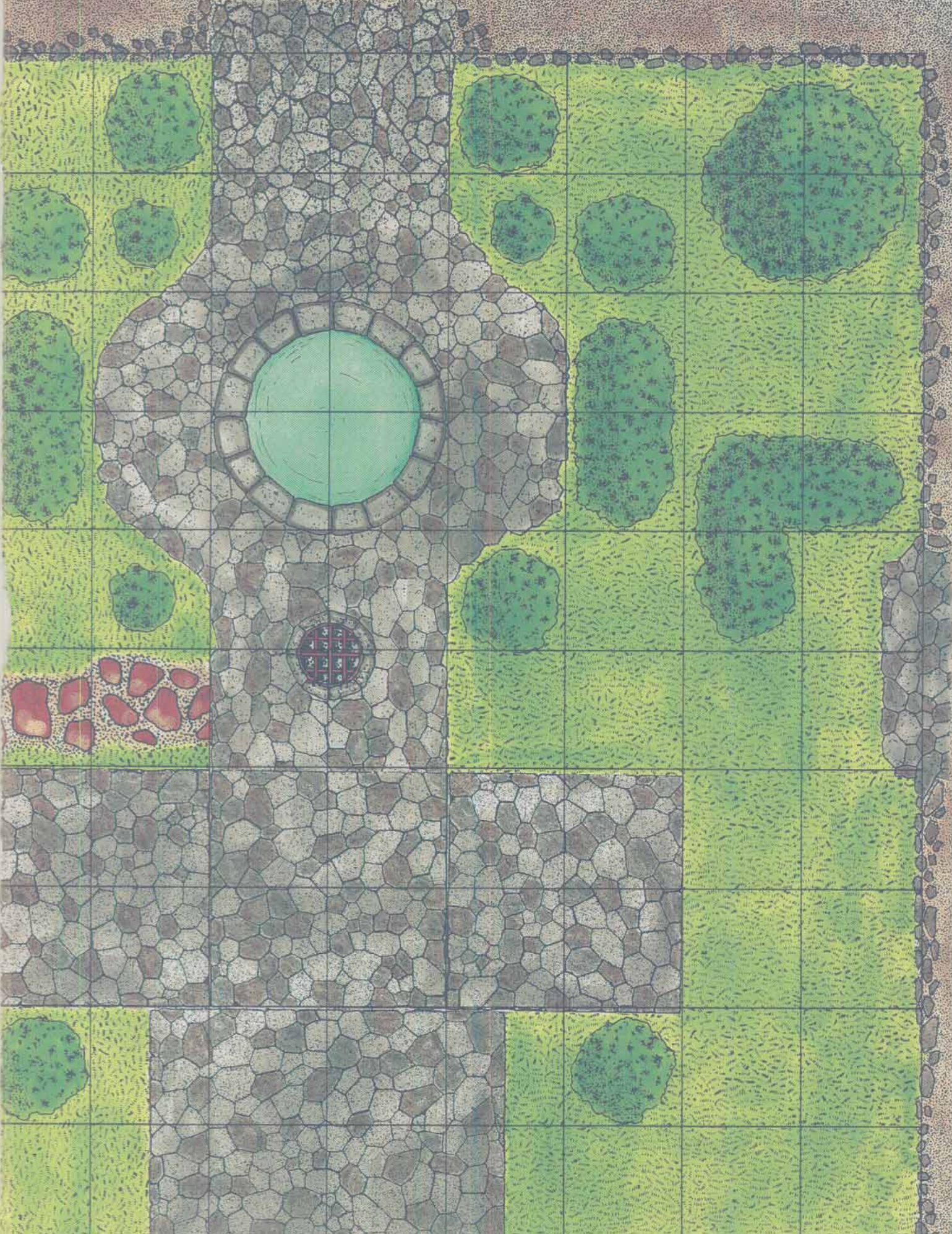

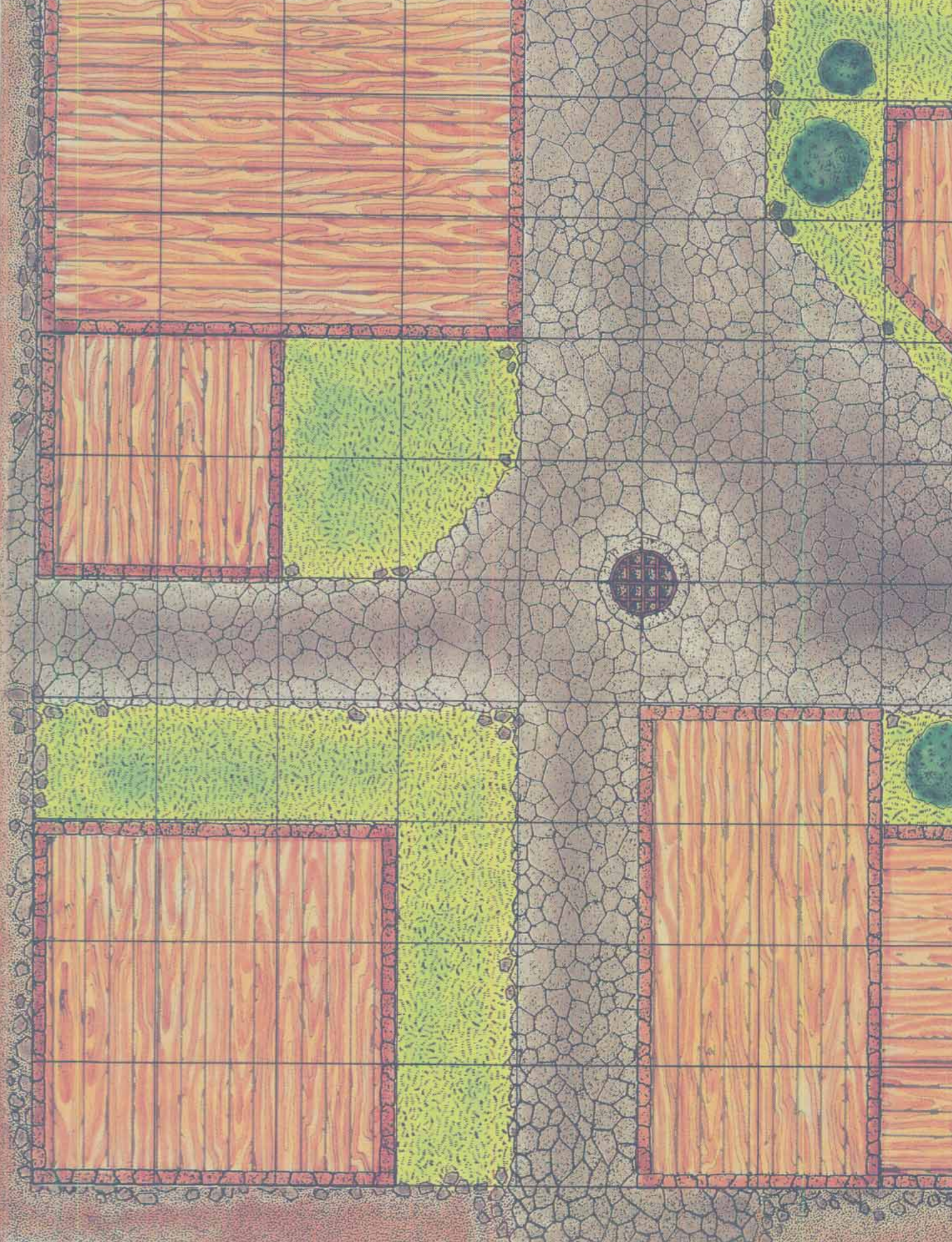

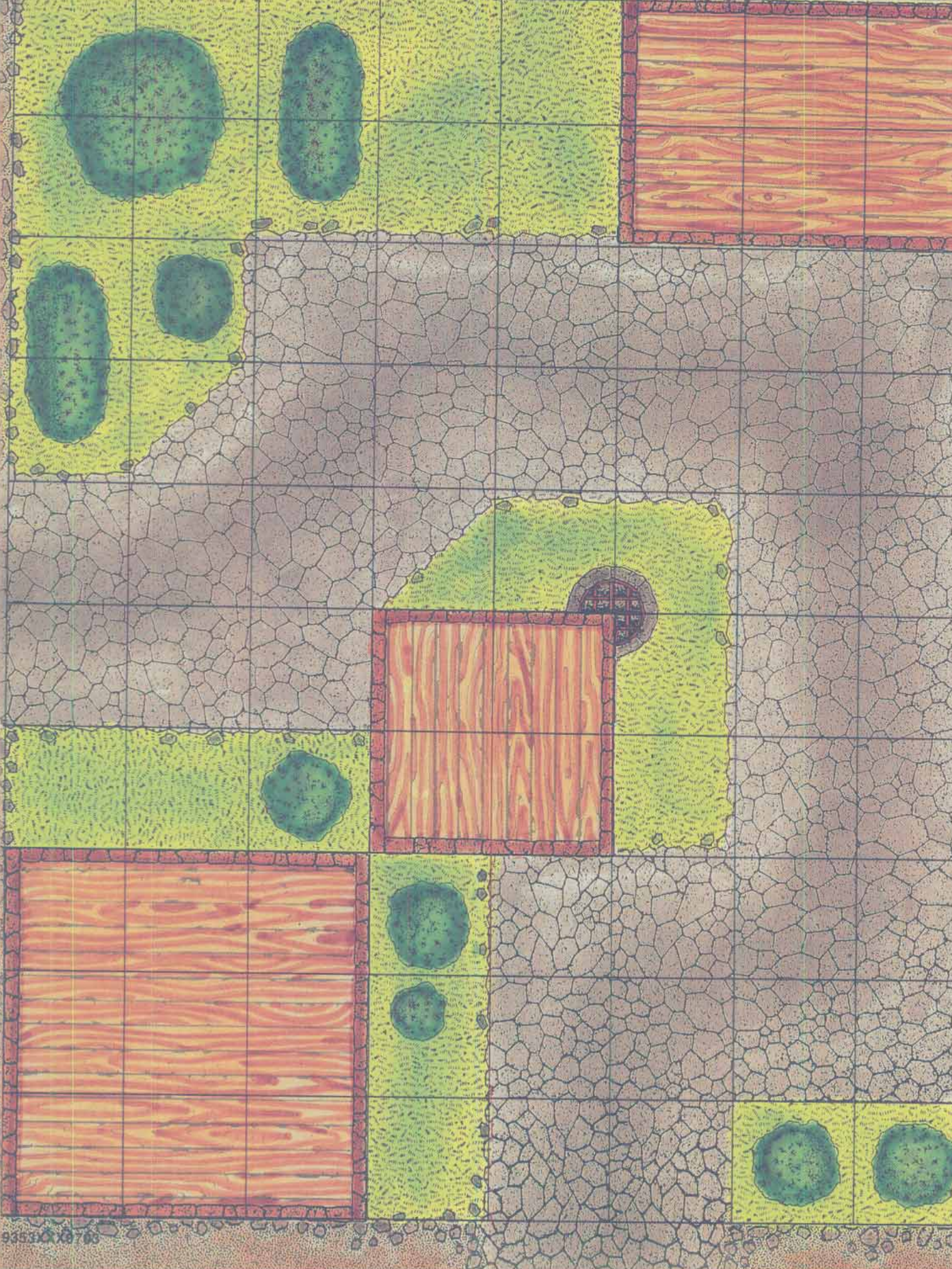

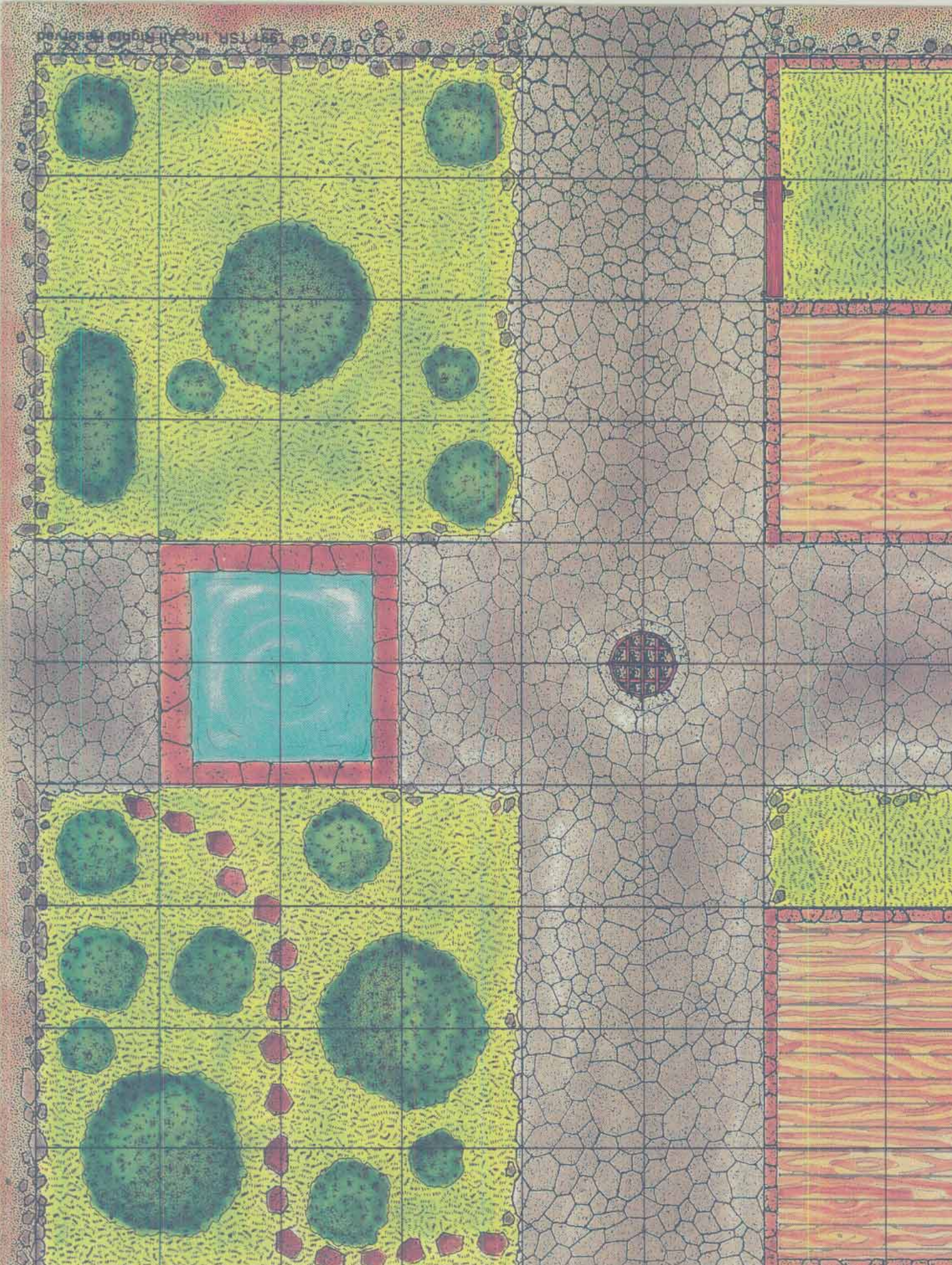

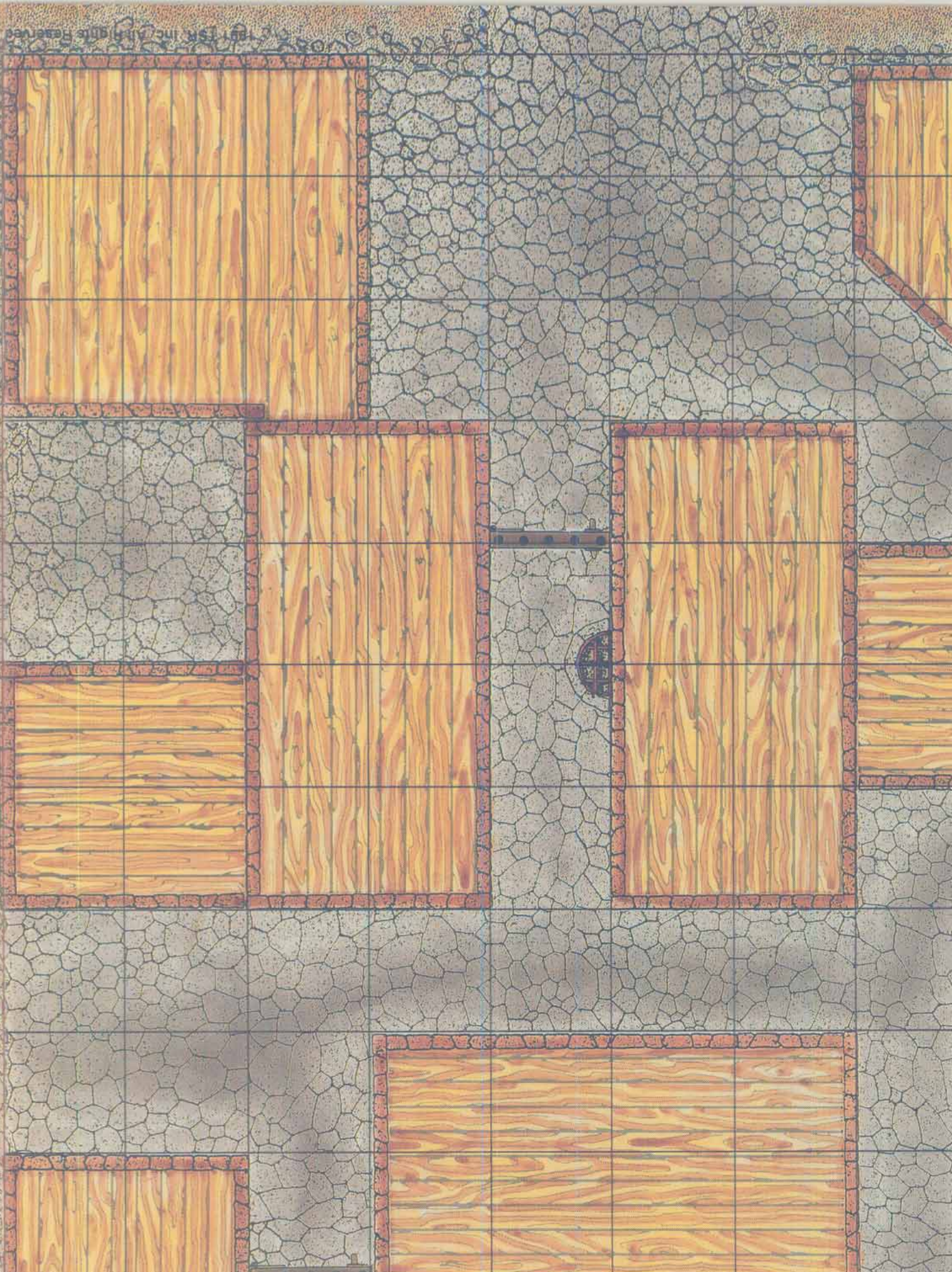

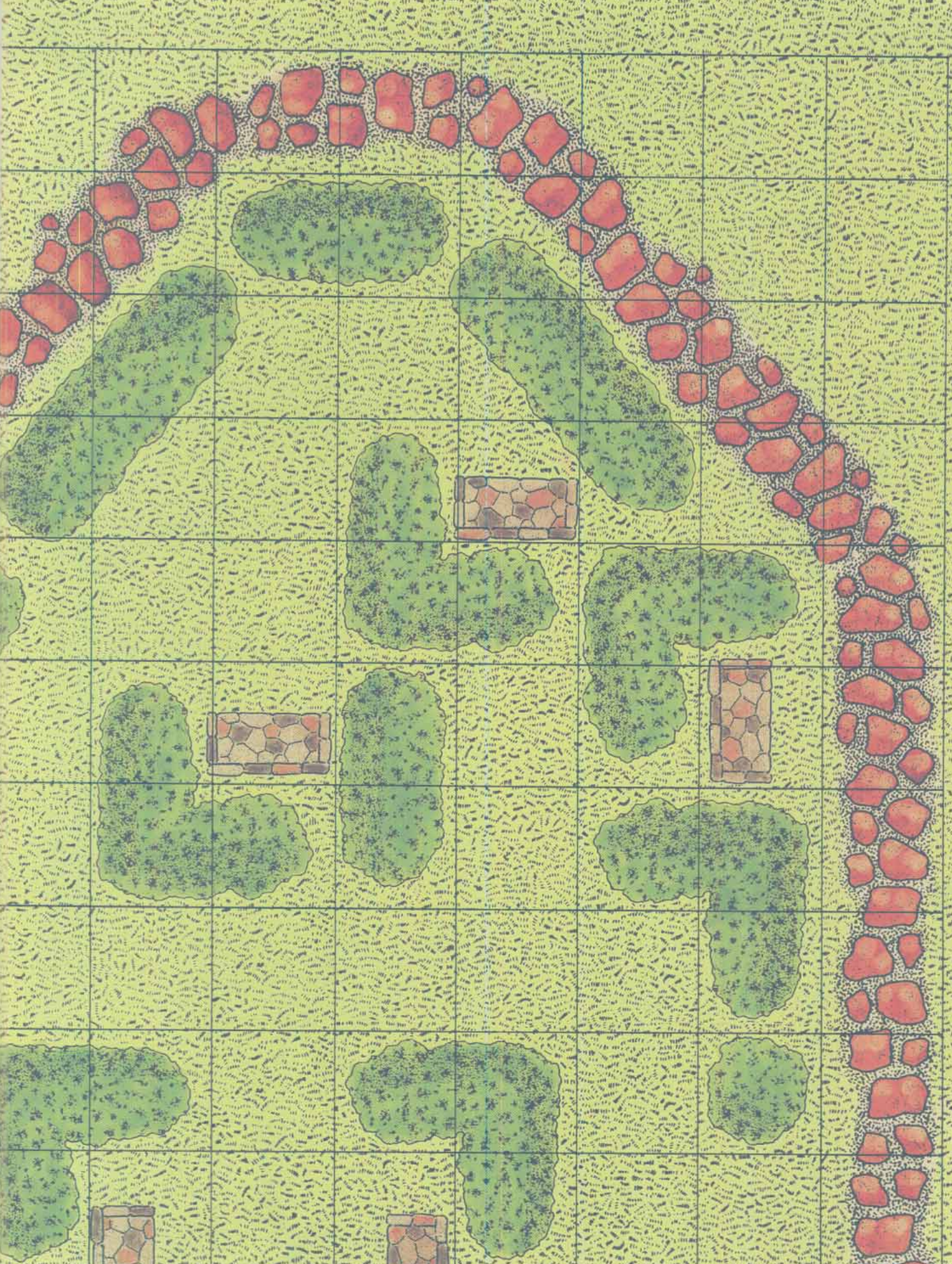

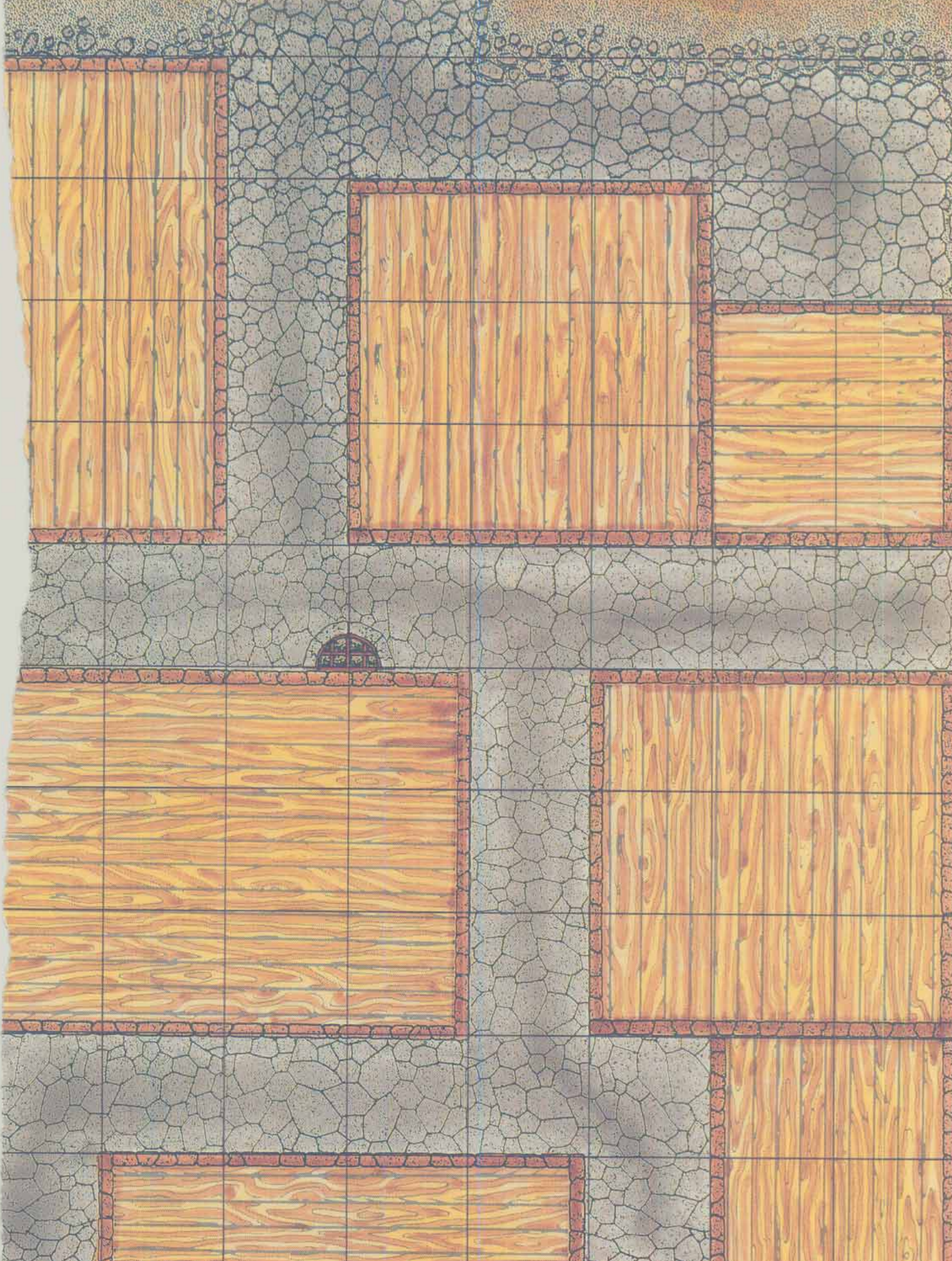



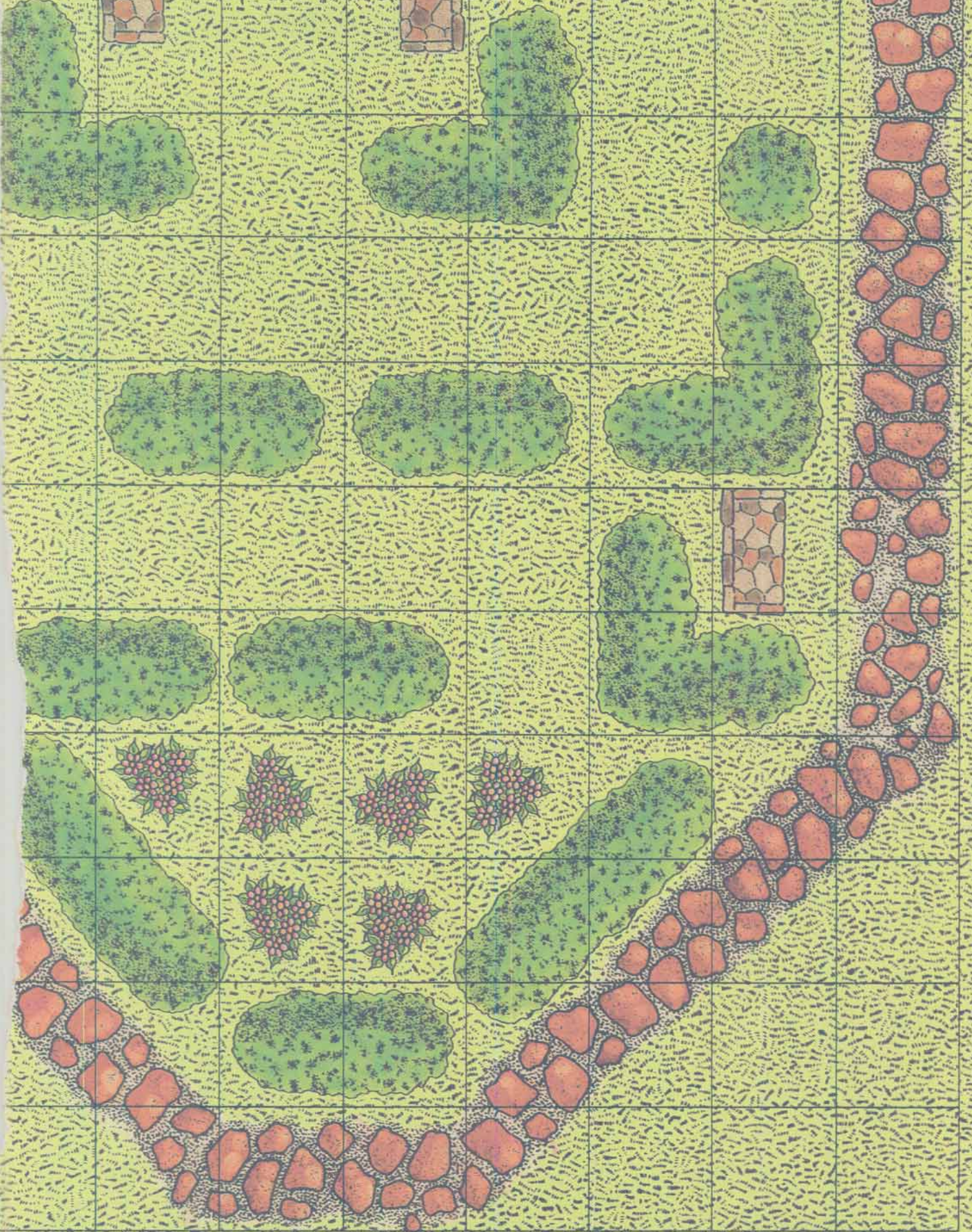

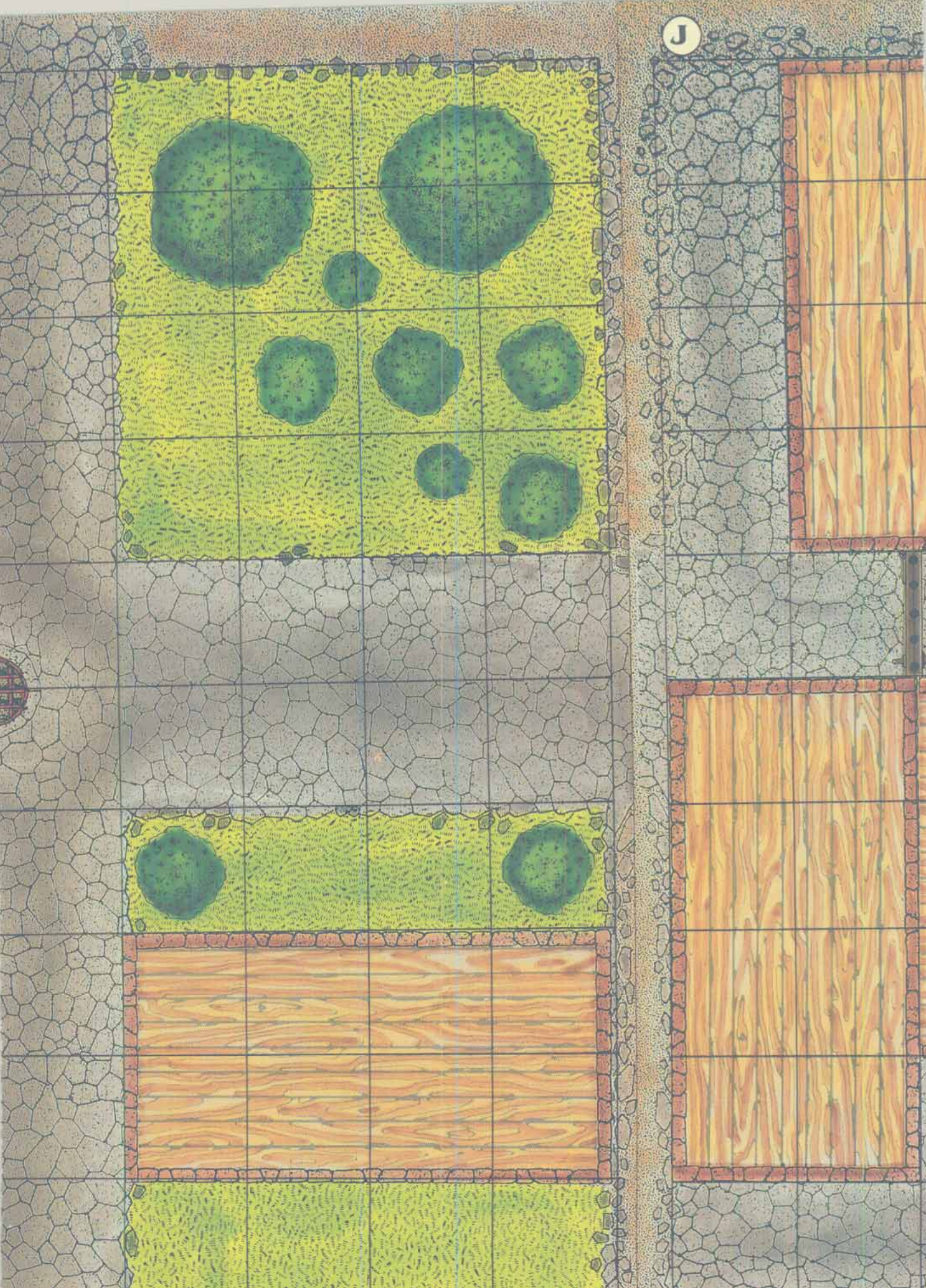

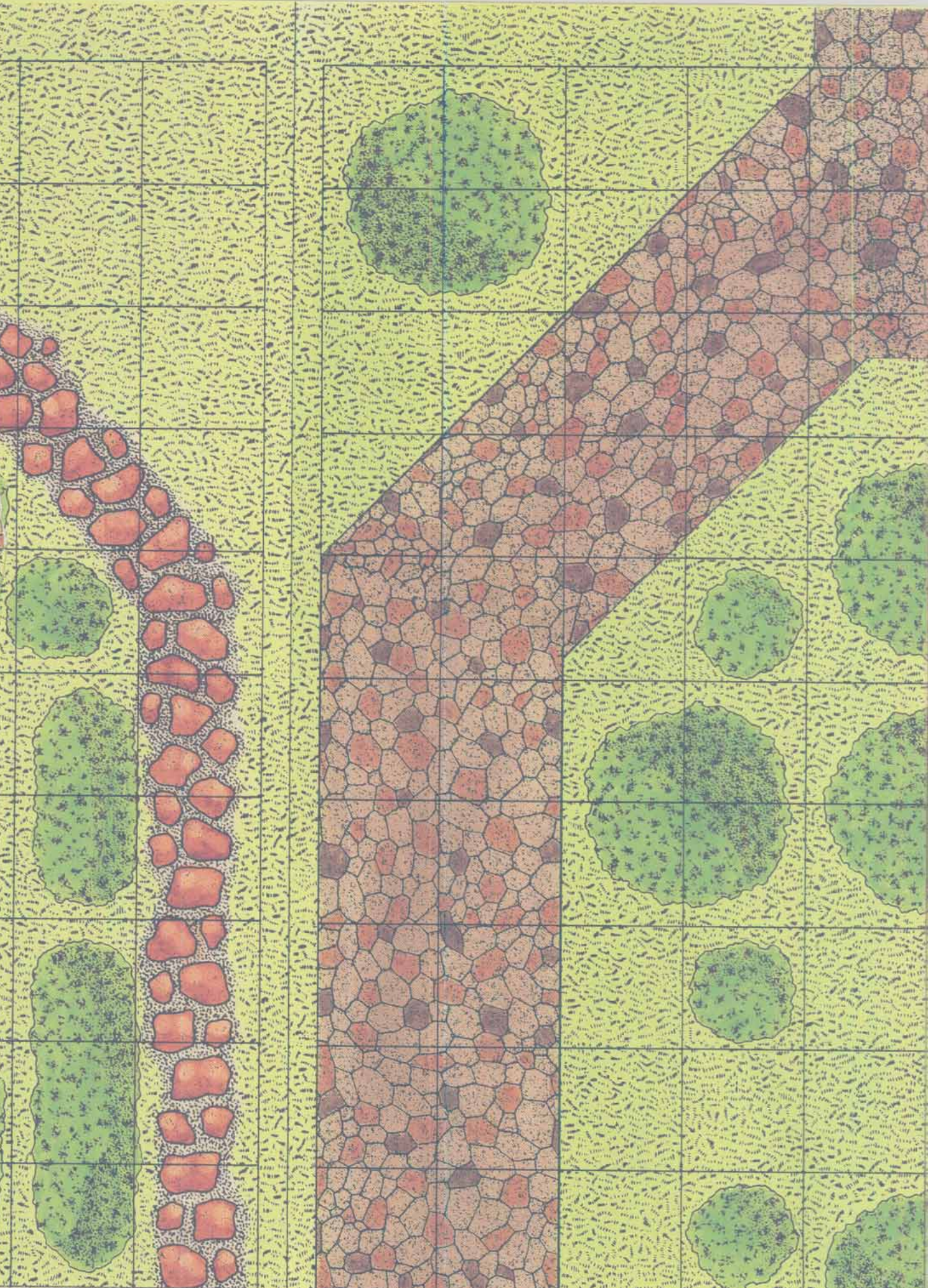



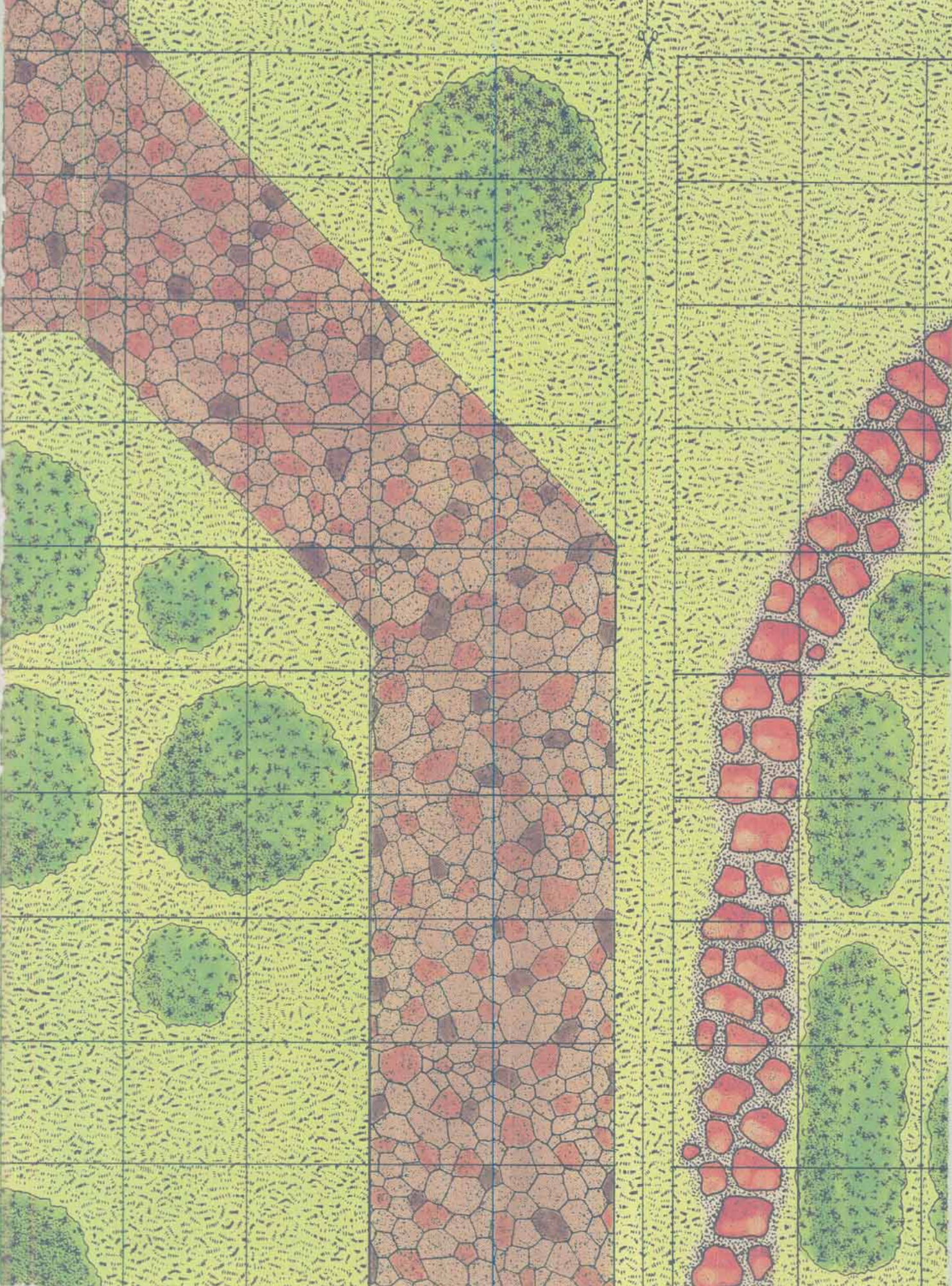

E

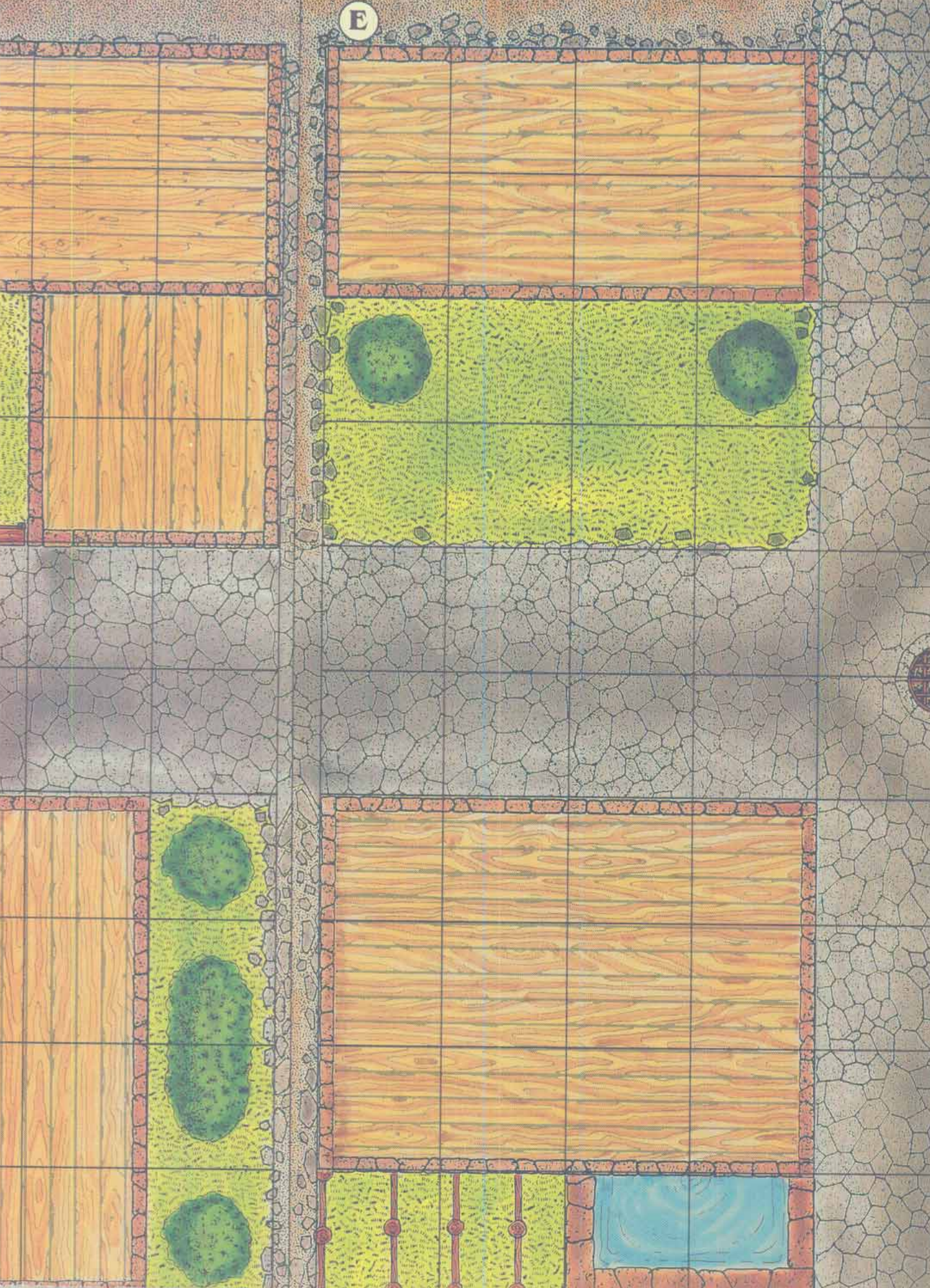

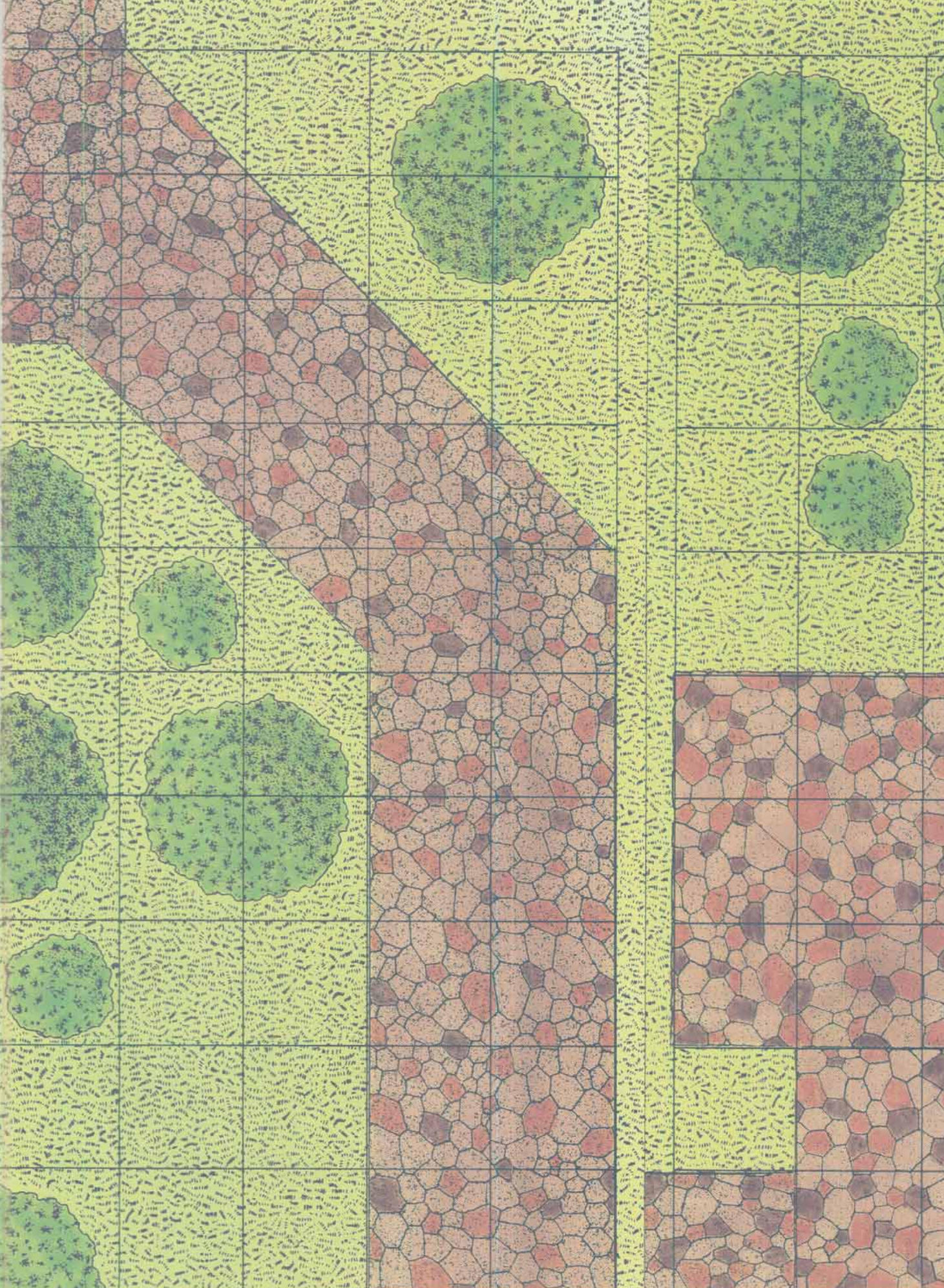





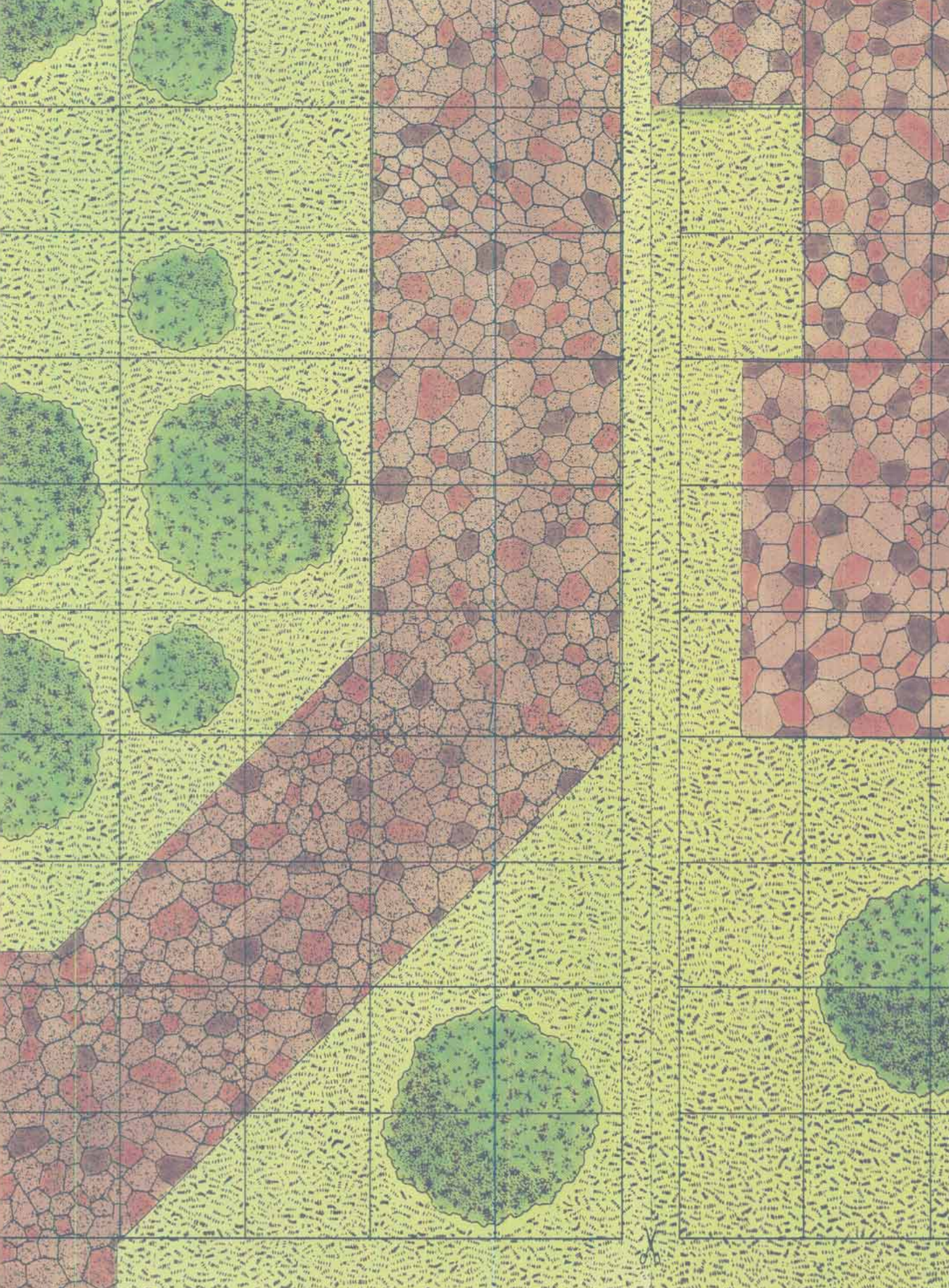

A

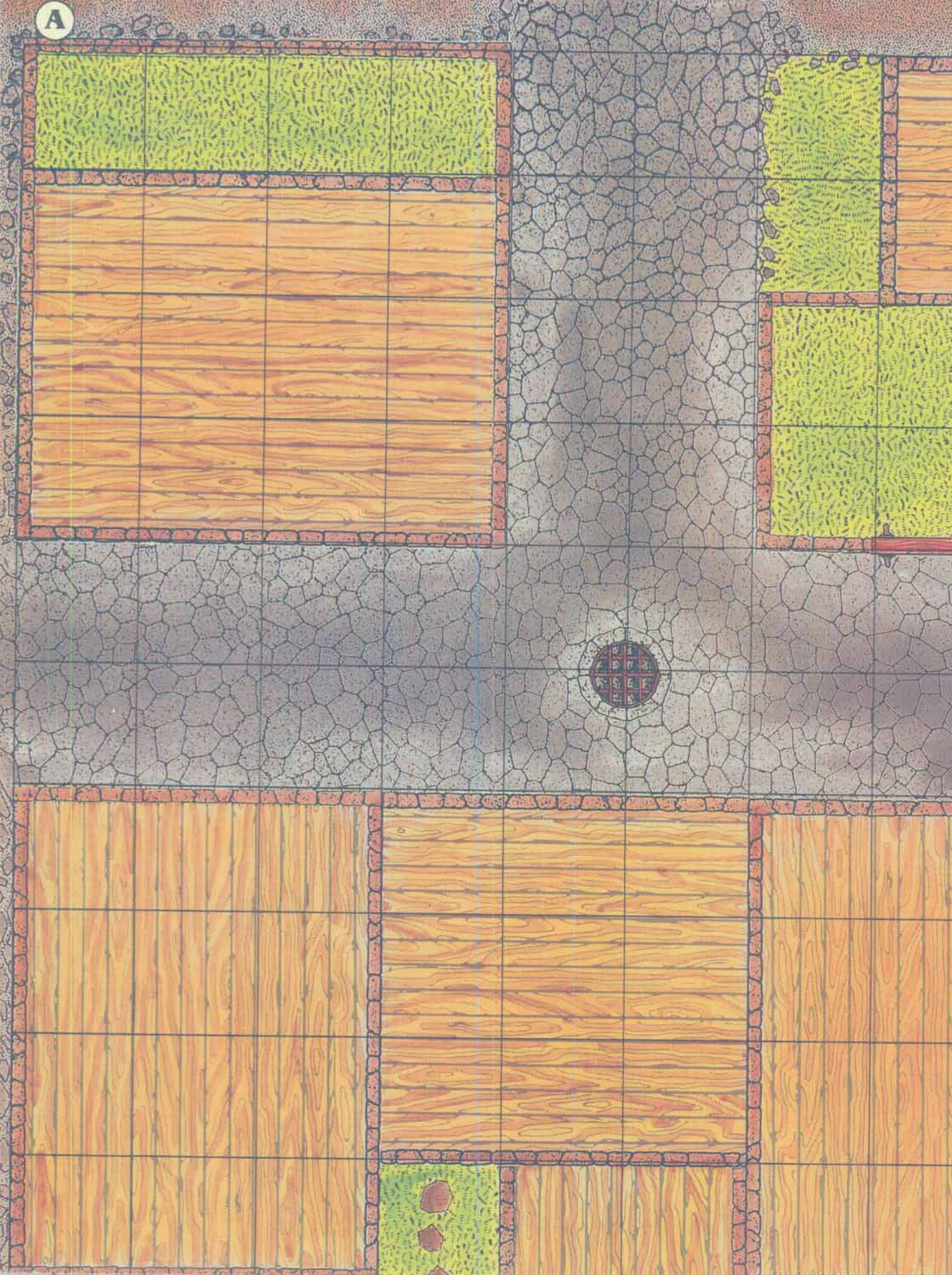

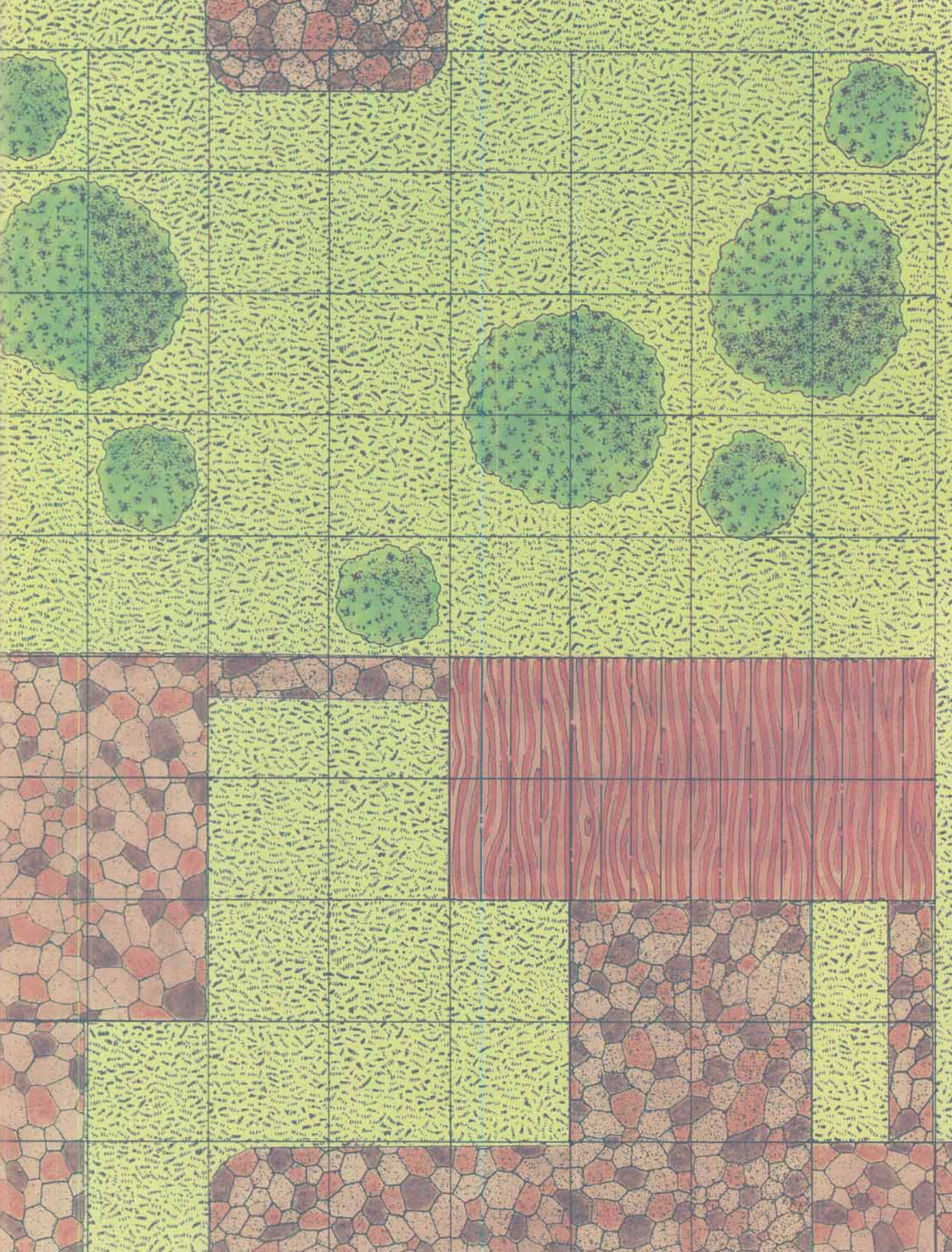



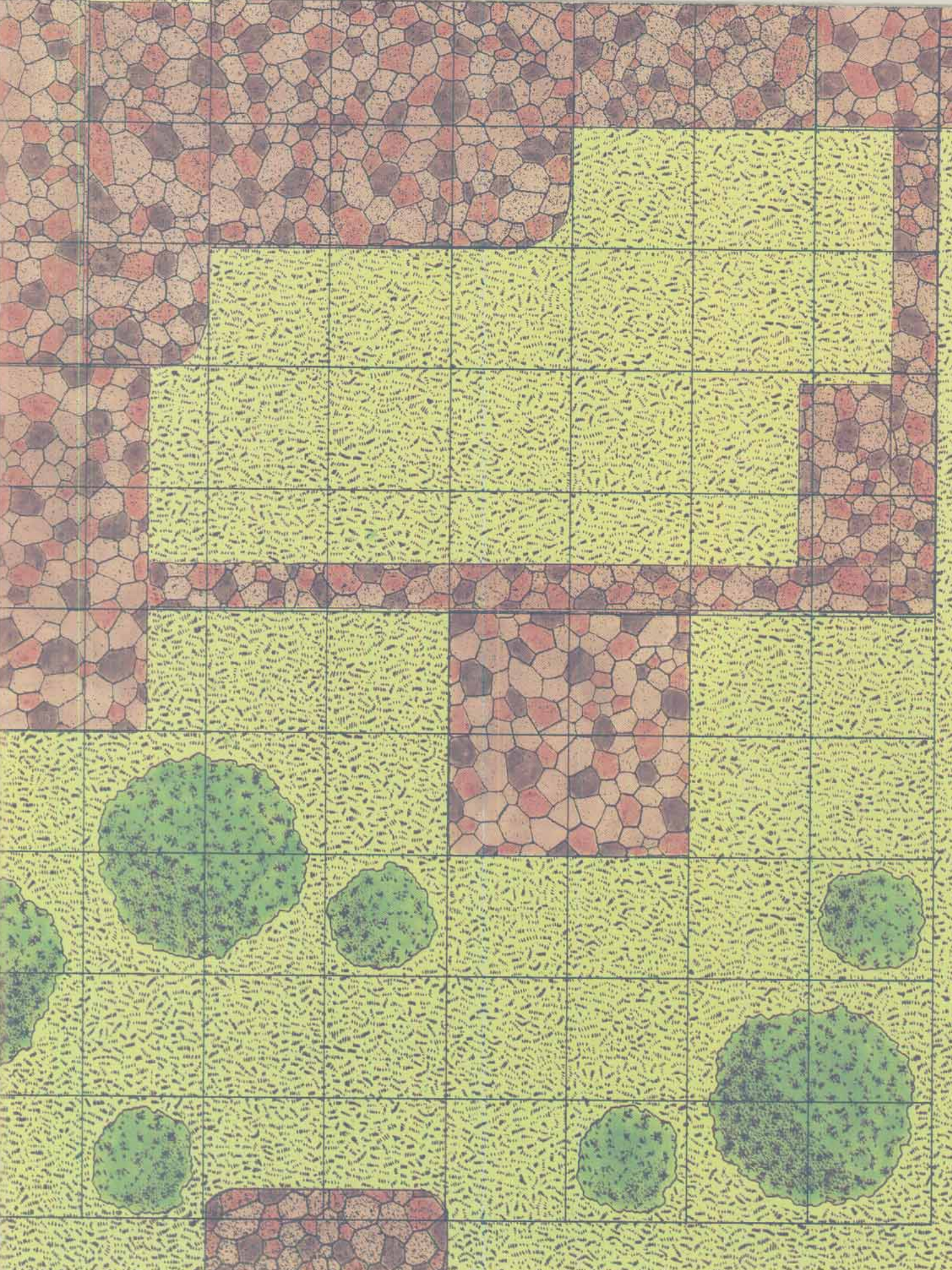



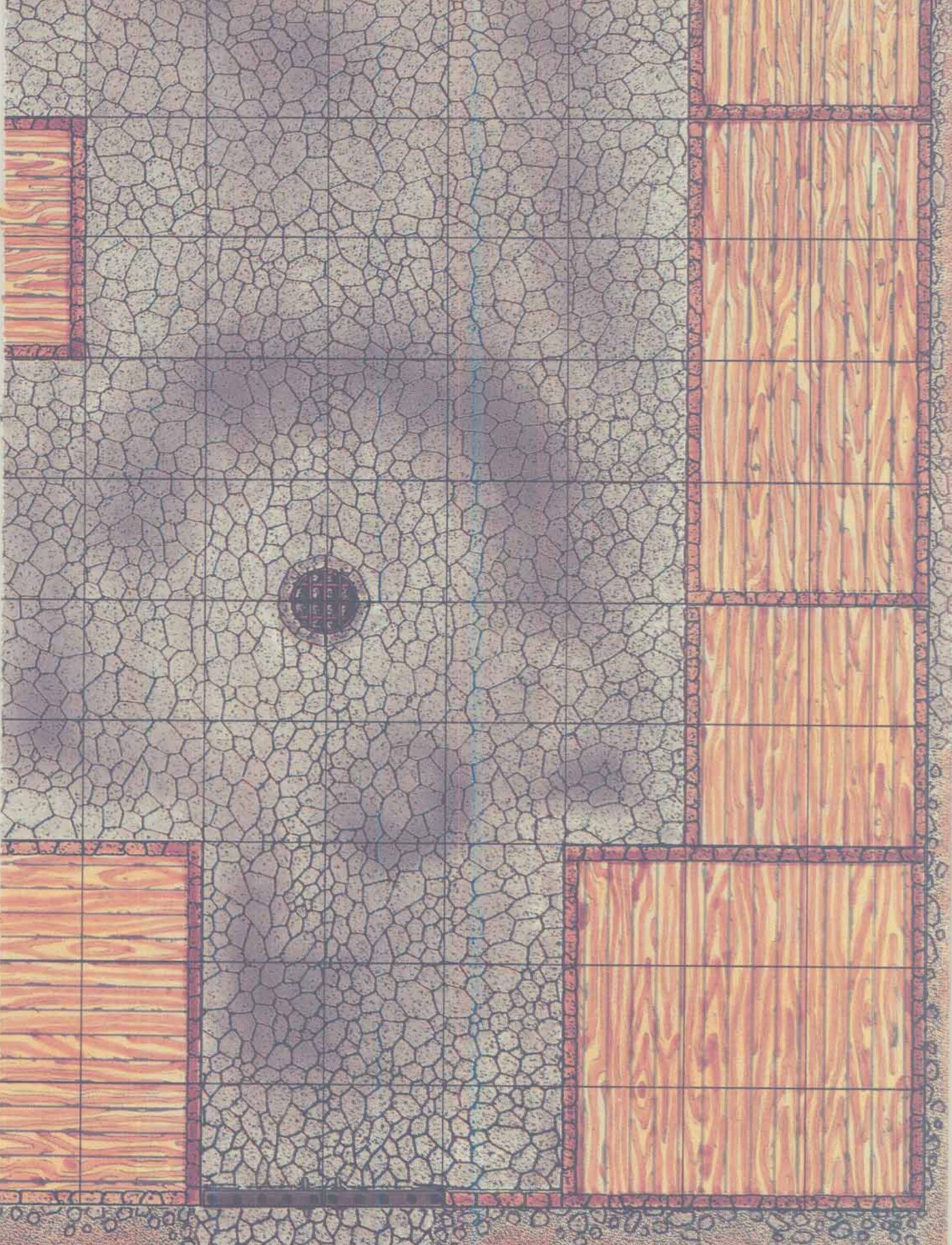





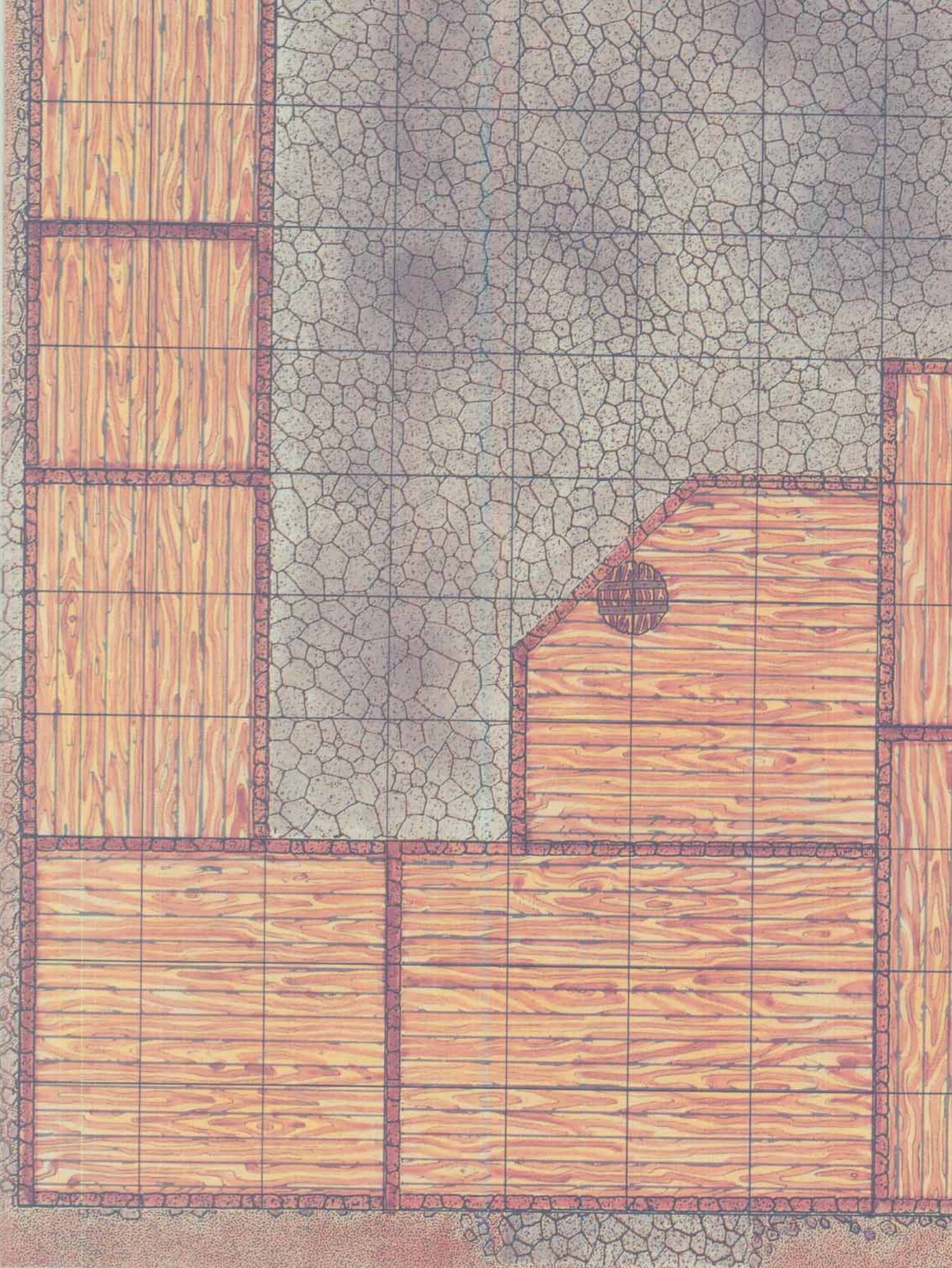

G

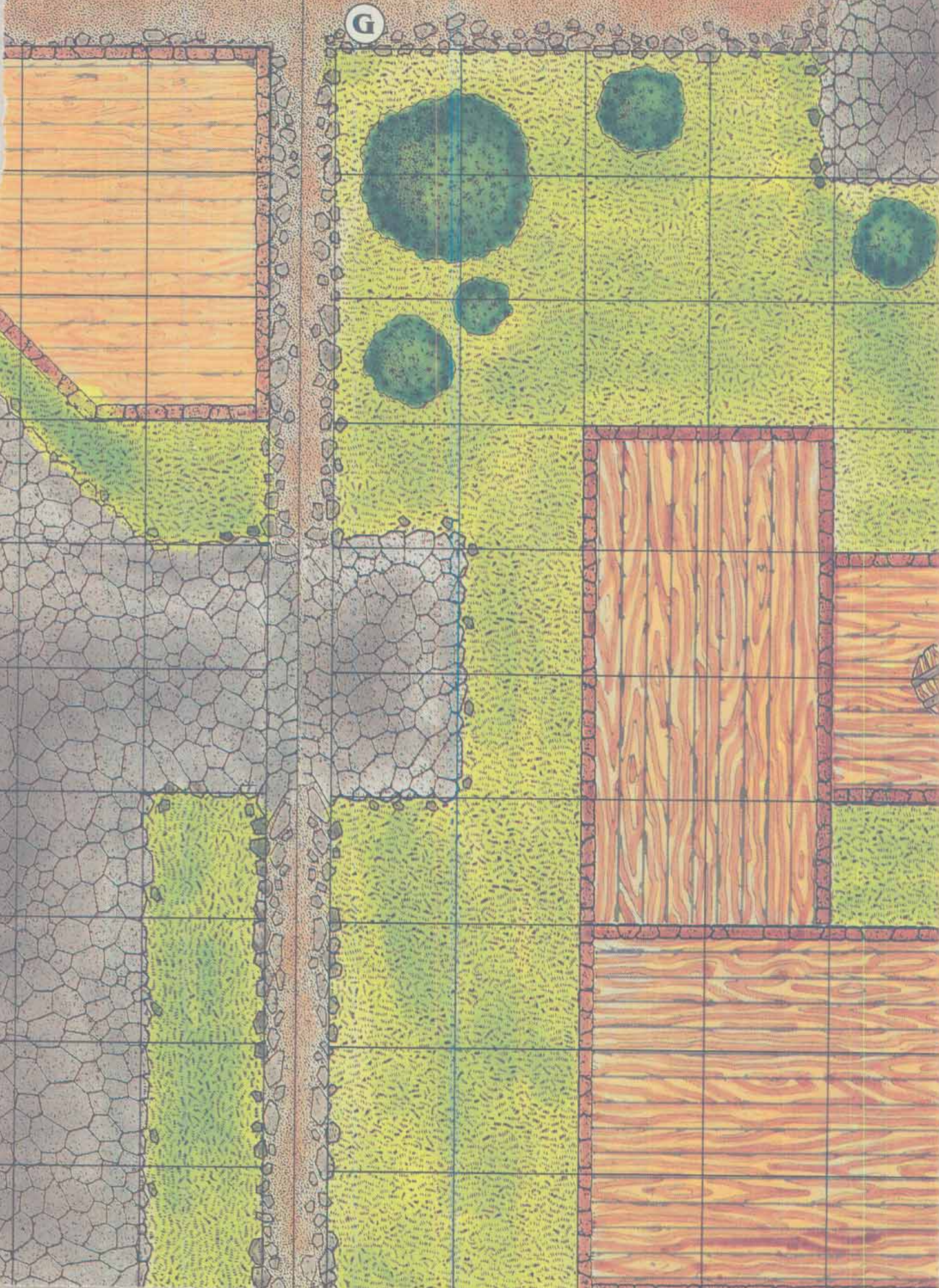

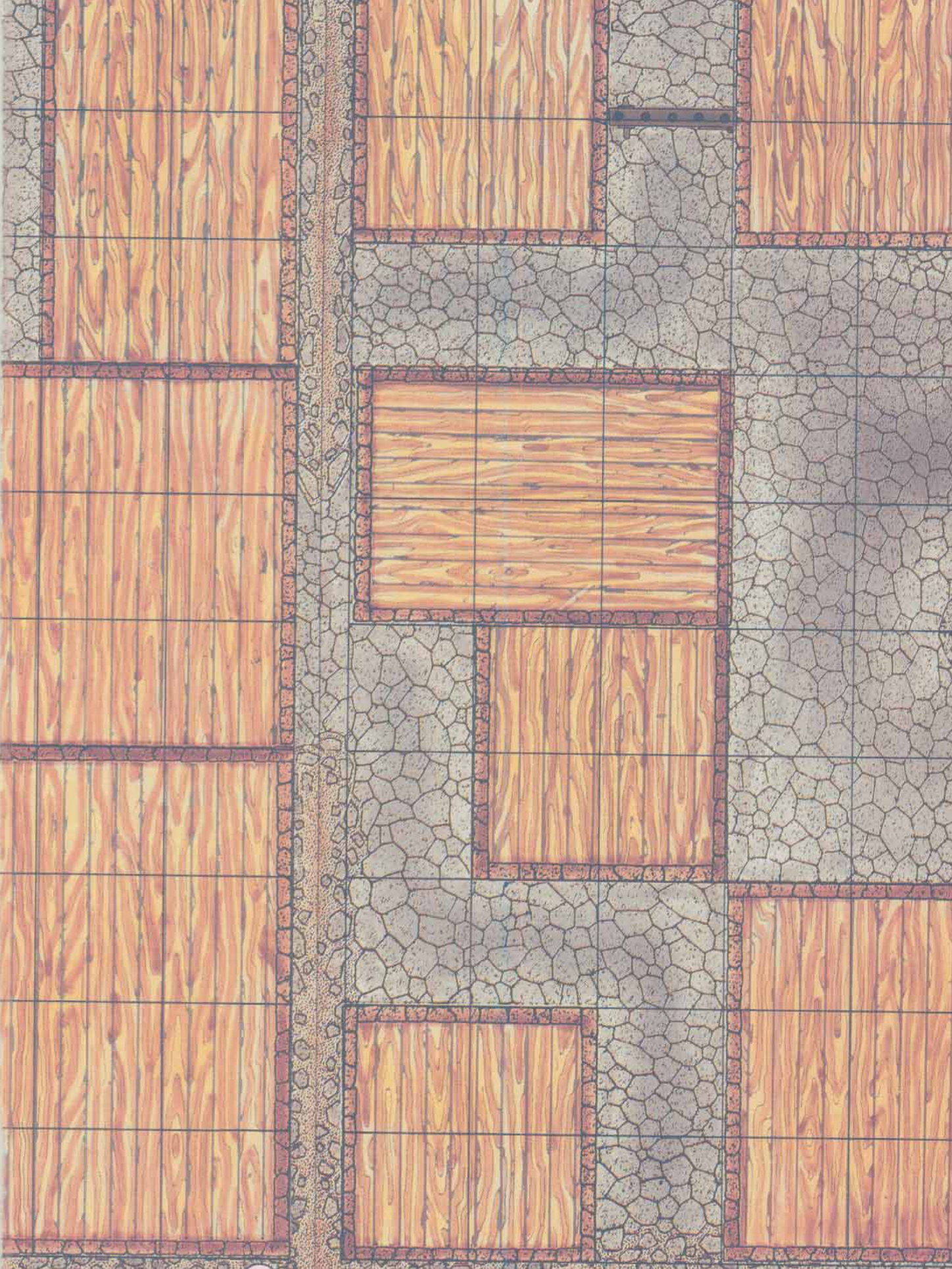

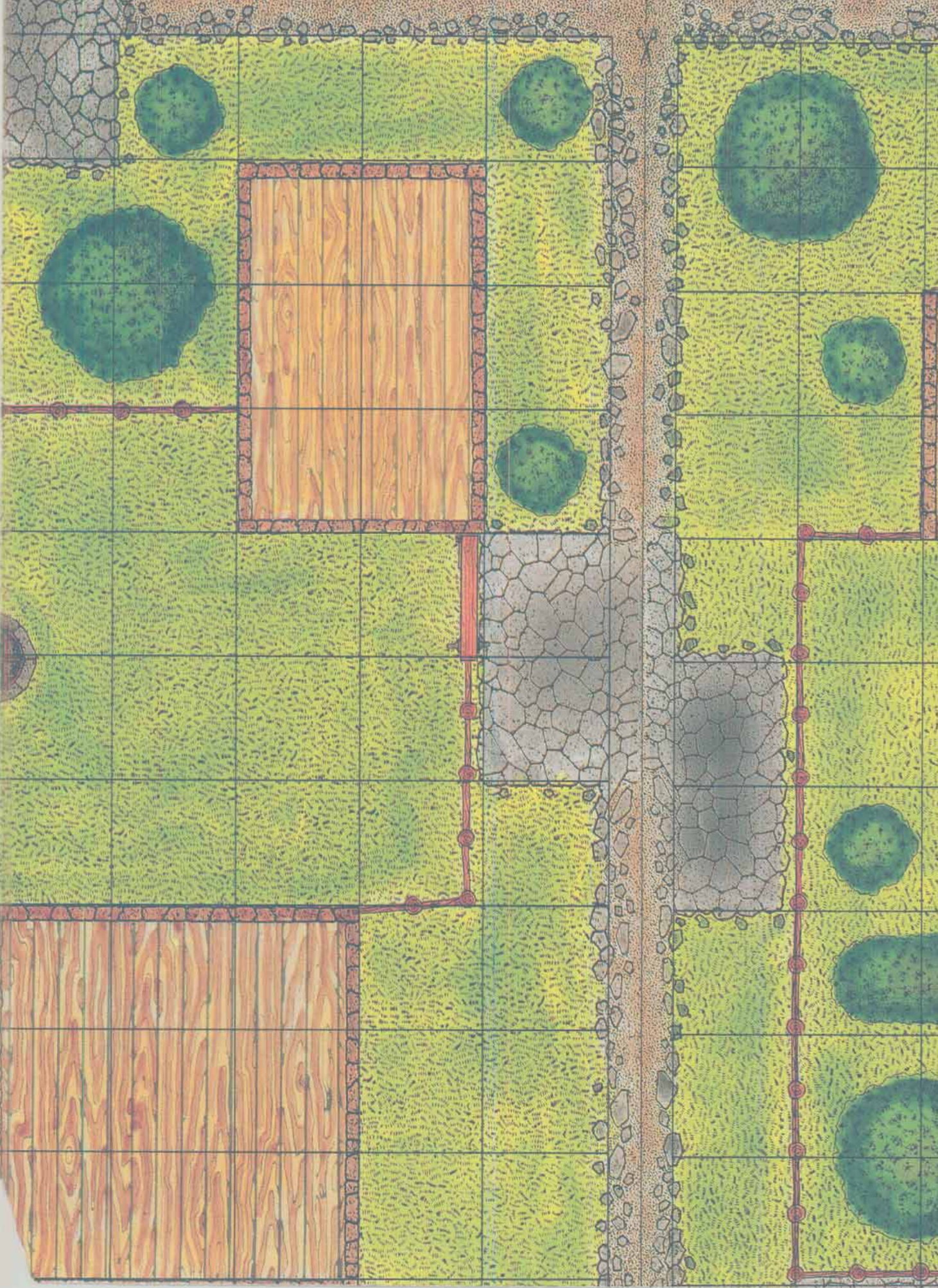

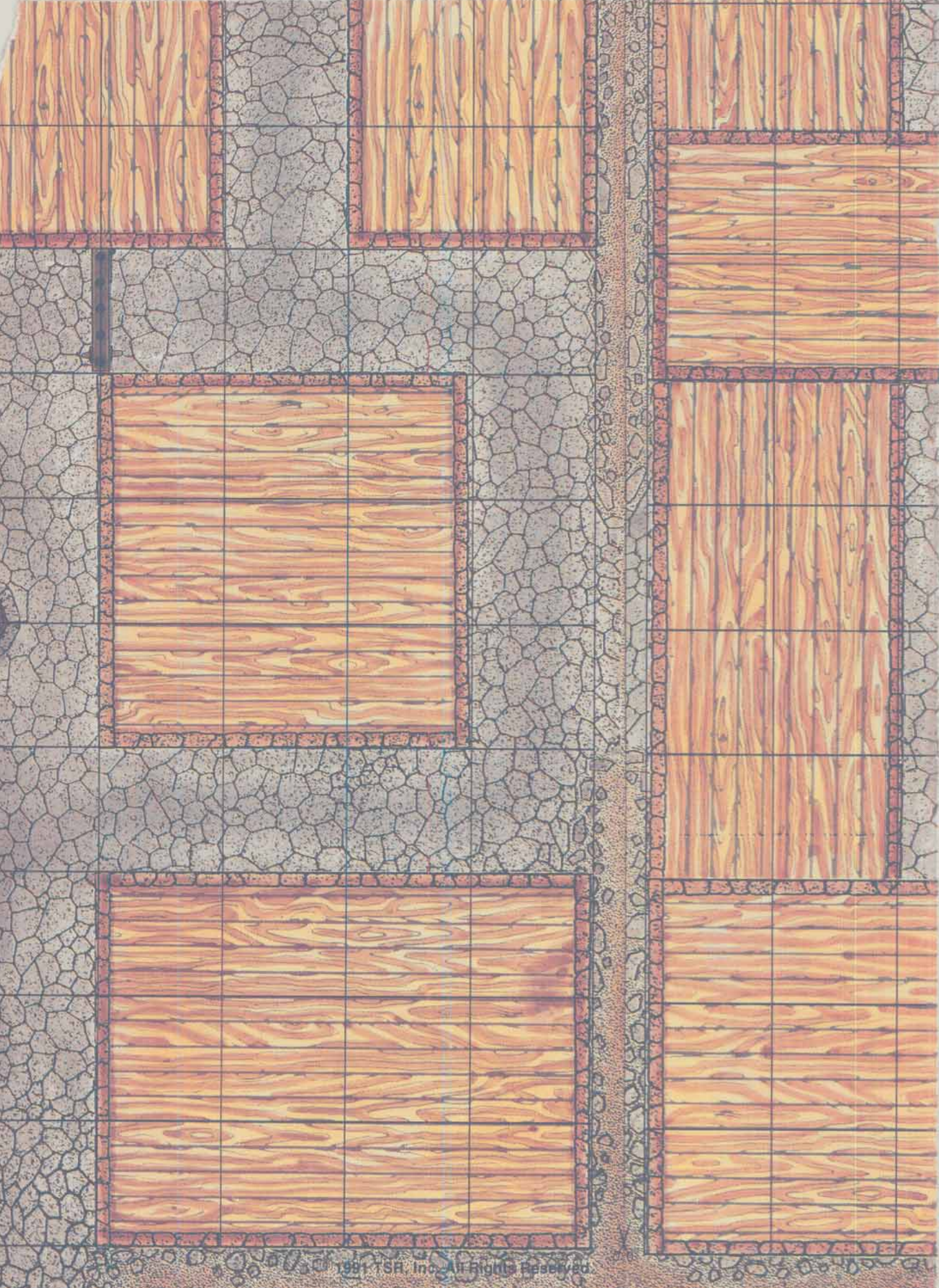

B

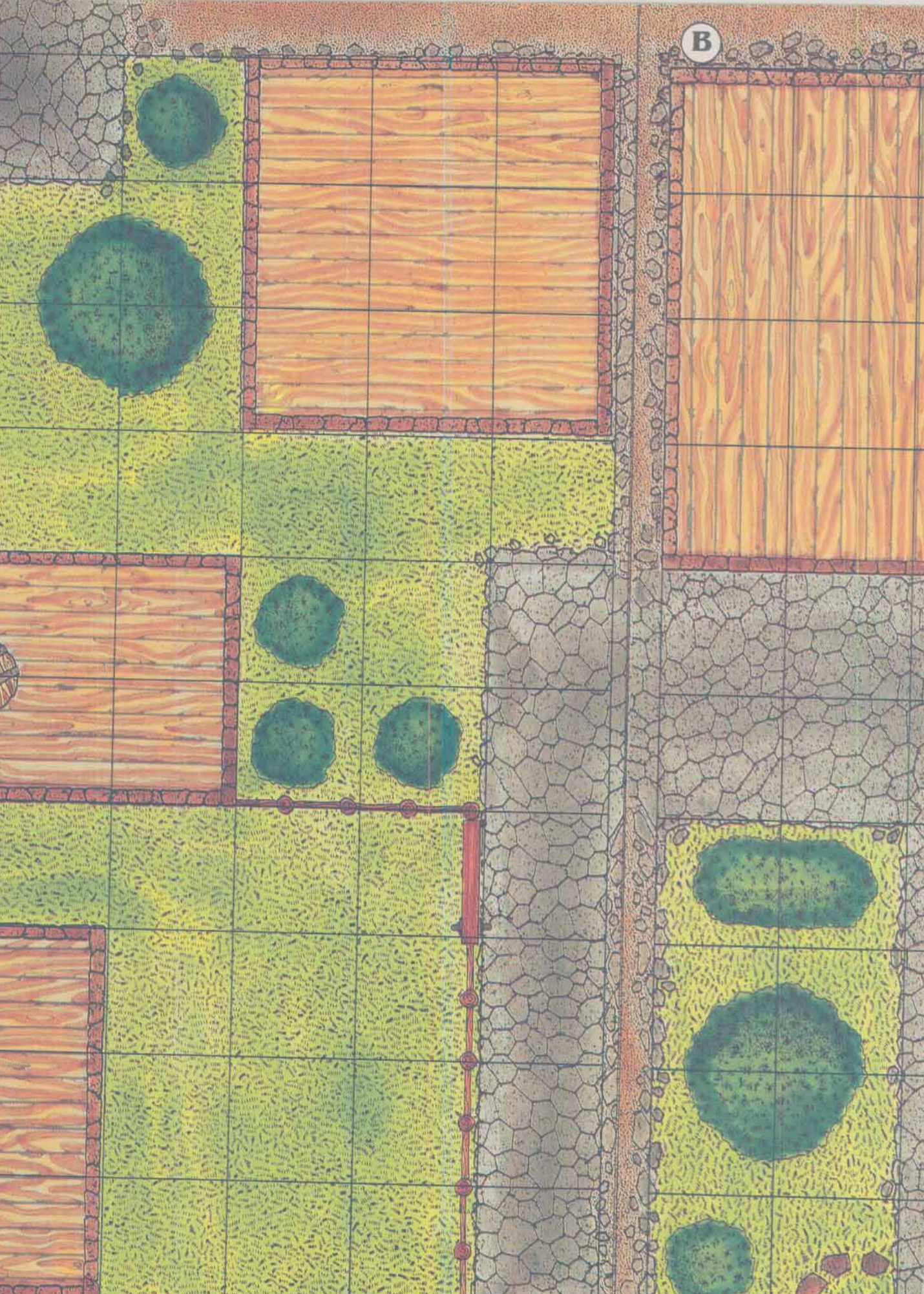

L

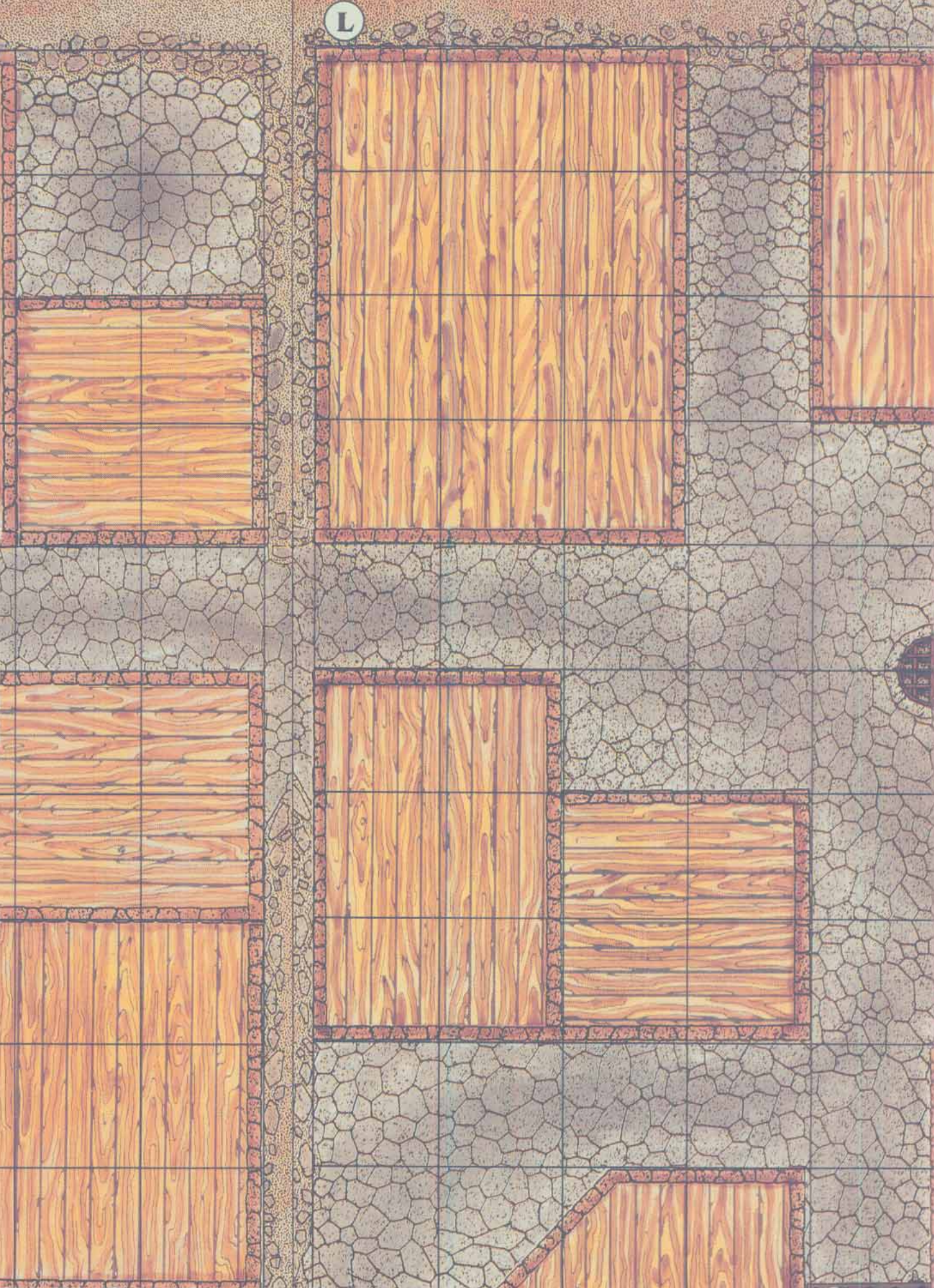





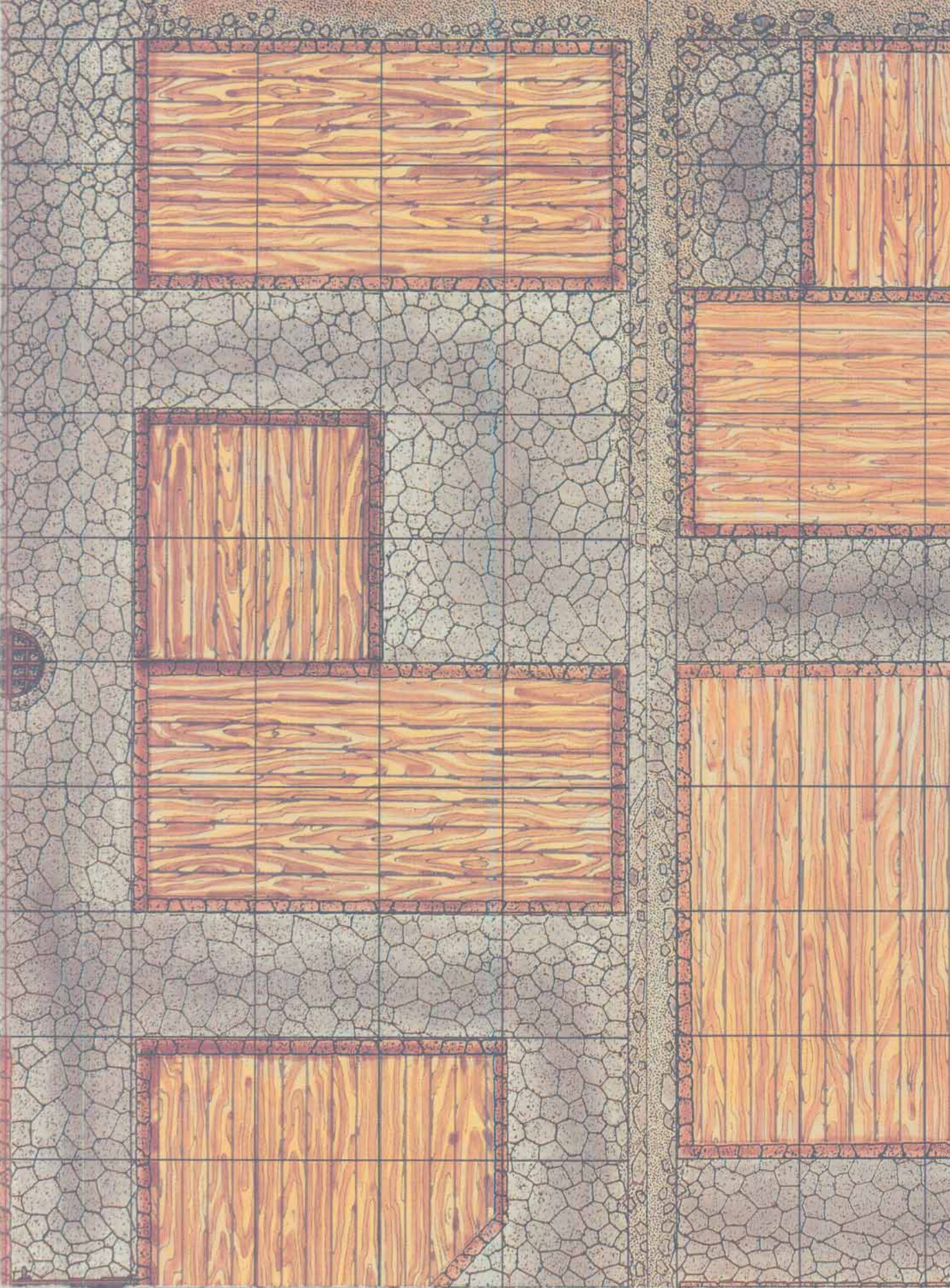



K

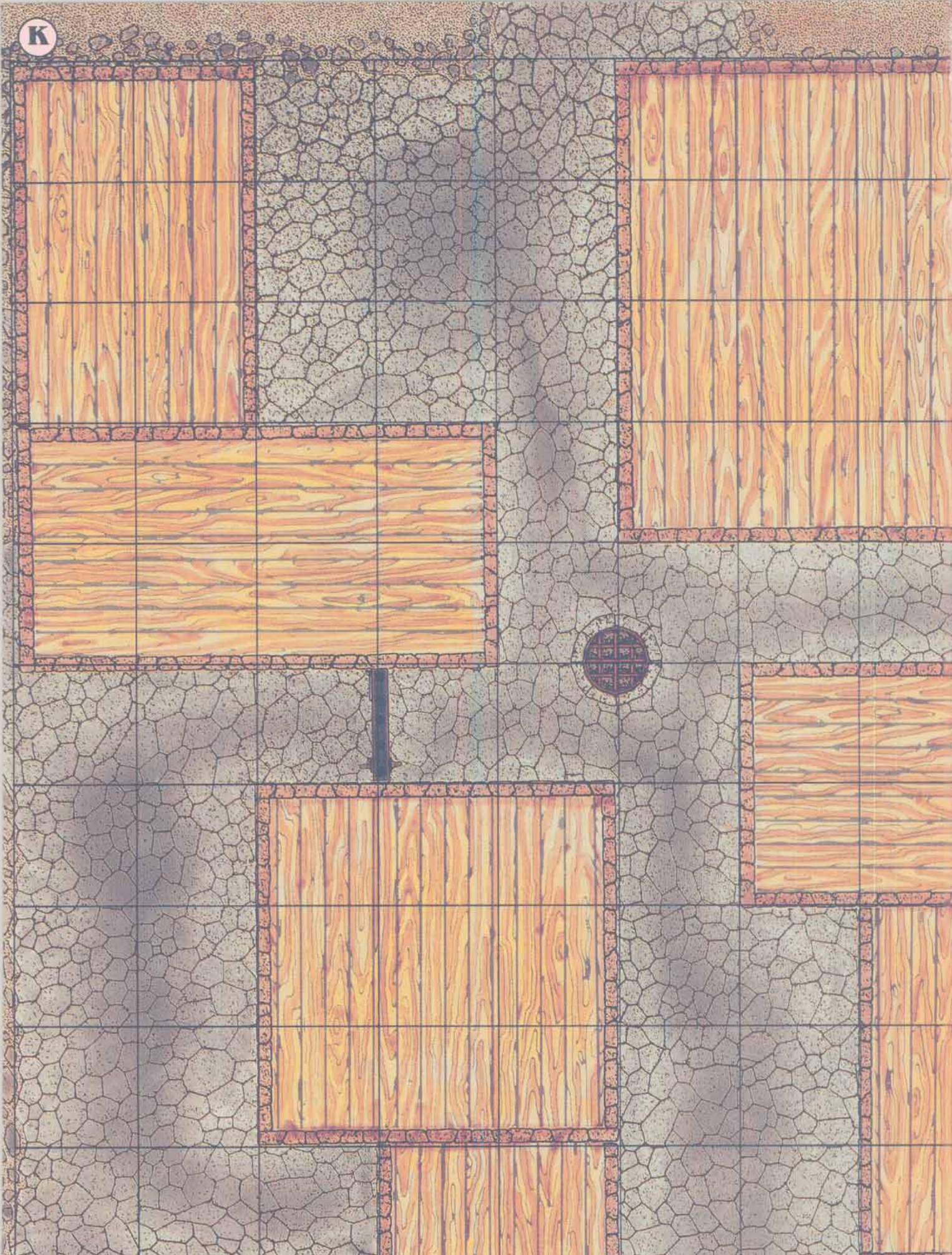

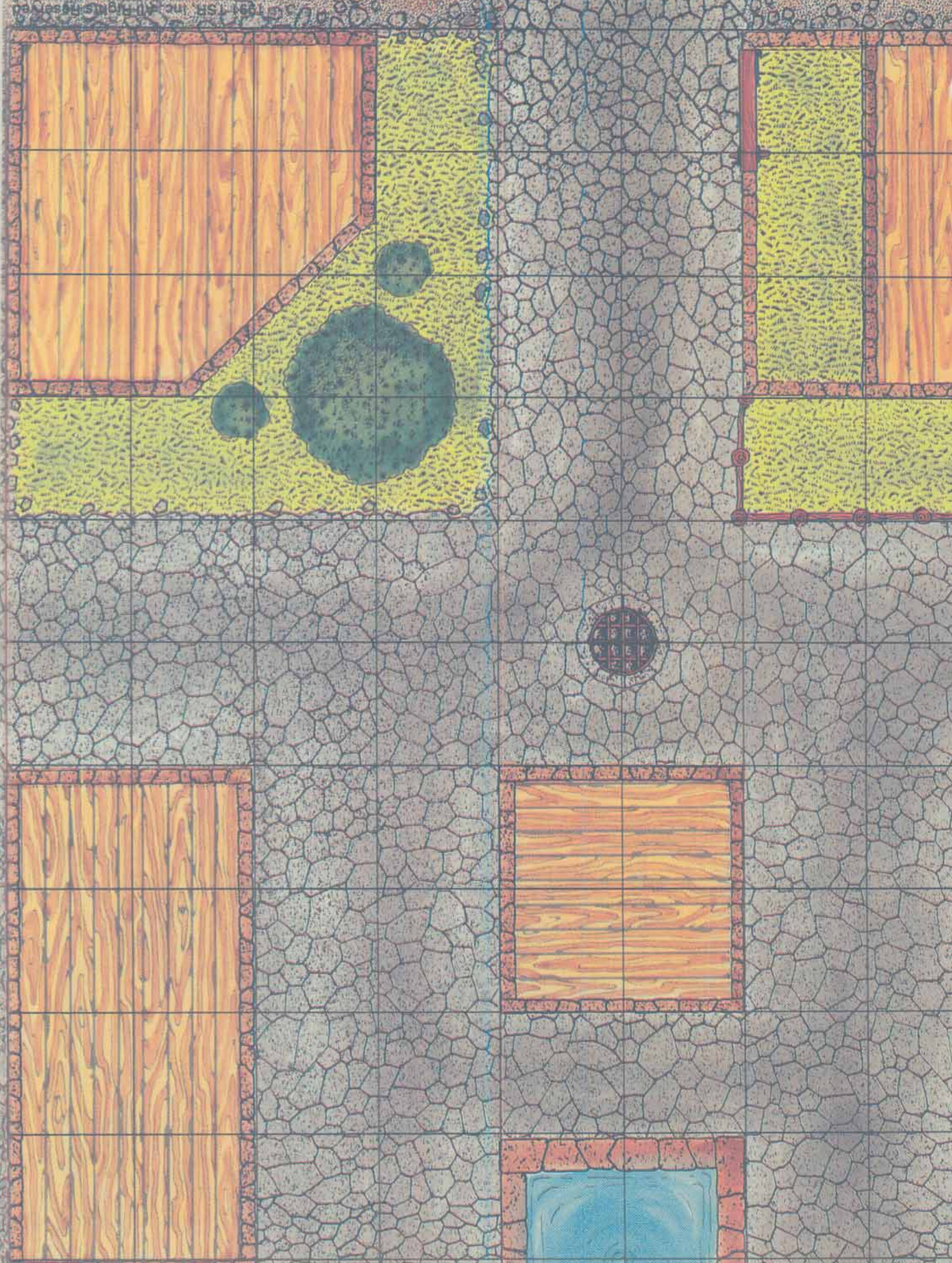

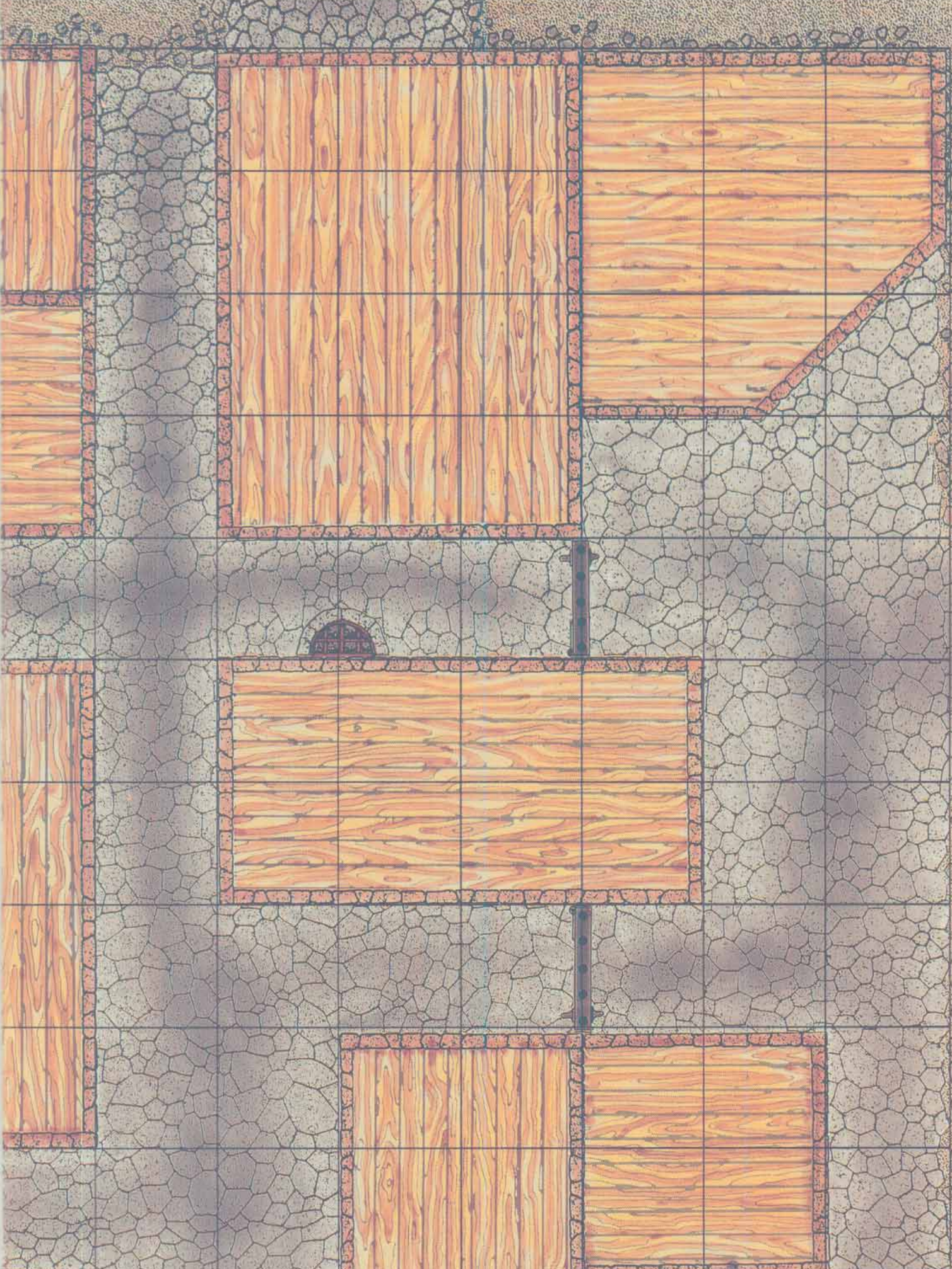

Add a new dimension to your role-playing or miniatures gaming — the third dimension! This box contains 30 sheets of colorful fold-up buildings. Assembly is simple because all the pieces are die-cut and pre-scored; all you need is glue. Also included are three full-color, two-sided mapsheets showing street layouts, plus a 16-page booklet describing how to assemble the buildings and how to modify and reassemble them in new and unusual ways.

# Strongholds

The pieces in this box are drawn from previous TSR publications, including *Castles*, *Falconmaster*, *Flames of the Falcon*, and the original *Cities of Mystery* set.



TSR, Inc.  
POB 756  
Lake Geneva, WI  
53147 U.S.A.



TSR Ltd.  
120 Church End, Cherry Hinton  
Cambridge CB1 3LB  
United Kingdom

ISBN 1-56076-361-2

9353

\$18.00 U.S.  
\$21.50 CAN  
£12.99 U.K. Inc. VAT

ADVANCED DUNGEONS & DRAGONS is a registered trademark owned by TSR, Inc. The TSR logo is a trademark owned by TSR, Inc. © 1992 TSR, Inc. All Rights Reserved. Printed in the U.S.A.

