

# DUNGEONS & DRAGONS®

3-D DRAGON TILES featuring

The Kidnapping of Princess Arelina

by Garry Spiegle

**NEW!**  
3-D Figures  
Build Your  
Own  
Dungeons!



Create your own dungeons with these 3-D tiles!  
A special D&D®/AD&D™ adventure is also included.



TSR, Inc.  
PRODUCTS OF YOUR IMAGINATION™



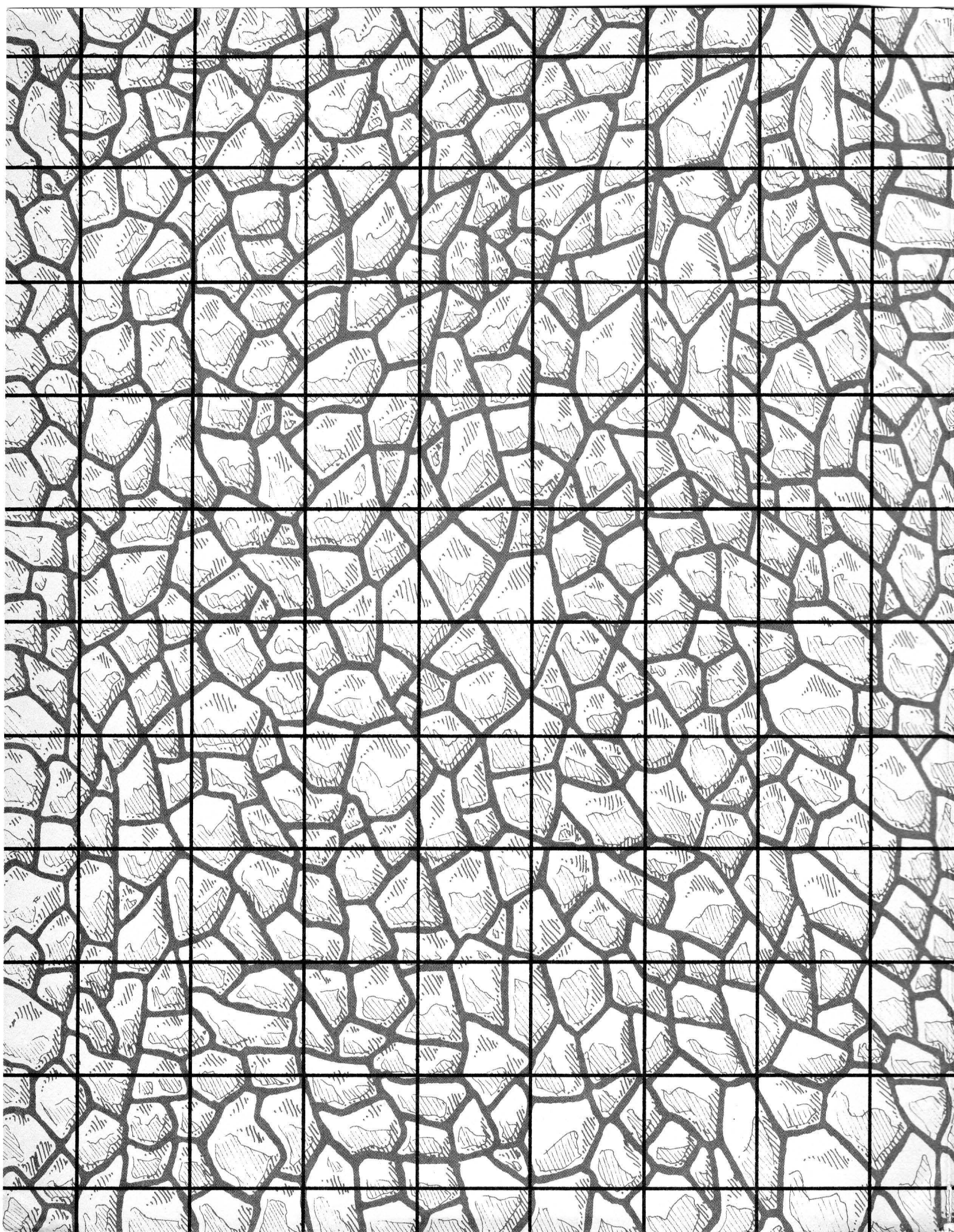

# DUNGEONS & DRAGONS®

## 3-D DRAGON TILES

For use with the DUNGEONS & DRAGONS® and ADVANCED DUNGEONS & DRAGONS® Games

### The Kidnapping of Princess Arelina

by Garry Spiegle



Editors: Tim Kilpin, Curtis Smith  
 Tile Artists: Dennis Kauth, Jim Roslof  
 Figures Designer: Dennis Kauth  
 Graphic Designer: Kitty Thompson

Distributed to the book trade by Random House, Inc., and in Canada by Random House of Canada, Ltd. Distributed to the toy and hobby industry by regional distributors. Distributed in the United Kingdom by TSR (UK) Ltd.

ADVANCED DUNGEONS & DRAGONS, DUNGEONS & DRAGONS, and D&D are registered trademarks owned by TSR, Inc. AD&D is a trademark owned by TSR, Inc.  
 ©1984 TSR, Inc. All Rights Reserved. Printed in U.S.A.

This product is protected under the copyright laws of the United States of America. Any reproduction or other unauthorized use of the material or artwork contained herein is prohibited without the express written permission of TSR, Inc.

TSR, Inc.  
 POB 756  
 Lake Geneva,  
 WI 53147

TSR (UK) Ltd.  
 The Mill, Rathmore Road  
 Cambridge CB14AD  
 United Kingdom



ISBN 0-88038-108-6  
 394-54143-XTSR0800  
 9121

## TABLE OF CONTENTS

What you get with 3-D Dragon Tiles .....	1
How to use the Dragon Tiles .....	2
<b>Dungeon adventure: <i>The Kidnapping of Princess Arelina</i></b>	
Preparing for the adventure .....	2
Beginning the adventure .....	2
Encounter key .....	2
Ending the adventure .....	7
 How to cut out and assemble the 3-D figures .....	 7

## LIST OF PLAYING AIDS

<b>3-D Figure Sheet 1:</b> Character and Monster Figures	<b>DM Sheet:</b> Abbreviations Monster statistics Prerolled characters DM Map 1: House of Towers Main Level DM Map 2: House of Towers Cellar
<b>3-D Figure Sheet 2:</b> Wall Sections and Hanging Figures	
<b>3-D Figure Sheet 3:</b> Corner Pieces, Door Inserts, and Wall Fence Sections	
<b>3-D Figure Sheet 4:</b> Double Door, Pillar Figures, and Monster Figures	
<b>3-D Figure Sheet 5:</b> Single Doors and Monster Figures	<b>Insert:</b> Feature Tile Sheet 1 Feature Tile Sheet 2

## What you get with 3-D Dragon Tiles

The 3-D Dragon Tiles are made up of two types of shapes: three-dimensional figures, and two-dimensional feature tiles. This set includes:

- |    |                             |    |  |
|----|-----------------------------|----|--|
| 8  | player character figures    | 6  | pillar figures (may be used to make walls) |
| 4  | nonplayer character figures | 2  | wall fence figures (may be used as wall)   |
| 11 | creature figures            | 84 | die-cut feature tiles                      |
| 1  | double door figure          |    |  |
| 3  | single door figures         |    |  |
| 6  | corner figures              |    |  |
| 4  | wall figures                |    |  |
| 1  | curtain figure              |    |  |
| 2  | bricked-up window figures   |    |  |
| 1  | mirror figure               |    |  |
| 1  | tapestry figure             |    |  |
| 1  | hanging swords figure       |    |  |

The 3-D figures are printed on the booklet's inside covers. The feature tiles are printed on two die-cut sheets included with the booklet. A special Dungeon Mapping Grid is printed on the booklet's outside cover.

Also included with the booklet is a special DM Sheet, which contains adventure maps and prerolled characters.

"The Kidnapping of Princess Arelina" is a special D&D®/AD&D™ adventure designed so that you may use the Dragon Tiles in play.



## Dungeon adventure: "The Kidnapping of Princess Arelina"

### How to use the Dragon Tiles

You may use these tiles in nearly any dungeon adventure. If you are running a group adventure, you may lay out the tiles as characters explore different areas. If you are playing a solo adventure, you may use the tiles to track your progress.

Start by punching out the 84 feature tiles. These tiles illustrate furniture, traps, or treasure the characters might find while exploring. In some cases, a feature tile may show an item the characters want to touch or use (a chest, for example). If characters touch such an item, the tile may be turned over to show what action the characters have caused (a chest of treasure, or a trapped chest, for example).

After you have punched out the feature tiles, cut out the major sections on the 3-D Figure Sheets. Special instructions for cutting out and assembling each of the 3-D figures are at the end of the booklet.

When you get ready to create or map a dungeon, lay the Dungeon Mapping Grid (printed on the inside of the booklet's outer cover) flat on a table. Each square on the grid is equal to 5 feet. The tiles and figures fit onto this grid.

You may use the official ADVANCED DUNGEONS & DRAGONS® Metal Miniatures with these tiles, or you may use the 3-D character and creature figures provided.



### Preparing for the adventure

This adventure is designed for a group of 4 to 8 characters between the second and fifth levels of experience. The group should include at least two clerics, as well as a mix of other character classes. Players may use their own characters, or they may use the prerolled characters provided on the DM Sheet.

You may use either DUNGEONS & DRAGONS® rules, or ADVANCED DUNGEONS & DRAGONS® rules for this adventure. Two DM maps are included on the DM Sheet. Do not show these maps to the players during the adventure.

"The Kidnapping of Princess Arelina" has been specially designed so that you may use the Adventure Tiles in running the adventure. Each encounter lists which 3-D figures and feature tiles you should use. Refer to the DM maps for the exact placement of each room's tiles and figures.

If you want to place an item (a chair, a chest) in a room that isn't listed in the encounter text, make sure you have a good reason for putting it there. Try not to clutter the dungeon with too many unnecessary obstacles.

Read the adventure and become familiar with all of the tiles used in it before you run the adventure for a group. Your adventure will go more quickly and will be more exciting if you do.

Read all boxed text to the players. The text in these boxes describes the areas the characters see as they explore. Some encounters list specific times at which you should read this boxed text. Try to lay out the proper tiles and figures at the same time you read the boxed text to the players.

All rooms are described as if characters have a lantern or torch and can see clearly. If characters have no light source, you may alter the room descriptions or add confusing tiles to the layout to reflect the characters' "impaired" visibility.

The DM Sheet lists all of the monster statistics and abbreviations used in the adventure.

After you have run this adventure, try designing and "stocking" your own dungeon. Guidelines for creating your own adventures are included in the D&D® Basic and Expert rule books.

### Beginning the adventure

Start this adventure by reading the Royal Edict to the players. Then go to the Encounter Key and start with **encounter 1**.

**Encounters 1-11** are shown on DM Map 1; **encounters 12-17** are shown on DM Map 2.

### ROYAL EDICT

Be it known that yesterday, vile and treacherous fiends kidnapped Princess Arelina, King Limakhan's youngest daughter.

Be it also known that royal guardsmen pursued the kidnappers to the gates of a house bounded by two dark towers. Archers and lancers have surrounded the evil place, and trapped the wretched kidnappers within.

Be it also known that the king has forbidden the archers and lancers to attack the house of towers so long as the princess remains inside. Therefore, the king seeks a few strong warriors to enter the house and rescue Princess Arelina.

Thus, King Limakhan offers a reward of 50,000 gold pieces to any person or party who rescues the princess by nightfall tomorrow. The king also offers one of his finest war horses to each rescuer.

Be warned! If the princess is harmed or is killed, or if the rescuers try to turn back, the king's archers and lancers will be forced to kill the wrongdoers.

### Encounter key

#### 1. THE HOUSE OF TOWERS ENTRYWAY

*3-D figures:* walls, double door, corners  
*Feature tiles:* stairs, gargoyle statues

Cool breezes blow through the wet grass as the sun lights the sky to the east. To the north, a dark, one-story stone building rises from the dawn mist. Bricked-up windows mark two 20-foot-high towers that rise from the northwest and southeast corners of the building.

A rickety iron fence runs around the house. Along the fence, dozens of soldiers stand guard. Steps run upward from the weed-covered lawn inside the fence. The steps lead to a porch in the south wall.

The house is made entirely of stone. All of the windows have been bricked over. This porch is the only entrance. No sunlight penetrates this gloomy place.

All rooms in the house are 10 feet high, unless otherwise noted. All doors are made of wood, and all are unlocked, unless otherwise noted. The inside walls are 1 foot thick, and the outside wall is 2 feet thick.

As characters approach the steps, they see two gargoyle statues standing on each side of the entryway. Five-foot wide, iron-banded double doors stand in the porch's north wall.



Pressure plates lie in the floor just north of each gargoyle statue. If a character steps on one of the plates, the gargoyle's clawed wings of stone swing out to hit the character. Any character who activates this trap must roll 1d20. If the dice roll is greater than his Dexterity score, the character takes 1d6 points of damage. Each statue takes 6 points of damage before it can be destroyed.

## 2. HALLWAY

*3-D figures:* walls, double door, single doors, bricked-up window, black curtain, broken mirror

*Feature tiles:* cobwebs, table

The sound of scurrying rats echoes from the north end of the hall. Cobwebs cover the ceiling and hang down into the hallway, which is musty and damp.

Rotting black curtains hang along one section of the east wall. A long wooden table stands to the north of the curtains.

Doors stand in the west and east walls of this hallway's north end. A bricked-up window rests in the north wall, and a cracked mirror hangs from one of the window's bricks.

A jumble of footprints criss-crosses the dusty floor.

The black curtains open onto a closet. Rotting clothes hang on pegs in the closet wall. Several pairs of mud-caked shoes and boots lie on the closet floor. If characters rummage through the clothes, they find 2 sp.

The window and mirror are illusions. A door that leads to **area 6** stands behind these illusions.

If characters study the footprints closely, they see that some are fairly fresh. The characters cannot follow the footprints in one specific direction, however.

## 3. LIBRARY

*3-D figures:* walls, single doors, corners, ghouls, hanging swords

*Feature tiles:* bookshelves, pile of books, desk, unlit fireplace, square rug, sofa, two stuffed chairs, wooden chair, extinguished candelabras

The door to this area is locked. Characters must have a combined Strength of 24 or higher to break down the door.

Bookshelves cover the entire north wall of this musty library. Many books, their leather covers ripped and rotting, have fallen to the floor.

A fireplace filled with spider webs and dry kindling stands along the west wall. Two swords draped in cobwebs hang above the mantle. Candelabras stand on each side of the fireplace. None of the candles is burning.

A sofa and two stuffed chairs face the fireplace, and a large, thick rug lies in front of the sofa.

A wooden desk stands in the southwest corner of the room. Several bottles and crystal goblets litter the desktop. An inkwell, a feather quill, and a parchment scroll lie between the bottles. A wooden chair stands before the desk.

As soon as the characters enter this room, a ghoul rises from the sofa to face them. A few seconds later, three more ghouls rise from the sofa and chairs. They all attack.

Ghouls (4): AC 6; HD 2; hp 11, 8, 7, 5; MV 90' (30'); #AT 3; D 1-3/1-3/1-6; Save F2; ML 9; AL C/CE; XP 25; SA touch causes paralysis unless victim makes a saving throw vs. paralysis; SD immune to *sleep* and *charm* spells

Most of the books that line the north wall of this room are worthless. If characters take the time to check the books carefully, they may find nine valuable books. Each is worth 10 gp.

A secret door behind one of the bookshelves along the north wall leads to **area 4**.

If a character cleans the cobwebs off one of the swords that hangs above the fireplace, the sword gives off a dim, bluish glow. Each sword is a silver *longsword* +1.

A trapdoor lies beneath the rug in this room. If characters open the trapdoor, they find a ladder that leads down into darkness. Unless the characters are unusually clumsy, they should not fall through this trapdoor, as its door opens toward the characters. If the characters go through the trapdoor, go to **area 12**.

The bottles on the desk contain old wine. If a character takes a drink from any of the bottles, the wine tastes bitter, but has no effect if the character immediately spits it out. Any character who drinks from one of the bottles must make a saving throw vs. poison or be sick for 1 hour. That character also suffers a -1 hit roll penalty for that time.

The scroll on the desk contains the spell *cure light wounds*.

A small vial containing a potion of *healing* lies in the top desk drawer.

## 4. BEDROOM

*3-D figures:* walls, single doors, corners, bricked-up window, broken mirror, black curtain, giant rats, wererats

*Feature tiles:* rotting bed, extinguished candelabras, round wooden table, square wooden table, chest (treasure chest), lumpy rug, spiral stairs, centipedes

A massive four-post bed, covered by rotting, filthy blankets, stands along this room's west wall. The bed's pillows are shapeless masses.

A large black curtain hangs along the room's northwest corner, which juts inward. A small, round table stands near the curtain.

A chest rests against the room's north wall; a lumpy rug lies in front of the chest. To the east of the chest, a broken mirror hangs on the wall. Pieces of broken glass litter the floor below the mirror.

A square wooden table stands against the room's south wall.

As soon as characters enter this room, they see two wererats freeze for an instant, and then leap forward to attack.

Wererats (2): AC 7/6; HD 3/3+1; hp 15, 12; MV 120' (40'); #AT 1; D 1-8; Save F3; ML 12; AL C/LE; XP 50; SA can only be hit by silver or magical weapons

The wererats fight until they are destroyed. After 1d4 rounds, two giant rats rush out from under the bed to attack the characters.

Giant Rats (2): AC 7; HD 1/2; hp 3, 2; MV 120' (40'); #AT 1; D 1-3; Save NM; ML 8; AL N/NE; XP 5; SA 5% chance of disease per bite

If characters disturb the black curtain along the northwest wall, a huge spider (from **area 5**) crawls out to attack the characters.

Huge Spider: AC 7/6; HD 2/2+2; hp 12; MV 120' (40'); #AT 1; D 1-8; Save F1; ML 7; AL N; XP 25; SA can leap 3 feet, bite inflicts poison unless victim makes saving throw vs. poison (+1 bonus)

If characters step on the lumpy rug along the north wall, three giant centipedes crawl out to attack the characters.

## “THE KIDNAPPING OF PRINCESS ARELINA”

Giant Centipedes (3): AC 9; HD 1/4; hp 2, 2, 1; MV 60' (20'); #AT 1; D poison; Save NM; ML 7; AL N; XP 6; SA bites inflict poison unless victim makes saving throw vs. poison (+4 bonus)

If characters rummage through the chest, they find a potion of *invisibility* and a *wand of secret door detection*. A *ring of protection +1* lies on the floor behind the chest.

### 5. WATCH TOWER

3-D figures: walls, single door, corners, bricked-up windows  
Feature tile: spiral staircase

As soon as characters open the black curtain that covers the door to this area, a huge spider rushes out to attack. (Characters may already have fought this spider in **area 4**). If characters open the door to this area, another huge spider drops from the ceiling and attacks.

Huge Spiders (2): AC 7/6; HD 2/2+2; hp 12, 7; MV 120' (40'); #AT 1; D 1-8; Save F1; ML 7; AL N; XP 25; SA bite inflicts poison unless victim makes saving throw vs. poison (+1 bonus)

If characters go beyond the door to this area, they find a dark spiral staircase that leads upward. If the characters go up the stairs, read the following boxed text to the players.

The stairs open into a dark, barren room. Empty torch sconces line the walls. Bricked-up windows rest in each wall of the tower room.

If characters inspect the windows, they see that cracks run between the mortar around some of the bricks. Characters cannot pull any of the bricks loose, but they can look through the cracks. If they do, they see several of King Limakhan's archers standing around the iron fence.

After 2d4 rounds, the door at the bottom of the stairs slams shut. Characters cannot reopen it from the inside. Characters must have a combined Strength of 30 or higher to break down the door.

### 6. BATHROOM

3-D figures: walls, single doors, corners, broken mirror, bricked-up window  
Feature tiles: rug, bathtub, basin

A large bathtub stands against the north wall of this square room. A bricked-up window rests in the wall above the tub. A tin basin, partially filled with brackish water, stands on a wooden table against the east wall. A broken mirror hangs above the basin.

A threadbare rug lies in the center of the floor. Dust covers everything here.

If characters move the rug, dozens of cockroaches scurry out. The cockroaches are harmless.

If characters inspect the basin, they find a sealed vial of holy water resting at the bottom.

### 7. SITTING ROOM

3-D figures: walls, single doors, corners, green curtains, skeletons, ghouls, hanging picture  
Feature tiles: rocking chair, sofa, unlit candles on table, wooden chair, rug, extinguished candelabra

A rocking chair stands against the east wall of this long room. Dust and mold cover a high-backed wooden chair that stands in the southwest corner. A green curtain hangs in the room's southeast corner.

Two huge portraits hang in the center of the north wall.

A moldy sofa stands along the south wall. End tables, each holding unlit candles, stand on both sides of the sofa. A long rug lies in front of the sofa. Sitting stiffly on the sofa are two skeletons, clutching teacups in their boney fingers.

As soon as characters see the skeletons, the skeletons rise to attack.

Skeletons (2): AC 7; HD 1; hp 5, 5; MV 60' (20'); #AT 1; D 1-6; Save F1; ML 12; AL C/N; XP 10; SD 1/2 damage from sharp and edged weapons, immune to *sleep*, *charm*, *hold*, and *cold*-based spells

If characters throw a full vial of holy water at the skeletons and hit them, the water causes a total of 2d4 points of damage.

Two ghouls are hiding in a secret chamber behind the easternmost portrait. The ghouls rip through the canvas 1d4 rounds after the skeletons attack. The ghouls cannot attack the same round they appear.

Ghouls (2): AC 6; HD 2; hp 8, 6; MV 90' (30'); #AT 3; D 1-3/1-3/1-6; Save F2; ML 9; AL C/N; XP 25; SA touch causes paralysis unless victim makes saving throw vs. paralysis; SD immune to *sleep* and *charm* spells

The chamber from which the ghouls came is empty.

If characters search behind the green curtain, they find a locked door. A piece of pale, blue silk is caught in the door. It is a piece of Princess Arelina's robe.

A secret door in the wall to the east of the portraits leads to the kitchen (**area 10**).

If characters search under the sofa, they find a clerical scroll. On the scroll are two *neutralize poison* spells.

### 8. DINING ROOM

3-D figures: walls, single doors, corners, black curtains, tapestry  
Feature tiles: wooden chairs, table, lit candles on tables, cabinet, shadows

A tall archway stands in the east wall of this dimly-lit room. Black curtains hang along the east wall on both sides of the archway. A huge tapestry hangs on the west wall.

Along the north wall stands an ornate china cabinet. A door stands in the wall to the east of the cabinet.

A long dining table dominates the center of the room. Ten high-backed wooden chairs surround the table. Brass candelabras, covered with wax drippings, sit at each end of the table. Colored candles flicker softly in the candelabras. The dim light casts strange, moving shadows about the room.

Several china settings are placed around the table. A glass goblet and several pieces of silverware accompany each setting. Suddenly, two of the goblets rise gracefully into the air and tip slightly. Pale, rose-colored liquid drains slowly from the goblets.

Knives and forks move about on a few of the plates and dishes. Two large silver platters suddenly float through the archway into the room.

Because of the dim light in this room, it takes 3 rounds for the characters to see that two shadows are sitting at the table. Two more shadows are carrying food in from **area 9**. Four rounds after characters enter the room, the shadows attack.



Shadows (4); AC 7; HD 2+2/3+3; hp 10, 9, 8, 8; MV 90' (30'); #AT 1; D 1-4 (2-5 if AD&D™ rules are used); Save F2; ML 12; AL C/CE; XP 35; SA each hit drains 1 Strength point, a character whose Strength points are drained to 0 immediately becomes a shadow; SD can only be hit by magical weapons, immune to *sleep* and *charm* spells

These shadows never go beyond **areas 8, 9, or 10.**

The silverware in the room is worth 500 gp. The china cabinet holds 10 large carving knives. Each is worth 10 gp. Characters may use these knives as daggers.

If characters inspect the tapestry, they see that it is faded and dusty. It depicts hunting and jousting scenes. Moths and other insects have infested the tapestry, making it worthless.

If characters search behind the black curtain, they find a door that leads to **area 5.**

## 9. SERVICE HALL

*3-D figures:* walls, single door, broken mirror, bricked-up windows

*Feature tiles:* skeletons

An archway stands near the southwest corner of this long hallway. A door stands ajar in the center of the north wall.

Two bricked-up windows rest in the east wall, and a broken mirror hangs on the west wall. Shards of glass lie on the floor beneath the mirror.

The bricked-up windows are illusions. Each window covers a secret door in the east wall. Small alcoves lie behind the secret doors. The north alcove holds the mummified remains of a woman, and the south alcove holds the mummified remains of a man. The female mummy is wearing a delicate gold ring, and the male mummy is wearing a large silver ring.

The female's ring is a *ring of protection +1.*

The male's ring gives its wearer the ability to fly once per day (duration of 1d6 turns). The ring is cursed, however. For the ring to work, its wearer must shout and scream as long as he is flying. The ring's powers are not affected by what the wearer shouts.

## 10. KITCHEN

*3-D figures:* walls, single doors, corners, rust monster

*Feature tiles:* fireplace, table, pots & pans, cabinet

The smell of rotting food hangs in the air of this dusty room. Doors stand in the west and south walls of the room. Both are ajar.

A large wooden table stands in the center of the room. A tall cabinet stands in the northwest corner, and a dusty fireplace runs along the east wall. Rusty pots and pans are scattered about on the floor.

After three characters enter this room, a rust monster bursts through the door in the west wall and attacks.

Rust Monster: AC 2; HD 5; hp 20; MV 120' (40'); #AT 1; D special; Save F3; ML 7; AL N; XP 300; SA hit causes metal armor and weapons to rust

A secret door in the south wall of this room leads to **area 7.** There is nothing else of value here.

## 11. STAIRWAY

*3-D figures:* walls, single door, corners

*Feature tile:* spiral stairs

The door opens onto a curved stairway that leads downward. The stairs have been carved from stone. The air in this shaft is cool and damp. Tiny holes riddle the walls of the shaft.

These stairs lead down to the house of towers cellar. Mice and rats live in the holes that riddle the shaft walls. Some of these creatures may rush out and startle the characters as they walk down the stairs, but the rodents cause no harm.

If characters search the stairs as they descend, they find a small ring. An emblem on the ring matches the emblem on the uniforms of the archers and lancers who are guarding the house. Princess Arelina dropped the ring.

## 12. LIBRARY TUNNEL

*3-D figures:* walls, corners

*Feature tiles:* open trapdoor, skeleton, rocky rubble

If characters discover the trapdoor in the floor of the library (**area 3**), they see that a ladder leads down to this cellar tunnel.

If characters climb down the ladder, they notice that dozens of cobwebs hang between the rungs. Tiny spiders crawl out across any characters who climb down the ladder. The spiders are harmless. The ladder may break,

however, under a character's weight (30% chance per character). If the ladder breaks, the character on it must roll 1d20. If the dice roll is greater than his Dexterity score, the character takes 1d6 points of damage from falling.

When characters reach the tunnel floor, read the following boxed text to the players.

Rough-hewn walls of rock form this dark tunnel, which leads to the south.

If characters follow the tunnel, they see that it turns eastward, and then widens to a small cavern. A pile of rocky rubble forms the cavern's east wall.

A skeleton lies along the cavern's north wall. There is nothing else in this cavern.

## 13. CELLAR HALLWAY

*3-D figures:* walls, single doors, corners

*Feature tile:* curved stairs

The stairs from the upper level of the house open onto this long, low hallway. The rough-hewn walls rise to a height of only 6 feet. A door stands in the south end of the west wall.

If characters continue down this hallway, they see that it widens as it turns toward the east. Another door stands in the north wall here. There is nothing else of interest in this hallway.

## 14. SOUTH TUNNEL

*3-D figures:* walls, wall fence, single door, corners, giant rats, wererat, fighters

*Feature tiles:* chest beneath rubble, pool of fire

Holes and ledges of rock mark this tunnel. Rocks and small boulders litter the floor.

Just ahead, a pile of rubble partially blocks the hallway, making it impossible for more than one person to move through the hallway at a time.

Two giant rats attack any character who moves past the pile of rubble.

Giant Rats (2): AC 7; HD 1/2; hp 2, 2; MV 120' (40'); #AT 1; D 1-3; Save NM; ML 8; AL N/NE; XP 5; SA 5% chance of dis-ease per bite

A small niche stands in the south wall just beyond the pile of rubble. A wererat is hiding in the niche. It attacks 2 rounds after the giant rats attack.

## “THE KIDNAPPING OF PRINCESS ARELINA”

Wererat: AC 7/6; HD 3/3+1; hp 15, 12; MV 120' (40'); #AT 1; D 1-8; Save F3; ML 12; AL C/LE; XP 50; SA can only be hit by silver or magical weapons

As the characters fight the rats, two of the kidnapers (Jahat from **area 15**, Jelek from **area 16**) try to trap the characters in the tunnel. They come to the east end of the tunnel and throw burning oil at the east end of the rubble pile. They then stand behind the burning oil and fire their crossbows into the space between the wall and the rubble pile. (See **area 15** for Jahat's statistics, and **area 16** for Jelek's statistics.)

If characters continue down the tunnel toward the west, they come to a pile of rubble that blocks the west wall. The west end of the tunnel has caved in. This tunnel once connected to **area 12**.

If characters inspect the rubble, they find a wooden chest buried under some of the rocks. The chest contains nine bottles of wine. The wine in six of the bottles has gone sour, but the wine in the other three bottles is in excellent condition. Each bottle is worth 3 sp.

### 15. CELLAR PRISON

*3-D figures:* walls, single door, corners, ghouls, fighters  
*Feature tile:* flock of bats

If characters have defeated Jahat and Jelek, skip to the boxed text below and read it to the players as the characters enter this room.

If the characters have not defeated the kidnapers, Jelek cracks open the door between **areas 16** and **13**, and fires his crossbow at the characters as they try to enter this room. Jelek is protecting Jahat, who is standing guard just inside the door to this room.

Jelek stops firing as soon as characters enter this room. He does not follow the characters.

This dark room is cold and damp. A rusted iron gate stands open at the far end of the room. Several bats hang from the ceiling in front of the gate.

If characters have not defeated Jahat, he attacks immediately.

Jahat, third level fighter: AC 6; hp 17; MV 120' (40'); #AT 1; D 1-8; Save F3; ML 10; AL N; S 15; I 11; W 7; DX 10; CN 8; CH 8

Jahat is armed with three loaded crossbows, 15 extra bolts, and a longsword.

This room is the cellar prison. The cell at the back of the room is empty. The bats on the

ceiling are harmless.

As Jahat fights the characters, he tries to draw them toward the tunnel off the room's east wall. Any character who is backed more than 5 feet into the tunnel is grabbed by two ghouls. The ghouls live in this short tunnel. They do not come out of the tunnel for any reason.

If characters back Jahat more than 5 feet into the tunnel, a scream suddenly pierces the air. Then there is silence.

Ghouls (2): AC 6; HD 2; hp 10, 8; MV 90' (30'); #AT 3; D 1-3/1-3/1-6; Save F2; ML 9; AL C/CE; XP 25; SA touch causes paralysis unless victim makes saving throw vs. paralysis; SD immune to *sleep* and *charm* spells

### 16. WINE CELLAR

*3-D figures:* walls, single doors, corners, fighters  
*Feature tiles:* stacks of casks, stacks of boxes, broken glass

If characters have defeated Jahat and Jelek, skip to the boxed text below and read it to the players as the characters enter this room.

If the characters have not defeated the kidnapers, Jahat steps out of **area 15**, stands in the hallway, and fires his crossbow at the characters as they try to enter this room. Jahat is protecting Jelek, who is standing guard in the northwest corner of this room.

Jahat continues to fire his crossbow as he follows the characters into this room.

A jumble of boxes and casks fills this room. Many of the boxes are ripped open, and several wine bottles have been smashed. Broken glass and corks litter the floor, which is stained a dark red.

If characters have not defeated Jelek, he attacks immediately.

Jelek, fourth level fighter: AC 5; hp 20; MV 90' (30'); #AT 1; D 1-6; Save F4; ML 10; AL N; S 15; I 13; W 8; DX 14; CN 15; CH 13

Jelek is armed with four loaded crossbows, 20 extra bows, and a shortsword.

Any character who hides behind the boxes or casks may improve his Armor Class by 4. If the characters badly wound Jelek, he retreats into **area 17**.

If characters inspect the wine, they find that most of it has gone sour. If they take the time to go through all of the boxes, they are only able to find 25 bottles that are still of any value. Each is worth 2 sp.

### 17. WEST STORAGE ROOM

*3-D figures:* walls, wall fence, single doors, corners, magic-user, princess  
*Feature tiles:* boxes, stack of boxes

Rusak, a magic-user and the last of the kidnapers, is in this room guarding Princess Arelina, who is gagged and tied in the south-east corner of the room.

Unless the characters were extremely quiet, Rusak heard the characters approaching this room, and prepared for their entrance. As soon as the characters open the door to the room, Rusak casts a *fireball* spell at the door. Read the following boxed text to the players when the characters enter the room.

The door opens onto a dark hallway. Suddenly, a flash of light bursts from deep inside the hall. Flames surge through the hallway just inside the door, blasting the door's wood to bits and filling the hall with fire. The sound of exploding bottles pops in the room beyond. Hot liquid splatters the entire area.

A rolling laugh sweeps out of the room. "Stay back!" the voice says. "There's a lot more where that came from!"

The door to this room burns and crumbles to cinders in a few seconds. After the door has stopped burning, the characters may safely enter the room.

Once they are in the room, the characters see burning boxes and exploding wine bottles, but they do not see Rusak.

Just after casting the *fireball* spell, Rusak cast an *invisibility* spell on himself.

Rusak, fourth level magic-user: AC 10; hp 15; MV 120' (40'); #AT 1; D 1-4; Save MU4; ML 12; AL N; S 11; I 13; W 12; DX 14; CN 12; CH 15

Spells.

First level: *ventriloquism*, *magic missile*  
Second level: *darkness* (15' radius)

Rusak stole several magic scrolls before he, Jahat, and Jelek kidnapped the princess. He used the spells on the scrolls to break into the house of towers and keep its creatures at bay. He has already used all of his scroll spells.

Rusak fights to the death. Jahat and Jelek, if they are still alive, come to Rusak's aid. None of the kidnapers harms Princess Arelina, although they constantly say they will.

As soon as the characters free the princess, she dashes to them, throwing her arms around the character in front. She thanks the characters, and then asks them to take her home.



## Ending the adventure

As the characters lead the princess out of the house of towers, King Limakhan, who followed the characters to the house, cries out with joy at the first sight of his daughter. He runs forward so quickly that his bodyguards can hardly keep up.

The king rushes to hug Arelina, and exclaims, "My princess, my daughter, joy of my life! Today you are born again for me!"

The king turns toward the characters. "You are skilled and courageous. I am a man of my word. Come to my castle to heal your wounds, rest your bodies, and collect your proper reward!"

## How to cut out and assemble the 3-D figures

To put these figures together, you will need scissors, and glue or tape.

Tear 3-D Figure Sheets 1, 3, and 4 along their perforations. Then cut along the score between 3-D Figure Sheets 2 and 5. You now have five different 3-D Figure Sheets.

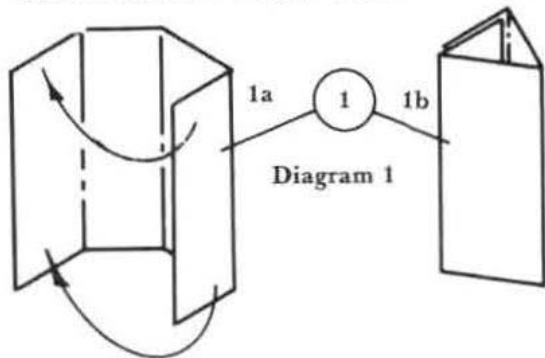

### 3-D Figure Sheet 1: Character and Monster Figures

The blank panel of each piece lists the character name or monster type.

1. Cut along the heavy solid lines until you have 18 separate pieces.

2. Fold along the light solid lines on each piece, as shown in Diagram 1. Each of the pieces folds into a triangle that shows a character's (or monster's) right, left, and back sides. To show that a character is moving forward, point its figure in the direction noted by the arrow on Diagram 1.

3. Apply a few drops of glue to the triangle's blank panel ("1a" on Diagram 1). Then fold the figure together into a triangle and press firmly. If you use tape, fold the figure together and wrap a small piece of tape around the front point of the triangle ("1b" on Diagram 1). The tape should bind the figure's right and left sides together.

### 3-D Figure Sheet 2: Long Wall Sections, Short Wall Sections, and Hanging Figures

Cut along the heavy solid lines of each piece on this sheet, until you have two Long Wall Sections, two Short Wall Sections, and six Hanging Figures.

#### Long/Short Wall Sections:

1. Fold along the light solid lines as shown in Diagram 2. Make sure that the wall triangles that border each wall fold *behind* the full-color wall section. The 2-color stone pattern is marked by a "1" on Diagram 2.

2. Apply a few drops of glue to the wall triangles' blank panels. Then firmly press the wall triangles against the wall. If you use tape, wrap small pieces of tape around the tops and bottoms of the wall where the triangles meet the wall.

#### Hanging Figures:

1. Fold each of the Hanging Figures along the light solid lines so that each figure stands like a tent. The full-color illustrations should show on both sides.

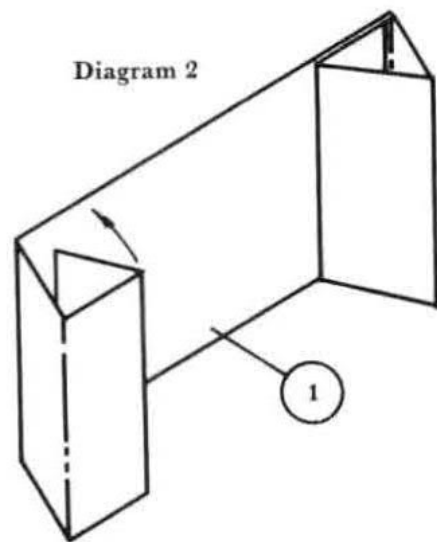
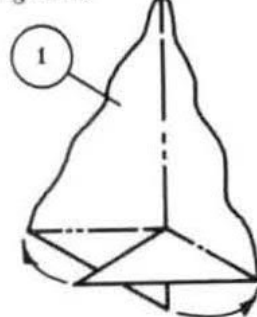

Diagram 3



### 3-D Figure Sheet 3: Corner Pieces, Wall Fence Sections, and Door Inserts

#### Corner Pieces ("1" on Diagram 3):

1. Cut along the heavy solid lines on the Corner Piece.

2. Cut along the solid line that runs along the blank panel at the bottom of the Corner Piece.

3. Fold the Corner Piece together along the light solid lines, as shown in Diagram 3. The arrows on Diagram 3 show how the Corner Piece's bottom panels fold together.

4. Apply a few drops of glue to the blank panel at the bottom of the Corner Piece. Fold the Corner Piece together and press firmly. If you use tape, fold the Corner Piece together and wrap a piece of tape around the bottom of the corner, where the two panels come together.

Diagram 4

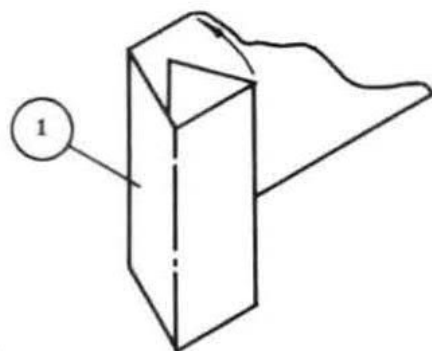

#### Wall Fence Sections:

1. Cut along the solid lines of the Wall Fence Section.

2. Fold along the Wall Fence's light solid lines, as shown in Diagram 4.

3. Apply a few drops of glue to the Wall Fence's blank panel. Then press the wall triangle ("1" on Diagram 4) firmly against the Wall Fence (as shown by the arrow in Diagram 4). If you use tape, press the wall triangle against the Wall Fence and wrap a small piece of tape around the top of the Wall Fence, where the triangle and wall meet. Then wrap another small piece of tape around the bottom of the Wall Fence, where the triangle and wall meet.

Set aside the Door Insert pieces for now.



### 3-D Figure Sheet 4: Double Door, Pillar Figures, and Monster Figures

#### Double Door:

1. Cut along the heavy solid lines of Double Door Frames A & B, and along the heavy solid lines of the Right and Left Double Door Stands.

2. Cut out the sections marked with an "X" on the Double Door Frames. These spaces will form the door opening when the door is put together.

3. Apply a few drops of glue to the blank side of Double Door Frame A ("1" on Diagram 5). Apply the glue ONLY along the lines marked by arrows on Diagram 5. Do not apply glue anywhere else on Double Door Frame A.

4. Press Double Door Frame A firmly together with Double Door Frame B ("2" on Diagram 5). Make sure that the full-color sides are showing on both sides of the door frame.

If you use tape, wrap small pieces of tape around the ends of the door frames (top and bottom). Use the arrows in Diagram 5 as guidelines for placing the tape.

5. Fold along the light solid lines of the Right and Left Double Door Stands, forming them into triangles. The Left Double Door Stand is "3" on Diagram 5, and the Right Double Door Stand is "4" on Diagram 5.

6. Glue or tape the Double Door Stand triangles together, as you would the Character Figures in Diagram 1.

7. Apply a few drops of glue to the blank back panel of the Left Double Door Stand. Press the triangle firmly against the left side of Double Door Frame B.

8. Apply a few drops of glue to the blank back panel of the Right Double Door Stand. Press the triangle firmly against the right side of Double Door Frame B.

If you use tape, attach the Double Door Stands to Double Door Frame B as you would the wall triangles in Diagram 2.

The double door should now stand on its own.

9. Get 3-D Figure Sheet 3 and cut out the Door Inserts along the heavy solid lines.

10. Place the Double Door Insert ("5" on Diagram 5) in the slot between Double Door Frames A & B. You should be able to freely

move the Double Door Insert up and down between the frames. When the double door is open (the Double Door Insert is pulled all the way up), your Character Figures should fit easily through the open doorway.

#### Pillar Figures:

Cut out, fold, and assemble these figures as you would the Character Figures (Diagram 1).

#### Monster Figures:

Cut out, fold, and assemble these figures as you would the Character Figures (Diagram 1).

Note: These Monster Figures rest horizontally, so they have no back sides.

### 3-D Figure Sheet 5: Single Doors and Monster Figures

#### Single Doors:

Cut out, fold, and assemble these figures as you would the Double Door (Diagram 5).

#### Monster Figures:

Cut out, fold, and assemble these figures as you would the Character Figures (Diagram 1).

Diagram 5

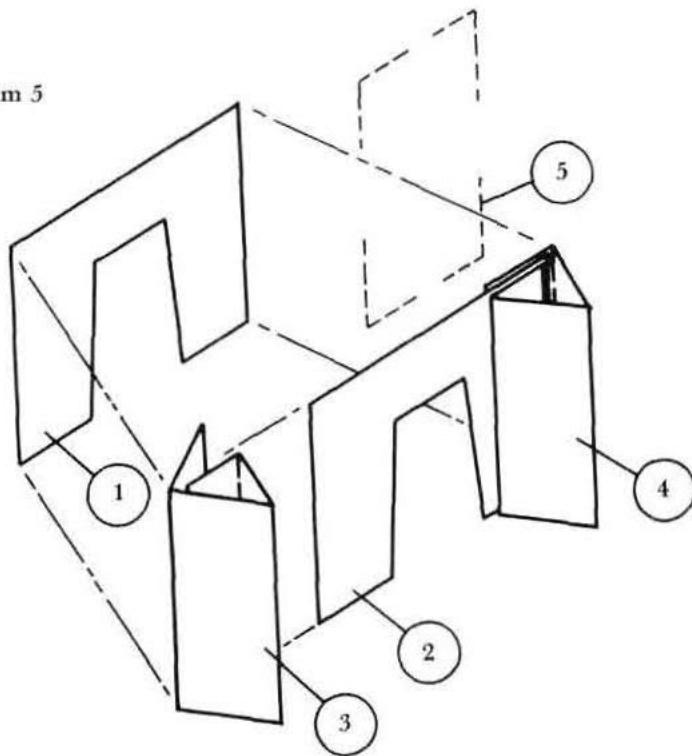

### Tips on using the 3-D figures

You may use these figures to create three-dimensional rooms on the dungeon grid. The uses for pieces such as walls and doors are fairly obvious, but other pieces may be used in several ways.

You may use *Corner Pieces* to delineate room sizes, while leaving a wall open for moving Character Figures and placing feature tiles. You may also use *Corner Pieces* to represent broken or crumbling walls.

You may use *Pillar Figures* as wall additions, or you may use them lengthwise as stone embankments.

You may use some *Hanging Figures* to represent free-standing statues or mirrors, or you may hang them over wall sections to represent various wall hangings. When you have set up a room that your players want to use for several hours, you may want to use paperclips to hold the walls, doors, and pillars together.



**Berklai**  
Fourth level fighter

Strength	15	Dexterity	12
Intelligence	16	Constitution	15
Wisdom	9	Charisma	15
Armor Class	4	Hit points	30

**Weapons:** *longsword* \*1, dagger, shortsword

**Equipment:** chain mail and shield; oil flask; 50 feet of rope

**Awas**  
Fourth level magic-user

Strength	8	Dexterity	17
Intelligence	15	Constitution	11
Wisdom	14	Charisma	13
Armor Class	7	Hit points	11

**Weapons:** dagger, quarterstaff

**Equipment:** bullseye lantern; six wax candles; small silver mirror; two bone scroll cases; *dust of disappearance*

**Spells.**

First level: *magic missile*, *read magic*, *sleep*

Second level: *mirror image*, *wizard lock*

**Triak**  
Fifth level cleric

Strength	10	Dexterity	17
Intelligence	12	Constitution	16
Wisdom	14	Charisma	10
Armor Class	2	Hit points	28

**Weapons:** *war hammer* \*1

**Equipment:** splint and shield; small silver mirror; bud of garlic; two silver holy symbols; prayer beads; three wax candles; bone scroll case, three vials of holy water

**Spells.**

First level: *bles*, *cure light wounds*, *protection from evil*

Second level: *chant*, *hold person*, *speak with animals*

Third level: *remove curse*

**Penchuri**  
Fourth level thief

Strength	11	Dexterity	18
Intelligence	9	Constitution	15
Wisdom	12	Charisma	9
Armor Class	3	Hit points	17

**Weapons:** shortsword; two throwing daggers; sling with 20 bullets

**Equipment:** leather armor; thieves' picks and tools; two small sacks, grapple hook; 50 feet of rope; flask of oil; *boots of elvenkind*

**Kuat**  
Third level ranger

Strength	13	Dexterity	14
Intelligence	15	Constitution	15
Wisdom	15	Charisma	14
Armor Class	7	Hit points	23

**Weapons:** longsword; composite bow with 20 arrows (*five arrows* \*1)

**Equipment:** studded leather; trained falcon; 50 feet of rope; oak staff; *cloak of elvenkind*

**Saudara**  
Third level magic-user

(with black cat familiar: AC 7; hp 3)

Strength	9	Dexterity	11
Intelligence	14	Constitution	14
Wisdom	10	Charisma	8
Armor Class	9	Hit points	10

**Weapons:** dagger, five darts

**Equipment:** *cloak of protection* \*1; leather scroll case, two wax candles

**Spells.**

First level: *burning hands*, *magic missile*

Second level: *mirror image*

**Teman**  
Fourth level cleric

Strength	10	Dexterity	10
Intelligence	15	Constitution	10
Wisdom	9	Charisma	8
Armor Class	7	Hit points	22

**Weapon:** mace

**Equipment:** leather armor; silver holy symbol; wooden holy symbol; three vials of holy water; 10 incense sticks; three wax candles

**Spells.**

First level: *cure light wounds* (x2), *light*

Second level: *hold person*, *spiritual hammer*

**Ambil**  
Third level thief

Strength	9	Dexterity	14
Intelligence	10	Constitution	12
Wisdom	14	Charisma	11
Armor Class	6	Hit points	12

**Weapons:** club, dart, dagger, shortsword

**Equipment:** leather armor; *ring of protection* \*2; thieves' picks and tools; grapple hook; 50 feet of rope; iron spike; flask of *oil of slipperness*

ABBREVIATIONS

AC — Armor Class	D — Damage
HD — Hit Dice	Save — Save As
hp — hit points	ML — Morale
MV — Movement	AL — Alignment
#AT — No. of attacks per round	XP — Experience point value
F — Fighter	N — Neutral
C — Chaotic	CE — Chaotic Evil
MU — Magic-user	NE — Neutral Evil
SA — Special Attack	SD — Special Defense
NM — Normal Man	S — Strength
I — Intelligence	W — Wisdom
DX — Dexterity	CN — Constitution
CH — Charisma	

MONSTER STATISTICS

Monster statistics are listed in the following order:

Monster/NPC Name (No. appearing, if more than one); Armor Class; Hit Dice or Class/Level; hit points; Movement per turn (round); No. of attacks per round; Damage; Save As; Class/Level; Morale; Alignment; Experience Point value; Special Attacks; Special Defenses; and special abilities or spells

*Important:* In all cases except Damage listings, statistics that precede a slash (/) mark pertain to D&D® rules, and statistics that follow a slash mark pertain to AD&D™ rules.

©1984 TSR, Inc. All Rights Reserved.

©1984 TSR, Inc. All Rights Reserved.





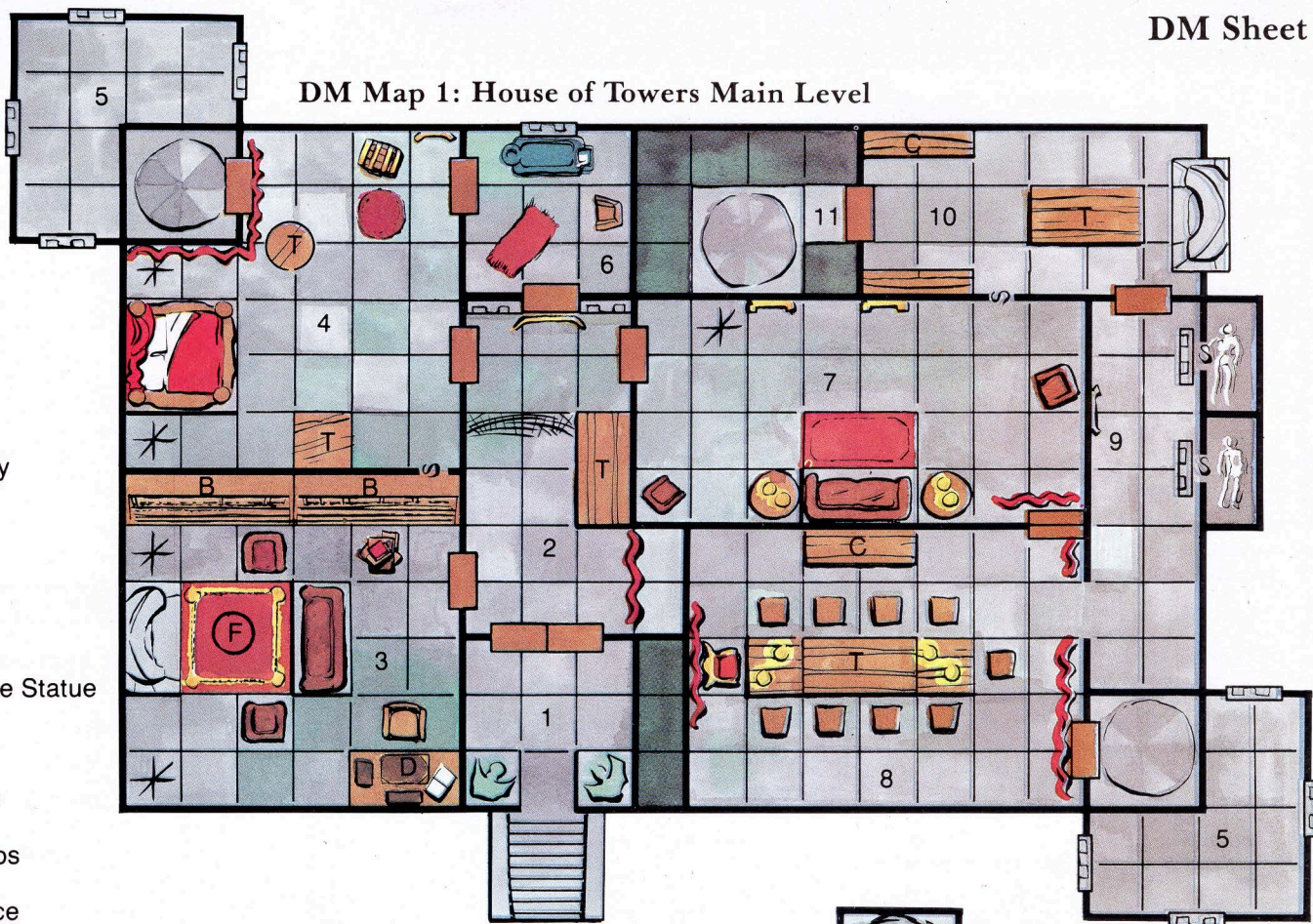



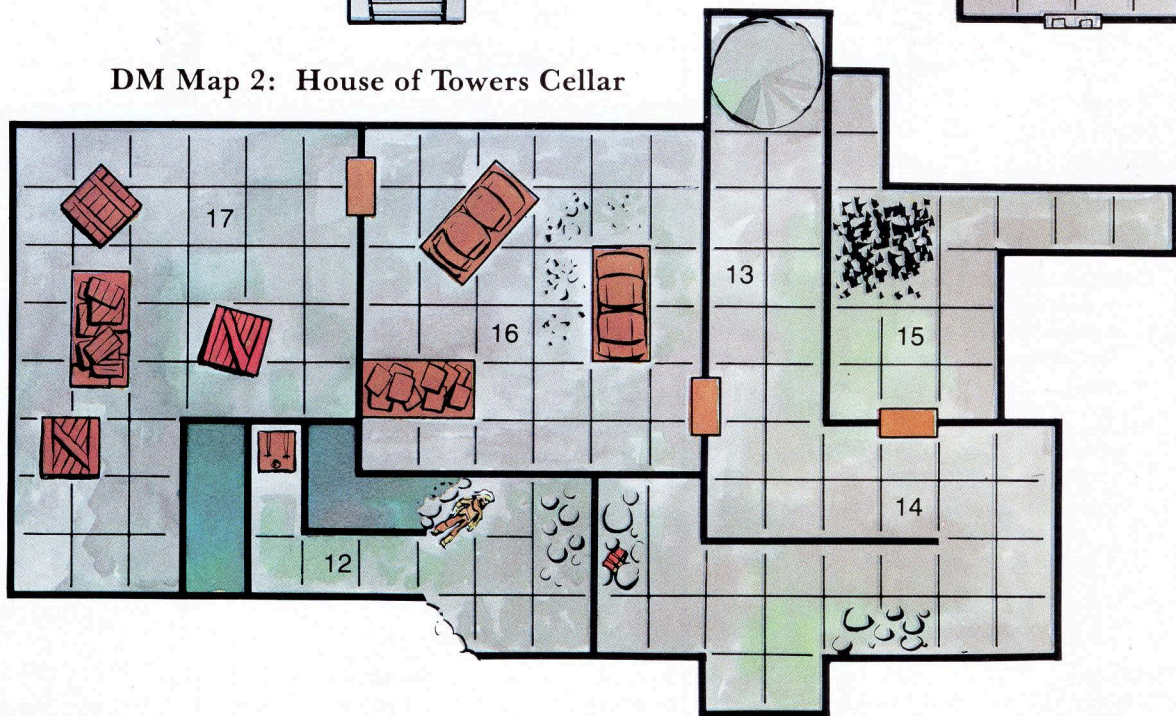



















DM Map 1: House of Towers Main Level



DM Map 2: House of Towers Cellar



KEY

-  Stairs
-  Body
-  Rug
-  Tapestry
-  Chairs
-  Bed
-  Chest
-  Gargoyle Statue
-  Table
-  Cabinet
-  Cobwebs
-  Fireplace
-  Bookshelf
-  Extinguished Candelabra
-  Desk
-  Secret Door
-  Curtain
-  Spiral Staircase
-  Bricked-up Window
-  Hanging Mirror
-  Locked Door
-  Candles
-  Door
-  Double Doors
-  Hanging Picture
-  Flock of Bats

-  Stack of Casks
-  Broken Glass
-  Rocky Rubble
-  Stack of Boxes
-  Trapdoor in Floor
-  Solid Stone
-  Box
-  Skeleton
-  Trapdoor in Ceiling
-  Chest Beneath Rubble

































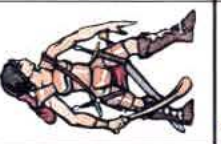













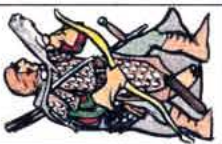





Scale: 1 square=5 feet



# 3-D Figure Sheet 1

Cut along heavy solid lines. Fold along light solid lines.

©1984 TSR, Inc. All Rights Reserved.

Apply glue to this panel. <b>Wererat</b>	Apply glue to this panel. <b>Wererat</b>	Apply glue to this panel. <b>Ghoul</b>	Apply glue to this panel. <b>Ghoul</b>	Apply glue to this panel. <b>Ghoul</b>	Apply glue to this panel. <b>Ghoul</b>
					
					
					
Apply glue to this panel. <b>Princess Arelina</b>	Apply glue to this panel. <b>Male Magic-user</b>	Apply glue to this panel. <b>Male Fighter</b>	Apply glue to this panel. <b>Male Fighter</b>	Apply glue to this panel. <b>Ambil</b>	Apply glue to this panel. <b>Temam</b>
					
					
					
Apply glue to this panel. <b>Saudara</b>	Apply glue to this panel. <b>Kuat</b>	Apply glue to this panel. <b>Penchuri</b>	Apply glue to this panel. <b>Triak</b>	Apply glue to this panel. <b>Awam</b>	Apply glue to this panel. <b>Berkelai</b>
					
					
					

MONSTER FIGURES

CHARACTER FIGURES

CHARACTER FIGURES





# 3-D Figure Sheet 2

©1984 TSR, Inc. All Rights Reserved.













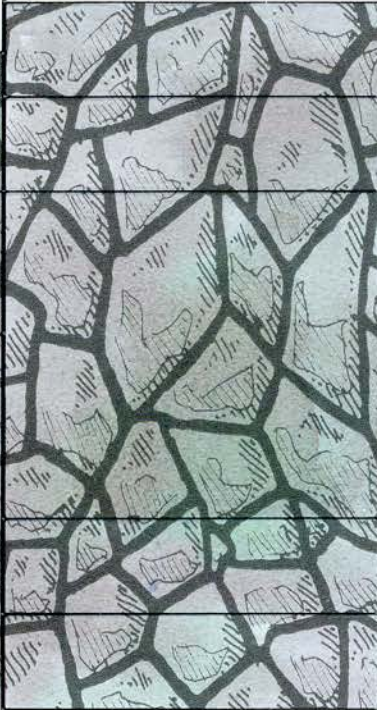

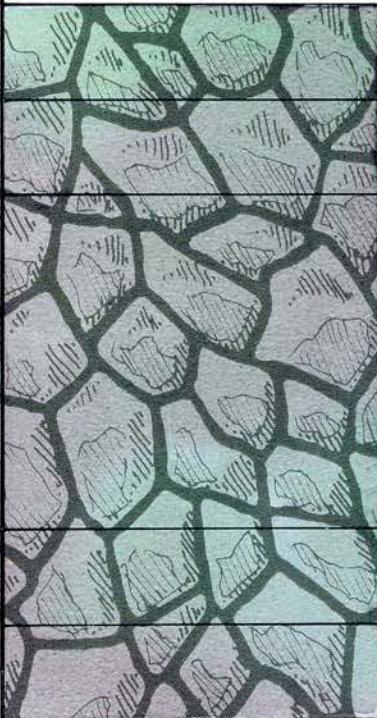

Cut along heavy solid lines. Fold along light solid lines.

## LONG WALL SECTION 1

## LONG WALL SECTION 2

## SHORT WALL SECTIONS 1 & 2

## HANGING FIGURES

Apply glue to this panel.	Apply glue to this panel.	Apply glue to this panel.	Sword Figure	Tapestry Figure
			Curtain Figure	Mirror Figure
			Window Figure	Window Figure
				
		Apply glue to this panel.		
		Apply glue to this panel.		
Apply glue to this panel.	Apply glue to this panel.			
Apply glue to this panel.	Apply glue to this panel.			
				
Apply glue to this panel.	Apply glue to this panel.	Apply glue to this panel.		



### 3-D Figure Sheet 3

Cut along heavy solid lines.  
Fold along light solid lines.

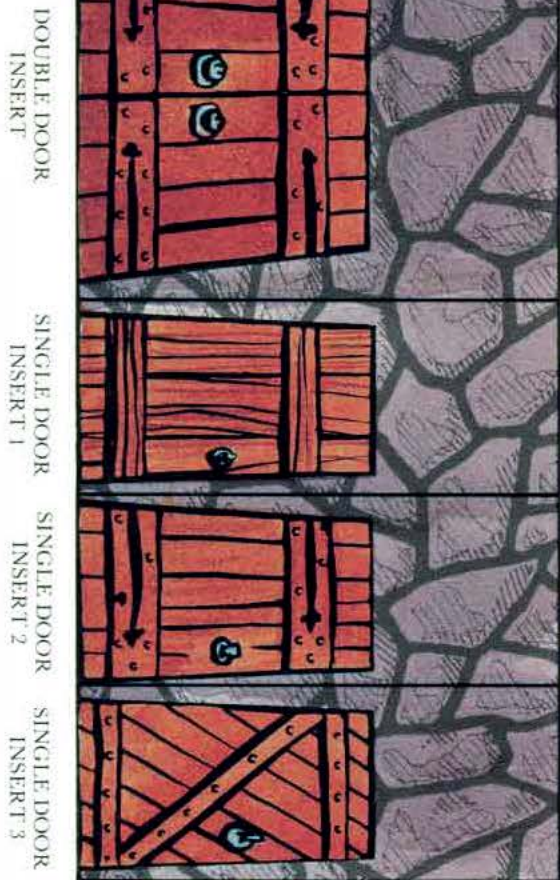

©1984 TSR, Inc. All Rights Reserved.

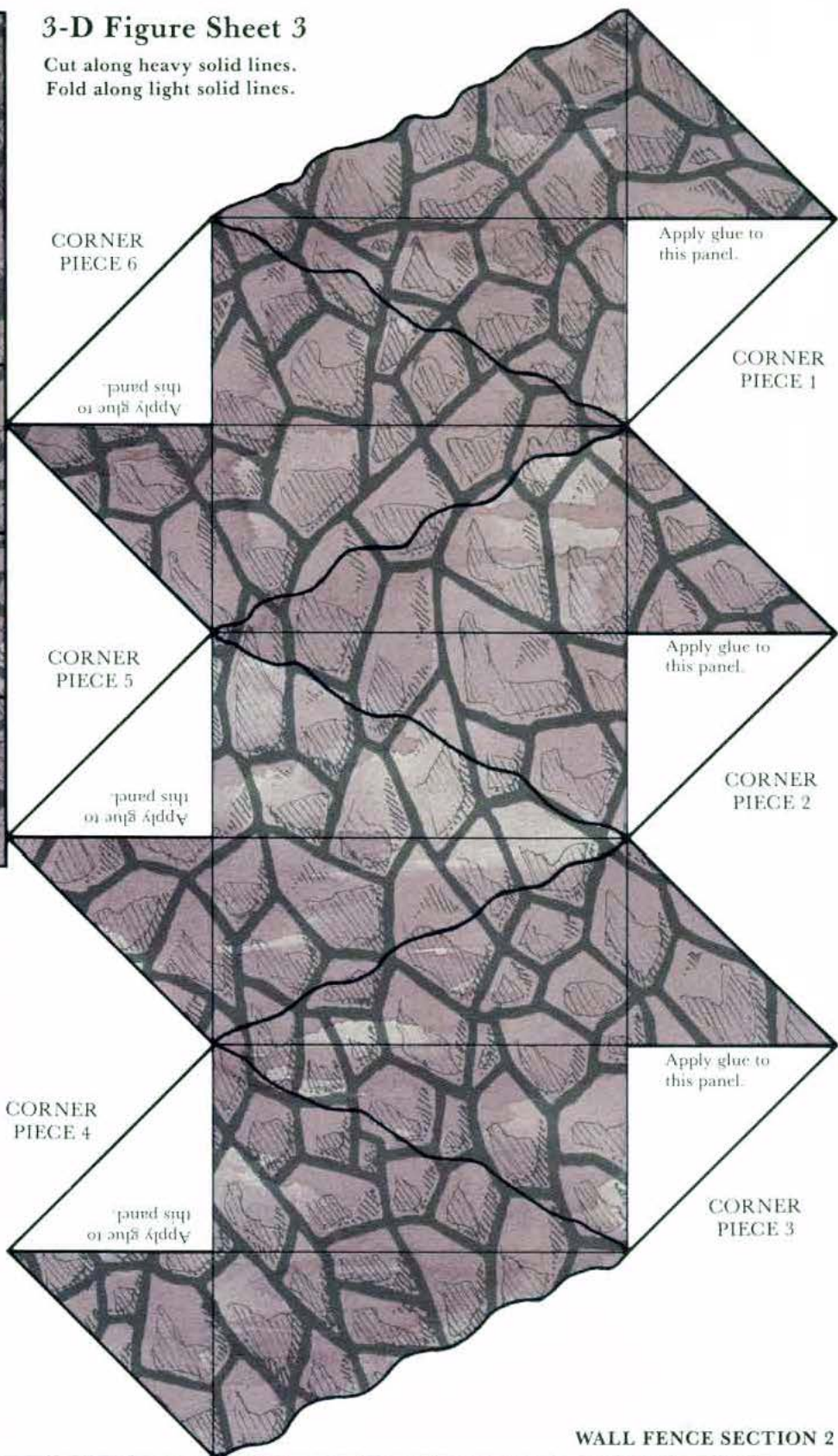

WALL FENCE SECTION 2

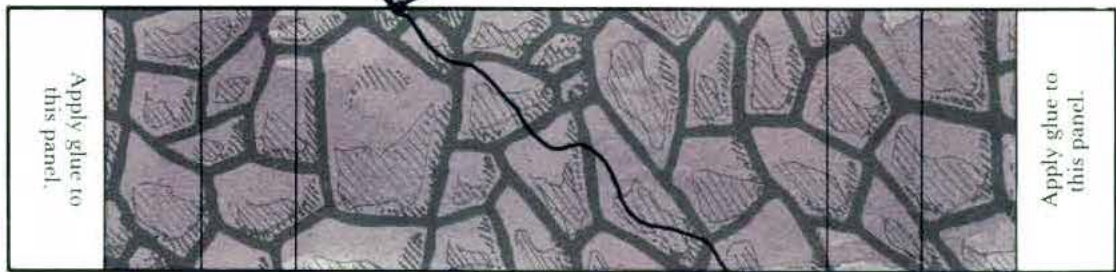

WALL FENCE SECTION 1



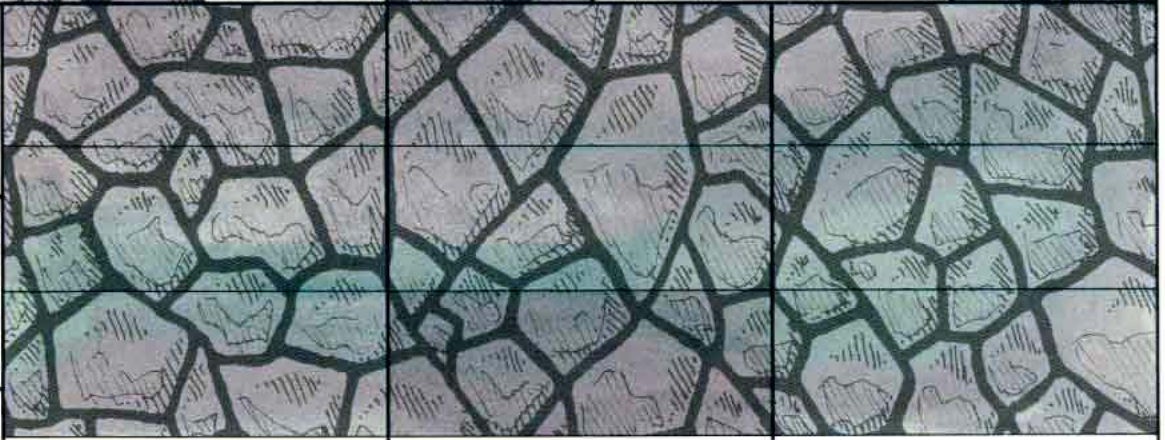
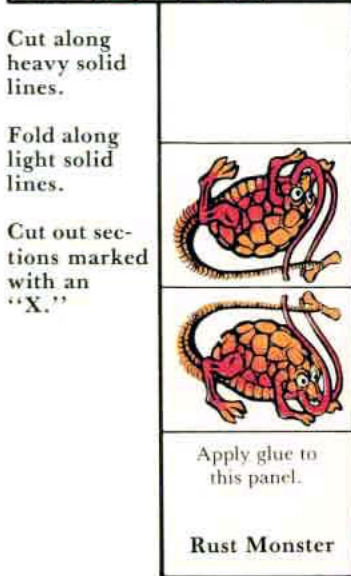
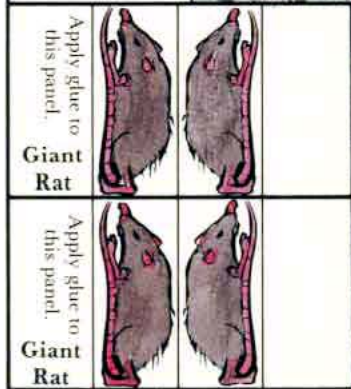
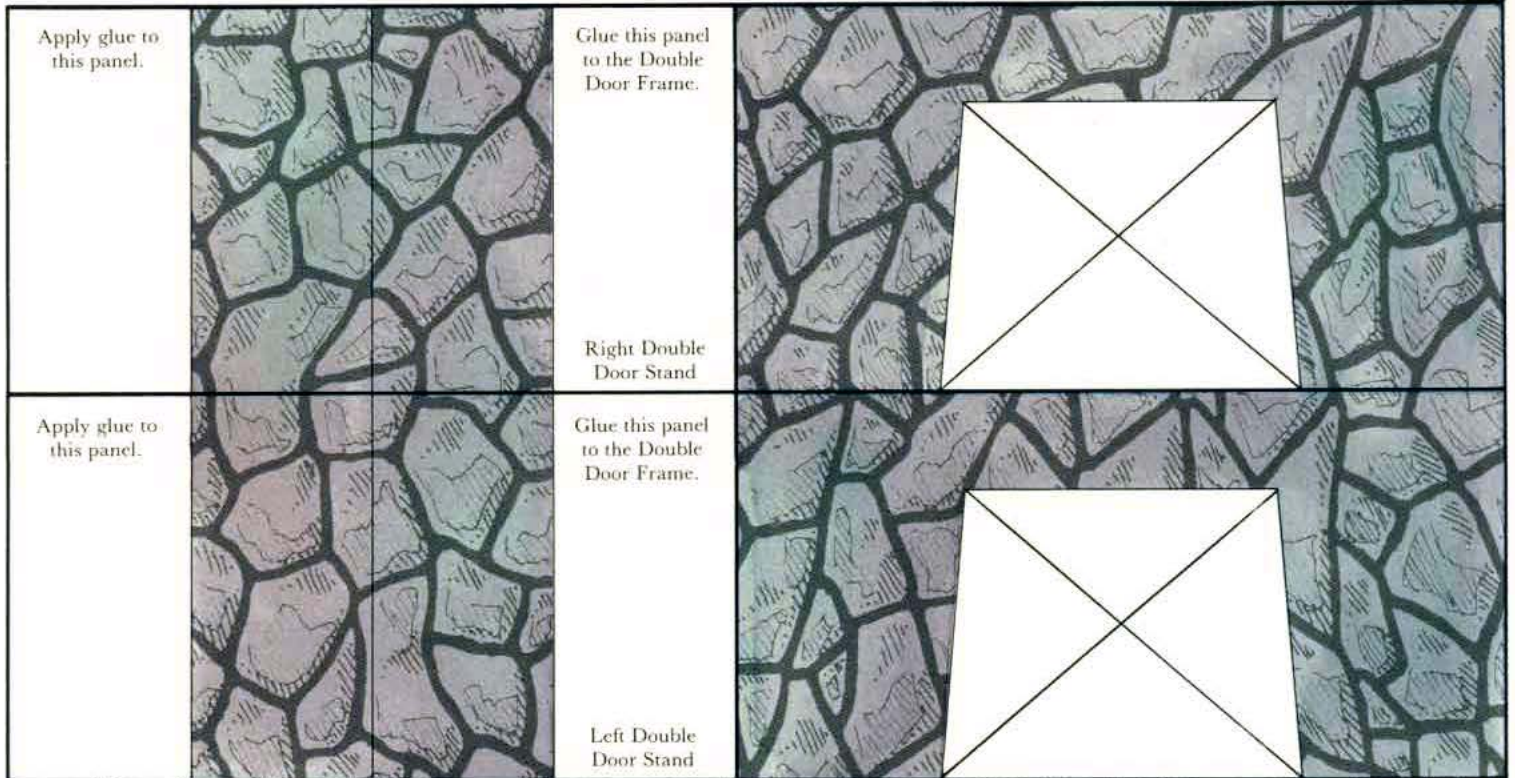

Apply glue to this panel. <b>PILLAR FIGURE 1</b>	Apply glue to this panel. <b>PILLAR FIGURE 2</b>	Apply glue to this panel. <b>PILLAR FIGURE 3</b>
---	---	---

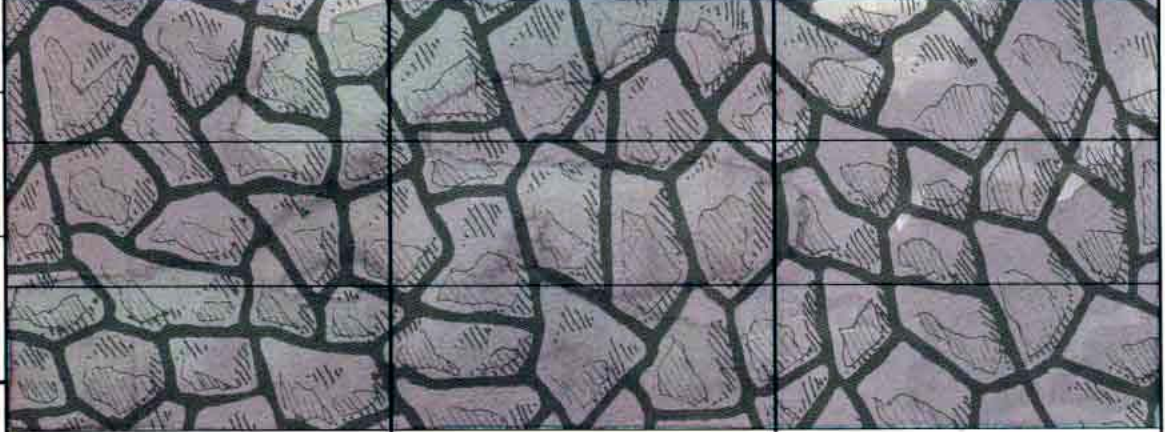

Apply glue to this panel. <b>PILLAR FIGURE 4</b>	Apply glue to this panel. <b>PILLAR FIGURE 5</b>	Apply glue to this panel. <b>PILLAR FIGURE 6</b>
---	---	---

3-D Figure Sheet 4

©1984 TSR, Inc. All Rights Reserved.

PILLAR FIGURES



Cut out sections marked with an "X."

SINGLE DOOR FRAMES 1A, 2A, & 3A

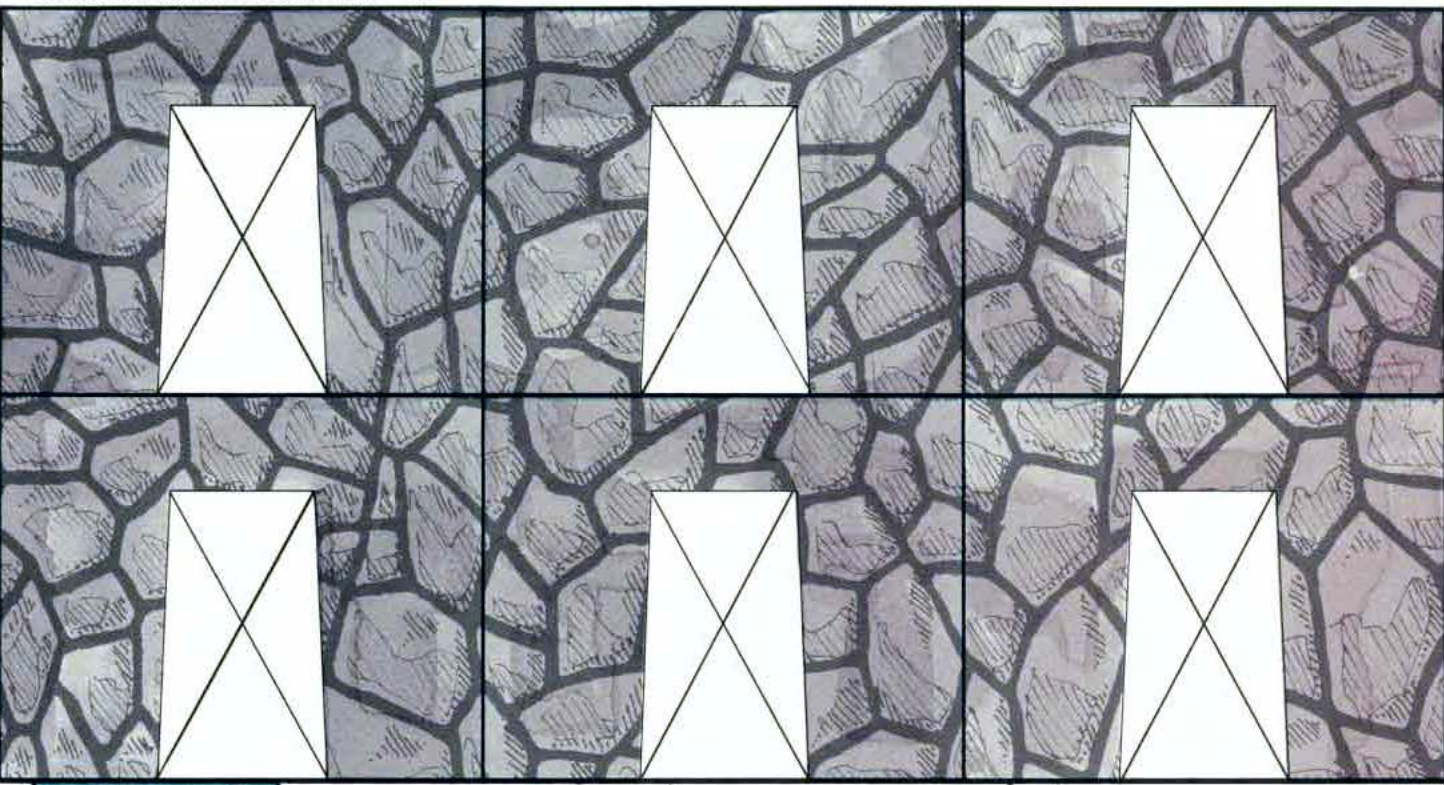

SINGLE DOOR FRAMES 1B, 2B, & 3B

	<p><b>SINGLE DOOR FRAME 1 - LEFT STAND</b> Glue this panel to Single Door Frame 1.</p>	<p><b>SINGLE DOOR FRAME 2 - LEFT STAND</b> Glue this panel to Single Door Frame 2.</p>	<p><b>SINGLE DOOR FRAME 3 - LEFT STAND</b> Glue this panel to Single Door Frame 3.</p>
<p>Apply glue to this panel. <b>Skeleton</b></p>	<p>Apply glue to this panel.</p>	<p>Apply glue to this panel.</p>	<p>Apply glue to this panel.</p>
	<p><b>SINGLE DOOR FRAME 1 - RIGHT STAND</b> Glue this panel to Single Door Frame 1.</p>	<p><b>SINGLE DOOR FRAME 2 - RIGHT STAND</b> Glue this panel to Single Door Frame 2.</p>	<p><b>SINGLE DOOR FRAME 3 - RIGHT STAND</b> Glue this panel to Single Door Frame 3.</p>
<p>Apply glue to this panel. <b>Skeleton</b></p>	<p>Apply glue to this panel.</p>	<p>Apply glue to this panel.</p>	<p>Apply glue to this panel.</p>

3-D Figure Sheet 5

Cut along heavy solid lines. Fold along light solid lines.



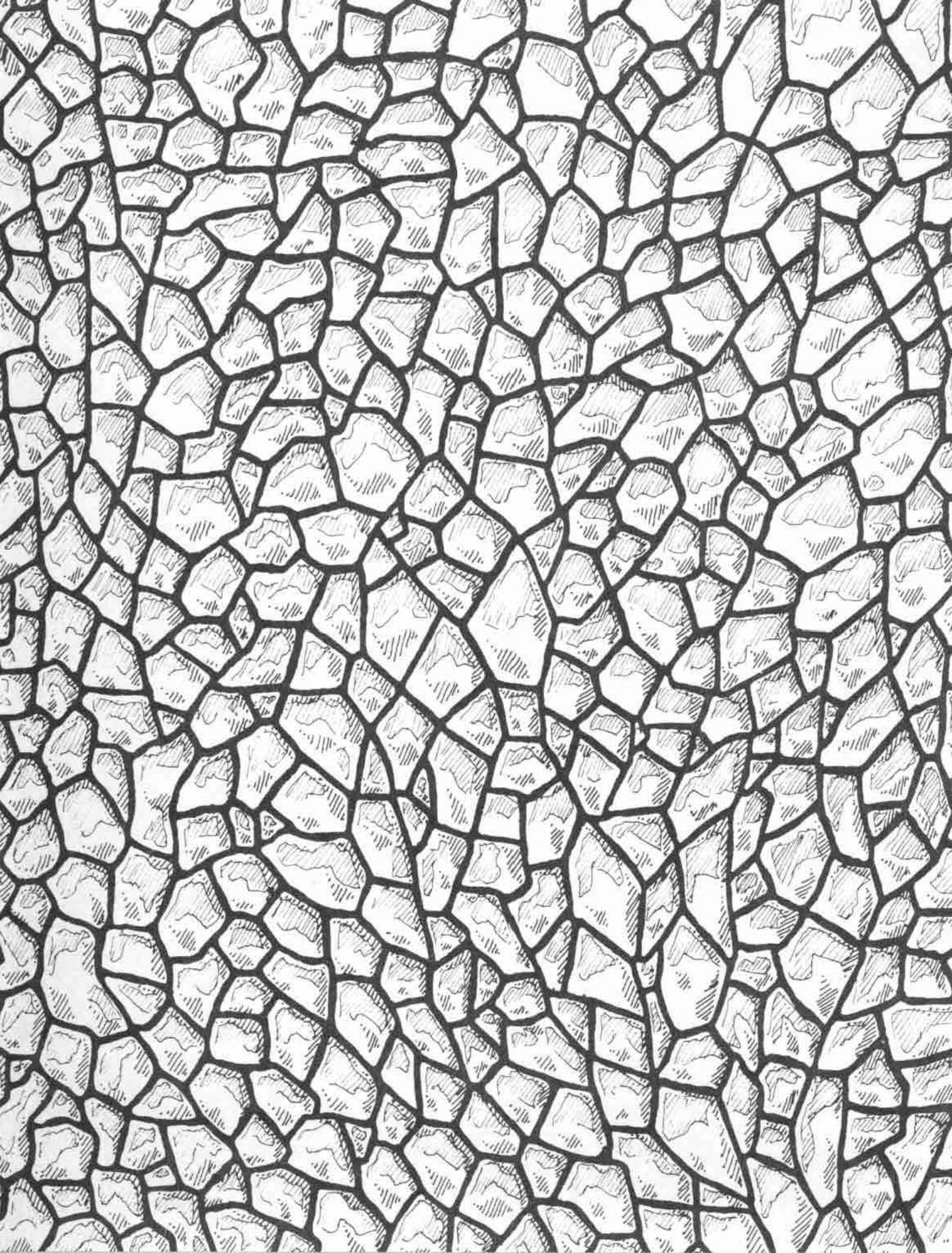

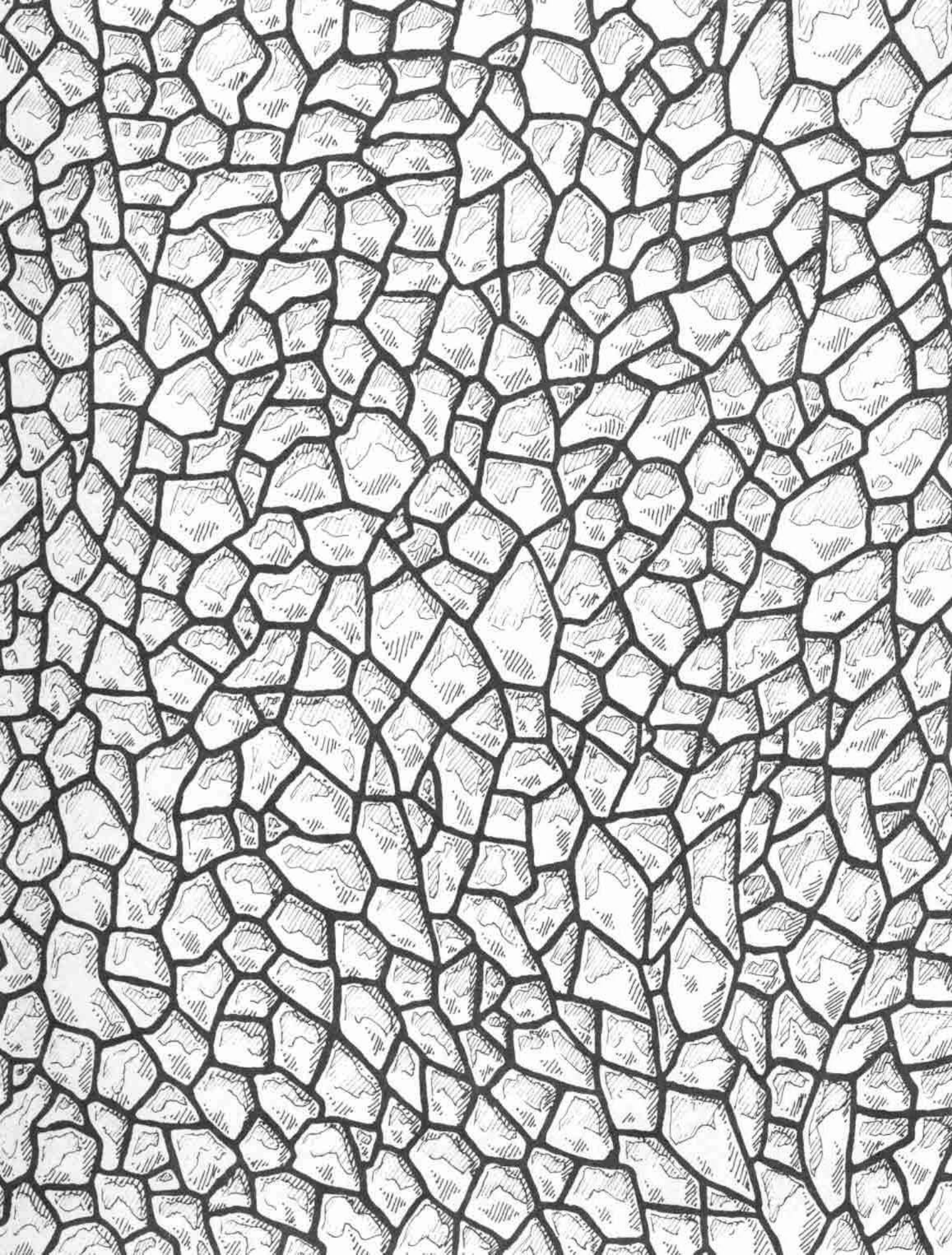



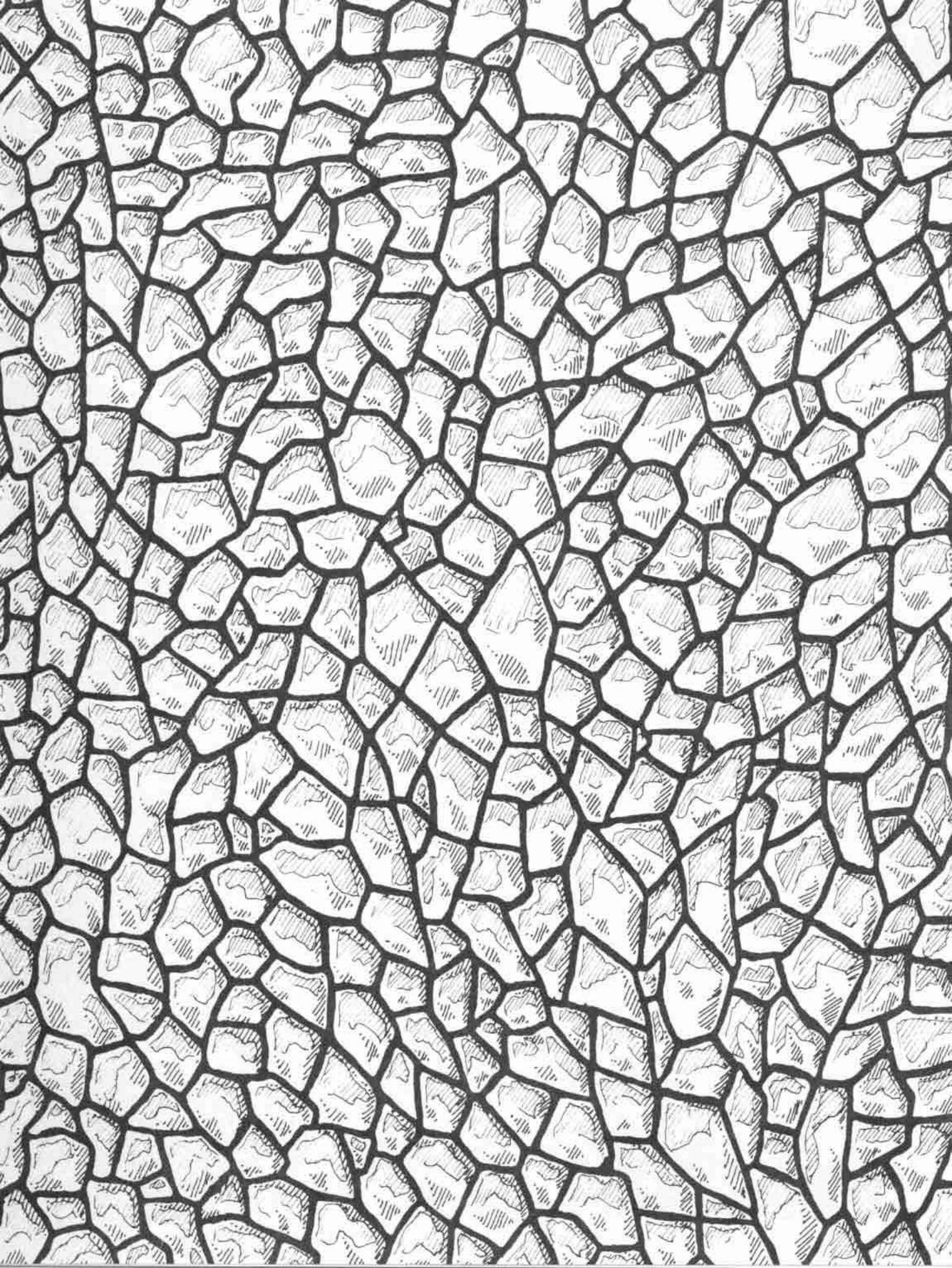



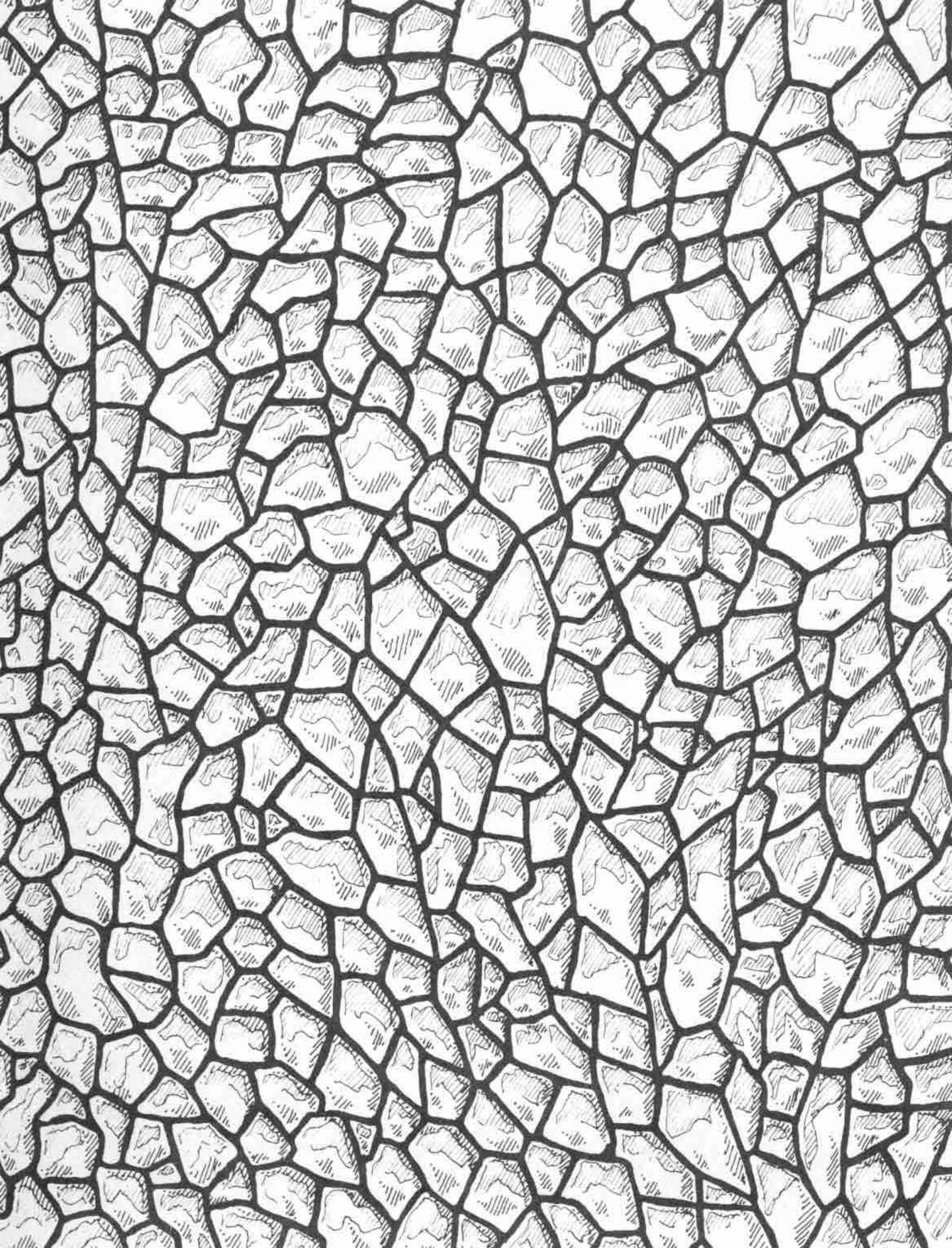



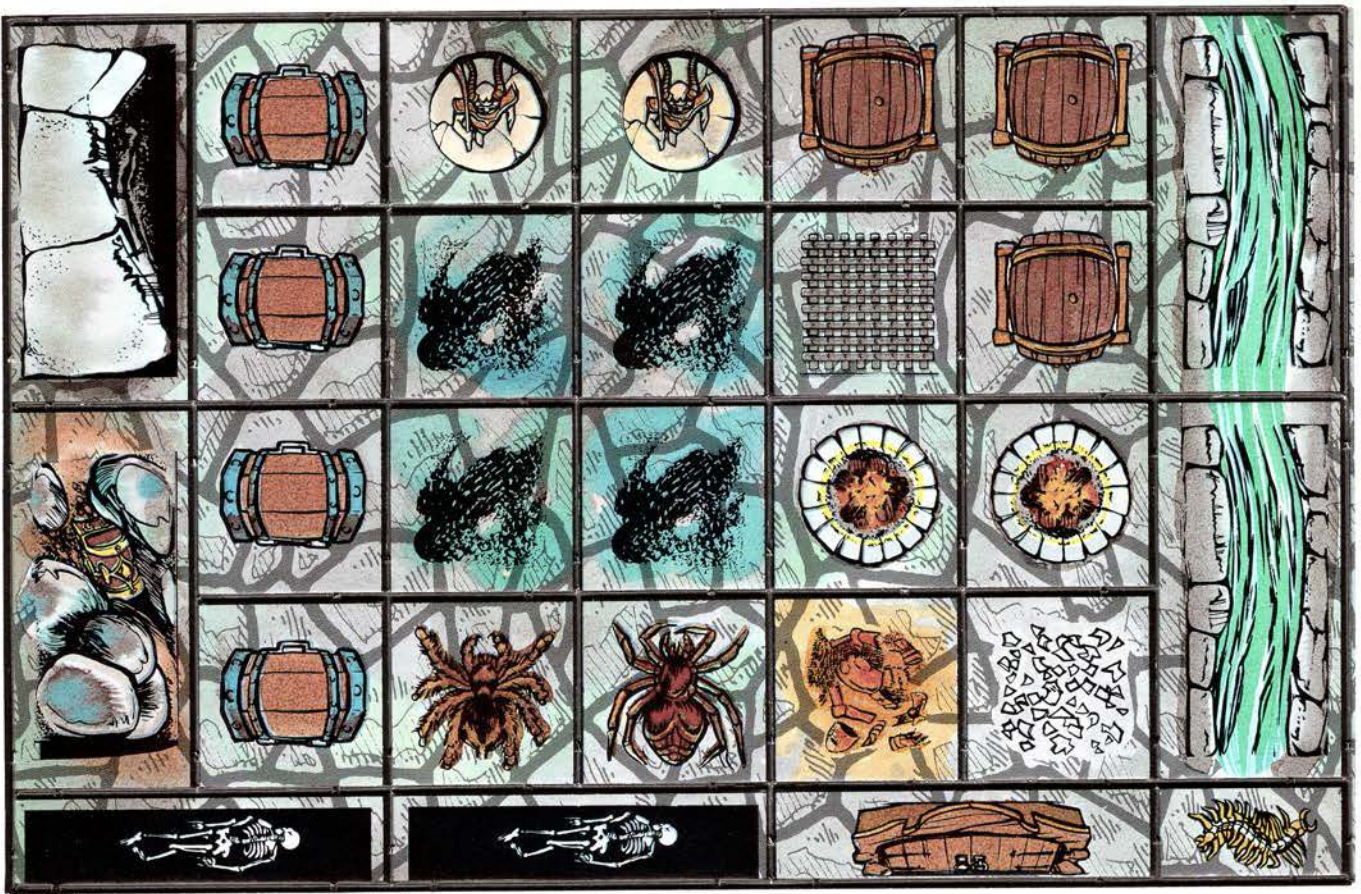

3-D DRAGON TILES

2-D FEATURE TILE SHEET 1

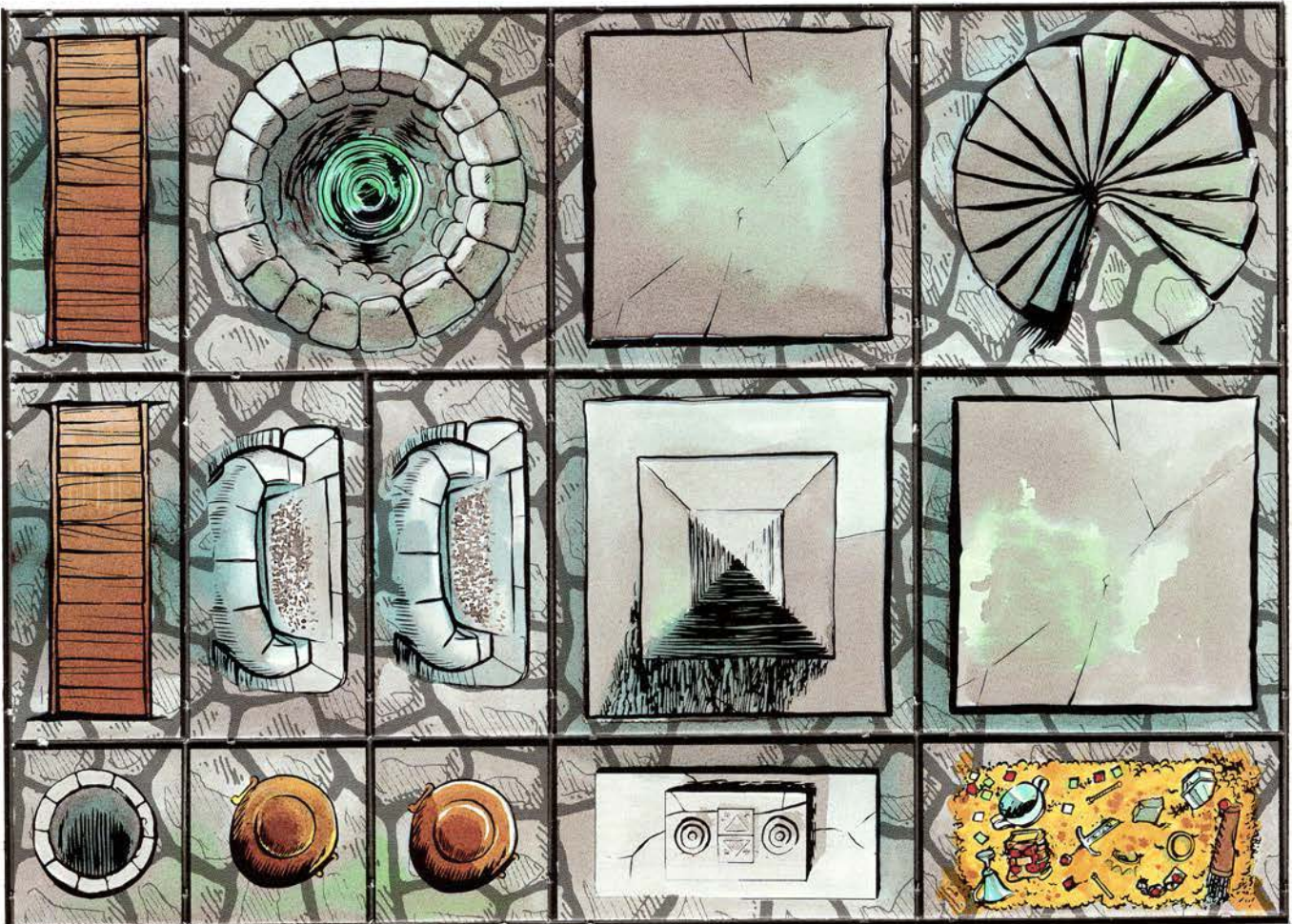



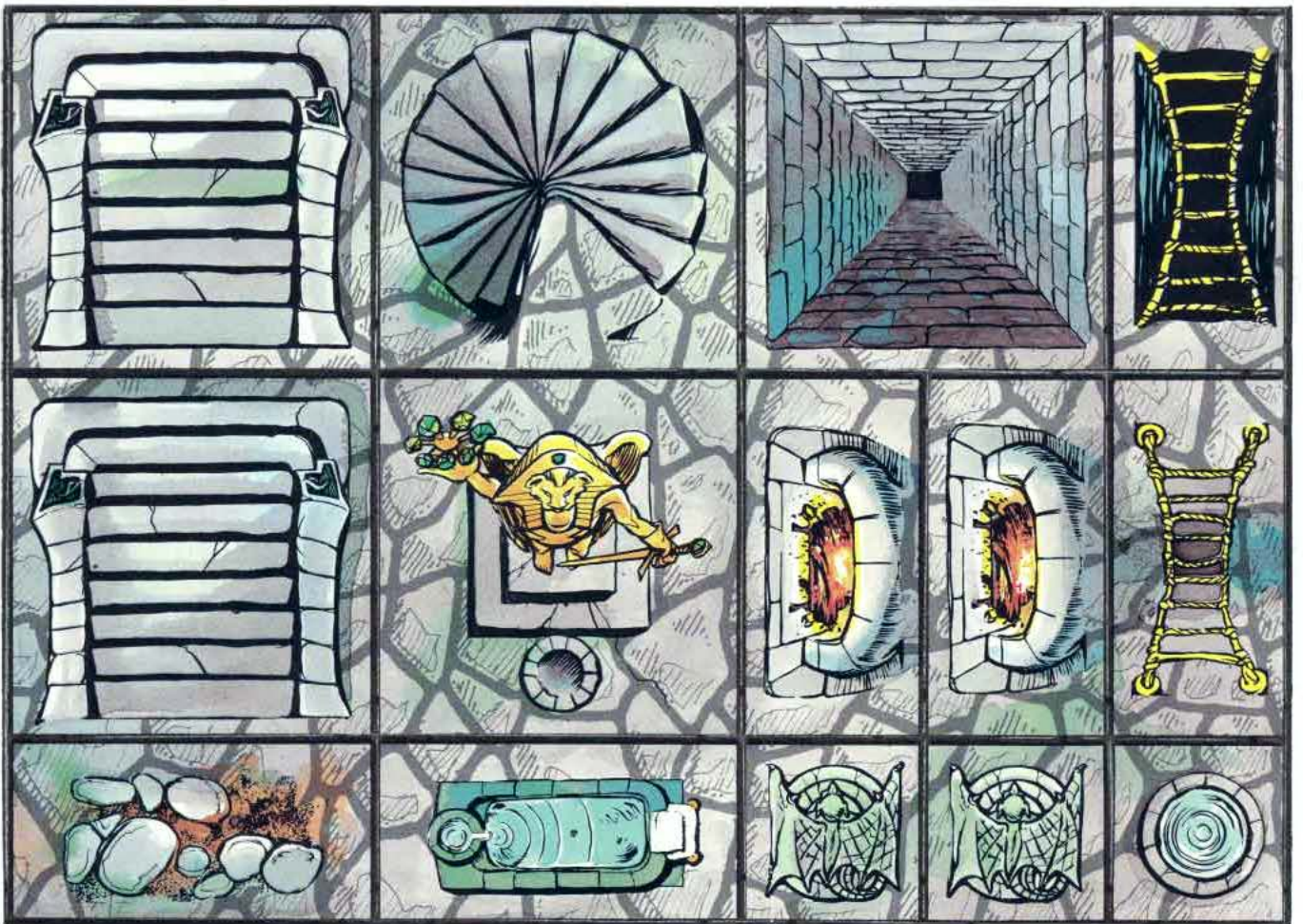
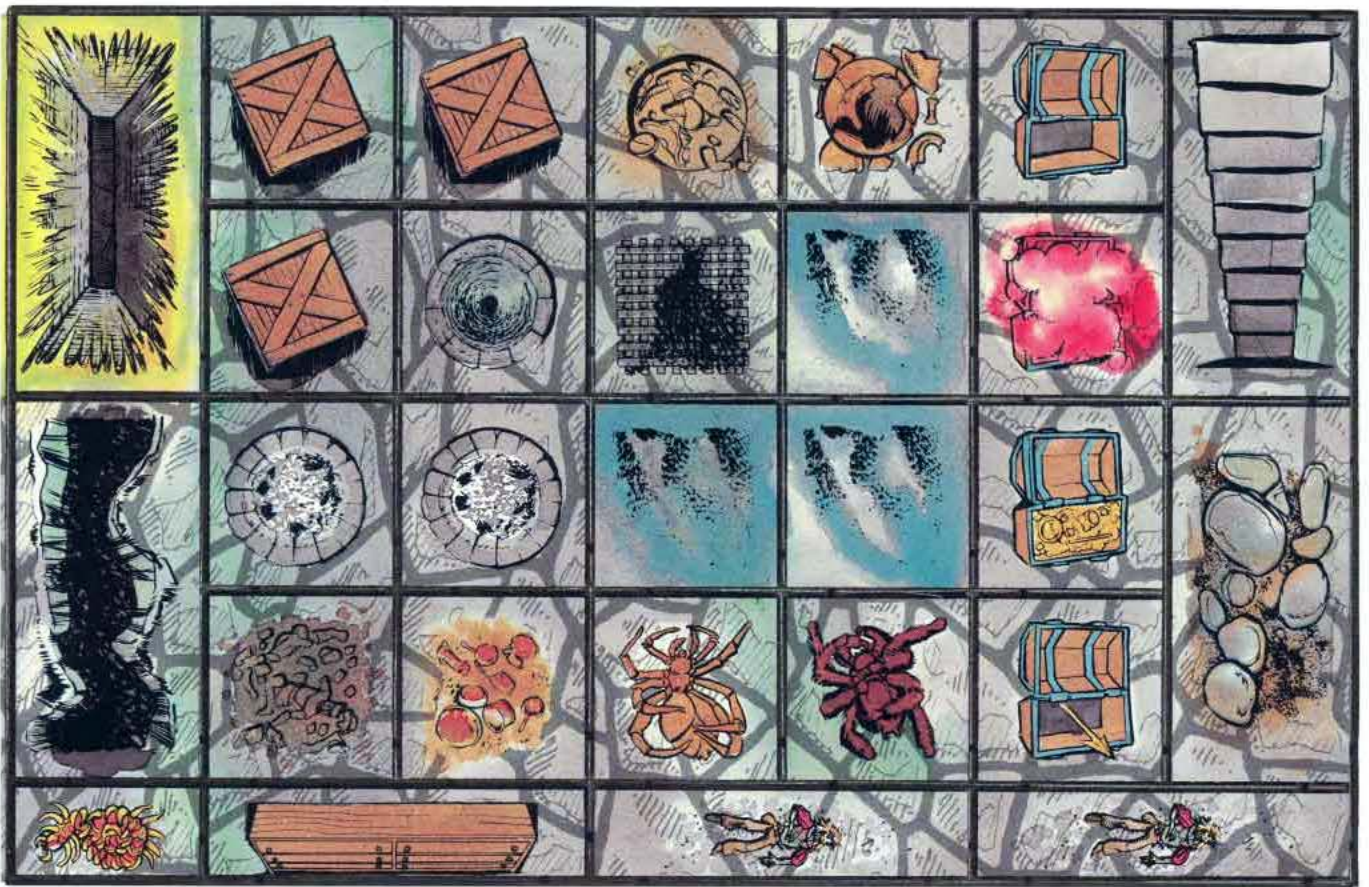





3-D DRAGON TILES

2-D FEATURE TILE SHEET 2

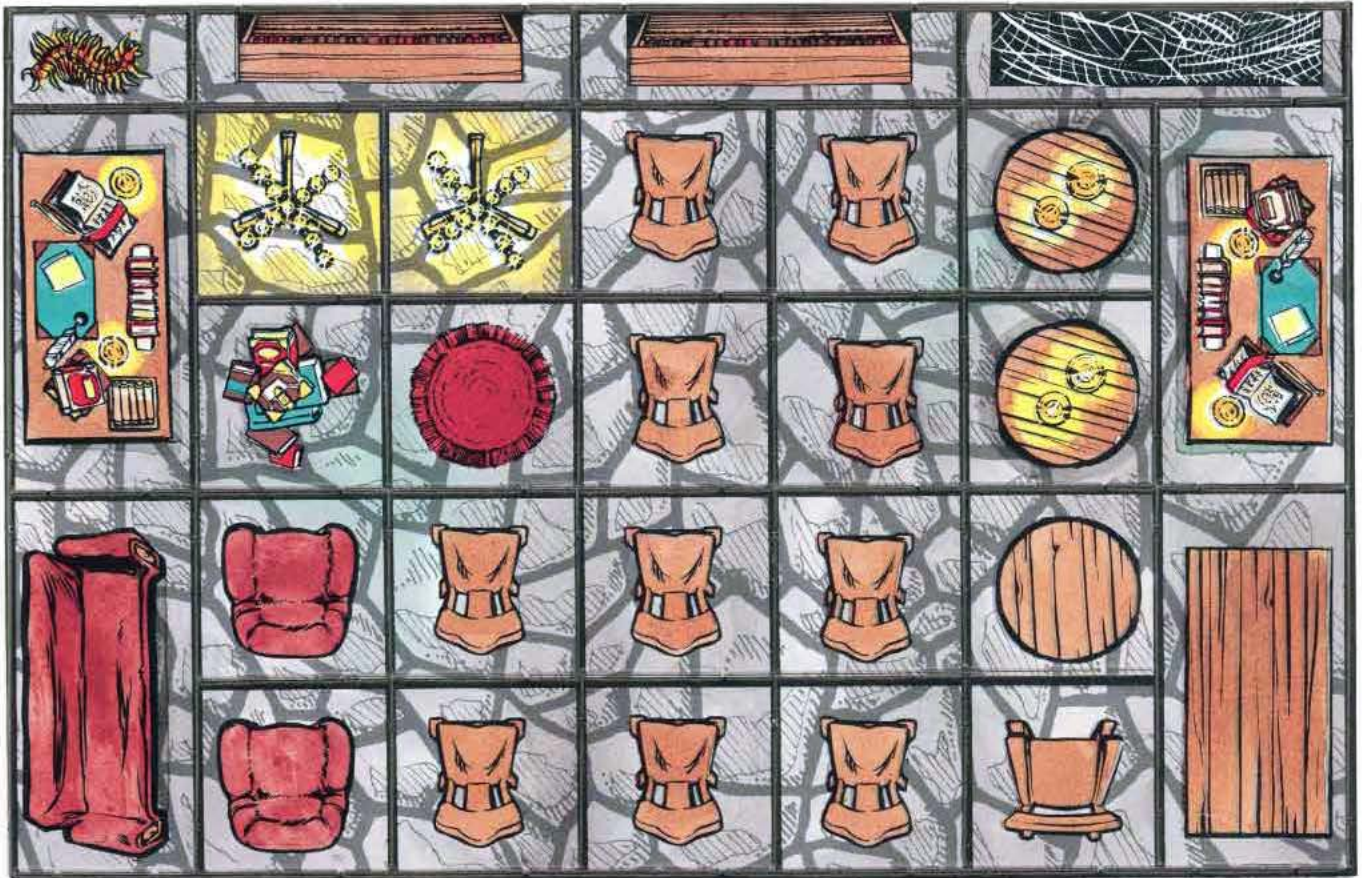



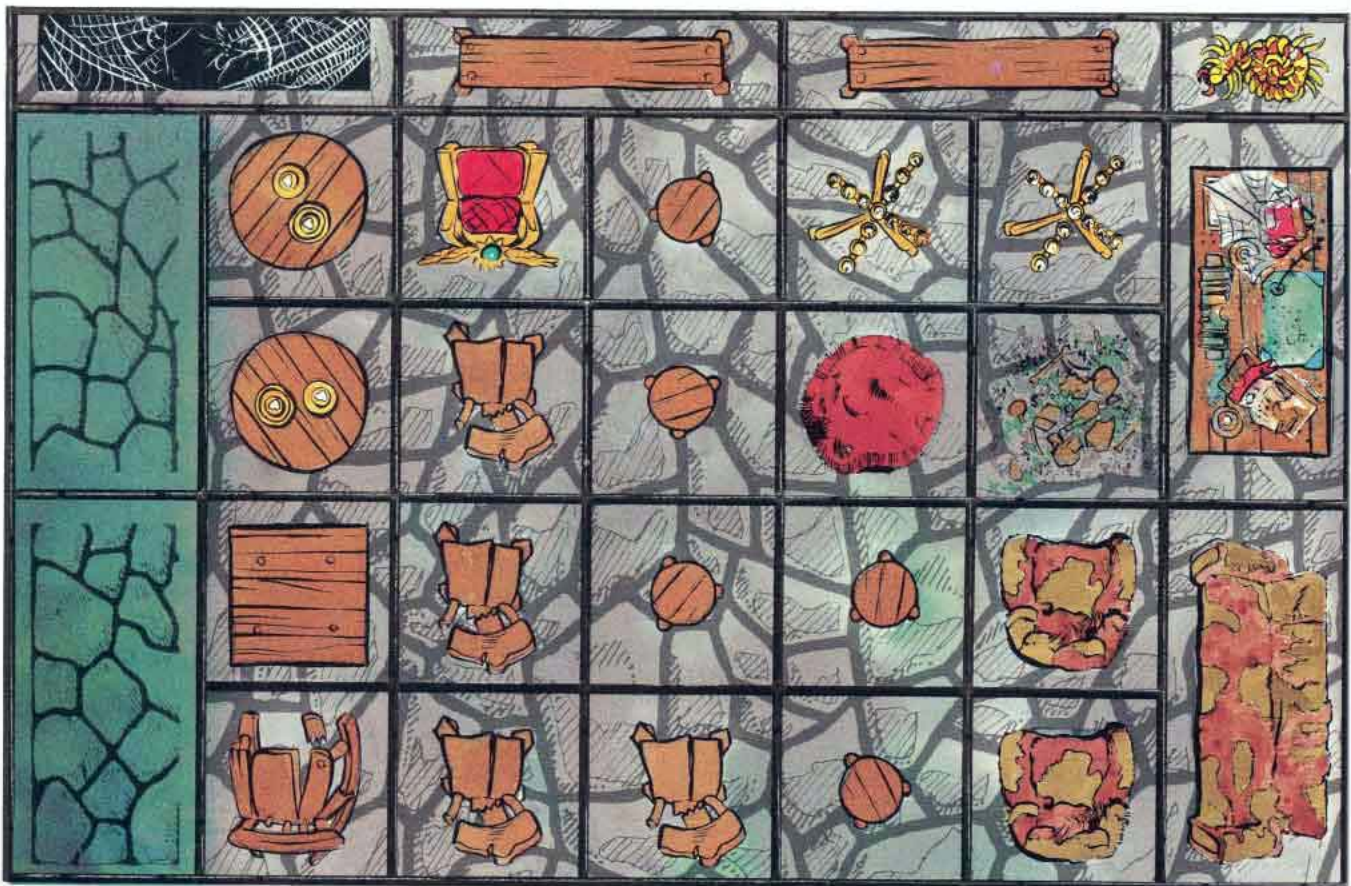
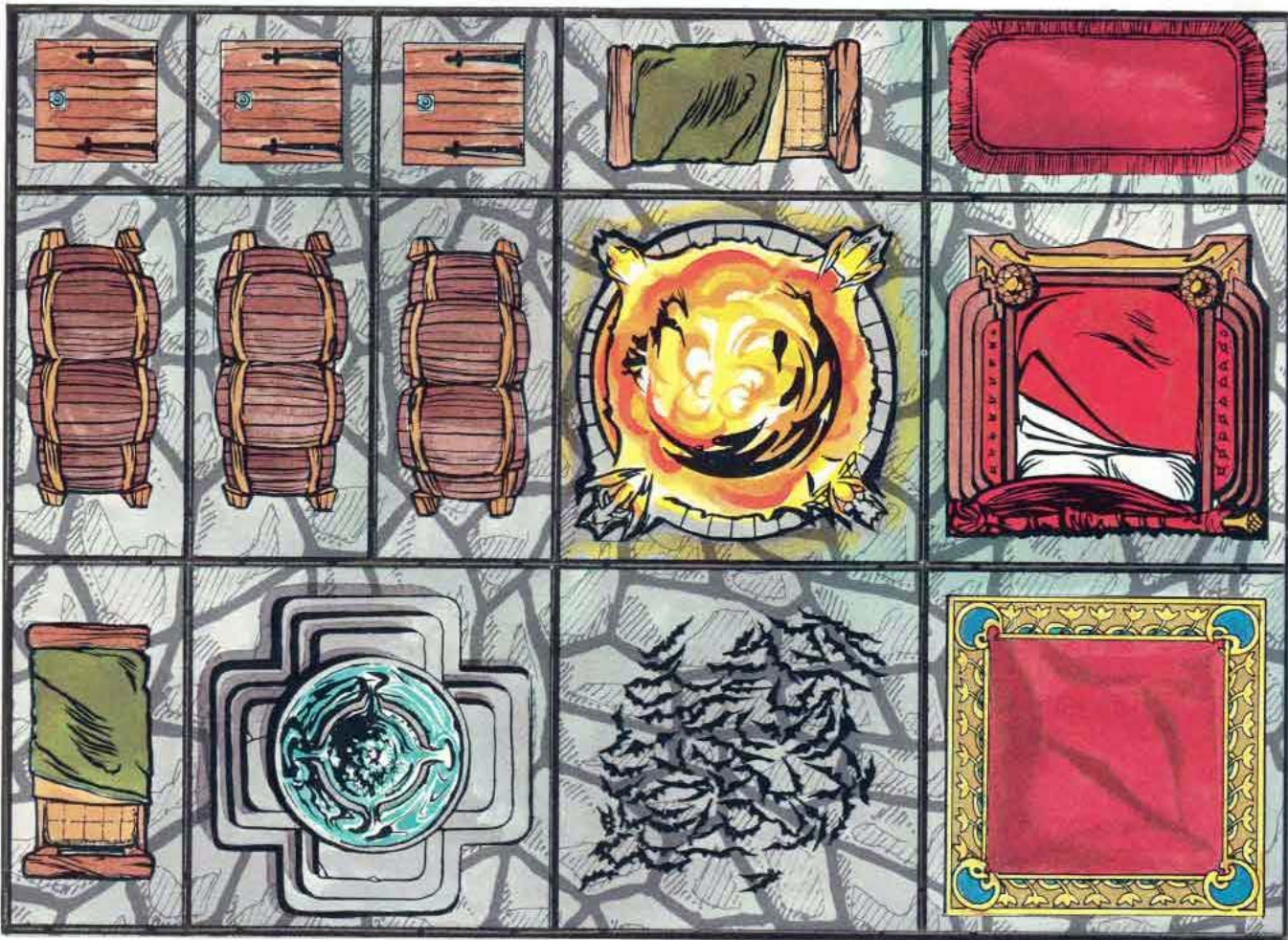



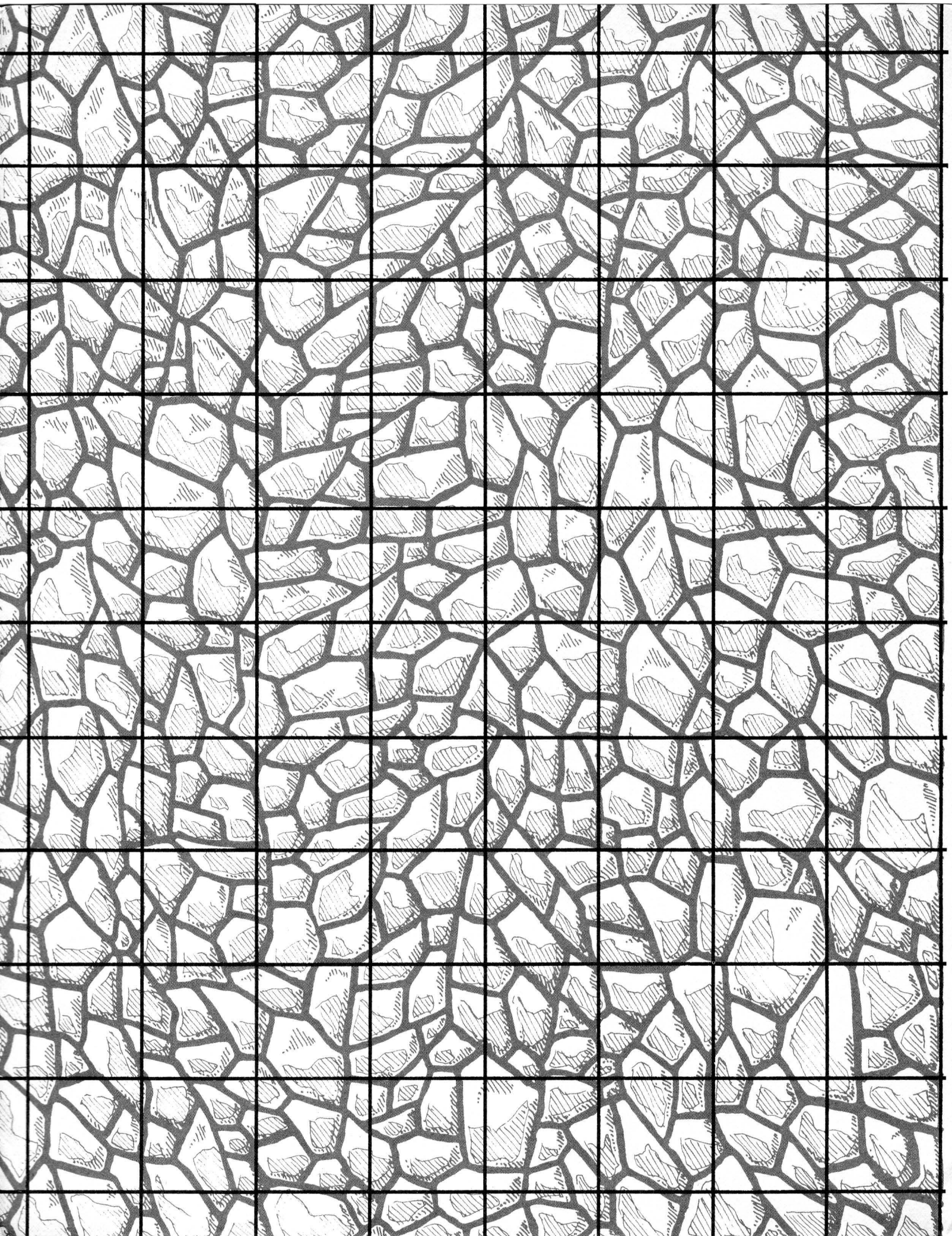





**3-D DRAGON TILES** featuring

---

**The Kidnapping of Princess Arelina**  
by Garry Spiegle

---

Your party moves stealthily up the dark hallway. Torn cobwebs dangle from the ceiling; to the south, a huge, iron door creaks eerily in the mysterious wind. A massive iron gate crashes down, blocking the corridor ahead!

Wait a minute. The pencil broke.

Mapping dungeons is quick, easy, and exciting with the 3-D Dragon Tiles. Use the Dragon Tiles to bring your DUNGEONS & DRAGONS® and ADVANCED DUNGEONS & DRAGONS® adventures to life.

This package includes 51 3-D figures, featuring characters, creatures, walls, and doors. Two sheets of 84 two-sided feature tiles, showing traps, treasures, furniture, and special surprises, are also included. A Dungeon Mapping Grid is provided to help you lay out dungeons quickly.

The 3-D Dragon Tiles also comes with a special D&D®/AD&D™ adventure, "The Kidnapping of Princess Arelina."

Can't find an eraser? Don't worry. Leave the dungeons to us.

---

1984 TSR, Inc. All Rights Reserved. Printed in U.S.A.

TSR, Inc.  
POB 756  
Lake Geneva, WI  
53147

TSR (UK) Ltd.  
The Mill, Rathmore Road  
Cambridge CB14AD  
United Kingdom

ISBN 0-88038-108-6  
394-54143-XTSR0800

