

Official **Advanced
Dungeons & Dragons®**

BATTLETM **SYSTEM**

Fantasy Combat Supplement



TSR, Inc.

PRODUCTS OF YOUR IMAGINATION™

ADVANCED DUNGEONS & DRAGONS and **DUNGEONS & DRAGONS** are registered trademarks owned by TSR, Inc. **BATTLESYSTEM**, **PRODUCTS OF YOUR IMAGINATION**, and the **TSR** logo are trademarks owned by TSR, Inc.

BATTLE

SYSTEM™

Fantasy Combat Supplement

Table of Contents

PART 1. INTRODUCTION TO BATTLESYSTEM™

- [1.0] SEQUENCE OF PLAY
- [2.0] COUNTERS, SCALE AND UNIT ORGANIZATION
- [3.0] SETTING UP
- [4.0] MORALE, DISCIPLINE AND COMMAND

PART 2. THE BASIC GAME

- [5.0] INITIATIVE PHASE
- [6.0] RALLY PHASE
- [7.0] MOVEMENT PHASE
- [8.0] MELEE PHASE

PART 3. THE INTERMEDIATE GAME

- [9.0] HEROES AND COMMANDERS
- [10.0] MISSILES AND ARTILLERY
- [11.0] SPECIAL MOVEMENT

PART 4. THE ADVANCED GAME

- [12.0] WEATHER CONDITIONS AND NIGHT BATTLES
- [13.0] SPECIAL CREATURE ABILITIES
- [14.0] MAGIC
- [15.0] FLYING MOVEMENT AND COMBAT
- [16.0] CAMPAIGN RULES



**BATTLESYSTEM™
FANTASY COMBAT
SUPPLEMENT**

Douglas MILES
Game Design

Michael DOBSON
Coordination/Editing

John C. MEYERS
Graphic Design

Jeff EASLEY
Cover Art

Dennis KAUTH
3-D Figures

Steve WINTER
The "Art of
3-D Gaming"
Booklet

Dave LAFORCE

Dave SUTHERLAND
Cartography

Doug HAMM
Photography

**DESIGN CONSULTING
AND ADVICE**

Zeb Cook

Bruce Nesmith

Jon Pickens

Frank Mentzer

Michael Dobson

PLAYTESTING

Bruce Nesmith

Zeb Cook

Steve Winter

Curtis Smith

Jeff Grubb

Jon Pickens

Ed Sellers

Bob Maurus

Bruce Heard

© 1985 TSR, Inc. All Rights Reserved. This game is protected under the copyright laws of the United States of America. Any reproduction or other unauthorized use of the material or artwork contained here is prohibited without the express written consent of TSR, Inc.

Distributed to the book trade in the United States by Random House, Inc., and in Canada by Random House of Canada, Ltd. Distributed to the toy and hobby trade by regional distributors. Distributed in the United Kingdom by TSR UK Ltd.

ADVANCED DUNGEONS & DRAGONS, DUNGEONS & DRAGONS, AD&D and D&D are registered trademarks owned by TSR, Inc. BATTLESYSTEM, PRODUCTS OF YOUR IMAGINATION, and the TSR logo are trademarks owned by TSR, Inc.

TSR, Inc.
POB 756 Lake Geneva, Wt 53147

TSR UK Ltd.
The Mill, Rathmore Road, Cambridge CB1 4AD United Kingdom
Printed in U.S.A. First Printing—March 1985.

INTRODUCTION

The BATTLESYSTEM™ Fantasy Combat Supplement allows you to create fantastic armies on the field of battle! You command troops and heroes in a war against the forces of darkness!

The BATTLESYSTEM™ game is a mass combat accessory for both the AD&D® and D&D® game systems. You must have either the AD&D® game rulebooks or at least one of the D&D® boxed sets in order to play. You must play the BATTLESYSTEM™ game with either the AD&D® or D&D® game—you can't "mix and match" the systems. Some of these rules apply only to the AD&D® game; some only to the D&D® game. Most rules, however, apply to both systems.

This game is designed primarily to be a miniatures wargame, but miniatures are not necessary in order to play.

Both the AD&D® and D&D® games originally grew out of miniatures wargaming. Many of the rules in the AD&D® and D&D® games (such as the AD&D® game custom of giving movement rates in inches) were derived from the CHAINMAIL™ game, designed by Gary Gygax and Jeff Perren. The CHAINMAIL Fantasy Supplement was the original inspiration for the Collector's Edition of the DUNGEONS & DRAGONS® game, and everything that grew out of it.

With the BATTLESYSTEM™ game, the AD&D® and D&D® games go back to their roots. You may have wondered what else you could do with the miniatures you have collected besides showing order of march and possibly running a small melee. The BATTLESYSTEM™ game allows you to fight a large battle using miniatures, and gives your AD&D® and D&D® game heroes the chance to become military leaders in your campaign world!

GAME PARTS

- 1 32-page rule book
- 1 24-page scenario book
- 1 16-page guide to miniatures
- 2 Player Aid Cards
- 2 Metal Miniature Generals
- 3-D ADVENTURE FOLD-UP™ Figures
- Army Roster Sheets
- 801 die-cut counters

The BATTLESYSTEM™ Rulebook, which you are now reading, is the first part of the package. It tells you how to play. The Scenario book sets up actual battles you can fight, and also tells you how to create your own BATTLESYSTEM™ scenarios to go with your campaign. THE ART OF

THREE-DIMENSIONAL GAMING is a guide to miniatures—how to buy them, paint them, mount them, and store them. That book also tells you how to create 3-D terrain features.

The counters that are included in the game can be used instead of miniatures—if, for example, you don't happen to own 500 orc figures. As you collect miniatures, you can use the counters as ready-made "miniature bases."

There's more to making an exciting miniatures battle than just buying lots of miniatures. The rest of the battle is important, too. So, we've included a set of 3-D ADVENTURE FOLD-UP™ figures that are compatible in scale with the miniatures.

Finally, to get you started, the package includes two metal miniatures—generals and standard bearers. You can paint and mount them for immediate use.

GETTING STARTED

This is the first part of the BATTLESYSTEM™ game. Read the rules in this book without trying to memorize them; this will familiarize you with the game. The rules are broken down into Basic, Intermediate, and Advanced Games, each with an introductory scenario. If you are an experienced gamer, you should be able to start with the Advanced Game.

This box contains all the basics for play. If you already have a large collection of miniatures, you should start by mounting them on the counter bases provided (see THE ART OF THREE-DIMENSIONAL GAMING and later sections of these rules) or on bases of equivalent size. If your miniatures are already mounted on bases of approximately the same size, there is no reason to change them. You can also mix counters and miniatures as needed. You will need a large playing surface—a tabletop at least four feet square is the minimum (4' x 8' is much better)—with access on all sides.

These rules are written in a version of the Case System, which should be familiar to most wargamers. There are four Parts: Introduction (you are reading it now), Basic Game, Intermediate Game, and Advanced Game. Within the Parts, there are Sections. Each Section is numbered (1.0, 2.0, 3.0, etc.) and named

(Sequence of Play, Counters and Scale; Setting Up, etc.). Starting off each Section is a general rule or procedure that tells you what topics are covered in that section. Within each section are numbered paragraphs, called Cases. The Cases are the specific rules for the BATTLESYSTEM™ game. Each Case is numbered in a decimal version of the Section number (e.g., the first Case in Section 1.0 is Case [1.1]). Sometimes, a Case is broken down further; those sub-cases are labeled with capital letters. There is one special exception that some wargamers will find unusual: if there are more than nine Cases in a Section, the case numbering goes from [1.9] to [1.10] to [1.11], and so on. Don't be confused by this; just remember that there can be more than nine Cases in a particular Section.

This game can be played either with or without a Dungeon Master or referee. The Basic Game, Intermediate Game,



and even some levels of the Advanced Game can be played without a referee. If you use invisibility or illusion magic, or if you use very many high-level spells or unusual monsters, a referee is strongly recommended. The referee can be your Dungeon Master, or somebody else. If you are using the BATTLESYSTEM™ game in your AD&D® or D&D® game campaign, and there is a large battle involving the forces of evil (controlled by the DM) and the forces of good (controlled by the players), it is a good idea to select an independent referee to handle invisible movement, spell effects, and other areas that can cause controversy. This also lessens the burden on the DM. The referee (whether or not he is also the DM) should be the final arbiter of any rules problems. If you don't use a referee and you encounter a rules problem, let common sense and fair play resolve the problem. (Remember to record your decision so that it applies in the future!) If that approach doesn't work, send your rules questions along with a stamped, self-addressed envelope (phrased so a one-word or short answer can be given!) to Rules Editor, BATTLESYSTEM™ Fantasy Combat Supplement, TSR, Inc., POB 756, Lake Geneva, WI 53147. We'll get back to you.

SEQUENCE OF PLAY

The **BATTLESYSTEM™** game is played in *Game Rounds*. Each Game Round is approximately equal to one Melee Round in the **AD&D®** or **D&D®** games. Each Game Round consists of seven *Phases*.

PROCEDURE

Each Game Round follows a set sequence that allows characters and their forces to perform any or all of the actions that go on during an **AD&D®** or **D&D®** melee round*. (*EXCEPTION:* In the **D&D®** game, everything *except movement* takes place at the rate of one melee round to one Game Round. Use the **D&D** movement rate per *game turn* instead of per melee round.) A character that can attack once or cast one spell can do the same thing in a given Game Round. A character capable of multiple actions, whether by skill or magic, can

perform the same number of actions in a **BATTLESYSTEM™** Game Round.

Each Game Round consists of Phases. Each player completes, in sequence, each of the phases outlined below. The player who is performing actions during a phase is the Phasing Player. When all phases are complete, the players proceed to the next Game Round. They repeat this process until the game ends.

You should keep a record of the passage of Game Rounds. For example, if the elven cavalry is due to arrive on the 5th Game Round, you must mark off each Game Round to know when the elves arrive. If a spell that lasts more

than one Game Round is used, you must note when a spell was cast and how long it will last to know when its effects cease.

The rules often refer to actions that occur during a "friendly" or "enemy" phase. A "friendly" phase is one in which you are acting; an "enemy" phase occurs when your opponent is acting.

* A **BATTLESYSTEM™** Game Round is actually much longer than either an **AD&D®** or **D&D®** game melee round. However, the scale of a large battle is such that the conversion of one Game Round to one melee round in terms of the number of actions that can take place is reasonably accurate. Note that individual combat (I.9.4) is handled at a rate of 3 melee rounds per **BATTLESYSTEM™** Game Round.

SEQUENCE OF PLAY

[1.1] INITIATIVE PHASE.

Each side rolls 1d6 (reroll all ties). The winning side is considered Side A for that

COUNTERS, SCALE AND UNIT ORGANIZATION

Each miniature or counter normally represents several creatures of the same type. Counters are grouped into *Units* to build your army.

[2.1] GROUND SCALE.

The outdoor scale for the **BATTLESYSTEM™** game is 1 inch = 10 yards. Thus, 1 foot (12 inches) on the tabletop represents 120 yards on the battlefield.

[2.2] COUNTER RATIOS.

Each counter (with or without a miniature figure mounted on it) represents one or more of the type of creature printed on its face. The most common scale is 10:1—each orc counter or miniature represents 10 orcs. The ratio of creatures per figure or counter varies with the hit dice of the creature depicted and whether the figure is a **PC/NPC** individual. Use Table 1 to determine the proper ratio.

SPECIAL NOTE: Throughout these rules, the terms "counter" and "figure" are used interchangeably.

Table 1. Creature/Figure Ratio.

Creature Hit Die	Creature/Figure Ratio
Less than 4 + 1 HD	10:1
4 + to 8 + HD	5:1
9 or more HD	2:1
PC/NPC individual*	1:1

* For this purpose, **PC/NPC** individuals include dragons, demons, liches, and other superpowerful and/or intelligent creatures with magical abilities, as well as **PC/NPC** commanders and character types.

[2.3] COUNTER SCALE.

Bases of different size are used for different sizes of creature. Use the following table:

Table 2. Counter Scale.

Creature Size (AD&D® game)	Creature Size (D&D® game)	Base Size
Small (S)	3'-4' tall*	½"
Medium (M)	man-sized	¾"
Large (L)	larger than man-sized	1"
Cavalry	Cavalry	¾" x 1½"
PC/NPC	PC/NPC	No base**
Oversize***	Oversize***	No base**

* Dwarves are mounted on ¾" bases even though they are size S creatures. They may be short, but they are roughly as wide as humans. Width is more important than height in determining base size.

** Individual **PCs/NPCs** are not mounted on bases. This is so that they can join other formations during the battle as well as act alone, and leaves them intact for role-playing. Optionally, you can mount them on ½" bases. If you are using counters, use ½" counters for such creatures, even if they are size M or L. (If the creature is incredibly large, use a ¾" or 1" counter.)

*** Oversize and special creatures are those whose miniature figures are so large they will not fit comfortably on a 1" base. Use a 1" counter if you are using counters; otherwise, use the figure without a base. Use Table 1 to determine how many creatures are represented by each such figure. Use 1" x 2" or larger counters for chariots and huge cavalry.

Game Round; the loser is Side B.

If there is more than one player on a side, but all the forces on a side are allied, the players on that side determine the order in which they will act within each phase of the Game Round. If there are more than two sides in a particular battle, you must add a "Side C" (or even more) to each phase.

[1.2] INITIAL MISSILE PHASE.

Side A takes any initial missile fire to which it is entitled (and removes killed figures); Side B does the same after Side A has fired.

[1.3] RALLY PHASE.

Side A attempts to rally any mobs or routed forces; Side B does the same.

[1.4] MOVEMENT PHASE.

Side A chooses which side moves its forces first. The first side moves any or all of its forces that are eligible to move. The second side then takes any

pass-through fire ([10.6]) to which it is entitled. Then, the second side moves and the first side takes pass-through fire.

[1.5] MISSILE AND MAGIC PHASE.

This phase consists of several steps, which must be followed in order:

A. Magic.

Side A uses any remaining eligible magic; Side B repeats.

B. Missile Fire.

Side A fires any remaining eligible missiles; Side B repeats.

C. Artillery.

Side A fires artillery weapons; Side B repeats.

[1.6] MELEE PHASE.

Units in base-to-base contact resolve melee combat in the following order:

A. Individual Combat.

individuals (1:1 ratio) figures in base-to-base contact conduct melee according to normal AD&D® or D&D® game rules. For such combat only, three AD&D® or D&D® game melee rounds are fought in each BATTLESYSTEM™ Game Round. Only the individuals in combat can be affected by any attacks used in individual combat.

B. Unit Combat.

Side A chooses the order in which all other melee combat will be resolved. All combat involving one unit or opponent must be resolved before moving to the next combat. In each combat, Side A attacks first, followed by Side B.

[1.7] END OF GAME ROUND PHASE.

Side A or the referee records the end of the Game Round, and the sequence begins again with determination of initiative.

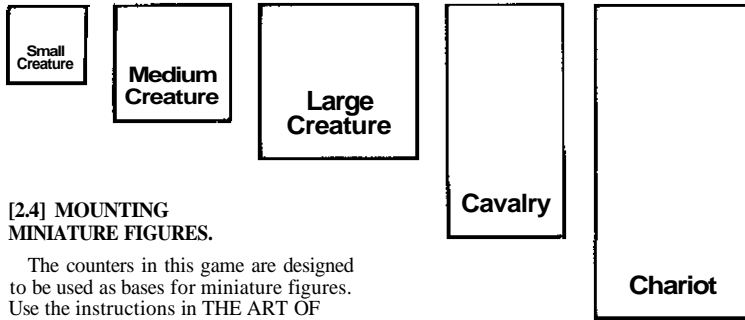

[2.4] MOUNTING MINIATURE FIGURES.

The counters in this game are designed to be used as bases for miniature figures. Use the instructions in THE ART OF THREE-DIMENSIONAL GAMING to paint and mount miniatures. You can use square cardboard of the same size as the counters to mount miniatures if you prefer.

If you are mounting large armies of creatures that normally act in large formations (humans, orcs, and other humanoids, for the most part), you can optionally mount three figures on a 3/4" by 2 1/4" base. This makes large military formations easier to handle. In miniatures terminology, this is called a "stand" of figures.

You don't have to use miniatures to play. The counters can be placed on the tabletop and moved around just as if they were miniatures. All the rules in the BATTLESYSTEM™ game apply to counters as well as figures. You can also mix counters and miniatures in the same battle. For example, two or three mounted orc figures can add a lot of visual impact to a formation of twenty orc counters. When the unit takes casualties, remove the counters first. This

allows you to play with armies that are larger than your miniatures collection.

[2.5] SPECIAL COUNTERS.

The counter sheets in the BATTLESYSTEM™ game also have special counters, called "markers," that are used to show certain conditions. There are nine types of markers: Rout, Magic, Wound, Immobilized, Invisible, Charm, Low Altitude, Medium Altitude, and High Altitude. When a unit or figure has one or more of these conditions, place the appropriate marker on the unit or figure. Magic markers can also be used to define a spell area of effect on the battlefield.

SPECIAL NOTE: The number of counters and markers included with this game is not meant to be a design limit. If you run out of counters of any particular type, make more out of cardboard, paper, or other materials. Some blank

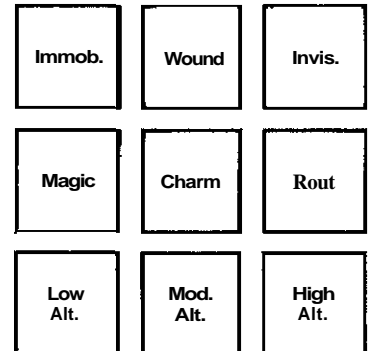

counters are provided in the game for your use.

[2.6] TYPES OF UNITS.

The counters (or figures) in the BATTLESYSTEM™ game are organized into Units and PC/NPC individuals. Only figures with a 1:1 ratio can be PC/NPC individuals; all other figures must be part of a unit. There are three kinds of units: Regulars, Skirmishers, and Mobs.

[2.7] INDIVIDUALS.

PC/NPC individuals can be Heroes, Commanders (or both), or simply members of units. The role each individual takes is determined by the owning player at the start of the game. The roles that a PC/NPC individual can take are discussed in [9.0] HEROES AND SPECIAL CHARACTERS.

[2.8] REGULAR UNITS.

Regular units are the backbone of a traditional army. Regular units can be infantry, archers, cavalry, aviation, magical artillery, or anything else that you desire.

Regular units must have a Unit Commander in order to fight and move at full effectiveness. If a regular unit is Out of Command (that is, its commander is missing or dead), it acts with lower effectiveness. It can, however, continue to move and fight at will.

Regular units can move in Closed or Open Formation ([7.2], [7.3]), and will Rout only if the entire unit is in Open Formation and fails a Morale Check.

A regular unit moves and fights as a unit. It can engage in melee combat or use distance weapons against more than one target at the discretion of the owning player, but cannot be broken into sub-units.

A regular unit must be defined at the beginning of the game. It cannot be changed into a skirmish unit, a mob, or a group of individuals during a battle.

A regular unit must start the battle with at least 4 figures and no more than 48 figures. All figures or counters in a regular unit must have ratios of 10:1, 5:1, or 2:1. A regular unit cannot be made of figures with a 1:1 ratio.

[2.9] SKIRMISH UNITS.

Skirmish units are used as scouts, guerilla forces, spies, and ambushers.

A skirmish unit does not have to have a Unit Commander. It does not receive the benefits for being In Command that regular units do, but does not suffer any penalties for being Out of Command.

Each figure in a skirmish unit must make a Morale Check whenever any friendly unit in its base ground movement range Routs. If the Morale Check is failed, the skirmishing figure also routs. A routing skirmisher can be Rallied by a Brigade or Army Commander in its direct chain of command. If the skirmish unit has a Unit Commander, that commander can also rally the routing skirmisher. This is the only function a skirmish Unit Commander can perform.

Each figure in a skirmish unit can act independently, and can perform any legal action the owning player desires.

A skirmish unit is limited in melee combat. No figure in a skirmish unit can ever move into base-to-base contact with an enemy unit. If any figure in a regular enemy unit or a mob moves into base-to-base contact with one or more skirmishing figures, the skirmishing figures must make a Fighting Withdrawal or Flee the melee as soon as possible. A skirmish figure may attack an enemy skirmisher or individual.

Skirmish units always move in Skirmish Formation ([7.4]); that is, the bases of the figures in a skirmish unit must always be 1" or more apart.

A skirmish unit must be defined at the beginning of the battle. It cannot be changed into a regular unit, a mob, or a group of individuals during the battle.

A skirmish unit must start the battle with at least 1 and no more than 24 counters or figures in it. All figures in a skirmish unit must have a ratio of 10:1, 5:1, or 2:1. A skirmish unit cannot be made of figures with a 1:1 ratio.

[2.10] MOBS.

A mob is a disordered group that is not in command. Mobs are normally made of peasants or other low-level, untrained, and usually ill-equipped creatures.

Mobs need not have Unit Commanders. However, they suffer all Out of Command penalties whether or not they have a Unit Commander.

A mob must have a designated figure or counter from which its movement is measured.

A mob is disordered by nature. It should be displayed on the battlefield by counters or figures placed in an irregular array. The array should be approximately as wide as it is deep (basically square-shaped). If a mob loses figures due to combat, remove losses so that the approximate shape of the mob is maintained. Mobs move and fight in Mob Formation ([7.5]).

The initial placement of a mob is at the discretion of the owning player (or as defined by the scenario). For the mob to move, fight, or otherwise act, a Unit, Brigade, or Army Commander must Give an Order during the Rally Phase. To Give an Order, the Unit, Brigade, or Army Commander must first make a successful Rally attempt. The following Orders can be given to a mob: Move Forward ([7.7]), Charge ([7.14]), Force March ([7.13]), and Wheel ([7.9]) up to 90 degrees. No more than one order can be given per Rally Phase. A mob continues to follow the last order it was given until a new order is successfully

given or until the mob fails a Morale or Discipline Check.

A mob automatically fights when it is in base-to-base contact with an enemy unit. A mob can never use missile weapons, but can use any melee weapon, including magic weapons. A mob can never use spells or devices with spell-like effects.

If a mob Routs, a Unit, Brigade or Army Commander can attempt to Rally it. A mob Rallies in the same way as a regular unit.

When moving, a mob always follows the path of least resistance (e.g., the most favorable terrain type) regardless of orders. It moves in as straight a line as possible within the above restriction.

A mob receives a +2 bonus to its morale if a friendly regular infantry unit is directly behind it and no more than 6" away.

A mob must be defined at the beginning of the battle. It cannot be changed into a regular unit, a skirmish unit, or a group of individuals during the battle.

A mob must start the battle with at least 12 and no more than 96 counters or figures in it. All figures in a mob must have a ratio of 10:1, 5:1, or 2:1. A mob cannot be made of figures with a ratio of 1:1.

[2.11] SPECIAL UNIT TYPES.

Occasionally, a scenario will specify a special unit type not listed above. For example, a unit of highly-trained and experienced troops might be designated as an Elite Unit. An Elite Unit would act as a Regular Unit but have a +2 morale bonus and be able to enter Skirmish Formation. A unit of human berserkers might act like a regular unit but not be able to enter Closed Formation. It would receive a +3 morale bonus, but have a Discipline rating of 0. Other special unit types are possible. It is important to define such units in detail before using them, and to make sure that they are balanced with other forces in the same scenario.

Special unit types cannot be used unless specifically permitted by the scenario being played.

3.0

SETTING UP

To play a BATTLESYSTEM™ game, first select a scenario, prepare Army Rosters, place terrain features on the tabletop, and set up forces for each side.

PROCEDURE

Scenarios for the BATTLESYSTEM™ game can be found in the Scenario Book,

in other BATTLESYSTEM™ products from TSR, Inc., or in DRAGON® magazine. In addition, you can create your own scenarios to go with your

existing AD&D® or D&D® campaign or just create your own battle. Case [16.3] CREATING ARMIES will help you do that. You must first choose (or design) a scenario, determine which players are on which side, and arrange for playing space. The referee, if there is one, sets up the tabletop terrain features, or else the players themselves set up the terrain. Each side must prepare an Army Roster for all forces on that side (some existing scenarios include complete rosters ready for play) and then set up their troops (counters, miniatures, or a combination) on the tabletop. All of this must be completed before play begins.

CASES

[3.1] ARMY ROSTER SHEET.

The BATTLESYSTEM™ Army Roster Sheet is used to record information about each unit in the game. Some Army Roster Sheets are included in this game; you can also use blank sheets of paper to record the necessary information. Use a separate block to list pertinent information for each unit.

All figures in a unit should have the same armor class, hit dice, and weapons, if possible. If a unit of mixed figures is used (in a campaign, for example), the unit always has the average ratings for armor class, hit dice, and damage. Round fractions to the least favorable for the unit. AIS figures in a unit must have the same weapon in order to fight as a unit.

UNIT NAME		UNIT TYPE	
DEATH'S HEAD		REGULAR/INFANTRY	
AC	#FIG	UNIT COMMANDER/DEPUTY	
6	10	Corth Badas	
HD/fig	RATG	LEVEL/RACE/CLASS	
10	16:1	Orc	
MV	SIZE	MR%	PPD PIP RSW BW SP
9"	M	0	14 15 16 17 17
AR	AR Modifiers		
19	+1/swords, -1 daylight		
ML	ML Modifiers		
13	+2 in command (leader CB)		
DL	Wpn/Dmg		
13	Longsword +1 (Dmg 2-9/2-13)		
SPECIAL ABILITIES AND LIMITATIONS			
Also Short Bow (Dmg 1-6/1-6)			
*AT 2, Range 5" (S), 10" (M, 2)			
15" (L, -5)			
Hate Elves (DL Check)			

This roster entry show a force of 200 orc infantry carrying *longswords + 1* and short bows (according to AD&D® game rules; some entries would be slightly different if using the D&D® game rules).

Unit Name. Self-explanatory.

Unit Type. Regular, Skirmish, Mob, or special unit type (if permitted by scenario).

AC. Armor Class (as in the AD&D® and D&D® games).

HD/fig. Number of Hit Dice represented by each figure or counter.

MV. Movement Rate in inches (from the AD&D® game). For the D&D® game, take the movement rate per turn (not melee round!) in feet and divide by 10 (e.g., 120"=12").

AR. Attack Rating (see [8.2]).

AR Modifiers. Modifiers (if any) to the Attack Rating; e.g., missile range adjustments, magic weapons, *bless* spells, etc.

ML. Base Morale (see [4.1]).

ML Modifiers. Such as morale bonus for being in command.

DL. Discipline (see [4.6]).

FIG. Number of figures or counters in the unit.

Ratio. Counter Ratio (see [2.2]).

Size. Of the creatures in the unit. Use S, M, or L.

Unit Commander/Deputy. Name of Unit Commander and Deputy Unit Commander, if any.

Race/Class/Level. Self-explanatory.

MR%. Magic Resistance. (From the AD&D® game; anti-magic percentages are explained in the D&D® Masters Set. If you are playing D&D® Basic, Expert, or Companion, this does not apply.)

PPD, P/P, RSW, BW, Sp. Saving throws for figures in the unit. In the AD&D® game, PPD is Paralyzation, Poison, and Death Magic; P/P is Petrification/Polymorph; RSW is Rod, Staff, or Wand; BW is Breath Weapon; and Sp is Spells. In the D&D® game, PPD is Death Ray or Poison; P/P is Paralyzation or Turn to Stone; RSW is Magic Wands; BW is Dragon Breath; SP is Rods, Staves, or Spells.

Weapon/Damage/# AT. Weapons used by all members of the unit and their damage rating (from the AD&D® or D&D® game); also, number of attacks per round.

Special Abilities and Limitations. As appropriate for the unit, or use as continuation space for the rest of the form. Use additional sheets of paper if necessary.

[3.2] HEROES AND COMMANDERS ROSTER SHEET.

The BATTLESYSTEM™ Heroes and Commanders Roster Sheet is used to record information about each PC/NPC individual in the game. You can use the forms that come with this game, or you

can use blank sheets of paper to record the necessary information. If the PC/NPC individuals are part of your campaign, use their Player Character Record Sheets as part of the roster.

NAME		CLASS/LEVEL	
GARETH DRAGONBANE		F 10	
COMMAND RANK			
Rep.	Army	13	15 16 17 18 19 20
AC	CB	RACE	PPD PIP RSW BW Sp
-4	+2	Human	4 5 3 9 8
HD	CR	WEAPON/DAMAGE/AT	
10	17"	Holy Avenger +5 (1-8/1-12 +9)	
hp	MV	*AT 2 (10 vs. L1)	
80	9"		
THACO	AR	THACO/AR Modifiers	
12	27	+5 sword/+3 dex	
SPECIAL ABILITIES and LIMITATIONS			
All Paladin SA from <i>Players Hdbk</i>			
Holy Sword gives 50% MR, Dispel Magic, +10 Dmg. vs. CE			
SPELL USE: Bless, Command			
Also wears Plate Mail +3			

This roster entry shows a 10th level paladin with a *holy sword* and *plate mail +3*.

Name. Self-explanatory.

Class/Level. If any, from the AD&D® or D&D® games.

Command Rank. See [9.2] and [9.3]. If the PC/NPC individual has no command rank whatsoever, write "Hero" in this space.

S, I, W, D, Co, Ch. Strength, Intelligence, Wisdom, Dexterity, Constitution, and Charisma, from the AD&D® or D&D® games. If the character is from an existing campaign, use those statistics. For random commanders and heroes from the AD&D® game, use Method I (DMG, p. 11). For random commanders and heroes from the D&D® game, roll 3d6 for each characteristic. If the dice result is less than the minimum needed for that race/class, use the minimum value for that race/class instead of the actual dice roll. Not all PC/NPC individuals need statistics here. Leave blank when inappropriate.

Race. AD&D® or D&D® game monster type.

MR %. Magic Resistance. (From the AD&D® game. Anti-magic percentages are explained in the D&D® Masters Set. If you are playing D&D® Basic, Expert, or Companion, this does not apply.)

PPD, P/P, RSW, BW, Sp. Saving throws. See [3.1] for definition.

AC. Armor Class (as in the AD&D® and D&D® games).

HD. Hit Dice, if appropriate.

hp. Number of hit points.

MORALE, DISCIPLINE, AND COMMAND

All units have a *Morale Rating* that reflects the general spirit and enthusiasm of the troops. Some units have *Commanders* who can give orders and rally troops. **Brigades and Armies have higher-ranking commanders. The morale, intelligence, and alignment of a unit determine its *discipline*—its ability to follow orders and fight effectively.**

THACO. Base number "to hit Armor Class Zero" from the AD&D® or D&D® game (see [8.3]).

CB. Charisma Bonus (see [4.9], Table 8).

CR. Command Radius (see [4.10]).

MV. Movement Rate (in inches). See [3.1].

AR. Attack Rating (see [8.2]).

THACO/AR Modifiers. Modifiers (if any) to either THACO or AR; e.g., magic weapons, spells, etc. (For an explanation of THACO, see [8.3].)

Weapon/Damage/# AT. All weapons carried by the character and the damage done by each; also, the number of attacks per round.

Special Abilities and Limitations. As appropriate for the character. Use as continuation space if needed; use additional sheets of paper if necessary.

[3.3] CHARACTER RECORD SHEETS.

If you are using important PCs and NPCs from your role-playing campaign, it is a good idea to have full character information for those individuals at



hand. You should ideally prepare full character statistics for other major PCs or NPCs to be used. Be sure to calculate special BATTLESYSTEM™ information, such as CR, AR, and CB, for each such character.

[3.4] ARMY PLACEMENT.

The scenario you are playing may specify starting positions for all forces to be used. If not, you may place your forces at will. All forces should start more than two full moves away from their nearest opponent (if possible), and all forces on the same side should be on the same side of the battle field (also if possible). Decide before placing your forces whether set-up will be simultaneous or whether one side goes first.

[3.5] MEASUREMENT.

For determining initial placement, it is permitted to measure the distance between your forces and the enemy to ensure that you are a sufficient distance apart. Except in this one instance, *never measure any proposed movement or placement before actually declaring the move!* (See also [7.7] HOW TO MOVE.)

A. MORALE

[4.1] DETERMINING BASE MORALE.

The Initial Morale for all units is 11. Modify the initial morale based on Table 3, below, to determine the Base Morale (ML) of each unit. Write the base morale on the Army Roster Sheet. The Current Morale of a unit can differ from base morale during a battle based on situational factors. You must keep track of current morale at all times.

SPECIAL NOTE: Some unusual monsters either never check morale, or have special morale bonuses. These should be carefully defined before the battle begins, and the game effects listed. Units that never check morale (e.g., berserkers, gibberlings) cannot Rout. However, you must calculate a morale rating for them no matter what, since there are situations not involving a potential rout in which a Morale Check may be required.

D&D® Game Morale. The morale ratings given for monsters and men in the D&D® game are calculated for role-playing adventures with small groups. They are not calculated for mass battles. Therefore, disregard the given morale rating for D&D® game creatures and calculate their morale using the procedures given here.

* In the AD&D® game, see DMG, page 85, for definitions. Units can receive both bonuses. In the D&D® game, give +1 to base morale for each 2 asterisks after the hit dice; round down.

EXAMPLES: A regular unit of twelve figures of 1 HD orcs at 10:1 ratio is wearing leather armor and carrying *longswords* +1. Their Base Morale is 11 (initial) + 1 (magical equipment) - 1 (AC 8) + 1 (Regular) = 12.

A skirmish unit of six figures of hill giants at 5:1 ratio all carry potions of *invisibility*. Their Base Morale is 11

(initial) + 2 (9 HD) + 1 (magical equipment) - 2 (only six figures) + 1 (AC 4) = 13.

[4.2] DETERMINING CURRENT MORALE.

Current morale is determined during play whenever the unit must check morale. The situational factors listed in Table 4 alter the base morale.

EXAMPLES: A unit of orcs with a Base Morale of 12 is commanded by a fighter with a charisma of 17, and is marching in closed formation when a *fireball* explodes, killing 30% of the unit. Its Current Morale is 12 (base) + 1 (closed formation) + 2 (commander CB) - 1 (figure removed by magic) = 14.

A unit of hill giants with a Base Morale of 13 is attacked from the rear by a unit of spectres, and over 50% of the hill giant unit has already been lost. Its Current Morale is 13 (base) - 2 (over 50% casualties) - 2 (attacked from the rear) - 3 (attacked by level drainers) = 6.

Table 3. Morale Modifiers.

Creatures have ½ HD or less	-2
Creatures have more than ½ HD but less than 1 HD	-1
Creatures have 4 to 8 + HD	+1
Creatures have 9 to 14 + HD	+2
Creatures have more than 14 + HD	+3
Demihumans	+1
Creatures with one or more Special Abilities*	+1
Creatures with one or more Exceptional Abilities*	+1
Unit has magic equipment	+1
Unit has 6 or fewer figures	-2
Unit has 7 to 11 figures	-1
Unit AC 0 or better	+2
Unit AC 1 to 4	+1
Unit AC 8 to 10	-1
Unit is mounted	+1
Unit is Regular	+1

Table 4. Situational Morale Factors.

At least 50% of unit has been lost	-2
At least 75% of unit has been lost	-4
An enemy unit is in base-to-base contact with the rear of the unit	-2
The unit is Out of Command (does not apply to skirmish units)	-2
The Morale Check is because a figure was removed by magic	-1
The Morale Check is because the unit commander was killed	-1
The unit is in Open or Mob Formation, Charged during the current Game Round, and failed to end its move in base-to-base contact with an enemy figure or figures	-3
The unit is in Closed Formation	+1
The unit is a Mob and a friendly regular infantry unit is directly behind it and no more than 6" away	+2
Any figure in the unit is in base-to-base contact with a creature that drains levels, or with a creature it cannot possibly harm (hit only by magic weapons, etc.)	-3
CB of current Commander	(if any)

[4.3] HOW TO CHECK MORALE.

When a Morale Check is required by the rules, the player controlling the unit that must check morale rolls 2d10. If the result is equal to or less than the current morale of the unit, the Morale Check is successful; otherwise, the Morale Check is failed.

[4.4] WHEN TO CHECK MORALE.

A unit must make a Morale Check whenever any of the conditions listed in Table 5 occur. One attack that fulfills two or more conditions requires only one Morale Check.

EXAMPLE: A *fireball* that pushes a unit's casualties over 50% requires only one Morale Check even though it fulfills two of the conditions for a Morale Check. On the other hand, if one unit attacks with a *fireball* and another unit fires a volley of missiles, causing total casualties over 50%, then the unit makes two Morale Checks, since there were two different attacks.

A unit may be required to make several Morale Checks during a Game Round. If conditions requiring a Morale Check occur in several different phases, the unit must check morale during each phase in which one of the conditions occurs.

EXAMPLE: During the Missile and Magic Phase, a unit is hit with a *fireball* that removes one figure (figure removed by magic). During the Movement Phase, pass-through fire pushes casualties over

50%. During the Melee Phase, the Unit Commander is killed by an invisible assassin (one Morale Check) and at the end of that phase the unit is in base-to-base contact with undead (another Morale Check). The unit must make a total of 4 Morale Checks during that Game Round.

Table 5. When to Check Morale.

- Immediately after the unit has lost 25% of its original figures.
- Immediately after the unit has lost 50% of its original figures.
- Each time a figure is lost from a unit after that unit has lost 50% of its original figures.
- Each time a figure is removed from a unit by magic.
- The unit's commander is killed.
- The unit is in base-to-base contact with undead or level draining creatures at the end of a Melee Phase.
- The unit is touching a creature it cannot harm (affected only by magical weapons, etc.) at the end of a Melee Phase.
- A figure is a member of a Skirmish unit, and any friendly unit or figure within its base ground movement rate Routs.
- Whenever other game or scenario rules require a Morale Check.

[4.5] EFFECT OF MORALE CHECKS.

If a Morale Check for a unit succeeds, no adverse effects occur.

If a unit in Closed Formation fails a Morale Check, it immediately breaks into Open Formation. The unit does not actually move, but the figures are spread apart. A unit cannot increase the number of figures in its frontage under this rule, but it can decrease the number of figures in its frontage.

If a unit in Open, Skirmish, or Mob Formation fails a Morale Check, it Routs. A routing unit immediately moves away from the enemy a total of its movement rate plus an additional 1/3 of its movement rate, and ends that move with its back to the enemy. Routs are also discussed under [7.15] ROUT and [6.0] RALLY PHASE.

B. DISCIPLINE

[4.6] DISCIPLINE.

Each unit has a Discipline (DL) rating as well as a Morale rating. The Discipline rating of a unit is calculated in the same manner as the Base Morale rating of a unit. In addition to the factors under Base Morale, the special modifiers in Table 6 apply to Discipline ratings. Situational morale factors (Table 4) never apply to Discipline ratings.

Table 6. Discipline Modifiers.

Unit has Low or lower intelligence	-1
Unit has High or higher intelligence	+1
Unit is of Chaotic alignment	-1
Unit is of Lawful alignment	+1

Some units that never check morale (notably berserkers) have a discipline rating of 0. Whenever they encounter a situation that requires a discipline check, the check automatically fails. This should be determined at the beginning of the game.

A discipline check is made when any of the following occur:

Table 7. When To Check Discipline.

- The unit sees a "hated" opponent (PH, p. 18) within its charge range at the beginning of HS Movement Phase.
- The unit is of chaotic alignment or low intelligence, and an enemy makes a Fighting Withdrawal (see [7.12] FIGHTING WITHDRAWAL) or Flees (see [8.8] ENDING A MELEE) while engaged with the unit.
- The unit is of chaotic alignment or low intelligence, and the unit is ordered to charge in Closed Formation.
- The unit is a Mob or is made of berserker-type troops, and it sees any opponent within its charge range at the beginning of its Movement Phase.

When a discipline check is failed, the unit goes Out of Command and attacks and/or charges the enemy regardless of the desires of the commander. If the unit was in Closed Formation, it goes immediately to Open Formation. It charges and/or attacks the enemy until the unit is routed, the enemy unit is routed, or the enemy unit is completely defeated.

The commander of a unit cannot reassert command until after the unit has completed its attack. The commander reasserts command in the same way he Rallies a unit (see [6.0] RALLY PHASE).

C. COMMAND

[4.7] DEFINITION OF COMMAND.

Commanders are an important part of any army. AD Regular units must have Unit Commanders; mobs and skirmish units sometimes have Unit Commanders. Brigade and Army Commanders command multiple units, and also exercise sole command over mobs and skirmish units that do not have Unit Commanders.

A unit is In Command when all figures are within the Command Radius (see [4.8] COMMAND RADIUS) of the unit's commander, and the unit has not failed a discipline check or routed. A unit that is not in command is Out of Command.

A regular unit must be in command to go into Closed Formation, or to move when it is in Closed Formation. A regular unit must be in command to perform a Fighting Withdrawal or to go into a special formation ([11.6], [11.7]).

A regular unit that is in command receives combat and morale bonuses. A regular or skirmish unit that is out of command may still move and fight, but does not receive these bonuses. A mob always suffers Out of Command penalties regardless of its command status.

A commander may rally units that have Routed (see [6.0] RALLY PHASE).

[4.8] COMMAND RADIUS.

Every commander has a Command Radius (abbreviated CR). The command radius of a human or demi-human commander is calculated by adding the character's charisma to his level and dividing by two. Fighters and their sub-classes (rangers, paladins, etc.) receive a 3" bonus to CR. The command radius of a humanoid or monster commander is equal to 2/3 of the creature's movement rate.

LIMITATIONS: A commander must be able to communicate with his troops.

Magical *silence* or *darkness* can take a unit out of command even if its commander is within his CR. There are no absolute rules on who can command what kind of unit, but beware of alignment problems, racial hatreds, languages, and the like. Common sense is recommended in choosing commanders. Commanders with special powers (*telepathy*, etc.) must have their powers defined in advance, either by the scenario or by the referee. Think carefully before allowing exceptions, and make sure everything necessary to the scenario is defined beforehand.

[4.9] CHARISMA BONUS.

The Charisma of a commander affects the current morale of his troops. Use the following table to determine the charisma modifier of each commander:

Table 8. Charisma Bonus

Commander Charisma	Morale Modifier
19 +	+3
17-18	+2
15-16	+1
7-14	0
5-6	-1
3-4	-2
2-	-3

[4.10] COMMAND HIERARCHY.

Some commanders have higher ranks than other commanders.

A Unit Commander commands only his unit. He cannot benefit the members of another unit.

A Brigade Commander commands 4-8 units. He can take over a unit if a Unit Commander is killed, rally a routed unit whether or not the Unit Commander is still alive, or place figures in command that are outside the command radius of their Unit Commander. He can also Give Orders to mobs. Brigade Commanders are only used in battles that have more than seven units on a side. There must be two or more brigades of 4-8 units each in order to have Brigade Commanders.

An Army Commander is the highest-ranking officer on the field. Each side may have no more than one Army Commander. The Army Commander may have Brigade Commanders if the battle is large enough. Otherwise, the Army Commander directly controls the Unit Commanders. An Army Commander can perform all the functions of a Brigade Commander, but can affect any unit in the entire army.

SPECIAL NOTE: Some scenarios may give a specific command structure for a battle. Some monsters (e.g., modrons) have special command hierarchies. All exceptions to normal command rules must be worked out and agreed to by the referee, or the other players if there is no referee, before the battle begins.

PART 2

THE BASIC GAME

The Basic Game covers only the most essential rules of the BATTLESYSTEM™ game. With the Basic Game, you can fight a battle between two small armies. The Basic Game does not include missiles, magic, cavalry, artillery, or individual characters. Those rules are given in the Intermediate and Advanced Games.

This section describes the Basic Game. The BATTLESYSTEM™ Scenario Book contains a short scenario using only these

rules. If you are already familiar with this type of game, you may decide to continue with the Intermediate and

Advanced Games and only play those scenarios.

For the purposes of the Basic Game, Unit Commanders are always assumed to be fighting with the unit [9.2]. Brigade and Army Commanders can operate as independent figures, but Individual Combat [9.4] is not allowed.

If you just play the Basic Game, use the following abbreviated Sequence of Play:

1. Initiative Phase.
2. Rally Phase.
3. Movement Phase.
4. Melee Phase.
5. End of Game Round Phase.

(OPTIONAL RULE: Use a d20 instead of the normal d6 to reduce the number of ties.)

The side that wins initiative is called Side A. The side that loses initiative is Side B.

[5.2] INDIVIDUAL INITIATIVE. (INTERMEDIATE GAME RULE, AD&D® GAME ONLY)

Sometimes, heroes or powerful

5.0

INITIATIVE PHASE

The side that moves first in each Game Round is determined by making an Initiative Roll.

[5.1] TEAM INITIATIVE.

At the beginning of each Game Round, each side makes a normal initiative roll

by rolling 1d6. In the BATTLESYSTEM™ game, there is no "simultaneous initiative." All ties must be rerolled.

monsters will face each other in Individual Combat [9.4]. All such battles use individual initiative (rolled according to normal AD&D® or D&D® game

procedures), not the general initiative of the side. See the intermediate Game for more detail.

6.0

RALLY PHASE

During the Rally Phase, each side attempts to rally any units that have routed, attempts to give orders to mobs, and tries to bring out of command units in command.

PROCEDURE

Units that failed Morale Checks in previous Game Rounds may have Routed; that is, they went out of command and retreated in a disorganized fashion. The unit's Unit Commander, Brigade Commander, or Army Commander may attempt to Rally the unit; that is, stop the rout, turn the unit around, and reenter the battle.

All attempts to rally a unit take place during the Rally Phase.

During the Rally Phase, a commander can also attempt to rally an out of command unit that has not routed, or Give Orders to a Mob. All conditions for a Rally must be met before these functions can take place.

CASES

[6.1] CONDITIONS FOR RALLY.

In order to attempt to rally a unit, all figures of the unit must be within the command radius of a Unit, Brigade, or Army Commander eligible to command the unit. A unit cannot be rallied if it is in base-to-base contact with any enemy figure or figures.

Only one eligible commander may attempt to rally any one unit during a single Rally Phase. One commander cannot attempt to rally more than one unit during a single Rally Phase. A commander who attempts to rally a unit, regardless of success, may exercise command and perform any other legal actions during later phases of the Game Round.

[6.2] HOW TO RALLY.

To rally a unit that has met the above conditions, make a Morale Check for that unit. If the check is successful, the unit is rallied. Remove the Rout marker from the unit. If the check fails, the unit is still routed.

[6.3] IF THE UNIT IS RALLIED.

If the unit is successfully rallied, it may immediately change facing (see [7.9] CHANGING DIRECTION). During the following Movement Phase, the unit may change formation (see [7.6] CHANGING FORMATION). It may not move or fire missiles during that Game Round. It may only fight in melee combat if it is attacked by an enemy unit. Beginning

with the next Game Round, however, the unit may move, fire, and attack normally.

[6.4] IF THE UNIT DOES NOT RALLY.

If no attempt to rally a unit is made, or if a rally attempt fails, the unit moves its full movement rate away from the enemy during the following Movement Phase, ending its movement with its back to the enemy. It cannot move, shoot missiles, or engage in melee combat during that Game Round.

If a routed unit is attacked by an enemy or must make a Morale Check during the Melee Phase, it takes any damage and automatically routs again, moving its full movement rate away from the enemy. This is an *exception* to the normal rule that a unit can only move once during a Game Round.

If a routed unit moves off the edge of the table, or otherwise crosses over the edge of the playing area, it is permanently removed from play.

[6.7] OUT OF COMMAND UNITS.

A unit may become Out of Command without having routed. If a successful rally attempt is made to bring an Out of Command unit into command, that unit can move and fight normally in later phases of the same Game Round.

[6.6] GIVING ORDERS TO A MOB.

An eligible commander can attempt to Give Orders to a Mob if he makes a successful rally attempt. See [2.10] MOBS for further detail.

7.0

MOVEMENT PHASE

Units may move during the Movement Phase. Units may also change formation, change frontage, change direction, and perform other special movement.

PROCEDURE

During the Movement Phase of each Game Round, all eligible units may move. In the AD&D® game, the movement rate for all figures is the number of inches for that type of creature as defined in the AD&D® game. In the D&D® game, use the conversion given in [3.1] ARMY ROSTER SHEET. There is a movement cost for certain terrain features (Intermediate Game

only), changes of unit formation, and changes of direction. Figures that begin a Movement Phase in base-to-base contact with an enemy figure are restricted in their movement options.

A. FORMATIONS

[7.1] DEFINITION OF FORMATION.

A formation is a deployment of troops in a unit. There are four types of formations: Closed, Open, Skirmish, and

Mob. Regular units can operate only in Closed and Open Formations. Skirmish units can operate only in Skirmish Formation. Mobs can operate only in Mob Formation. Each formation has certain characteristics.

PC/NPC individuals may or may not be part of a unit. They do not have to be part of a specific formation at any time. Their roles are defined in [9.0] HEROES AND COMMANDERS.

[7.2] CLOSED FORMATION.

In closed formation, the figures in the unit are in base-to-base contact.

If a unit in closed formation suffers losses, always remove them from the rear of the unit regardless of where they actually occur, since the unit is assumed to automatically fill any holes in its front ranks.

A unit must be in command in order to enter closed formation.

CLOSED FORMATION

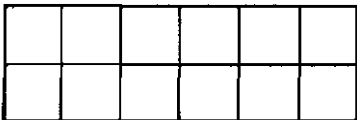

[7.3] OPEN FORMATION.

In open formation, the bases of the figures in the unit are approximately 1/2" apart. (OPTIONAL RULE: If you are using stands of figures (see [2.4] MOUNTING MINIATURE FIGURES), place the stands 1" apart.)

If a unit in open formation suffers losses, it must move figures to fill any gaps in its front lines. It costs 1" of movement rate per figure that must be moved to fill such gaps. It must pay this cost and move as many figures as necessary to close gaps, even if it is in base-to-base contact with an enemy unit. If the total cost for movement exceeds the movement rate of the unit, then the unit fills the gap and cannot move for the remainder of the current Game Round unless it Routs.

OPEN FORMATION

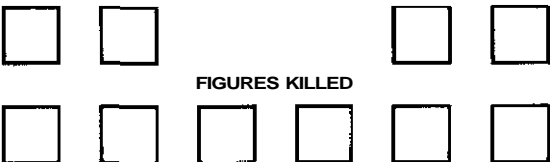
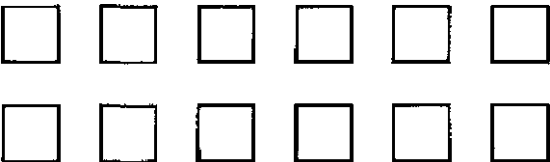

FIGURES KILLED

FILLING GAPS IN OPEN FORMATION FOR COST: 2"

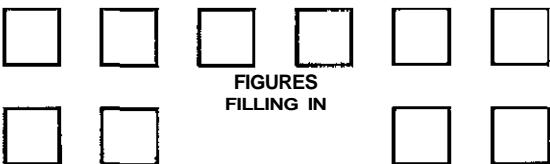

FIGURES FILLING IN

[7.4] SKIRMISH FORMATION.

In skirmish formation, the bases of the figures in the unit are 1" or more apart. Figures in a skirmish unit may move as far away from each other as desired.

A unit in skirmish formation can "pass-through" another friendly unit that is also in skirmish formation. No other formation can do this.

If a unit in skirmish formation loses figures, it does not automatically fill gaps. If it chooses, it can move individual figures at the normal movement rate to fill gaps.

Figures operating in skirmish formation can never move into base-to-base contact with enemy units.

[7.5] MOB FORMATION.

A unit in mob formation is displayed by placing figures or counters in an irregular (but approximately square) array. Figures in mob formation are always placed in base-to-base contact. If a unit in mob formation suffers casualties, remove figures from the rear, since a mob automatically fills in any gaps.



SKIRMISH FORMATION

MOB FORMATION

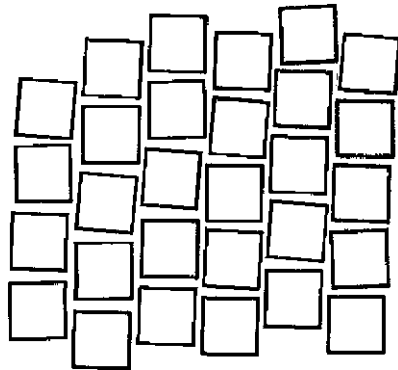

[7.6] CHANGING FORMATION.

A unit may change formation at any point during its Movement Phase. All figures in a unit must be in command for it to change formation, unless the unit goes out of command or is routed. In the latter case, it automatically goes to open formation if not already in that formation.

A change of formation costs a unit 1/3 of its movement rate. Changes of formation that happen involuntarily (such as going out of command or being routed) have no cost.

CHANGING FROM CLOSED TO OPEN FORMATION

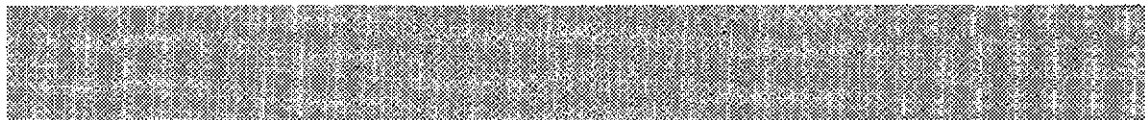
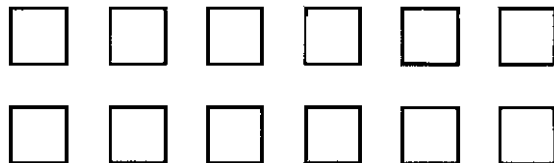
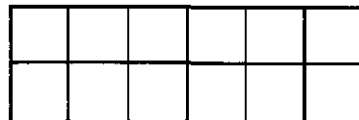

B. MOVEMENT

[7.7] HOW TO MOVE.

Use a ruler or tape measure to determine how far a figure can move. It speeds play if each player has his or her own ruler or tape measure.

Measure movement from the front of the figure's base. If an entire unit is being moved, it is usually sufficient to measure the move of one or two of the figures in the front rank. Then move the rest of the figures in the unit and place them in the same relation to the figures whose move you have measured as they were at the beginning of the move.

To measure the movement of a mob, designate one figure or counter as the point from which all measurements are made.

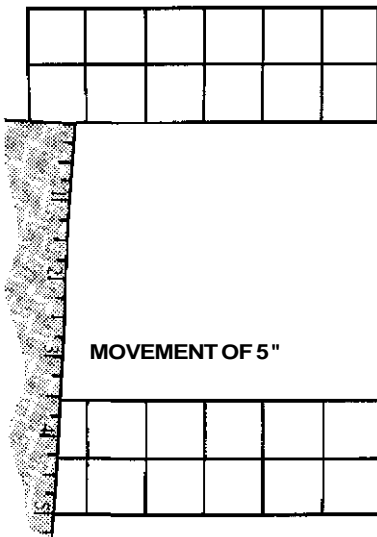

SPECIAL NOTE: It is strictly illegal to pre-measure movement distances, ranges, areas of effect, or anything else without first declaring the action. Once the action is declared, those forces are committed to the stated action, or to no action for that entire phase!

[7.8] MOVEMENT AND ENEMY UNITS.

A figure must immediately stop its movement when it comes into base-to-base contact with an enemy figure. Other figures in the same unit may continue movement if they are not yet in base-to-base contact with the enemy. Figures may not change direction once any member of the unit has made contact with an enemy figure.

Figures that begin their Movement Phase in base-to-base contact with an enemy

may only execute Wrap-Around Movement ([7.11]), Fighting Withdrawal ([7.12]), or Flee ([8.8]). This restriction applies even if the enemy units have moved into base-to-base contact within the same Game Round.

A unit that has lost initiative and had an enemy unit move into base-to-base contact with it cannot change formation, facing, or frontage in its current Movement Phase. In subsequent Movement Phases, it can only execute Wrap-Around Movement ([7.11]), Fighting Withdrawal ([7.12]), or Flee ([8.8]).

[7.9] CHANGING DIRECTION.

Units in skirmish formation can change direction at will during their Movement Phase without a penalty in movement rate.

Units in closed or open formation can move straight ahead or up to 45 degrees to the left or right at will during their Movement Phase without a penalty in movement rate. Use a protractor or angle to measure changes of direction.

Units in closed, open, or mob formation can change direction by Wheeling. To wheel, a unit pivots around one of its figures. The movement cost of wheeling is the distance moved by the outermost figure in the unit.

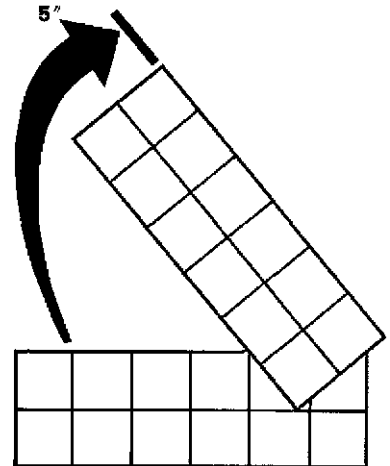

**CHANGING DIRECTION BY WHEELING
MOVEMENT COST: 5"**

Units in closed or open formation can also change direction by Changing Facing. There are three types of facing changes: Right Face, Left Face, and About Face.

To make a Right or Left Face, turn all figures in the unit (or only some figures, if desired) 90 degrees to the right or left. The cost of a right or left face is $\frac{1}{3}$ of the unit's movement rate, even if only some of the figures changed facing.

To make an About Face, turn all figures in the unit (or only some figures, if desired) 180 degrees. The cost of an about face is $\frac{1}{2}$ of the unit's movement rate, even if only some of the figures changed facing.

CHANGE FACING

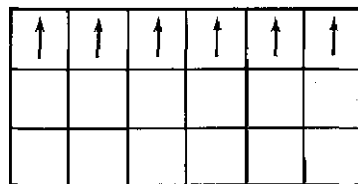
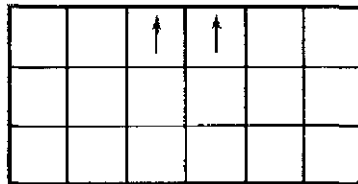

**MV
COST
 $\frac{1}{3}$ MV
ALLOWANCE**

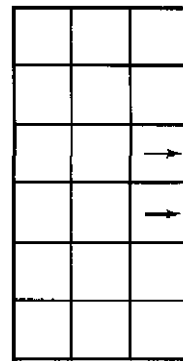

**MV
COST
 $\frac{1}{2}$ MV
ALLOWANCE**

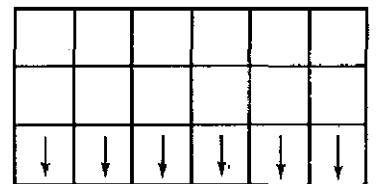

[7.10] CHANGING FRONTAGE.

Units in closed, open, or mob formation have a Frontage. The frontage of a unit is the number of figures along the front side. Units in skirmish formation do not have frontages.

Figures may be added to or subtracted from a unit's frontage by moving figures up from the rear ranks of the unit or moving them back to the rear ranks. The movement cost of changing frontage is 1" for each figure added to or subtracted from the unit's frontage.

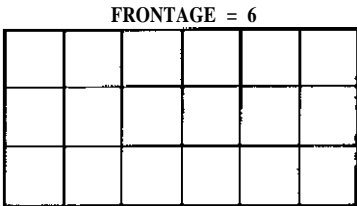

CHANGING FRONTAGE

for each figure added to or subtracted from the unit's frontage.

A mob can only change frontage by moving figures forward as it takes losses. It cannot voluntarily expand or shrink its frontage.

A unit cannot both expand and contract its frontage in the same Movement Phase, nor can a figure move into base-to-base contact with an enemy unit while changing frontage.

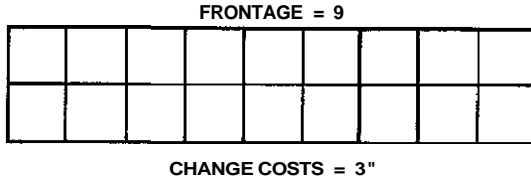

[7.11] WRAP-AROUND MOVEMENT.

A unit that begins its Movement Phase in base-to-base contact with an enemy unit can attempt Wrap-Around Movement during its Movement Phase.

In wrap-around movement, the unit expands its frontage and wheels the ends of its battle line inward to envelop, or wrap-around, the enemy unit. Both the right and left flanks of a unit may wheel inward during this maneuver.

The movement cost of wrap-around movement is the total of the costs of expanding frontage and wheeling the edges of the line inward. No individual figure may move more than its full movement rate.

At the end of melee, a unit that has used wrap-around movement is automatically considered to be in open formation. Note that the bases of the figures will not necessarily be 1/2" or more apart. This is an *exception* to the normal rules relating to open formation.

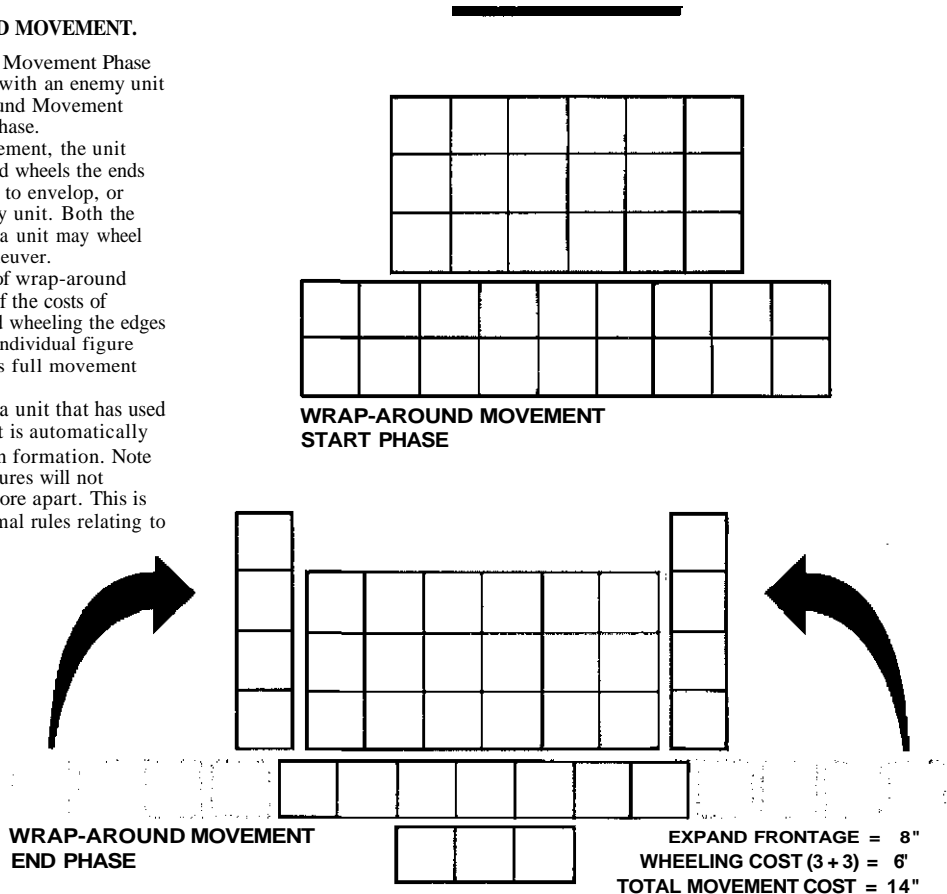

[7.12] FIGHTING WITHDRAWAL.

A unit that is in base-to-base contact with an enemy unit at the beginning of its Movement Phase can attempt to make a Fighting Withdrawal. The unit attempting to make a fighting withdrawal must have a current movement rate of at least 3".

To make a Fighting Withdrawal, the unit moves 3" backward, away from the enemy unit. It may not end up in base-to-base contact with another enemy unit.

The enemy unit has the immediate option to either remain in place, or to advance 3" and remain in base-to-base contact with its opponent. It may do so even if it has already used its full movement rate during that Game Round.

If the enemy unit consists of creatures with low intelligence or chaotic alignment, it must make a Discipline Check. If the check succeeds, the unit has the option to remain in place; otherwise, it automatically advances to continue the melee.

If an enemy unit elects to remain in place, it cannot Charge the unit that withdrew for the remainder of the current Game Round.

[7.13] FORCED MARCH.

A unit or individual can move farther than its normal full movement rate through a Forced March.

A unit must be in command to make a forced march. PC/NPC individuals can always make a forced march. A unit cannot be in base-to-base contact with an enemy figure during any part of its Movement Phase during a Game Round in which it makes a forced march.

A unit that makes a forced march must make a Morale Check at the end of its move. If the check is failed, the unit's Attack Rating (AR) worsens by one (e.g., 19 becomes 20; 16 becomes 17). This penalty accumulates. (Units that "never check morale" are subject to this penalty.)

EXAMPLE: A unit with an Attack Rating of 15 makes a forced march for three Game Rounds. At the end of the first Game Round, it fails a Morale Check, and the AR goes to 16. At the end of the second Game Round, it fails its check again, and the AR becomes 17. At the end of the third Game Round, it makes a successful Morale Check, so the AR remains 17.

This AR penalty stays until removed. The AR improves by one (up to its original value) each time the unit spends one entire Game Round doing absolutely nothing and is not attacked.

A unit that makes a Forced March moves 1 1/2 of its normal full movement rate.

[7.14] CHARGE.

A regular unit or mob may Charge during its Movement Phase if it can reach an enemy unit to engage in melee at the end of its move. A charging unit may move 1 1/2 its normal movement rate (this is called a "charge range"). At the end of the move, the charging unit must be in base-to-base contact with an enemy unit or figure, and it must attack that figure during the Melee Phase.

Skirmish units and individuals cannot charge. Their "charge range" for Discipline Checks is the same as their normal movement rate.

To charge, the unit must be able to move at least 2/3 its normal movement rate before it comes into base-to-base contact with its target. The last % of the charge distance must be in a straight line.

A unit may charge in open, closed, or mob formation. A regular unit that charges in closed formation gains a -1 bonus (minuses are advantageous) to its Attack Rating [8.3] for the Melee Phase in that Game Round only.

If the charging unit is in closed formation and consists of creatures of chaotic alignment or low intelligence, it must make a Discipline Check when charging. If the Discipline Check fails, the unit goes out of command and breaks into open formation during the charge. Except in this one instance, *an out of command regular unit cannot charge.*

If a charging unit runs into an enemy figure or figures that would be killed even if the charging unit does minimum possible damage, it Breaks Through. The enemy figures are immediately removed and the unit continues its charge. The charging unit does not need to eliminate an entire unit to break through; just those figures in its path. However, the charging unit must end its Melee Phase in base-to-base contact with another enemy figure or figures or suffer the penalty below.

If a unit in closed formation fails to end its charge in base-to-base contact with an enemy figure or figures, it breaks into open formation, but remains in command. If a unit in open or mob formation fails to end its charge in base-to-base contact with an enemy figure or figures, it suffers a -3 penalty to current morale for the remainder of the current Game Round.

[7.15] ROUTING.

If a unit in open or skirmish formation fails a Morale Check, it Routs. Place a Rout marker on any unit that routs.

A routing unit immediately moves away from the enemy a total of its movement rate plus an additional 1/3 of its movement rate, and ends its move with its back to the

enemy. A unit always routs away from whatever caused the Morale Check, and routs toward its own lines if possible.

If a routing unit hits a friendly unit that has not routed, the unit that has not routed must make an immediate Morale Check. If that unit routs, it moves ahead of the friendly unit that forced the Morale Check. If the checking unit does not rout, the routing unit "breaks around" the checking unit, reforms on the other side, and continues its movement. (Note that a routing unit can pass-through a unit in skirmish formation—but the unit in skirmish formation must nevertheless make a Morale Check.)

The owning player may attempt to rally units that have routed during the Rally Phase (see [6.0] RALLY PHASE). If no attempt to rally is made, or if an attempt to rally fails, the routing unit continues to rout. On the Movement Phase that follows, the routing unit moves its full movement rate in the same direction it was moving.

If a routing unit moves off the edge of the table, or across the edge of the battlefield, it is removed from play.

If a unit that would otherwise rout is completely surrounded (all passable terrain completely blocked) by an enemy unit in



closed or open formation, and there is no gap of 1" or more of passable terrain through which even a single figure could escape, the routing unit is automatically destroyed and removed from play. Otherwise, the entire unit is entitled to rout through the gap. When escaping through such a gap, no single figure in the routing unit can move more than its rout movement rate.

OPTIONAL RULE: In a campaign battle, if a unit completely surrounds a unit that would otherwise rout, the attacking player can choose to Capture the routing unit. The attacking player designates one of his figures as Guards for every four captured enemy figures; otherwise, the enemy figures automatically escape. Escaped figures are treated as Routed figures for all purposes. The attacking player receives twice the normal number of experience points for captured figures at the end of the game (see [16.2] EXPERIENCE POINTS), and may be able to ransom them if the campaign situation permits. Captured prisoners can also be traded for prisoners held by the other side, if the trading players agree.

MELEE PHASE

Combat takes place between opposing units that are in base-to-base combat during the *Melee Phase*.

PROCEDURE

Melee combat occurs between all opposing units that are in base-to-base contact during any part of the Melee Phase. The side with initiative determines the order in which melees are resolved. Each melee situation is resolved before moving on to the next. AH melee combat is considered to be simultaneous. It is easier for one side to make its attack followed by the other, but do not remove losses until after both sides have completed their melee actions. Even figures that are killed get to fight during their final Melee Phase! (*SPECIAL NOTE*: This applies to melee combat only.)

CASES

[8.1] FORCES ELIGIBLE TO FIGHT.

All figures in a unit that are in base-to-base contact with one or more enemy figures are eligible to fight in melee.

If a unit is in closed formation, an additional one figure to the left and one figure to the right of the enemy's figures can also fight.

If a unit in closed formation is using pikes, each figure in the two rows directly behind the row in base-to-base contact with the enemy gives the unit one extra attack. If the unit is using spears,

pole arms, or halberds, each figure in the first row directly behind the row in base-to-base contact with the enemy gives the unit one extra attack.

A unit can fight multiple opponents. Each unit vs. unit battle is treated as a separate melee, and attacks are rolled separately even when one unit is involved in different melees. If figures in a unit can fight in different melees, the owning player must designate in advance which figures are attacking which targets.

- A = FIGURE CAN FIGHT WITH ANY WEAPON
- B = FIG. CAN FIGHT WITH SPEAR, POLE-ARM, HALBERD, OR PIKE
- C = FIGURE CAN FIGHT WITH PIKE

B	B	B	B	B	B	B	B	B
A	A	A	A	A	A	A	A	A

A	A	A	A	A	A
B	B	B	B	B	B
C	C	C	C	C	C

FORCES ELIGIBLE TO FIGHT

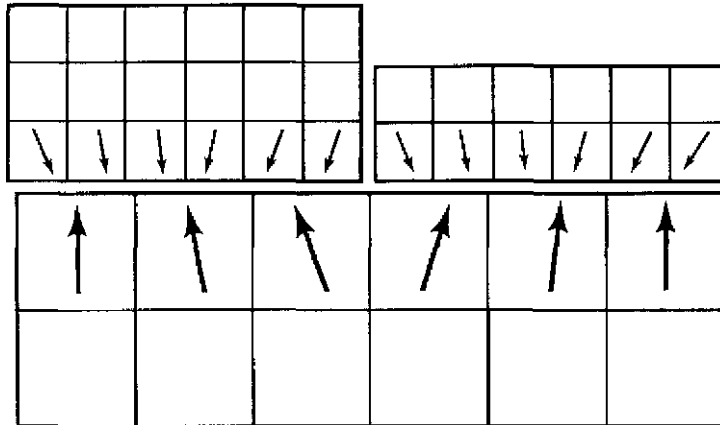

MULTIPLE UNIT BATTLES

[8.2] WEAPON IN HAND.

All members of a unit must be armed with the same weapon in order to fight as a unit, and they must have the same weapon "in hand" in order to fight. Unlike the AD&D® and D&D® games, members of a unit can change weapons at the beginning of any Melee Phase without a penalty of time, movement, or combat effectiveness. The owning player simply announces that his unit is changing weapons, and the change takes place. A change in weapons can take place even if the unit is in melee.

[8.3] DETERMINING ATTACK RATINGS.

The base Attack Rating (AR) for a figure or unit is determined before the start of the game. It is modified according to situational factors, and is used to determine the effectiveness of an attack (e.g., the amount of damage it inflicts on the enemy).

To determine the base Attack Rating for a figure or unit, first determine the THACO (number "to hit Armor Class 0") according to AD&D® or D&D® rules. The THACO is based on the level, class, and hit dice of the creature. Add or subtract any AD&D® or D&D® game bonuses and penalties to THACO (use of magic weapons, high dexterity, weapon non-proficiency, etc.)

When converting THACO to AR, ignore the multiple 20s on the AD&D® game Attack Matrix and the D&D® game Character/Monster Hit Rolls Tables. For example, if a figure or unit hits AC 1 on a 20, its THACO for the purposes of determining AR is 21. This applies only in converting THACO to AR. For all other purposes, the THACO remains 20, with a note that the figure also hits AC 1 with a 20.

Once the base THACO is calculated, add the Ratio Adjustment from the table below to determine the Base AR.

Table 9. Ratio Adjustments for Determining AR.

Figure Ratio	Adjustment
10:1	0
5:1	+ 5
2:1	+ 10
1:1	+ 15

Write the Base AR for each figure or unit on the Army Roster Sheet. In melee, modify the Base AR according to Table 10 to determine the actual AR for combat.

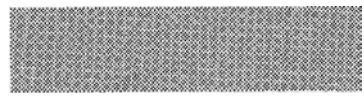

Table 10. Attack Rating Modifiers for Melee Combat.

Attacker is in open or skirmish formation	+1
Any attacking figures are out of command (does not apply to skirmish units)	+1
Defender occupies higher ground	-1
Attacker is charging in closed formation	-1
Attacking commander is fighting as part of the unit	-1

SPECIAL NOTE: Also add or subtract all normal AD&D® or D&D® game bonuses and penalties to THACO from the adjusted AR.

EXAMPLES: -1 for negating defenders' shield bonus (for attacking from flank), -2 for attacking from the rear, +1 for goblins and orcs attacking in daylight, etc. Note that minuses are beneficial to the attacker.

[8.4] MELEE PROCEDURE.

A. Determine adjusted AR of attacker and Armor Class (AC) of defender. Subtract AC from AR.

B. Roll 2d6. Add that number to the result from Step A.

C. Determine the type of damage attacker does (1d6, 2d12, 1d4 + 1, etc.). Use the rules in [8.5] DICE CONVERSION to convert damage to a single dice type (D6, D8, D12, etc.)

D. Cross reference the Dice Type column found in Step C with the Attack Roll found in Step B, using the BATTLESYSTEM™ Combat Results Table (CRT) on the back cover of this booklet (or on the Player Aid Cards). The number found is the number of Hit Dice of damage done by each attacking figure.

E. Multiply the Hit Dice of damage done by the number of figures that attacked. Determine how many enemy figures are killed or wounded according to [8.7] KILLED AND WOUNDED FIGURES.

F. The defending player makes any attacks to which he is entitled, using the same procedure.

G. After both players have completed their attacks, remove all figures killed on both sides, and place Wound markers on all wounded figures.

EXAMPLE: A unit of 10 figures has an adjusted AR of 17, and attacks an enemy with an AC of 8. Subtracting AC from AR gives a result of 9. A roll of 2d6 gives a result of 7, for a total Attack Roll of 16 (9 + 7). The attackers are armed with longswords, which do D8 damage. Cross referencing the Attack Roll of 16 with the D8 damage column gives a result of 6.

Ten figures do 10 x 6 HD of damage, for a total of 60 HD.

[8.5] DICE CONVERSIONS.

Some weapons do damage that is expressed in the roll of a single die (e.g., a dagger does 1-4, or D4, damage; a longsword does either D8 or D12 damage). For such attacks, use the Damage column on the CRT that corresponds to the dice type of damage done (e.g., D4, D8, or D12).

Some weapons do damage that is expressed in a multiple of a single die (e.g., a broadsword does 2-8, or 2D4 damage; a bastard sword against large targets does 2-16, or 2D8 damage). For such attacks, use the Damage column on the CRT that corresponds to the dice type of damage done (e.g., D4, D6, D8), and multiply the result times the number of dice done.

EXAMPLE: If a weapon does 2D8 damage, and the result in the D8 column is 6, then each figure does 12 HD of damage.

Some weapons do damage that is expressed as a modified dice type (e.g., a war hammer does 2-5, or D4 + 1 damage; a holy longsword + 5 does D8 + 5 damage). Damage pluses or minuses change the column on which the results are read, according to the following procedure.

IF THE DAMAGE MODIFIER IS A PLUS, shift one column to the right for each plus (e.g., a + 3 weapon gives 3 column shifts to the right). If the column shifts past the D20 column, start again with the D2 column and add the D20 column result to the column found after "wrapping around" the table.

EXAMPLE: Damage of D6 + 1 is read on the D8 column. Damage of D12 + 4 is read on the D20 column. Damage of D20 + 3 is calculated by wrapping around the table three columns to the right, i.e., D2-D3-D4. The damage is the sum of the D20 and the D4 column results. Damage of D8 + 11 is determined by moving 11 columns to the right, i.e., D14-D16-D18-D20-D2-D3-D4-D6-D8-D10-D12. The damage is the sum of the D20 and D12 columns. If the column shift wraps around more than once, e.g., D10 + 40, keep adding the D20 result each time you pass it. For example, damage of D10 + 40 would be read as the sum of D20 + D20 + D20 + D20 + D8.

IF THE DAMAGE MODIFIER IS A MINUS, shift one column to the left for each minus. If the column would shift past the D2 column, apply the D2 result.

EXAMPLE: Damage of D20-3 is read on the D14 column. Damage of D6-4 is read on the D2 column.

[8.6] MULTIPLE ATTACKS.

If a figure is entitled to multiple attacks per melee round, it is entitled to multiple attacks per BATTLESYSTEM™ game Melee Phase. (EXAMPLE: In the AD&D® game, a 7th level fighter is entitled to 3 attacks per 2 melee rounds, and to 7 attacks per melee round if fighting monsters of less than 1 HD or 0 level humans or semi-humans (PH, p. 25).)

Use the same Attack Roll to calculate damage for all attacks. If each attack causes the same type of damage (e.g., D6, D8, or D4 +1), multiply the damage result by the number of attacks. If different attacks do different types of damage (e.g., a weretiger does 1-4/1-4/1-12, or D4/D4/D12), use the same Attack Roll and add the various damage results together to get the total damage done.

[8.7] KILLED AND WOUNDED FIGURES.

Each figure represents a certain number of hit dice. It must lose all the hit dice represented by the figure in order to be killed.

EXAMPLE: A single orc figure (10 orcs) has 10 hit dice.

When a unit takes damage in melee, it loses a certain number of hit dice. If the number of hit dice of damage equals or exceeds the number of hit dice of one figure, one or more figures are killed.

EXAMPLE: A unit of 10 orc figures has 100 hit dice. If an attack causes 30 hit dice of damage, 3 orc figures are killed, and are removed from play.

If the number of hit dice of damage is not an exact multiple of the number of hit dice of a single figure, a Wound may result. A figure is Wounded if there is damage equal to or greater than 1/4 of the hit dice of that figure, and less than the total of hit dice of the figure.

EXAMPLE: An attack against a unit of 10 orc figures does 35 hit dice of damage. Three orc figures are killed with 5 hit dice left over. Since 5 hit dice is more than 1/4 of a single figure, one orc figure is wounded. If the attack had done 31 hit dice of damage, there would only have been 1 hit die left over. Since 1 hit die is less than 1/4 of a single figure, no wound would result. The left-over damage is simply disregarded.

Place a Wound marker on each wounded figure. Wounds may only be removed by magic, covered in the Advanced Game.

A wounded figure moves and fights normally.

A figure can take only two wounds before being killed. At the end of a Melee Phase, no unit can have more than one wounded figure. If a unit has two wounded figures, remove one and return the other to normal health.

EXAMPLE: During the previous Melee Phase, 3 orc figures were killed and 1 was wounded. In the next Melee Phase, the attacker did 25 hit dice of damage. Two more orc figures are killed, and a second wound is caused. Since two wounds have now been placed, a third orc figure is also removed.

[8.8] ENDING A MELEE.

A melee ends when one or both units have been completely destroyed, or when one unit moves away from the other.

A unit that fails a Morale Check may rout away from its opponent. A unit may make a fighting withdrawal, giving the opponent the opportunity to follow or remain in place.

A unit can Flee a melee. To flee, a unit makes an about face (no movement cost in this case) and moves its full movement rate away from the enemy. The enemy is entitled to one free attack at the fleeing unit with a -2 bonus "to hit" (attacking from behind). The fleeing unit may not fight back, but must make any Morale Check required by losses it takes.

THIS ENDS THE BASIC GAME SECTION. USING THESE RULES, YOU MAY NOW PLAY THE INTRODUCTORY SCENARIO, "BATTLE AT THE CROSSROADS."

PART 3

THE INTERMEDIATE GAME

The Intermediate Game expands the options available in the Basic Game. With the Intermediate Game, you can fight a battle that includes missiles, artillery, cavalry, individual Heroes, special formations, and terrain effects. These rules can be adapted to play any type of historical miniatures battle from the dawn of organized warfare to the introduction of gunpowder.

9.0

HEROES AND COMMANDERS

Player characters and major non-player characters can be part of units, command units, or be Heroes acting alone on the battlefield.

PROCEDURE

During set-up, each player must identify the initial role that each PC/NPC individual will play in the battle. These roles are: member of unit, Unit/Brigade/Army Commander, or Hero. A character can also be designated as a Deputy Commander. A Deputy Commander can take over for a Commander during the battle. PC/NPC individuals can change roles during a battle. All changes of roles must be declared at the beginning of the Movement Phase of the current Game Round, and take effect immediately.

CASES

[9.1] CHARACTERS AS MEMBERS OF UNITS.

PC/NPC individuals who are declared to be Members of Units are assumed to be with their unit at all times. They participate in melee with the unit and flee if the unit routs. They share in all benefits and penalties that happen to the unit. Do not use a separate miniature figure for such characters, since they are considered to be part of one of the figures in the unit. A PC/NPC individual with better armor, weapons, or THACO than the other troops in the unit can

improve the average fighting ability of a unit (see [3.1] ARMY ROSTER SHEET). Remember, however, that all members of a unit must have the same weapon in hand in order to fight as a unit.

Because a character fighting as a member of a unit is part of a 10:1, 5:1, or 2:1 figure (depending on HD), he does not receive the 1:1 ratio adjustment to THACO in determining AR (Table 9). Instead, he receives the ratio adjustment appropriate to the figure of which he is a part.

A PC/NPC individual is alive as long as at least one figure from the original unit remains on the board. If the unit routs and leaves the battlefield (see [6.4] IF THE UNIT DOES NOT RALLY), the PC/NPC individual cannot rejoin the battle, although he is still alive.

If the last figure of a unit is removed because of combat losses, the fate of the character is determined by the following table. Roll 1d10 and apply the appropriate result immediately.

Table 11. Fate of PC/NPC in Eliminated Unit.

Die	Character's Fate
1	Character is killed and body is lost
2-3	Character is killed and body lies on the field
4-7	Character is badly wounded (1-6 hp remaining)
8-0	Character is un wounded but unconscious for 1-10 AD&D® or D&D® game turns.

A wounded or stunned character is automatically captured by the enemy if at the end of the battle the enemy's forces hold the area where the character fell. If the character's side is victorious, the character can return to his unit as soon as he recovers.

[9.2] CHARACTERS AS COMMANDERS.

A PC/NPC individual can be designated as a Unit, Brigade, or Army Commander. A character who commands is subject to all rules and procedures given in cases [4.7] to [4.10] COMMAND.

Place a separate figure (no base) with the unit to represent the Unit Commander. Brigade and Army Commanders are also represented by separate figures, but are not necessarily placed with a unit. Note the command status of each lone figure on the Heroes and Commanders Roster Sheet.

A commander with spell-casting abilities cannot cast a spell and command his unit in any part of the Game Round

in which the spell is cast. If a spell is cast by a commander, his unit is out of command for the entire Game Round. However, a commander can use magic items or innate spell abilities and still command.

A commander fighting with his unit is considered to be alive as long as a single figure of his unit remains. If the last figure of a unit is removed by combat, roll on Table 11 above to determine the fate of the unit commander.

Under certain circumstances in the Advanced Game (an invisible assassin, magic, etc.) it is possible to remove, immobilize, charm, or kill a commander without necessarily harming the rest of the unit. Otherwise, a Unit Commander fighting with the unit cannot be killed without his unit being destroyed. Commanders who are physically separate from their units can be attacked and killed as if they were Heroes ([9.4]).

[9.3] CHARACTERS AS DEPUTY COMMANDERS.

Any PC/NPC individual can be designated as a Deputy Commander at the start of the game. Deputy Commander status must be recorded on the Heroes and Commanders Roster Sheet.

There are three types of Deputy Commanders: Deputy Unit Commanders, Deputy Brigade Commanders, and Deputy Army Commanders. A Unit Commander can be designated as a Deputy Brigade or Army Commander. A Brigade Commander can be designated as a Deputy Army Commander. Heroes and members of units can be designated as any type of Deputy Commander.

A character can only be a Deputy Commander for one Commander. Each Commander can have only one Deputy appointed to him.

A Deputy Commander can take over for his designated commander if that commander dies, is disabled, is removed from combat, or is otherwise not in command of his forces. A Deputy Commander can only take over command of a unit that is currently out of command (i.e., command cannot be "passed over" by a Unit Commander who wishes to become a Hero, for example, unless that commander's unit goes out of command for at least the remainder of the current Game Round).

OPTIONAL RULE: If one or more of the armies in the battle are using a special command hierarchy (see [4.10] COMMAND HIERARCHY), the owning player(s) must prepare a Chain of Command chart showing which commanders move into which positions when commanders are lost. This is particularly useful in large-scale battles.

[9.4] CHARACTERS AS HEROES.

Any PC/NPC individual can be designated as a Hero. Heroes are represented by individual figures (no bases) on the battlefield. Heroes roam the battlefield, using their abilities wherever they are most needed. Heroes may fight other Heroes, enemy commanders, powerful monsters, or enemy units. Characters of any class or alignment may be designated as Heroes. Heroes may also be designated as Deputy Commanders.

Heroes can engage in character vs. figure combat and individual combat. Heroes in individual combat use individual initiative, rather than the initiative of their side (see [5.0] INITIATIVE PHASE). Individual combat takes place during the Melee Phase.



A. Character vs. Figure Combat.

If a Hero is capable of affecting all the creatures represented by at least one single figure in an enemy unit (a magic-user with an area effect spell, or a high-level fighter vs. very low-level creatures, for example), resolve the attack using normal BATTLESYSTEM™ melee procedures.

If the Hero cannot affect all the creatures in a figure simultaneously (this is normally the case), use the following procedure:

FIGURE ATTACKING HERO: Only 1 figure can attack a size S or size M Hero at a time. Up to 3 figures can attack a size L Hero at a time. The figure attacks using normal BATTLESYSTEM™ melee procedures. Each hit die of damage caused by the figure causes 4 hit points of damage to the Hero.

HERO ATTACKING FIGURE: The Hero attacks using normal BATTLESYSTEM™ melee procedures. If the hit dice result is less than 1/2 the figure's hit dice, there is no effect. If the hit dice result is 1/2 or more of the figure's hit dice, the figure takes a wound. (*SPECIAL NOTE:* Even if the Hero's attack causes more hit dice of damage than the figure has, the figure still only takes a wound. This means that a Hero cannot kill a figure in less than two Game Rounds, regardless of hit dice results, unless the Hero is capable of affecting all the creatures represented by at least one single figure. In that case, the Hero can kill an enemy figure in only one Game Round.)

B. Individual Combat.

Individual Combat is melee combat between figures with a 1:1 ratio. It is resolved using normal AD&D® or D&D® game melee and magic rules, rather than BATTLESYSTEM™ melee procedures. Individual combat can take place only

during the Melee Phase, and only between figures with a 1:1 ratio who are in base-to-base contact.

Individual combat takes place at a rate of 3 AD&D® or D&D® game melee rounds to 1 BATTLESYSTEM™ Melee Phase.

Because of the speeded-up time scale of individual combat, no attack made while in individual combat can ever affect a figure of 2:1, 5:1, or 10:1 ratio, even if it is a ranged (i.e., missile) weapon or an area of effect spell.

10.0

MISSILES AND ARTILLERY

Missile weapons and battlefield artillery can be used during the Initial Missile Phase, the Movement Phase (as *pass-through fire*), and the Missile and Magic Phase of the Game Round.

PROCEDURE

All missile weapons usable by characters in the AD&D® and D&D® games can be used in the BATTLESYSTEM™ game. The range of missile weapons and the number of shots per Game Round are the same as in the AD&D® and D&D® games. Missile weapons can be used during the Initial Missile Phase, the Movement Phase (see [10.6] PASS-THROUGH FIRE), and the Missile and Magic Phase of the Game Round, depending on the number of shots per Game Round of the missile weapon used.

Use the BATTLESYSTEM™ melee combat procedure for missile weapons. Unlike melee combat, figures killed by missile fire are removed immediately—they do not get to return fire before being removed.

A. MISSILE WEAPONS

[10.1] WHO CAN USE MISSILES.

All members of a unit must be armed with missile weapons in order for them to be used. A unit that is base-to-base contact with enemy figures cannot use missile weapons.

A figure using missile fire must be able to trace a line of sight to its intended target (45 degrees to either side of the figure). If only a portion of the intended target can be seen, the figure can still shoot, but at a penalty (see [10.8] MISSILE FIRE MODIFIERS). If only part of a unit can see an enemy unit, only those figures who can see the enemy unit can shoot. If only part of the enemy unit can be seen, all enemy losses must be taken from the figures visible to the firing unit. If more losses are called for by the combat result than there are figures that can be seen, ignore remaining losses.

If a unit of archers (short bow, long bow, or composite bow, but not crossbow) is in closed or open order, the first two rows of archers can fire. If a unit is using any other missile weapon, only the first row can fire.

[10.2] WHEN MISSILES ARE USED.

Missile weapons can be used during the Initial Missile Phase, the Movement Phase (as *pass-through fire*), and during the Missile and Magic Phase.

A unit can only fire during the Initial Missile Phase if it is entitled to two or more shots during a Game Round. Regardless of the number of shots a unit is allowed, it can only fire a maximum of one time during the Initial Missile Phase.

A unit that has at least one shot remaining during the enemy Movement Phase can elect to fire a maximum of one shot as *Pass-Through Fire* ([10.6]). A unit does not have to be entitled to more than one shot per game round in order to use *pass-through fire*.

A unit can fire any or all of its remaining shots during the Missile and Magic Phase. If it has already used all its shots during the Initial Missile Phase and the enemy Movement Phase, it cannot fire during the Missile and Magic Phase.

Units can also elect to move and shoot (see [10.4] MOVEMENT AND MISSILE FIRE), or take *split-fire* (see [10.5] SPLIT-FIRE).

If an enemy figure or figures moves into base-to-base contact with a figure or unit that has already used missile weapons during the current Game Round, the missile-using unit cannot fight during that *Melee Phase*.

[10.3] AMMUNITION.

Units using normal (non-magical) arrows, quarrels, stones, or bullets as

missiles have an unlimited supply of ammunition. (A specific scenario may specify a limit on ammunition.) Units using any other types of missiles have a limited number of weapons. Each player must list the number of axes, javelins, spears, magic arrows, etc., each member of a unit carries, and mark off weapons as they are expended. (A specific scenario may specify a limit; otherwise, assume each member of a unit is armed with two volleys.)

[10.4] MOVEMENT AND MISSILE FIRE.

If a unit using missile weapons fires during a Game Round, its movement is limited during that Game Round. A unit that fires missile weapons cannot charge during that Game Round.

A missile-firing unit's movement during the same Game Round is limited according to the following table:

Table 12. Movement and Missile Fire.

Missile Weapon	Movement Restriction
Thrown Weapons	Fire once and 1/3 movement penalty
Crossbows/Slings	Either move or shoot
Archers	Fire twice and not move, fire once and 1/2 movement penalty
Mounted Archers	Fire twice and not move, fire once and move full movement rate
Mounted Crossbows	Fire once and 1/2 movement penalty

[10.5] SPLIT-FIRE.

Archers mounted on other creatures, or centaur archers, can move 1/2 of their movement rate, fire at eligible enemy units, then continue moving the remainder of their movement rate.

Creatures with breath weapons or innate missile weapons (e.g., needlemen) can also *split-fire*,

[10.6] PASS-THROUGH FIRE.

Units that are eligible to fire during the

Missile and Magic Phase can fire at enemy units during the enemy Movement Phase by declaring that they will take Pass-Through Fire. Pass-through fire can be taken at any point during the enemy's movement. Pass-through fire can be used against enemy units that subsequently engage the firing unit in melee combat, or against any enemy units in range and line of sight.

Artillery weapons can also use pass-through fire.

[10.7] INDIRECT FIRE.

Archers can sometimes shoot over friendly troops to hit the enemy. This is called Indirect Fire. To use indirect fire, the archers must be in command and at least 3" away from the friendly troops over which they are firing.

[10.8] MISSILE FIRE MODIFIERS.

The following bonuses and penalties are applied to the AR of missile troops prior to rolling the die.

Table 13. Missile Fire Modifiers.

Target is in open or skirmish formation	+1
Target is in woods or behind hedge	+2
Target is in building, behind wall, or in Shield Wall formation	+4
[11.6] Missile-using troops are mounted	+2
Missile-using troops are using Indirect Fire	+3
Target is at Medium Range*	+2
Target is at Long Range*	+5

* Use these standard AD&D® game penalties for the D&D® game as well. Ignore D&D® game missile adjustments for range.

B. ARTILLERY

[10.9] ARTILLERY WEAPONS.

There are two types of field artillery used in the BATTLESYSTEM™ game: catapults and ballistae.

Artillery weapons can move only along roads or dear terrain ([11.8]).

A. Catapults.

A catapult cannot shoot at a target closer than its Minimum range. It can use indirect fire at normal penalties. A catapult's target is always considered to be AC 5, regardless of the actual AC of the target. It can fire every other Game Round.

LIGHT CATAPULT:

Range: Min = 15", S = 20", M = 25",
L = 30"
Damage: 2d10
MV: 8"

HEAVY CATAPULT:

Range: Min = 18", S = 24", M = 30",
L = 36"
Damage: 2d12
MV: 4"

B. Ballistae.

A ballista can fire every Game Round. It must be able to trace a straight line of sight to its target, and cannot use indirect fire. A ballista's target is always

considered to be AC 10, regardless of the actual AC of the target.

BALLISTA:

Range: S=11", M=22", L=32"
Damage: 2d6
MV: 6"

[10.10] ARTILLERY CREWS.

Each artillery piece must have a crew. An artillery crew must be human, demihuman, or humanoid, and is represented by one figure with 10 or more HD (10:1, 5:1, 2:1, or 1:1 ratios, as desired).

The AR of an artillery piece is the same as the THACO of its crew figure, not adjusted for ratio. If the original crew figure is removed, any replacement crew figure has a +2 AR penalty for the duration of the battle.

If an artillery crew is wounded, the artillery piece cannot move. A wounded artillery crew can fire only at ½ normal rate.

An artillery crew figure is considered to be a skirmish unit for the purposes of command, movement, and melee.

[10.11] SPECIAL ARTILLERY AMMUNITION.

In addition to boulders and arrows, field artillery can be used to fire a variety of items, ranging from glass balls filled with green slime to magical items of destruction. It is the using player's responsibility to work out details of all such special ammunition with the referee or other players before the game begins.

11.0

SPECIAL MOVEMENT

Special movement in the Intermediate Game includes cavalry, chariots, shield walls, set spears and pikes, and terrain effects on movement.

A. CAVALRY AND CHARIOTS

[11.1] DEFINITION OF TERMS.

Cavalry are human, demi-human, or humanoid creatures riding faster, larger creatures into battle. The riders are the primary fighters, and the mounts serve first as transportation and second as fighters. Cavalry mounts include horses, wargs, giant boars, elephants, mammoths, dinosaurs, and any creature that can be mounted and ridden into battle. Flying creatures with riders ([15.0]) are considered to be cavalry.

Chariots are vehicles pulled by one or

more creatures that carry one or more human, demi-human, or humanoid passengers. The passengers are the primary fighters, and the creatures pulling the chariot serve first as transportation and second as fighters.

Each cavalry or chariot figure fights as a whole. If either the rider or the steed is killed, the entire figure is considered unable to fight, and is removed.

EXAMPLE: A unit of drow elves is riding nightmares. The unit is hit with a spell that kills the nightmares, but does not affect the drow because the drow have Magic Resistance. Although the drow survived the attack, the cavalry

unit is removed because the steeds were all killed. Think twice before mounting kobolds on dragons!

[11.2] RATING CAVALRY.

The AR, HD, AC, MV, and Dmg of cavalry are determined in the following manner.

AR: Rider's AR.

HD: Average of the rider's HD and the mount's HD; round up.

AC: The poorer AC of rider or mount.

MV: Mount's MV.

Dmg: Add the damage done by mount and rider.

SA, SD: Special abilities possessed by either rider or steed can be used. Special defenses apply only if they apply to both rider and steed.

[11.3] RATING CHARIOTS.

The AR, HD, AC, MV, and Dmg of chariots are determined in the following

manner:

AR: Average of all passengers and creatures pulling the chariot, rounded in favor of the chariot.

HD: Average HD of all creatures pulling the chariot plus average HD of all passengers.

AC: Average AC of passengers and pulling creatures, plus bonus of -2.

MV: 2/3 of the MV of the creatures pulling the chariot.

EXCEPTION: If the creatures pulling the chariot have 3 or more times the total HD of the riders, the full movement rate of the pulling creatures is used.

Dmg: Add the damage done by all creatures pulling the chariot and all passengers.

SA, SD: Special abilities possessed by either riders or steeds can be used. Special defenses apply only if they apply to all creatures forming the chariot.

[11.4] CAVALRY AND CHARIOT CHARGES.

Charging cavalry or chariots receive a bonus of -2 to AR for that Game Round unless the defending unit is in Set Spears/Pikes formation. This includes

"break-through" attacks (see [7.14] CHARGE.)

Weapons that do double damage in a charge also do double damage in a cavalry or chariot charge.

[11.5] CAVALRY AND CHARIOTS IN MELEE COMBAT.

Only one attack roll is made for an attack by cavalry or chariots. When adding together the damage done by riders, passengers, mounts, and creatures pulling the chariot, use the same die roll to determine number of hit dice of damage caused.

B. SPECIAL FORMATIONS

[11.6] SHIELD WALL

A unit that is in command and in closed formation at the beginning of the unit's Movement Phase, and that is equipped with large shields, can declare a Shield Wall before the unit moves.

A Shield Wall gives a unit a bonus of 4 to AC against all normal missile attacks, and a bonus of 2 to AC against melee attacks. It only gives the bonus for attacks that hit the front of the unit; it gives no advantage to attacks from the flanks and rear of the unit, or from

above. It gives no bonus to AC against artillery.

A unit in shield wall formation can be placed so that it is in a circular or square shape with the shields facing outward, in this case, the unit has no flank or rear sides, and the bonuses to AC apply to attacks coming from any direction. However, a unit in this formation cannot move. Note that to enter a 4-sided formation, some figures must have enough movement to turn and face the rear of the unit.

If the shield wall only protects the front of the unit, the unit can move up to 1/2 its normal movement rate. The unit can change facing only up to 90 degrees during any one Game Round. A change of facing costs a unit in shield wall formation its entire movement rate.

[11.7] SET SPEARS/PIKES.

A unit that is in command and in closed formation at the beginning of the unit's Movement Phase, and that is equipped with spears or pikes, can declare a Set Spears/Pikes before the unit moves.

A Set Spears/Pikes formation does double damage to any enemy unit that charges the formation. In this formation,

PART 4

THE ADVANCED GAME

The Advanced Game allows you to use the full range of options available in the AD&D® and D&D® games.

Magic, flying, weather, night battles, and special monsters are all available. Finally, the Advanced Game provides special campaign rules to allow full integration of the BATTLESYSTEM™ game into your role-playing campaign.

12.0

WEATHER CONDITIONS AND NIGHT BATTLES

Weather is only used in the game when there is at least one person or monster with power to *control weather*. Night battles take place only when called for by a special scenario.

PROCEDURE

If no one in the battle has the power to affect the weather, weather conditions

are always assumed to be favorable and the battle is assumed to in the daytime. However, an individual scenario or your campaign may require specific weather

conditions or darkness to be in effect.

If there is someone in the battle who has the power to affect the weather, roll on Table 15 below to determine weather conditions at the start of the game.

CASES

[12.1] INITIAL WEATHER CONDITIONS.

Battles are always assumed to take place in moderate weather unless the specific scenario or your campaign specifies otherwise. In the latter case, the scenario rules or your referee will specify what the weather conditions are, and what their effect is on battle. Otherwise, roll 1d6 three times and check Table 15 for initial weather conditions.

Table 15. Initial Weather Conditions.

Humidity	Temperature	Wind
1-2 = Clear	1 = Hot	1-2 = Calm
3-4 = Partly Cloudy	2-3 = Warm	3-4 = Light Wind
5-6 = Cloudy	4-5 = Cold	5-6 = Strong Wind

[12.2] EFFECT OF WEATHER CONDITIONS.

None of the initial weather conditions in Table 15 have any combat effect

enemy losses are removed immediately, before the enemy unit gets its return attack (only the surviving figures may attack). If the enemy unit is in closed formation, however, it can fill in any losses in the front line from the rear ranks before making its attack.

Entering a set spears/pikes formation costs 1/3 of a unit's movement rate. The formation can be set to defend any and all sides of a unit. However, if a 4-sided formation is used, some figures must have enough remaining movement to turn and face the rear of the unit.

C. TERRAIN EFFECTS

[11.8] TERRAIN EFFECTS ON MOVEMENT.

Table 14. Terrain Effects on Movement.

CLEAR TERRAIN: Full normal movement.

ROAD: Bonus of 1/3 to normal movement. To use a road, the entire unit must be on the road, and the unit must stay on the road for the entire move.

WOODS: Penalty of 1/3 to normal movement. Woodland creatures (elves, halflings, treants, sylphs, etc.) ignore this penalty. No unit can ever

be in closed formation in the woods. **OBSTACLES** (streams, walls, fences, gulleys, etc.): Penalty of 1/3 to normal movement, no charge possible through obstacles. A unit in closed formation goes immediately to open formation when crossing an obstacle, but there is no movement penalty for this change of formation.

ELEVATION: Penalty of 1/3 of a unit's movement rate to move up 10 feet of elevation (hill, etc.). Units may not charge uphill.

ROUGH TERRAIN: Penalty of 1/2 of a unit's movement rate. Dwarves, hill giants, and other mountain-bred creatures ignore this penalty. Units cannot be in closed formation in rough terrain.

SWAMPS: Penalty of 1/2 to normal movement. Lizard men, sahuagin, lacedons, and other swamp inhabitants ignore this penalty. Units cannot be in closed formation in swamps.

RIVERS, PONDS, LAKES: Units can never enter these terrain features unless entirely made of aquatic or amphibious creatures. Such creatures move their full normal movement rate in water. Units cannot be in closed formation in water. (*SPECIAL NOTE.*

Some scenarios may specify that a specific river is fordable, or allow other exceptions to this rule.)

[11.9] TERRAIN EFFECTS ON COMBAT.

Units in woods can only use missile fire if they are at the edge of the woods and shooting out of the woods. Missile fire cannot be used at units in the woods, but can be used against units at the edge of the woods. (If they can fire out, they can be hit.)

Elves and other woodland creatures can sight and cast spells up to 6" in woods; all other creatures can sight and cast spells only up to 1".

Certain terrain protects creatures against missile fire, as listed in Table 14: Missile Fire Modifiers.

If a unit in a ditch, gully or trench; fording a stream; or in a swamp attacks a unit at the edge of the ditch, gully, or trench; at the edge of the stream; or at the edge of the swamp, it receives a +4 penalty to AR as long as that condition holds true.

THIS ENDS THE INTERMEDIATE GAME SECTION. USING THESE RULES, YOU MAY NOW PLAY THE INTERMEDIATE SCENARIO, "BATTLE OF THE BORDERLANDS"

whatsoever. They are used only to determine what weather conditions such spells as *control weather* can create. In the AD&D® game, use the table in the AD&D® *Players Handbook*, p. 52, to control what weather conditions can be obtained. Of course, your campaign or the specific scenario might have different weather conditions available.

Use Table 16 to determine the effect of certain weather conditions on the battle.

Table 16. Effect of Weather Conditions.

FOG*: Visibility limited to 12".

HEAVY FOG:** Visibility limited to 6".

RAIN*: Visibility limited to 24"; all missile attacks + 1 to AR.

DOWNPOUR:** Visibility limited to 12"; all missile attacks + 2 to AR.

HAILSTORM:** Visibility limited to 9"; missile attacks impossible.

GALE*: All missile attacks + 2 to AR.

STORM:** Visibility limited to 24"; all missile attacks impossible.

HURRICANE/TYPHOON:** Visibility limited to 12"; all missile attacks impossible; all non-magic weapons + 3 to AR; movement penalty of 3/4

SNOW*: Visibility limited to 18"; all missile attacks + 2 to AR;

movement penalty of 1/3.

HEAVY SNOW:** Visibility limited to 9"; all missile attacks impossible; movement penalty of 2/3

* Size M and L creatures cannot fly, except for those from the Elemental Plane of Air. All maneuverability classes are worsened by 1.

** No creatures can fly, except those from the Elemental Plane of Air. All maneuverability classes are worsened by

D&D® GAME NOTE: If you are using the Companion Set of the D&D® game, use the spell effects and radius described in the spell *Weather Control*, located on p. 21 of the Player's Companion, instead of Table 16. However, flight penalties remain as in Table 16.

[12.3] SPECIAL WEATHER CONDITIONS.

A. Temperature Extremes.

Creatures defined as having a penalty against cold- or heat-based attacks suffer a -1 penalty to morale in unfavorable extreme weather conditions, and receive an additional hit dice of damage for each attacking enemy figure.

B. Tornadoes.

A magically-summoned tornado is treated like a 16 HD air elemental in *whirlwind* form (see AD&D® *Monster Manual*, p. 37 or D&D® Expert Set

Rulebook, p. 49). It lasts for 1-10 turns, arriving on the battlefield from a random direction. It travels in a random direction (determine each Game Round) for a movement rate of 36". If it leaves the battlefield, it does not return.

[12.4] WEATHER MAGIC.

Weather spells are governed by the rules for magic [14.0]. If two or more *control weather* spells are used to create the same condition, then the onset time for the weather is 1/2 normal; if two *control weather* spells are used to create conflicting conditions, then both spells cancel out. If a *control weather* spell is used to reinforce current weather conditions, then it takes two or more *control weather* spells acting together to overcome it.

The druidic spell *predict weather* will reveal the action of any *control weather* spells currently operating, even if the weather condition has not yet arrived.

All weather magic must be cast either before the battle begins or during the Missile and Magic Phase.

[12.5] NIGHT BATTLES.

If a battle takes place at night, all missile-using troops without infravision shoot at + 2 to AR. Visibility is restricted to 12" even with infravision; no attacks are possible beyond that range.

SPECIAL CREATURE ABILITIES

Many of the monsters in the AD&D® and D&D® games have special abilities.

PROCEDURE

All special abilities and limitations of creatures must be determined before play begins. For monsters in official AD&D® and D&D® game publications, the published information should be used. For new monsters, you must agree what the abilities and limitations are before play begins. A referee is extremely useful for resolving problems.

CASES

[13.1] COMBAT BONUSES AND PENALTIES.

If a creature has a penalty or benefit under certain circumstances (e.g., -1 to hit in daylight, or -4 to AC against giants), the adjustment applies whenever the circumstances occur. Make AR and AC adjustments before the dice are rolled; make damage adjustments after the dice have been rolled. Each + or - equals one column shift on the Combat Results Table *per attacking figure* to the total hit dice of damage done.

EXAMPLE: If the result is 3D6 of damage per figure, and there is a +1 damage adjustment, the actual number of hit dice of damage is 3 times the result in the D8 column (1 column shift to the right).

[13.2] POISON.

There are two types of poison: poison that causes paralysis or immobilization, and poison that causes extra damage or death.

Poison that causes paralysis, immobilization, or similar effects is resolved as in [13.4] PARALYZATION or [14.6] CHARM, HOLD, AND TEMPORARY IMMOBILIZATION.

Poison that causes extra damage or death is treated as extra dice of damage, using the same dice roll as the conventional attack(s) made during that phase. If the poison is defined as weak, or the saving throw is made at a bonus, shift one column to the right to determine the extra damage. If the poison is defined as strong, or the saving throw is made at a penalty, shift three columns to the right to determine the extra damage. If the strength of the poison is not defined and there is no bonus or penalty to the saving throw, shift two columns to the right to determine the extra damage. Do not make a saving

throw against poison in the BATTLESYSTEM™ game, even if one is permitted. **SPECIAL NOTE:** This rule applies even if the poison only does extra damage, rather than causes death.

[13.3] INVULNERABILITY.

Some creatures are hit only by magic or silver weapons, have a *shield* spell or *globe of invulnerability*, or possess other protection against harm.

If a unit ends a Melee Phase in base-to-base contact with an enemy figure or unit it cannot possibly harm, it makes an immediate Morale Check in addition to any other checks that may have to be made in that phase.

[13.4] PARALYSIS.

Any damage caused by a figure or unit that paralyzes upon touch causes any enemy units in base-to-base contact with it to become paralyzed.

Paralyzation attacks never cause wounds; if any damage is scored, fractional unit damage paralyzes an entire figure. If the only damage caused by a unit is to paralyze, use the D4 column on the CRT to calculate how many HD of enemy figures are paralyzed. Any damage (no matter how small) that affects a single figure requires an immediate saving throw for that figure (if allowed).

[13.5] LEVEL DRAINING.

Creatures engaged with level-draining opponents at the end of a Melee Phase must make an immediate Morale Check with a -2 penalty, in addition to any other checks that must be made.

When level-draining creatures engage in melee combat, they do double damage.

[13.6] AWE AND FEAR (AD&D® GAME ONLY).

Some creatures, including dragons, demons, and devils, have the power to cause *awe* and/or *fear*. The official monster description for each such creature explains when the effect occurs and who is subject to it.

If a creature capable of causing *awe* and/or *fear* is on the battlefield, all units that are affected by it and that are within 12" of it must make an immediate

Morale Check, in addition to any other Morale Checks that must be made.

Modify the unit's morale by -1 if the check is caused by a dragon or a creature of 12 + HD. Modify the morale by +1 if the check is caused by an illusion of a creature that causes *awe* or *fear*.

If a divine being (gods and demigods only) with a charisma of 19 or higher appears on the battlefield, all forces within sight on both sides are automatically affected by the god's *awe power*. (*Awe power* is defined in *Legends & Lore* (formerly the DEITIES & DEMIGODS™ Cyclopedica), p. 7.) *Awe power* stuns affected creatures into inaction as long as the deity is present. There is no saving throw.

[13.7] BREATH WEAPONS.

Breath weapons use the rules for magical artillery. See [14.5] for calculating damage. Range is as defined in the official AD&D® or D&D® monster description, but area of effect is as defined in [14.2].

Breath weapons are normally used during the Missile and Magic Phase. They can be used as split-fire or as pass-through fire if desired.

[13.8] REGENERATION.

Creatures with this ability can remove a Wound marker from a figure if it goes for two Game Rounds without participating in combat. When regenerating creatures are killed, place a second Wound marker on the figure and leave it on the battlefield. Two Game Rounds later, one Wound marker is removed and the figure can move and fight normally. If an enemy figure is within 1" of the "dead" regenerating creature, the creature cannot regenerate. A single figure can prevent two regenerating creatures from healing if it is within 1" of each such figure.

Damage caused by fire and acid attacks does not regenerate unless the creature description says otherwise.

[13.9] UNDEAD AND MINDLESS CREATURES.

Mindless undead (zombies, skeletons, etc.), must be in command in order to move or fight. They never check morale or discipline (but must have a morale rating calculated for them). If a unit of mindless undead goes out of command, it continues following its last order: move, fight, pursue, halt, etc., regardless of circumstances. If it is moving, it will fight any opponents or friendly forces in its path, and move off the tabletop or over a cliff or into a river or otherwise self-destruct if command is not reestablished in time.

MAGIC

Magic is a powerful force in the BATTLESYSTEM™ game. Magic can be used by spell-casters, by monsters with spell-like abilities, and by figures and individuals possessing magic items.

PROCEDURE

Magical spells, spell-like abilities, and magic items can only be used during the Magic and Missile Phase. Some spells and magic items can be used as pass-through fire. Unless the BATTLESYSTEM™ rules specify that a type of spell can be used as pass-through, it cannot be so used.

Special markers are provided in the game to mark magical effects on the tabletop. Magic markers can be placed on figures, or they can be placed to mark a spell area of effect on the battlefield. Magic markers are printed in several colors to help you tell the various effects apart. Charm markers are used to identify figures under a *charm* spell or similar effect. Invisible markers are used to designate invisible creatures that have been detected and placed on the board. Immobilized markers are used for figures who have been paralyzed, held, or otherwise rendered immobile, but who are not dead. (They are also used for regenerating creatures.)

SPECIAL NOTE: The AD&D® and D&D® game spells used in the BATTLESYSTEM™ game have been broken down into general categories for illustration and convenience in description. These lists are not complete or comprehensive, since clever and creative players will always think of unusual uses for even the most conventional and simple magic spells. It is highly advisable to use a referee when playing the Advanced Game in order to resolve confusing or conflicting situations.

A. RULES AND REGULATIONS FOR MAGIC USE

[14.1] RESTRICTIONS ON MAGIC USE.

All AD&D® and D&D® game rules apply to the use of magic in the BATTLESYSTEM™ game unless specifically modified by this rulebook. A spell-caster or magic item user can perform the same actions in one BATTLESYSTEM™ Game Round as in one AD&D® or D&D® game melee round (**EXCEPTION:** Individual combat takes place at the rate of 3 AD&D® or D&D® game melee rounds to 1

BATTLESYSTEM™ Game Round. See [9.4] CHARACTERS AS HEROES.)

Spell-casters cannot move during the same Game Round in which they cast spells, unless affected by a potion of *speed* or a *haste* spell (see [14.7]). Figures using magic items can move ½ their normal movement rate during the same Game Round in which they use the item. Characters with magic wands or rods who are riding mounts can split-fire like mounted archers.

A figure in base-to-base contact with any enemy figure or figures can only use magic on itself or against the figure(s) with which it is in contact. A figure can use eligible magic as pass-through fire during an enemy Movement Phase before the enemy figure enters into base-to-base contact with it.

Any figure that represents only one individual can use whatever magic the individual possesses. A figure that represents more than one individual can only use magic if all of the creatures represented by that figure are capable of using that spell or item.

A mob cannot use magic, except for innate spell-like abilities. It must be successfully Ordered to use such abilities. A skirmish unit can use whatever magic it possesses. A regular unit that is in command can use whatever magic it possesses. A regular unit that is out of command can use magic if and only if it passes a special Morale Check in order to do so. If the special Morale Check fails, the unit cannot use magic. Units that "never check morale" are subject to this rule. **SPECIAL NOTE:** Magic weapons without special abilities can be used by any units without restriction or penalty.

All magic (except for magical melee weapons) must be used during the Movement Phase (as pass-through fire) or during the Missile and Magic Phase. This applies even to melee-like effects (*spiritual hammer*, *cause light wounds*, etc.). Like missile fire, magical casualties are removed at once—they do not get return attacks as in melee combat.

Spells can be pre-cast before the battle begins. The referee or the scenario rules should specify any limits on spell pre-casting (e.g., no more than 5 spells per side, or beginning only 10 Game Rounds before the start of the battle, etc.). Each player must calculate for each spell-caster the number of rounds it takes

to pre-cast, and deduct that time from all pre-cast spells.

[14.2] GAME SCALE AND AREA OF EFFECT.

In the AD&D® game, the range of any magic spell or item is the range in inches from the *Players Handbook*, *Dungeon Masters Guide*, or other source. In the D&D® game, calculate the range of a magic item or spell in the same way movement rate is calculated (see [3.1]).

The casting time, onset time (if any), and duration of any magic spell or item is the same as given in the official AD&D® and D&D® game books for that spell or item.

In a BATTLESYSTEM™ game using AD&D® rules, the Area of Effect of a magic spell or item is 1" = 10', not 10 yards. This means that it takes 3" of area of effect in the AD&D® game to equal 1" of area of effect in the BATTLESYSTEM™ game. Use Table 17 to convert spell areas of effect from the AD&D® game to the BATTLESYSTEM™ game. The column labeled "Figure Base Size" is used to determine whether all the creatures represented by a single figure fall in a spell's area of effect.

In a BATTLESYSTEM™ game using D&D® rules, each 30' of area of effect equals 1" on the tabletop.

SPECIAL NOTE: The Figure Base Size describes figures in closed or mob formation only! For creatures in open or skirmish formation, consider the base size to be one size larger.

Table 17. Spell Areas of Effect.

AD&D® or D&D® GAME SCALE	BATTLESYSTEM™ SCALE	FIGURE BASE SIZE
1"/30'	1/2"	1/2"
2"/60'	1"	3/4"
3"/90'	1"	1"
4"/120'	1 1/3"	1 1/2"
5"/150'	1 2/3"	1 3/4"
6"/180'	2"	2"

[14.3] SAVING THROWS.

Figures that represent only one individual use the normal AD&D® or D&D® game saving throws to determine the effect of spells.

Figures that represent more than one creature also use AD&D® or D&D® game saving throws. Make a separate saving throw roll for each figure in the spell area of effect. If the saving throw succeeds, the entire figure has saved; if the saving throw fails, the entire figure has failed.

OPTIONAL RULE: If 20 or more figures have been affected, you can optionally have one less than the saving throw number of figures fail

automatically for each multiple of 20 figures. Make individual saving throws for remaining figures. This saves time when a large number of saving throws must be made. If you decide to use this rule, you must declare it prior to making any saving throw rolls.

[14.4] LINE OF SIGHT.

Any spell or item that acts at a distance must be able to trace a clear line of sight from the caster to its intended victim. If the line of sight passes through woods, buildings, walls higher than either character, or other obstructions, it is broken and the spell caster cannot see his target well enough to cast the spell. A unit in closed, open, or mob formation, or skirmishers no more than 1" apart, also blocks line of sight.

The range from spell-caster to target must be calculated after the magical attack is declared. If it is found that the range is insufficient, or the line of sight is obstructed, the spell automatically fails and is expended.

It is impossible to target individual characters in a regular unit in closed or mob formation. In all other formations, an individual character can be targeted if not physically blocked by any figure or portion of a figure. If it is not obvious whether a character can be targeted, stretch a string or rubber band between the spell-caster and the target character. If the string or rubber band does not touch any object or figure in the direct path, the character can be targeted successfully.

B. TYPES OF MAGIC

[14.5] MAGICAL WEAPONS AND ARTILLERY SPELLS.

CLERICAL

Spiritual Hammer
Sticks to Snakes
Flame Strike
Insect Plague
Earthquake
Holy (Unholy) Word

DRUID

Shillelagh
Fire Trap
Call Lightning
Pyrotechnics
Fire Seeds
Fire Storm

MAGIC-USER

Magic Missile
Shocking Grasp
Stinking Cloud
Fireball
Flame Arrow
Lightning Bolt
Cloudkill
Cone of Cold
Death Spell
Disintegrate.
Otiluke's Freezing Sphere

Delayed Blast Fire Ball
Mordenkainen's Sword
Bigby's Clenched Fist
Incendiary Cloud
Bigby's Crushing Hand
Explosive Cloud
Meteor Swarm
Power Word, Blind
Power Word, Kill
ILLUSIONIST
Color Spray
Prismatic Spray
Etc.

This category includes all spells and items that can do damage to one or more enemy figures. It also includes most breath weapons (see [13.7] BREATH WEAPONS).

Spells in this category can be used as pass-through fire.

A. Calculating Damage.

Against individuals, damage is determined by normal AD&D® or D&D® game rules. Against figures representing more than one creature, you must calculate the number of Hit Dice of damage done.

All damage that would be considered to be D6 or D8 damage on the BATTLESYSTEM™ CRT does the same number of HD of damage in the BATTLESYSTEM™ game.

EXAMPLES: A *Wand of Fire Balls* does 6d6 damage in the D&D® game, and so does 6 hit dice of damage in the BATTLESYSTEM™ game. In the AD&D® game, a *magic missile* does D4 +1 damage, and so does 1 HD of damage in the BATTLESYSTEM™ game.

In all other cases, first determine the number of hit points of damage done and then divide by 4 to determine the number of hit dice of damage done. This may involve first rolling dice to determine the number of hit points, and then dividing.

EXAMPLE: An *ice storm* does 3d10 points of damage. Roll a d10 three times (let's say you roll 6, 5, and 3 for a total of 14) and then divide 14 by 4 to get 3 ½, rounded to 4 HD. (Round ½ and higher fractions up.)

SPECIAL NOTE: An area of effect spell affects every creature in that area! If a *fireball* does 6 hit dice of damage, a figure representing 10 creatures in the area of effect takes 60 hit dice of damage.

B. Determining Spell Effect.

If all creatures represented by a figure will die even if they all made their saving throws, the figure is automatically removed. If all creatures represented by a figure will live even if they failed their saving throws, the figure is automatically wounded.

If a saving throw would determine whether a figure lives or dies

(*EXAMPLE:* ten 4HD ogres are hit by a 6 HD *fireball*, and a saving throw is made for the figure. If the check succeeds, the figure is wounded; if it fails, the figure is removed.)

If the spell effect is linear or cone-shaped, the following special rules apply: A linear effect can do no more than wound a figure if fired from in front of or directly behind the figure. If it is fired from the side against a figure in closed or open formation, it can cause a figure to be removed if the damage is sufficient. This restriction applies to the first ½ of the range of a cone-shaped spell effect also.

[14.6] CHARM, HOLD, AND TEMPORARY IMMOBILIZATION.

CLERICAL

Snake Charm
DRUID
Entangle
Charm Person or Mammal
Hold Animal
Hold Plant
Confusion

MAGIC-USER

Charm Person
Friends
Sleep
Forget
Ray of Enfeeblement
Hold Person
Suggestion
Charm Monster
Fire Charm
Feeblemind
Hold Monster
Geas
Repulsion
Charm Plants
Antipathy/Sympathy
Mass Charm
Maze
Temporal Stasis

ILLUSIONIST

Hypnotism
Blindness
Deafness
Hypnotic Pattern
Paralyzation
Emotion
Chaos
Mass Suggestion
Etc.

Spells in this category can be used as pass-through fire.

A. Charm.

If a *charm* spell or similar effect is used against a unit commander or individual, that commander/individual receives any normal saving throws to which he is entitled. If the saving throws (if any) fail, the *charmed* commander and his unit fall under the control of the other side for 1-4 + commander's CB (if any) Game

Rounds. A unit serving a *charmed* commander moves during the enemy Movement Phase. It cannot be ordered to attack units on its side, but it can be moved in any manner the enemy player decides, as long as its move is legal. If a unit following a *charmed* commander ends its move in a position in which it can be attacked in the flank or rear by an enemy ground unit during the same Game Round, the unit must make a Discipline Check. If the unit passes the check, it remains in place; if the unit fails, the player owning the figures may make a facing change for all figures in the unit at no cost. When the enemy control period ends, the unit "figures out" that its commander is acting strangely, and goes out of command.

If a *mass charm* or similar spell effect is used against an entire unit, every figure in the area of effect that is entitled to a saving throw must make a saving throw. Each figure that fails falls under the control of the opposing player for the duration of the *mass charm*. Such figures move during the opposing player's Movement Phase, and can move or fight in any manner the opposing player wishes—including attacking figures on its own side. The figure or individual casting the *mass charm* is considered to be the Unit Commander, and the commander's CR is considered to be the range of the spell. Note that it is possible for a unit to be split and fight itself.

Place a Charm marker on any *charmed* individual or figure.

B. Hold/Temporary Immobilization.

When a figure is attacked by a hold or temporary immobilization spell, first make any saving throw to which the figure is entitled. If the saving throw fails, place an Immobilized marker on the figure and write down the nature and duration of the effect.

A *sleep* spell can be broken if a friendly figure moves into base-to-base contact with an affected figure and remains for one full Game Round. On the next Game Round, the sleeping creatures awake.

Paralyzed creatures must have their paralysis broken by magic or wait until the effect wears off.

[14.7] BONUSES AND PENALTIES.

CLERICAL

Bless
Protection from Evil
Resist Cold
Sanctuary
Chant
Resist Fire
Prayer
Survival
Protection from Evil 10' Rad.
DRUID

Protection from Lightning

Protection from Fire

Anti-Animal Shell

MAGIC-USER

Protection from Normal Missiles

Haste

Slow

Fumble

ILLUSIONIST

Dispel Exhaustion

Etc.

Bonus and penalty spells improve or lower the abilities of figures. A bonus or penalty spell used on a figure representing a single individual works according to normal AD&D® or D&D® game rules. A bonus or penalty spell used on a figure representing more than one individual or creature must be able to affect all creatures represented by the figure, or else have no effect. (EXAMPLES: It takes 10 *protection from fire* spells to benefit a 10:1 figure; but a single *haste* spell cast by a 10th level magic-user could affect all 10 creatures represented by the figure.)

If not all the figures in a unit have been affected by the magic, place a Magic marker on each affected figure; if all figures in the unit are affected, there is no need for the markers. Remember to write the nature and duration of the bonus or penalty on the roster sheet.

If only part of a unit is affected, that part fights separately from the rest of the unit. The affected figures may still function as members of the unit, but combat rolls and damage are figured for the enchanted and non-enchanted figures separately.

Haste spells and potions of *speed* allow a figure to make its full move and also cast spells/use missiles, or make a double move, or fire missiles or melee for double damage.

[14.8] INVISIBILITY.

DRUID

Invisibility to Animals

MAGIC-USER

Invisibility

Invisibility 10' Radius

Mass Invisibility

ILLUSIONIST

Improved Invisibility

Etc.

It is highly recommended that you use a referee when using invisibility magic in the BATTLESYSTEM™ game.

A figure or group of figures that are invisible are not placed on the board. Instead, the player controlling them writes down their initial position and records direction and length of each move, then shows the referee what is going on.

The referee determines whether the move is legal, whether the invisible figure or figures came into contact with any

figures of either side, and whether the enemy was able to detect the invisible figures.

If the player using invisible figures fails to leave enough space among his units for the invisible figure or figures, the invisible forces are automatically eliminated.

Invisible figures must always operate in skirmish formation.

If invisible figures enter a *detect invisibility* spell area of effect, come within range of a *true sight* spell or a *gem of seeing*, or encounter similar magic, they must be immediately placed on the board. However, they have a -4 AC bonus as long as they are invisible. In addition, figures unable to see the invisible figures cannot make magic or missile attacks. (SPECIAL NOTE: In the AD&D® game, the DMG, p. 60, gives a chance to automatically detect invisible figures based on intelligence and level.)

If an invisible figure attacks, it loses its invisibility according to the AD&D® and D&D® game rules. The enemy may attack the formerly invisible figure during that Game Round, but the invisible figure retains its -4 AC bonus for the rest of that Game Round. If an invisible creature wades a stream, the opponent must be told that something unseen crossed in that location, but the figure need not be placed on the board.

If an invisible figure comes into base-to-base contact with any enemy figure at any point, the invisible figure must be placed on the board, but gets an immediate free melee, missile, or magic attack. It can then melee normally during that Game Round. This is an *exception* to the rule that prohibits a unit from using missiles or magic and then performing melee combat during the same Game Round.

If an invisible creature is placed on the board, but its invisibility is not broken, place an Invisible marker on the figure. These figures always have a -4 AC bonus. Please note that such AD&D® game spells as *improved invisibility* and *psionic invisibility* give exceptions to some of the rules. In dealing with invisibility, use the spell descriptions to govern effects.

If you are not using a referee, place invisible figures on the board with an Invisible marker on them. They cannot be attacked unless they are detected by enemy forces. All other rules related to invisibility apply.

[14.9] AWE AND FEAR.

CLERICAL

Fear

MAGIC-USER

Scare

Etc.

A figure confronted with a spell effect causing *awe* or *fear* may make a saving throw if permitted. If the saving throw fails, the unit either routs or is stunned, according to the spell effect.

[14.10] CREATE TROOPS.

CLERIC

Animate Dead
Aerial Servant
Animate Object
Conjure Animals
Gate

DRUID

Summon Insects
Animal Summoning I,II,III
Conjure Fire Elemental
Conjure Earth Elemental
Animate Rock
Creeping Doom
MAGIC-USER
Find Familiar
Unseen Servant
Monster Summoning I-VII
Conjure Elemental
Mordenkainen's Faithful Hound
Invisible Stalker
Cacodemon

Clone

Create Magical Monster

Gate

ILLUSIONIST

Shadow Monsters
Demi-Shadow Monsters
Summon Shadow
Shades
Etc.

Created or summoned troops can be brought into play using the above spells, or such magic items as the *Horn of Valhalla* (AD&D® game).

Illusions that do "killing" damage actually only put their victims into a cataleptic state. A *shadow monster* or related spell does real melee damage. However, if it has a special killing ability (e.g., a *death ray*), and the attacked figures have made a saving throw, then the special killing ability only puts its victims into a cataleptic state, just like a normal illusion.

[14.11] DETECTION AND INFORMATION.

CLERIC

Detect Evil
Detect Magic
Augury
Detect Charm
Fired Traps
Know Alignment
Speak with Animals
Locate Object
Speak with the Dead
Detect Lie
Divination
Neutralize Poison
Speak with Plants
Tongues

Commune

True Seeing

Find the Path

Speak with Monsters

Stone Tell

DRUID

Detect Snares and Pits

Locate Animals

Locate Plants

Commune with Nature

MAGIC-USER

Comprehend Languages

Identify

Detect Invisibility

ESP

Clairaudience

Clairvoyance

Infravision

Wizard Eye

Contact Other Plane

Glasse

Lore

Legend Lore

ILLUSIONIST

True Sight

Detect Illusion

Vision

Etc.

A. Detection.

Detection spells work according to normal AD&D® and D&D® game rules.

B. Information.

Most information spells work according to normal AD&D® and D&D® game rules. However, such spells as *augury*, *divination*, *vision*, and even *wish* used as an information spell pose special problems.

Questions may be asked of the referee or opposing player, according to the nature of the question and of the spell. If there is a chance that the answers may be false, the referee rolls the dice in secret, and tells the person who is to answer the question whether or not he must tell the truth.

Any question on the order of "Who will win the battle?" cannot be answered. If the answer to any question is unknown, or if the question cannot be answered, the questioner gets no information and the question is expended.

Questions about the actions of the other side have special limits: a player can only discover what an enemy unit or units will do on the following Game Round. If a *wish* or *vision* spell is used, the maximum information that can be obtained is either (a) what forces and capabilities one enemy brigade has (the questioned player must show the asker Army Roster Sheets for one brigade, or (b) where the units and commanders of any one brigade will move during the next Game Round. If a player is forced to declare where his units will move on the

next Game Round, he must move according to what he declares, regardless of changing circumstances.

SPECIAL NOTE: Heroes and any commander with magic resistance or other protection against *ESP* detection, or magic are immune to information magic, even a *wish*. A player never has to reveal the whereabouts, capabilities, or intentions of such heroes or commanders in response to information magic.)

[14.12] MAGICAL DEFENSES.

CLERIC

Blade Barrier

Barrier

Word of Recall

DRUID

Barkskin

Feign Death

Repel Insects

Anti-Plant Shell

Anti-Animal Shell

MAGIC-USER

Feather Fall

Hold Portal

Shield

Mirror Image

Rope Trick

Blink

Leomund's Tiny Hut

Fire Shield

Minor Globe of Invulnerability

Bigby's Interposing Hand

Anti-Magic Shell

Bigby's Forceful Hand

Globe of Invulnerability

Guards & Wards

Bigby's Grasping Hand

Duo-Dimension

Statue

Mind Blank

Serten's Spell Immunity

Prismatic Sphere

ILLUSIONIST

Blur

Prismatic Wall

Etc.

Defensive magic works according to the AD&D® and D&D® game rules. Defensive spells used for offensive purposes (a *blade barrier*, for example) may require decisions by a referee. It is the responsibility of the casting player to keep track of the effect and duration of the spell.

The spell *mirror image* eliminates damage in proportion to the number of duplicates generated by the spell. **EXAMPLE:** A figure has cast *mirror image* and created three duplicates of itself. If the figure receives 40 HD of damage, it takes only 10 HD, since each of the duplicates also took 10 HD of damage (each duplicate disappears after taking damage).

Spells in this category can be used as pass-through fire.

[14.13] MOVEMENT.

CLERIC

Astral Spell

Travel

Wind Walk

DRUID

Plant Door

Pass Plant

Transport via Plant

Transport through Plants

Chariot of Sustarre

MAGIC-USER

Spider Climb

Jump

Levitate

Fly

Dimension Door

Passwall

Teleport

Phase Door

Etc.

Movement spells work according to the normal AD&D® and D&D® game rules.

Movement spells (including *teleport* as an innate ability), must always be used in the Missile and Magic Phase.

[14.14] ILLUSIONS.

DRUID

Hallucinatory Forest

MAGIC-USER

Dancing Lights

Ventriloquism

Audible Glamer

Fools Gold

Leomund's Trap

Nystul's Magic Aura

Phantasmal Force

Hallucinatory Terrain

Massmorph

Distance Distortion

Project Image

Simulacrum

ILLUSIONIST

Change Self

Improved Phantasmal Force

Phantasmal Killer

Spectral Force

Shadow Door

Shadow Magic

Demi-Shadow Magic

Permanent Illusion

Programmed Illusion

Veil

Etc.

A. Saving Throws.

The owning player must decide when any of his forces will check to see if something is illusory. If the owning player does not state that his forces are trying to disbelieve an illusion, his forces do not get a saving throw.

If the owning player decides to have his forces check, all 1:1 ratio figures on his side automatically make saving throws. All 2:1, 5:1, and 10:1 figures

must first make a Morale Check to see if they try to disbelieve, and then make a saving throw against the illusion. If some forces successfully disbelieve an illusion, all forces that failed their Morale Check get to make a saving throw next Game Round.

If an illusion is missing an expected sensory component (for example, sound), the figures that must check morale do so at +1 for that check only. If you are using a referee, the referee can optionally assign an additional bonus or penalty of 1 to the Morale Check based on his judgement as to whether the illusion is particularly appropriate or inappropriate to the situation.

(EXAMPLE: An illusion of dragons when dragons are known to be part of the army, or of quicksand when there is quicksand known to be on the battlefield, are particularly appropriate. On the other hand, an illusion of a good demi-god fighting on the side of evil creatures, or of Demogorgon suddenly appearing in the midst of an army of elves, is particularly inappropriate.)

If troops or heroes try to disbelieve something that is real, they automatically fail any saving throws that might apply against that real object.

B. Casting.

All illusion magic must be cast during the Missile and Magic Phase. If the casting player elects, he can delay the appearance of the illusion until a later phase (for example, to simulate a different type of spell) in the current or next Game Round.

All illusions are three-dimensional unless otherwise stated. Place figures or terrain pieces on the battlefield to represent illusions.

If an illusion is used to conceal something (e.g., an illusion of solid ground covering a trench), the first rank automatically falls in and the second rank must make saving throws vs. Paralyzation to avoid falling in. The third and subsequent ranks do not fail in.

In order to increase the "realism" of illusions, place cut-outs, counters, or miniatures on the tabletop to show what is "seen."

[14.15] MODIFICATION AND DISGUISE OF TERRAIN, TROOPS, ETC.

DRUID

Pass without Trace

Tree

Obscurement

Hallucinatory Forest

Pyrotechnics

Trip

Plant Growth

Snare

Transmute Rock to Mud

Dissolve

Wall of Fire

Wall of Thorns

MAGIC-USER

Web

Dig

Wall of Ice

Wall of Force

Hallucinatory Terrain

Distance Distortion

Wall of Iron

Wall of Stone

Move Earth

ILLUSIONIST

Wall of Fog

Fog Cloud

Etc.

Terrain/troop modification and concealment spells are of two types: illusions and real changes. Illusory modifications are treated like other illusions. Whether the modification is real or not, place terrain pieces, counters, or figures on the tabletop to show the effect. Place Magic markers to simulate temporary effects. To simulate a *wall of fog* or similar obscurement spell, you can use a Dungeon Masters Screen to conceal the troops hidden by the *wall*. Until the wall dissipates, all movement behind the *wall* cannot be seen by the enemy player.

[14.16] REGENERATION AND MAGICAL HEALING.

CLERICAL

Cure Light Wounds

Slow Poison

Cure Blindness

Cure Disease

Cure Serious Wounds

Cure Critical Wounds

Cureall

Raise Dead Fully

Restore

Neutralize Poison

Raise Dead

Heal

Regeneration

Resurrection

Etc.

Curative magic used on a figure representing a single individual works according to normal AD&D® or D&D® game rules.

When curative magic is used on a figure representing more than one creature that currently has a Wound marker, it has the following effects:

A *cure light/serious/critical wounds* spell cures 1 HD of damage for every level of the spell. A *heal, regeneration, restoration, or resurrection* spell cures 2 HD of damage for every level of the spell. If the total damage cured by such magic is equal to ½ the HD of a figure, its Wound marker is removed.

Raise dead can bring a single individual back to life, but that individual cannot fight for the rest of the battle. Place an Immobilized marker on any such individual or figure.

A *limited wish* or *alter reality* spell can remove one Wound marker. A *wish* spell can remove two Wound markers or bring any one figure back to life.

If the healing magic cures a number of hit points rather than a roll of hit dice, determine the number of hit points cured and divide by 4 to determine the number of hit dice restored.

[14.17] SPELLS THAT ONLY AFFECT INDIVIDUALS.

CLERIC

Command
Hold Person
Feign Death
Remove Curse
(*Curse*)
(*Blindness*)
(*Cause Light Wounds*)
(*Cause Serious Wounds*)
(*Cause Critical Wounds*)
Exorcise
Atonement
Plane Shift
Quest
(*Slay Living*)
(*Harm*)
(*Energy Drain*)
(*Wither*)
(*Destruction*)

DRUID

Animal Friendship
Feeblemind
Finger of Death
Transmute Metal to Wood
Enlarge
Jump
Strength

MAGIC-USER

Polymorph Other, Self, Any Object
Geas
(*Flesh to Stone*)
Tenser's Transformation
Power Word, Stun
Otto's Irresistible Dance
Dance
Power Word, Blind
Magic Jar
Trap the Soul
Imprisonment
ILLUSIONIST
Shape Change
Etc.

These spells are mostly for use by individual Heroes and commanders against enemy Heroes and commanders, or for additional defense. A creative player can find many uses for such spells. A referee is needed to decide on unusual uses for these spells.

The AD&D® game spells *command*, *hold person*, *feign death*, *blindness*.

feeblemind, *finger of death*, *enlarge*, *polymorph*, *power word stun*, *Otto's irresistible dance*, *power word blind*, *magic jar*, *trap the soul*, and *imprisonment* (and their D&D® game equivalents) can be used as pass-through fire.

[14.18] SPECIAL EFFECTS.

CLERIC

Create Water
Light
Purify Food and Drink
Silence 15' Rad.
Continual Light
Create Food and Water
Dispel Magic
Glyph of Warding
Lower Water
Dispel Evil
Part Water
Striking
Symbol
DRUID
Faerie Fire
Purify Water
Heat Metal
Produce Flame
Warp Wood
Stone Shape
Water Breathing
Produce Fire
Animal Growth
Turn Wood
MAGIC-USER

Affect Normal Fires
Burning Hands
Erase
Mending
Message
Push
Read Magic
Tenser's Floating Disc
Floating Disc
Write
Darkness 15' Rad.
Knock
Shatter
Wizard Lock
Explosive Runes
Enchanted Weapon
Extension I,II,III, etc.
Fire Trap
Rary's Mnemonic Enhancer
Airy Water
Leomund's Secret Chest
Telekinesis
Enchant an Item
Lower Water
Spiritwrack
Stone to Flesh
Sword
Drawmij's Instant Summons
Limited Wish
Reverse Gravity
Vanish
Clone
Glassteel
Permanency
Symbol
Time Stop

Wish

ILLUSIONIST
Gaze Reflection
Misdirection
Continual Darkness
Dispel Illusion
Non-Detection
Minor Creation
Major Creation
Alter Reality
Etc.

The official AD&D® and D&D® game spell descriptions define the normal use of these spells. The referee must rule on unusual or particularly creative applications of these spells.

The spells *wish*, *limited wish*, and *alter reality pose* special problems. The referee must apply the literal wording of the *wish* (regardless of what the player actually meant), and then decide whether the desired effect is compatible with other spells of the same level. (Remember, a *wish* is only a 9th level magic spell—not a grant of infinite power!)

A *wish* spell can cancel out another *wish* spell.

Any use of a *wish* is subject to the ruling of the referee. If the use of a *wish* spell is disallowed, the *wish* is still expended.

[14.19] CLERICS AND UNDEAD.

If a cleric successfully turns undead, a minimum of one figure is automatically routed, even if the cleric did not turn sufficient hit dice to equal one entire figure. A cleric can keep attempting to turn a unit of undead once per Game Round until an attempt is failed. After that, the cleric cannot attempt to turn any more undead in that particular unit, although he may attempt to turn the same kind of undead in a different unit.

If a cleric's power is such that he automatically destroys undead, he destroys a minimum of one figure of undead, even if he did not destroy sufficient hit dice to equal one entire figure.

If an evil cleric turns undead, he can sometimes make them enter his service (see DMG, p. 65). Such undead fall instantly under the command of that cleric, and follow his orders without question until they are killed, turned by an evil cleric on the other side, or move out of the cleric's CR. The same rules apply to avengers (D&D® Companion, book 1, p. 18).

[14.20] MAGIC ITEMS.

Magic items are handled in the same way as the spells they most closely resemble. Certain magic items have a specific effect in the BATTLESYSTEM™ game:

Ring of Human Influence (AD&D® game only): gives a commander a +1

Charisma bonus.

Rod of Rulership (AD&D® game only): gives a commander a +2 Charisma bonus.

Drums of Panic (AD&D® game only): forces an immediate Morale Check for every enemy unit with at least one figure in range of the effect.

Sphere of Annihilation (AD&D® game only): all figures must stay 2" away from it. If it is moved during the Missile and Magic Phase, it will "push" all figures that come within 2" of it out of its way.

Rod of Victory (D&D® game only): raises the morale of its entire side by 1.

Rod of Ruling (D&D® game only): gives any commander who wields it a +2 to Charisma.

[14.2] PSIONICS.

All psionic powers and attack modes operate as the spell-types they most closely resemble. Psionic vs. psionic combat can only take place between Heroes and commanders. *Psionic invisibility* cannot be detected using the table in DMG, p. 60. *Telepathic projection* can raise or lower enemy or friendly morale by 1 point.

[14.22] BARD POWERS. (AD&D® GAME ONLY)

A bard's singing can raise the morale of friendly figures in his CR by +1. Only one bard can provide this morale bonus to any single figure at a time.

A bard cannot sing and command at the same time unless he is singing *suggestions* to charmed troops.

15.0

FLYING MOVEMENT AND COMBAT

Creatures who have natural or magical flying ability greatly increase the options available to the BATTLESYSTEM™ Game commander, but also greatly complicate his job.

PROCEDURE

Basic rules on flying movement and combat for the AD&D® game are listed in the DMG, pp. 49-53. Those rules apply in the BATTLESYSTEM™ game except as specifically noted below. For the D&D® game, use the rules given below only.

CASES

[15.1] MOVEMENT.

The movement rate of flying creatures (both natural and magical) are the same as for the AD&D® game. Calculate flying movement rates in the D&D® game in the same way as ground movement rates. Also list the Maneuverability Class (AD&D® game only) for the creature on the Army Roster Sheet.

In the D&D® game, creatures smaller than man-sized can change direction up to 180 degrees per Game Round. Man-sized flying creatures can change direction up to 90 degrees per Game Round. Flying creatures significantly larger than man-sized can change direction up to 45 degrees per Game Round. Magical devices, spells, spell-effects, or innate magical abilities permitting flight (such as those possessed by air elementals) allow changes of direction up to 180 degrees per Game Round. This replaces the AD&D® game Maneuverability Class.

Mounted flying creatures maneuver at one category worse than normal. A creature flying at ½ or less its maximum

movement rate maneuvers at one category better than normal.

There are three altitudes for flying creatures: low (30', or 1"), medium (120', or 4"), and high (240', or 8"). Use the appropriate Altitude marker to show the height of flying creatures. (You can also stack flying creatures on dice, or otherwise mark them for easy visual reference.) Flying creatures on the ground do not need a marker.

It takes 1/3 of a figure's flying movement rate to rise one altitude level. There is no movement cost to descend any number of levels.

Most flying creatures can, of course, fly higher than 240'. However, 8" is the upper limit of the battlefield. A flying creature that flies higher than 8" has left the battlefield and is removed from play. (Note that a flying creature can escape by flying up.)

OPTIONAL RULE: In a primarily or exclusively flying battle, you can change the definition of altitude levels or create additional levels to increase the three-dimensional battlefield.

[15.2] FORMATIONS.

Flying units must be either in open or skirmish formation when flying. A flying unit that is otherwise entitled to do so can go into closed formation on the ground.

[15.3] COMBAT.

When a unit in flight attacks a unit on the ground, the unit on the ground

suffers a +2 AC penalty.

When a unit in flight fires missiles, treat short range as medium and medium range as long. **EXCEPTION:** Units using fly spells or *carpets of flying* suffer no penalties.

If a figure flying with wings receives any hit dice of damage (even if the damage is not sufficient to cause a wound), it must land immediately. It may move 1/3 its normal movement rate (even if it had already moved its full movement rate during the same Game Round) in landing, but must be on the ground at the end of its move. This does not apply to figures with innate or magical flying ability.

A flying figure with a Wound marker cannot take flight again. A flying figure that was forced to land because it received damage but did not receive a wound can take to the air again on the following Game Round.



[15.4] BOMBING.

Flying creatures can carry boulders or other "bombs." This gives them a maneuverability class one worse than normal. For every man-sized weight equivalent in "bombs" dropped, 2d6 damage is caused. Regardless of a victim's armor class, a bomb dropped from low altitude hits as if the victim were AC 10, a bomb from medium altitude hits as if the victim were AC 8, and a bomb from high altitude hits as if its victim were AC 4.

If magical or special "bombs" are to be used, the referee or other players must define their effects in advance.

CAMPAIGN RULES

The **BATTLESYSTEM™** game can be played in the context of a grand **AD&D®** or **D&D®** role-playing campaign. The special *Campaign Rules* are used for that purpose.

CASES

[16.1] RECOVERING CASUALTIES.

The "kills" in a **BATTLESYSTEM™** battle represent actual kills, wounds that immobilize or disable, and routed or fleeing characters.

If you are playing a campaign battle, you can recover some of your "killed" forces when the battle is over.

On that part of the battlefield your forces hold when the battle is over, you can recover 2/3 of the "dead" troops. You can also recover 2/3 of any forces routed off the tabletop (the remainder are assumed to have run away, never to return).

You can also take prisoner 1/3 of the enemy forces that fell on that part of the battlefield you hold. (Alternatively, you can kill them or let them escape.) Dealing with the prisoners you have captured is part of the on-going campaign, and is not dealt with here. Possibilities include holding them for ransom, *charming* them into joining your side, or trading them for your forces that the enemy took prisoner.

[16.2] EXPERIENCE POINTS.

In addition to all normal experience awards under the **AD&D®** and **D&D®** game systems, the following experience points apply to **BATTLESYSTEM™** engagements.

If the soldiers in a unit are capable of earning experience points, they earn the total XP kill value of all enemies their unit killed or routed off the tabletop divided by the number of soldiers who survived the battle. A unit that earns enough experience points can raise all its members in level, but must be able to raise all its members simultaneously in order to do so.

If a Unit Commander is capable of earning experience points (even if his unit is not capable of earning experience points), he receives 25% of the total XP kill value of all enemies his unit killed or routed off the tabletop, minus 25% of the XP value for all figures in his unit that were removed during the battle. (There is no penalty for wounded figures, and there is no benefit for figures recovered after the battle under [16.1], above.) In addition, of course, he receives any experience points for

individual combat in which he participated.

If a Brigade Commander is capable of earning experience (even if his subordinate commanders and troops cannot), he receives 25% of the XP earned by each subordinate Unit Commander (or what that Unit Commander would earn if capable of earning experience), and 25% of the XP earned by each subordinate skirmish or mob unit, as well as any XP earned through individual combat.

If an Army Commander is capable of earning experience, he receives 50% of what each of his Brigade Commanders earn (or would earn if they could earn experience points), in addition to any XP earned through individual combat. If an Army Commander has no subordinate Brigade Commanders, his XP is calculated in the same way as a Brigade Commander.

Regardless of battlefield losses, a commander can never receive a negative experience point award for command. If the XP award is a negative number, the commander receives an XP award of 0.

[16.3] CREATING ARMIES.

There are several different ways to fight a **BATTLESYSTEM™** battle: you can use a published **BATTLESYSTEM™** adventure or scenario from TSR, Inc., you can work a major battle into your campaign, or you can create your own battles and fight them as a miniatures wargame.

At some point you may find that you must create an army to fight the forces of your player characters. How do you create an army that is challenging but not overwhelming?

This section is designed to provide guidelines for creating armies that are roughly equal so that you can put together your own battles. It is a guideline only, since such factors as terrain, generalship, and military objective can have as much to do with victory and defeat as the strength of the armies themselves.

First, calculate the strength of the PCs and their forces to determine the number of Points and the Power Level of those forces. Determine whether one side has a terrain or defensive advantage. Then, using the system below, begin to build the opposing army.

You can also use this section to create two armies that are roughly equal in order to just fight a battle.

A. Power Levels.

The following Power Levels govern the type of game and the amount of magic that can be used.

BASIC GAME: Only Basic Game rules are allowed; forces that have Intermediate or Advanced Game abilities cannot use them.

INTERMEDIATE GAME: Only Basic Game and Intermediate Game rules are allowed; forces that have Advanced Game abilities cannot use them.

ADVANCED GAME/LOW MAGIC: In the **AD&D®** game, all **BATTLESYSTEM™** rules are allowed; spells and spell effects higher than 2nd level are not permitted; no magic item worth 1,200 XP or more is permitted. In the **D&D®** game, all **D&D®** Basic Game rules and items are permitted.

ADVANCED GAME/MEDIUM MAGIC: In the **AD&D®** game, all **BATTLESYSTEM™** rules are allowed; spells and spell effects higher than 5th level are not permitted; no magic item worth 4,000 XP or more is permitted. In the **D&D®** game, all **D&D®** Basic and Expert Game rules and items are permitted.

ADVANCED GAME/HIGH MAGIC: In the **AD&D®** game, all **BATTLESYSTEM™** rules are allowed; all spells and spell effects are allowed; each side can have no more than one *wish* spell for each 50,000 points it has; artifacts are not permitted. In the **D&D®** game, all **D&D®** Basic, Expert, and Companion Game rules and items are permitted.

ADVANCED GAME/ANYTHING GOES: In the **AD&D®** game, all **BATTLESYSTEM™** rules are allowed; all spells and spell effects are allowed; unlimited use of *wish* spells and artifacts permitted (within point cost limits). In the **D&D®** game, all official rules and items in any boxed game or module are permitted. Special or custom items permitted with the approval of the referee.

B. Points.

Each side receives a set number of points it can spend on troops, magic, and equipment. You can give a total number of points or you can give different totals for troops and commanders.

Each side can spend points according to the costs on Table 18. The referee has final say on how points are to be calculated, decides what is legal, and sets any special conditions for the battle. (Alternatively, the players can decide this among themselves in advance.)

Table 18. Point Costs.

Creature/Item Cost

SPELLS Pay 50 points per level of the spell (e.g., a 4th level spell costs 200 points).

MAGICAL ITEMS (AD&D® Game) 50% of the XP value from the DMG or other official source. If item has charges and also has spell capabilities above 3rd level, pay spell costs for each charge. (Scrolls cost only the value of the spell(s) they contain.)

MAGICAL ITEMS (D&D® Game) Varies by type. All plusses on weapons and armor cost 50 points per plus. Items that simulate spell effects cost 100 points per charge per spell level, or 1000 points per spell level if use is unlimited. Miscellaneous magic items cost 500 points each if they are in the Basic set, 2,500 points each if they are in the Expert set, 5,000 points each if they are in the Companion set, and 7,500 points each if they are in the Masters or higher sets. If the level of the item is unknown, consider it to be a Companion item. The referee can adjust these figures for game balance if he so desires.

ARTIFACTS/ CURSED ITEMS Cannot be purchased. **OPTIONAL RULE (AD&D® game only):** Can be purchased for 50% of the GP sale value.

CHARACTER TYPES Pay 1% of the maximum XP value for the level and class of the desired character type. Multi-classed characters pay the total cost for all classes. In addition, pay spell costs for all spell levels the character is capable of casting, and pay for all magic items the character possesses.

MONSTERS AD&D GAME: Pay the XP value for killing the creature, using the official AD&D® game value or as calculated by the DMG method, p. 85, whichever is higher.

D&D® GAME: Pay three times the XP value for killing the creature.

BOTH GAMES: If monster has spell-use, pay spell costs for all spell levels monster is capable of using. If monster has innate spell abilities, pay 50 points per spell level. If the monster's innate spell abilities are improved (usable at will, no save, extra range, no error, etc.), pay 100 points per spell level.

CATAPULTS AND BALLISTAE 200 points apiece.

EXAMPLES (AD&D® game):

An 18th level fighter/18th level magic-user with *chain mail +3*, *shield +1*, *sword of dancing*, a *wand of fire*, a *ring of invisibility*, and a scroll of 5 5th level spells costs the following:

- F 18 (2,750,000 XP) = 27,500 pts.
- MU 18 (3,375,000 XP) = 33,750 pts.
- Spells (139 spell levels) = 6,950 pts.
- Chain mail +3* (2,000 XP) = 1,000 pts.
- Shield + 1* (250 XP) = 125 pts.
- Sword of Dancing* (4,400 XP) = 2,200 pts.
- Wand of Fire* (4,500 XP) = 2,250 pts.
- Ring of Invisibility* (1,500 XP) = 750 pts.
- Scroll of 5 5th level spells (25 spell levels) = 1,250 pts.
- TOTAL = 75,775 pts.
- 100 ghouls (65 XP per ghoul) = 6,500 pts.
- 100 1st level fighters (2,000 XP each) with *swords + 1* (400 XP each) = 22,000 pts.
- 1 Iron Golem = 14,550 pts.
- 1 Lich (10,500 XP), abilities as 18th level Magic-User (139 spell levels @ 50 pts. each) = 17,450 pts.
- 1 Efreeti (1,950 XP), capable of 3 *wishes* per day (27 spell levels = 1,350 pts.), has innate spell abilities (14 spell levels = 700 pts.), can enter *gaseous form* (use potion cost, since there is no direct spell equivalent, 300 XP = 150 pts.), has unlimited use of *produce fire* and *pyrotechnics* (3 spell levels @ 100 pts. each) = 4,450 pts.

If there is any disagreement about how to calculate the point cost of a particular creature or item, always use the method that gives the highest total cost.

[16.4] COMMON SENSE.

The BATTLESYSTEM™ rules govern only the most basic elements of mass

combat. Because of the profusion of strange monsters, magic spells, and magical items in both the AD&D® and D&D® games (and the likelihood of much more to come!), and because of the different playing styles that each player can adopt, it is inappropriate of us to tell you what is the only "correct" way to play.

However, we can tell you that the use of common sense will greatly improve your enjoyment. For example, although the rules don't forbid it, elves commanded by a half-orc should certainly suffer some sort of morale penalty. And before you equip 2,000 kobolds with longbows, remember that the longbow is a difficult weapon that requires strength and many years of practice. Creatures of widely differing alignment are unlikely to work together in harmony. Of course, there's nothing to stop you from putting together an arbitrary and silly battle for an evening's pleasure. But there is more pleasure to be found in a well-designed, well-balanced scenario where the individual components all make sense in medieval fantasy, the use of powerful magic is kept within reasonable bounds, and the whole battle is integrated into an ongoing campaign.

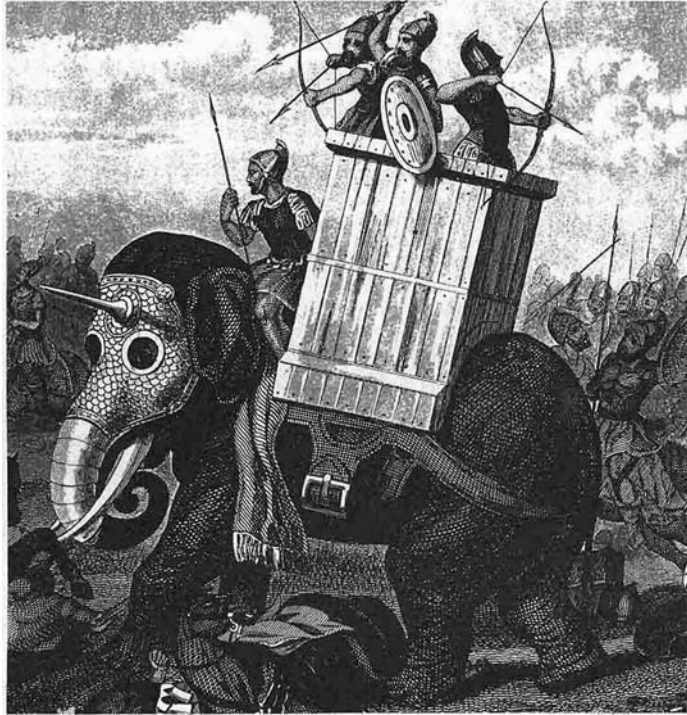

This ends the Advanced Game Rules.
You are now ready to play the Advanced
Scenarios in the Scenario Book or to
create your own BATTLESYSTEM™ Game
adventures.

Table of Contents

PART 1. INTRODUCTION TO BATTLESYSTEM™

GAME PARTS GETTING STARTED

[1.0] SEQUENCE OF PLAY

- [1.1] INITIATIVE PHASE
- [1.2] INITIAL MISSILE PHASE
- [1.3] RALLY PHASE
- [1.4] MOVEMENT PHASE
- [1.5] MISSILE & MAGIC PHASE
- [1.6] MELEE PHASE
- [1.7] END OF GAME ROUND PHASE

[2.0] COUNTERS, SCALE AND UNIT ORGANIZATION

- [2.1] GROUND SCALE
- [2.2] COUNTER RATIOS
- [2.3] COUNTER SCALE
- [2.4] MOUNTING MINIATURE FIGURES
- [2.5] SPECIAL COUNTERS
- [2.6] TYPES OF UNITS
- [2.7] INDIVIDUALS
- [2.8] REGULAR UNITS
- [2.9] SKIRMISH UNITS
- [2.10] MOBS
- [2.11] SPECIAL UNIT TYPES

[3.0] SETTING UP

- [3.1] ARMY ROSTER SHEET
- [3.2] HEROES AND COMMANDERS ROSTER SHEET
- [3.3] CHARACTER RECORD SHEETS
- [3.4] ARMY PLACEMENT
- [3.5] MEASUREMENT

[4.0] MORALE, DISCIPLINE AND COMMAND

A. MORALE

- [4.1] DETERMINING BASE MORALE
- [4.2] DETERMINING CURRENT MORALE
- [4.3] HOW TO CHECK MORALE
- [4.4] WHEN TO CHECK MORALE
- [4.5] EFFECT OF MORALE CHECKS

B. DISCIPLINE

- [4.6] DISCIPLINE

C. COMMAND

- [4.7] DEFINITION OF COMMAND
- [4.8] COMMAND RADIUS
- [4.9] CHARISMA BONUS
- [4.10] COMMAND HIERARCHY

PART 2. THE BASIC GAME

[5.0] INITIATIVE PHASE

- [5.1] TEAM INITIATIVE
- [5.2] INDIVIDUAL INITIATIVE

[6.0] RALLY PHASE

- [6.1] CONDITIONS FOR RALLY
- [6.2] HOW TO RALLY
- [6.3] IF THE UNIT IS RALLIED
- [6.4] IF THE UNIT DOES NOT RALLY
- [6.5] OUT OF COMMAND UNITS
- [6.6] GIVING ORDERS TO A MOB

[7.0] MOVEMENT PHASE

A. FORMATIONS

- [7.1] DEFINITION OF FORMATION
- [7.2] CLOSED FORMATION
- [7.3] OPEN FORMATION
- [7.4] SKIRMISH FORMATION
- [7.5] MOB FORMATION
- [7.6] CHANGING FORMATION

B. MOVEMENT

- [7.7] HOW TO MOVE
- [7.8] MOVEMENT AND ENEMY UNITS
- [7.9] CHANGING DIRECTION
- [7.10] CHANGING FRONTAGE
- [7.11] WRAP-AROUND MOVEMENT
- [7.12] FIGHTING WITHDRAWAL
- [7.13] FORCED MARCH
- [7.14] CHARGE
- [7.15] ROUTING

[8.0] MELEE PHASE

- [8.1] FORCES ELIGIBLE TO FIGHT
- [8.2] WEAPON IN HAND
- [8.3] DETERMINING ATTACK RATINGS
- [8.4] MELEE PROCEDURE
- [8.5] DICE CONVERSIONS
- [8.6] MULTIPLE ATTACKS
- [8.7] KILLED AND WOUNDED FIGURES
- [8.8] ENDING A MELEE

PART 3. THE INTERMEDIATE GAME

[9.0] HEROES AND COMMANDERS

- [9.1] CHARACTERS AS MEMBERS OF UNITS
- [9.2] CHARACTERS AS COMMANDERS
- [9.3] CHARACTERS AS DEPUTY COMMANDERS
- [9.4] CHARACTERS AS HEROES

[10.0] MISSILES AND ARTILLERY

A. MISSILE WEAPONS

- [10.1] WHO CAN USE MISSILES
- [10.2] WHEN MISSILES ARE USED
- [10.3] AMMUNITION
- [10.4] MOVEMENT AND MISSILE FIRE
- [10.5] SPLIT-FIRE
- [10.6] PASS-THROUGH FIRE
- [10.7] INDIRECT FIRE
- [10.8] MISSILE FIRE MODIFIERS

B. ARTILLERY

- [10.9] ARTILLERY WEAPONS
- [10.10] ARTILLERY CREWS
- [10.11] SPECIAL ARTILLERY AMMUNITION

[11.0] SPECIAL MOVEMENT

A. CAVALRY AND CHARIOTS

- [11.1] DEFINITION OF TERMS
- [11.2] RATING CAVALRY
- [11.3] RATING CHARIOTS
- [11.4] CAVALRY AND CHARIOT CHARGES
- [11.5] CAVALRY AND CHARIOTS IN MELEE COMBAT

B. SPECIAL FORMATIONS

- [11.6] SHIELD WALL
- [11.7] SET SPEARS/PIKES

C. TERRAIN EFFECTS

- [11.8] TERRAIN EFFECTS ON MOVEMENT
- [11.9] TERRAIN EFFECTS ON COMBAT

PART 4. THE ADVANCED GAME

[12.0] WEATHER CONDITIONS AND NIGHT BATTLES

- [12.1] INITIAL WEATHER CONDITIONS

- [12.2] EFFECT OF WEATHER CONDITIONS

- [12.3] SPECIAL WEATHER CONDITIONS

- [12.4] WEATHER MAGIC

- [12.5] NIGHT BATTLES

[13.0] SPECIAL CREATURE ABILITIES

- [13.1] COMBAT BONUSES AND PENALTIES

- [13.2] POISON

- [13.3] INVULNERABILITY

- [13.4] PARALYSIS

- [13.5] LEVEL DRAINING

- [13.6] AWE AND FEAR

- [13.7] BREATH WEAPONS

- [13.8] REGENERATION

- [13.9] UNDEAD AND MINDLESS CREATURES

[14.0] MAGIC

- A. RULES AND REGULATIONS FOR MAGIC USE

- [14.1] RESTRICTIONS OF MAGIC USE

- [14.2] GAME SCALE AND AREA OF EFFECT

- [14.3] SAYING THROWS

- [14.4] LINE OF SIGHT

B. TYPES OF MAGIC

- [14.5] MAGICAL WEAPONS AND ARTILLERY SPELLS

- [14.6] CHARM, HOLD, AND TEMPORARY IMMOBILIZATION

- [14.7] BONUSES AND PENALTIES

- [14.8] INVISIBILITY

- [14.9] AWE AND FEAR

- [14.10] CREATE TROOPS

- [14.11] DETECTION AND INFORMATION

- [14.12] MAGICAL DEFENSES

- [14.13] MOVEMENT

- [14.14] ILLUSIONS

- [14.15] MODIFICATION/DISGUISE OF TERRAIN/TROOPS

- [14.16] REGENERATION AND MAGICAL HEALING

- [14.17] SPELLS THAT ONLY AFFECT INDIVIDUALS

- [14.18] SPECIAL EFFECTS

- [14.19] CLERICS AND UNDEAD

- [14.20] MAGIC ITEMS

- [14.21] PSIONICS

- [14.22] BARDIC POWERS

[15.0] FLYING MOVEMENT AND COMBAT

- [15.1] MOVEMENT

- [15.2] FORMATIONS

- [15.3] COMBAT

- [15.4] BOMBING

[16.0] CAMPAIGN RULES

- [16.1] RECOVERING CASUALTIES

- [16.2] EXPERIENCE POINTS

- [16.3] CREATING ARMIES

- [16.4] COMMON SENSE

Combat Results Table

ATTACK ROLL	DAMAGE										
	D2	D3	D4	D6	D8	D10	D12	D14	D16	D18	D20
0/less	5	7	9	12	15	18	20	22	24	28	32
1	4	6	8	11	14	17	19	21	23	26	29
2	3	6	7	10	13	16	18	20	22	24	26
3	3	5	7	10	13	15	18	20	22	23	25
4	3	5	7	9	12	15	17	19	20	22	24
5	3	4	6	9	11	14	17	18	20	21	23
6	3	4	6	8	11	14	16	17	18	20	22
7	3	4	6	8	11	13	15	15	17	19	21
8	2	4	5	8	10	12	15	15	16	18	20
9	2	3	5	7	10	12	14	14	15	17	19
10	2	3	5	7	9	11	13	13	15	16	18
11	2	3	5	6	8	10	12	12	14	15	17
12	2	3	4	6	8	10	11	12	13	14	16
13	2	3	4	6	7	9	11	11	12	13	15
14	2	2	4	5	7	8	10	11	11	12	13
15	1	2	4	5	6	8	9	10	11	12	13
16	1	2	3	5	6	7	9	9	10	11	12
17	1	2	3	4	5	7	8	8	9	10	11
18	1	2	3	4	5	6	7	8	8	9	10
19	1	1	3	4	5	6	6	7	8	8	9
20	1	1	2	3	4	5	6	6	7	8	8
21	1	1	2	3	4	4	5	5	7	8	8
22	1	1	2	2	3	4	4	5	6	7	8
23	0.5	1	1	2	3	3	4	4	5	6	7
24	0.5	1	1	2	2	3	3	4	5	6	7
25	0.5	0.5	1	1	2	2	2	3	4	6	6
26	0.2	0.5	1	1	1	1	2	3	3	5	5
27	0.2	0.5	0.5	0.5	1	1	1	3	3	5	5
28	0.1	0.2	0.5	0.5	0.5	1	1	2	3	4	4
29	0.1	0.2	0.2	0.2	0.5	0.5	1	2	2	3	4
30	0.1	0.1	0.1	0.2	0.2	0.5	0.5	1	2	3	3
31	0	0.1	0.1	0.1	0.2	0.2	0.5	1	1	2	3
32	0	0	0	0.1	0.1	0.2	0.2	0.5	1	2	2
33	0	0	0	0	0.1	0.1	0.2	0.5	0.5	1	2
34	0	0	0	0	0.1	0.1	0.1	0.5	0.5	1	1
35-39	0	0	0	0	0	0.1	0.1	0.2	0.2	0.5	1
40+	0	0	0	0	0	0	0	0	0	0	0



TSR, Inc.

PRODUCTS OF YOUR IMAGINATION™

ADVANCED DUNGEONS & DRAGONS, DUNGEONS & DRAGONS, PRODUCTS OF YOUR IMAGINATION,
BATTLESYSTEM, and the TSR logo are trademarks owned by TSR, Inc.
1985 TSR, Inc. All Rights Reserved. Printed in U.S.A.

BATTLE SYSTEM™

Fantasy Combat Supplement

Scenario Book

This booklet contains four complete **BATTLESYSTEM™** scenarios ready to play. The first three scenarios are designed for the Basic, Intermediate, and Advanced Games, respectively, and cover three battles in a war between monsters. The fourth scenario is an Advanced Game battle set in the **DRAGONLANCE™** campaign world. That battle takes place during the time period covered in DL 2, **DRAGONS OF FLAME**, while the **DRAGONLANCE** characters are adventuring in the dungeons of Pax Tharkas.

Pages 5-20 of this booklet are roster forms ready for play. They are organized so that if you bend back the staples in the center (carefully!), pull out the roster pages, and cut them into single sheets, each front-and-back sheet contains rosters for forces on the same side (good or evil).

Use the **BATTLESYSTEM** metal miniatures to represent the Army Commanders in each battle. If you have miniatures of your own, use them first as heroes and unit commanders, and second as troops. Otherwise, use the counters provided with the game.

The counters in the **BATTLESYSTEM** game represent a wide variety of creatures so that you can play battles involving a number of different creature types. Because of this variety, no single creature type has a huge number of counters. Some

scenarios call for more of one creature type than there are counters in the game. Substitute another creature counter of the same size when this occurs. For example, use human or dwarf counters for one of the



elven units in the Battle of Qualinost scenario. Whenever possible, all the counters in a single unit should be of this same type. This helps avoid confusion on the battlefield.

On the roster sheets, certain adjustments that remain constant (such as ML and AR adjustments for a leader fighting with his unit) have not been entered. Refer to the Player Aid Cards during play.

Whenever a unit commander is listed on the unit description together with his CR (e.g. Bairn Stonewall—CR 10"), no separate roster for that commander has been included. In this case, the unit commander is assumed to have the same level, AC, weapons, MR, etc., as the members of the unit.

Basic Game Scenario

Battle at the Crossroads

The first reports sounded just like another monster raid, perhaps a little larger than usual. But soon it becomes clear that a huge army of monsters has gathered in the wilderness and has swept into the borderlands. Small, isolated settlements have fallen before the advance, and refugees are streaming toward the imagined safety of the interior.

The leading force of monsters—a brigade of orcs, ogres, and goblins—is advancing rapidly and will soon close off a key crossroads. If this occurs, many of the refugees will be trapped, and face certain capture—or worse—at the lands of the evil horde.

The trained warriors and local militia from the small town of Glarus have moved out to meet the spearhead of the monster army. Hours before the battle begins, the humans are joined by small contingents from the nearby dwarven and halfling communities. Petty differences are set aside, and all agree to fight together.

Now the tramp of heavy footsteps resounds from just beyond the horizon. The monsters will soon be in sight. Can the little force at the crossroads destroy this advance guard and give the refugees a chance to escape before the main force of the monsters arrives?

The two armies are the Crossroads Force (Good) and the Borderland Spearhead (Evil). Use the map below to create the battlefield. The Evil side sets up its forces first, followed by the Good side. Units may begin in any eligible formation. Mark the prohibited

areas on the battlefield with cutouts of construction paper, or with a tape and string border. No unit or figure may enter this area during the battle.

All rules of the Basic Game are used in this scenario. Intermediate and Advanced Game rules do not apply.

The victor is the last player with at least one figure remaining on the field—all enemy forces must have been routed or killed. If the result is a tie (forces annihilate each other), the Good side wins.

The battle takes place in daylight. The weather is good.

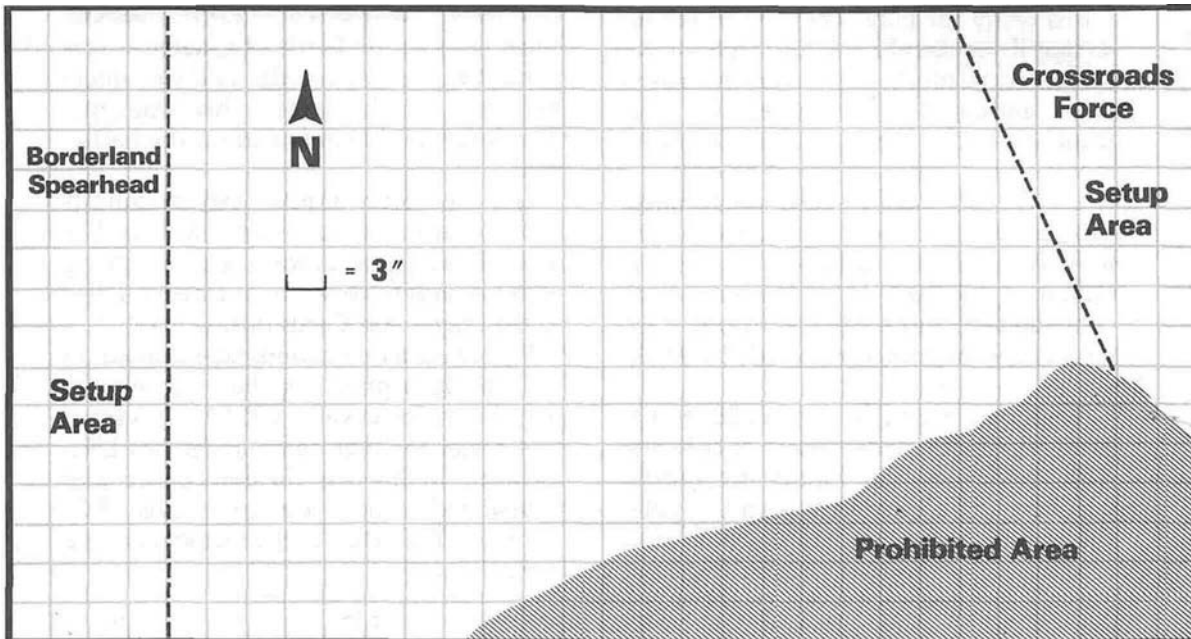

Intermediate Game Scenario

Battle of Lairn

Three days after the Battle at the Crossroads, another powerful force of monsters was discovered sweeping into civilized lands. This force was the forward wing of the main invasion body, heading directly toward the peaceful town of Lairn.

Again, the steadfast dwarven nation sent aid to its human allies, and dwarves and humans prepared to defend Lairn against the forward wing. Dubbed the "Army du' Lairn," this force was commanded by the reknowned Baron Grange Rarrack of Lairn.

Scouts have reported that yet another body of monsters follows in the wake of the forward wing. The Baron knows that he must crush the initial force before the two monster armies can link up. Reinforcements, including a unit of skilled elven warriors, may arrive in a week or so; but until then, the Army du' Lairn is on its own.

The Baron has collected his force on the fields before the town, since the town is in a weak defensive position. The monsters delay their attack until near sunset, thus preventing the goblin troops from having to fight in bright light.

Use the accompanying map to set up the battlefield and place terrain types. Both armies set up simultaneously at the locations shown. Units may begin in any allowable formation. The playing surface should not be larger than 4 ft. by 8 ft.

The victor is the last player with at least one figure remaining on the field—all enemy forces must have

been routed or killed. If the result is a tie (forces annihilate each other), the Evil side wins.

All rules from the Basic and Intermediate Games apply in this scenario. No Advanced Game rules may be used.

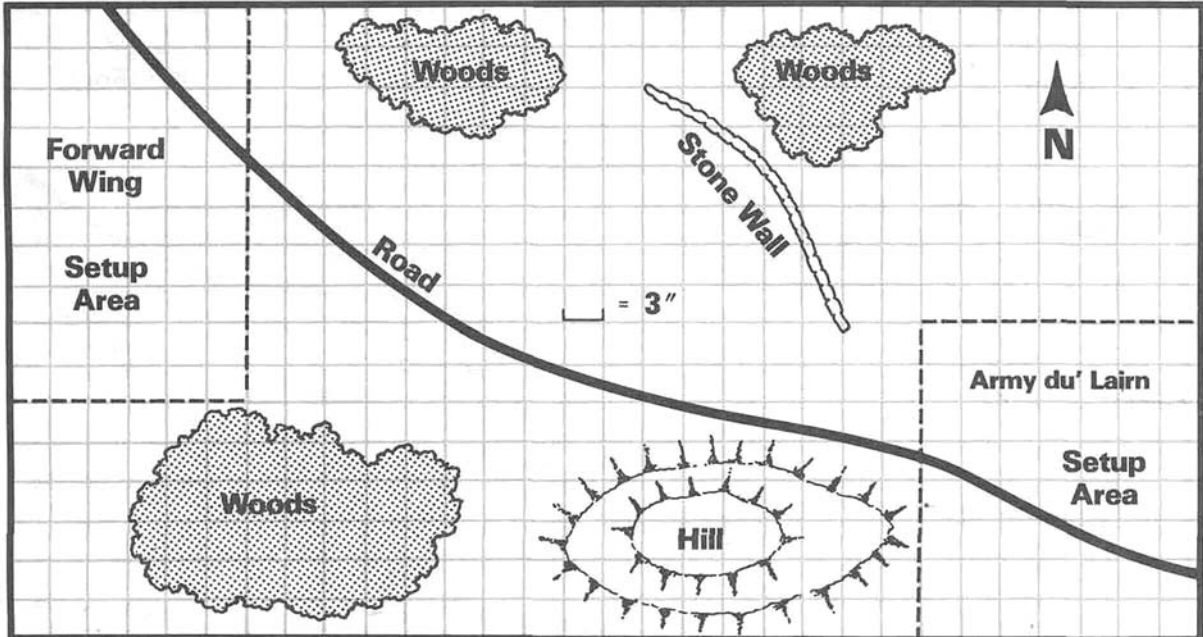

Advanced Game Scenario

Battle of Merrell's Crossing

The main force of the monster army has come to the fore. The initial skirmishes are over; now the fate of civilization will be determined by a single battle. General Garrock, the King's own field commander, has assumed command of the forces of good, and has established his major line of defense along the banks of the winding Merrell River.

At this point the water is shallow enough to allow many crossings. General Garrock holds his forces a little back from the river. The evil warrior Black Derek is in command of the monster army. He is sure to press his attack harshly, showing no mercy.

A force of elite elven warriors has arrived to bolster the General's line, but the monsters are rumored to have a force of trolls—even the stoutest warrior trembles at the thought of such powerful evil.

Use the accompanying map to set up the terrain on the battlefield. The Landforce (Good) sets up first, in the area indicated on the map, and then the forces of the Main Body (Evil) are placed on the map. Units may be set up in any allowable formation. Spells may be cast before the actual battle begins. Be sure to keep track of duration of all precast spells.

If space is available, the battlefield may be extended 12" to the north. This is especially useful if the Optional Rule, below, is used.

The battle ends in a victory for the Landforce if all

enemy figures are killed or routed off the field. The battle ends in a victory for the Main Body if all enemy figures are killed or routed off the field and if the Main Body has at least 30 figures left. Any other result is a draw.

All BATTLESYSTEM rules from the Basic, Intermediate, and Advanced Games are used in this battle.

Special Rule 1: Two figures can shoot missiles or fight in melee through each of the four walls of the Hut. This represents the effects of arrowslits and other apertures in the walls. Figures placed in the hut have "hard cover" (-4 to AC).

Special Rule 2: The Main Body automatically receives initiative on the first Game Round.

Special Rule 3: The special Elite unit optional rule (2.11) is used in this scenario.

Optional Rule: If you are playing the three scenarios as a campaign, all forces which survive the Basic and Intermediate Scenario can be added to the armies, making a much larger battle. Treat the forces from the earlier scenarios as Brigades.

Alternately, all the forces from the three scenarios can be brought together to fight one huge battle if desired.

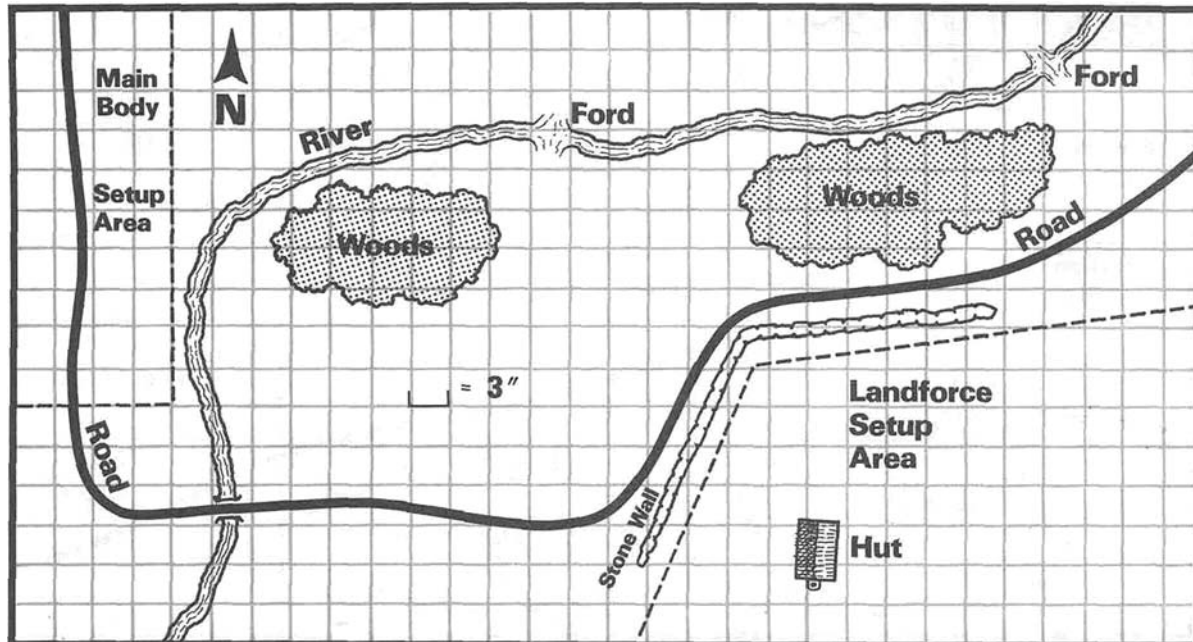

DRAGONLANCE™ SCENARIO

Battle of Qualinost

The armies of the evil Dragon Highlords are sweeping across the face of Krynn. All who resisted their inexorable march have been destroyed.

The elves of the ancient kingdom of Qualinesti know that they do not possess enough strength to halt the onrushing hordes of dragons and their allies, and have reluctantly decided to abandon the ancient elven homeland and retreat to safer shores.

But even this evacuation is threatened by the swift advance of the dragon armies. Three evil armies menace the elven kingdom, and may soon block off all hope of safety.

A party of brave heroes have set forth on a perilous mission to mighty Pax Tharkas (see DL 2 DRAGONS OF FLAME). This mission, if successful, should distract one of the dragon armies. The other two thrusts are coming from the north, however, and the small Qualinesti Army must be divided into the First and Second Armies in an attempt to delay the advance of the dragon armies so that their people can escape.

The Dragonarmy Red Wing Four's advance has been delayed, so the elves have a chance. Red Wing One, the largest of the invading armies, is driving straight for the elven capital, Qualinost. Only the Second Qualinesti Army stands in its way.

This is the battle that will determine the fate of the Qualinesti elves. Porthios Guildleaf, son of the ruler of Qualinesti, is commanding the elven army. Verminaard, Dragon Highmaster of the Red Wing, is determined to see the race of elves wiped from the face of Krynn.

This battlefield has several elevations, and is mostly forest. Use the 3-D ADVENTURE FOLD-UP™ figures and the suggestions in THE ART OF THREE-DIMENSIONAL GAMING to create the battlefield. Since the field is mostly forest, you may decide to mark only the clearings, and not the forest. Set the Second Qualinesti Army up first, followed by Red Wing One. Units can begin in any allowable formation. Spells can be precast, and flying creatures may start the battle in the air. This battle takes place during the daytime.

You will need to record the passage of Game Rounds in this battle to determine victory conditions.

The Second Qualinesti Army wins the battle if, after twelve Game Rounds, no more than twelve enemy figures have moved off the south end of the table. Red Wing One wins the battle if, after twelve Game Rounds, at least twenty friendly figures have moved off the south end of the table. Any other result is a draw.

This battle uses all BATTLESYSTEM Basic, Intermediate, and Advanced Game rules.

Special Rule 1: To move figures off the field, they must first be moved to the southern edge of the battlefield during their Movement Phase and stop there, even if they have additional movement remaining. On any following Movement Phase, the owning player declares that the figures are leaving the table. Set aside such figures until the end of the battle, then count them to determine the victor.

Routed evil figures cannot leave the table by the south edge.

Special Rule 2: Kapak Draconians have the ability to poison their swords with their venomous saliva. The unit of kapaks can envenom their swords by spending one complete Game Round without moving or fighting. The draconians can be attacked by magic or missile fire without preventing the envenoming; however, if the unit routs, the weapons cannot be poisoned during that Game Round. The kapak poison paralyzes its victims for 2-12 rounds. The swords, once envenomed, stay poisoned for three Game Rounds, even if they are used in melee.

Special Rule 3: Both types of draconians can take their weapons in their mouths and drop to all four limbs while charging. This is the 15" movement rate shown on the rosters. Draconians can gain normal charge bonus in addition to this movement, and can attack normally after completing a charge.

Red Wing One

Setup Area

Stream



Clearing

3'

Clearing

Hill

Clearing

Second Quadrant Army

Setup Area

Hill

Heroes and Commanders Roster Sheet

ARMY NAME Main Body
PLAYER NAME Advanced Scenario

NAME									CLASS/LEVEL			NAME									CLASS/LEVEL					
Black Derek									F 14			Dire - hand									/					
COMMAND RANK		S	I	W	D	Co	Ch	MR%	COMMAND RANK		S	I	W	D	Co	Ch	MR%	COMMAND RANK		S	I	W	D	Co	Ch	MR%
Army		16	15	14	10	11	18	0	Hero								0	Hero								0
AC	CB	RACE		PPD	P/P	RSW	BW	Sp	AC	CB	RACE		PPD	P/P	RSW	BW	Sp	AC	CB	RACE		PPD	P/P	RSW	BW	Sp
-2	+2	Human		2	3	4	3	5	0	/	Stone giant		8	9	10	9	11	0	/	Stone giant		8	9	10	9	11
HD	CR	WEAPON/DAMAGE/# AT							HD	CR	WEAPON/DAMAGE/# AT															
14	19"	Halberd +2 1d10+3/2d6+3							9'	/	3d6															
hp	MV								hp	MV																
90	9"								41	12"																
THACO	AR	THACO/AR Modifiers							THACO	AR	THACO/AR Modifiers															
6	21								12	27																
SPECIAL ABILITIES and LIMITATIONS												SPECIAL ABILITIES and LIMITATIONS														
Ring of protection +3												Hurl rocks; range 10/20/30" dmg 3d10														

NAME									CLASS/LEVEL			NAME									CLASS/LEVEL					
Carinol Bloodgrun									C 8			Stone-fist									/					
COMMAND RANK		S	I	W	D	Co	Ch	MR%	COMMAND RANK		S	I	W	D	Co	Ch	MR%	COMMAND RANK		S	I	W	D	Co	Ch	MR%
Dep. Army		12	13	15	9	14	17	0	Hero								0	Hero								0
AC	CB	RACE		PPD	P/P	RSW	BW	Sp	AC	CB	RACE		PPD	P/P	RSW	BW	Sp	AC	CB	RACE		PPD	P/P	RSW	BW	Sp
2	+2	Human		7	10	11	13	12	0	/	Stone giant		8	9	10	9	11	0	/	Stone giant		8	9	10	9	11
HD	CR	WEAPON/DAMAGE/# AT							HD	CR	WEAPON/DAMAGE/# AT															
8	13"	Mace +2 1d6+3/1d6+2							9	/	3d6															
hp	MV								hp	MV																
34	9"								43	12"																
THACO	AR	THACO/AR Modifiers							THACO	AR	THACO/AR Modifiers															
14	29								12	27																
SPECIAL ABILITIES and LIMITATIONS												SPECIAL ABILITIES and LIMITATIONS														
Spells by level: 4 - Cure serious wounds (x2) 3 - Prayer; disp. magic (x2) 2 - Spir. hammer; silence 15'; hold person 1 - Det. magic; bless; cure lt. wounds												Hurl rocks; range 10/20/30" dmg; 3d10														

Heroes and Commanders Roster Sheet

ARMY NAME Forward Wing
PLAYER NAME Intermediate Scenario

NAME Horibb Roake				CLASS/LEVEL F 10				NAME Snaggart				CLASS/LEVEL /					
COMMAND RANK Army		S 16	I 12	W 14	D 10	Co 14	Ch 16	MR% 	COMMAND RANK Unit		S 	I 	W 	D 	Co 	Ch 	MR% 0
AC 0	CB +1	RACE Human		PPD 8	P/P 9	RSW 10	BW 9	Sp 11	AC 3	CB 0	RACE Ogre		PPD 13	P/P 14	RSW 15	BW 16	Sp 16
HD 10	CR 16"	WEAPON/DAMAGE/# AT 2 Handed sword +2 1d10+3/3d6+3						HD 7	CR 6"	WEAPON/DAMAGE/# AT 2d6							
hp 59	MV 15"							hp 33	MV 9"								
THACO 10	AR 25	THACO/AR Modifiers						THACO 13	AR 28	THACO/AR Modifiers							
SPECIAL ABILITIES and LIMITATIONS Rides heavy warhorse									SPECIAL ABILITIES and LIMITATIONS								
NAME Trunk - foot				CLASS/LEVEL /				NAME Club - nose				CLASS/LEVEL /					
COMMAND RANK Hero		S 	I 	W 	D 	Co 	Ch 	MR% 0	COMMAND RANK Hero		S 	I 	W 	D 	Co 	Ch 	MR% 0
AC 4	CB /	RACE Hill giant		PPD 10	P/P 11	RSW 12	BW 12	Sp 13	AC 4	CB /	RACE Hill giant		PPD 10	P/P 11	RSW 12	BW 12	Sp 13
HD 8	CR /	WEAPON/DAMAGE/# AT 2d8						HD 8	CR /	WEAPON/DAMAGE/# AT 2d8							
hp 40	MV 12"							hp 38	MV 12"								
THACO 12	AR 27	THACO/AR Modifiers						THACO 12	AR 27	THACO/AR Modifiers							
SPECIAL ABILITIES and LIMITATIONS Hurl rocks; range 7/14/20" dmg 2d8									SPECIAL ABILITIES and LIMITATIONS Hurl rocks; range 7/14/20" dmg 2d8								

Heroes and Commanders Roster Sheet

ARMY NAME Landforce
PLAYER NAME Advanced Scenario

NAME Garrock								CLASS/LEVEL F 15			NAME Mareth Harowll								CLASS/LEVEL C 12		
COMMAND RANK Army				S 17	I 10	W 12	D 9	Co 11	Ch 17	MR% 0	COMMAND RANK Dep. Army				S 9	I 12	W 17	D 13	Co 10	Ch 16	MR% 0
AC -2	CB +2	RACE Human		PPD 4	P/P 5	RSW 6	BW 4	Sp 7	AC 2	CB +1	RACE Human		PPD 6	P/P 9	RSW 10	BW 12	Sp 11				
HD 15	CR 19"	WEAPON/DAMAGE/# AT 2 Handed sword +2 1d10+3/3d6+3							HD 12	CR 14"	WEAPON/DAMAGE/# AT Mace +1 1d6+2/1d6+1										
hp 62	MV 9"	2 Att./Round							hp 41	MV 9"											
THACO 3	AR 18	THACO/AR Modifiers							THACO 13	AR 28	THACO/AR Modifiers										
SPECIAL ABILITIES and LIMITATIONS										SPECIAL ABILITIES and LIMITATIONS Spells by level: 6 - Blade barrier (x2) 5 - Cure crit. wound; insect plague 4 - Cure serious wound (x3) 3 - Prayer (x3) Disp. magic (x2) 2 - Silence 15';hold pers.(x4)spir.ham. 1 - Det. mag. (x3) bless (x3)											
NAME Kint Leafholder								CLASS/LEVEL F/MU 7/7			NAME Gysseriol Wyn								CLASS/LEVEL MU 10		
COMMAND RANK Unit				S 15	I 14	W 10	D 15	Co 9	Ch 14	MR% 0	COMMAND RANK Hero				S 8	I 18	W 12	D 13	Co 9	Ch 7	MR% 0
AC 3	CB 0	RACE Elf		PPD 10	P/P 11	RSW 9	BW 12	Sp 10	AC 6	CB /	RACE Human		PPD 13	P/P 11	RSW 9	BW 13	Sp 10				
HD 7	CR 14"	WEAPON/DAMAGE/# AT Longsword +3 1d8+3/1d12+3							HD 10	CR /	WEAPON/DAMAGE/# AT Dagger										
hp 22	MV 12"								hp 21	MV 12"											
THACO 10	AR 25	THACO/AR Modifiers							THACO 20	AR 35	THACO/AR Modifiers										
SPECIAL ABILITIES and LIMITATIONS Spells by level: 4 - Dig 3 - Fireball; haste 2 - Invisibility; web; det. invis. 1 - Magic missile (x2); det magic, jump										SPECIAL ABILITIES and LIMITATIONS Spells by level: 5 - Cloudkill; trans. rock to mud 4 - Fear; ice storm 3 - Fly; fireball (x2) 2 - Invis.; web; det. invis. (x2) 1 - Magic missile (x2); sleep (x2)											

Heroes and Commanders Roster Sheet

ARMY NAME

Army du' Lairn

PLAYER NAME

Intermediate Scenario

NAME Grange Rarrack				CLASS/LEVEL F 10				NAME Randar				CLASS/LEVEL F 5					
COMMAND RANK Army		S 16	I 10	W 11	D 9	Co 14	Ch 17	MR% 0	COMMAND RANK Unit		S 14	I 11	W 12	D 14	Co 12	Ch 10	MR% 0
AC 0	CB +2	RACE Human		PPD 8	P/P 9	RSW 10	BW 9	Sp 11	AC 7	CB 0	RACE Human		PPD 11	P/P 12	RSW 13	BW 13	Sp 14
HD 10	CR 16"	WEAPON/DAMAGE/# AT 2 Handed sword +4						HD 5	CR 12"	WEAPON/DAMAGE/# AT Longsword +3							
hp 48	MV 15"	1d10+5/3d6+5						hp 24	MV 24"	1d8+3/1d12+3							
THACO 8	AR 23	THACO/AR Modifiers						THACO 13	AR 28	THACO/AR Modifiers							
SPECIAL ABILITIES and LIMITATIONS Mounted on heavy warhorse								SPECIAL ABILITIES and LIMITATIONS Mounted on light warhorse									
NAME Eric of Lairn				CLASS/LEVEL F 4				NAME Roderick of Lairn				CLASS/LEVEL F 9					
COMMAND RANK Unit		S 12	I 9	W 14	D 16	Co 11	Ch 15	MR% 0	COMMAND RANK Unit		S 18/ 52	I 11	W 14	D 9	Co 10	Ch 13	MR% 0
AC 8	CB +1	RACE Human		PPD 13	P/P 14	RSW 15	BW 16	Sp 16	AC 4	CB 0	RACE Human		PPD 8	P/P 9	RSW 10	BW 9	Sp 11
HD 4	CR 13"	WEAPON/DAMAGE/# AT Longsword +2 1d8+2/1d12+2						HD 9	CR 14"	WEAPON/DAMAGE/# AT Longsword +2 1d8+5/1d12+5							
hp 18	MV 12"							hp 40	MV 9"								
THACO 16	AR 31	THACO/AR Modifiers						THACO 8	AR 23	THACO/AR Modifiers							
SPECIAL ABILITIES and LIMITATIONS								SPECIAL ABILITIES and LIMITATIONS									

Heroes and Commanders Roster Sheet

ARMY NAME Red Wing One
PLAYER NAME Dragonlance Scenario

NAME Verminaard					CLASS/LEVEL C 8			NAME Ember					CLASS/LEVEL /				
COMMAND RANK Army		S	I	W	D	Co	Ch	MR%	COMMAND RANK Hero		S	I	W	D	Co	Ch	MR%
14	12	16	10	15	18	0			0								
AC 0	CB +2	RACE Human		PPD 7	P/P 10	RSW 11	BW 13	Sp 12	AC -1	CB /	RACE Red Dragon		PPD 7	P/P 8	RSW 7	BW 8	Sp 8
HD 8	CR 13"	WEAPON/DAMAGE/# AT Mace +3 1d6+4/1d6+3						HD 11	CR /	WEAPON/DAMAGE/# AT 2d8+3d10 or breath							
hp 50	MV 12"							hp 88	MV 9"/24"								
THACO 13	AR 28	THACO/AR Modifiers						THACO 10	AR 25	THACO/AR Modifiers							
SPECIAL ABILITIES and LIMITATIONS Rides Ember Spells by level: 4 - Cause serious wds; cure serious wd. 3 - Ani. dead; cause disease; prayer 2 - Hold person (x2); spir. ham. (x3) 1 - Det. magic; cure light wounds (x4)									SPECIAL ABILITIES and LIMITATIONS Spells by level: 4 - Poly. self; wall of fire 3 - Haste; slow 2 - Web; mirror image 1 - Sleep; det. magic								
NAME Coal					CLASS/LEVEL /			NAME Firewall					CLASS/LEVEL /				
COMMAND RANK Hero		S	I	W	D	Co	Ch	MR%	COMMAND RANK Hero		S	I	W	D	Co	Ch	MR%
0									0								
AC -1	CB /	RACE Red Dragon		PPD 8	P/P 9	RSW 10	BW 9	Sp 11	AC -1	CB /	RACE Red Dragon		PPD 8	P/P 9	RSW 10	BW 9	Sp 11
HD 10	CR /	WEAPON/DAMAGE/# AT 2d8+3d10 or breath						HD 10	CR /	WEAPON/DAMAGE/# AT 2d8+3d10 or breath							
hp 50	MV 9"/24"							hp 50	MV 9"/24"								
THACO 10	AR 25	THACO/AR Modifiers						THACO 10	AR 25	THACO/AR Modifiers							
SPECIAL ABILITIES and LIMITATIONS									SPECIAL ABILITIES and LIMITATIONS								

Heroes and Commanders Roster Sheet

ARMY NAME Red Wing One
PLAYER NAME Dragonlance Scenario

NAME Parrall Deighth					CLASS/LEVEL C 5			NAME Gangek Ooll					CLASS/LEVEL C 7				
COMMAND RANK Unit		S	I	W	D	Co	Ch	MR%	COMMAND RANK Unit		S	I	W	D	Co	Ch	MR%
12		9	15	14	17	16	0	14		8	14	13	12	18	0		
AC 5	CB +1	RACE Human		PPD 9	PIP 12	RSW 13	BW 15	Sp 14	AC 5	CB +2	RACE Human		PPD 7	PIP 10	RSW 11	BW 13	Sp 12
HD 5	CR 11"	WEAPON/DAMAGE/# AT Mace +1 1d6+2/1d6+1						HD 7	CR 13	WEAPON/DAMAGE/# AT Mace +2 1d6+3/1d6+2							
hp 22	MV 18"							hp 33	MV 18"								
THACO 17	AR 32	THACO/AR Modifiers						THACO 14	AR 29	THACO/AR Modifiers							
SPECIAL ABILITIES and LIMITATIONS Spells by level: 3 - Dispel magic 2 - Hold person; sp. hammer (x2) 1 - Det. magic; cure light wound protection from good									SPECIAL ABILITIES and LIMITATIONS Spells by level: 4 - Cure serious wounds 3 - Dispel magic; power 2 - Spir. hammer; hold person (x2) 1 - Cure light wounds (x3)								
NAME Fewmaster Toede					CLASS/LEVEL F 4			NAME Savall Villagebane					CLASS/LEVEL F 14				
COMMAND RANK Unit		S	I	W	D	Co	Ch	MR%	COMMAND RANK Hero		S	I	W	D	Co	Ch	MR%
16		8	11	10	16	6	0	18/ 10		8	7	16	12	5	0		
AC 4	CB +1	RACE hobgob.		PPD 13	PIP 14	RSW 15	BW 16	Sp 16	AC -3	CB /	RACE Human		PPD 5	PIP 6	RSW 7	BW 5	Sp 8
HD 4	CR 8"	WEAPON/DAMAGE/# AT Short sword 1d6/1d8						HD 14	CR /	WEAPON/DAMAGE/# AT 2 handed sword +4 1d10+7/3d6+7 2 att./round							
hp 22	MV 12"							hp 74	MV 9"								
THACO 18	AR 33	THACO/AR Modifiers						THACO 3	AR 18	THACO/AR Modifiers							
SPECIAL ABILITIES and LIMITATIONS									SPECIAL ABILITIES and LIMITATIONS								

Heroes and Commanders Roster Sheet

ARMY NAME Second Quaulinesti
PLAYER NAME Dragonlance Scenario

NAME Porthios									CLASS/LEVEL F/MU 7/7			NAME Laren Laugh									CLASS/LEVEL F/MU 6/5		
COMMAND RANK Army			S 15	I 14	W 11	D 17	Co 9	Ch 16	MR% 0	COMMAND RANK Dep. Army			S 14	I 16	W 9	D 15	Co 12	Ch 15	MR% 0				
AC 2	CB +1	RACE Elf		PPD 10	P/P 11	RSW 9	BW 12	Sp 10	AC 2	CB +1	RACE Elf		PPD 11	P/P 12	RSW 11	BW 13	Sp 12						
HD 7	CR 15"	WEAPON/DAMAGE/# AT Longsword +3 1d8+2/1d12+2							HD 6	CR 14	WEAPON/DAMAGE/# AT Longsword +2 1d8/1d12+2												
hp 27	MV 9"	1d8+3/1d12+3							hp 22	MV 9"	1d8+2/1d12+3												
THACO 10	AR 25	THACO/AR Modifiers							THACO 13	AR 28	THACO/AR Modifiers												
SPECIAL ABILITIES and LIMITATIONS Spells by level: 4 - Wall of fire 3 - Haste; fireball 2 - Mirror image; stink. cloud (x2) 1 - Magic missile; jump; charm person; sleep									SPECIAL ABILITIES and LIMITATIONS Spells by level: 3 - Fireball 2 - Mirror image; invisibility 1 - Sleep (x2) charm person Det. magic														
NAME Stoutlimb									CLASS/LEVEL /			NAME Gnarrack Cleanblade									CLASS/LEVEL F 16		
COMMAND RANK Hero			S	I	W	D	Co	Ch	MR% 0	COMMAND RANK Hero			S 18/ 40	I 9	W 11	D 12	Co 16	Ch 10	MR% 0				
AC 0	CB /	RACE Treant		PPD 7	P/P 8	RSW 9	BW 8	Sp 10	AC -2	CB /	RACE Human		PPD 4	P/P 5	RSW 6	BW 4	Sp 7						
HD 12	CR /	WEAPON/DAMAGE/# AT 4d6							HD 16	CR /	WEAPON/DAMAGE/# AT 2 handed sword +4 1d10+7/3d6+7 2 att. per round												
hp 57	MV 12"								hp 91	MV 9"													
THACO 9	AR 24	THACO/AR Modifiers							THACO 1	AR 16	THACO/AR Modifiers												
SPECIAL ABILITIES and LIMITATIONS Can cause 2 trees to move (3") and attack as treant -4 to saves vs. fire									SPECIAL ABILITIES and LIMITATIONS Potion of speed														

Army Roster Sheet

ARMY
Crossroads Force

PLAYER NAME
Basic Scenario

BRIGADE

UNIT NAME Twin Blades		UNIT TYPE Regular Dwarven Axemen						UNIT NAME Glarus Militia		UNIT TYPE Regular Human Spearmen					
AC 4	#FIG 12	UNIT COMMANDER/DEPUTY Bairn Stonewall - CR 10"						AC 8	#FIG 16	UNIT COMMANDER/DEPUTY John Longthrower - CR 9"					
HD/fig 10	RATIO 10:1	LEVEL/RACE/CLASS 1 Dwarf fighters						HD/fig 10	RATIO 10:1	LEVEL/RACE/CLASS 0 Human fighters					
MV 6"	SIZE M	MR% 0	PPD 11	P/P 12	RSW 13	BW 13	SP 14	MV 12"	SIZE M	MR% 0	PPD 16	P/P 17	RSW 18	BW 20	SP 19
AR 20	AR Modifiers -1 when attacking goblins, orcs, hobgoblins						AR 21	AR Modifiers							
ML 13	ML Modifiers						ML 11	ML Modifiers							
DL 14	Wpn/Dmg Axe 1d6/1d6						DL 12	Wpn/Dmg Spears 1d6/1d6							
SPECIAL ABILITIES AND LIMITATIONS -4 to AC vs. ogres, trolls & giants								SPECIAL ABILITIES AND LIMITATIONS							
UNIT NAME Clanguard		UNIT TYPE Regular Halfling Swordsmen						UNIT NAME Glarian Guard		UNIT TYPE Regular Human Swordsmen					
AC 7	#FIG 10	UNIT COMMANDER/DEPUTY Slendall Lightfoot-CR 10"						AC 5	#FIG 12	UNIT COMMANDER/DEPUTY Radd Wainwright - CR 10"					
HD/fig 10	RATIO 10:1	LEVEL/RACE/CLASS 1 Halfling fighters						HD/fig 20	RATIO 10:1	LEVEL/RACE/CLASS 2 Human fighters					
MV 9"	SIZE 5	MR% 0	PPD 11	P/P 12	RSW 13	BW 13	SP 14	MV 9"	SIZE M	MR% 0	PPD 14	P/P 15	RSW 16	BW 17	SP 17
AR 20	AR Modifiers						AR 20	AR Modifiers							
ML 11	ML Modifiers						ML 12	ML Modifiers							
DL 12	Wpn/Dmg Short sword 1d6/1d8						DL 13	Wpn/Dmg Longsword 1d8/1d12							
SPECIAL ABILITIES AND LIMITATIONS								SPECIAL ABILITIES AND LIMITATIONS							

Heroes and Commanders Roster Sheet

ARMY NAME

Second Qualinesti

PLAYER NAME

Dragonlance Scenario

NAME				CLASS/LEVEL				NAME				CLASS/LEVEL					
Warrell of Que - Shu				F 10				Par - Salian				MU 12					
COMMAND RANK		S	I	W	D	Co	Ch	MR%	COMMAND RANK		S	I	W	D	Co	Ch	MR%
Unit		17	14	13	10	16	18	0	Hero		7	16	12	14	9	9	0
AC	CB	RACE		PPD	P/P	RSW	BW	Sp	AC	CB	RACE		PPD	P/P	RSW	BW	Sp
0	+2	Human		6	7	8	7	9	5	/	Human		11	9	7	11	8
HD	CR	WEAPON/DAMAGE/# AT						HD	CR	WEAPON/DAMAGE/# AT							
10	17"	Longsword +3 1d8+3/1d12+3						12	/								
hp	MV							hp	MV								
57	9"							30	12"								
THACO	AR	THACO/AR Modifiers						THACO	AR	THACO/AR Modifiers							
8	23							17	32								
SPECIAL ABILITIES and LIMITATIONS									SPECIAL ABILITIES and LIMITATIONS								
Ring of protection +2									Spells by level: 6 - Disintegrate 5 - CloudKill (x2); Hold mons. (x2) 4 - Dig (x2); charm mons. (x2) 3 - Fly; fireball (x3) 2 - Invis. (x2); mirror image (x2) 1 - Magic missile (x4)								
NAME				CLASS/LEVEL				NAME				CLASS/LEVEL					
Beryl Oakfriend				F/MU 7/6				Soryl Oakfriend				F/MU 7/6					
COMMAND RANK		S	I	W	D	Co	Ch	MR%	COMMAND RANK		S	I	W	D	Co	Ch	MR%
Hero		12	15	10	17	10	11	0	Hero		16	12	11	14	9	11	0
AC	CB	RACE		PPD	P/P	RSW	BW	Sp	AC	CB	RACE		PPD	P/P	RSW	BW	Sp
1	/	Elf		10	11	9	12	10	1	/	Elf		10	11	9	12	10
HD	CR	WEAPON/DAMAGE/# AT						HD	CR	WEAPON/DAMAGE/# AT							
7	/	Longsword +2 1d8+2/1d12+2						7	/	Longsword +3 1d8+4/1d12+4							
hp	MV							hp	MV								
24	9"							26	9"								
THACO	AR	THACO/AR Modifiers						THACO	AR	THACO/AR Modifiers							
12	27							11	26								
SPECIAL ABILITIES and LIMITATIONS									SPECIAL ABILITIES and LIMITATIONS								
Spells by level: 3 - Haste; fireball 2 - Invisibility; mirror image 1 - Magic missile; sleep charm person; detect magic									Spells by level: 3 - Haste; lightning bolt 2 - Invisibility; mirror image 1 - Sleep (x2); detect magic magic missile								

Army Roster Sheet

ARMY
Second Qualinesti

PLAYER NAME
Dragonlance Scenario

BRIGADE

UNIT NAME		UNIT TYPE						UNIT NAME		UNIT TYPE					
First Qualinost		Regular elven						Second Qualinost		Regular elven					
AC	#FIG	UNIT COMMANDER/DEPUTY						AC	#FIG	UNIT COMMANDER/DEPUTY					
3	12	Gairn Wraithsbane-CR 12"						5	16	Warrel Greens-CR 11"					
HD/fig	RATIO	LEVEL/RACE/CLASS						HD/fig	RATIO	LEVEL/RACE/CLASS					
30	10:1	3/3 elf F/MU						10	10:1	1 elf F/MU					
MV	SIZE	MR%	PPD	P/P	RSW	BW	SP	MV	SIZE	MR%	PPD	P/P	RSW	BW	SP
9"	M	0	13	13	11	15	12	12"	M	0	14	13	11	15	12
AR	AR Modifiers						AR	AR Modifiers							
17							19								
ML	ML Modifiers						ML	ML Modifiers							
15							14								
DL	Wpn/Dmg Range 7/14/21"						DL	Wpn/Dmg Range 7/14/21"							
15	Sword 1d8/1d12 or bow 1d6						14	Sword 1d8/1d12 or bow 1d6							
SPECIAL ABILITIES AND LIMITATIONS								SPECIAL ABILITIES AND LIMITATIONS							
Spells by level: 1 - Magic missile (x2) 2 - Levitate								Spell: Magic missile							
UNIT NAME		UNIT TYPE						UNIT NAME		UNIT TYPE					
Borderguard		Regular elven						Plainsmen legion		Regular Swordsmen					
AC	#FIG	UNIT COMMANDER/DEPUTY						AC	#FIG	UNIT COMMANDER/DEPUTY					
5	12	Daryl Cliffscaler-CR 13"						3	26	Warrell of Que-shu					
HD/fig	RATIO	LEVEL/RACE/CLASS						HD/fig	RATIO	LEVEL/RACE/CLASS					
10	10:1	1 elf F/MU						10	10:1	1 Human fighter					
MV	SIZE	MR%	PPD	P/P	RSW	BW	SP	MV	SIZE	MR%	PPD	P/P	RSW	BW	SP
12"	M	0	14	13	11	15	12	9"	M	0	14	15	16	17	17
AR	AR Modifiers						AR	AR Modifiers							
19							20								
ML	ML Modifiers						ML	ML Modifiers							
14							13								
DL	Wpn/Dmg Range 7/14/21"						DL	Wpn/Dmg							
14	Sword 1d8/1d12 or bow 1d6						14	1d8/1d12							
SPECIAL ABILITIES AND LIMITATIONS								SPECIAL ABILITIES AND LIMITATIONS							
Spell: Magic missile								Large shields; can form shield wall							

Army Roster Sheet

ARMY Borderland Spearhead
BRIGADE

PLAYER NAME Basic Scenario

UNIT NAME Orcs of the Red Blade		UNIT TYPE Regular orcs							UNIT NAME Skullcrushers		UNIT TYPE Regular ogres						
AC 6	#FIG 14	UNIT COMMANDER/DEPUTY Red Orcall - CR 6"							AC 5	#FIG 6	UNIT COMMANDER/DEPUTY Ogrrall - CR 6"						
HD/fig 10	RATIO 10:1	LEVEL/RACE/CLASS Orc							HD/fig 20	RATIO 5:1	LEVEL/RACE/CLASS Ogre						
MV 9"	SIZE M	MR% 0	PPD 14	P/P 15	RSW 16	BW 17	SP 17	MV 9"	SIZE L	MR% 0	PPD 13	P/P 14	RSW 15	BW 16	SP 16		
AR 19	AR Modifiers +1 in daylight							AR 20	AR Modifiers								
ML 11	ML Modifiers							ML 11	ML Modifiers								
DL 10	Wpn/Dmg 1d8							DL 9	Wpn/Dmg 1d10								
SPECIAL ABILITIES AND LIMITATIONS Hate elves								SPECIAL ABILITIES AND LIMITATIONS									
UNIT NAME Twisted claws		UNIT TYPE Regular goblins							UNIT NAME Broken fang		UNIT TYPE Regular goblins						
AC 6	#FIG 12	UNIT COMMANDER/DEPUTY Terrill Rippert - CR 4"							AC 6	#FIG 12	UNIT COMMANDER/DEPUTY Black Fang - CR 4"						
HD/fig 10	RATIO 10:1	LEVEL/RACE/CLASS Goblins							HD/fig 10	RATIO 10:1	LEVEL/RACE/CLASS Goblins						
MV 6"	SIZE S	MR% 0	PPD 14	P/P 15	RSW 16	BW 17	SP 17	MV 6"	SIZE S	MR% 0	PPD 14	P/P 15	RSW 16	BW 17	SP 17		
AR 20	AR Modifiers +1 in daylight							AR 20	AR Modifiers +1 in daylight								
ML 10	ML Modifiers							ML 10	ML Modifiers								
DL 9	Wpn/Dmg 1d6							DL 9	Wpn/Dmg 1d6								
SPECIAL ABILITIES AND LIMITATIONS Hate gnomes & dwarves								SPECIAL ABILITIES AND LIMITATIONS Hate gnomes & dwarves									

Army Roster Sheet

ARMY
Red Wing One

PLAYER NAME
Dragonlance Scenario

BRIGADE

UNIT NAME		UNIT TYPE						UNIT NAME		UNIT TYPE					
23 rd Draconian		Regular						41 st Draconian		Regular					
AC	#FIG	UNIT COMMANDER/DEPUTY						AC	#FIG	UNIT COMMANDER/DEPUTY					
4	12	Parrall Deighth						4	12	Gangek Ooll					
HD/fig	RATIO	LEVEL/RACE/CLASS						HD/fig	RATIO	LEVEL/RACE/CLASS					
20	10:1	Baaz Draconian						30	10:1	Kapak Draconian					
MV	SIZE	MR%	PPD	P/P	RSW	BW	SP	MV	SIZE	MR%	PPD	P/P	RSW	BW	SP
*	M	20%	14	15	16	17	17	*	M	20%	13	14	15	16	16
AR	AR Modifiers						AR	AR Modifiers							
16							16								
ML	ML Modifiers						ML	ML Modifiers							
13							14								
DL	Wpn/Dmg						DL	Wpn/Dmg							
14	2d4						14	1d8+ poison							
SPECIAL ABILITIES AND LIMITATIONS								SPECIAL ABILITIES AND LIMITATIONS							
* MV 6"/ 15" /18"								Poison blades for 3 rounds after 1 round envenoming (no move, no combat) * MV 6"/ 15" /18"							
UNIT NAME		UNIT TYPE						UNIT NAME		UNIT TYPE					
Tearing Ears		Regular						Black Legion		Regular Swordsmen					
AC	#FIG	UNIT COMMANDER/DEPUTY						AC	#FIG	UNIT COMMANDER/DEPUTY					
5	30	Fewmaster Toede						5	24	Xakkan Ruthlyss - CR 12"					
HD/fig	RATIO	LEVEL/RACE/CLASS						HD/fig	RATIO	LEVEL/RACE/CLASS					
10	10:1	Hobgoblin						10	10:1	1 Human fighter					
MV	SIZE	MR%	PPD	P/P	RSW	BW	SP	MV	SIZE	MR%	PPD	P/P	RSW	BW	SP
9"	M	0	14	15	16	17	17	9"	M	0	14	15	16	17	17
AR	AR Modifiers						AR	AR Modifiers							
18							20								
ML	ML Modifiers						ML	ML Modifiers							
12							12								
DL	Wpn/Dmg						DL	Wpn/Dmg							
13	1d3						12	Longsword 1d8/1d12							
SPECIAL ABILITIES AND LIMITATIONS								SPECIAL ABILITIES AND LIMITATIONS							
Hate elves															

Army Roster Sheet

ARMY
Army du'Lairn

PLAYER NAME
Intermediate Scenario

BRIGADE

UNIT NAME		UNIT TYPE							UNIT NAME		UNIT TYPE						
Orcsmashers		Regular Dwarves							Plainsriders		Regular Cavalry						
AC	#FIG	UNIT COMMANDER/DEPUTY							AC	#FIG	UNIT COMMANDER/DEPUTY						
4	26	Throckmorton - CR 13"							7	16	Rander						
HD/fig	RATIO	LEVEL/RACE/CLASS							HD/fig	RATIO	LEVEL/RACE/CLASS						
10	10:1	1 Dwarf fighters							20	10:1	1 Human fighters						
MV	SIZE	MR%	PPD	P/P	RSW	BW	SP	MV	SIZE	MR%	PPD	P/P	RSW	BW	SP		
6"	M	0	11	12	13	13	14	24"	L	0	14	15	16	17	17		
AR	AR Modifiers							AR	AR Modifiers								
20	-1 against goblins, orcs, hobgobs.							20	-2 when changing								
ML	ML Modifiers							ML	ML Modifiers								
13								13									
DL	Wpn/Dmg							DL	Wpn/Dmg								
14	Axe 1d8/1d8							14	1d8/1d12 + 1d4 + 1d4								
SPECIAL ABILITIES AND LIMITATIONS								SPECIAL ABILITIES AND LIMITATIONS									
-4 to AC vs. ogres, trolls, giants																	
UNIT NAME		UNIT TYPE							UNIT NAME		UNIT TYPE						
Archers of Lairn		Regular Archers							Legion of Lairn		Regular Swordsmen						
AC	#FIG	UNIT COMMANDER/DEPUTY							AC	#FIG	UNIT COMMANDER/DEPUTY						
8	20	Eric of Lairn							6	24	Roderick of Lairn						
HD/fig	RATIO	LEVEL/RACE/CLASS							HD/fig	RATIO	LEVEL/RACE/CLASS						
10	10:1	1 Human fighters							10	10:1	1 Human fighters						
MV	SIZE	MR%	PPD	P/P	RSW	BW	SP	MV	SIZE	MR%	PPD	P/P	RSW	BW	SP		
12"	M	0	14	15	16	17	17	9"	M	0	14	15	16	17	17		
AR	AR Modifiers							AR	AR Modifiers								
20	Range 7"/14"/21", 0/-2/-5							20									
ML	ML Modifiers							ML	ML Modifiers								
11								12									
DL	Wpn/Dmg							DL	Wpn/Dmg								
12	Longbow 1d6							13	Longswords 1d8/1d12								
SPECIAL ABILITIES AND LIMITATIONS								SPECIAL ABILITIES AND LIMITATIONS									
2 Shots per Game Round								Have large shields (can form shield wall)									

Army Roster Sheet

ARMY
Landforce

PLAYER NAME
Advanced Scenario

BRIGADE

UNIT NAME		UNIT TYPE							UNIT NAME		UNIT TYPE						
First Elven Foot		Elite archer/ sword							Garrock's Riders		Regular Cavalry						
AC	#FIG	UNIT COMMANDER/DEPUTY							AC	#FIG	UNIT COMMANDER/DEPUTY						
4	18	Kint Leafholder							7	16	Darran Wander - CR 14"						
HD/fig	RATIO	LEVEL/RACE/CLASS							HD/fig	RATIO	LEVEL/RACE/CLASS						
30	10:1	3 Elven F/MU							20	10:1	1 Human fighter/ Light warhorse						
MV	SIZE	MR%	PPD	P/P	RSW	BW	SP	MV	SIZE	MR%	PPD	P/P	RSW	BW	SP		
9"	M	0	13	13	11	15	12	24"	M	0	14	15	16	17	17		
AR	AR Modifiers							AR	AR Modifiers								
17								20									
ML	ML Modifiers							ML	ML Modifiers								
16								13									
DL	Wpn/Dmg							DL	Wpn/Dmg								
15	Longsword 1d8/1d12 or bow 1d6							14	Longsword 1d8/1d12+2d4								
SPECIAL ABILITIES AND LIMITATIONS								SPECIAL ABILITIES AND LIMITATIONS									
Range 7"/14"/21" Spells by level: 2 - Invisibility 1 - Magic missile (x2)																	
UNIT NAME		UNIT TYPE							UNIT NAME		UNIT TYPE						
Second Legion		Regular Sowrdsmen							First Tallfellow		Regular halfling						
AC	#FIG	UNIT COMMANDER/DEPUTY							AC	#FIG	UNIT COMMANDER/DEPUTY						
5	24	Zonnack Kallah - CR 12"							3	20	Garn Tallfellow - CR 13"						
HD/fig	RATIO	LEVEL/RACE/CLASS							HD/fig	RATIO	LEVEL/RACE/CLASS						
10	10:1	1 Human fighter							20	10:1	2 Halfling fighter						
MV	SIZE	MR%	PPD	P/P	RSW	BW	SP	MV	SIZE	MR%	PPD	P/P	RSW	BW	SP		
9"	M	0	14	15	16	17	17	6"	S	0	14	15	16	17	17		
AR	AR Modifiers							AR	AR Modifiers								
20								20									
ML	ML Modifiers							ML	ML Modifiers								
12								13									
DL	Wpn/Dmg							DL	Wpn/Dmg								
13	Longsword 1d8/1d12							14	Sword 1d6/1d8								
SPECIAL ABILITIES AND LIMITATIONS								SPECIAL ABILITIES AND LIMITATIONS									

Army Roster Sheet

ARMY Forward Wing
BRIGADE

PLAYER NAME Intermediate Scenario

UNIT NAME		UNIT TYPE							UNIT NAME		UNIT TYPE						
Red Club		Ogre regulars							Twisted Claw		Regular Goblins						
AC	#FIG	UNIT COMMANDER/DEPUTY							AC	#FIG	UNIT COMMANDER/DEPUTY						
5	12	Snaggart							6	18	Flat Nose - CR 4"						
HD/fig	RATIO	LEVEL/RACE/CLASS							HD/fig	RATIO	LEVEL/RACE/CLASS						
20	5:1	Ogres							10	10:1	Goblins						
MV	SIZE	MR%	PPD	P/P	RSW	BW	SP	MV	SIZE	MR%	PPD	P/P	RSW	BW	SP		
9"	L	0	13	14	15	16	16	6"	S	0	14	15	16	17	17		
AR	AR Modifiers							AR	AR Modifiers								
15								20	Range +1 in daylight 5"/10"/15",0/-2/-5								
ML	ML Modifiers							ML	ML Modifiers								
13								10									
DL	Wpn/Dmg							DL	Wpn/Dmg								
11	1d10							9	Shortbows 1d6								
SPECIAL ABILITIES AND LIMITATIONS								SPECIAL ABILITIES AND LIMITATIONS									
								Hate gnomes & dwarves									
UNIT NAME		UNIT TYPE							UNIT NAME		UNIT TYPE						
Vile Rune		Orc regulars							Worgriders		Regular Goblin Cavalry						
AC	#FIG	UNIT COMMANDER/DEPUTY							AC	#FIG	UNIT COMMANDER/DEPUTY						
6	30	Red Snout - CR 6"							6	14	Black Fang - CR 12"						
HD/fig	RATIO	LEVEL/RACE/CLASS							HD/fig	RATIO	LEVEL/RACE/CLASS						
10	10:1	Orc							30	10:1	Goblins & worg wolves						
MV	SIZE	MR%	PPD	P/P	RSW	BW	SP	MV	SIZE	MR%	PPD	P/P	RSW	BW	SP		
9"	M	0	14	15	16	17	17	18"	M	0	14	15	16	17	17		
AR	AR Modifiers							AR	AR Modifiers								
19	+1 in daylight							20									
ML	ML Modifiers							ML	ML Modifiers								
11								13									
DL	Wpn/Dmg							DL	Wpn/Dmg								
10	1d8							11	1d6 + 1d4 + 1d4								
SPECIAL ABILITIES AND LIMITATIONS								SPECIAL ABILITIES AND LIMITATIONS									
Hate elves								Hate gnomes & dwarves									

Army Roster Sheet

ARMY
Main Body

PLAYER NAME
Advanced Scenario

BRIGADE

UNIT NAME Paw - Riders		UNIT TYPE Regular Orc Cavalry						UNIT NAME Gaping Maw		UNIT TYPE Regular trolls					
AC 6	#FIG 16	UNIT COMMANDER/DEPUTY Black Leg - CR 8"						AC 4	#FIG 12	UNIT COMMANDER/DEPUTY Gorath - CR 8"					
HD/fig 40	RATIO 10:1	LEVEL/RACE/CLASS Orc & Giant boar						HD/fig 35	RATIO 5:1	LEVEL/RACE/CLASS Trolls					
MV 12"	SIZE M	MR% 0	PPD 14	P/P 15	RSW 16	BW 17	SP 17	MV 12"	SIZE L	MR% 0	PPD 10	P/P 11	RSW 12	BW 12	SP 13
AR 19	AR Modifiers +1 in daylight						AR 13	AR Modifiers							
ML 14	ML Modifiers						ML 15	ML Modifiers							
DL 13	Wpn/Dmg 1d8 + 3d6						DL 14	Wpn/Dmg 2d4+8 + 2d6							
SPECIAL ABILITIES AND LIMITATIONS								SPECIAL ABILITIES AND LIMITATIONS Regeneration							
UNIT NAME Flaming Arrow		UNIT TYPE Regular Orc Archers						UNIT NAME Long - Poles		UNIT TYPE Regular Orc Pike					
AC 6	#FIG 24	UNIT COMMANDER/DEPUTY Keen - Eye - CR 6"						AC 6	#FIG 24	UNIT COMMANDER/DEPUTY Croosh - CR 6"					
HD/fig 10	RATIO 10:1	LEVEL/RACE/CLASS Orc						HD/fig 10	RATIO 10:1	LEVEL/RACE/CLASS Orc					
MV 9"	SIZE M	MR% 0	PPD 14	P/P 15	RSW 16	BW 17	SP 17	MV 9"	SIZE M	MR% 0	PPD 14	P/P 15	RSW 16	BW 17	SP 17
AR 19	AR Modifiers +1 in daylight						AR 19	AR Modifiers +1 in daylight							
ML 11	ML Modifiers						ML 11	ML Modifiers							
DL 10	Wpn/Dmg Shortbows 1d6						DL 10	Wpn/Dmg Pikes 1d6/1d12							
SPECIAL ABILITIES AND LIMITATIONS Range 5/10/15"								SPECIAL ABILITIES AND LIMITATIONS							

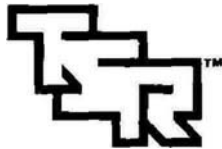

TSR, Inc.
PRODUCTS OF YOUR IMAGINATION™

ADVANCED DUNGEONS & DRAGONS, AD&D, DUNGEONS & DRAGONS, and D&D are registered trademarks owned by TSR Inc. BATTLESYSTEM, DRAGONLANCE, ADVENTURE FOLD-UP, PRODUCTS OF YOUR IMAGINATION, and the TSR logo are trademarks of TSR, Inc. » 1985 TSR, Inc. All Rights Reserved. Printed in U.S.A.

1019XXX2001

This booklet is protected under the copyright laws of the United States of America. Any reproduction or unauthorized use is prohibited without the express written of TSR, Inc.

Printed in U.S.A.

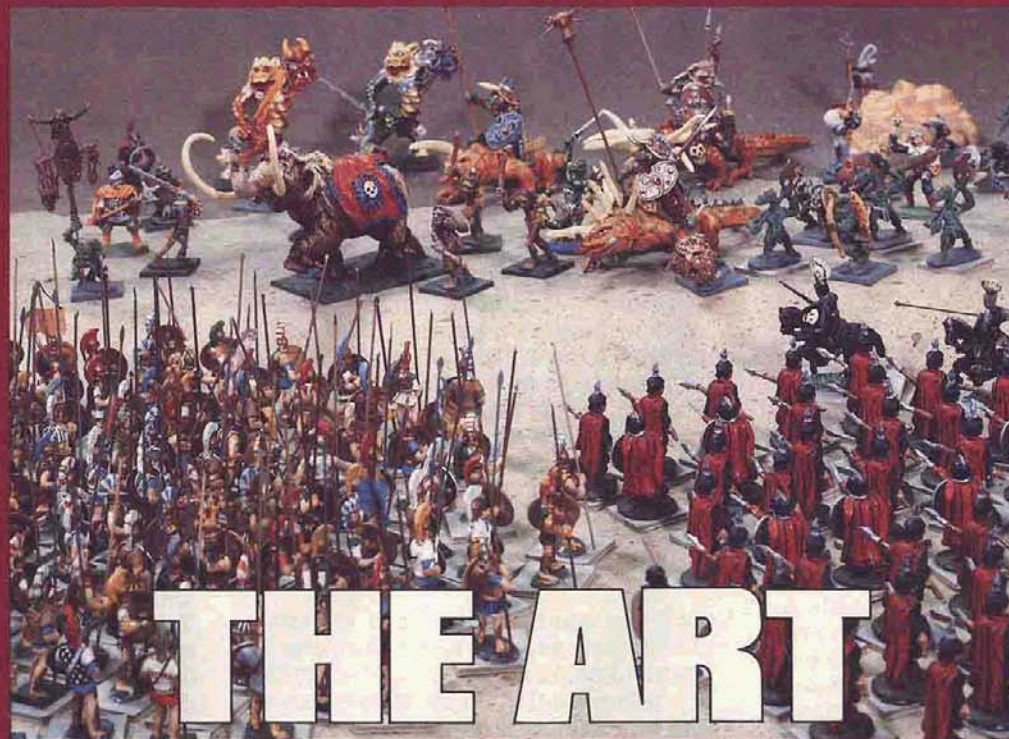

THE ART OF THREE-DIMENSIONAL GAMING

An Introduction to Tabletop Miniatures by Steve Winter

GETTING STARTED

Painting an army of miniature figures can be tedious, time-consuming, and frustrating, or it can be fun, relaxing, and rewarding, depending on how you approach the task. An organized work area, the proper tools, and plenty of patience are the vital ingredients. The more care you put into the job, the better your results will be.

The place to get started is in your tool box. Having the right tools when you need them will save time and cut down on botched paint jobs.

Brushes

Obviously, you'll need paint brushes. Two or three brushes are enough to start with, but you'll need a variety of sizes. Try a size 1 flat brush and a size 2 round brush for painting large areas, and a size 0, 00, or even 000 round for painting details.

Don't even think about synthetic fiber brushes. Red sable artist's brushes are more expensive, but their performance more than makes up for the cost difference. Buy the best brushes you can afford, and take good care of them. That includes plucking out any hairs that are sticking out at funny angles, trimming the end so that it's even, and eventually retiring a brush when it's worn out.

Clean your brushes thoroughly whenever you switch colors or paints, and clean them with soap and water before you put them away. Reform the tip with your fingers while the bristles are still damp so that they will be straight the

next time you use the brush. And always pull the brush downward when painting, so the paint flows from the root to the tip. Any other motion—swirling, splaying the hairs—pushes paint into the roots of the bristles, where it is notoriously hard to get out and eventually will ruin the brush for anything except dry-brushing or dusting.

Paints

Whether you use acrylic (water-based) paint or enamel (oil-based) paint is largely a matter of taste. Most miniaturists wind up using both in order to get the colors they want. Acrylics are easy to use because they can be thinned and cleaned up with water. They tend to give bright, flat colors. Enamels give a hard, smooth finish, but you'll need paint thinner both for thinning and cleaning up.

There's nothing wrong with using enamels and acrylics on the same figure, as long as you let one coat dry completely before starting the next one. But never, never try to mix acrylics and enamels together to get a third color; it won't work, and you'll be sorry you tried.

You'll want a wide variety of colors. A good flesh tone is essential, as are numerous browns and greens. Bold, bright colors look best on gaming miniatures. While it isn't always practical, it's nice to have three shades of each color: the color itself, and that color in lighter and darker shades. This makes shading and highlighting a lot easier, since you don't have to mix lighter or darker shades of each color.

Model paints aren't cheap, so it's worth making an effort to take care of them. The first time you open a new bottle or tin of paint, drop in a few ball bearings,

screws, or washers. These help mix the paint when you shake it. Always shake the paint vigorously before opening the bottle, and stir it a few times with a toothpick or the handle of your brush after opening to make sure it's well mixed. If you paint straight from the bottle, shake the paint again before you put it away. This prevents the partially dried-out paint at the top of the bottle from drying out completely in storage.

Instead of painting straight from the bottle, though, it's best to put a little paint in an old bottle cap or on a palette. Then you can recap the paint bottle immediately and not worry about it drying out or tipping over. Paints are easier to thin and mix when you're working with a small amount, too.

Other Tools

Besides brushes and paints, you'll need all or some of the following: metal file; utility knife; rags for cleaning brushes; clean water or thinner (for thinning paints); more water or thinner (for cleaning brushes); bottle caps, very small jar lids, or a paint palette; pliers (for opening gunked-up paint bottles); glue; and toothpicks. Toothpicks are useful both for stirring paint and for touching up small mistakes.

THE ART OF PAINTING

People who paint individual player character figures can afford to spend hours laboring over tiny details and intricate brush strokes. The fact that you're reading this implies that you want to paint entire armies of inch-high elves, dwarves, and goblins. The basic techniques are the same for both tasks, but army painters need to take a few shortcuts if they intend to ever actually array their host on a gaming table. Both techniques—painting for speed and painting for detail—are explained in this section. But first, some practical background.

While the BATTLESYSTEM™ game is set in fantasy worlds, fantasy is more appealing when it is extrapolated from reality. Let your imagination run wild when painting your fantasy miniatures, but at the same time, keep your eyes open for real-life counterparts. A giant lizard, for example, is a fantasy concoction, but small lizards do exist. Your giant lizard will look more believable if you base your paint job on its real-life cousin. You don't need to lift your colors straight from a blue-tongued skink, but you can examine how the skink's scales are patterned and colored. For this purpose, a good painting of a lizard is more helpful than a photograph. A photo shows you what the lizard looks like, but a painting shows you how another painter captured that look.

The smaller a figure is, the darker it looks. To compensate, it must be painted with light, bright colors. A flesh tone that looks way too light painted on the back of your hand will be just right on a 25mm

figure. This is true for all colors except black, white, and most metallics.

Also, small figures look shinier than they really are. Something that's glossy in reality looks wrong on a 25mm figure unless it's painted in flat colors. Polished leather, silk, and metal are the three exceptions. Everything else should be flat.

Fourth, even a highly detailed 25mm miniature just doesn't have much three-dimensional relief. If you just paint on the colors, the figure will look like a 25mm statue. To make it look real, you must give it shadows; you must create shadows with paint and brush where none exist. This is a lot easier than it sounds, and in many ways it speeds up painting.

The nine steps that follow describe a system for painting armies of miniatures. Most of these steps apply equally when painting detailed leader and player-character figures. Following these nine steps are a few more advanced techniques for detailed figures.

STEP 1: CLEANING. The first step in painting your miniatures is cleaning them thoroughly. Start by trimming any flash (excess lead that isn't supposed to be there) away from the figure with a sharp knife and a small file. Try to smooth out any rough edges that show where the mold was fitted together. Trim or file the bottom of the figure so it stands up straight without rocking.

Next, wash the miniatures in warm, soapy water, and rinse them off in warm, clean water. Set them out on a towel or newspaper and let them dry overnight. (This wash is to remove any dirt, grease, or oil from the figure, so don't handle the figures any more than you have to while they're drying.)

STEP 2: MOUNTING. When the figures are completely dry, mount them on individual bases. In the BATTLESYSTEM game, there are three standard, square base sizes: 1/2 inch for small troops, 3/4 inch for man-sized troops, and 1 inch for large troops. Some especially big figures—dragons and dinosaurs, for example—use bases cut to the size of the figure, or no base at all.

The counters that come in this game box can be used as bases, if you like. You can also make your own—especially if you plan to field a very large army.

The best material to make bases from is matte board or posterboard. Matte board is easy to cut and is available from most art supply stores. Use a pencil and ruler to measure off as many bases as you need. Put the sheet of matte board on a worktable or some other solid surface that won't be damaged by scratches and cuts. Use a sharp hobby knife and a metal straightedge to cut out the bases. You probably will need to make several strokes to cut all the way through the matte board. Be sure to keep the knife along the edge of the metal guide so you get a straight cut.

Bases also can be made from balsa wood, masonite, floor tile, or any other flat, sturdy material. Most of these have

drawbacks of some kind, though, so unless you're experienced at working with them, matte board is best.

Epoxy, instant super-strength glues, or even white carpentry glue can be used to mount metal miniatures on their bases. Be sure to follow all of the instructions that come with the glue, and use it in an area with good ventilation.

Bendable plastic miniatures (which aren't very common, anyway) are more difficult to mount. Silicone adhesive or rubber cement works best. If you use anything else, you may simply have to resign yourself to having the figures break loose occasionally.

Some people prefer to mount five to ten figures on long strips of wood or cardboard (with a very small amount of glue!) so that they can be handled more easily while painting. When the painting is done, the figures are taken off the group base and mounted on their permanent bases. Use whichever method seems best suited to your painting system.

STEP 3: PRIMING. Once the figures are mounted, they should be primed. All figures should be primed, unless you intend to use the bare, polished metal as a finish (this works well for knights in plate mail). Priming prevents tarnishing, helps the paint stick to the figure, and makes colors look brighter. A flat white or gray spray primer is best. Let the primer dry overnight before doing any more painting.

STEP 4: OUTLINING. Outlining involves painting black those areas that would be in shadow if the figure were life-size. Dilute flat black paint 2:1 or 3:1



with thinner or water (so it will flow into cracks and low spots) and then paint it into areas that should be dark: folds in robes, between the arms and the torso, around scabbards, in recesses of helmets and armor (especially chain

mail), above and below belts. At this stage, it's better to put on too much than too little. When you're finished, the figure's features should be clearly defined.

STEP 5: COLORING. This step is easy. Simply paint in the areas that have been outlined in black with whatever color you want. Take care to paint right



up to the black outlining, but don't paint completely over it. It's best to start with the flesh tones and work outward; paint the layer of clothing closest to the skin, then the next layer, and so on, finishing with backpacks, weapons, and

equipment hanging from belts. Paint the figure's base last. You can save time by painting figures in groups. If, for

example, you have 20 goblins with pikes, paint the flesh on all 20 at once. Then paint all of their brown armor, then their steel helmets, etc.

STEP 6: HIGHLIGHTING.

Highlighting is optional. It makes your miniatures more visually exciting, but it takes some practice. The goal is to lighten those areas that stand out in bright light. Make a pale mix of the color being highlighted and brush it onto the strong spots: outer folds of cloth, shoulders, foreheads. Getting just the right amount of highlighting is tricky. To work, it must be bold, but too much looks artificial. You can get a softer effect by brushing on the paint, then wiping off the excess with a cloth.



STEP 7: DRYBRUSHING. Like highlighting, not all figures will benefit from drybrushing. It works best when trying to accentuate fur, chain mail, scales, and other raised surface details.



To drybrush details, get a little paint on your brush, then wipe off most of it on a rag or a sheet of newspaper. With the small amount of paint left, brush lightly across the figure, leaving just

enough paint to bring out fine details. Use an old brush for this, because drybrushing will ruin a new one.

STEP 8: TEXTURING. An extra touch that will make your miniatures look more attractive and natural is sand or model railroad grass glued onto the base. Just spread a thin layer of white glue on the base with a modelling knife, then dip the base into the sand or sprinkle sand over it. Let the glue dry for a while, then use an old paint brush to brush away the loose sand. Paint the base so it matches



the color of your gaming table. Field green is the most common and versatile color, but other earth tones can work just as well. Drybrushing yellow over a field green, textured base produces very attractive artificial grass.

STEP 9: PROTECTING. After your figures are painted and mounted, it's a good idea to protect them from nicks and gouges with clear acrylic spray. Just the normal wear from handling miniatures during a game can rub the paint off of high spots and leave greasy finger marks. A clear, matte acrylic works best, and can be found in most paint stores or art supply stores. If a matte finish isn't available, use a glossy acrylic spray and coat it with a thin matte finish. These protective sprays may darken the figure a bit, but this is a small price to pay for protecting your miniature masterpieces from minor damage.

DETAILED PAINTING TECHNIQUES

This nine-step process yields colorful, somewhat blocky-looking figures. This is just what you want in an army, where the individual figures aren't subjected to close scrutiny. But if you're painting figures to use as player characters in an AD&D® game, you will want a softer, more natural-looking figure. To achieve this look, steps 4 and 5 must change a bit.

STEP 4: SHADING. Outlining should be much more subdued, or skipped entirely. Instead, a shadow effect is achieved by washing the figure with darker shades of the surrounding color. First, choose the color you want an area to be. Dilute that color so the paint flows easily. It should cover the high spots, but also flow into the low, shadowed spots. Next, make a thinner mix of a darker shade and paint it into the shadowed areas. It should flow easily into folds and corners, increasing the contrast between high and low spots. These two coats—the primary color and its darker shade—should create enough contrast, but more shading can be added if you want the extra detail.

Assume, for example, that you are painting an illusionist wearing a green robe. Start by painting with a slightly thinned green. When that coat is dry, make a very thin mix of dark green and paint it into the folds of the robe, around the belt, collar, and hood, and into the cuffs. The dark green collects in these low spots, creating a gradual shadow effect.

STEP 5: DETAILING. After painting the major areas, fill in belts, metallic colors, and trim. You don't want this paint to run, so use a fairly thick mix.

Even on highly detailed miniatures, eyes should be underplayed. That usually means you can forget about them entirely. You really can't see much detail about a person's eyes from more than a few feet away. If you decide your figure must have eyes, try painting on just eyebrows. If that isn't good enough, try

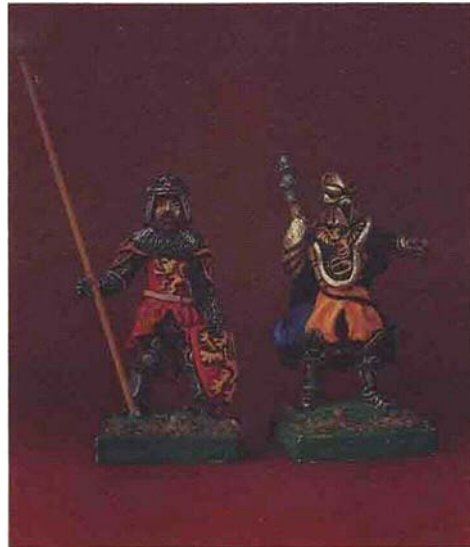

either of these methods: Add an iris of very light gray (not white) and put in a pupil by making a very small pinhole in the iris. If even that isn't good enough, paint the eyebrow and entire eye black or brown. Bring out the pupil by putting a spot of light gray on both sides.

STORING YOUR MINIATURES

Once you've painted, mounted, and sealed your miniatures, you'll need to keep them somewhere. This can be quite a problem, since it isn't a good idea to just toss them in a sack and slide it under the bed. You've put a lot of work into creating your miniature army, and it must be stored properly to protect it from damage and deterioration.

Your storage system needs to accomplish three things: it must keep miniatures dry and dust-free; it must protect your miniatures from getting nicked and bent; and it must be portable, so you can take your miniatures to a friend's house or a game convention. You should store your miniatures standing up instead of laying over.

Plastic, compartmentalized trays are sold in hundreds of varieties. Check at the local hardware store. You should find several types of workshop storage bins designed for screws, nails, and other small items that get lost easily. Some of these are clear plastic trays that are divided into a dozen or so compartments and have a hinged lid. Others are stackable units that have 10 to 30 small plastic drawers. These hold lots of miniatures, are sturdy, and are easy to carry around. If you buy trays like these, make sure the compartments or drawers are big enough to hold your miniatures. Spearmen, bowmen, and mounted knights are very tall, and won't fit standing up in many plastic trays.

Like hardware trays, fishing tackle boxes are sold in hundreds of sizes and

shapes, many with compartmentalized trays and drawers. Tackle boxes are big, sturdy, and can hold miniatures of many different sizes. A tackle box with a tray of small compartments, a second tray with larger compartments, and a big storage area at the bottom is especially useful. You can store an entire (small) army in a tackle box like that. Good tackle boxes are expensive, but worth the money if you can afford them.

The cheapest alternative is to store your miniatures in low cardboard boxes with lids. A stationery box is ideal, and large candy boxes work well, also. The box should be sturdy enough that it doesn't flex a lot; otherwise, it will flex when you pick it up and your miniatures will fall over and slide around inside. The box must have a lid or it will collect dust, cat toys, and other little pieces of garbage.

One of the very best (and cheapest!) storage boxes is one you make yourself from cardboard. The drawback, of course, is that making storage trays takes some time and practice. Cardboard boxes are available free (or very cheap) from stores of any kind. Try to get several boxes that are the same size, and several more that you can cut up for extra cardboard. If you can find three or four boxes of the same size that will fit snugly inside another box, so much the better.

There are lots of ways to modify cardboard boxes to store miniatures. The best is to cut down the sides of the box and form a new lid, then use the removed flaps to make compartments (see the diagram). Use a ruler to measure off the new height of the sides, and a straightedge as a guide when cutting. When forming the new top flaps, you'll have to score the sides where you want the flaps to fold. Also, when notching cardboard strips to form the compartments, make the cut as wide as the cardboard is thick. Otherwise the cardboard strips will twist, bend, or rip when you assemble them.

One last note on storing your miniatures. Keep them someplace where your dog, cat, and baby brother or sister can't get at them. Not only will this keep them from getting bent, thrown around, and lost, but it keeps them out of your sibling's and your pet's mouths. Miniatures are made of lead, and lead can be poisonous if swallowed, chewed, or even handled a lot. So wash your hands after handling unpainted lead miniatures, and store them on a shelf in the closet or in a closed cabinet and save everyone a lot of grief.

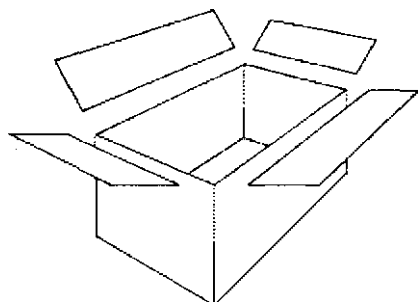

STEP 1: Remove flaps, measure new box side height and top flap length.

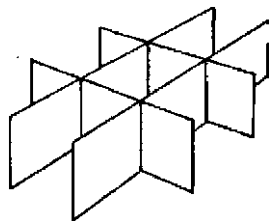

STEP 3: Make compartment walls from removed cardboard.

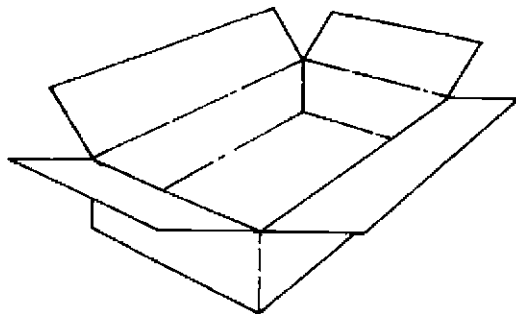

STEP 2: Cut out corners between top flaps, score sides where top flaps fold.

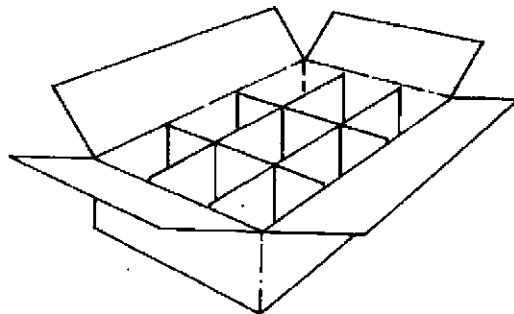

STEP 4: Assemble, and put in your miniatures!

MAKING TERRAIN

Miniature figures are only a part of a miniatures wargame setup. Once the armies are assembled, they need someplace to fight. You can conduct your battles on a flat, featureless table if you want (it might be fun, if the battle was set in another dimension), but you really need some interesting terrain to spice up the battlefield. Terrain can be the deciding factor in a battle. A key hilltop becomes an impregnable fortress, a forest anchors your flank or screens you from enemy archers, and a river splits your enemy so you can crush him in detail. Even minor terrain features can be important: a shallow depression hides troops from the enemy, a farm fence provides a rallying point for routed units, a small pond allows a magic-user to summon a water elemental.

At first, especially if you're using counters instead of miniatures, you may want to make simple, flat terrain features out of construction paper and cardboard. Make hills with brown construction paper, using progressively darker shades of brown to show higher contours. Rivers can be made with blue construction paper or tinfoil. Dark green paper makes dense woods, while light green can be used for open woods, orchards, or scrub brush. Masking tape or gray construction paper can be used for roads. Once you get the hang of it, you can make any terrain feature with the appropriate color or combination of colors.

An even easier method is to simply draw the terrain features onto your game table with chalk, or onto large sheets of paper with felt pens or crayons. Or you can use masking tape to mark out all

terrain features. Both methods are fast and cheap, but don't look nearly as nice as terrain made from construction paper.

Of course, part of the attraction of a miniatures game is its visual splendor. Once you build up an army of miniatures, you'll want to start using three-dimensional terrain on your battle table. Three-dimensional terrain is easy to build and, depending on the materials you use, can be very inexpensive.

A few materials are very useful for making several different types of terrain. These are: styrofoam or foam rubber sheets, available (as insulation) from hardware or building supply stores; shag carpet remnants in various greens and other earth tones; dried lichen, available from model railroad hobby stores; clean kitty litter or aquarium gravel; various-colored sheets of construction paper, but particularly brown, green, blue, and gray.

HILLS. Hills can be handled several ways. The way you choose is largely a matter of taste.

The first is to cut out irregular shapes of styrofoam or foam rubber and paint them mottled green and brown. One piece makes a low hill. One large piece with a smaller piece stacked on top is a higher hill. Each piece of foam represents a different elevation (like the area between two contour lines on a topographical map). If each layer of foam represents 10 yards of elevation, then figures on the table are at ground level, figures on the bottom piece of foam are 10 yards above ground level, and figures on the second piece of foam are 20 yards above ground level. The change in elevation from one level to the next can vary from battle to battle, but it should be consistent within

each battle.

An alternate method is to pile up books, carpet remnants, magazines, newspapers, etc., on the game table wherever you want hills, and then lay an old blanket, tablecloth, or section of indoor/outdoor carpeting over the whole table. This looks more natural, assuming your table cover resembles grass more than it resembles a checkerboard. Fasten the blanket or cloth to the table with staples or tape, or an accidental bump and scrape could wipe out the setup. Be sure to get permission before using one of your mother's good tablecloths.

RIVERS. Even in a three-dimensional game, rivers are best done in two dimensions. Blue construction paper, blue felt, or tinfoil (slightly crinkled, with the shiny side up) make excellent rivers. If you really want a 3-D river, mold it in sections out of papier-mache or clay. Paint the banks mottled brown and green and the streambed blue, then cover the streambed with a generous layer of white glue. The glue becomes transparent when it dries, giving the river some depth.

TREES. You really have some options here. Model railroad stores usually carry a wide variety of plastic trees in several scales. Hobby stores also carry dried lichen, which can be used straight out of the package, or glued onto small sticks so it looks more like a tree with a trunk. Dried moss, available from most florists and greenhouses, can be used the same way, but it's messier. Even a small clump of steel wool, glued onto a 'tree trunk' and painted green, makes a fine tree.

For a less expensive forest, try making trees from light cardboard. You can make individual tree stands by notching

two cardboard triangles so they fit together and stand up, or by making a stand-up trunk and a flat leaf canopy that snaps onto the top. The 3-D trees that came with this game are examples of the second type.

In any case, keep in mind that you don't need a model tree to represent every tree in the forest. One model tree represents a lot of trees, and a group of model trees marks a large, wooded area. You can mark the edge of the forest by making a thin trail of fresh kitty litter around the trees. Leave enough room between your model trees to move miniatures through the forest. And feel free to move trees around in the woods to make room for the figures.

GULLIES. Gullies can be best represented with construction paper or kitty litter.

ICE. Smooth tinfoil (with the dull side up) or light blue construction paper make convincing sheets of ice, either for glaciers or mere frozen lakes and rivers.

BRUSH. Irregularly-shaped sections of earth-tone shag carpet make excellent patches of scrub brush. Carpet remnants can be picked up at very reasonable prices from most carpet stores. Lichen and dried moss also make fine brush.

SNOW. Plain white paper is the easiest and best material to use if you want a few snowfields dotting the battlefield. Purists will insist on using soap flakes; while their visual effect is stunning, it is more than offset by the problem of cleaning up afterward. Stick to white paper.

BOULDERS. Boulders are easy. Just

take a short walk down the street and pick up a few handfuls of loose gravel and small stones. Wash them off at home and, voila, authentic miniature boulders!

SWAMP. A fetid swamp or two never fails to liven up a fantasy battle. Whether it's inhabited by shambling mounds, giant leeches, or will-o-wisps, it looks best if you represent it with small, scattered patches of dirty blue-green carpet outlined with kitty litter. Wet carpet looks even worse, but be sure you dry it out again before putting it away.

IMPROVISATIONS. Bearing in mind that this is a fantasy game, don't restrict yourself to things that you've seen. If you don't toss in a few fantastic terrain features occasionally, people will forget they're playing an AD&D® game adventure. Some examples: champagne corks from last year's New Year's Eve party make dandy giant mushrooms; plastic flowers look like exotic jungle or magical growths on a game table. Quicksand, craters, caves, and lava are a few other features that lend variety to games. Let your imagination have some fun, too!

CASTLES, COTTAGES, AND CAUSEWAYS

Just as important as the natural terrain of the battlefield are the man-made (or orc-made) structures on it: houses, farms, fences, bridges, roads, and castles. Most armies try to find battlefields that are clear of large structures, since villages and such just get in the way of a good cavalry charge. But sometimes, as in a chance meeting between two forces, armies must take whatever ground they get. Sometimes the

village, road, or bridge may be what the fight is all about.

Several manufacturers market medieval bridges and buildings in both 15mm and 25mm scales. These aren't too expensive (compared to your army of miniatures) and they look very nice on the game table. Look in the miniatures section of your local hobby shop.

TSR Inc. also has available 3-D Adventure Fold-up™ figures of bridges, stone walls, and village buildings. These are less expensive than molded buildings, are printed in full color, and give you the added bonus of being fun to put together. D&D® game adventure module B6, "The Veiled Society," includes seven paper sculpture houses and a city gate that are perfect for setting up a small village.

If you'd rather make your own structures from scratch, here are some basic guidelines to follow.

BUILDINGS. Make buildings out of thin cardboard or matte board, balsa wood, foam-core sheets, or toy building blocks. The first four items can be found at any art supply store. If you (or your little brother or sister) don't have some building blocks, check at the local toy store.

Buildings made from cardboard don't need to be elaborate. Four walls and a roof are all that's really necessary. Take your time when coloring them and even these simple constructions will look nice in the game. You can color them with markers, pencils, or the paints you use on your miniatures. Use bright colors and outline important features in black.

Primitive huts are even easier to make. Peat pots are small, rough, cardboard cups used for starting plants. You can buy them at greenhouses or in dime stores.

Turn a peat pot upside down and cut out a doorway and you have a fine hut. Very small paper cups printed with a rough pattern or painted brown will suffice, but they don't look as authentic as peat pots.

If you want thatched buildings, cover the roofs and/or walls with burlap. A spray adhesive is best for sticking the burlap onto the building, although most glues will work. Spray adhesive is sold in art supply stores, and is useful for gluing together any sort of paper or cloth sheets.

Like model trees, you don't need a model house for each building in a village. In the BATTLESYSTEM game scale, each model house represents a cluster of buildings—a farm house and several outbuildings and sheds, for example. Five or six buildings represent an entire small village.

WALLS. Along with buildings, TSR Inc. sells heavy paper fold-up rock walls. You can scratch-build very authentic-looking rock walls by gluing together dry beans, or by sticking together small lumps of modeling clay. Long, square strips of wood can be painted with rock patterns. Many companies also manufacture miniature stone walls specifically for use with military miniatures. Whatever you decide to use, look for (or build) walls that are wide enough for a miniature to stand on. This makes it easy to indicate which troops are crossing the wall.

ROADS. Gray or brown construction paper, masking tape, or a trail of kitty litter or aquarium gravel all make excellent roads. Remember that road building was pretty much a neglected science in the Middle Ages. Unless your fantasy campaign takes place in a very advanced culture or among the remnants

of a fallen civilization most roads will be nothing but rutted dirt tracks in the dry season, and impassable mires in the rainy season.

BRIDGES. Again, you can buy prefabricated bridges from TSR Inc. or hobby stores, or you can make your own. A long, thin candy box or pencil box with the ends cut off is a good place to start.

CASTLES. An entire chapter could be written on castle building alone. Castles come in such a variety of sizes and shapes, particularly in a fantasy world, that nothing more than general guidelines are practical here.

When building a castle, keep in mind that its purpose is defense. Also keep in mind that defending a castle from umber hulks, wyvern riders, and magic-users requires a different type of architecture than prevailed in medieval Europe. The exact construction will vary by the amount of magic in your game. You'll have to experiment a bit to find out what works.

The best way to start a castle is with a tower. A half-gallon milk carton or a thick mailing tube, appropriately painted and adorned with gates, arrow slits, and crenellations, becomes a tower stronghold in less than an hour. Add a few shoeboxes and paper towel tubes connected by cardboard walls and the tower is a castle. Unless you intend to run a full-scale siege, keep the castle small and simple.

Also remember that, because castles are bastions of safety and civilization, they attract people. Most castles, unless inhabited by evil wizards who prefer to be alone, should have a village nearby. The village may be inhabited or deserted,

depending on how much warning the villagers had of the attack.

For people who want to spend the money, many toy stores sell building blocks designed specifically for building castles. These are very attractive, can be used to make almost an infinite variety of castles, and are lots of fun to play with between battles. Their big drawback is cost; expect to pay \$40 to \$80 for a medium to large set.

WHERE DO I PLAY?

Unlike the AD&D® and D&D® role-playing games, which can be played almost anywhere, a miniatures game takes quite a bit of space. You'll need to find a table that's big enough for the battle and that won't be needed for something else (like dinner) before the game is over.

Your gaming table must be big enough to allow two or three turns of maneuver for both sides before the real fighting begins. It's tempting to cram as many miniatures as possible into two lines of battle that stretch from one end of the table to the other. This set-up looks impressive, but it leads to boring battles; the players can't make any important decisions. Their only option is to charge straight across the table and hope the enemy units ahead are small and weak. Allow some room to march and maneuver, so players can try to outflank the enemy or fall back before a heavy assault.

If you're playing on a really big table, check beforehand to be sure that you can reach every spot on the table from somewhere along the edge. If you can't reach the middle of the table, it's too big.

For small battles, a kitchen table (with

several leaves in place) should be big enough. A ping-pong table is excellent for bigger battles. A pool table also works nicely, but be careful not to damage the felt surface. A cheap alternative is to set a large plywood sheet across two or three sawhorses. If nothing else is available you can play on the floor, but be careful not to step on any miniatures (and sweep the floor before the game)!

The ultimate game table is a sand table. A sand table is basically a sand box on legs. The sand can be molded into hills, ravines, rivers, gullies, and roads. Dampening the sand helps hold its shape during the game. The molded terrain can be spray-painted green to give it a more natural appearance.

Building a sand table is a fairly large undertaking (not like building a garage, but more than a dog house). Once it's built, a sand table can't be taken down and stored the way a ping-pong table can, so put it up someplace where you can leave it for a long time. For these two reasons, a sand table makes a good wargame club project. The cost and effort of building the table can be spread among the club members, and the table can be kept at the club's regular meeting place.

Information on building sand tables at your local hobby store or library. Whatever design you use, make sure your table is sturdy and steady; the sand needs to be only a few inches deep but even a few inches of sand, spread over a 6 by 8 foot table, can weigh hundreds of pounds, especially when dampened. Line the sand box with a heavy plastic sheet or seal it tightly with calking compound so the sand doesn't leak out.

WRAPPING UP

Miniature figures actually represent two hobbies in one: first, collecting, painting, and displaying them, and second, playing wargames with toy soldiers. Don't let the first overshadow the second, or vice versa. Leaning too far in one direction takes away the fun, and leaning too far in the other direction takes away the challenge.

HOW TO ASSEMBLE THE BATTLESYSTEM™ 3-D ADVENTURE FOLD-UP™ FIGURES

The 3-D Adventure Fold-up™ figures included with this game are fairly easy to build, if you take your time and check each step carefully before proceeding with the next.

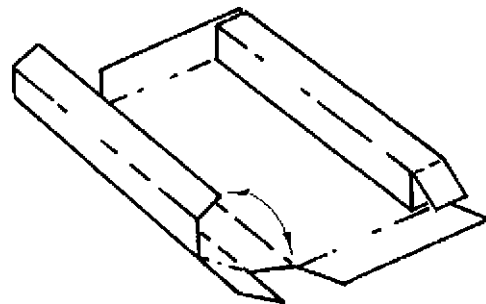

You will need a worktable, scissors (or utility knife), and glue. A ruler or other straightedge is also handy for making folds—place the straightedge against the fold and then fold, ensuring a nice, even crease.

Before actually using glue on any figure, fold it together to see if it works. If you've made a mistake, you'll have time to correct it. Otherwise, the piece will be ruined. When you glue pieces together, use the glue sparingly, or else you can gunk up a figure beyond repair.

There are eight sheets of figures: one containing Catapults, Ballistae, and a Hut, one containing Tree Trunks, Flags, and a Catapult Top, two containing Treetops, one containing a Bridge, and three containing Walls. We'll start with the Catapults, Ballistae, and Hut sheet.

CATAPULT

There are two catapults in the game. Each catapult consists of a Catapult Top, Catapult Base, Catapult Arm, and four Catapult Wheels. The second Catapult Top is on the sheet with the Tree Trunks.

Start by carefully cutting out all the catapult pieces along the outer dark lines. Then look at Diagram 1a, which shows how to fold up the Catapult Base.

Fold the base inward (toward the plain, or undecorated, side) along each of the dotted lines. The long, thin sections fold up into a long, skinny box, with the side labeled "Catapult Base" facing the undecorated side of the base. The two tabs marked with an "X" close off the ends of the box. The two decorated end flaps (one with a winch, one without) fold down to close off the back and front sides of the base.

Glue the sides marked "Catapult Base" to the undecorated underside, then glue the decorated end flaps to the "X" flaps. You now have your base. Put it aside to dry, then take out the Catapult Top.

Fold the top inward (toward the undecorated side) along each of the dotted lines, as shown in Diagram 1b. Press the top together so that it forms a right triangle, with the side labeled "Catapult Top" on the outside.

Apply a few drops of glue to each of the undecorated small triangles, and to the square section marked with an "X." Press together carefully so that the side labeled "Catapult Top" ends up on the outside. Put it aside to dry, and then take out the Catapult Arm.

Fold the arm inward (toward the undecorated side) along each of the dotted lines, as shown in Diagram 1c. You should end up with a long, thin tube with

two flaps marked "X" at one end, and a strange-looking extension at the other.

First, glue the long, thin side marked with an "X" to the undecorated side of its counterpart, forming the tube. Then glue the two small flaps together, forming an angle. Finally, place a drop of glue on the tab marked "X" at the base of the strange-looking extension, and insert it into the hollow end of the tube. You will see a circle drawn on the upper side of arm. That's where the catapult projectile would go if this were a real catapult.

Now to assemble the device. Study Diagram 1d before beginning. First, glue the Catapult Top to the Catapult Base, with the side labeled "Catapult Top" against the corresponding "X" on the Catapult Base. The angle side of the Catapult Top should face the winch drawn on the Catapult Base.

Next, glue the small end of the Catapult Arm to the small square on the Catapult Base directly in front of the Catapult Top. Note that the arm will project at an angle, and the circle where the projectile goes will be facing up.

Finally, glue the four wheels to the base. Each wheel should stick up equally above and below the base.

BALLISTA

There are two ballistas in this game. Each ballista consists of two parts: a Ballista Base and a Ballista Arm. First, carefully cut out each of the ballista parts along the solid dark lines. We'll start with the Ballista Base.

Fold the two dotted lines nearest the center inward (toward the undecorated side), and fold the outer two dotted lines

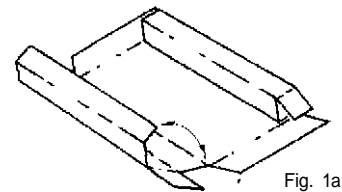

Fig. 1a

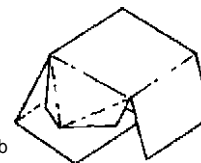

Fig. 1b

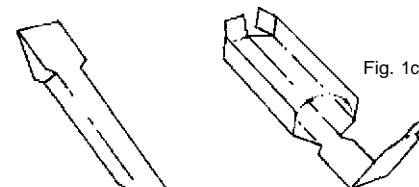

Fig. 1c

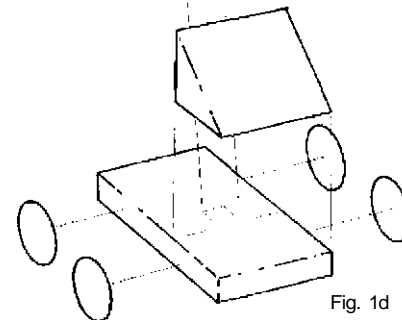

Fig. 1d

outward. Don't fold the two undecorated tabs at either end. Press the base together so that you have a triangle with a tab on top, as shown in Diagram 2a. Glue the top two halves of the tab together. Set it aside to dry, and take out the Ballista Arm.

Look at Diagram 2b. Carefully cut the Ballista Arm along the lines A-B and C-D. Do not cut across the dotted lines!

Now, fold the entire arm lengthwise. Fold back (decorated side to decorated side) the front section along the dotted line(C-C).

Take a look at Diagram 2c. Fold each half of the cut section up along the dotted lines. Bring the little tabs (each with a drawing of an arrowhead) out so that they point forward. Let go of the folded sections (each with a drawing of part of a bow). When you're finished, the entire assembly should resemble a crossbow, which is (sort of) what it is.

Diagram 2d shows how to put the pieces together. Glue the halves of the bow and of the arrowhead together. Before gluing the long, thin section together, put a little glue on the undecorated tabs of the base and insert the base so that the crossbow tilts upward. Then glue the rest of the long, thin section together. You should end up with a giant crossbow (in 25 mm scale, anyway) on a base.

HUT

There is one hut included with the game. It consists of two pieces, the Hut and the Roof. First, cut out the two pieces along the heavy dark lines. We'll start by building the Hut.

Fold the Hut along each of the dotted lines. If you like, you can cut the door and

each of the windows along three sides and fold them back so that they open.

Find the tab at the far right edge of the hut (to the right of the door as you look at the decorated side). Fold the hut so that the tab touches the far wall, as shown in Diagram 3a. Glue the tab to the inside (undecorated side) of that wall.

Then fold the roof in half (toward the undecorated side) along the center dotted line. Put a few drops of glue on each of the tabs on top of the hut, and gently press the roof against those tabs. See Diagram 3d.

FLAG

Two flags are included. They can be fastened to the standard pole carried by one of the miniature figures included in the game, or fastened to toothpicks or other thin pieces of wood or metal as decoration. Cut the flags out along the solid dark lines, and fold them in half (toward the undecorated side) along the center dotted line. Place the standard pole in the center, and glue the halves together, as shown in Diagram 4.

TREES AND TREE TRUNKS

There are ten tree trunks and two sheets of treetops included in the game. You can make a variety of trees out of these materials.

First, cut out several irregular clumps of trees from the treetops sheets. There is no "right" size or "wrong" size, but try to make all the lines curvy. Remember, in a miniatures game, each "tree" will actually represent an aerial view of a grove of trees or part of a forest. Smaller clumps of trees are more versatile than large clumps. Be sure that each clump of

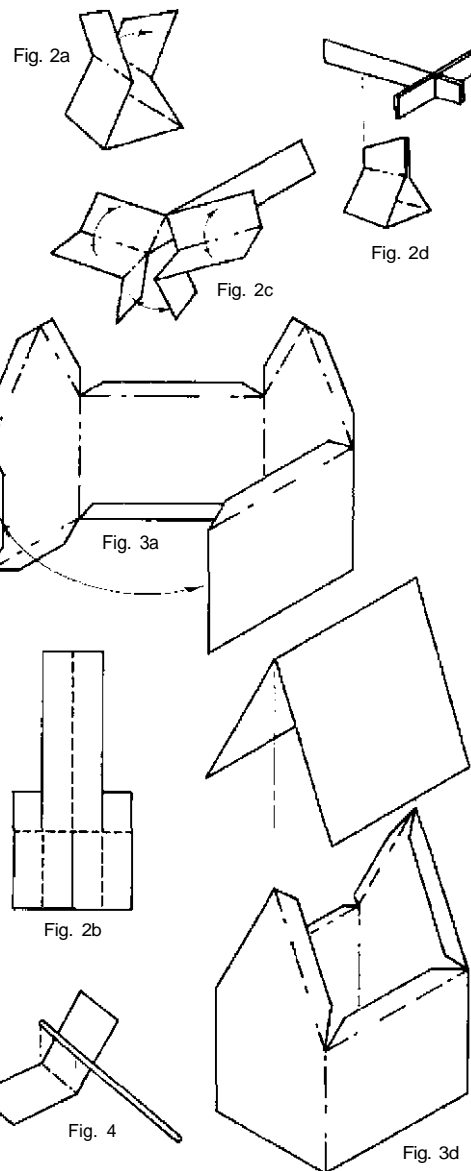

trees is big enough to use at least two tree trunks, or else they will fall over.

Next, cut out each of the tree trunks. Fold them inward (toward the undecorated side) along each of the dotted lines. When you press them together you should find that all the triangles overlap. The undecorated long side (marked with an "X") can fit behind its decorated counterpart on the other side of the tree trunk, so that the tree trunk forms a triangle. See Diagram 5a.

Glue the undecorated long side to the underside of its decorated counterpart to form a triangle. Then glue together the three triangles (it doesn't matter which side is on top) to close off the ends of the trunk.

When you have built the tree trunks, glue two or three (as needed) to the undecorated side of each of the clumps of trees you cut out earlier. See Diagram 5b.

BRIDGE

Study the bridge sheet and Diagram 6a before cutting anything out. On one end of the sheet are 15 hexagons with triangles in their middles. Those are the End Caps. Directly above them are what appear to be two rectangles divided in the middle by a heavy solid line and lengthwise by four thin solid lines. When you cut these out, cut out the long rectangles and then cut them in half along the heavy solid line. Don't cut them along the thin solid lines. These are the Guardrails. Directly above the Guardrails are two Bridge Supports with arches. One of the Bridge Supports is a solid piece, the other is cut into two pieces. Finally, above the Bridge Supports, is the Bridge Surface. It is a rectangle with a thin solid line dividing it in half, and two thin lines at the edges.

Once you've made sure you know which part is which, and where exactly to cut, cut out all the bridge pieces.

First, fold the Bridge Surface inward (toward the undecorated side) along the thin line in the center. Do not fold the thin lines at the edges.

Second, take the solid Bridge Support and fold it inward (toward the undecorated side) along the thin lines that meet in the "V" notch. Apply a few drops of glue to the flaps created by the fold, and press the folded bridge surface against them so that the surface is glued to the top of the support. Take the two halves of the other Bridge Support, fold them along the thin lines, and glue them to the other side of the bridge surface in the same way.

Take each of the four Guardrails and fold them into triangles the same way you folded the tree trunks, except that there are no triangular sections on top. It doesn't matter which side ends up underneath the others. To cap the ends of the Guardrails, take an End Cap piece, and fold each of the hexagon sides inward so that only the triangle remains facing out. Put a drop of glue on each of the folded hexagon sides and insert the End Cap into one end of the Guardrail so that the end of the Guardrail is neatly covered, as shown in Diagram 6b.

Glue the Guardrails to the Bridge Surface, as shown in Diagram 6c.

Next, take out the Walls sheet, and cut out two sections each 1 square by 2 squares. (Cut along the heavy solid lines, not along the light solid lines.) Fold each of those sections in the same way as you folded the Guardrails, and cap the ends with End Caps. Fasten these small sections to the sides of the bridge, as shown in Diagram 6d.

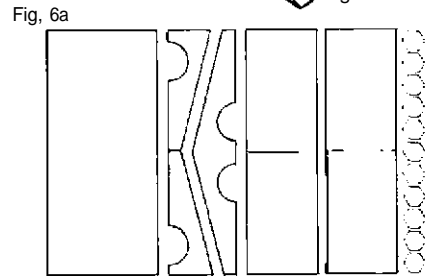
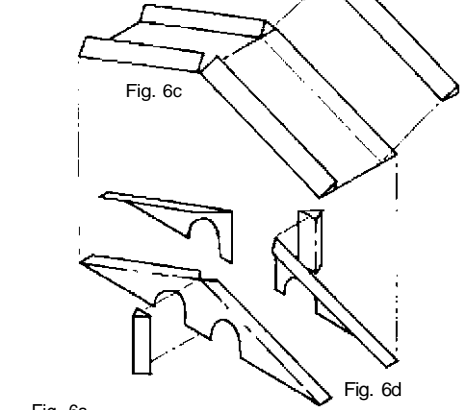
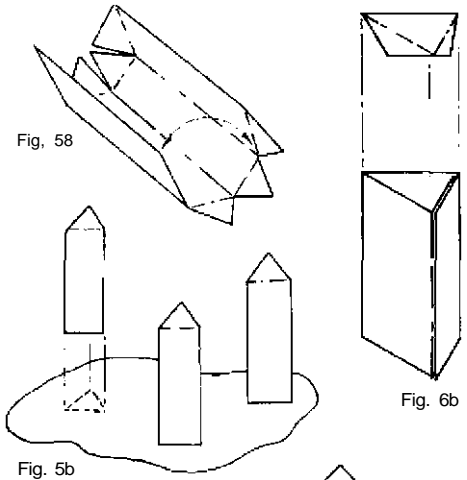

WALLS

The Walls sheets can be used to create walls of different shapes and lengths. There are two basic shapes: triangular walls (when you want them to be impassable) and rectangular walls (when you want them to be passable). Diagrams 7a and 7b show you how to fold them.

A triangular wall must be four squares wide in order to fold, and can be any number of squares long, up to the limit of the sheet. Triangular walls are folded in the same manner as Guardrails, and may be capped if you have any End Caps left over from building the Bridge.

A square wall that you want to end up one square high and wide must be five squares high when you cut it out. For every extra square high or wide you want the wall to be, add two squares when you cut the wall out. You can make the wall as long as you want, up to the limit of the sheet. Fold the square wall like you did the Catapult Base (Diagram 1a) or Catapult Arm (Diagram 1c). If you want to cap the ends, leave an extra block on two of the five sides and fold inward, as shown in Diagram 7c.

There are many different things you can do with these wall sections. Experiment with photocopies to get the shape you want, but photocopies will not last very long if you use them in the game.

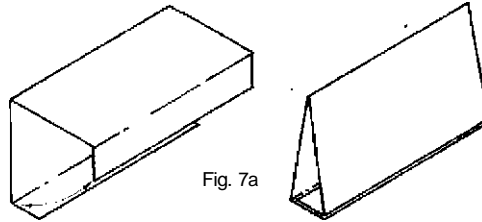

Fig. 7a

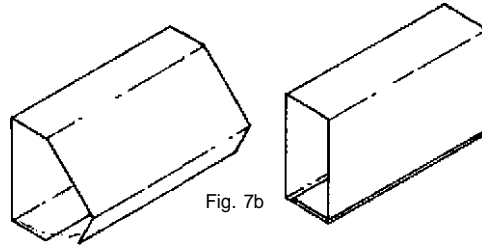

Fig. 7b

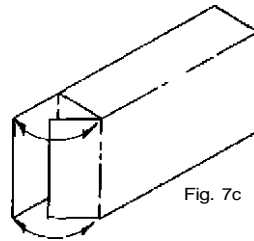

Fig. 7c



TSR, Inc.
PRODUCTS OF YOUR IMAGINATION™

© 1985 TSR, Inc. All Rights Reserved. Any reproduction or other unauthorized use of the material contained herein is prohibited without the express written permission of TSR, Inc. **ADVANCED DUNGEONS & DRAGONS, DUNGEONS & DRAGONS, AD&D, and D&D** are registered trademarks owned by TSR, Inc. * designates other trademarks owned by TSR, Inc.

Army Roster Sheet

PLAYER NAME

ARMY
BRIGADE

UNIT NAME		UNIT TYPE					
AC	#FIG	UNIT COMMANDER/DEPUTY					
HD/fig	RATIO	LEVEL/RACE/CLASS					
MV	SIZE	MR%	PPD	P/P	RSW	BW	SP
AR	AR Modifiers						
ML	ML Modifiers						
DL	Wpn/Dmg						
SPECIAL ABILITIES AND LIMITATIONS							

UNIT NAME		UNIT TYPE					
AC	#FIG	UNIT COMMANDER/DEPUTY					
HD/fig	RATIO	LEVEL/RACE/CLASS					
MV	SIZE	MR%	PPD	P/P	RSW	BW	SP
AR	AR Modifiers						
ML	ML Modifiers						
DL	Wpn/Dmg						
SPECIAL ABILITIES AND LIMITATIONS							

UNIT NAME		UNIT TYPE					
AC	#FIG	UNIT COMMANDER/DEPUTY					
HD/fig	RATIO	LEVEL/RACE/CLASS					
MV	SIZE	MR%	PPD	P/P	RSW	BW	SP
AR	AR Modifiers						
ML	ML Modifiers						
DL	Wpn/Dmg						
SPECIAL ABILITIES AND LIMITATIONS							

UNIT NAME		UNIT TYPE					
AC	#FIG	UNIT COMMANDER/DEPUTY					
HD/fig	RATIO	LEVEL/RACE/CLASS					
MV	SIZE	MR%	PPD	P/P	RSW	BW	SP
AR	AR Modifiers						
ML	ML Modifiers						
DL	Wpn/Dmg						
SPECIAL ABILITIES AND LIMITATIONS							

Heroes and Commanders Roster Sheet

ARMY NAME
PLAYER NAME

NAME								CLASS/LEVEL			NAME								CLASS/LEVEL		
COMMAND RANK		S	I	W	D	Co	Ch	MR%	COMMAND RANK		S	I	W	D	Co	Ch	MR%				
AC	CB	RACE		PPD	P/P	RSW	BW	Sp	AC	CB	RACE		PPD	P/P	RSW	BW	Sp				
HD	CR	WEAPON/DAMAGE/# AT							HD	CR	WEAPON/DAMAGE/# AT										
hp	MV								hp	MV											
THACO	AR	THACO/AR Modifiers							THACO	AR	THACO/AR Modifiers										
SPECIAL ABILITIES and LIMITATIONS									SPECIAL ABILITIES and LIMITATIONS												
NAME								CLASS/LEVEL			NAME								CLASS/LEVEL		
COMMAND RANK		S	I	W	D	Co	Ch	MR%	COMMAND RANK		S	I	W	D	Co	Ch	MR%				
AC	CB	RACE		PPD	P/P	RSW	BW	Sp	AC	CB	RACE		PPD	P/P	RSW	BW	Sp				
HD	CR	WEAPON/DAMAGE/# AT							HD	CR	WEAPON/DAMAGE/# AT										
hp	MV								hp	MV											
THACO	AR	THACO/AR Modifiers							THACO	AR	THACO/AR Modifiers										
SPECIAL ABILITIES and LIMITATIONS									SPECIAL ABILITIES and LIMITATIONS												

Players Aid Card

Combat Results Table

ATTACK ROLL	DAMAGE										
	D2	D3	D4	D6	D8	D10	D12	D14	D16	D18	D20
0 / less	5	7	9	12	15	18	20	22	24	28	32
1	4	6	8	11	14	17	19	21	23	26	29
2	3	6	7	10	13	16	18	20	22	24	26
3	3	5	7	10	13	15	18	20	22	23	25
4	3	5	7	9	12	15	17	19	20	22	24
5	3	4	6	9	11	14	17	18	20	21	23
6	3	4	6	8	11	14	16	17	18	20	22
7	3	4	6	8	11	13	15	15	17	19	21
8	2	4	5	8	10	12	15	15	16	18	20
9	2	3	5	7	10	12	14	14	15	17	19
10	2	3	5	7	9	11	13	13	15	16	18
11	2	3	5	6	8	10	12	12	14	15	17
12	2	3	4	6	8	10	11	12	13	14	16
13	2	3	4	6	7	9	11	11	12	13	15
14	2	2	4	5	7	8	10	11	11	12	13
15	1	2	4	5	6	8	9	10	11	12	13
16	1	2	3	5	6	7	9	9	10	11	12
17	1	2	3	4	5	7	8	8	9	10	11
18	1	2	3	4	5	6	7	8	8	9	10
19	1	1	3	4	5	6	6	7	8	8	9
20	1	1	2	3	4	5	6	6	7	8	8
21	1	1	2	3	4	4	5	5	7	8	8
22	1	1	2	2	3	4	4	5	6	7	8
23	0.5	1	1	2	3	3	4	4	5	6	7
24	0.5	1	1	2	2	3	3	4	5	6	7
25	0.5	0.5	1	1	2	2	2	3	4	6	6
26	0.2	0.5	1	1	1	1	2	3	3	5	5
27	0.2	0.5	0.5	0.5	1	1	1	3	3	5	5
28	0.1	0.2	0.5	0.5	0.5	1	1	2	3	4	4
29	0.1	0.2	0.2	0.2	0.5	0.5	1	2	2	3	4
30	0.1	0.1	0.1	0.2	0.2	0.5	0.5	1	2	3	3
31	0	0.1	0.1	0.1	0.2	0.2	0.5	1	1	2	3
32	0	0	0	0.1	0.1	0.2	0.2	0.5	1	2	2
33	0	0	0	0	0.1	0.1	0.2	0.5	0.5	1	2
34	0	0	0	0	0.1	0.1	0.1	0.5	0.5	1	1
35-39	0	0	0	0	0	0.1	0.1	0.2	0.2	0.5	1
40+	0	0	0	0	0	0	0	0	0	0	0

Table 14. Terrain Effects on Movement.

CLEAR TERRAIN: Full normal movement.

ROAD: Bonus of $\frac{1}{3}$ to normal movement. To use a road, the entire unit must be on the road, and the unit must stay on the road for the entire move.

WOODS: Penalty of $\frac{1}{3}$ to normal movement. Woodland creatures (elves, halflings, treants, sylphs, etc.) ignore this penalty. No unit can ever be in closed formation in the woods.

OBSTACLES (streams, walls, fences, gulleys, etc.): Penalty of $\frac{1}{3}$ to normal movement, no charge possible through obstacles. A unit in closed formation goes immediately to open formation when crossing an obstacle, but there is no movement penalty for this change of formation.

ELEVATION: Penalty of $\frac{1}{3}$ of a unit's movement rate to move up 10 feet of elevation (hill, etc.). Units may not charge uphill.

ROUGH TERRAIN: Penalty of $\frac{1}{2}$ a unit's movement rate. Dwarves, hill giants, and other mountain-bred creatures ignore this penalty. Units cannot be in closed formation in rough terrain.

SWAMPS: Penalty of $\frac{1}{2}$ to normal movement. Lizard men, sahuagin, lacedons, and other swamp inhabitants ignore this penalty. Units cannot be in closed formation in swamps.

RIVERS, PONDS, LAKES: Units can never enter these terrain features unless entirely made of aquatic or amphibious creatures. Such creatures move their full normal movement rate in water. Units cannot be in closed formation in water.

Table 10. Attack Rating Modifiers for Melee Combat.

Attacker is in open or skirmish formation	+1
Any attacking figures are out of command (does not apply to skirmish units)	+1
Defender occupies higher ground	+1
Attacker is charging in closed formation	-1
Attacking commander is fighting as part of the unit	-1

Sequence of Play

Initiative Phase
Initial Missile Phase
Rally Phase
Movement Phase
Missile and Magic Phase
Melee Phase
End of Game Round Phase

Table 13. Missile Fire Modifiers.

Target is in open or skirmish formation	+1
Target is in woods or behind hedge	+2
Target is in building, behind wall, or in Shield Wall formation (11.6)	+4
Missile-using troops are mounted	+2
Missile-using troops are using Indirect Fire	+3
Target is at Medium Range*	+2
Target is at Long Range*	+5

Table 17. Spell Areas of Effect.

AD&D® and D&D® game scale	BATTLESYSTEM™ game scale	FIGURE BASE SIZE
1"/30'	1/3"	1/2"
2"/60'	2/3"	3/4"
3"/90'	1"	1"
4"/120'	1 1/3"	1 1/2"
5"/150'	1 2/3"	1 3/4"
6"/180'	2"	2"

Players Aid Card

Combat Results Table

ATTACK ROLL	DAMAGE										
	D2	D3	D4	D6	D8	D10	D12	D14	D16	D18	D20
0 / less	5	7	9	12	15	18	20	22	24	28	32
1	4	6	8	11	14	17	19	21	23	26	29
2	3	6	7	10	13	16	18	20	22	24	26
3	3	5	7	10	13	15	18	20	22	23	25
4	3	5	7	9	12	15	17	19	20	22	24
5	3	4	6	9	11	14	17	18	20	21	23
6	3	4	6	8	11	14	16	17	18	20	22
7	3	4	6	8	11	13	15	15	17	19	21
8	2	4	5	8	10	12	15	15	16	18	20
9	2	3	5	7	10	12	14	14	15	17	19
10	2	3	5	7	9	11	13	13	15	16	18
11	2	3	5	6	8	10	12	12	14	15	17
12	2	3	4	6	8	10	11	12	13	14	16
13	2	3	4	6	7	9	11	11	12	13	15
14	2	2	4	5	7	8	10	11	11	12	13
15	1	2	4	5	6	8	9	10	11	12	13
16	1	2	3	5	6	7	9	9	10	11	12
17	1	2	3	4	5	7	8	8	9	10	11
18	1	2	3	4	5	6	7	8	8	9	10
19	1	1	3	4	5	6	6	7	8	8	9
20	1	1	2	3	4	5	6	6	7	8	8
21	1	1	2	3	4	4	5	5	7	8	8
22	1	1	2	2	3	4	4	5	6	7	8
23	0.5	1	1	2	3	3	4	4	5	6	7
24	0.5	1	1	2	2	3	3	4	5	6	7
25	0.5	0.5	1	1	2	2	2	3	4	6	6
26	0.2	0.5	1	1	1	1	2	3	3	5	5
27	0.2	0.5	0.5	0.5	1	1	1	3	3	5	5
28	0.1	0.2	0.5	0.5	0.5	1	1	2	3	4	4
29	0.1	0.2	0.2	0.2	0.5	0.5	1	2	2	3	4
30	0.1	0.1	0.1	0.2	0.2	0.5	0.5	1	2	3	3
31	0	0.1	0.1	0.1	0.2	0.2	0.5	1	1	2	3
32	0	0	0	0.1	0.1	0.2	0.2	0.5	1	2	2
33	0	0	0	0	0.1	0.1	0.2	0.5	0.5	1	2
34	0	0	0	0	0.1	0.1	0.1	0.5	0.5	1	1
35-39	0	0	0	0	0	0.1	0.1	0.2	0.2	0.5	1
40+	0	0	0	0	0	0	0	0	0	0	0

Table 14. Terrain Effects on Movement.

CLEAR TERRAIN: Full normal movement.

ROAD: Bonus of $\frac{1}{3}$ to normal movement. To use a road, the entire unit must be on the road, and the unit must stay on the road for the entire move.

WOODS: Penalty of $\frac{1}{3}$ to normal movement. Woodland creatures (elves, halflings, treants, sylphs, etc.) ignore this penalty. No unit can ever be in closed formation in the woods.

OBSTACLES (streams, walls, fences, gulleys, etc.): Penalty of $\frac{1}{3}$ to normal movement, no charge possible through obstacles. A unit in closed formation goes immediately to open formation when crossing an obstacle, but there is no movement penalty for this change of formation.

ELEVATION: Penalty of $\frac{1}{3}$ of a unit's movement rate to move up 10 feet of elevation (hill, etc.). Units may not charge uphill.

ROUGH TERRAIN: Penalty of $\frac{1}{2}$ a unit's movement rate. Dwarves, hill giants, and other mountain-bred creatures ignore this penalty. Units cannot be in closed formation in rough terrain.

SWAMPS: Penalty of $\frac{1}{2}$ to normal movement. Lizard men, sahuagin, lacedons, and other swamp inhabitants ignore this penalty. Units cannot be in closed formation in swamps.

RIVERS, PONDS, LAKES: Units can never enter these terrain features unless entirely made of aquatic or amphibious creatures. Such creatures move their full normal movement rate in water. Units cannot be in closed formation in water.

Table 10. Attack Rating Modifiers for Melee Combat.

Attacker is in open or skirmish formation	+1
Any attacking figures are out of command (does not apply to skirmish units)	+1
Defender occupies higher ground	+1
Attacker is charging in closed formation	-1
Attacking commander is fighting as part of the unit	-1

Sequence of Play

Initiative Phase
Initial Missile Phase
Rally Phase
Movement Phase
Missile and Magic Phase
Melee Phase
End of Game Round Phase

Table 13. Missile Fire Modifiers.

Target is in open or skirmish formation	+1
Target is in woods or behind hedge	+2
Target is in building, behind wall, or in Shield Wall formation (11.6)	+4
Missile-using troops are mounted	+2
Missile-using troops are using Indirect Fire	+3
Target is at Medium Range*	+2
Target is at Long Range*	+5

Table 17. Spell Areas of Effect.

AD&D® and D&D® game scale	BATTLESYSTEM™ game scale	FIGURE BASE SIZE
1"/30'	1/3"	1/2"
2"/60'	2/3"	3/4"
3"/90'	1"	1"
4"/120'	1 1/3"	1 1/2"
5"/150'	1 2/3"	1 3/4"
6"/180'	2"	2"

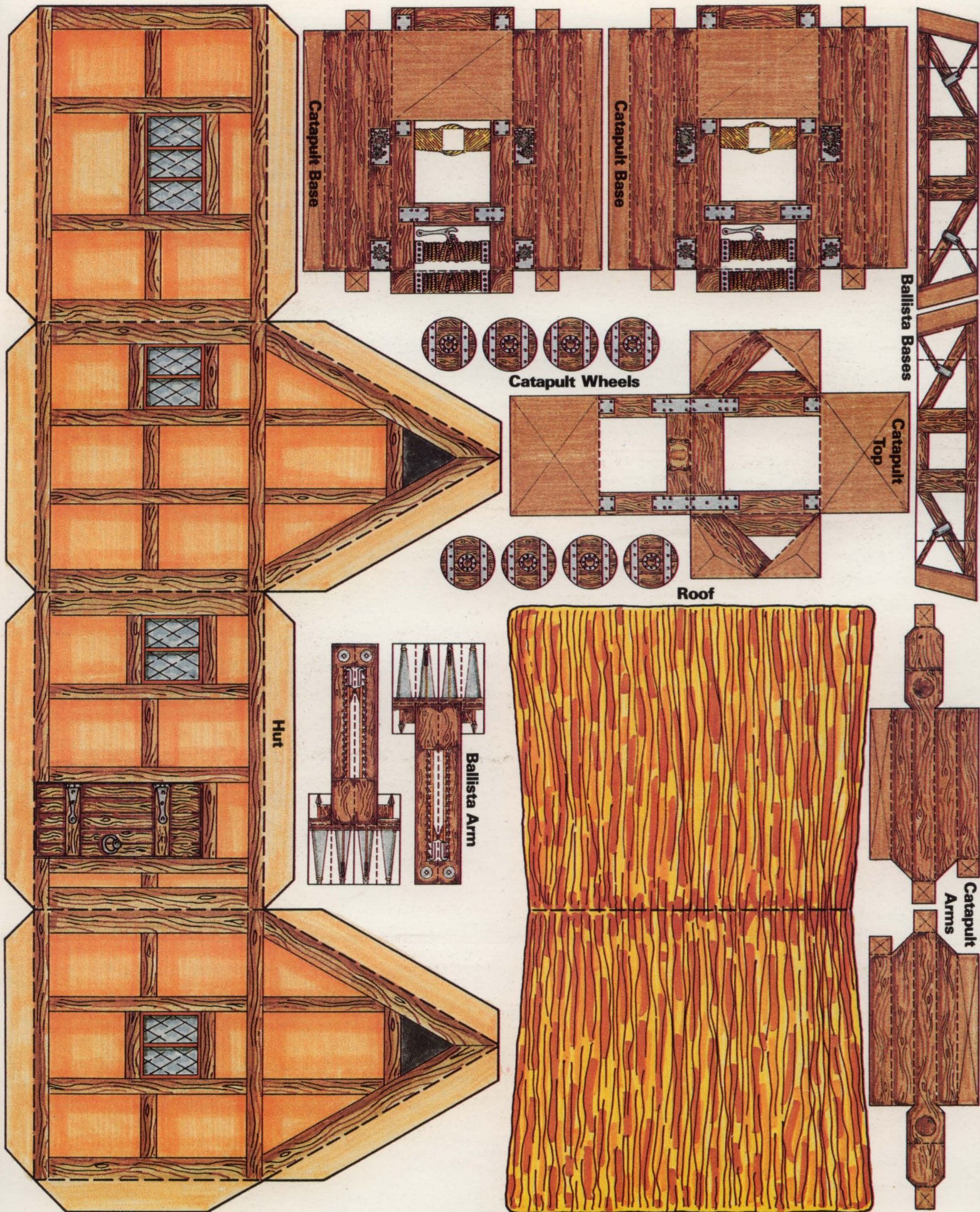

Catapult Base

Catapult Base

Ballista Bases

Catapult Wheels

Catapult Top

Roof

Hut

Ballista Arm

Catapult Arms

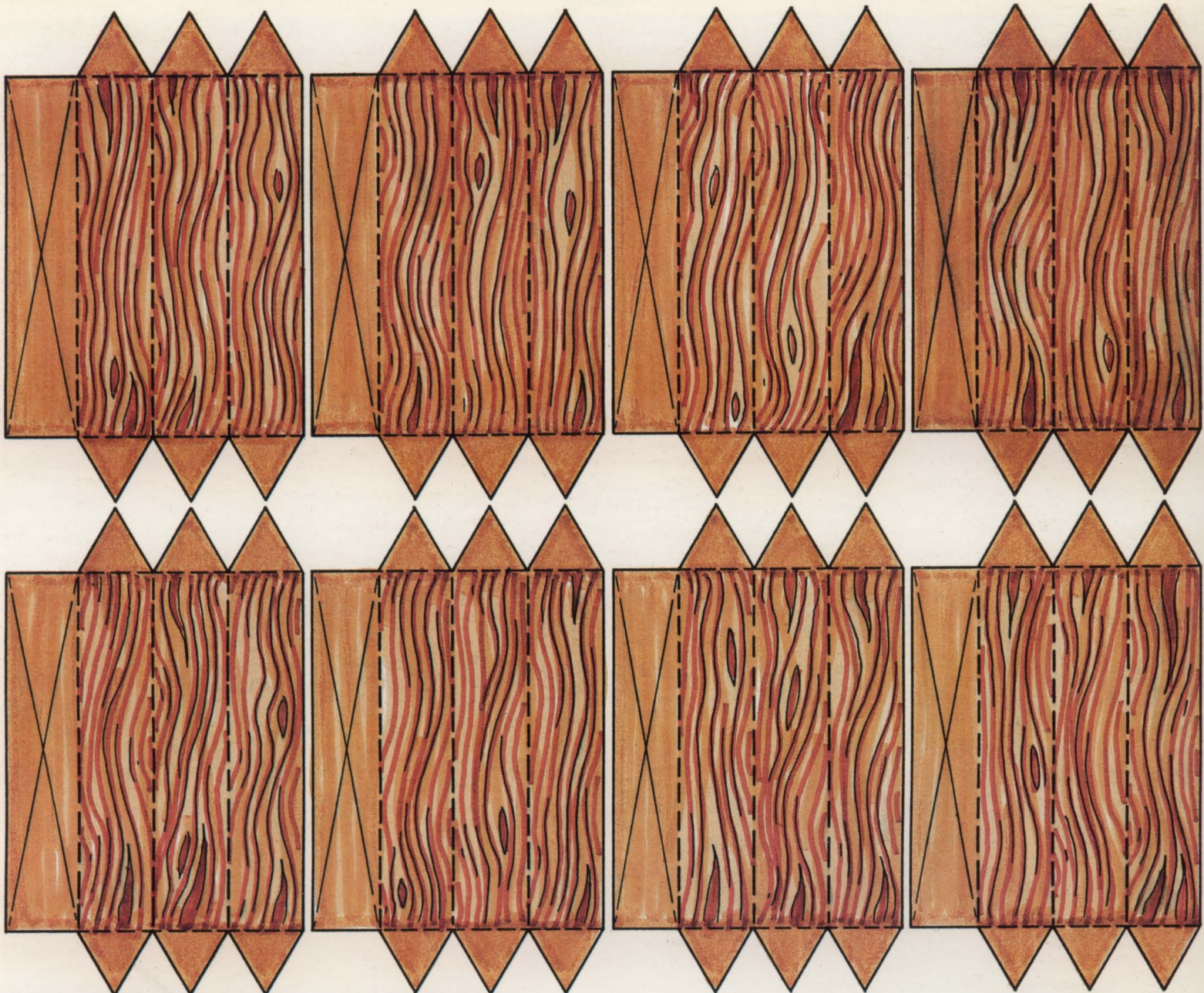

**Flags for
Standard Bearer**

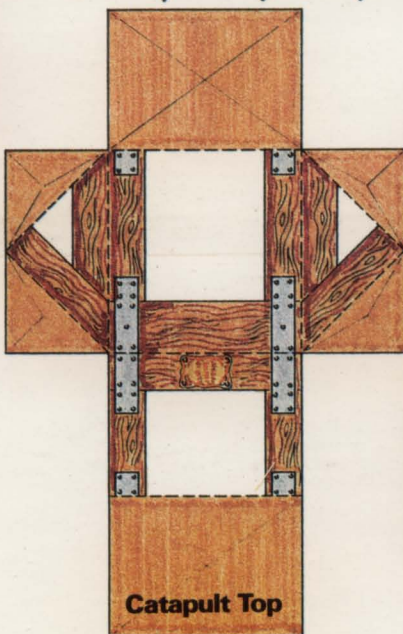

Catapult Top

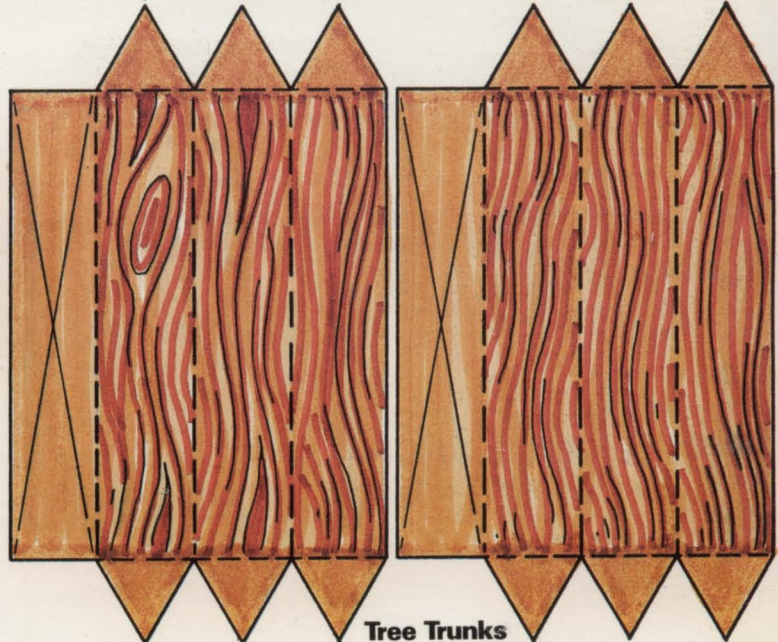

Tree Trunks

Bridge



Walls

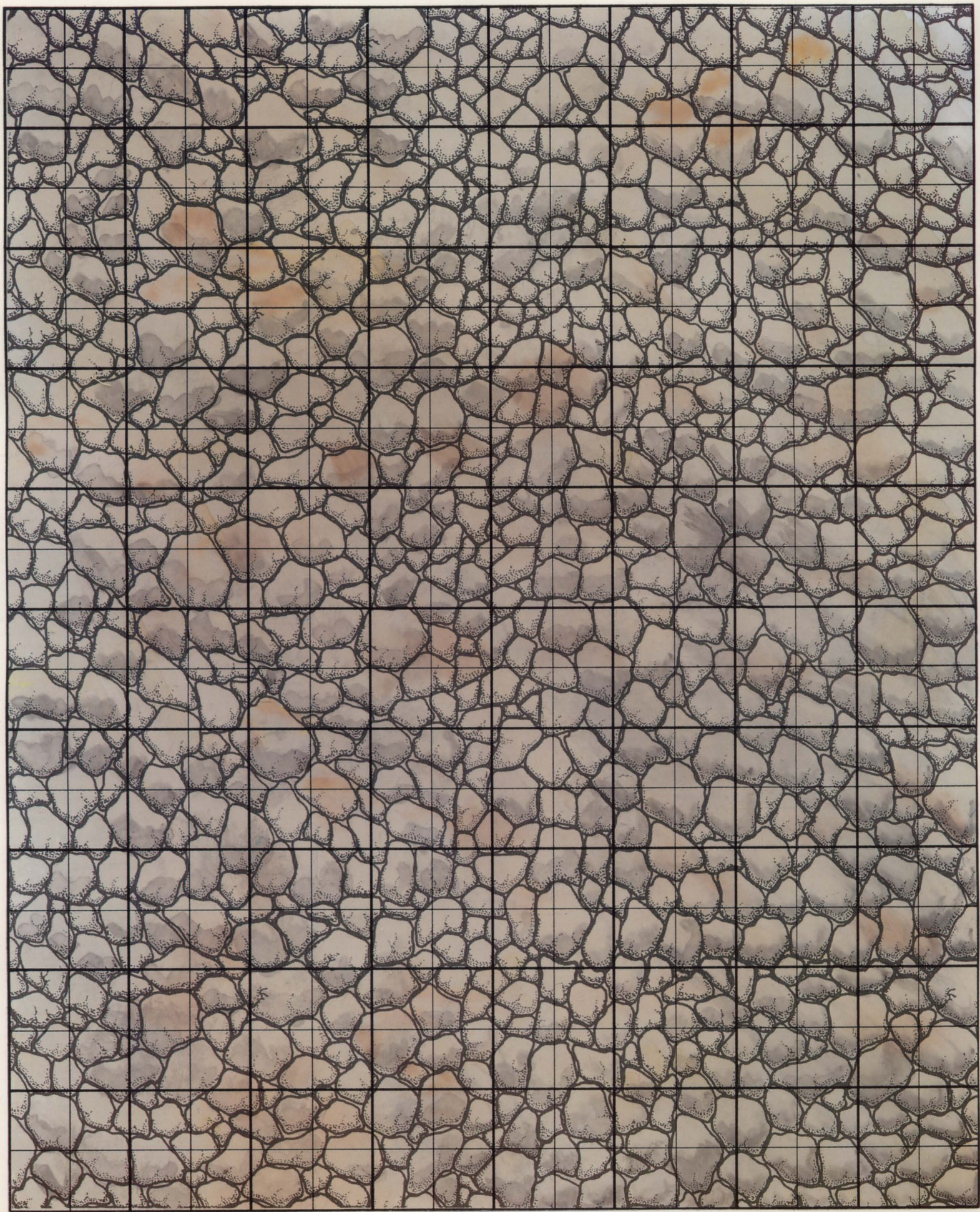

Treetops

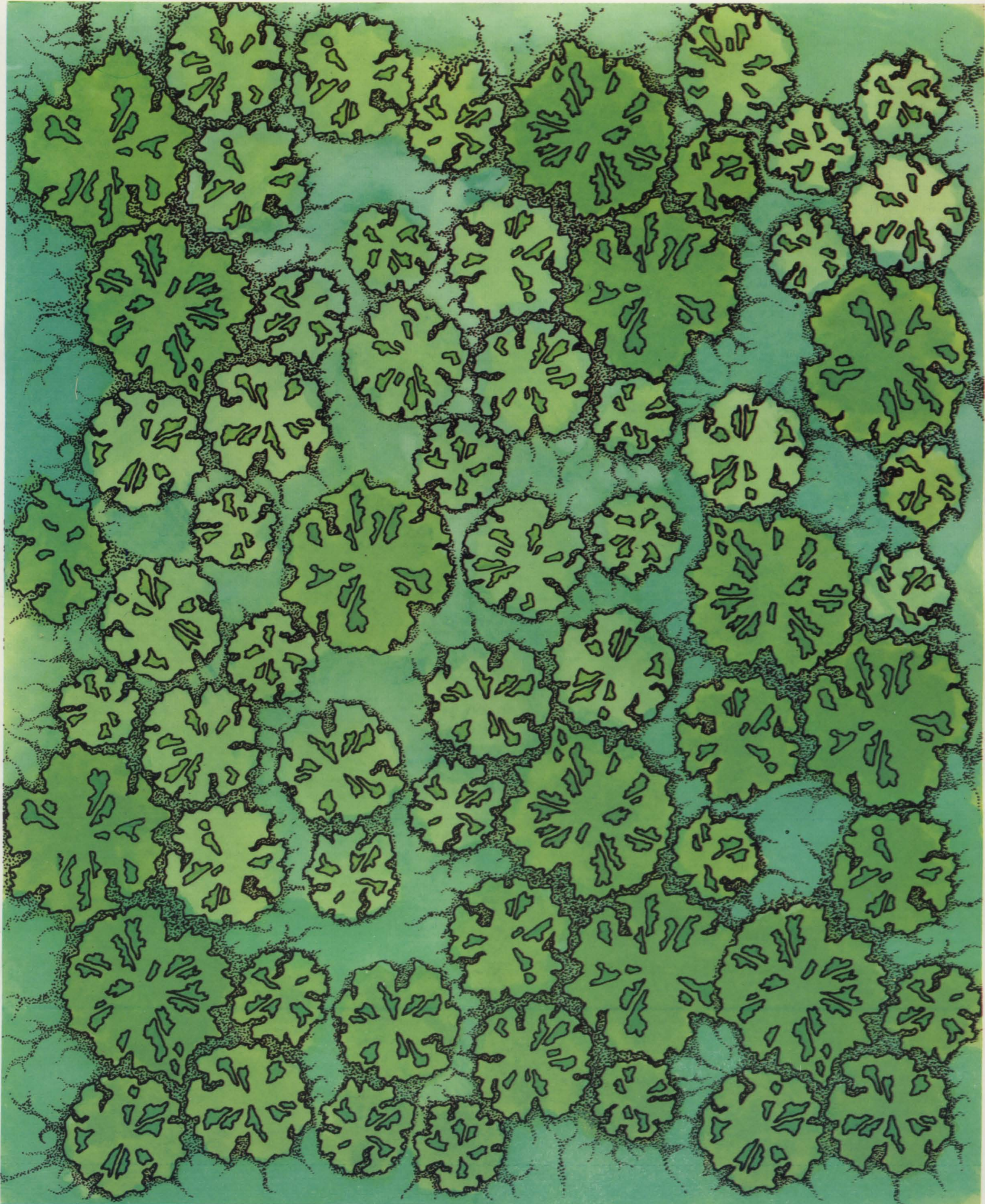



Troll



Troll



Troll



Troll



Troll



Troll



Troll



Troll



Troll



Troll



Troll



Troll



Troll



Troll



Troll



Troll



Troll



Troll



Ogre



Ogre



Ogre



Ogre



Ogre



Ogre



Ogre



Ogre



Ogre



Ogre



Ogre



Ogre



Ogre



Ogre



Ogre



Ogre



Ogre



Ogre



Wyvern



Wyvern



Wyvern



Wyvern



Wyvern



Wyvern



Wyvern



Wyvern



Wyvern



Wyvern



Wyvern



Wyvern



Giant



Giant



Giant



Giant



Giant



Giant



Wounded



Wounded



Wounded



Wounded



Wounded



Wounded



Wounded



Wounded



Wounded



Wounded



Wounded



Wounded



Wounded



Wounded



Wounded



Wounded



Wounded



Wounded



Wounded



Wounded



Wounded



Wounded



Wounded



Wounded



Wounded



Wounded



Wounded



Wounded



Wounded



Wounded



Wounded



Wounded



Wounded



Wounded



Wounded



Wounded



Wounded



Wounded



Wounded



Wounded



Wounded



Wounded



Wounded



Wounded



Wounded



Wounded



Wounded



Wounded



Wounded



Wounded



Wounded



Wounded



Wounded



Wounded



Giant



Giant



Giant



Giant



Giant



Monster



Giant



Giant



Giant



Giant



Giant



Monster



Giant



Giant



Giant



Giant



Giant



Monster



Roc



Roc



Roc



Roc



Roc



Monster



Monster



Monster



Monster



Monster



Monster



Monster



Monster



Monster



Monster



Monster



Monster



Monster



Monster



Monster



Monster



Monster



Monster



Monster



Monster



Monster



Monster



Monster



Monster



Monster



Monster



Monster



Monster



Monster



Monster



Monster



Wounded



Wounded



Wounded



Wounded



Wounded



Wounded



Wounded



Wounded



Wounded



Wounded



Wounded



Wounded



Wounded



Wounded



Wounded



Wounded



Wounded



Wounded



Wounded



Wounded



Wounded



Wounded



Wounded



Wounded



Wounded



Wounded



Wounded



Wounded



Wounded



Wounded



Wounded



Wounded



Wounded



Wounded



Wounded



Wounded



Wounded



Wounded



Wounded



Wounded



Wounded



Wounded



Wounded



Wounded



Wounded



Wounded



Wounded



Wounded



Wounded



Wounded



Wounded























































Wounded























































Wounded



Wounded

 Dwarf	 Dwarf	 Dwarf	 Dwarf
 Dwarf	 Dwarf	 Dwarf	 Dwarf
 Dwarf	 Dwarf	 Dwarf	 Dwarf
 Dwarf	 Dwarf	 Dwarf	 Dwarf
 Human	 Human	 Human	 Human
 Human	 Human	 Human	 Human
 Human	 Human	 Human	 Human
 Human	 Human	 Human	 Human
 Human	 Human	 Human	 Human
 Human	 Human	 Orc	 Orc
 Orc	 Orc	 Orc	 Orc
 Orc	 Orc	 Orc	 Orc
 Orc	 Orc	 Orc	 Orc

 Dwarf	 Dwarf	 Dwarf	 Dwarf
 Dwarf	 Dwarf	 Dwarf	 Dwarf
 Dwarf	 Dwarf	 Dwarf	 Dwarf
 Dwarf	 Dwarf	 Human	 Human
 Human	 Human	 Human	 Human
 Human	 Human	 Human	 Human
 Human	 Human	 Human	 Human
 Human	 Human	 Human	 Human
 Human	 Human	 Human	 Human
 Orc	 Orc	 Orc	 Orc
 Orc	 Orc	 Orc	 Orc
 Orc	 Orc	 Orc	 Orc
 Orc	 Orc	 Orc	 Orc

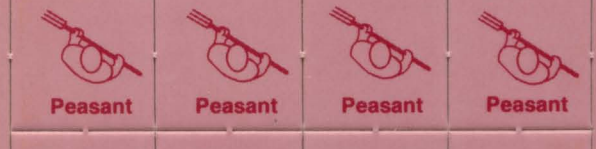
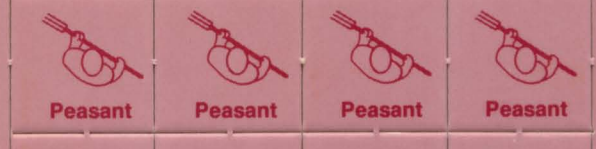
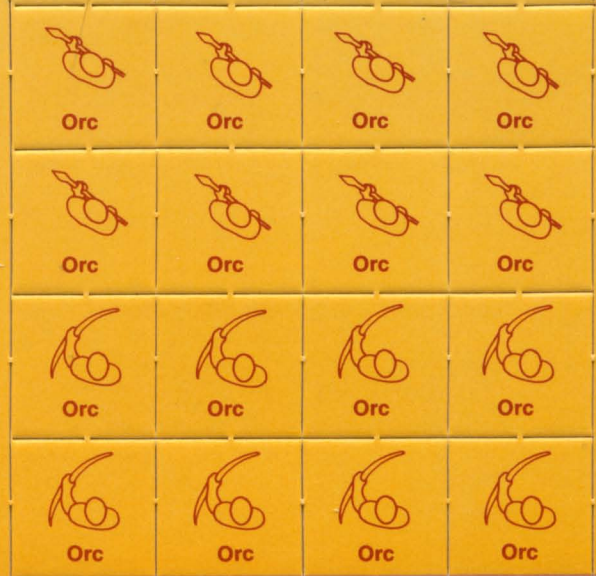
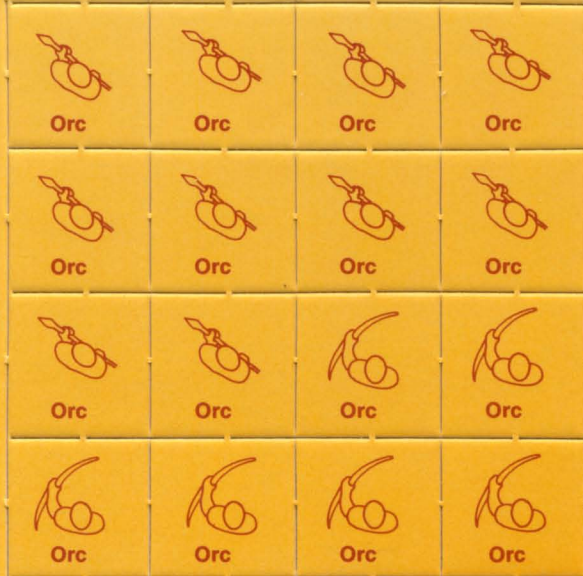



Wounded



Wounded



Wounded



Wounded



Wounded



Wounded



Wounded



Wounded



Wounded



Wounded



Wounded



Wounded



Wounded



Wounded



Wounded



Wounded



Wounded



Wounded



Wounded



Wounded



Wounded



Wounded



Wounded



Wounded



Wounded



Wounded



Wounded



Wounded



Wounded



Wounded



Wounded



Wounded



Wounded



Wounded



Wounded



Wounded



Wounded



Wounded



Wounded



Wounded



Wounded



Wounded



Wounded



Wounded



Wounded



Wounded



Wounded



Wounded



Wounded



Wounded



Wounded



Wounded



Wounded



Wounded



Wounded



Wounded



Wounded



Wounded



Wounded



Wounded



Wounded



Wounded



Wounded



Wounded



Wounded



Wounded



Wounded



Wounded



Wounded



Wounded



Wounded



Wounded



Wounded



Wounded



Wounded



Wounded



Wounded



Wounded



Wounded



Wounded



Draconian



Draconian



Draconian



Draconian



Draconian



Draconian



Draconian



Draconian



Draconian



Draconian



Draconian



Draconian



Draconian



Draconian



Draconian



Draconian



Draconian



Draconian



Draconian



Draconian



Draconian



Draconian



Draconian



Draconian



Giant



Giant



Giant



Giant



Giant



Giant

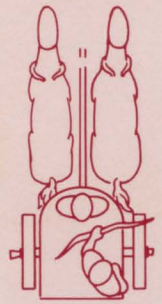

Chariot

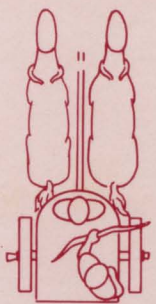

Chariot



Elephant



Giant



Giant



Giant



Giant



Giant



Giant

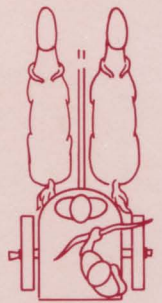

Chariot

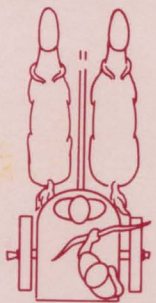

Chariot



Elephant



Dragon



Dragon



Dragon

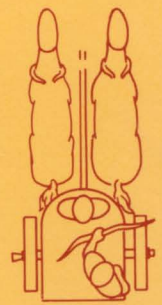

Chariot

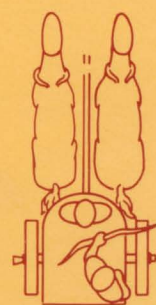

Chariot



Dragon



Dragon



Dragon



Dragon

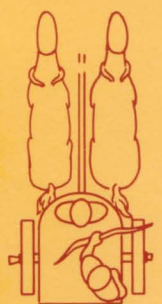

Chariot

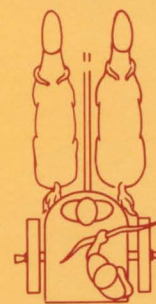

Chariot



Dragon



Dragon



Dragon



Dragon



Wounded



Wounded



Wounded



Wounded



Wounded



Wounded



Wounded



Wounded



Wounded



Wounded



Wounded



Wounded



Wounded

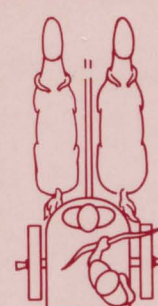

Damaged

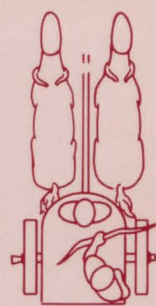

Damaged



Wounded



Wounded



Wounded



Wounded

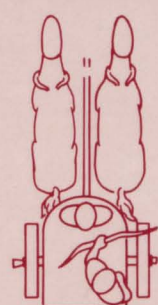

Damaged

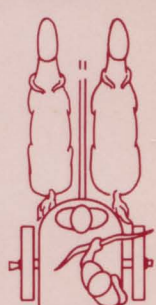

Damaged



Wounded



Wounded



Wounded



Wounded

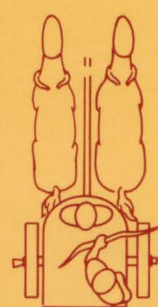

Damaged

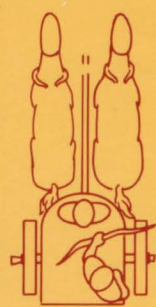

Damaged



Wounded



Wounded



Wounded



Wounded

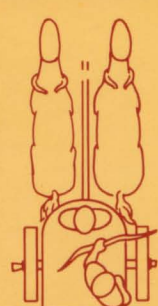

Damaged

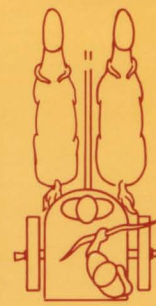

Damaged



Orc



Orc



Orc



Orc



Orc



Orc



Orc



Orc



Goblin



Goblin



Goblin



Goblin



Goblin



Goblin



Goblin



Goblin



Goblin



Goblin



Goblin



Goblin



Goblin



Goblin



Goblin



Goblin



Heavy Cavalry



Heavy Cavalry



Heavy Cavalry



Heavy Cavalry



Heavy Cavalry

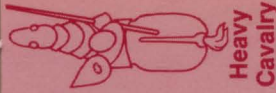

Heavy Cavalry

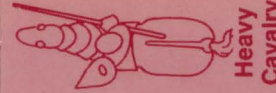

Heavy Cavalry



Heavy Cavalry

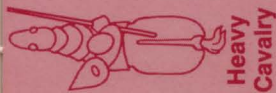

Heavy Cavalry



Heavy Cavalry

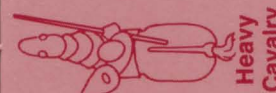

Heavy Cavalry

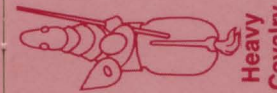

Heavy Cavalry



Light Cavalry



Light Cavalry

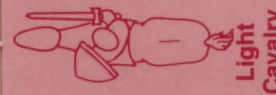

Light Cavalry



Light Cavalry



Light Cavalry



Light Cavalry



Light Cavalry



Light Cavalry



Light Cavalry



Light Cavalry



Light Cavalry



Light Cavalry



Light Cavalry



Light Cavalry



Light Cavalry



Light Cavalry

Wounded



Wounded



Wounded



Wounded



Wounded



Wounded



Wounded



Wounded



Wounded



Wounded



Wounded



Wounded



Wounded



Wounded



Wounded



Wounded



Wounded



Wounded



Wounded



Wounded



Wounded



Wounded



Wounded



Wounded



Wounded



Wounded



Wounded



Wounded



Wounded



Wounded



Wounded



Wounded



Wounded



Wounded



Wounded



Wounded



Wounded



Wounded



Wounded



Wounded



Wounded



Wounded



Wounded



Wounded



Wounded



Wounded



Wounded



Wounded



Wounded



Wounded



Wounded



Wounded



Official Advanced Dungeons & Dragons

BATTLE SYSTEM™

Fantasy Combat Supplement

Here's What You Get!

- A. 1 32-page rule book
- B. 1 24-page scenario book
- C. 1 16-page guide to miniatures
- D. 2 Player Aid Cards
- E. 2 Metal Miniature Generals*
- F. 3-D ADVENTURE FOLD-UP™ Figures
- G. Army Roster Sheets
- H. 801 die-cut counters

An exciting new direction for AD&D® and D&D® games!

Create fantastic armies with miniature figures or die-cut counters and fight incredible battles against the forces of evil!

The BATTLESYSTEM™ game is fully compatible with any official AD&D® or D&D® game spell, monster, or plane of existence—no matter how obscure! You can create your own battles or play the exciting scenarios—including an epic DRAGONLANCE™ adventure battle!

The BATTLESYSTEM™ game uses an innovative mass combat system and allows use of field artillery, flying, magic, invisibility, and illusion! AD&D® and D&D® characters can earn experience points by commanding armies or fight as individual heroes!

Lead your armies into the ultimate fantasy war with the BATTLESYSTEM™ Fantasy Combat Supplement!

*WARNING: Contains LEAD and should not be chewed or swallowed. Not suitable for children under 10 years of age.

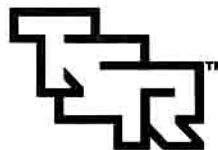

TSR, Inc.
PRODUCTS OF YOUR IMAGINATION™

TSR, Inc.
POB 756
Lake Geneva, WI 53147

TSR UK Ltd.
The Mill, Rathmore Road
Cambridge CB1 4AD
United Kingdom

