

THE MINOTAUR'S BARGAIN: A1

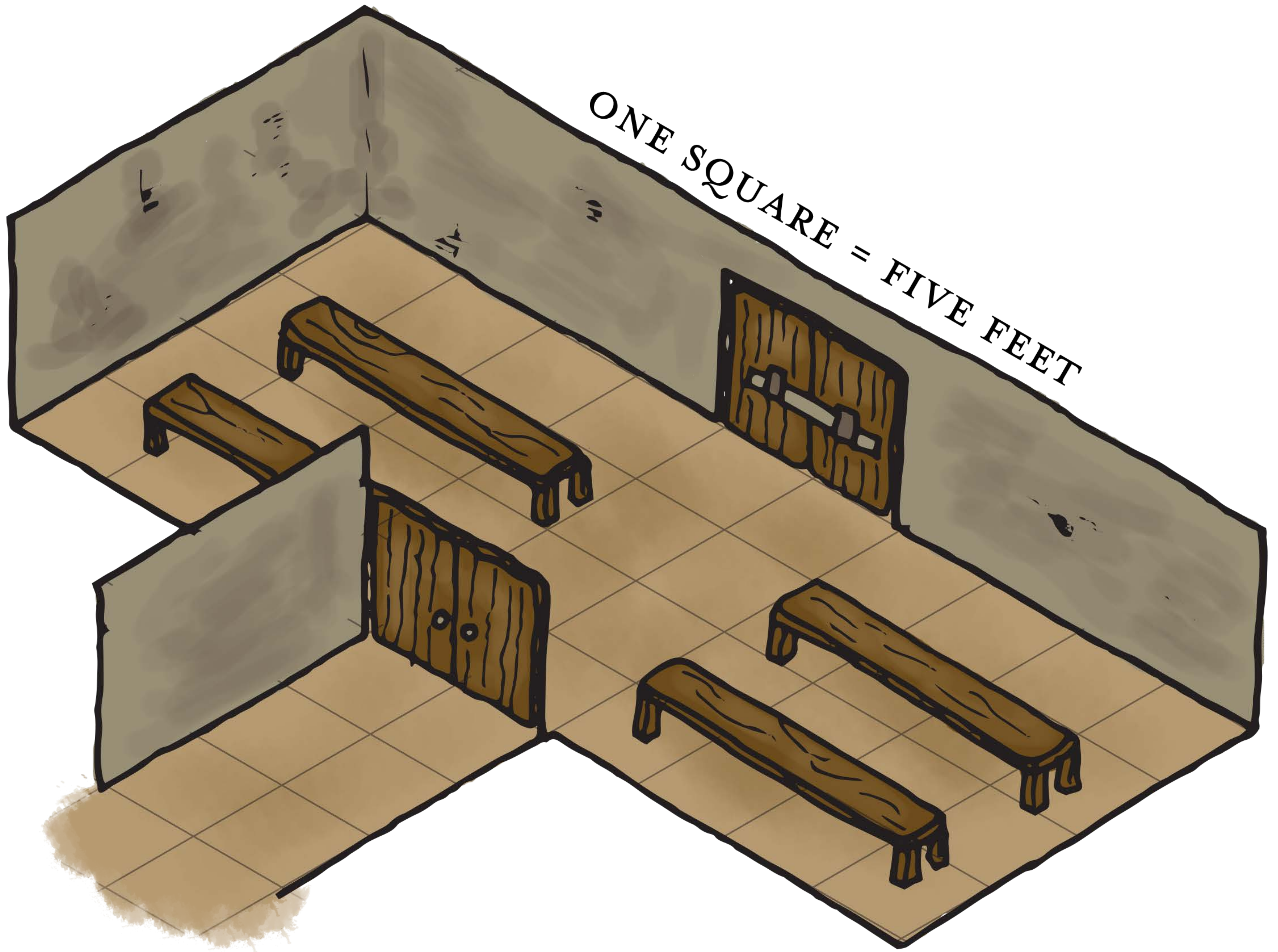

THE MINOTAUR'S BARGAIN: A1

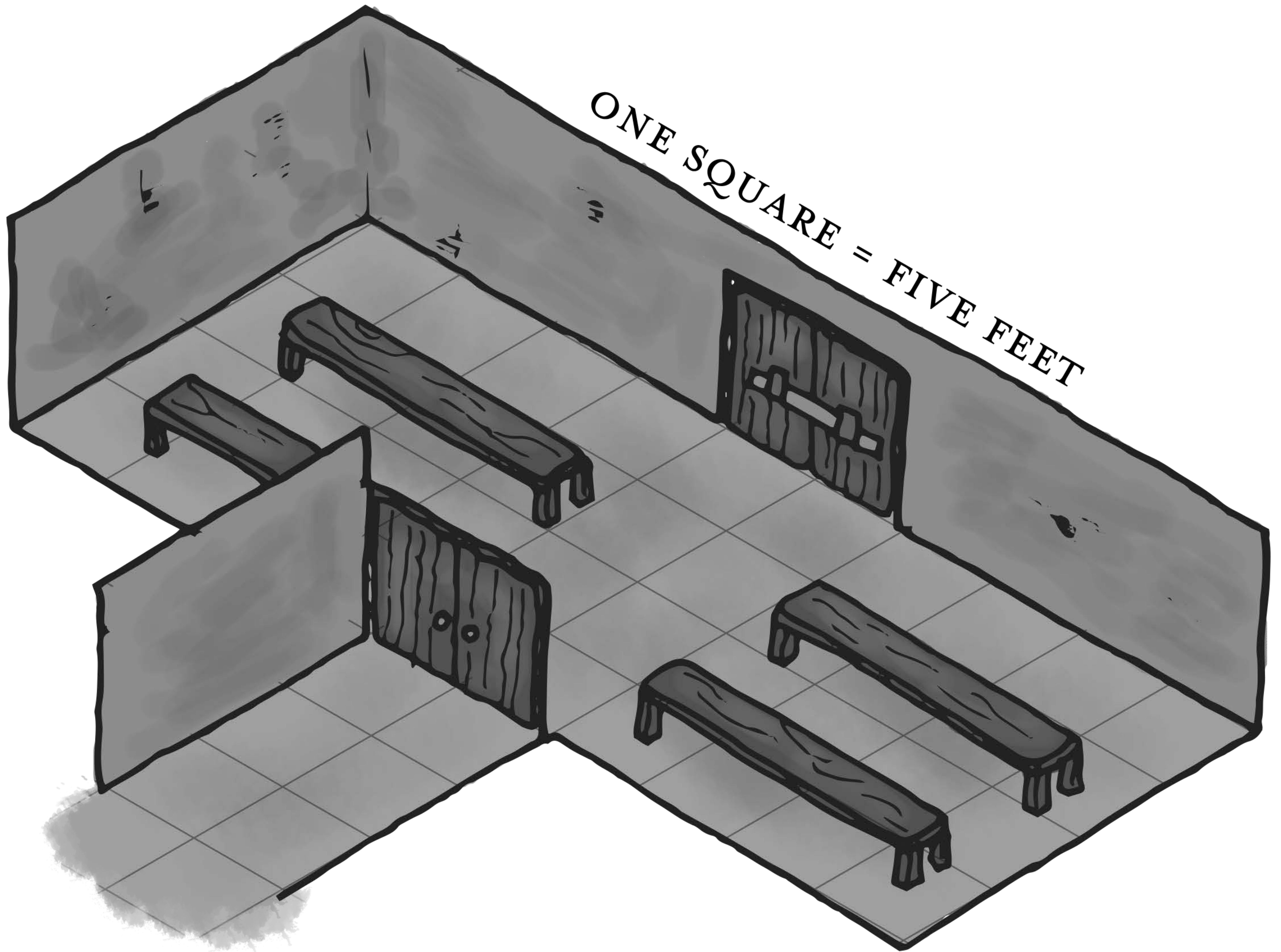

THE MINOTAUR'S BARGAIN: A2

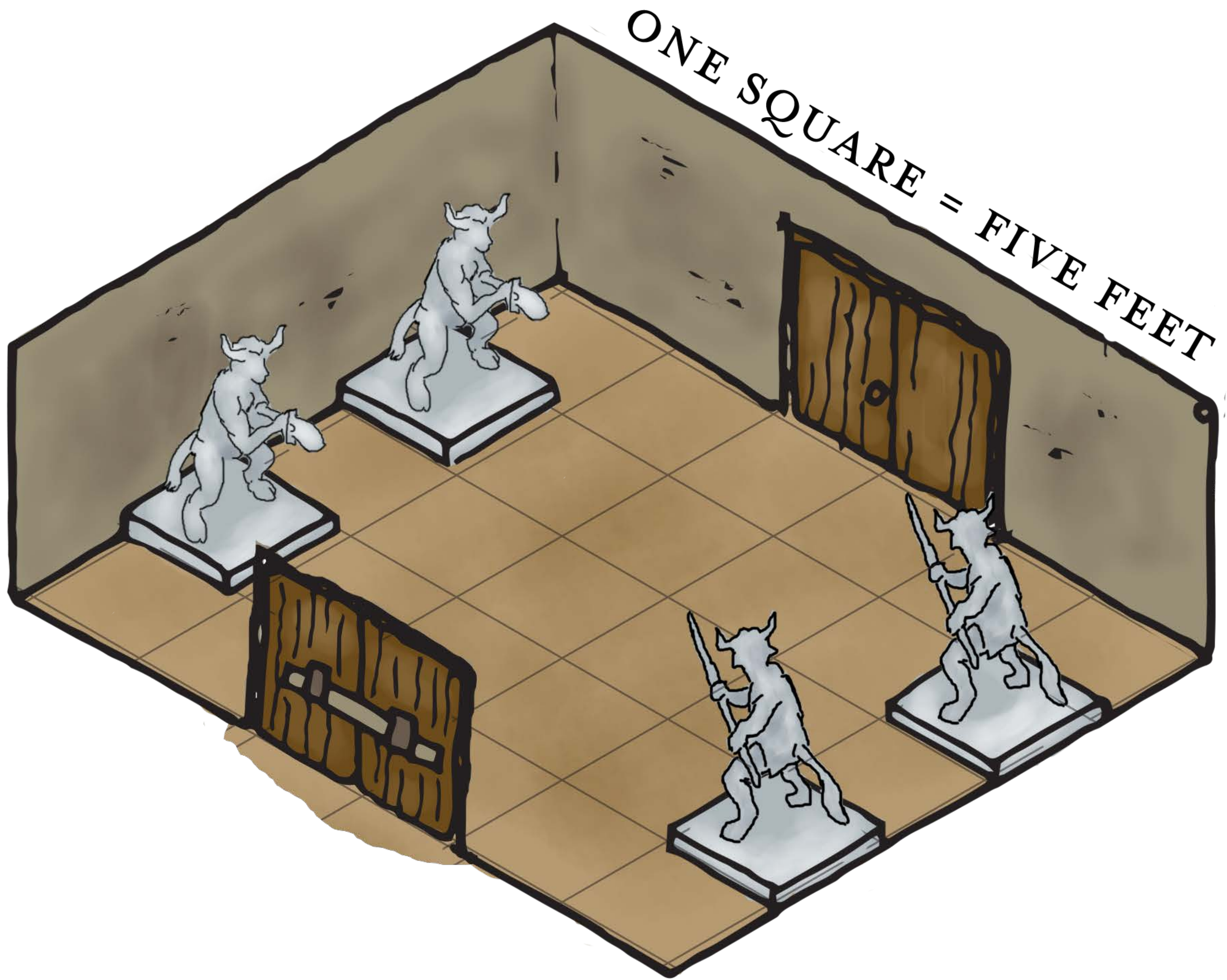

THE MINOTAUR'S BARGAIN: A2

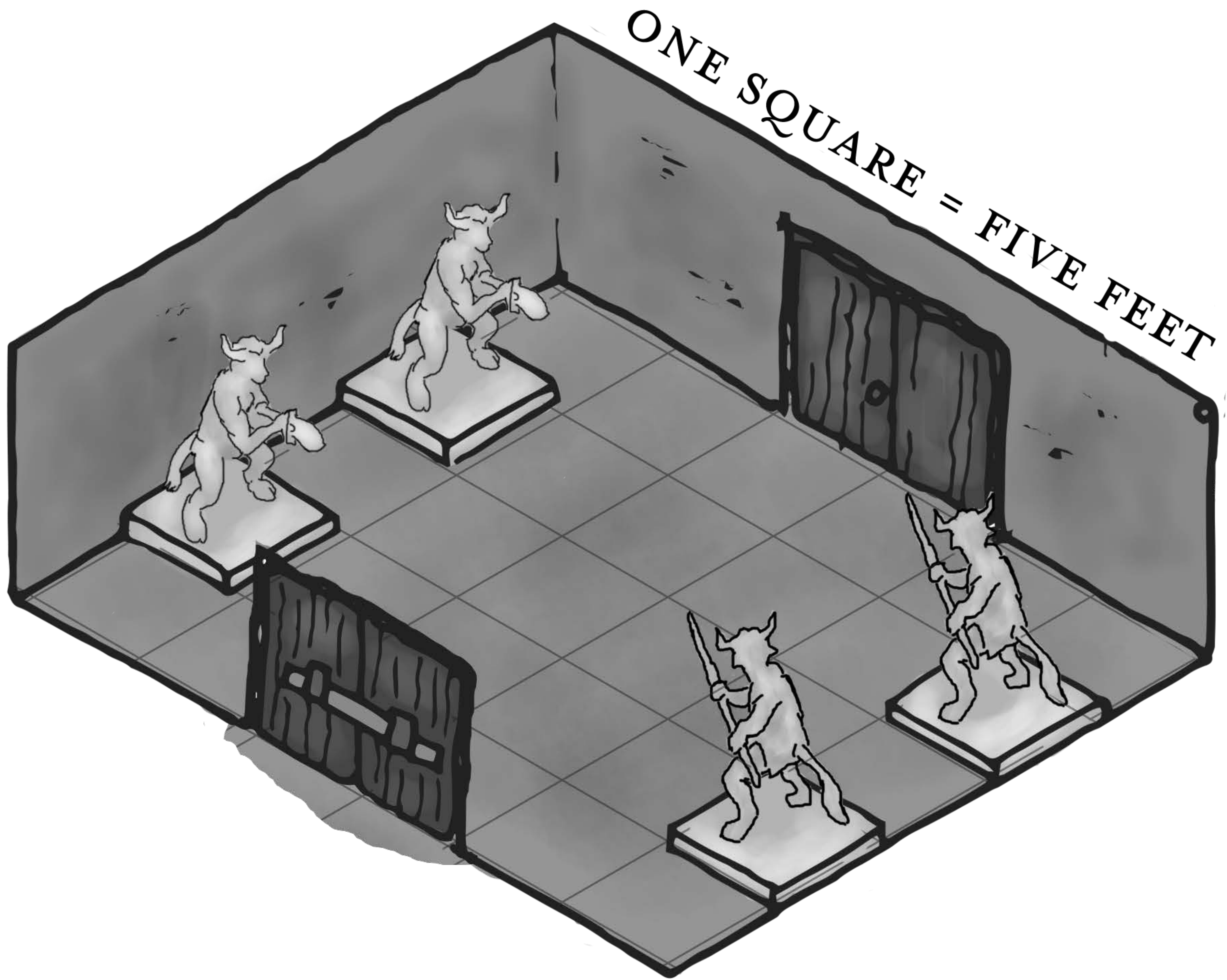

THE MINOTAUR'S BARGAIN: A4

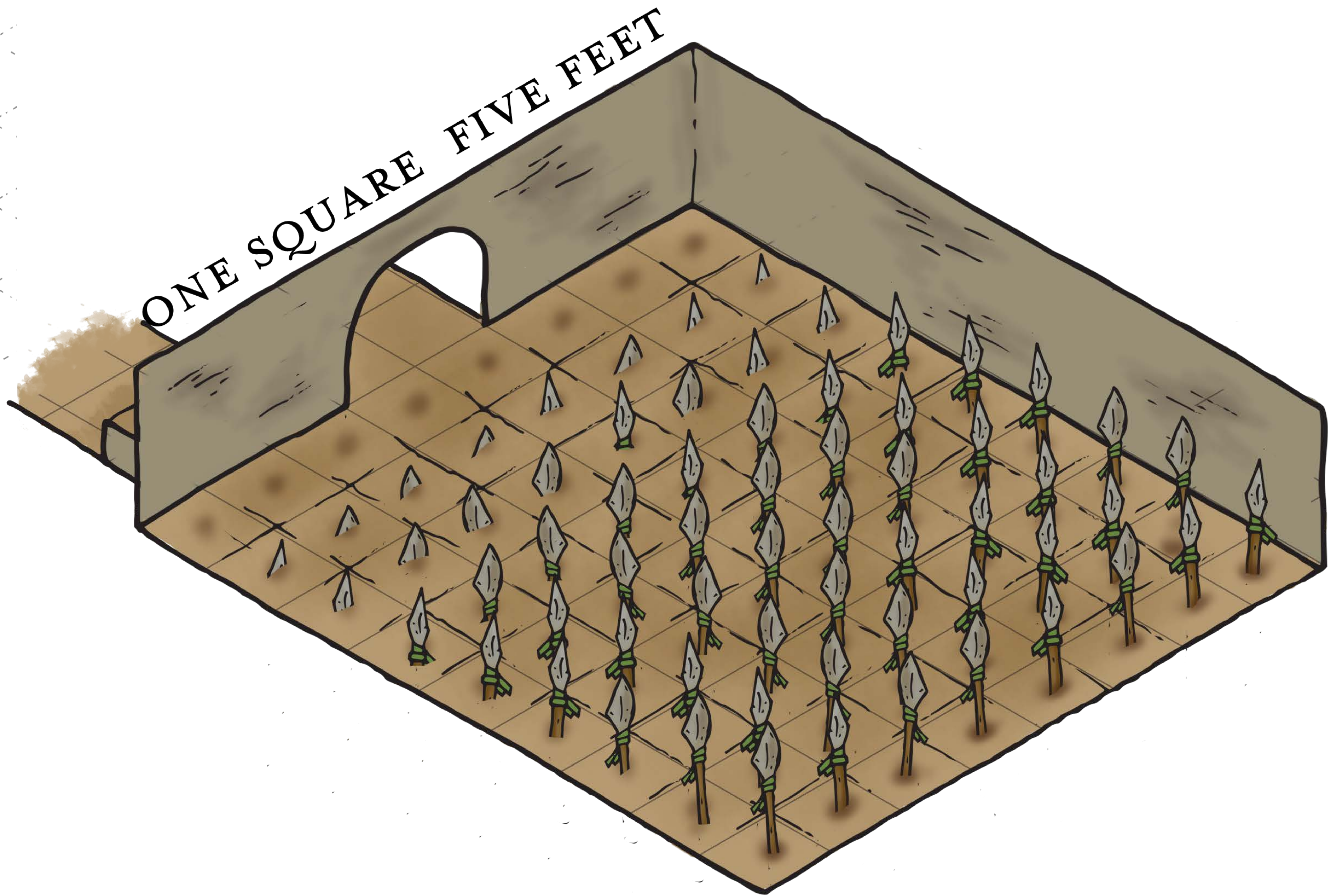

THE MINOTAUR'S BARGAIN: A4

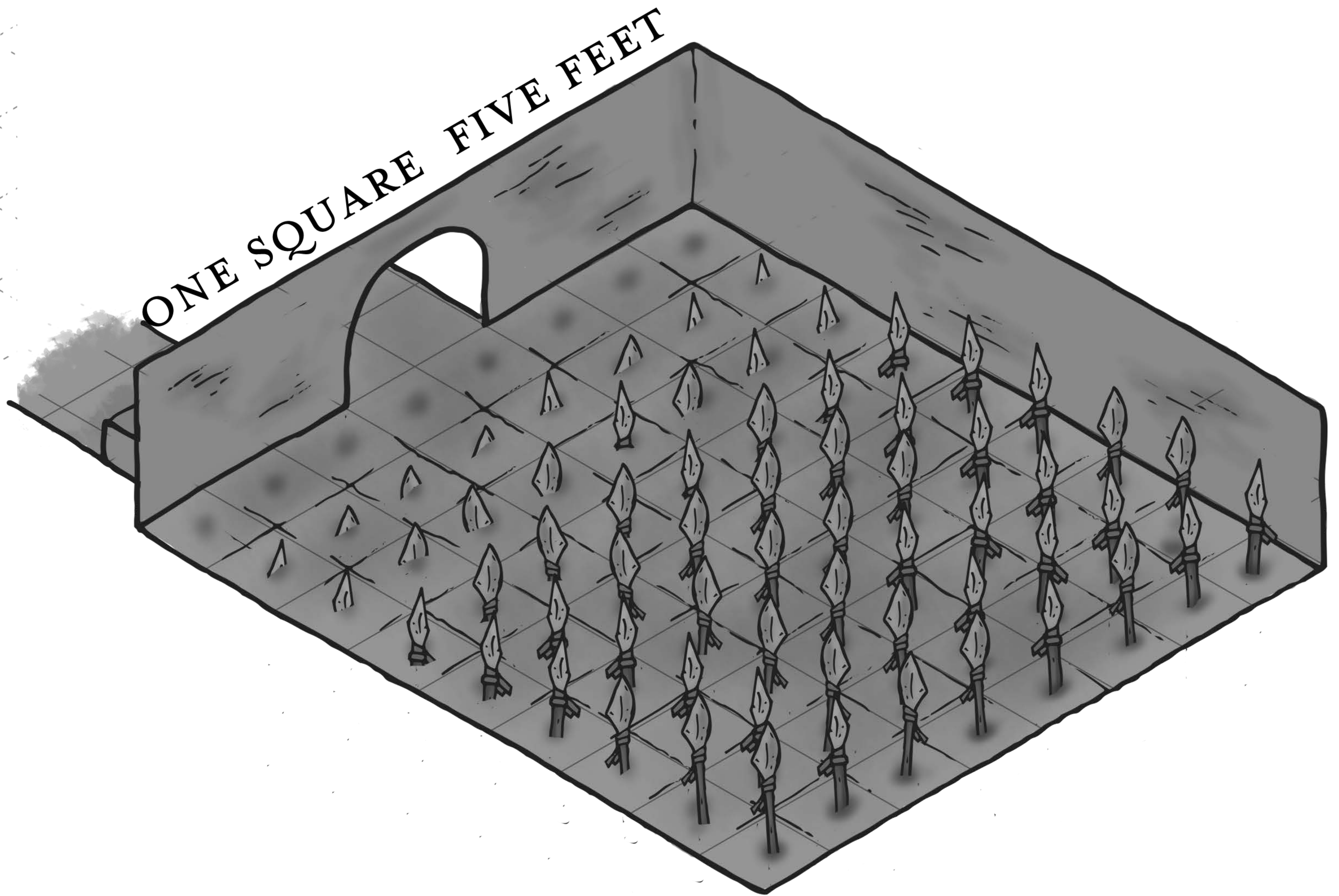

THE MINOTAUR'S BARGAIN: A5

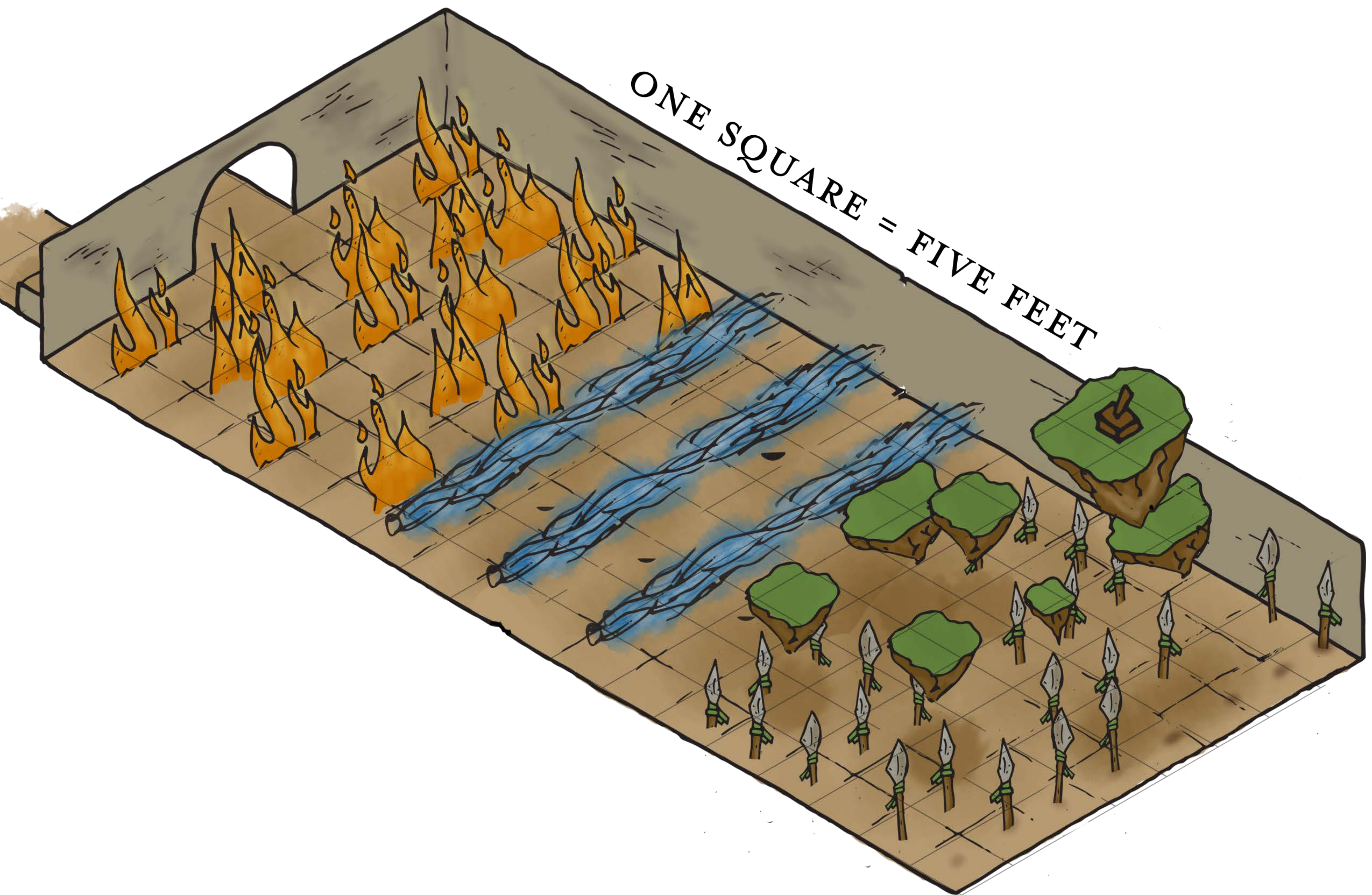

THE MINOTAUR'S BARGAIN: A5

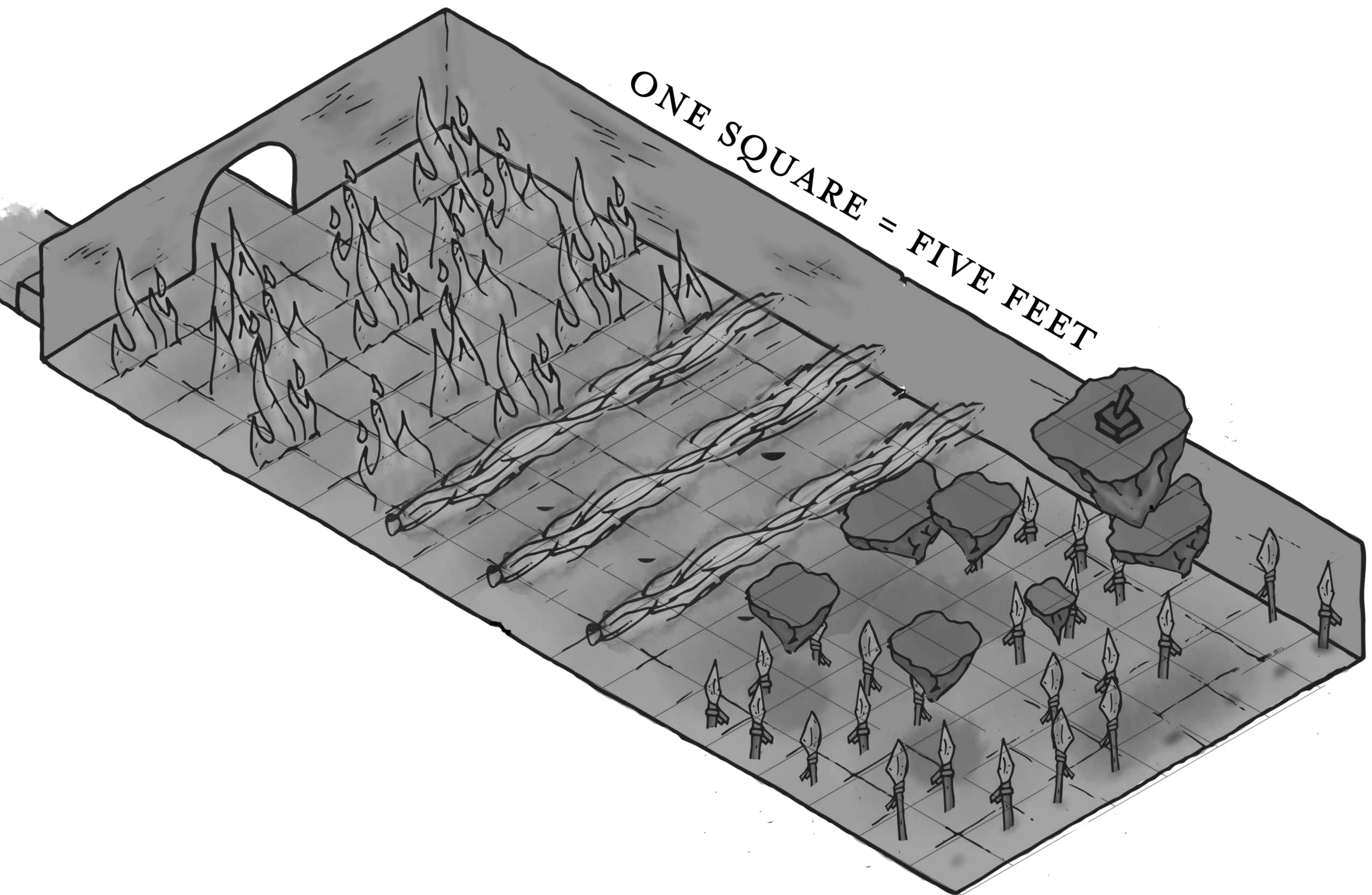

THE MINOTAUR'S BARGAIN: A6

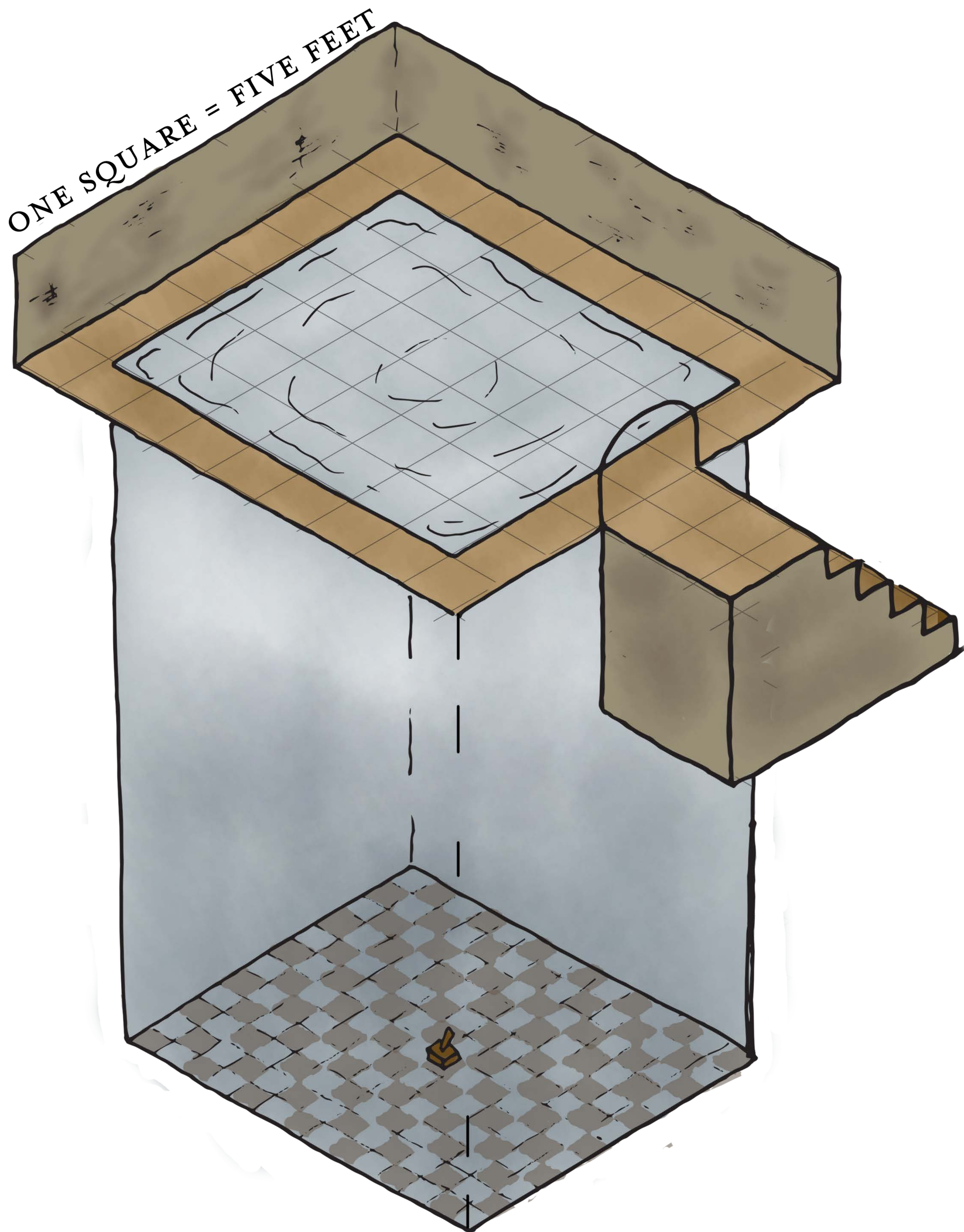

THE MINOTAUR'S BARGAIN: A6

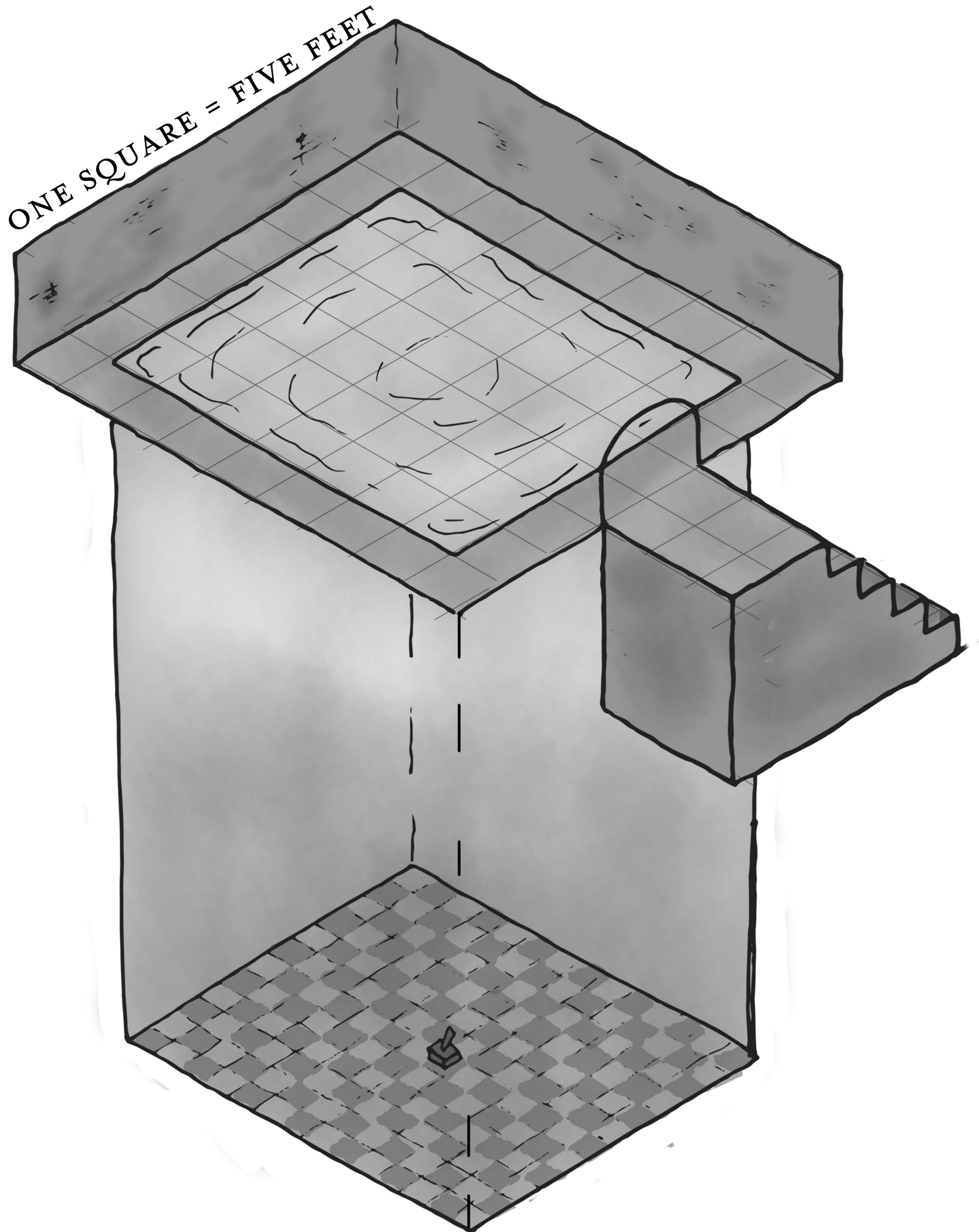

THE MINOTAUR'S BARGAIN: A7

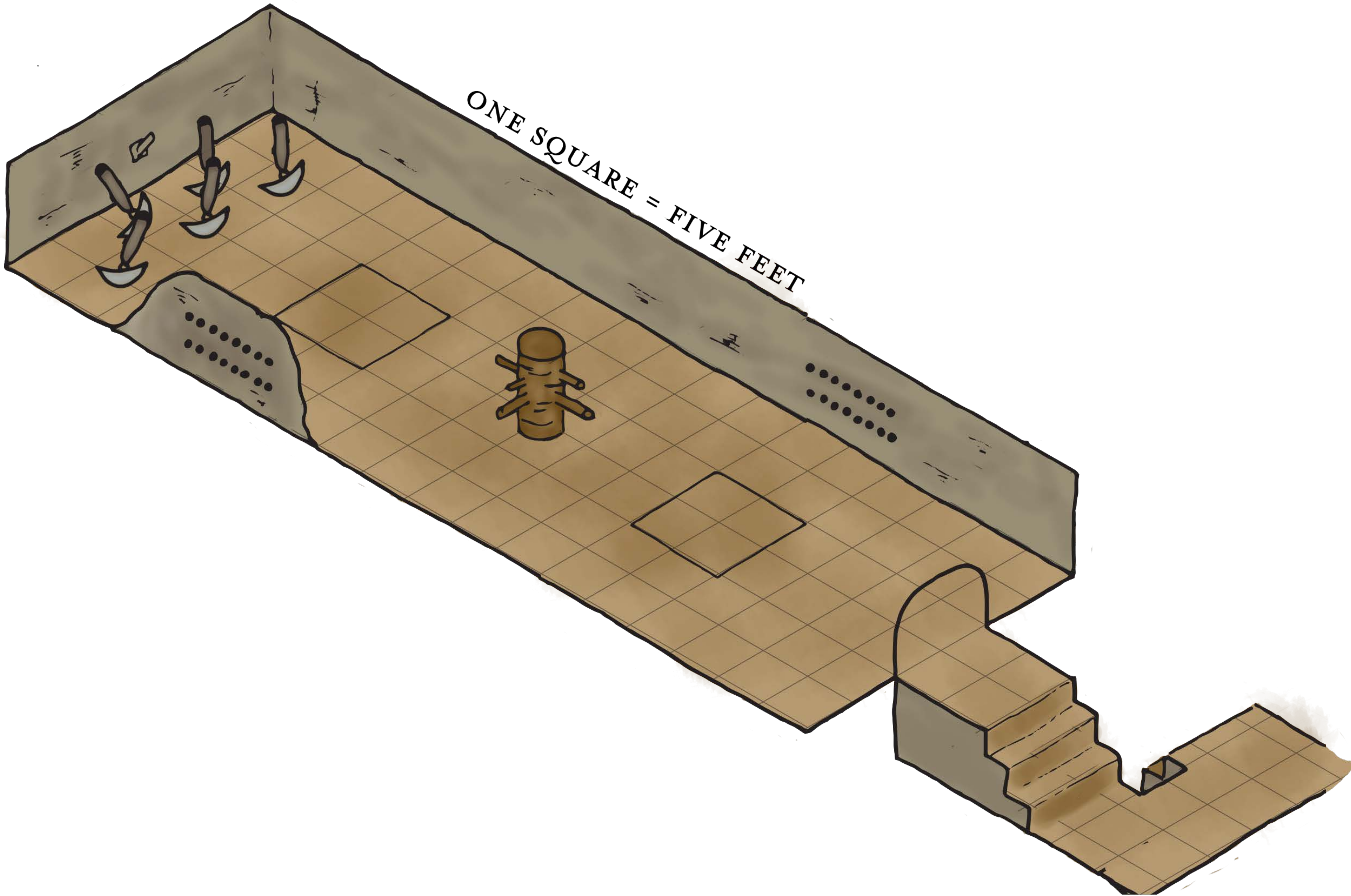

THE MINOTAUR'S BARGAIN: A7

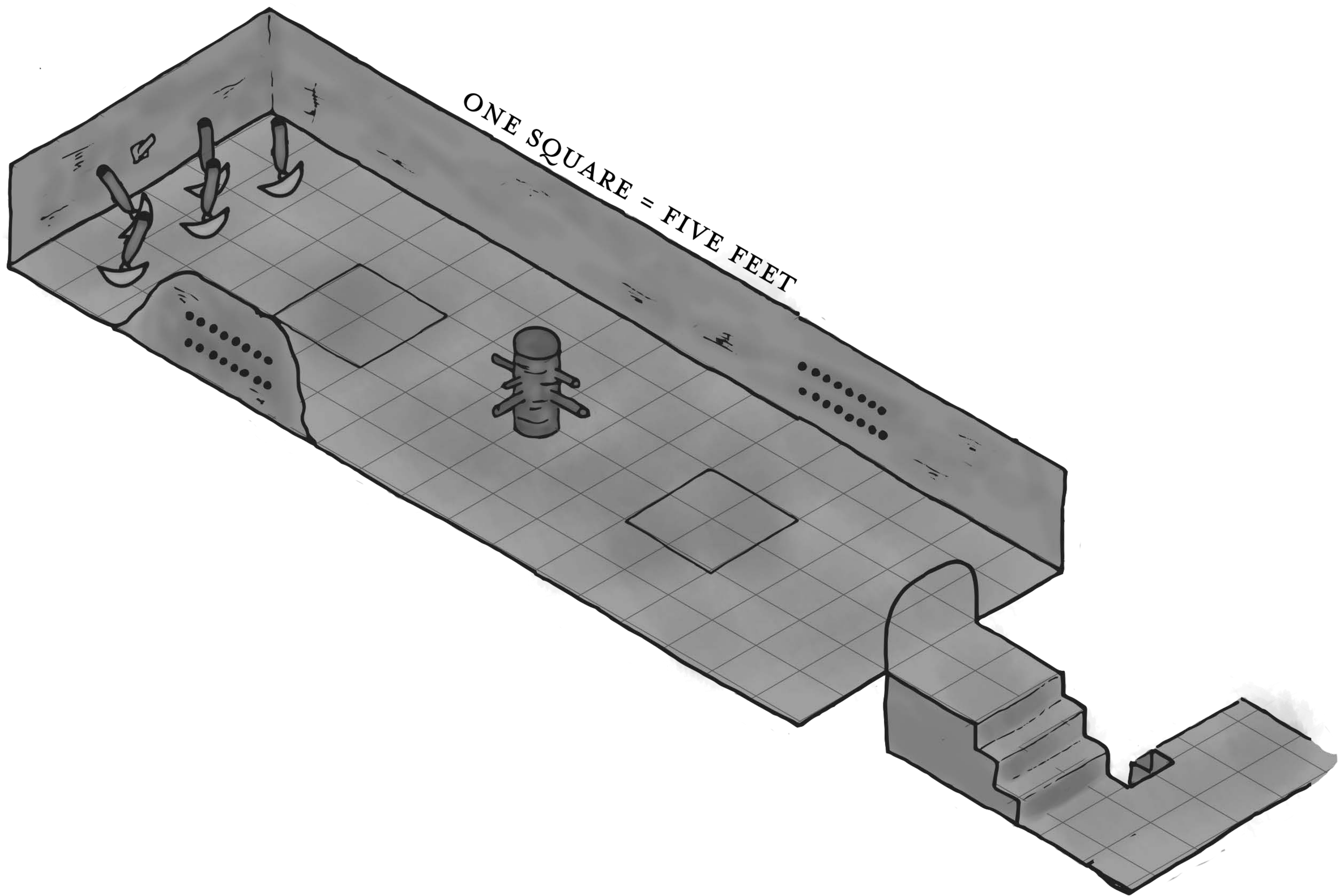

THE MINOTAUR'S BARGAIN: A8

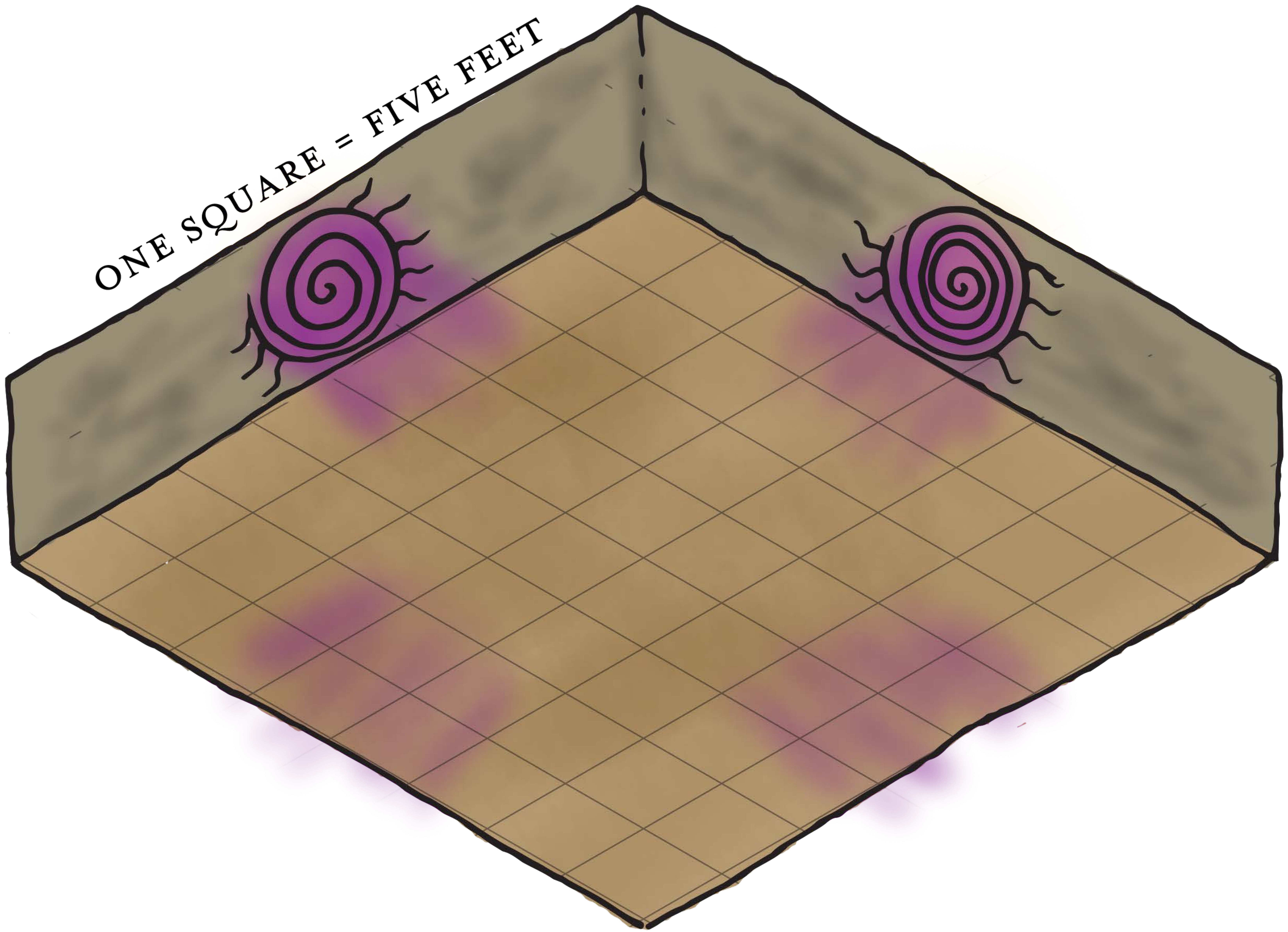

THE MINOTAUR'S BARGAIN: A8

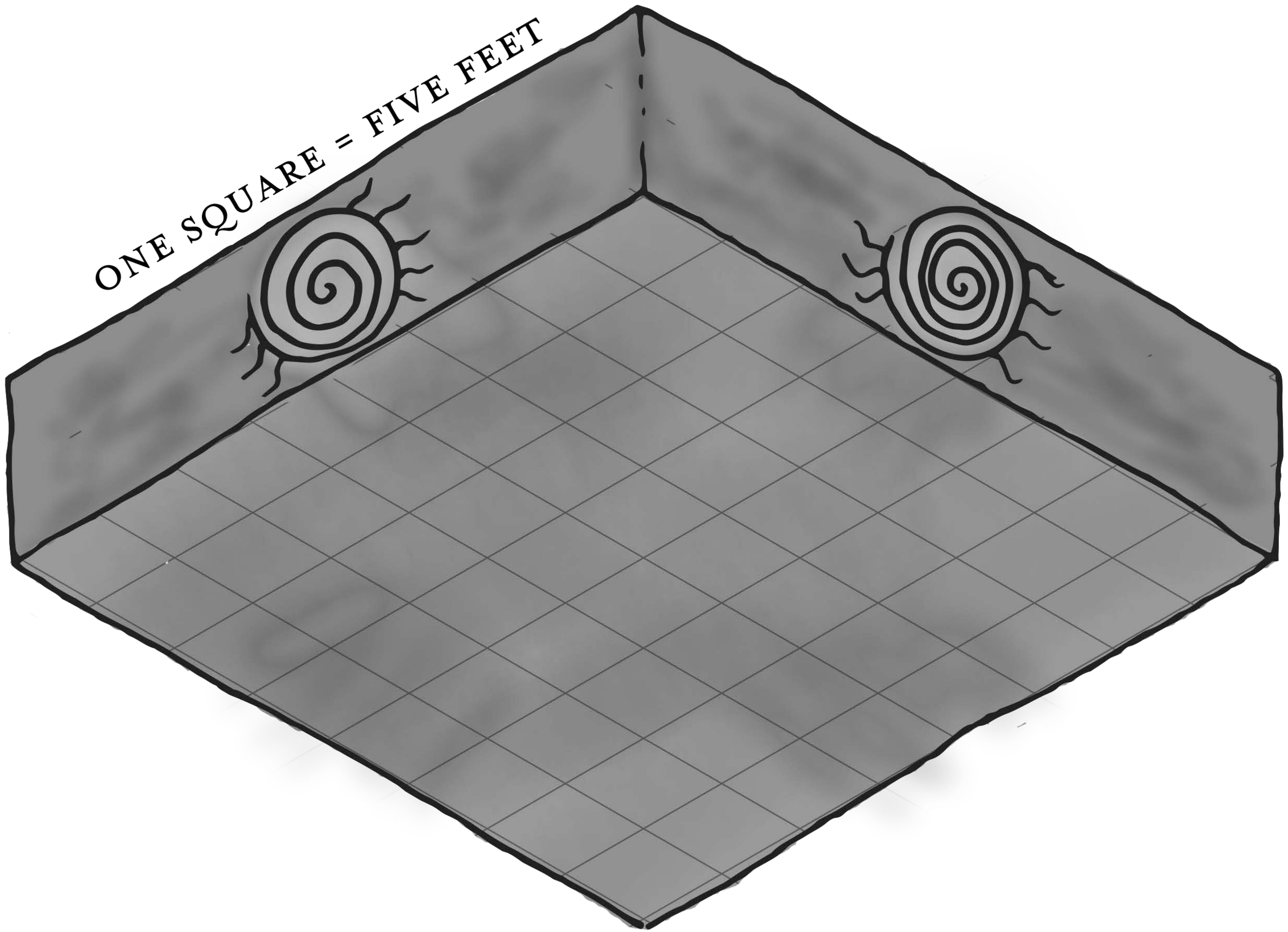

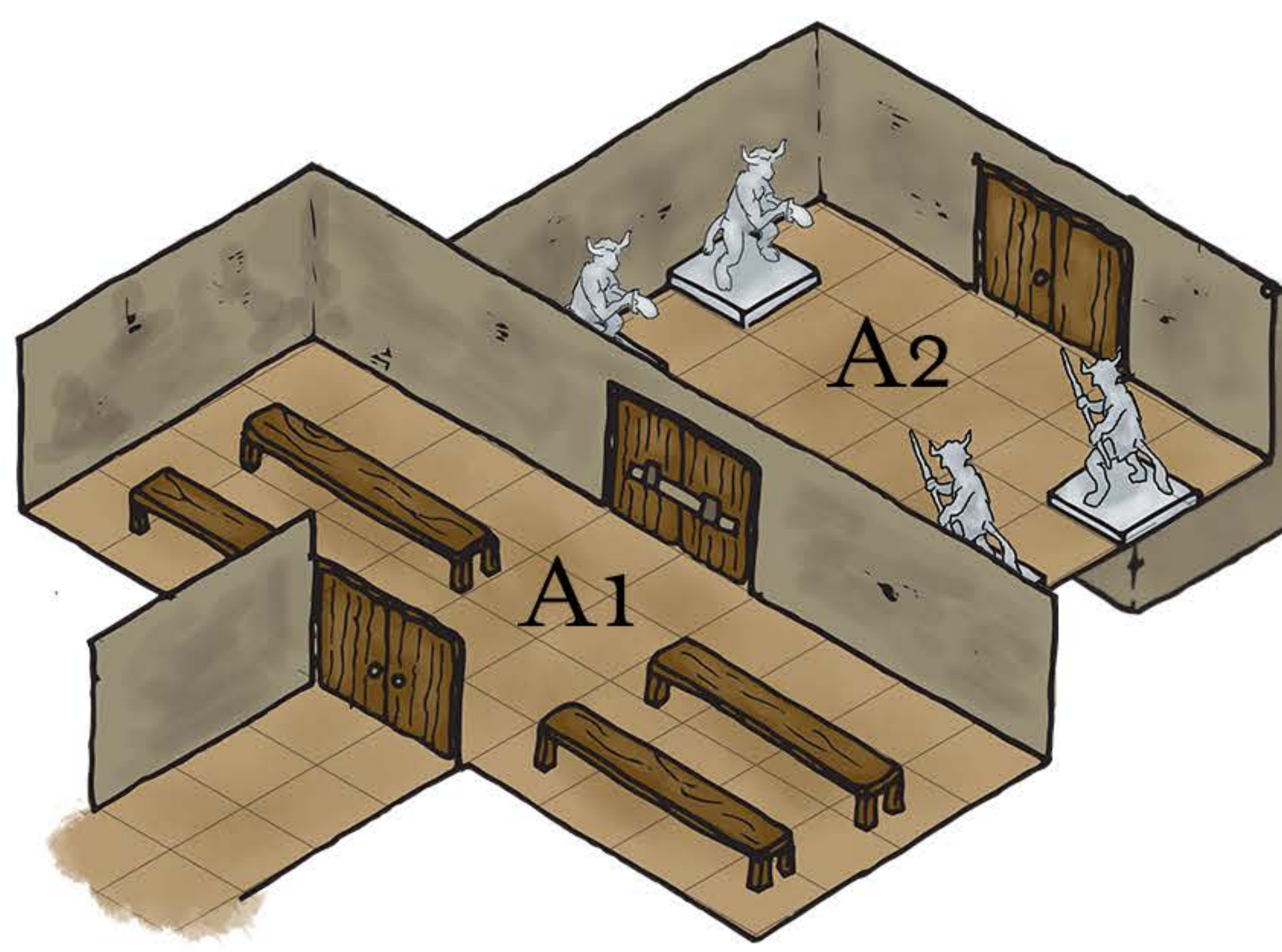
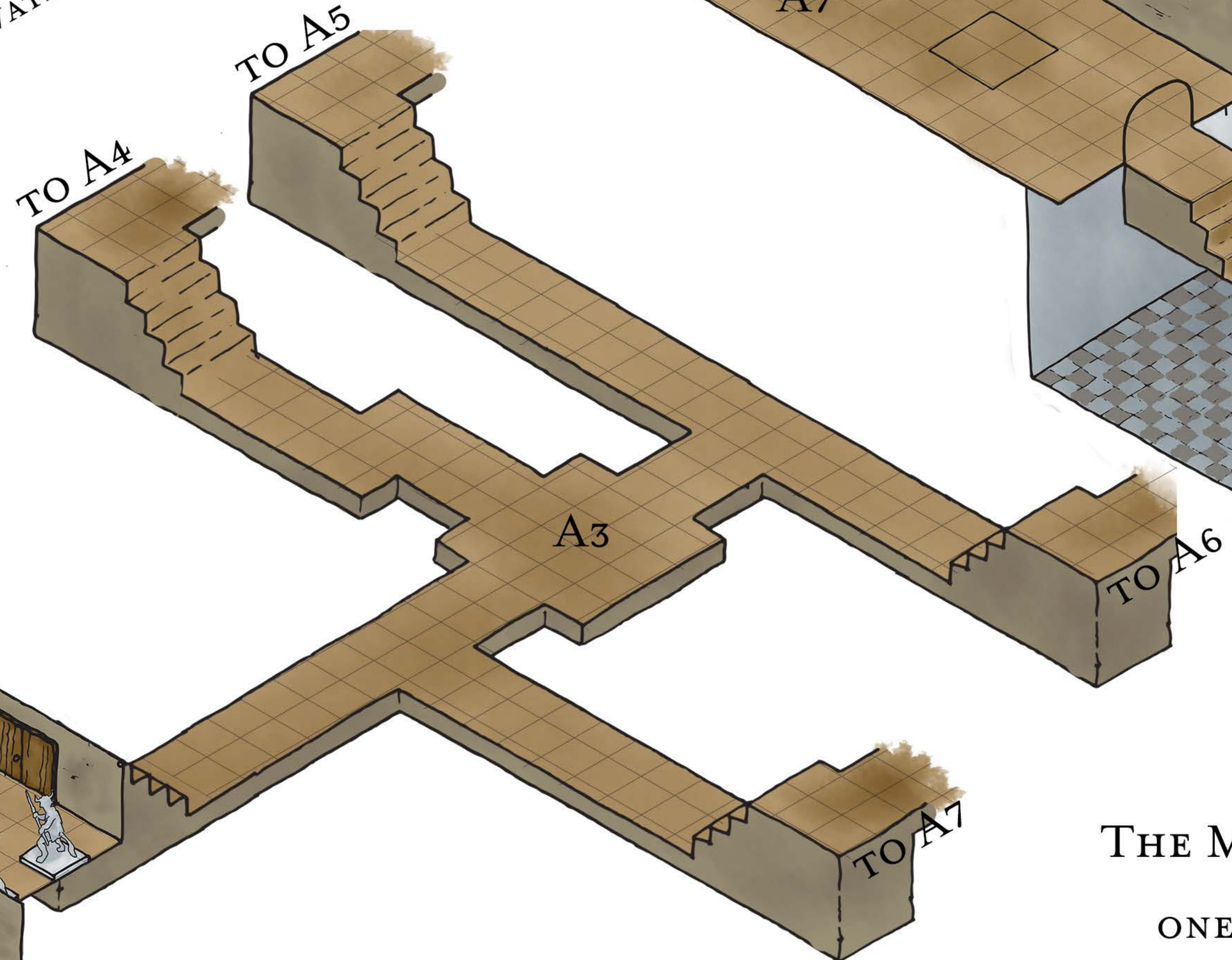
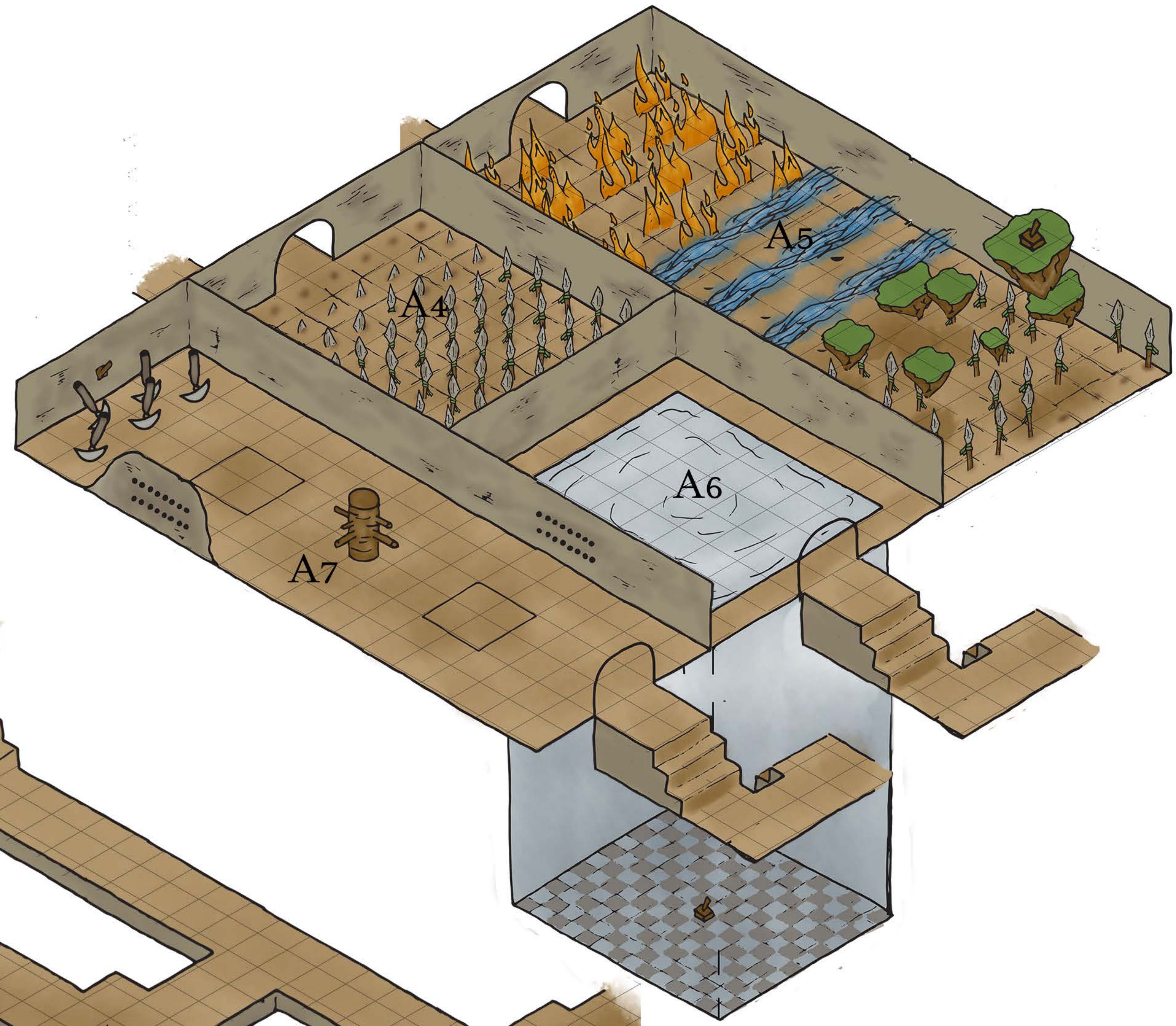
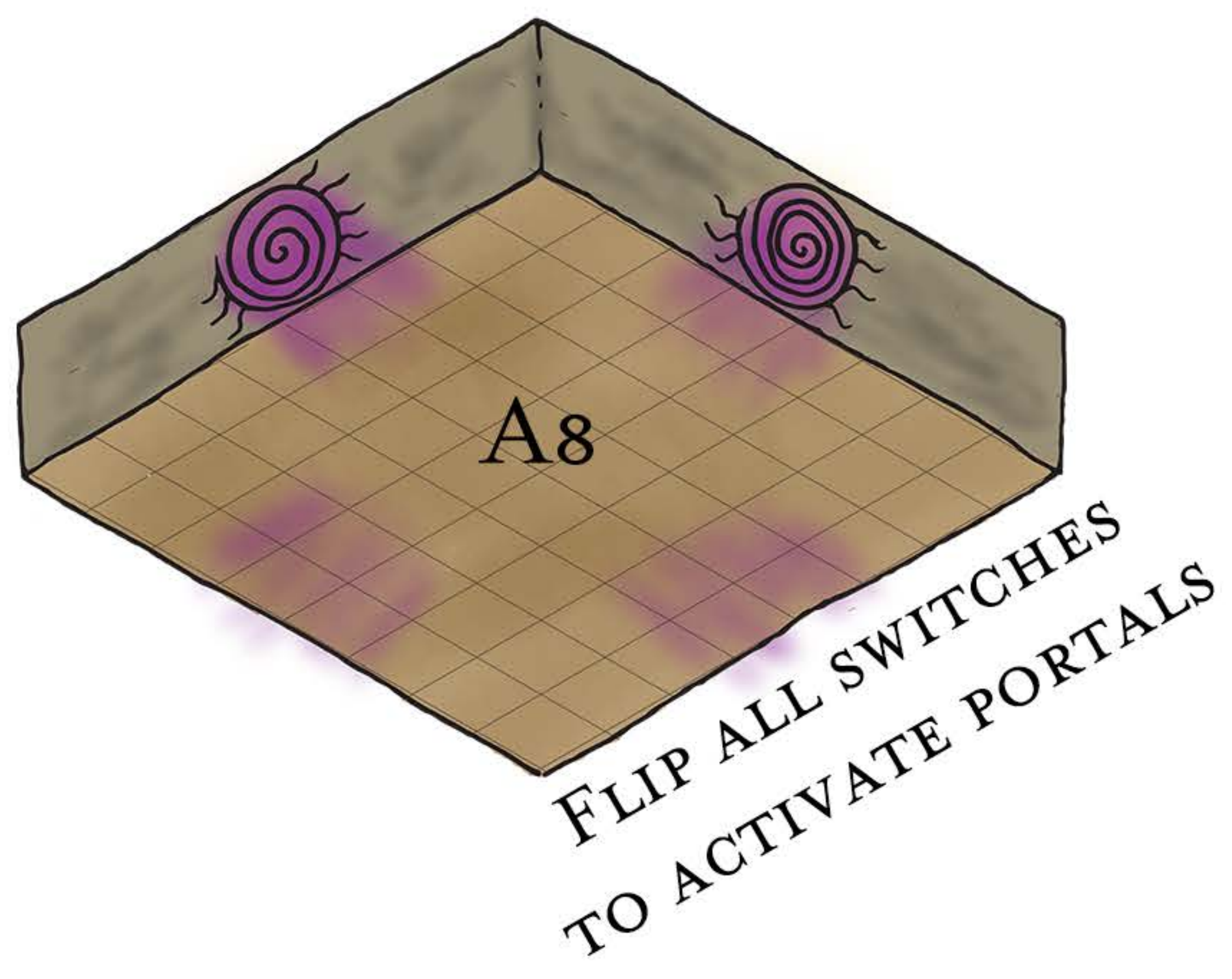

THE MINOTAUR'S BARGAIN

ONE SQUARE = FIVE FEET

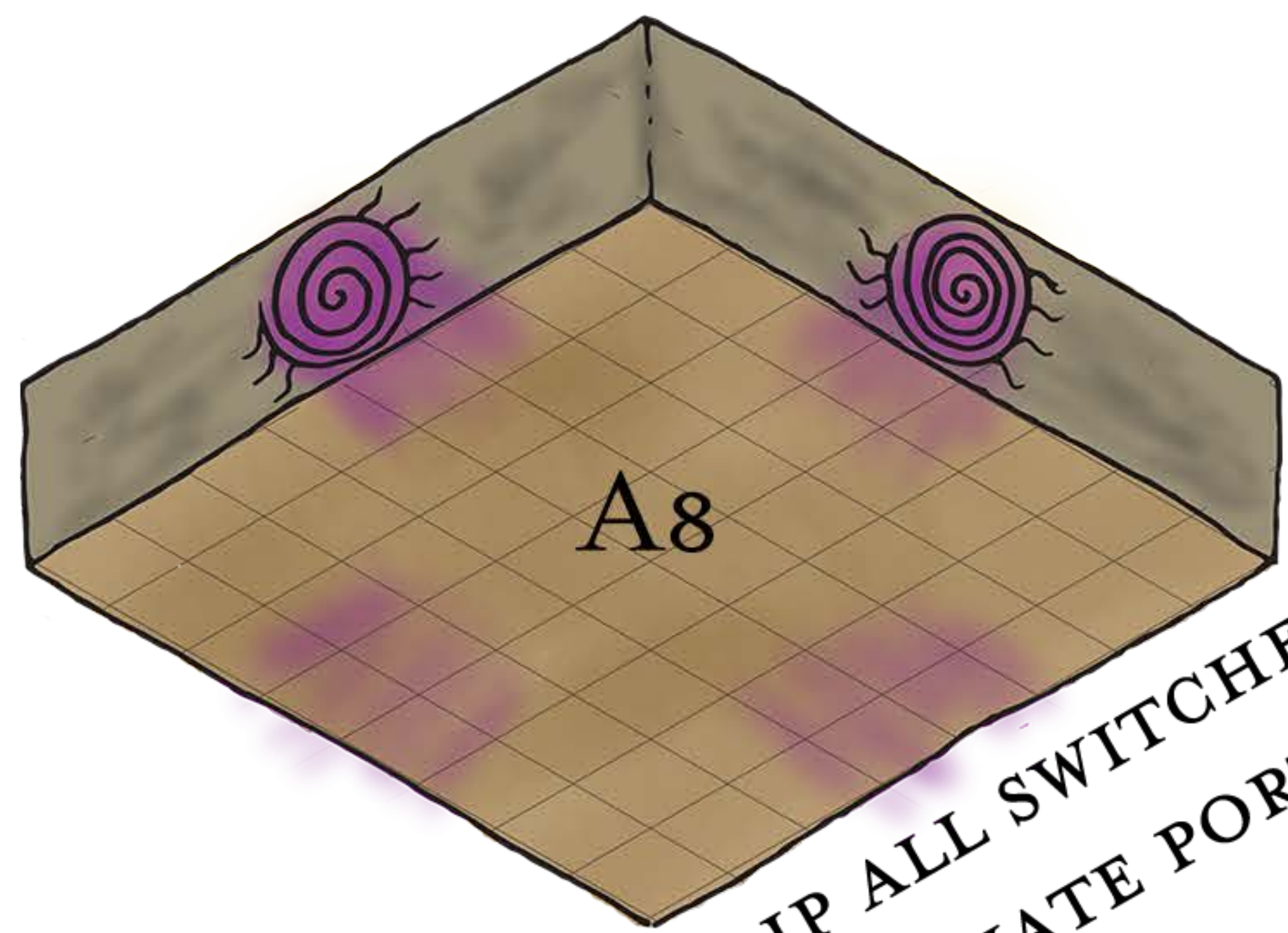

FLIP ALL SWITCHES
TO ACTIVATE PORTALS

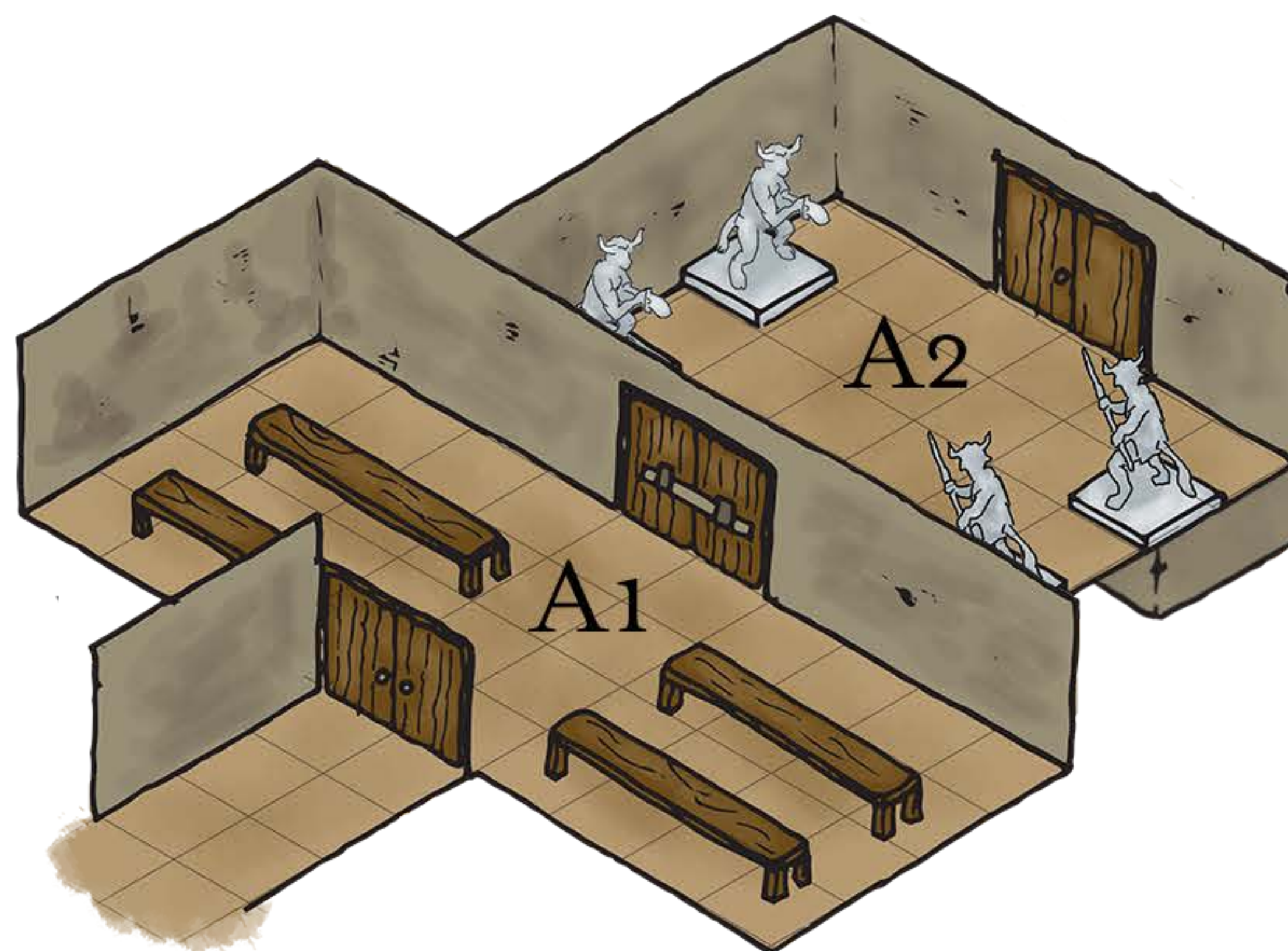
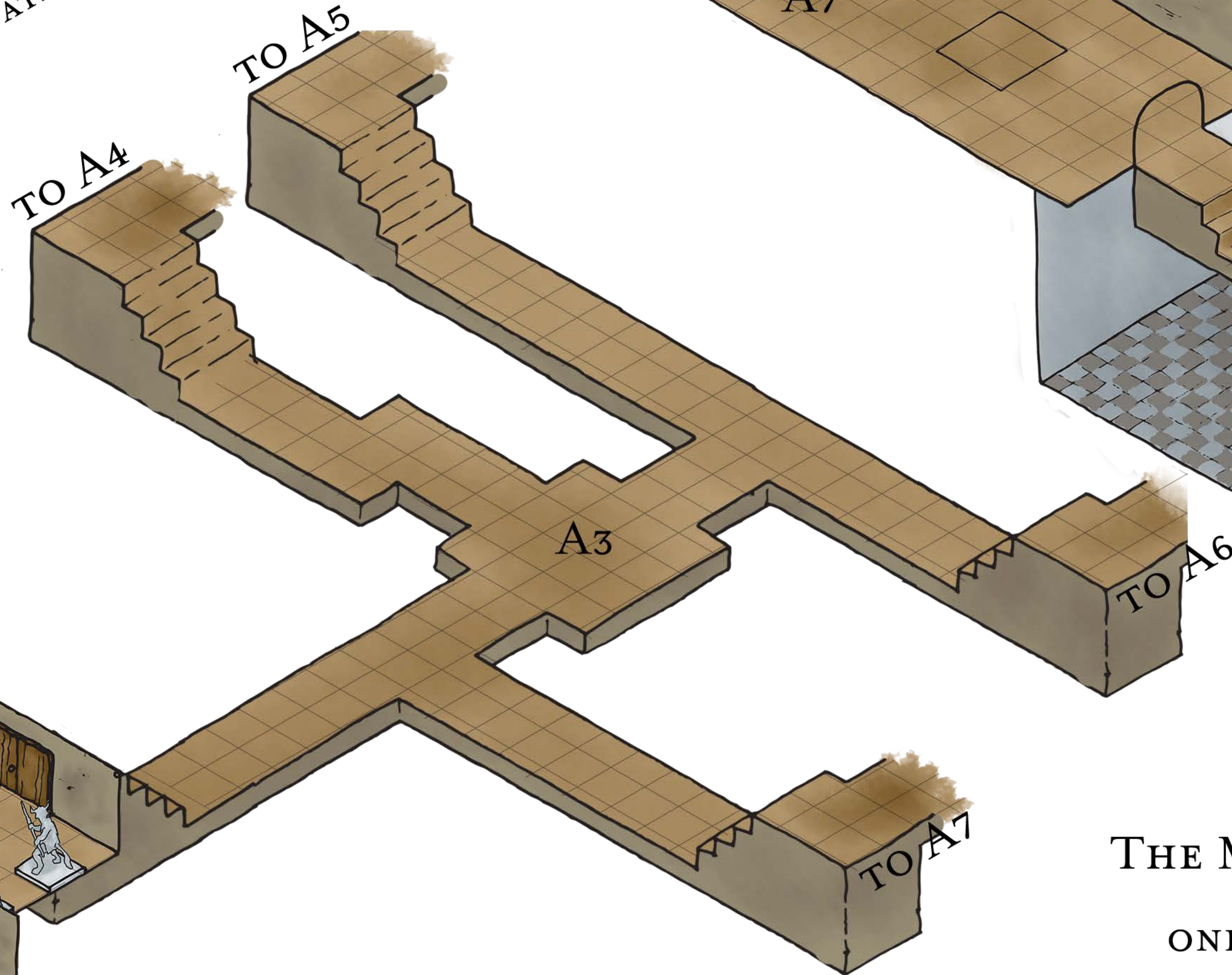
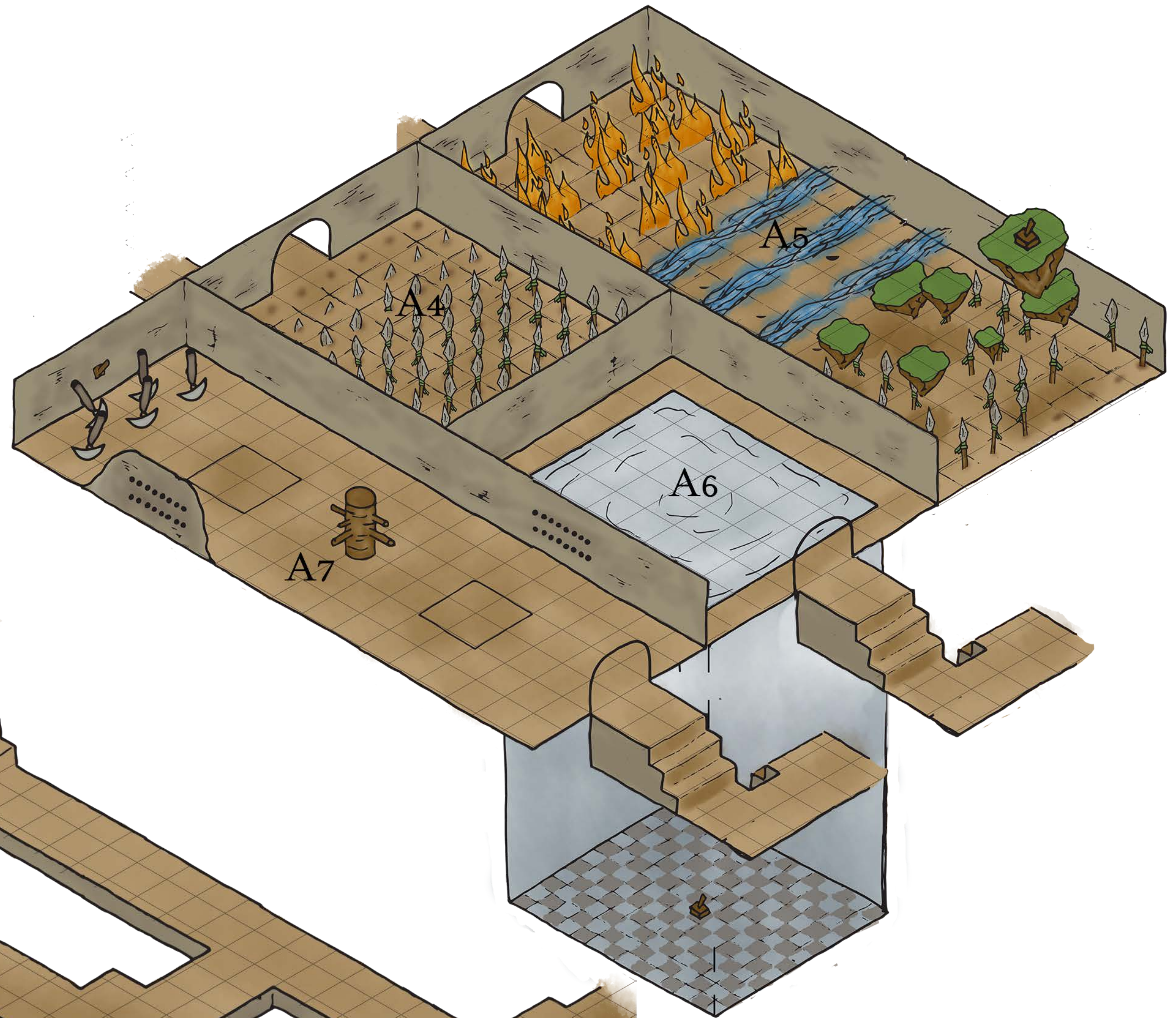

THE MINOTAUR'S BARGAIN

ONE SQUARE = FIVE FEET

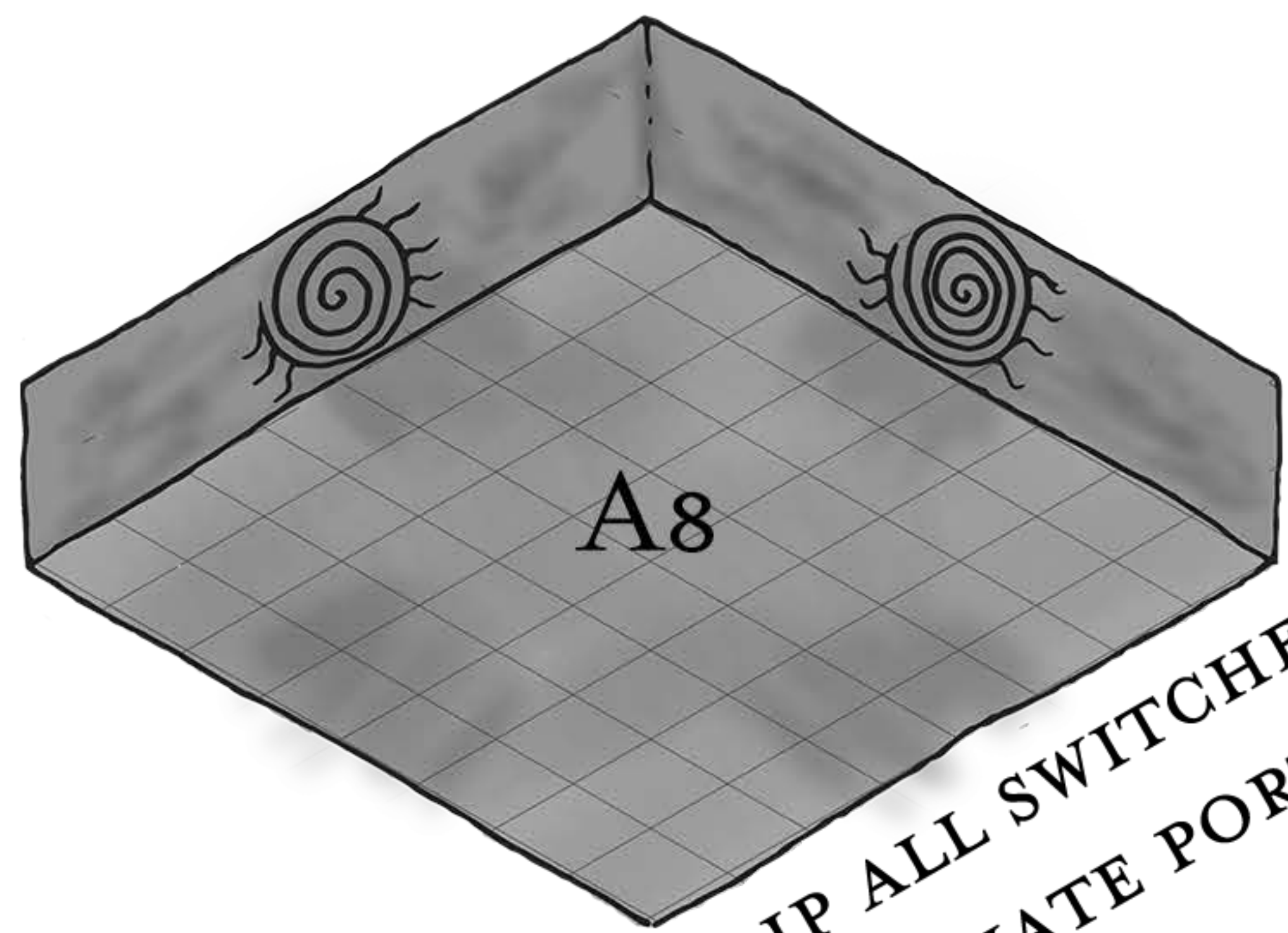

FLIP ALL SWITCHES
TO ACTIVATE PORTALS

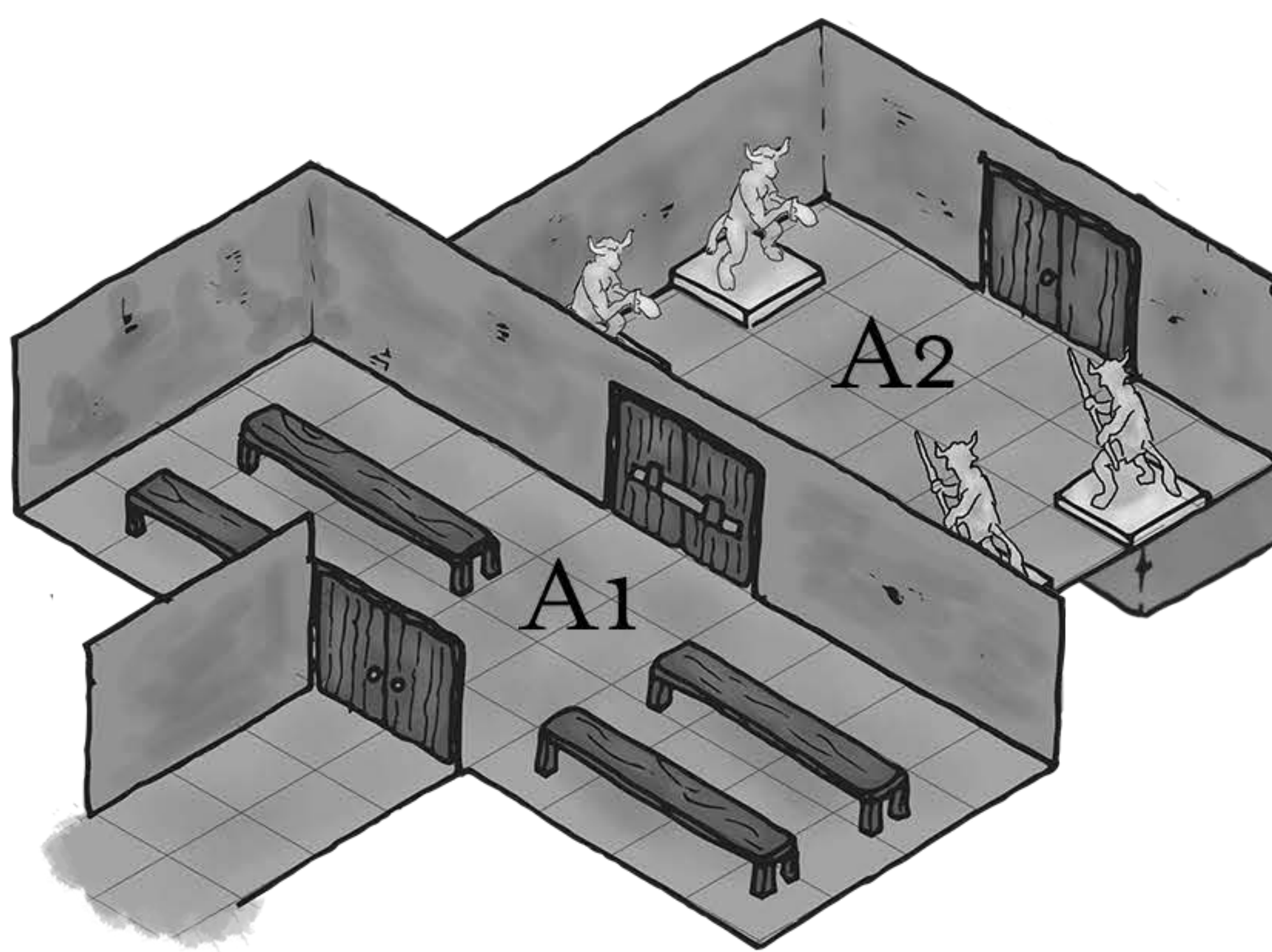
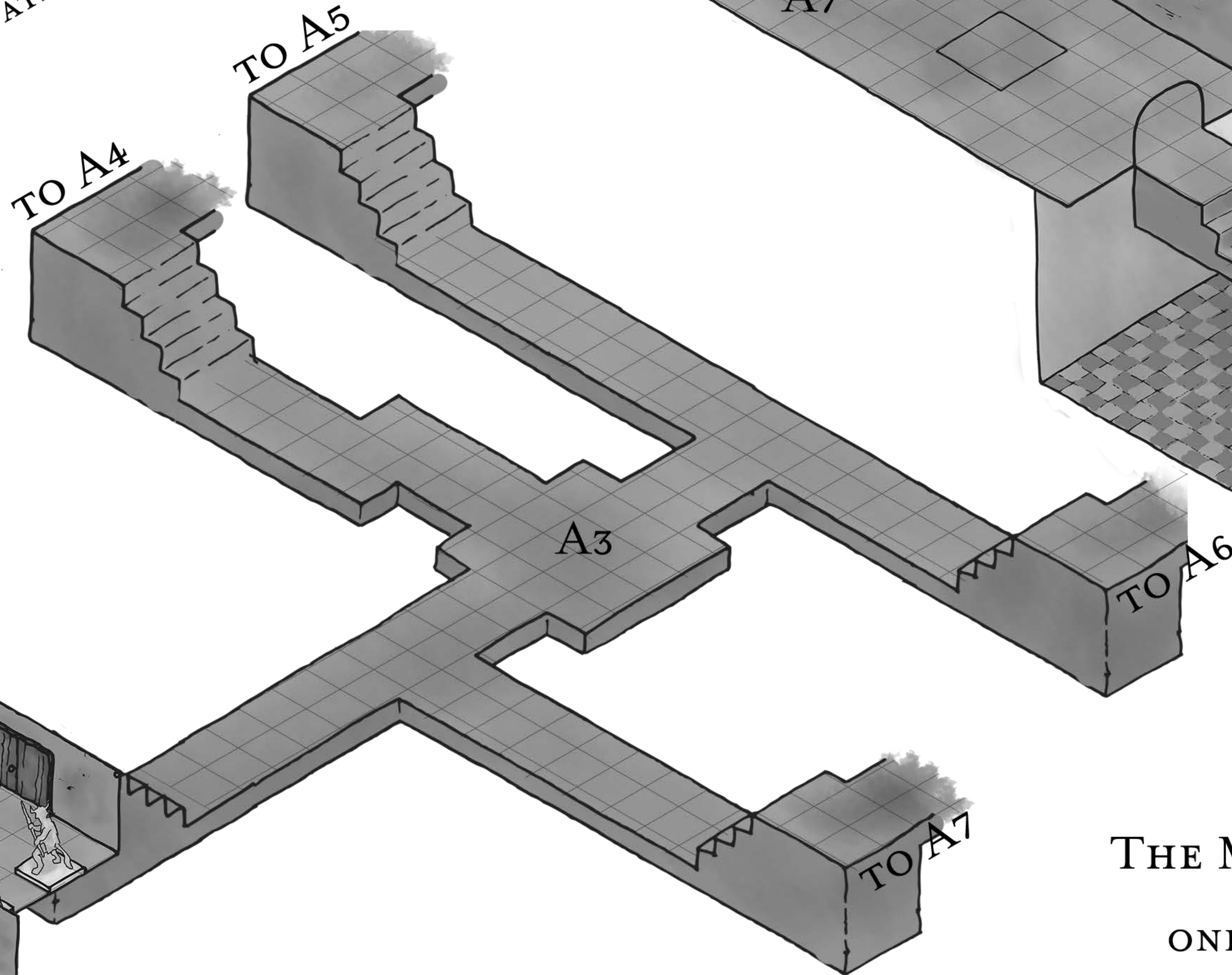
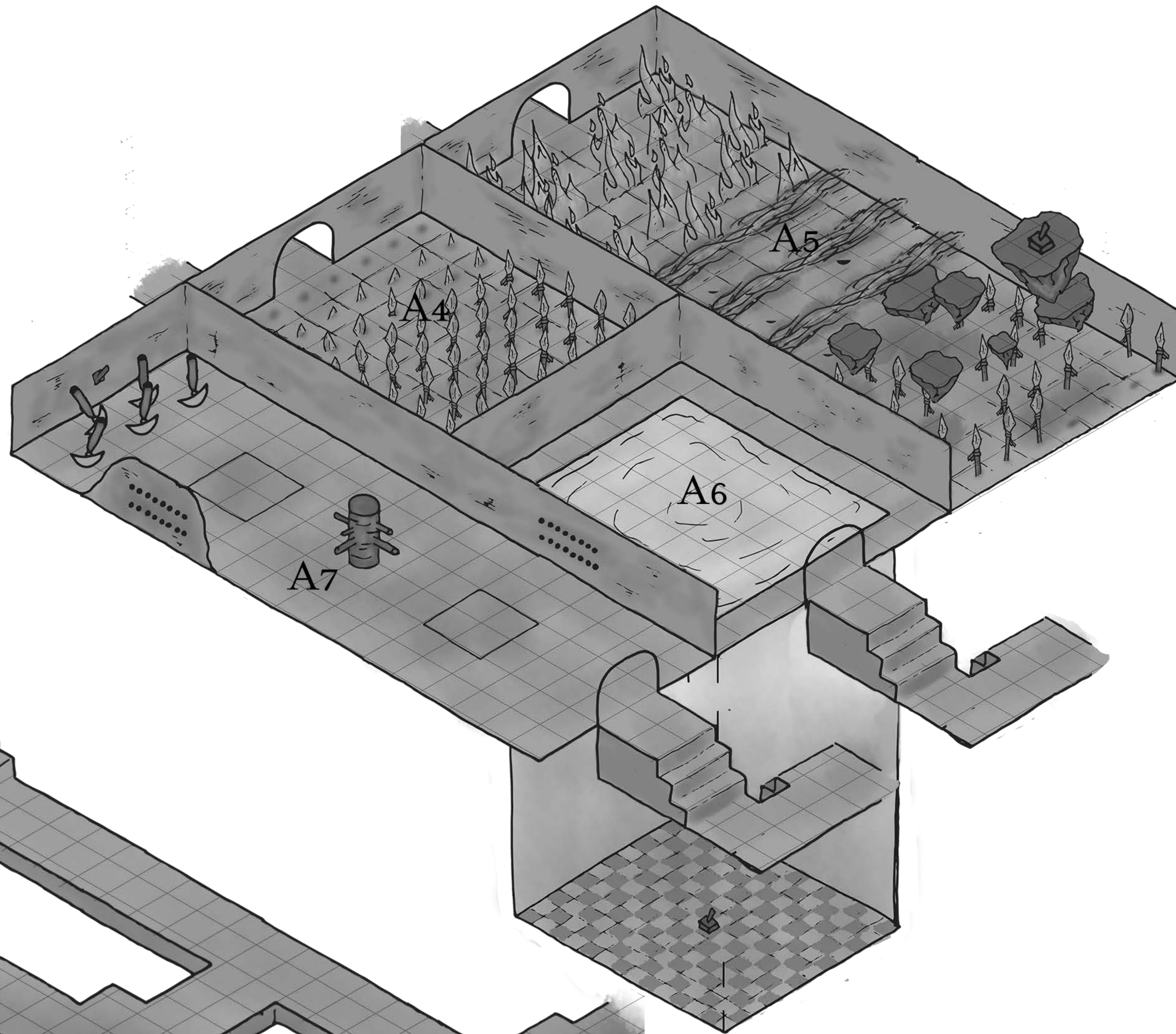

THE MINOTAUR'S BARGAIN

ONE SQUARE = FIVE FEET

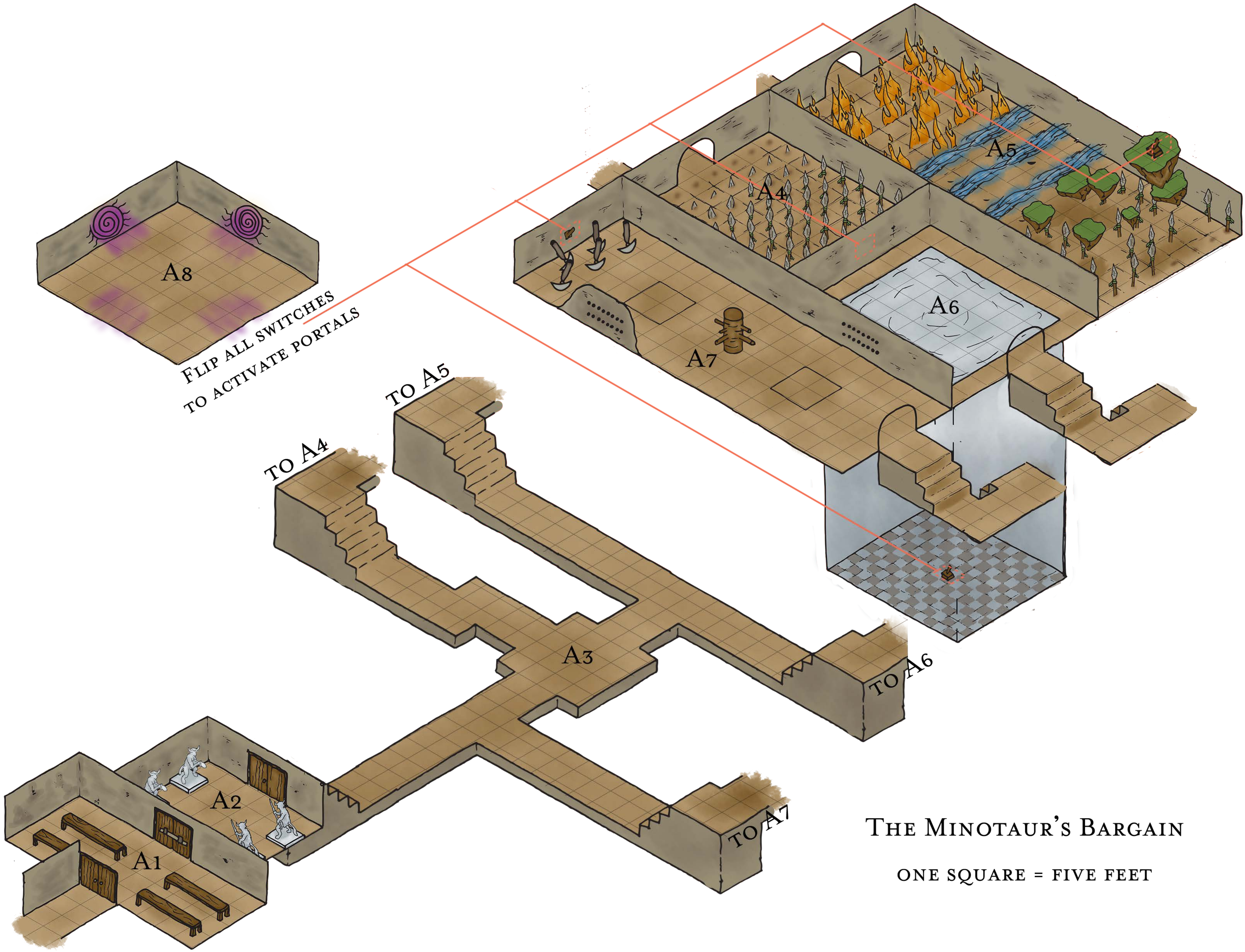

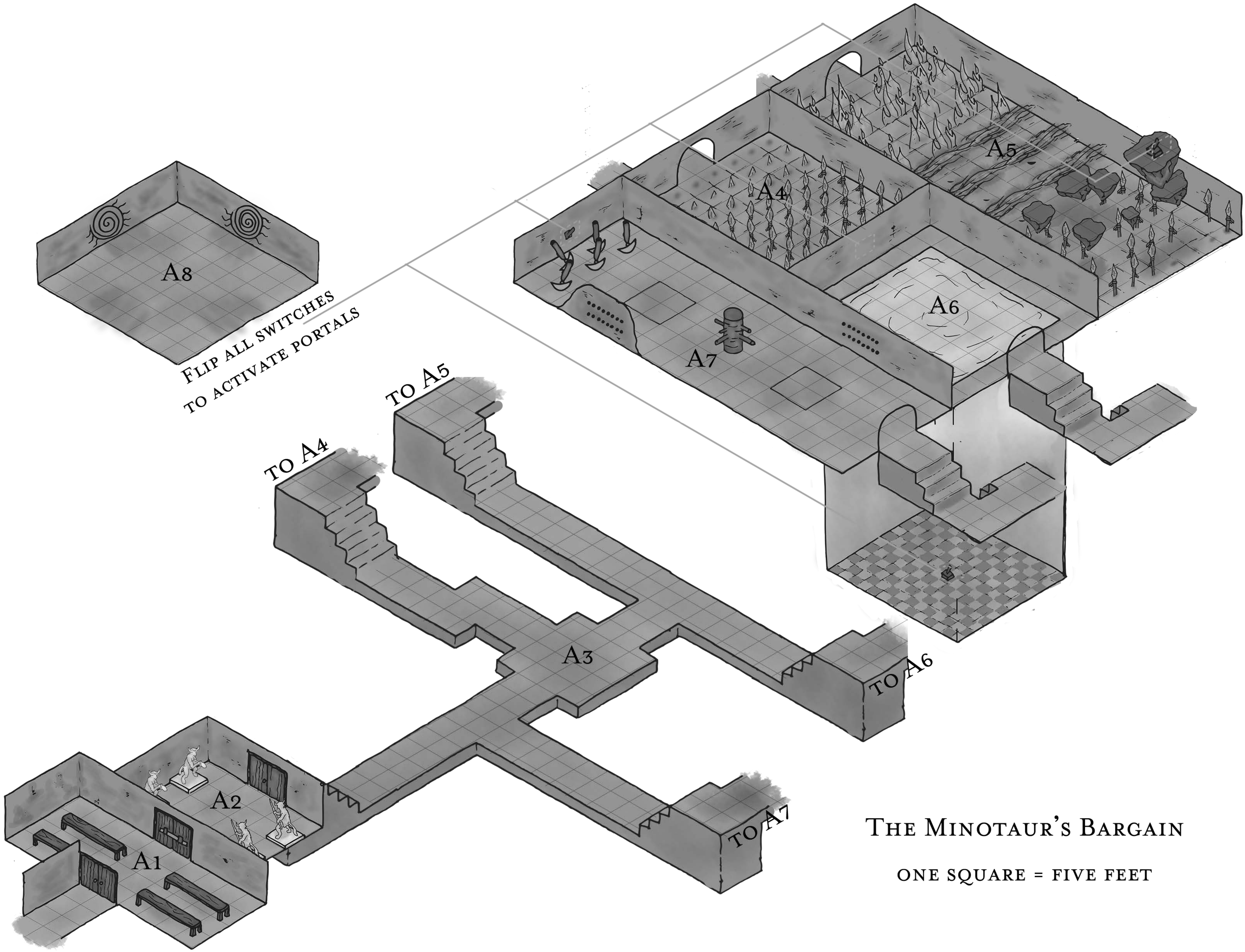

FLIP ALL SWITCHES
TO ACTIVATE PORTALS

THE MINOTAUR'S BARGAIN

ONE SQUARE = FIVE FEET