

EB3



# The Blight

Richard Pett's Crooked City

## EB3: Bloody Jack

Greg A. Vaughan



FROG GOD  
GAMES

# The Blight

Richard Pett's Crooked City

## EB3: Bloody Jack

### Credits

#### Author

Greg A. Vaughan  
Based on original material by Richard Pett.

#### Developer

Greg A. Vaughan

#### Producer

Bill Webb

#### Editor

Laura Sheppard

#### Layout and Graphic Design

Charles A. Wright

#### SE Content Editor

James Redmon

#### Front Cover Art

Felipe Gaona

#### Interior Art

Steve Ellis, Felipe Gaona, Brain LeBlanc, Cara Mitten, Terry Pavlet, Richard Pett, Eric Pollack

#### Photography

Richard Pett

#### Cartography

Robert Altbauer

### FROG GOD GAMES IS

#### CEO

Bill Webb

#### Creative Director: Swords & Wizardry

Matthew J. Finch

#### Creative Director: Pathfinder Roleplaying Game

Greg A. Vaughan

#### Art Director

Charles A. Wright

#### Lead Developer

John Ling

#### Marketing Manager

Chris Haskins

#### Customer Service Manager

Krista Webb

#### Zach of All Trades

Zach Glazar

#### Espieglerie

Skeeter Green



5TH EDITION RULES,  
1ST EDITION FEEL

FROG  
GOD  
GAMES

©2016 Frog God Games.

Compatibility with the Pathfinder Roleplaying Game requires the Pathfinder Roleplaying Game from Paizo Publishing, LLC.

See <http://paizo.com/pathfinderRPG> for more information on the Pathfinder Roleplaying Game.

Paizo Publishing, LLC does not guarantee compatibility, and does not endorse this product.

Pathfinder is a registered trademark of Paizo Publishing, LLC, and the Pathfinder Roleplaying Game and the Pathfinder Roleplaying Game Compatibility Logo are trademarks of Paizo Publishing, LLC, and are used under the Pathfinder Roleplaying Game Compatibility License.

See <http://paizo.com/pathfinderRPG/compatibility> for more information on the compatibility license.



# Other Products from Frog God Games

You can find these product lines and more at our website, [froggodgames.com](http://froggodgames.com), and on the shelves of many retail game stores. Superscripts indicate the available game systems: "PF" means the Pathfinder Roleplaying Game, "5e" means Fifth Edition, and "S&W" means *Swords & Wizardry*. If there is no superscript it means that it is not specific to a single rule system.

## GENERAL RESOURCES

Swords & Wizardry Complete <sup>S&W</sup>  
The Tome of Horrors Complete <sup>PF, S&W</sup>  
Tome of Horrors 4 <sup>PF, S&W</sup>  
Tome of Adventure Design  
Monstrosities <sup>S&W</sup>  
Bill Webb's Book of Dirty Tricks  
Razor Coast: Fire as She Bears <sup>PF</sup>  
Book of Lost Spells <sup>5e</sup>  
Fifth Edition Foes <sup>5e</sup>  
The Tome of Blighted Horrors\* <sup>5e, PF, S&W</sup>  
Book of Alchemy\* <sup>5e, PF, S&W</sup>

## THE LOST LANDS

Rappan Athuk <sup>PF, S&W</sup>  
Rappan Athuk Expansions Vol. I <sup>PF, S&W</sup>  
The Slumbering Tsar Saga <sup>PF, S&W</sup>  
The Black Monastery <sup>PF, S&W</sup>  
Cyclopean Deeps Vol. I <sup>PF, S&W</sup>  
Cyclopean Deeps Vol. II <sup>PF, S&W</sup>  
Razor Coast <sup>PF, S&W</sup>  
Razor Coast: Heart of the Razor <sup>PF, S&W</sup>  
Razor Coast: Freebooter's Guide to the Razor Coast <sup>PF, S&W</sup>  
LL0: The Lost Lands Campaign Setting\* <sup>5e, PF, S&W</sup>  
LL1: Stoneheart Valley <sup>PF, S&W</sup>

LL2: The Lost City of Barakus <sup>PF, S&W</sup>  
LL3: Sword of Air <sup>PF, S&W</sup>  
LL4: Cults of the Sundered Kingdoms <sup>PF, S&W</sup>  
LL5: Borderland Provinces <sup>5e, PF, S&W</sup>  
LL6: The Northlands Saga Complete <sup>PF, S&W</sup>  
LL7: The Blight <sup>5e, PF, S&W</sup>  
LL8: Bard's Gate <sup>5e, PF, S&W</sup>  
LL9: Adventures in the Borderland Provinces <sup>5e, PF, S&W</sup>

## QUESTS OF DOOM

Quests of Doom (Vol. 1) <sup>5e</sup>  
Quests of Doom (Vol. 2) <sup>5e</sup>  
Quests of Doom (includes the 5e Vol. 1 and 2, but for PF and S&W only) <sup>PF, S&W</sup>  
Quests of Doom 2 <sup>5e</sup>  
Quests of Doom 3 <sup>5e, S&W</sup>  
Quests of Doom 4\* <sup>5e, PF, S&W</sup>

## PERILOUS VISTAS

Dead Man's Chest (pdf only) <sup>PF</sup>  
Dunes of Desolation <sup>PF</sup>  
Fields of Blood <sup>PF</sup>  
Mountains of Madness\* <sup>PF</sup>  
Marshes of Malice\* <sup>PF</sup>

\* (forthcoming from **Frog God Games**)

# Table of Contents

---

Introduction.....	Pg. 5
<b>Plot Map</b> .....	Pg. 7
<b>The Spiteful</b> .....	Pg. 8
Chapter 1: The Murder Investigation.....	Pg. 9
<b>Deputies of the Watch</b> .....	Pg. 11
<b>But What About Magic?</b> .....	Pg. 11
Chapter 2: Grindlylow's Grinders.....	Pg. 13
Chapter 3: Hidden Ways of the Sewagers and Ironmongers.....	Pg. 16
Chapter 4: Madam Larua — Teller of Fortunes and Diviner of Secrets.....	Pg. 22
Chapter 5: The Queen's Own.....	Pg. 26
Chapter 6: The Muncy Flat.....	Pg. 31
<b>The Truth of the Crime Scene</b> .....	Pg. 32
<b>Between</b> .....	Pg. 34
Chapter 7: Kechler's Drop.....	Pg. 37
<b>The Ghats and Holy Water Temples of the Great Lyme</b> .....	Pg. 37
Chapter 8: The Bloody Business.....	Pg. 44
<b>The Annual Children's Carnival</b> .....	Pg. 44
<b>The Great Wheel</b> .....	Pg. 46
<b>Won't Somebody Please Think of the Children?</b> .....	Pg. 49
Appendix One: Events in the Blight.....	Pg. 50
Appendix Two: New Monsters .....	Pg. 52
<b>Sough-Eel</b> .....	Pg. 52
<b>Spite-Waif</b> .....	Pg. 53
Appendix Three: Player Handouts.....	Pg. 54
Map Appendix.....	Pg. 65
Legal Appendix.....	Pg. 78

# The Blight

Richard Pett's Crooked City

## TB3: Bloody Jack

By Greg A. Vaughan



*“...You’ve just entered the wrong side of town...”*

*Bloody Jack* is a 5e adventure designed for a party of four to five 5th-level PCs. It serves as a companion adventure to Richard’s Pett’s *The Blight* and takes place in that twisted city as revealed in the campaign setting published by **Frog God Games**.

# Introduction

**B**loody Jack Carver  
Went down to the harbour  
Taking some children to play.

An eel popped up its head  
And ate them instead,  
While Jack tip-toed away.

— Children’s Rhyme from the *Blight*

Life is hard on the streets of the Blight, and no harder, perhaps, than for the children of the city. When danger is real enough for the fully grown who are able to defend themselves and are jaded to its terrors, it becomes a waking nightmare for the weak and innocent. Yet the children of the city are not without warning. They learn of the dangers even while in their cradles as their nursemaids sing them to sleep with silly rhymes — rhymes that speak of atrocious things that are only all too real. And every child knows the songs of Bloody Jack.

The City-State of Castorhage, known as the Blight to visitors and many of its residents, is an ancient city of Akados dating back to the early days

## Warning!

This adventure contains mature themes that may not be suitable for some readers or players. As mentioned in the ad materials and introduction to this adventure, it explores the mystery surrounding a serial killer that singled out children thirty years ago and works to prevent him from starting his killing again. For thousands of years, human folklore has explored the dire consequences that await “naughty” children or those who do not heed the advice of their parents and elders. From *Hansel and Gretel* and *Little Red Riding Hood* to *The Boy Who Cried Wolf* we have seen that children have not been spared from the horrors of adult life, and more often than not the stories involve some bogeyman that specifically targets such children for its depredations. This adventure brings that concept to life as it explores the long-term ramifications upon a populace when just such a bogeyman is real (in the form of Bloody Jack) and gives the players the opportunity to thwart just such a threat.

Our purpose at **Frog God Games** is not to make tasteless products for the general public that would be classified as “adult content,” offensive, or inappropriate for minors. But we do intend to make thrilling adventures in the style of old-school game play that test the players’ stalwartness and bring difficult and layered nuances to their game. Simulating and navigating the struggles of real life (and/or their fantasy equivalent) with exceptional powers and skills as characters while freeing players of the prospect of actual consequences is one of the great draws of roleplaying games, and we always strive to create that experience in our products.

As the father of young children who play roleplaying games, I would probably not allow them to play *Bloody Jack*, or even other products from *The Blight* for that matter. These products are darker in theme and maturity, and **Frog God Games** provides many other titles much more suitable for young gamers. However, as my children reach their teenage years, I would not hesitate to let them delve into the world that is *The Blight* and will happily discuss with them the intricacies of life and decision making that the campaign entails while enjoying the thrill of the creepy horror movie vibe that it brings to their game.

of the Hyperborean Empire. Long viewed as a centre of learning and scientific advancement, it eventually fell to its own hubris and corruption, becoming the hive of terror and foulness that it is today.

Despite the rampant villainy of the city and the terrors that haunt its nights, it remains, ostensibly at least, a bastion of civilization, and its citizens go about their mundane (if somewhat precarious) existences preferring to ignore the constant dangers of their day-to-day lives and the dark goings-on that stalk its benighted streets. A stout bolt on the door and a penchant for minding one’s own business are necessities for survival. This adventure gives only a glimpse into the dark glass that is the Blight and provides players with their first introduction to the place. For further information, see *The Blight: Richard Pett’s Crooked City* from **Frog God Games**.

*Bloody Jack* is a plot-based adventure but it is different in that it doesn’t follow a linear plot. As an ongoing mystery, the PCs control the direction of the plot based on which clues they find and which leads they choose to follow. While all of the plot points lead to the same finale, there are multiple ways that this finale can be reached as the individual plot points can be discovered in varying orders. As a result, each major plot point is given its own chapter. The beginning of each chapter has a short summary at its beginning that lists the means by which the PCs can have reached that point (what clues and plot points they must have already experienced), as well as which clues can be gained in that chapter and which plot points can be accessed from there. These convenient summaries provide you as the GM all the information you need to reach that portion of the adventure and all the information that can be gleaned from it to move on.

In addition, **Appendix I** contains information for developments that occur to advance the plot behind the scenes and involve the PCs without having them go anywhere or do anything specific. They occur based on the elapsed time of the adventure and what the PCs have done up to that point.

## Adventure Background

### The History of Bloody Jack Carver

William Hughe — Bill to any friends he might have had, if he’d had any friends — was never the most stable of individuals. If anyone had really known him, most would have thought him twitchy or perhaps a bit “touched”. However, his change from simply unstable to a violent sociopath can be traced to a singular incident — the last legs of his sanity were swept from beneath him on the night that we first saw a spite-waif.

Bill Hughe was a tinker by trade, working the endless corridor-alleys of East Ending, sharpening knives and repairing kettles and crocks for the goodwives and labourers of that district. He pushed his cart from custom to custom delivering repaired goods, picking up new assignments, and completing the occasional on-the-spot repair for an extra copper farthing or present from the corner-doxies. Such rounds as these often kept him out on the streets until after the relatively safe hours of daylight had passed, and he hurried home to his own hovel and shop through lengthening shadows and gathering horrors as night stalked across the city.

One such evening, Bill found himself and his little cart far from home, at the servants’ entrance of the townhouse of one Thaddeus Deudermont, Esquire, Barrister of the Commons. On this evening, Goodwife Trumella had left him waiting at the doorstep for a considerable amount of time as he anxiously watched the red rays of the sun beam through the alley, dancing with a thousand motes of soot and dust. Finally, as the first stars began to appear in the purpling dusk, his cringing coward’s heart made a decision it had never come to before, a sea change in the life of the tinker: He pushed open the door and stepped into the scullery. Finding it abandoned, and with no sounds of habitation on the first floor, he climbed the labourers’ stair thinking he had heard the sound of movement on the

## THE BLIGHT: RICHARD PETT'S CROOKED CITY

floor above. Coming to the back landing, he cautiously made his way past the dark and empty servants' stations towards the only light in the house, coming from a doorway at the front. The door into the parlour was ajar, and gave off the glow of candlelight from within. Listening at the door revealed that the subtle scrape of movement came from within, along with the clear, undisturbed sound of steady breathing.

Taking his cap into his hand and knuckling his sooty forelock, Bill stepped through the door thinking to humbly beg the missus' pardon and remind her might she not have some small task for him to take care of for her. Instead, what Bill Hughe found stopped him in his tracks: the Goodwife Trumella was sprawled on the floor. Her husband, the jurist, sat slumped in an over-stuffed chair. At first he thought he had come upon the scene of a foul murder and was about to make for the back door with all speed when he realized that the breathing he had heard was theirs. The Deudermonts were inexplicably both in the midst of a deep sleep.

Bill was just considering the possibility of taking advantage of this fortuitous situation to pilfer some small item when the scrape of movement he had heard before caught his attention again. His eyes were drawn to the narrow side door that led into the nursery of the townhouse. There in the darkened nursery, just visible through the partially open door, stood the cradle of little Marjory Deudermont, the light of Thaddeus' and Trumella's lives. He could just make out the shape of the baby's pudgy legs as they kicked in the air, as babies are wont to do, and he watched in horror as the cheval glass mirror standing behind the crib finished sliding open like a window pane — making the scraping noise he had heard. Crawling out from the strange nothingness beyond the mirror's image came a tiny form, the spitting image of the baby in the crib but moving strangely on all fours as if it had too many joints — like some kind of insect. The spite-waif — for that is what it was; a hideous changeling from Between — grabbed Baby Marjory by a leg and then, horribly distending its jaw like a serpent, swallowed the baby in a single gulp. It then glared malevolently at poor Bill Hughe, standing there aghast, before closing the pane of the cheval glass mirror and assuming the late baby Marjory's position in the cradle.

At that moment, both Master Thaddeus and Goodwife Trumella moaned softly and began to stir to consciousness.



Bill knew no more for a long while. When he once again recognized his surroundings he was covered in sweat and back in his little hovel, sharpening a great, serrated fisherman's knife. Bill had seen the changeling replace the Deudermont baby. He knew that spite-waifs were loose in Castorhage, and at that moment, as if he had left his apathy back at the Deudermont townhouse, he declared his own private war on the accursed false children.

Unfortunately Bill had left more than his apathy at the Deudermonts'. He had also left whatever shreds of sanity he had left. And while he truly was concerned about the spite-waifs replacing the children of the Blight and infiltrating the city, he had no means of discerning between what was a malevolently disguised spite-waif versus what was truly an innocent child. He did not let such details hinder him.

For five years he continued to push his tinker's cart by day, and by night he conducted a reign of terror on the children and parents of the city. Scores of children disappeared during that time, some to be found later in various states of dismemberment or evisceration. Most were never found. Based on the bloody murder weapons and the types of wounds left by the meat cleavers and butcher knives he used, the authorities assumed their murderer was butcher or packer at one of the meat-packing warehouses of the East Ending. More than one innocent labourer wearing his blood-spattered apron from his day's work was lynched by mobs of fear- and sorrow-crazed parents. The murderer became known as Bloody Jack Carver, and children's rhymes began to appear among urchins on the streets and even in nurseries. Every child in the Blight knew who Bloody Jack Carver was and what he would do to unruly children.

Then one day thirty years ago, Bill decided he'd had killed enough. What caused him to reach this decision he could not say, but whatever psychotic motivation drove him to endlessly hunt the spite-waifs ebbed, and the regular disappearances of children ceased. The reign of Bloody Jack Carver had ended. The authorities never discovered who the culprit was but quietly assumed that one of the unfortunates lynched by the mob must have been the right one, and they closed the case in their books. Bloody Jack was gone, but his name and his rhymes lived on among the children of the Blight.

## Adventure Summary

**Chapter 1:** The PCs are called upon by a friend, one Inspector Hogan Muncy of the City Watch, for assistance in a murder investigation. He doesn't explain his reasons for bringing them in other than to say he thinks the unique nature of the crime may befit a group of professionals such as the PCs as opposed to the more regulation-minded Watch. They report to the hovel of an old tinker named Bill Hughe where a grisly murder has occurred, and the clues make it appear that the murderer was a small child.

Inspector Muncy gives the PCs a head start on the Watch to begin their own independent investigation before leaving them to their own devices — and acting a bit suspicious himself in the process.

The PCs can choose which course their investigation follows, but clues discovered at the crime scene point them to an old grinding shop. Or suspicious PCs can choose to investigate the strange manner in which Inspector Muncy has recruited them for this assignment by checking up on him at a pub known to be frequented by members of the Watch. Whichever they choose, the adventure proceeds as they follow up their leads and suspicions.

**Chapter 2:** At the grinding shop, the PCs discover Bill Hughe's old tinker's cart. Searching it, they discover a secret compartment inside and the chilling signs that it once held captive children within. Thus they discover the first signs that point to the fact that Bill Hughe was the Bloody Jack Carver killer. They also find clues that point to both a nearby grate leading into the city's old sewer system, and an old handbill for a fortune teller named Madam Larua.

**Chapter 3:** Investigating the sewers discovers more evidence of Bill's culpability in the Bloody

# BLOODY JACK PLOT MAP

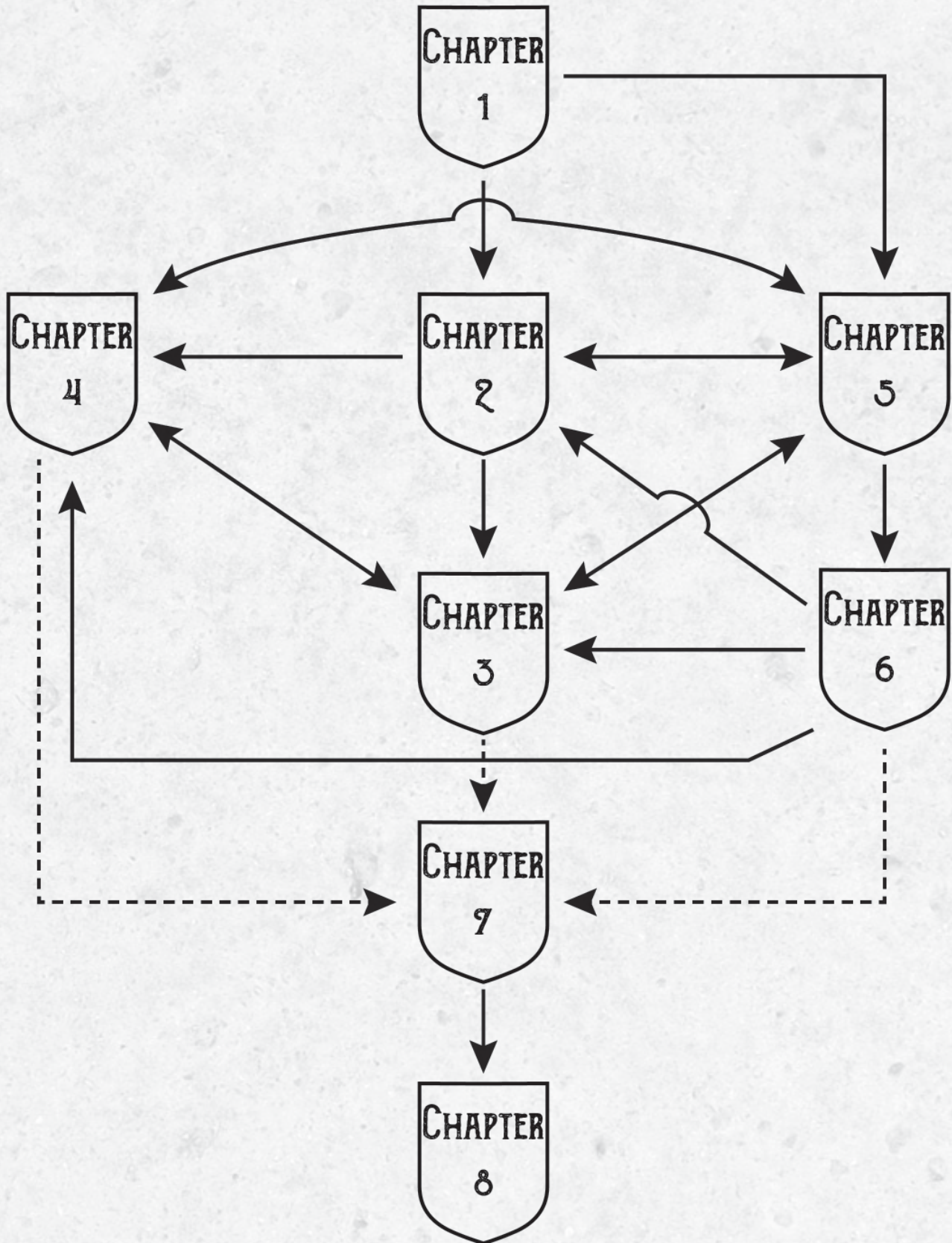



## THE BLIGHT: RICHARD PETT'S CROOKED CITY

Jack murders and that he used these sewers as a hideout where he conducted some of the killings. Further exploration leads the PCs to an old closed eatery that Bill often frequented, wherein they discover the remains of some of his victims of three decades ago in an old locked larder. From the remains they also discover signs that some of the supposed children were anything but human. They are further menaced by a horror from beyond the grave that continues to haunt the basement of the old eatery. As they escape, they discover that they have come to the attention of some malevolent, otherworldly group or syndicate who begins hunting them through the benighted streets of the city.

**Chapter 4:** Seeking out Madam Larua finds the old gypsy still in business at the edge of the city's festival district. Asking her about Bill Hughe reveals that she recalls him visiting her thirty years ago. She suspected that he was Bloody Jack from those visits, but the killings stopped shortly thereafter and she never saw him again, so she didn't bother reporting him to the Watch, assuming they had already captured or killed him. She does reveal a fortune-telling she did for him that indicated even after he had stopped his bloody work (the reason she thought he might be Bloody Jack) someone else would take it up anew for him. The interview is cut short by an attack by a horror from Between that devours the old gypsy and likely endangers the PCs themselves.

**Chapter 5:** If the PCs choose to follow up on Inspector Muncy, they can visit The Queen's Own pub where information and rumours can be obtained about members of the Watch. There they can learn of the murder of the inspector's own wife and child twenty years earlier that had been hushed up and the strange circumstances that may connect it to the murder they are currently investigating.

To delve further into this murder, the PCs must access the Watch Archives at the Capitol. There they find the original of the carefully redacted statement of Hogan Muncy that seems to implicate that his wife was murdered by their own child, and that she killed the babe in self-defense in the process, though the entire affair was later covered up. The PCs also discover that someone within the Capitol does not want them pursuing the old case and is willing to hurt or possibly murder them to prevent it. Attempts to locate the inspector come up empty, but they can learn the location of the crime scene where his wife and child died.

**Chapter 6:** If the PCs travel to the Muncy's old flat, they find it still sealed from the crime that occurred there two decades earlier. Within, they find the crime scene eerily undisturbed. Furthermore, they locate a previously hidden gateway to Between and realize that Inspector Muncy himself has recently passed through it. If they wish to have a chance to catch up to him, they'll have to pursue him into that bizarre realm. Once through the gateway, they encounter the strange fey and other malicious creatures that inhabit Between and emerge near the stall of Madam Larua (or its destroyed remains) without having caught up to Inspector Muncy.

**Chapter 7:** The next morning the PCs are summoned by the Constables of the Watch to a new crime scene on the Great Lyme River. Allegedly it was Inspector Muncy that sent for them, though when they arrive they are ambushed by slough eels and a doppelganger disguised as the inspector. Following clues found on the doppelganger leads the PCs to a nearby textile mill used as a front by a group of doppelgangers and spite-waifs from Between and lead a Watch police raid on it.

In the course of this raid, the PCs learn that Inspector Muncy has taken up Bill Hughe's mantle of Bloody Jack Carver from thirty years ago and is intending to kill all the spite-waifs hidden in the city. However, like Old Bill, Muncy does not intend to be overly particular about which children he takes and, as a result, many innocent children will die as well, just as happened during Bill Hughe's reign of terror.

### The Spiteful

Though villains and unsavory characters abound in this adventure, the true nemesis to the PCs and the ultimate cause of the Bloody Jack killings thirty years ago is not Bloody Jack himself, in either his previous incarnation as Bill Hughe or his new incarnation as Inspector Muncy. Rather, the true culprit behind these atrocities is the conspiracy of fey and foul creatures from Between known as The Spiteful. These creatures wish to invade and conquer the mundane world of Castorhage and seek to do so through subversion. It is for this reason that the changeling spite-waifs have been placed in the cribs of certain of the city's new parents for decades and what originally caused Bill Hughe to snap and begin preying upon the children of the city in an attempt to terminate the spite-waif menace. Though Bill (and later Inspector Muncy) never truly understood the motivations of The Spiteful, he (they) understood enough to recognize the abomination that was among the people of Castorhage and was moved to eliminate it as a result.

Though The Spiteful's methods and ultimate purpose remain murky, they have for decades replaced children in certain, carefully selected families within the city based on whatever mystical predictions they have made in regards to the potential for power within the city that they have calculated for those children. The PCs do not have the opportunity to stop this generation-spanning plot, but their actions in exposing it can set it back and disrupt those plans for many years to come — perhaps buying the future of the city a little bit of time.

**Chapter 8:** The adventure finale occurs as the PCs pursue the now-thoroughly insane Inspector Muncy to a children's fair on the river pier. There Muncy has taken several children captive atop the great ferris wheel, and the PCs must clamber up its superstructure high above the pier and face him. The adventure concludes as the PCs defeat the maddened Muncy and rescue the children from his clutches, though they may never know if all of the children they rescued are truly innocent humans.

## Beginning the Adventure

The adventure begins as the PCs are contacted by Inspector of the Watch Hogan Muncy, a mid-level inspector of the city's Office of the Watch. The inspector has come upon an atypical (and personally disturbing case) and seeks to utilize the PCs' unique talents as adventurers and their position outside the regular channels of the Watch to assist in the investigation.

Inspector Muncy should know at least one of the PCs through family, friends, or perhaps some social club or professional association that they have participated in together. While the PCs need not be members of the city government or law enforcement, it is assumed that they are not known outlaws and can be counted on to largely confine their actions within the limits of the law (at least insofar as any witnesses are concerned). The opening of **Chapter 1** assumes such a relationship exists, so modify it as necessary if you wish to adjust it to fit your own campaign.

# Chapter One:

## The Murder Investigation

### The PCs can reach this chapter in the following ways:

- The adventure begins with this chapter.

### Clues that should be found in this chapter include:

- The strange circumstances of the grisly murder apparently perpetrated by a child.
- The receipt for repairs for Grindlylow's Grinders.
- Inspector Muncy's strange behavior in regards to this case and his involvement in a similar prior investigation.

### The PCs' investigation can proceed to the following chapters from here:

- **Chapter 2** to investigate any connections with Grindlylow's Grinders.
- **Chapter 5** to find additional information at The Queen's Own pub about Inspector Muncy's strange behavior and the similar case from two decades before.

The adventure begins as the PCs answer a summons from the Office of the Watch to a rundown tenement in East Ending at dawn. Read the following:

The grey light of dawn breaks through the dismal smudge that is the air of East Ending, barely beginning to illuminate the broken cobbled streets. The streets run between ancient tenements that seem to sag against each other as if in exhaustion and whose windows look out like blank, soulless eyes. It is the domain of the lost and the defeated, and the last place you'd choose to be at this — or any — hour.

A large, black sewer rat scurries through one of the many puddles of effluvia that gather among the cobbles as it runs for cover at your approach. The early morning air is chill, but the cloudless sky promises to bring an oppressively hot day, especially here among the tall buildings and narrow alleys where a decent breeze can't ever seem to reach. At least with the morning chill, the reek of the streets and those that live upon them hasn't yet set in for the day.

Trudging through the ubiquitous puddles and potholes, you see your destination ahead. Among the darkened structures and rotten fencing that make up this alley stands one small hovel from which lamplights burn. The distinctive red rope of the Office of the Watch cordons off the door. It is a crime scene, and the familiar figure of one of the Watch officers stands in the doorway, illuminated by the lamp within.

The figure is Inspector Hogan Muncy, a detective of the Watch and an acquaintance for the past several years. You can't say that you know him well, but your paths have crossed in your personal circles and developed into, if not exactly a friendship, at least something of a mutual respect. He is the reason that you gather in this godsforsaken place at this godsforsaken hour on this godsforsaken street. The Constable

of the Watch that roused you from your slumber an hour ago simply said that Inspector Muncy had requested your assistance with an investigation and to gather your gear and come as quickly as you were able. He then escorted you into the benighted slums of East Ending and left you to continue on your own a block back. It seems that your meeting with the good inspector is to be in private.

Inspector Muncy lights his pipe and steps out into the street to intercept you before you get a chance to glance into the doorway behind him. He looks the part of the quintessential Watch Inspector as he has every time you've seen him, from his regulation moustache and sideburns, to his tweed jacket and pants, to his long coat from whose pocket his tiny Watch shield is suspended, to his city-issued, square-toed leather brogans. Even the brown bowler atop his balding head screams "official business". However professional his demeanor is, his eyes look tired and his face a bit pallid.

At your approach, Muncy retrieves a small wax tablet from his coat pocket and clears his throat as he reviews his notes. "Let's see. The deceased is one William Hughe, approximate age 70, at time of death, 'Old Bill' to the few people around here that knew him. He was a tinker by trade, though I get the idea he hadn't done much business in a long time and mainly lived off the bread lines and charity houses. Didn't get out much, didn't have any friends as far as we know.

"Bill's body was discovered about three hours ago by a pair of street sweepers making their nightly rounds. They noticed that the residence was lit and the front door standing open... something no one in their right mind would do in the middle of the night in East Ending. The sweepers found the decedent inside and immediately ran to the nearest Watch Station seven blocks from here to report the crime. The constables immediately cordoned off the area and called me. No one has been in or out since then other than me, and what I found prompted me to call you in. Before you go in I must warn you, the scene is...shocking to say the least."

After giving the PCs his rundown, Muncy steps aside to let them enter the hovel and have a look around themselves. He answers any questions they have but doesn't know much more than he has told them. He provides answers as written to the following questions:

- **How do you know his name, age, occupation, etc.?** The street sweepers who reported the crime are regulars on this street and had seen him before. He's apparently lived here for many years. They didn't know him personally, but did know who he was.
- **Were there any witnesses to what happened?** No the tenements and buildings around Bill Hughe's residence are mainly warehouses or are otherwise abandoned. Bill pretty much had this part of the street to himself. Constables knocked on doors an hour ago but were unable to find anyone in the area who might have heard or seen anything.
- **Were any clues found outside the residence?** There is one window that was broken from the outside and appears to have been the perpetrator's point of entry. The perpetrator then appears to have exited

## THE BLIGHT: RICHARD PETT'S CROOKED CITY

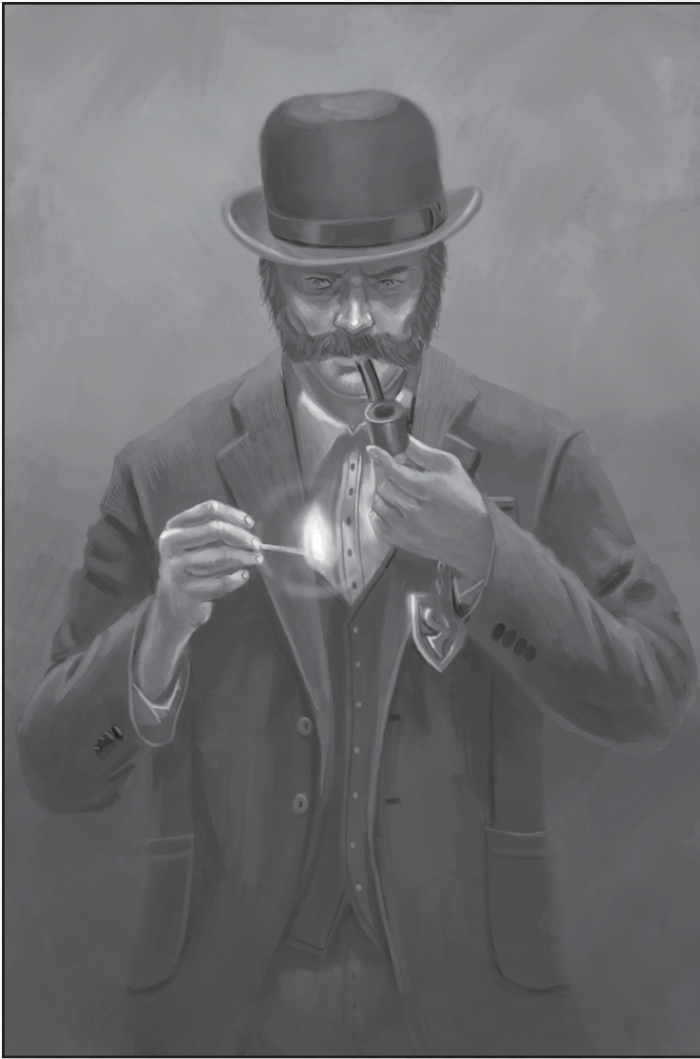

through the front door and left it standing open.

- **Do you know of a motive?** No, we don't know much about William Hughe, though he doesn't seem like the type to have made a lot of enemies. Also there are no signs of robbery. It seems like this was strictly a murder with no known motive.
- **How do you know the street sweepers weren't involved?** I'll let you look at the crime scene and see for yourself.
- **Why did you call us in?** We'll get to that in a bit.

Once the PCs have satisfied themselves with questioning Inspector Muncy, they are free to enter the house and look over the crime scene. Muncy hangs back in the doorway to let them look around undisturbed.

The inside of the hovel looks like the site of a massacre. The entry room is small and doubles as a both a sitting room and a kitchen. A door leads back into a small bedroom. A small table next to the bedroom door holds the lit lamp that was apparently set there by Bill before he was killed, though the wick in it has burned down and is about to go out. It has obviously been lit for several hours. The window next to the front door has been broken out, and the glass shards all lie on the floor of the hovel alongside a broken cobble clearly taken from the street outside, confirming that it was broken from the street and likely served as the murderer's point of entry since the front door does have a perfectly serviceable bolt on it.

Old Bill himself, still in his night clothes, lies gruesomely dismembered in the centre of the floor in a pool of gore. He

was clearly a victim of many of his own tinker knives and tools at the hands of someone who bore him great animosity. The blood-stained tools themselves lie scattered about the room as if they were thrown away in anger after they were used. Only the upper portions of the old man's face and his staring, open eyes were spared the villain's brutal ministrations — perhaps to better see and appreciate the killer's handiwork. The semi-congealed blood on the floor and the corpse confirm that this murder occurred within the last few hours, sometime after nightfall last evening.

Anyone taking in the scene finds nothing out of the ordinary about the room itself and, as Inspector Muncy mentioned, there are no signs of vandalism or that the room was ransacked in any way. It appears that the window was broken to gain entry and that the tools that once sat on shelves around the room were used to commit the crime, but nothing else appears to have been disturbed. A DC 12 Intelligence check postulates that the sound of breaking glass woke Bill and brought him from the bedroom where he confronted, and was ultimately murdered by, the intruder.

The only other real piece of evidence to be gleaned can be spotted with a DC 15 Wisdom (Perception) check (Muncy points it out if the PCs do not notice it on their own). There is no trace left by the killer except one footprint left in the spattered blood leading from the body to the front door — the bare footprint of a small child. A DC 10 Intelligence (Investigation) check can confirm that it is not a halfling footprint, nor that of any other race. It very clearly appears to be a human footprint belonging to a child no more than six years of age.

Once the footprint has been noticed, Inspector Muncy addresses the PCs once again.

“Sure this murder is brutal and gruesome, but I've served as an Officer of the Watch for more than 20 years. Even the most stomach-turning crime scenes are nothing new to me.” Inspector Muncy's eyes take on a haunted cast, “but this footprint...a child capable of doing this; that's something unusual even for the Blight. But even this wouldn't be such a shock that I thought maybe outside assistance would be of benefit except for what I'm about to tell you.

“This isn't the first time I've seen a crime scene where a brutal murderer appeared to have been a small child. It's actually the second time, and the first was twenty years ago when I was just a green constable. I was involved in a murder investigation then, and that time, too, it appeared that the culprit was likely a small child. The evidence seemed too ludicrous for the Watch to seriously consider that possibility, so the case was closed and given a plausible 'official' explanation before being quickly brushed under the rug. But for all these years I've wondered what could have happened in that other murder, and now to see this, I can't help but be reminded of that earlier crime and the unsatisfactory conclusion that the Watch came to on it.

“So that's why I've summoned you here. Two decades have passed since that earlier murder was hushed up, so I know the killer can't possibly be the same one that 'offed' Old Bill Hughe, but the similarities are uncanny and I want a fresh take on this one before the department gets ahold of it and decides it too needs to be closed and given a 'plausible' explanation. That's where you come in. I know that you've got some special talents and skills that maybe aren't found in a typical member of the Watch, and you can operate outside official channels to try and get to the bottom of this. I've been placed in charge of this investigation, so I can give you 48 hours before the Watch starts digging in earnest, so you'll have an undisturbed head start before any official interference could be cooked up. I'll pull strings to keep you out of any trouble with the Watch, though obviously don't start wrecking the town or roughing

up witnesses.

“Do what you have to do, within reasonable limits of course, to get this thing solved. I want to know who did this, the why, and the how. I’m not letting this one slip through my fingers like the other one did, and I can’t really trust anyone with it other than you. You’ll draw a Watch stipend while you do the work, and I can see to it that you get any mundane supplies that you may need, though it’ll have to go through official requisition channels, so probably the less you ask for the better.

“Well, that’s about it,” he says as he looks out at the sky now growing pink with the arrival of first light. “I think it’s time for me to take a lunch break. You gentlefolk better get to it,” he says with a grim smile.

Inspector Muncy places the bowler firmly upon his nearly bald pate and steps out the front door before striding down the street whistling a chipper tune jarringly discordant with the gruesome crime scene he just left. It looks like the investigation is yours.

Allow the PCs a DC 15 Wisdom (Insight) check. A successful check reveals that the inspector seems much more disturbed than he is letting on about this investigation — as if there may be more to the story than he has revealed. He does not give any further information at this time, though, and if questioned about the prior case he mentioned will simply state that he was not assigned to that case and can’t give further information. Unless stopped by the PCs, Inspector Muncy walks several blocks to an eatery just opened for the morning to dine. Even if stopped, he has no further information and departs as quickly as possible. If the PCs need to reach him, they can check in at the nearest Watch Station to get a message to him.

The PCs have the crime scene to themselves, and the Watch is unlikely to arrive for their own cursory crime scene investigation for several hours so the PCs have time to look things over. A search of the neighborhood reveals that Muncy’s report is correct; nobody lives nearby that might have heard or seen anything. Checking the Watch Station finds that the street sweepers were questioned and released but that they did not know any additional information. The PCs can use their credentials with Inspector Muncy to get the sweepers’ names and addresses, but this proves to be a dead end as they truly know nothing else.

Searching the hovel likewise turns up nothing else of interest except for a few impressive butcher knives that Bill had been sharpening for his job (and that were subsequently used on the old man). However, a search of the bedroom with a DC 10 Wisdom (Perception) check locates an old chest concealed beneath some blankets under the bed. Its lock and hinges are rusted shut (DC 10 Strength to break, DC 25 to unlock). Inside is a pile of hand-written receipts for tinkering jobs done by Old Bill 30 years ago, apparently stored here and forgotten. There aren’t any receipts in the rest of the house, so this appears to be a practice that Bill hasn’t continued in some time.

Examining the receipts reveals that for most of his work Bill did not use receipts, but some business required him to take customer’s property home with him while he repaired it, and the receipts were issued to the owner and copies were kept by Bill until the work was completed. Spending an hour going through the receipts allows the PCs to sort them out and discover that most were issued to people with unfamiliar names or businesses that closed down decades ago. A DC 15 Wisdom (Perception) check, however, uncovers one receipt issued to Eustus Grindlylow of Grindlylow’s Grinders for repairs to a gear mechanism (**Handout A**). The repaired mechanism lies in the bottom of the chest, apparently never returned to its owner. A DC 10 Intelligence (History) check recalls that Grindlylow’s Grinders is still in business and located only a few blocks away, apparently still awaiting the delivery of its part after 30 years.

There is nothing further of interest to be found at Bill’s hovel. As the PCs are leaving the crime scene, a squad of constables arrives. These officers of the Watch give the PCs suspicious looks but are obviously under orders to leave them unmolested. They secure the crime scene as the PCs depart but do not bother to ask any questions. They assume the PCs have not removed any evidence and can do little about it even if the PCs tell them, since Muncy has ordered them to let the PCs work. They will

## Deputies of the Watch

Each day that the PCs spend on the investigation earns them a 1gp stipend apiece. In addition, Inspector Muncy has given them writs deputizing them as investigators for the Watch that they can use as credentials. They can also attempt to requisition any piece of mundane gear worth 100gp or less from the Watch once per day. Doing so requires that they go to a Watch Station with their credentials and succeed at a DC 10 Charisma (Persuasion) check. If they are successful, any item of 20gp value or less can be had immediately (at the GM’s discretion, since some items may be harder to come by and require a day to procure). Items worth more than 20gp require a day to procure, and the PCs must return to pick it up. Unless the item would be consumed by its use (holy water, etc.), it is expected that the PCs will return it within 1 week. If they fail to do so, they will be charged double its list price by the Office of the Watch in order to replace it.

## But What About Magic?

This is a murder mystery; why not just use divination magic or *speak with dead* to get to the bottom of it? Magical investigation could certainly assist in solving this mystery. Unfortunately, the PCs are not of high enough level to have ready access to any truly effective divination magic that would be of real use, and no one else within the government or outside it frankly gives a rip about the death of an old tinker in East Ending... certainly not enough to expend expensive magical resources on it. And the victims available to question with *speak with dead* have little of specific value to offer. The PCs are going to just have to solve this one with good, old-fashioned legwork. Needless to say, don’t put any such resources at the PCs’ disposal unless you wish for a particularly short and unsatisfying mystery.

not, however, allow the body to be removed. That goes to the city morgue for examination and won’t be of any further use to the PCs anyway.

## Behind the Scenes

Though the PCs don’t know it, their involvement in this case brings them into a much deeper plot that threatens Castorhage, much larger than the horrific murder of an old man — even an old serial killer. Unbeknownst to the PCs, Bill’s hovel is being watched by individuals sympathetic to the spite-waifs that murdered the old man. These watchers remain hidden from the PCs (in abandoned windows and behind crooked fences) as they observe them and then go and report what they have seen to The Spiteful. The Spiteful take note of the presence of the PCs on the case but ascribe no special significance to it at this time — there is plenty of time for that as the PCs get deeper into the mystery and make a nuisance of themselves. For now, The Spiteful are content to simply observe.

For the rest of the adventure, anytime the PCs are in a public place day or night (and sometimes even a not-so-public place, such as the sewers) there is a hidden observer keeping an eye on them. The PCs will not have the opportunity to catch any of these observers in the act, but on these occasions allow each PC a DC 15 Wisdom (Perception) check to get the feeling that they are being watched by some malevolent presence — really no more than a prickly sensation on the back of their necks, nothing they can put a finger on. Play this up for atmosphere and to build tension, but do not let it derail the adventure. As mentioned, the PCs will be unable to catch anyone in the act — even with magic — and will have to simply “trust their guts”. There will be plenty of opportunity later to turn the tables on these unwelcome intrusions.

## What Next

The PCs now have a good idea of the murder but know little of why it occurred or who did it. In addition, they have very few leads to speak of. Really their only valid options at this point are to check out Grindlylow's Grinders to see if there are any clues that might remain after 30 years (a long shot indeed, as it seems unlikely that a grudge over an unreturned gear part would be sufficient motive for the murder) or to see if they can find out any further about Inspector Muncy's strange behavior in regards to this case and the one from two decades previous.

If the PCs wish to head over to Grindlylow's, this is covered in **Chapter 2**. Further investigation into Inspector Muncy will involve a visit to The Queen's Own pub and is covered in **Chapter 5**.

# Chapter Two: Grindlylow's Grinders

## The PCs can reach this chapter in the following ways:

- The receipt found at Bill Hughe's hovel in **Chapter 1**

## Clues that should be found in this chapter include:

- The possibility that Old Bill was the Bloody Jack Carver killer, based on the hidden cage in his cart and the presence of the sleeping poison, which could have given a motive to his murderer.
- The key from the Guild of Sewagers and Ironmongers in Bill's cart.
- The reference to Madam Larua whom Bill perhaps consulted or at least thought about consulting around the time he left the cart.

## The PCs' investigation can proceed to the following chapters from here if they have not already done so:

- **Chapter 3** to investigate the sewer entrance.
- **Chapter 4** to locate Madam Larua.
- **Chapter 5** to investigate the suspicious behavior of Inspector Muncy.

Grindlylow's Grinders is an industrial grinding operation primarily concerned with machining metal components for gears and other machinery and smoothing stone for construction. It is located only five blocks away at the edge of the Great Lyme River and is open from sunrise until 1 hour before sunset. The following description assumes that they arrive during operating hours.

The rumble of a millstone and the screeching of metal grinding metal fill the air as you approach this building. A much-repaired retaining wall surrounds a courtyard before the two-storey building whose own walls show many patches of mismatched brick. The wooden roof of the long main building sags in the middle, and just below its eaves faded, flaking lettering has been painted directly onto the brick, identifying the establishment as "Grindlylow's Grinders." Below this a patch of brick wall has been painted over and additional lettering added more recently, "Horatius Grindlylow, Prop."

A wrought-iron gate stands open allowing entry to the hard-packed dirt of the courtyard before the building's barnlike doors. Within its dust-clouded interior can be seen large mechanisms driven by long canvas belts running over pulleys and powered by a large waterwheel in the back. Numerous small outbuildings cluster along the edges of the courtyard.

As the PCs enter the courtyard, a dusty, middle-aged man in a worker's smock walks out of the dimly lit main building to meet them. He is Horatius Grindlylow (CN male human **commoner**; Int 12; Wis 14), the owner and proprietor of the grinding house and he assumes that the PCs have come to contract his company for an industrial grinding job. If the PCs show him the repaired gear and the receipt, he seems surprised and slightly annoyed. He tells them that his father, Eustus, died of a fever

eight winters ago and left the grinding house to him. He tells them that he doesn't care if the repair has been made, he's not going to pay them the agreed upon price because it's 30 years late and they had to buy a new gear to replace it long ago.

If the PCs succeed on a DC 15 Charisma (Persuasion) check to make him more amenable, or at least roleplay either a friendly demeanor or one of official business for the Office of the Watch, he tells them that he doesn't know anything about the gear but the employee who ran the main grinder back then and who would have handled the transaction 30 years ago is still around. The PCs can talk to him if they like. He then calls back into the building ("Hey, Ev! Some folks to see you."), and moments later out walks a bent-over, older man with grizzled features and worn coveralls. Horatius introduces him as Everett Schimp (N male human **commoner**; Int 12; Cha 12), now the grinding house foreman, and then leaves him to deal with the PCs, too busy to waste time with people who aren't paying customers.

Schimp is an irascible old man and seems highly amused when he is shown the gear and the receipt. He talks readily enough and confirms he hired Old Bill to make the repairs — and remembers it well because he nearly got fired for it. Old Bill was to take the gear home and have it fixed overnight before returning it and collecting his payment. When he never showed up the next day (or the next, or the next), Schimp realized he wasn't going to be coming back. Rather than try to find a needle in a haystack like an itinerant tinker in all of East Ending (they didn't know where Old Bill lived or even his last name), they opted to just buy a new gear to replace the broken one. Old Man Grindlylow (Eustus) was furious at Everett and docked his pay for two weeks to make up for the loss.

Schimp says he always wondered what happened to Old Bill and laughs saying he always figured the old tinker had gotten the worst of it. He had left his tinker cart at the grinding house when he took the gear home and had intended to pick it up the next day when he returned the gear. When Old Bill never showed up again, Old Man Grindlylow pawned every tool and scrap of metal on the cart to make up for his loss and repurposed the old thing for storing cans of paint and grease. If the PCs don't think to ask on their own, Everett's Schimp's eyes suddenly light up as he recalls that they, in fact, still have the cart. No one has used it for years, and it's just been sitting in the back of one of their storage sheds gathering dust. He can show it to them if they ask to examine it.

## The Tinker's Cart

Crammed into the back of a storage shed, stacked with old cans of dried paint and jars of grease is Old Bill's tinker cart. It is a two-wheeled pushcart approximately 4ft long by 2ft wide with a bin occupying the front 2ft of it for holding items to be repaired, and the back half consisting of a large wooden box with dozens of pegs on the outside for hanging the tools of his trade from. The tools are long since gone, and the cart is now covered in spatters of paint, old grease, and rust flakes from its years of service at the grinding house.

At first glance there is nothing of particular interest about the cart. Anyone knocking on the wooden box that the tools once hung from confirms that it is hollow, as would be expected. However, a DC 20 Wisdom (Perception) check determines that it actually has a secret catch in the back that allows it to be opened. Everett Schimp expresses surprise at this discovery, as he was never aware all these years that a compartment could be accessed within. The opening mechanism is complex, though, and requires a DC 15 Dexterity check with thieves' tools to gain access to

## THE BLIGHT: RICHARD PETT'S CROOKED CITY

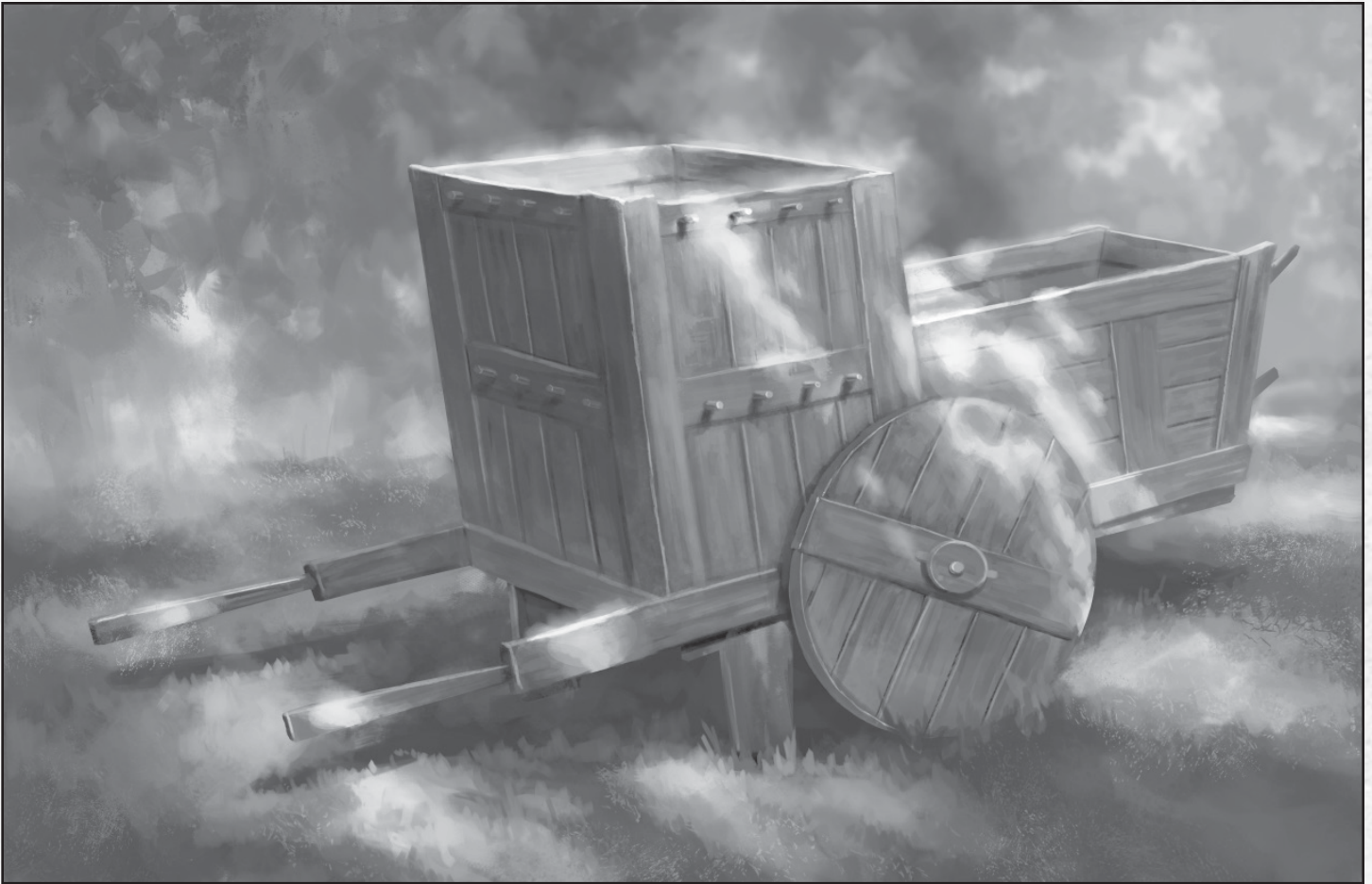

the interior. Likewise, the cart could be disassembled with the proper tools (which are readily available at the grinding house).

Opening the compartment reveals a hollow, as expected, but it quickly becomes obvious that it is not an ordinary compartment. First, the wood is double-layered to make it sturdier and proofed against sound and light. The additional thickness of the wood makes the compartment interior no bigger than could hold a small child. Second, the inside is smeared in many places with brown stains, suspiciously like old blood, and there are many scratch marks in the wood as if something had tried to escape. If a light source is used to examine this interior, a DC 15 Wisdom (Perception) check reveals a child-sized handprint among these brown smears, confirming that a Small humanoid had, on one or more occasions, been confined within the secret compartment long ago.

Also within the compartment is an old tool belt. Stored within the tool belt are a small clay bottle with a rag stuffed into its neck to serve as a stopper, and a strangely crafted iron key wrapped in a piece of parchment.

Pulling the stopper on the bottle reveals a dried remnant of blue powder caking its interior. It is the dried remains of essence of ether. If a victim were to receive a dose of it, they would fall unconscious for 8 hours if a saving throw was failed. The rag itself is also stained in the centre with the dried blue crust where it had at one time been soaked in the concoction. If no one present is capable of identifying the poison, applying a bit of the crust to the tongue causes momentary numbness, giving a hint as to its sedative effects with a DC 10 Intelligence check.

The key is large and made of iron with a decorative bow. Cast into the key's bow is an intricate sigil of a plumb bob and hammer. A DC 10 Intelligence (History) check recognizes the sigil as that of the city's old Guild of Sewagers and Ironmongers, which can still be seen on the lock-gates on many of the older sewer tunnels and drainage channels throughout the city, if one knows where to look. A DC 10 Intelligence (History) check recalls the guild to have been the extremely corrupt organization that built and managed the sewers and underground drainage systems of the city for centuries before finally being replaced by the city's Office of Sanitation by order of the infamous Crown Justice Moravan. The key appears to be one of the old master keys that belonged to the guild for use in accessing the city's sewer lock-gates.

Finally the parchment that the key was wrapped in is also of interest. It is actually a piece torn from a 30-year-old broadsheet that bears an advertisement for one "Madam Larua — Teller of Fortunes and Diviner of Secrets" (**Handout B**). The broadsheet gives the location of her fortune-telling stall as being located near the edge of the Skew at the summit of the Festival Pier.

While the clues found on the cart seem a bit disconnected between the old sewagers guild and a fortune teller, the presence of the sleeping poison and the hidden, child-sized cage hint at a grim truth all their own.

To add one final piece to everything uncovered at Grindlylow's Grinders, a few moments after Everett Schimp sees the sigil on the key — whether the PCs have recognized its significance or not — he perks up and comments how he's seen that sigil before. It's inscribed above an old barred gate in a courtyard nearby where he eats his lunch each day. If asked, he can show it to the PCs.

### Behind the Scenes

Bill never returned to the grinding house with the gear because that very night was when he came to the decision that his days of hunting spite-waifs were over. With that decision made, he moved on from that part of his life and never bothered to return for his cart or even thought about it again. To him it was as if he had never owned it — that was all part of another lifetime.

The clues provided by the cart are only all too clear. Bill would use the essence of ether to drug the children who were his victims and then hide them inside the compartment in his cart so he could secretly transport them to the various locations where he committed his crimes. When the PCs come to this realization (or something to the effect that Bill may have been drugging children and locking them in the cart), they likely begin to realize a motive for why Bill might have been murdered by a child. Furthermore, a DC 10 Intelligence (History) check or Everett Schimp (if the GM needs an NPC voice to fill them in) remembers the legends of Bloody Jack Carver and the nursery rhyme presented at the introduction to this adventure (provide the players with **Handout C**).

## What Next

The PCs have now likely made a connection between Bill and the abduction, and possibly murder, of children three decades ago and may be suspicious that he was, in fact, the Bloody Jack killer. This certainly gives a motive for why a child might have killed Old Bill but certainly doesn't explain how a child was capable of it, or even aware of something that occurred 30 years before. Indeed, none of this really gets them any closer to solving the crime they are currently investigating.

They do have new clues in the old Sewagers Guild tunnels and the location of a fortune-telling stall from a generation ago, though what insight these disparate locations might provide remains a mystery. However, at this point they still have little else to go on.

If the PCs follow Everett Schimp to the old sewer entrance, proceed with **Chapter 3**. If they'd like to check into the enigmatic Madam Larua, they can do so in **Chapter 4**. If they still have not followed up on Inspector Muncy himself at The Queen's Own pub, they can still do so in **Chapter 5**.



# Chapter Three: The Hidden Ways of the Sewagers and Ironmongers

**The PCs can reach this chapter in the following ways:**

- The Sewagers Guild key from Old Bill's cart in **Chapter 2**.

**Clues that should be found in this chapter include:**

- Further evidence that Old Bill was Bloody Jack based on the additional equipment found in area **3**.
- The fact that Bloody Jack was killing more than just children based on the non-human skeletons found in **11**.
- The fact that children (or something that seems childlike) are now possibly coming after the party with malicious intent when the door is locked at **7**.
- The possibility that someone may be helping them in their investigation with the discovery of the sign board at **2** (though this could also appear to have been a lure set by the same "children" that tried to trap them at **11**).

**The PCs' investigation can proceed to the following chapters from here if they have not already done so:**

- **Chapter 4** to locate Madam Larua.
- **Chapter 5** to investigate the suspicious behavior of Inspector Muncy.
- **Chapter 7** as events proceed behind the scenes if they have already completed **Chapters 3, 4, and 6**.



Everett Schimp guides the PCs to a nearby abandoned courtyard among the streets and alleys of East Ending where he takes his lunch each day to gain a few moments of peace away from the noise and bustle of the grinding house.

## 1. Vacant Courtyard

The noise and confusion of the city are left behind as two alleys come together here to open into a remote courtyard, surrounded on all sides by mostly vacant, three-storey buildings. A few trees grow along the edges providing shade for a stone bench that sits beneath one of them. To the west, a thick cascade of withered vines grows upon a wall, mostly obscuring an archway beneath them. Just barely visible beyond the vines is a gate of iron bars and at its arched top is a rusted iron plaque bearing a hammer and plumb bob sigil.

The bench is where Everett eats lunch. The overgrown gate is a lock-gate, and the sigil above it is indeed that of the Sewagers Guild. The entire courtyard slopes slightly to the west so that when rainfall occurs, the

runoff flows through the lock-gate and into the city's drainage tunnels. It is currently dry. The curtain of vines shows that no one has used this lock-gate in many years. Removing the overgrowth from the lock-gate takes a few minutes work to reveal that the gate itself is secured with a heavy lock. This rusty lock requires a DC 20 check to open, or the PCs can use the key found in **Chapter 2** to open it easily. Everett Schimp will not accompany the PCs beyond this gate for any reason and can provide no further information.

## 2. Drainage Tunnel

Grimy steps descend rapidly to one of the old drainage tunnels that run beneath the city. This tunnel's brick walls are coated with years of grime up to the high water marks left here long ago, and the floor is several inches deep in collected filth and detritus. Though slightly muddy, the tunnel is largely dry now. There are no light sources, but in the wan illumination coming through the lock-gate, you can see that the centre of the tunnel is punctuated periodically by large iron grates providing further drainage for storm runoff.

# Seaside Larder and Adjoining Tunnels

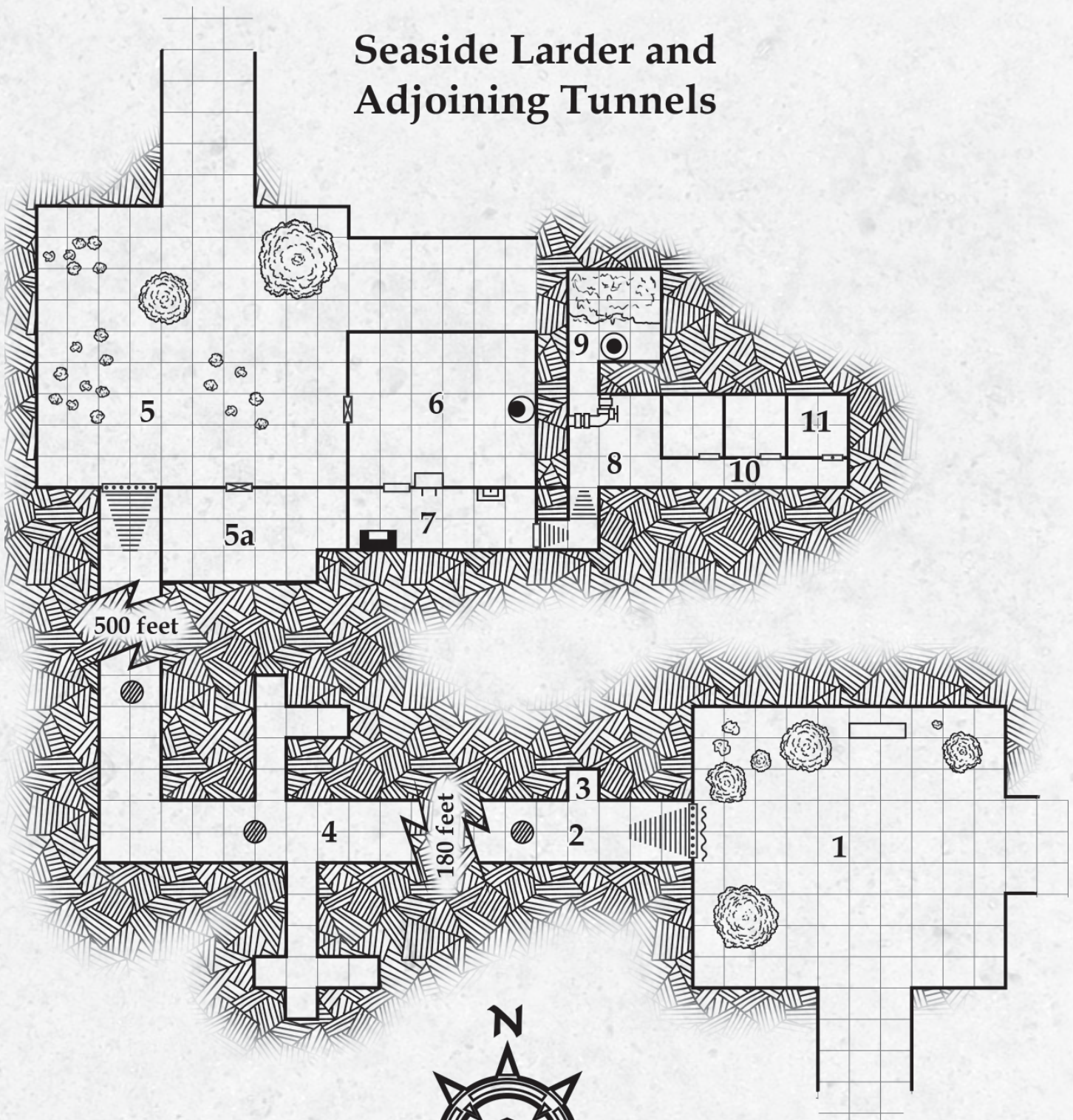

1 square - 5 feet

## THE BLIGHT: RICHARD PETT'S CROOKED CITY

The drainage tunnels are 10ft high. The iron grates can be lifted with a DC 15 Strength check but they just lead to smooth-walled vertical shafts that run down into the lower bowels of the city's sewer. Based on the pungent aroma arising from them, the tunnels below are obviously still in use. An alcove branches off of this tunnel just inside the entrance and requires a DC 15 Wisdom (Perception) check to notice in the shadows. If a light source (or a PC with darkvision) is brought in, it is noticed automatically.

### 3. Storage Alcove

The back wall of this brick alcove is stamped with the plumb bob and hammer of the Guild of Sewagers and Ironmongers. Shelves have been built above the high water mark on each side wall, and hooks protrude from the wall beneath them.

This alcove was once used by guild members to store equipment and hang tool belts and waders for use in the maintenance of these tunnels. It has not been used for this purpose in many years, however searching the shelves reveals several other items lying under a thick layer of dust. These items include a small metal coffer, a tattered old book of children's fairy tales, a few articles of soiled and grubby children's clothing, and a pair of rusty old butcher's knives, stained brown with old blood. Opening the coffer reveals two clay bottles that contain the same blue residue (essence of ether) as found in Old Bill's tinker cart in **Chapter 2**. These items were all left here by Old Bill three decades ago and have been forgotten ever since.

**Development:** While the PCs are examining the items in this alcove, there comes a loud clatter out in the main tunnel as if a large piece of wood falling to the floor. Anyone going out to check finds that 50ft down the tunnel to the west, a wooden signboard has fallen to the floor from where it hung from the wall by an old bolt (now rusted through). The sign is stenciled with faded lettering that simply says, "Tunnel 34 West, East Terminus," and has clearly hung here since the days of the guild's use. Why it would suddenly choose this moment to give way and fall is not readily apparent. There can also be seen a message recently scrawled in charcoal (**Handout D**) on the front of the signboard. A DC 10 Intelligence (History) check recognizes it as another Bloody Jack-related nursery rhyme common among the children of the Blight.

Anyone searching the semi-solid muck around where the signboard fell, notices with a DC 5 Wisdom (Perception) check an arrow drawn in the grime pointing further down the tunnel as well as a small piece of charcoal — obviously used to write the message. A DC 15 Perception check notices a set of child-sized footprints with stocking feet going to and from where the signboard fell. They emerge from and return to a nearby floor drain whose grate has been shifted from its seating to allow access to the vertical tunnel below for a Small creature. Attempting pursuit down this 30ft deep shaft is fruitless as it just leads to flooded sewer pipes only a few feet in diameter where the PCs cannot safely follow. Though it may appear that these prints were left by the perpetrator of the Bill Hughe murder (i.e. a spite-waif), they were in fact left by an attic whisperer that is serving as a hidden benefactor to the PCs in their investigation and will appear again in **Chapter 7**. The PCs will be unable to discern the undead origin of the footprints, however, because the creature wears an old pair of stockings that disguises its skeletal feet.

### 4. Crooked Crossing

The tunnel walls are broken here by a low, 5ft high opening on either side. In addition, a drain grate in the centre of the tunnel has been removed to reveal the open pit leading to the sewers below. A foul stench wafts from this pit.

Anyone making a DC 20 Wisdom (Perception) check can tell that the sewer smell is coming from the side tunnels in addition to the sewer pit. This is because the clutch of 3 **crooked chokers** that dwell here make frequent trips between the sludgy sewer channels below and the small

access tunnels that run to the north and south. These filthy creatures look like regular chokers — grey-skinned, hunched-over wretches with long, tentacle-like arms ending in splayed, spiny claws — except their heads have been twisted around oddly on their corkscrew necks until they face backward and they scuttle about on all fours in an awkward crablike gait. These horrors descended from Between long ago and took up residence in the tunnels beneath the Blight. The Spiteful have gone ahead of the PCs and roused them from their lair here to prepare an ambush.

The chokers usually climb along the ceiling and walls of the crumbling brick tunnel, rarely touching the ground so they leave no tracks, but anyone searching the tunnel floor (DC 10 Wisdom [Perception] check) can find a single pair of man-sized, shod footprints next to the floor drain as if somebody appeared and stood there for a moment before disappearing and leaving no trail behind. In actuality, a fey-touched agent of The Spiteful invisibly flew here ahead of the PCs to warn the chokers of their approach, and then flew off down the tunnel ahead of the PCs to prepare their next obstacle.

**Crooked Choker (3): AC 15; HP 45 (10d6+10); Spd 30ft, climb 15ft; Melee tentacle (+6, 10ft, 1d8+4 bludgeoning plus restraint, escape DC 13), bite (+6, 1d6+4 piercing); SA multi-attack (tentacle x2 or tentacle, bite), quickness (move with bonus action); Str +4, Dex +2, Con +1, Int -3, Wis +1, Cha -1; Skills Athletics +5, Stealth +6; Senses darkvision 60ft; Traits strangle (restrained target can't speak or cast verbal spells); AL CE; CR 2 (XP 450).**

**Tactics:** The broken chokers have prepared an ambush for the PCs. One hangs in the drain just below its lip, and one lurks in the north side tunnel. These both have total concealment as the party approaches. Likewise, one hides in a crevice in the ceiling just above the drain. As soon as the PCs approach within 10ft, the choker in the pit leaps out and starts running to the west. If the PCs attempt to pursue or make ranged attacks, the choker in the side tunnel attempts to run out and shove a PC with surprise into the pit from behind. The choker dangling from the ceiling then makes attacks at any PCs behind that one so it can grapple them over the pit and drop them. The third choker then doubles back and joins in the attack on any remaining foes. The choker in the ceiling crevice has total cover to anyone not in an adjacent square and half cover even from adjacent squares. Only those in the square directly below the choker's position don't have to deal with it having cover. However, wedged into the crevice as it is, that choker is attacked with advantage.

The pit is 5ft in diameter with slimy walls (DC 20 Strength [Athletics] check) and drops 30ft into a 2ft deep pool of sewage (3d6 falling damage, DC 15 Dexterity save to grab the pit's edge to avoid falling). The side pipes leading out of the pit are too small for the PCs to traverse. These degenerates fight to the death.

**Treasures:** Deposited in the corner of the side branch down the northern tunnel is the desiccated corpse of a halfling, half-eaten long ago by the chokers with the torso and remaining leg left to dry out like jerky. Anyone searching these remains must make a DC 12 Fortitude save or contract leprosy (see the Pathfinder Roleplaying Game, Appendices, "Diseases"). Also a DC 15 Wisdom (Perception) check reveals an old dry-rotten leather pouch stuffed into the corpse's mouth. This pouch contains two chrysoberyls (150gp each) and 7pp.

### 5. Light at the End of the Tunnel

Another lock-gate bars the end of the tunnel as it emerges to a short stair rising to another courtyard. This one is much like the one you entered through, though perhaps even more desolate. Where the other had a few trees and a shady bench, this has several sickly trees and a thick growth of bracken that has broken through the cobblestones. Also, unlike the other yard which simply had blank brick walls from surrounding buildings closing it off, this one has the boarded-up doors of old businesses that once opened out onto it. The sounds of traffic and the lifeblood of the city are heard only very faintly from this courtyard.



The key that the PCs' possess easily opens this lock-gate as well. The streets run for 100ft to the north and east before opening onto more heavily travelled thoroughfares. The two boarded-up businesses that opened onto this courtyard bear signs that read "Abler's Stitchery: Fine Apparel" and "The Seaside Larder: The freshest fare this side of the sea." The door to each has been boarded up but can be forced open with a DC 10 Strength check or a few minutes work with a crowbar or axe.

A DC 10 Intelligence check recalls that The Seaside Larder was one of the names that appeared repeatedly in the receipts they found in Old Bill's home. Apparently he performed a lot of tinkering jobs for them and was at the location quite frequently. That combined with the fact that he possessed a Sewager's Guild key to give easy access to the establishment should seem a glaring coincidence.

## 5a. Abler's Stitchery

This building is vacant and dusty with only the remains of a broken old loom standing against the back wall to provide any hint as to its former purpose. There is nothing of interest.

## 6. The Seaside Larder

The ghostly forms of sheet-draped tables stand scattered across the room, the chairs that once stood with them long since stolen. The dry, cracked remains of an old plaster fountain hang upon the back wall, and a service window opens next to the door to the kitchen.

Once an ostentatious (for East Ending) eatery of middling quality, The Seaside Larder closed more than 30 years ago. As Bill had done a great bit of work for it over the years and was familiar with the building, he continued to use it in his role as Bloody Jack Carver as will be discovered by the PCs in its cellar.

## 7. Kitchen

This dusty space once served as the kitchen for this establishment, and the faint stench of fish grease still hangs over the place. A large oven and grill stands across the room while at the opposite end a stone basin sink protrudes from the wall. A heavy door stands closed not far from the sink.

The sink once brought water to this room from the pipes below the eatery but, like the fountain in room 6, it is now dry. Opening the door reveals a rickety wooden staircase leading down into the cellar.

## 8. Kitchen Cellar

The brick walls of the kitchen stair are crusted thick with nitre and stained with soot as they open into a cellar. The air here is muggy and damp with large patches of black mould growing on the floor and walls. A large lead pipe protrudes at head height from the north wall before turning abruptly into the west wall. A flywheel mounted on its elbow joint appears to be rusted in place. Long strings and sheets of dripping fungus hang down from this pipe nearly obscuring a passageway beyond it. Another passage exits to the east.

The lead pipe once carried water to the fountain and sink in the eatery above, but its iron valve is now rusted shut. Nevertheless, it is still the source of the excessive dampness in the chamber as a continuous trickle of water runs through it. The mould and fungus themselves are harmless, however, residing among the fungus atop the old pipe is a **fungus weird**, a snakelike creature that appears to be composed of thick ropes of fungus

## THE BLIGHT: RICHARD PETT'S CROOKED CITY



with countless stacks of tableware, crockery, cooking utensils, and old grease traps. Old rat droppings lie scattered across the floor and this pile of detritus.

This scullery was where the dishes and linens of the eatery were washed. Now these have sat and festered in this damp chamber for more than 30 years and created a rotten mound of decay and filth. Anyone staying in here for longer than 1 round must make a DC 10 Constitution save or be poisoned for as long as they remain in the chamber. Searching through the morass for treasure or anything of interest will require at least an hour of digging. Furthermore, the rags are so damp that they will not burn.

Buried at the bottom of this mound is the former chef of The Seaside Larder, now a **carcass**. A massively obese man, the Larder was closed more than three decades ago when its chef suddenly went missing. He in fact ran afoul of Old Scratch one night who tortured and murdered him as sort of a parlour prank before animating the corpse and hiding it back here without anyone knowing. Since the eatery closed so soon after that and the mound of washing was never moved, he was never discovered. A gluttonous and cruel man in life fond of consuming live river eels by the handful, in death he is a mound of corpulent undead flesh, huge fat rolls hanging listlessly from his pale body. His distended abdomen has split open to reveal the twisted remain of his past meals, 4 **lamprey zombies** lurching forward on their spiny ventral fins, their maws filled with needle-sharp fangs. The chef remains quiescent at the bottom of the mound unless the PCs dig down and disturb him. Otherwise he does not rouse from his stupor until the events described under "Development" in room 11.

**Carcass:** AC 13; HP 58 (9d8+18); Spd 20ft; **Melee** slam (+7, 1d8+5 bludgeoning) or envelop (grapple escape DC 15); **SA** envelop (paralysis, DC 15 Con avoids, 1d4 acid per round), expel, multiattack (slam x2); **Str** +5, **Dex** -2, **Con** +2, **Int** -4, **Wis** +0, **Cha** +0; **Skills** Perception +4; **Senses** darkvision 60ft; **AL** NE; **CR** 2 (450 XP).

**Lamprey Zombie (4):** AC 13; HP 19 (3d6+9); Spd 30ft, swim 40ft; **Melee** bite (+3, 1d6+1 piercing); **Immune** poison; **Resist** slashing; **Str** +1, **Dex** +1, **Con** +3, **Int** -4, **Wis** -2 (+0), **Cha** -3; **Senses** darkvision 60ft; **AL** NE; **CR** 1/4 (50 XP).

twisted together. Anyone attempting to pass through the fungus (the corner 5ft square is considered the weird's pool) to gain access to room 9 becomes automatically entangled as the spell and must make either a DC 15 Strength (Athletics) check or Dexterity (Acrobatics) to break free. The fungus weird ignores anyone entangled and instead concentrates its attacks on others in the room. It can go anywhere in the room (though not beyond) but always maintains a tenuous link to the curtain of fungus on the pipes.

**Fungus Weird:** AC 15; HP 67 (9d10+18); Spd 30ft; **Melee** bite (+5, 10ft, 3d6+3 piercing plus restraint, escape DC 13); **SA** sleep spores (Recharge 5-6, 10ft cone, 1 min, poison causes unconsciousness, DC 12 Con avoid, repeat save if target takes damage); **Immune** blindness, bludgeoning, deafness, exhaustion, fright, unconscious; **Resist** cold, normal piercing and slashing attacks; **Str** +3, **Dex** +3, **Con** +2, **Int** +0, **Wis** +1, **Cha** +1; **Senses** blindsight 30ft (blind outside radius); **Traits** camouflage (invisible in pool), fungus pool (20ft radius difficult terrain, entangle causes restraint, escape DC 13); **AL** N; **CR** 4 (1100 XP).

### 9. Scullery

The stench in here is almost overwhelming. It is the smell of rotting fabric, mildew, and decades-old accumulation of fish scales and table waste. Next to the door a spigot extends from the wall above a large wooden tub, empty now of all save old water stains and a few broken pieces of crockery. Stacked against the north wall and filling half the room is the source of the stench, a huge pile of table linens, aprons, waiter uniforms, chef's apparel, linen napkins, and old wash rags intermixed



## 10. Larders

The fishy stench down this narrow hall is noticeably worse than elsewhere. Along the north wall are a series of metal doors undoubtedly used to store the fish brought in for the eatery above. The doors all appear to be intact and in good repair but are otherwise unremarkable save for the last door down. Even from here a padlock can be seen hanging from the hasp of the door handle.

These rooms served as ice boxes for the eatery. Ice was brought in and stored in these rooms on a bed of sawdust while fresh catches were stored here until they could be prepared for customers. The first two rooms smell strongly of the old fish reek and have only a few metal hooks dangling from the ceiling, wooden shelving for storing fish, and piles of old, mildewed sawdust where the ice was once stored. They have nothing of value.

## 11. Bloody Jack's Larder

The door to this chamber bears a large padlock that has the insignia of the Guild of Sewagers and Ironmongers (DC 20 to unlock). It opens easily with Old Bill's key.

This larder is different from the others you've seen. As the door swings open, a subtle musty smell, like old leather, drifts from within. The ceiling of the revealed chamber is filled with dangling meat hooks and as the light filters inside, you realize with horror that many of the hooks pierce the desiccated, almost skeletal, remains of more than a dozen human children.

After the eatery closed, Bloody Jack Carver used this room to dispose of some of the children he abducted. There are a total of 17 children on meat hooks that have hung here since Bill left them 30 years ago. The relative dryness of this sealed chamber caused them to desiccate into their current forms rather than rot away. They hang with the hooks jammed through their rib cages, and their dried skin has become parchment thin, stretched tight over the bones, revealing the dried remains of their internal organs and muscles beneath. Anyone examining them and making a DC 10 Wisdom (Medicine) check notices something strange about them, however. Three of the "children" do not have the normal internal anatomical features of a human child. Their organs are strangely shaped and out of place, and most of their abdomens are occupied by a distended stomach. Closer examination of these bodies reveals the permanent teeth buds emerging from their jaws are sharp and pointed like a carnivore's, and their fingernails are thicker and extend deep back into the bones of their fingers to provide strong and dangerous claws. Intelligence checks will not provide any further information on the type of creature. These simply have never been encountered by the inhabitants of Castorhage, so there is no base knowledge to draw from for these. Whatever they are, they are definitely not human, having only the superficial appearance of human children. Clearly Bloody Jack was doing more than just murdering the human children of the city.

If the PCs have access to spells such as *Speak with Dead*, they can try and question any of the corpses. The human corpses are all children of East Ending who disappeared 30 years ago and tell the same woeful tale of the kindly tinker, Old Bill, befriending them with kind words and treats only to find themselves locked inside a wooden box and ultimately brought to this chamber where they were hung from the meat hooks to die. They know nothing of his motives or any unhuman children. Strangely, the nonhuman corpses give the same kinds of responses as from the perspective of the human personas they were inhabiting as an odd side effect of their perfect copy ability that allowed them to take those forms so long ago. The result is clear: there are no easy answers to be had by magical means here.

**Development:** As the PCs have had a moment to make the discovery of the murdered children (and likely discover that not all of them are

children), read the following if they have not already encountered the carcass in 9. If the carcass has been destroyed, then do not read the italicized portion, and instead replace the carcass with a **hell hound** that The Spiteful released into the cellar before locking the door.

Your discoveries are interrupted by a sound, ordinarily harmless but strangely menacing in the current setting: the faint sound of children's laughter coming from the direction of the eatery's cellar. It is followed by the echoing boom of the cellar stair door being slammed shut and cutting off the laughter. *All is silent in the allegedly abandoned basement for only a moment before another sound reaches your ears — fainter, almost a whisper at first. It is the sound of shifting fabric and the clatter of dislodged stacks of crockery. Something large and heavy shifts in the darkness back in the direction you came from, followed shortly by the growing stench of a graveyard wind. You are not alone in the dark.*

The Spiteful have attempted to trap the PCs within the cellar along with the carcass (that they discovered years ago). PCs retreating to the top of the cellar stairs find that the strong wooden door has been barred from the other side (DC 15 Strength check to open). Meanwhile, the carcass emerges from room 9 and attempts to trap the PCs in the passage at 10. It first expels the lamprey zombies in its stomach to allow these crawling horrors to engage the PCs before lumbering forward itself to take part in the slaughter. These creatures fight until destroyed. When the PCs escape the cellar, they find no trace of The Spiteful who laid the trap for them.

**Hell Hound:** AC 15; HP 45 (7d8+14); Spd 50ft; **Melee** bite (+5, 1d8+3 piercing plus 2d6 fire); **SA** fire breath (Recharge 5–6, 15 ft cone, 6d6 fire, DC 12 Dex half); **Immune** fire; **Str** +3, **Dex** +1, **Con** +2, **Int** –2, **Wis** +1, **Cha** –2; **Skills** Perception +5; **Senses** darkvision 60ft, keen hearing and smell; **Traits** pack tactics; **AL** LE; **CR** 3 (700 XP).

## Behind the Scenes

The PCs have now confirmed that they have come to the attention of something (possibly children) that want them dead or incapacitated but do not know how or why. They also may be beginning to suspect that someone is trying to help them (from the sign in the tunnel), though more likely assume it to have been part of the ambush set by The Spiteful.

In fact, with the discovery of the non-human corpses among the murdered children, The Spiteful have decided that the PCs are a dangerous liability that needs to be eliminated before they can spread their knowledge of the unhuman children to someone who may pay enough attention to do something about it (not likely in Castorhage at this stage of the investigation). Regardless, The Spiteful will now be actively attempting to thwart the PCs (murdering them if necessary) to remove them from the case, and the PCs' unknown benefactor (revealed in **Chapter 7**) will be working to provide them with clues when it can. The PCs should not have a direct encounter with either at this point. Use **Appendix I** to run encounters that occur as a result of this newfound notoriety.

## What Next

The PCs have not discovered any new evidence to give them direction on where to go at this point, but they have found nearly conclusive proof that Old Bill was in fact Bloody Jack Carver (or at least closely allied with him), as well as a possible motive for the killings — to weed out non-human children disguised among the human populace of the Blight, though who was doing it, why, or even what they truly are is beyond the PCs at this point.

With no new directions to look, they can now try to follow up on the whereabouts of Madam Larua in **Chapter 4** or look into the background of Inspector Muncy at The Queen's Own pub in **Chapter 5**. When **Chapters 3, 4, and 6** have all been completed, proceed with **Chapter 7**.

# Chapter Four: Madame Larua — Teller of Fortunes and Diviner of Secrets

**The PCs can reach this chapter in the following ways:**

- The advertisement from Old Bill's cart in **Chapter 2**.

**Clues that should be found in this chapter include:**

- Madam Larua always suspected that Bill Hughe was Bloody Jack.
- Madam Larua's last reading for Bill Hughe strongly implicates him as Bloody Jack Carver and coincides with the end of his killing spree.
- Someone or something wanted Madam Larua dead, and it may have something to do with the Bloody Jack killings or the murder of Bill Hughe.
- Some important clue remains to be found at one of the crime scenes (which one is very much up for debate), but it allegedly may trigger a new series of Bloody Jack killings.

**The PCs' investigation can proceed to the following chapters from here if they have not already done so:**

- **Chapter 3** to investigate the sewer entrance.
- **Chapter 5** to investigate the suspicious behavior of Inspector Muncy.
- **Chapter 7** as events proceed behind the scenes if they have already completed **Chapters 3, 4, and 6**.

Following the advertisement on the broadsheet found in Old Bill's cart brings the PCs to the upper edge of the Skew, 200ft of steeply rising streets built upon the edge of the great Festival Pier leading up to the Great Fayre at its summit. The streets are haphazard, full of switchbacks and dead ends, built up on elevated walks around, between and on top of the jumble of buildings crammed onto this artificial precipice. Fortunately, Madam Larua's (LAR-oo-ah) stall is near the top at the inner edge of this hodge-podge of construction where it gives way to the Great Fayre, so it is actually fairly easy to locate.

The encounter at this location works best at night, so assume it is just after nightfall when the PCs arrive here. If they chose to go straight here from the crime scene at Old Bill's hovel, assume that they had a great deal of trouble locating Madam Larua's stall among the tangle of streets that is the Skew. Otherwise, just assume that the amount of time necessary to cross the river and walk from East Ending all the way to the top of the Skew took the better part of the day (along with any other tasks they may have chosen to take care of before hand).

Read the following as the PCs complete the climb through the chaos that is the Skew.

River below up through the tangle of streets that is the Skew to the summit of Festival. The ramshackle streets and elevated walks you climbed rose steeply between the countless hovels and shops, built upon each other like a seemingly never-ending stack of precarious children's blocks. The creaks of ancient timbers shoring up sections of this cobbled-together mass and the all-too-obvious warping and groaning of massive bolts holding key structural elements of the conglomeration together give the entire journey a feeling of taking one's life into his or her own hands. It is not a pleasant sensation, and you are stunned to realize the masses of people that live and work in and among this house of cards. The dailies frequently speak of collapses in sections of the Skew, but they in no way capture the true peril that lurks incessantly among its rising byways and the atrocious loss of life that must occur.

Surmounting the Skew brings you to the summit of the great pier that is the Festival District, and only a few hundred feet away lays the entrance to the Great Fayre, a riot of colour and lights, attractions and screams of delight against a background of never-ending, tuneless calliope music and the lingering smell of urine and fried treats.

However, here at the very verge of the summit, set up outside the limits of the Great Fayre, are endless rows of vendor stalls, many occupied, some abandoned, but all burdened with years of grime and disenchantment. One in particular catches your eye — a ramshackle wooden affair with its back end virtually hanging out over the drop of the Skew below. Faded bunting that was once some shade of purple flutters feebly in the first breezes of the night around a hand-painted sign — long since faded and peeling — that shows an elaborately dressed, sharp-featured young gypsy woman peering deeply into the ubiquitous crystal ball. Still barely legible next to this image are the words, "Madam Larua — Teller of Fortunes and Diviner of Secrets." You have found it.

Though the front door to the small building is closed, the faint glimmer of candlelight can be seen coming from underneath it. Madam Larua is open for business. The stall is a claptrap affair with walls and roof of scavenged timber so coated with decades of gull droppings and blown garbage that it is difficult to see the sagging planks beneath it. The building actually does hang over the edge of the Skew's precipice with a back room built onto and supported entirely by stilts set into the roof of a building below. A locked door opens onto an exterior stair that descends into the mazelike warrens below. Anyone falling off the edge of this precipice or the stairway takes 2d6 bludgeoning damage as he crashes through the flimsy roof of a cottage 15ft below.

The last gleam of twilight has given way to nightfall by the time you finish the climb from the banks of the Great Lyme

## BLOODY JACK

### Madame Larua's Stall - The Skew

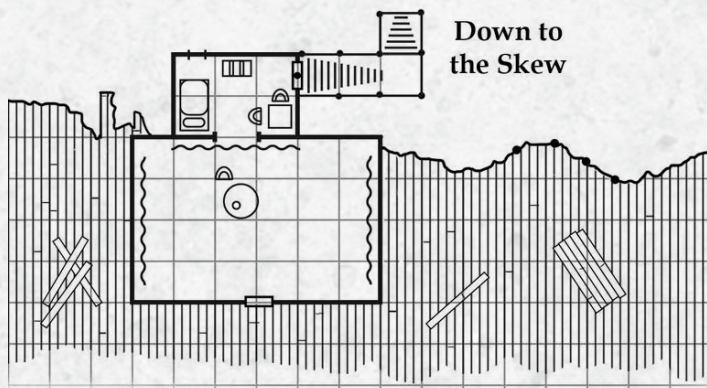

1 square - 5 feet

When the PCs enter, read the following:

It takes a moment for your eyes to adjust to the dim interior of this flimsy structure. The floor creaks, and the floorboards sag noticeably near the back wall where they extend out over the edge of the precipice of Festival. The rear wall even bows slightly from this warping, though much of it is covered by a thick, moth-eaten curtain. The side walls are likewise covered in this manner, and the ceiling is swathed in old, dusty bolts of muslin, giving the entire room the feeling of the inside of a gypsy caravan wagon.

Before the rear curtain stands a small, cloth-covered table. Upon it rests a dust-covered crystal ball with a few well-thumbed, illuminated cards splayed out before it, along with an inkwell and old quill. Behind the table sits a bedraggled, white-haired old woman in threadbare finery and a colourful bandana. Her sharp features sag and have been dulled by age and drink. You assume her to be the aforementioned Madame Larua, but clearly many years have passed since the portrait on the sign above the door was painted. She thumps a half-empty bottle to the floor behind the table and fixes a bleary eye upon you.

The woman before the PCs is indeed Madame Larua (CN female human fortune teller **commoner**), now 62 years of age — an unheard-of lifespan for most residents of the Skew. The spidery veins on her nose and cheeks would reveal her long association with strong drink even if her fetid breath didn't, but she is sober enough to greet the PCs and ask them if they would like to know the future, only 5sp for a reading. She will not even talk to them unless somebody buys a reading which, after taking the money and depositing it securely in her girdle, she conducts by taking the PC's hand and staring blearily into his eyes. She then closes her own and in a monotone states, "Look for a change in your future as ze hidden strength of your character catch ze attention of someone important" — as bland and generic a "fortune" as the PCs have ever heard. If the PC complains about

this, Madame Larua merely shrugs as she takes another sip from her bottle and says in her thick accent, "Zat is what you get for five silver pilasters." She refuses to talk with them further unless they offer her at least 5gp. If they give her a bottle of spirits (one can be obtained at a nearby stall for 1gp), then she lowers the bribe threshold to 2gp. Once given proper incentive, she sips on her bottle and answers the PCs' questions. She knows the following information:

- **Do you know a tinker from 30 years ago named Bill Hughe or Old Bill?** Though her memory is often clouded by age and drink, she actually does remember the troubled tinker. He visited her on many occasions thirty-odd years ago and always had an intense demeanor, like he was on some sort of mission. She found him unnerving.
- **What sorts of questions did Bill want answers to?** He always sought readings on how to find what he called "naughty children". He always seemed very concerned with the whereabouts of these naughty children but never elaborated.
- **Did you ever think anything odd about Bill?** That's why she remembers him: the strangely intense tinker, always asking about naughty children, all during the time that the Bloody Jack Carver killings were occurring. She half-suspected that the strange tinker was Bloody Jack himself, though he never gave any actual hints that he was.
- **Did you ever tell the authorities of your suspicions?** Who would listen to the ramblings of a gypsy? Plus he was a regular customer and his money was good. She never had any real, tangible proof, just a suspicion based on his odd behavior and she was unwilling to lose him as a paying customer on account of it. She always told herself that if he ever gave any concrete evidence that he actually was Bloody Jack, she would report him to the Office of the Watch, but he never did. By the time she had thought of a way to parlay her suspicions to the authorities for a big payoff, Bill had stopped coming to her, and the killings had stopped, so she thought she had missed the boat on that.
- **Was there a reason why he stopped coming?** None that she knows of because he never said. He had been coming at least once a month for several years — sometimes as many as two or three times a week — then he just stopped. She always wondered if the last reading that she gave him caused him to stop coming, but she shrugs the thought away. No matter, he stopped coming; that is all there is to it.
- **What was your last reading for Bill Hughe?** "I have no idea. Sometimes someone come in, gives me five pils, I close my eyes, say some grand words, and send zem on zeir way no better or worse zan zey came. Zey came wanting entertainment and a touch of mystery, and I gave it to zem. But sometimes someone come in, and ze Spirit world really want to talk to zem. When zat happen, I say zings—zings I don't know and don't remember. My mother had ze Sight, and it touch me sometimes like zat. I don't charge anyzing more for zese readings because if ze gods want to talk to someone, far be it from me to interfere. But when ze spirits decide to talk, you don't get your own front row seat. You're just ze carriage; ze spirits become ze driver." However, though she doesn't know the readings herself, she always keeps ink and quill on hand. When under the influence of the spirits (the PCs have to wonder which kind she is referring to here as she polishes off the bottle), she always recorded them on scrolls which she then locked away for posterity. However, she never read them, feeling that it was a private matter between the client and the Spirit world. She always figured it would be bad luck to read their correspondence.
- **If you've still got the final reading that you gave Old Bill, can we see it?** She initially refuses based on her prior claim of bad luck. However if properly plied with coin and/or liquor (10gp or at least three bottles) she relents and agrees to let them see it.

**Development:** After the PCs have paid their latest bribe, Madame Larua ushers them through the curtain into a small room in the back of the stall. It actually sits upon wooden scaffolds out over the precipice. It has only a rude cot, a small table and chairs, a single window with a thin curtain, and a locked steamer trunk. A bolted door leads to stairs descending down into the Skew.

Madame Larua produces a key from her girdle and opens the steamer trunk. Within are dozens of parchment rolls secured with bits of string



## THE BLIGHT: RICHARD PETT'S CROOKED CITY

or ribbon. Each bears a date carefully written on the outside. All of these are true readings that she has had over the last 40 years. She rummages through until she finds one with the correct date 30 years ago (a DC 15 Intelligence [History] check recognizes it as a date approximately 1 week after the last known Bloody Jack killing occurred) and hands it to the PCs. It contains Old Bill's last reading with Madam Larua (**Handout E**).

*"You will soon lay down the knife as your time is done. Another is to come who will return to the scene of the crime and take up the bloody business again."*

If this is shown to Madam Larua, she has no idea what it refers to (though still strongly suspects the Bloody Jack killings). She does recall that as she came to Bill was mumbling to himself something about "grinders" or "grindies" and a "locked gate". He then walked out of the stall and never returned. He was, in fact, talking about Grindlylow's near a particular lock-gate where he had left his tinker cart and was wondering if it might be safest just to abandon it there (which he ultimately did).

Before the PCs can ruminate further upon this information, the whole building shakes as if it had just been struck by a gust of wind from a violent storm front. However, before anything else can be done, a large tentacle suddenly bursts through the tiny window and wraps around Madam Larua's neck. She is able to let out only a small, "Urkl!" before being pulled bodily through the window with the sound of much snapping of bone.

The gypsy's stall has been attacked by an **atrophied gohl**. Also known as a hydra cloud, this flying creature resembles a large writhing mass of tentacles and snake heads. Normally possessing three such snake heads and six tentacles, this particular gohl has been the victim of some wasting condition that has caused one of its heads and three of its tentacles to wither into pale, dangling, useless appendages. It floats in the air beyond the precipice behind the stall and spends the surprise round and the following round devouring Madam Larua and dragging the building from its perch to fall crashing into the structures 30ft below (anyone still inside takes 3d6 bludgeoning damage and must spend a round extricating himself from the rubble before climbing the stairs back to the top of the Skew). It

then turns its attention to the PCs if they have remained around or have attacked it. Even in its atrophied form it is a powerful foe, so though it would normally fight to the death, if it appears to be inflicting too much damage on the PCs, after a few rounds it tires of the battle and departs, disappearing back into the clouded night sky from whence it came and leaving behind no trace except the blood-smeared wreckage of Madam Larua's stall. Regardless of how the battle plays out, the scroll containing Bloody Jack's reading (**Handout E**) disappears in the confusion and cannot be located by the PCs.

**Atrophied Gohl:** AC 15; HP 85 (10d10+30); Spd fly 30ft; **Melee** bite (+7, 10ft, 1d6+4 piercing plus 1d8 acid), tentacle slam (+7, 1d8+4 bludgeoning plus grapple, DC 15 Dex avoid), tentacle constrict (auto hit if grappled, 1d10+4 bludgeoning); **SA** multiattack (bite x2, tentacle slam or constrict x3); **Immune** acid; **Resist** non-silver normal attacks; **Str** +4, **Dex** +3 (+6), **Con** +3, **Int** -2, **Wis** +1 (+3), **Cha** -1; **Senses** darkvision 60ft; **AL** CE; **CR** 5 (1800 XP). (**Fifth Edition FoEs** 124)

The Watch does not respond to the incident; it will take hours for word of events in the Skew to even make it to them, and they'll simply assume there was another collapse. A few yellow journalists for the daily broadsheets might write a sensational story or two. If the PCs seek witnesses to what happened or what attacked, they won't find anyone that actually saw the gohl before it attacked, though a few mention noticing a dark cloud blowing in out of the north (possibly the gohl as it flew under cover of darkness). Universally, the inhabitants in the area will ascribe it to a "black wind blowing off of the Haunted Steppe" far to the north — a common enough superstition for the cause of tragic events in the Blight.

## Behind the Scenes

As Madam Larua suspected, her final reading to Old Bill was the catalyst for him to hang up his persona of Bloody Jack Carver. Not even



## BLOODY JACK

### What Next

Between what is discovered here and **Chapter 3**, it should be fairly clear that Bill Hughe was the Bloody Jack killer. And from here it seems the reason that he stopped stemmed from a cryptic gypsy reading whose meaning even she did not know. If they haven't followed up on the strange key they discovered at Grindlylow's Grinders yet, the PCs can locate Everett Schimp and have him show them the lock-gate he has seen. If they wish to investigate Inspector Muncy's strange behavior in **Chapter 1** or seek to find out more information about old Bloody Jack crime scenes, they can seek to do so at the Queen's Own pub. Finally, they may wish to return to the scene of Bill Hughe's murder thinking there may be more clues regarding what they learned from the gypsy's reading. That is, in fact, a dead end. They find that the Watch has begun its investigation of the scene and has moved many pieces of evidence around, thoroughly muddling any further investigation attempts. Regardless, that is not the crime scene referred to in Madam Larua's reading, so such work is a waste of time anyway.

The PCs can pursue the lead from the old lock-gate key in **Chapter 3** or look into the background of Inspector Muncy or other crime scenes at the Queen's Own pub in **Chapter 5**. When **Chapters 3, 4, and 6** have all been completed, proceed with **Chapter 7**.



he knew what impelled him to do so, but it is the explanation for why the killings suddenly ceased after so long. As to what the reading Madam Larua gave him meant, Bill did not know that either. It is possible that the PCs will believe that it refers to the scene of Bill Hughe's murder or perhaps one of Bloody Jack's old crime scenes, but it actually refers to an altogether different crime scene that will be revealed in **Chapter 6**.

Whether the gohl's attack is a result of the gypsy's ill-starred luck, karma for revealing the contents of one of her true readings, or something engineered by The Spiteful is altogether unclear. The steamer trunk of her other readings is lost when the building collapses down into the Skew, so there are no other forthcoming clues to be obtained. Regardless, the illustrious Madam Larua will be making no more readings and will be of no further assistance to the PCs.

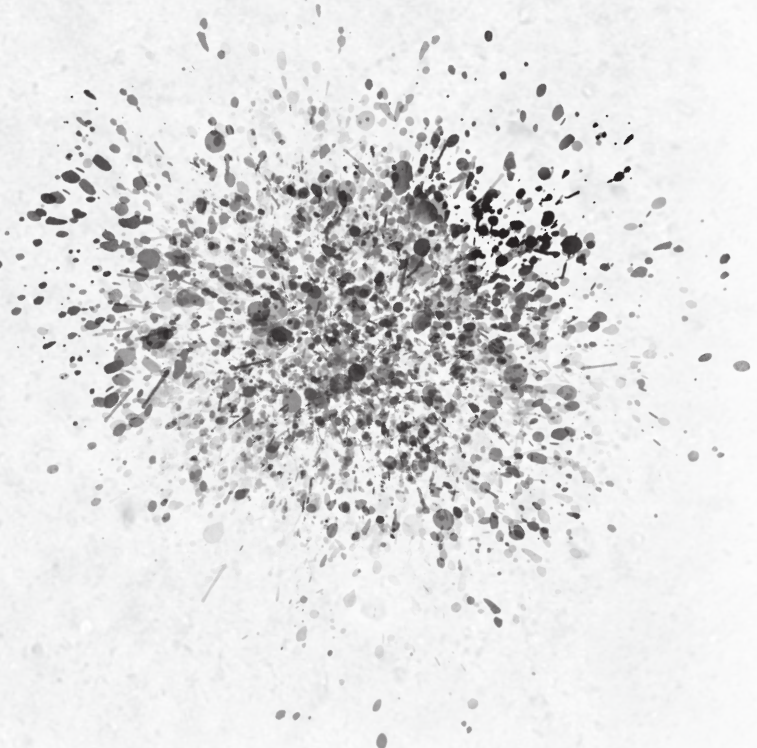

# Chapter Five: The Queen's Own

**The PCs can reach this chapter in the following ways:**

- Following up on the strange behavior exhibited by Inspector Muncy in **Chapter 1**.
- Seeking information or formal Watch reports on other crimes or crime scenes, especially after learning of Madam Larua's reading in **Chapter 4**.

**Clues that should be found in this chapter include:**

- The reason for Inspector Muncy's suspicious activity were the murders of his own wife and child two decades ago that has some eerie similarities to the murder of William Hughe.
- The murder of Inspector Muncy's wife and child was largely covered up by the Office of the Watch, though enough records remain that the PCs could investigate the scene for themselves.
- The crime scene of the murder of Inspector Muncy's wife and child may still be sealed after all these years and could, therefore, still contain some clues that may be of use.
- Someone in Crown Justice Braken's office apparently wants the PCs off the case and is willing to cause them harm to discourage their involvement.

**The PCs' investigation can proceed to the following chapters from here if they have not already done so:**

- **Chapter 2** to investigate any connections with Grindlylow's Grinders.
- **Chapter 3** to investigate the sewer entrance if they have already completed **Chapter 2**.
- **Chapter 4** to locate Madam Larua if they have already completed **Chapter 2**.
- **Chapter 6** to investigate the old crime scene at Inspector Muncy's flat.

If the PCs wish to question Inspector Muncy further, they can simply go to his Watch station and ask for him. Anytime they do so, however, they will be informed that he is away at the moment working a case. The desk constable will offer to deliver a message to him when he returns, though. Regardless of what messages the PCs leave for him, they do not have any contact with the inspector until **Chapter 6**.

Requests for official records or reports from the Watch are met with the advice to seek it at the Capitol. Considering the immense size of the Capitol and the lack of any further information provided on the subject (most members of the Watch neither know nor care about the details of the archiving of records), the PCs should quickly realize this is unlikely to be a fruitful line of questioning.

If the PCs wish to gather information specifically in regards to the inspector or his background, they receive

even less help at the Watch station or among its personnel, but if pressed the obviously irritated desk constable will scowl at them and say, "If yew want to knaow somethin' abaout a gentleman o' the Watch, guv'ner, yaour best bet is to seek it amaong the Queen's Men, if yew ketch my meaning." He then acts dismissive of the PCs for forcing him to be so blatant on the subject and has no further interaction with them.

A DC 5 Charisma (Persuasion) check to gather information easily reveals that "Queen's Men" is a nickname given to Officers of the Watch. A DC 10 Charisma (Persuasion) check reveals that the desk constable was referring to a pub that is a known hangout for Officers of the Watch called The Queen's Own. A DC 15 Charisma (Persuasion) check is sufficient to learn not only the location of The Queen's Own but also that many lazy or unscrupulous members of the Watch who frequent the pub are known to sell information to interested parties (usually the city's yellow journalists for their sensational stories in the dailies) for an occasional extra shekel. This practice is officially frowned upon by the Office of the Watch but unofficially permitted as the Watch pays little enough, hires a plentitude of somewhat unsavory characters, and keeps the corruption to a reasonable minimum, knowing that anyone could be a whistle blower. The PCs should have no trouble blending in at the pub as just another group of broadsheet writers looking for the latest scoop.

If the PCs think to ask about any sort of personnel records or crime reports kept by the Watch, the desk constable (or anyone else in the Watch for that matter) will only state that such documents are stored at the Watch Archives, though questions as to its location will receive either a blank stare (the speaker truly doesn't know and had never really thought about it) or a cursory, "At the Cap'tol, aof course" (for the same reason but making a reasonable deduction). In either case, the PCs will find no one who is able to give them any sort of specific guidance on where to find such things beyond the suggestion that it's the type of thing that can be learned from the "Queen's Men".

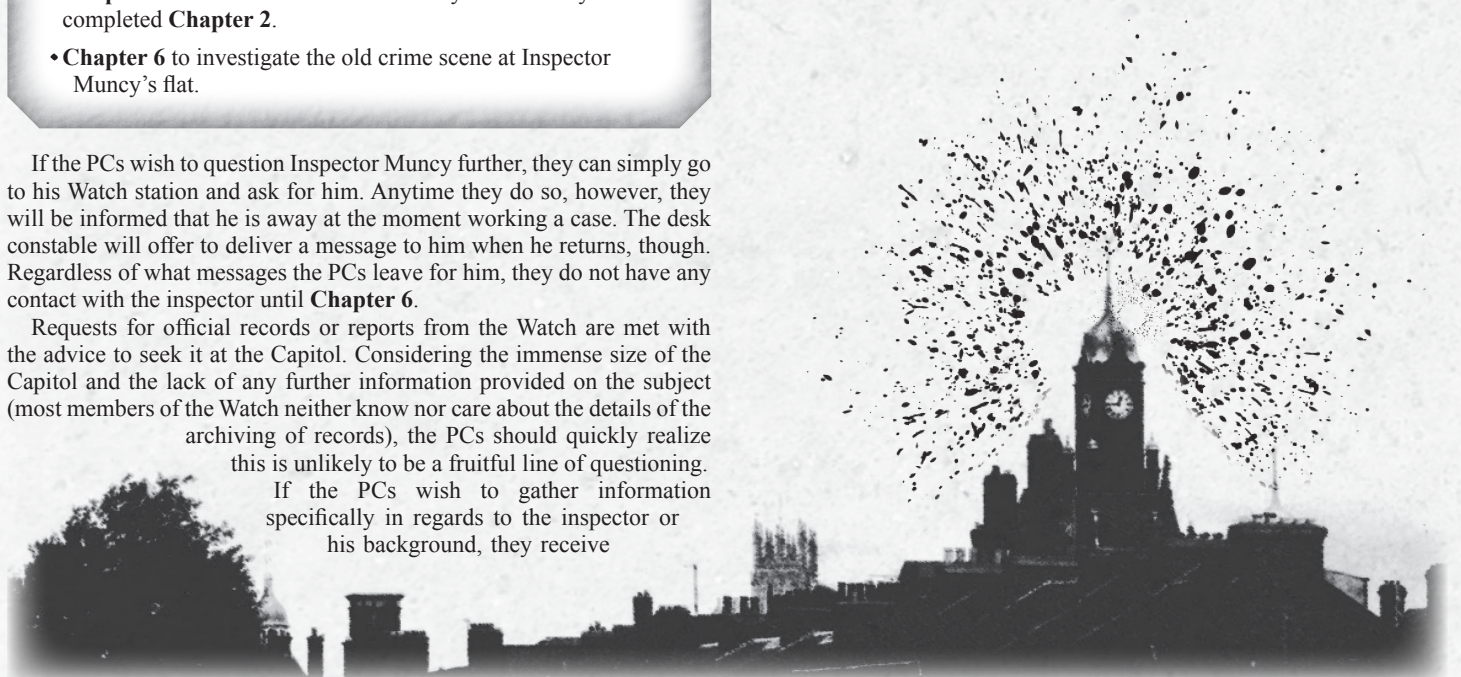

# The Queen's Men

The Queen's Own is located near the Royal South Bridge Gate on Town Bridge. When the PCs approach, read the following:

Reaching the pub is an adventure unto itself. Town Bridge is a hodge-podge maze of dwellings and businesses stacked on top of each other in dozens of levels and extending out over the waters of the Great Lyme in a desperate attempt to exploit every inch of space on the half-mile-long bridge. Its status over the river as being separate from the city exempts it from the city's taxes and has coerced thousands of residents to take shelter and do business within the overborne length of its span. If occasionally a hovel falls off into the swirling brown morass of the river below, it is considered by some a small price to pay to be out from under the immediate boot heel of the municipal government's restrictive administration.

The Queen's Own is quaint enough, lying tucked between a modest haberdashery and the office of a coal speculator. Mashed atop it is a billiard hall accessible by an external stair with some sort of merchandiser atop that. The pub itself has a wooden façade with heavy shutters over leaded glass windows and a decorative pediment over the doors with the heraldry of the Office of the Watch upon it.

Within is a surprisingly large common room complete with a long mahogany bar along the back and numerous shadowy, curtained alcoves with tables where private conversations can be held away from prying eyes and ears. The establishment is bustling with patrons, most in blue constable uniforms but some in the less-noticeable coats of inspectors. Behind the bar, a balding man in a stained apron looks up from polishing the wooden countertop with a rag and stares at you questioningly.

Customers who are not members of the Watch are tolerated within The Queen's Own but only if they are there for information. It is expected that they will buy a drink, pay a bit of baksheesh to the nearest bartender, ask about a topic, and be directed to a likely source of information by that bartender. If the PCs are unfamiliar with this protocol, Bad Mike (LE male human **Ftr3**), the bartender who is addressing them, will gladly fill them in. Drinks cost 1gp each for folks who are not Queen's Men, regardless of what they order (the PCs' current position as deputized constables will not extend them Queen's Men status among the men and women who are lifers within the Watch). In addition to their orders (Bad Mike brings them watered-down versions of the ordered drinks), he expects them to tip at least 5gp and let him know what kind of information they're looking for. Asking about Bloody Jack, Inspector Muncy, or crimes/investigation related to either one will cause Mike to tip his head towards a corpulent parish officer seated at a corner table and whisper, "Fat Windrayke is 'oo ye need teh see. 'E can 'elp ye aout. Don't call 'im 'Fat', though, if ye want teh keep yer teeth. 'E don't care for it much." Bad Mike seems to find this last bit particularly hilarious and bursts into a fit of laughter that is joined by exactly no one in the place. However, the PCs now have a point of contact.

Frederic "Fat" Windrayke (NE male human **veteran**) is a Parish Officer of the Watch for Fourth Ward of East Ending. Inspector Muncy is not a part of his Watch station, but he is very familiar with the inspector and all things related to Bloody Jack. He demands a high-priced glass of wine from the PCs (3gp per glass of which he drinks three over the course of the interview) before fixing his beady eyes upon the PCs over his grossly stretched out, food-stained vest. Questions, his responses and the prices for the information are listed below. He does not have answers for any other questions the PCs may ask but does not charge them for these.

- **Where can we find Inspector Hogan Muncy?** [1gp] I don't know. He is assigned to East Ending Third Ward, so he's not in my stations. I hear he's working a strange killing from the other night — which night

doesn't have a strange killing in East Ending? — but I'm sure he's in and out all the time. If you need to reach him, the best bet is to leave a message with Third Ward's desk constable.

- **What unusual murder investigation was Inspector Muncy involved with 20 years ago?** [10gp] (If the PCs ask about a murder investigation involving a child as the perpetrator, Windrayke will raise his eyebrows and say he doesn't know of any such thing. He'll then say the only one involving Muncy that might fit the bill of what they're looking for is the one involving his own wife and child and continue with the following). Muncy was involved with a controversial murder investigation 20 years ago, and it's possible there was a cover-up involved. It was the murder of Muncy's own wife and child when he was still just a green constable. Muncy himself was cleared of any wrongdoing, but the whole thing was hushed up pretty thoroughly. I never saw the official report, but it and any evidence should still be kept in the Office of the Watch Archives.
- **Where were the crime scenes of the Bloody Jack Carver killings 30 years ago?** [5gp] The Bloody Jack killings went on for nearly three years and involved the disappearance of over 70 local children. Only a handful of those missing kids were ever found, and they were nothing but mutilated corpses. Very few of the actual crime scenes were ever found, and it was supposed that he disposed of his victims after abducting them. None were ever seen alive again, so their murders seem a near certainty. There was some speculation that the various Bloody Jack nursery rhymes that sprang up among the children of East Ending during that time might hold some clue as to the crime scenes or where they were being held, but nothing ever came of that and no one could ever determine where the nursery rhymes originated either. Any details on the Bloody Jack killings would be in their files stored in the Office of the Watch Archives.
- **Can you tell us any of the Bloody Jack nursery rhymes?** [free] Go soak your head in a can of coal-oil, you bloody twit; I don't have time to play kiddy games.
- **Where is the Office of the Watch Archives?** [1gp] The old case documents of the Watch are stored in a municipal building at the foot of the Capitol at the corner of Fiedler and Armistice streets. They're poorly managed, and it should be easy enough to gain access with Watch credentials or a sufficient bribe.

## Office of the Watch Archives

As mentioned, the Office of the Watch Archives is a run-down section of the Capitol, that virtual mountain of officialdom that houses the Royal Family, City Justices, and apparatus of government for Castorhage and towers over the rest of the city in a massive sprawl. The archives stand at its base near the intersection of Fiedler and Armistice streets. It is not necessary to access the Great Doors to gain access to the archives, but a side door and several twisting corridors are necessary to reach its entrance. The PCs may spend a few minutes lost within the halls but will eventually reach their destination. The archives consist of an outer office and the inner stacks. A clerk, Oslo (N male human **commoner**), in the outer office demands credentials or a bribe of at least 2gp to grant access to the archives. He will accept the PCs' status as deputized auxiliary members of the Watch if they choose to use that to enter. He will not provide them any assistance in their search, instead returning back to the daily broadsheet he was reading over a crust of bread and glass of port.

If a PC wishes to and makes a DC 10 Wisdom (Perception) check, he can quickly glance at the most recent visitors to the archives while signing the sign-in book. The clerk will also allow them to examine the book for an additional bribe of 1gp. If examined, the sign-in book shows the archives to be only infrequently visited with no visitors within the last several weeks and none of note then. However, there was a visitor the day before the PCs came who signed in only as "Braken" which the

Office of the Watch Archives  
Inner Stacks

1 square - 5 feet

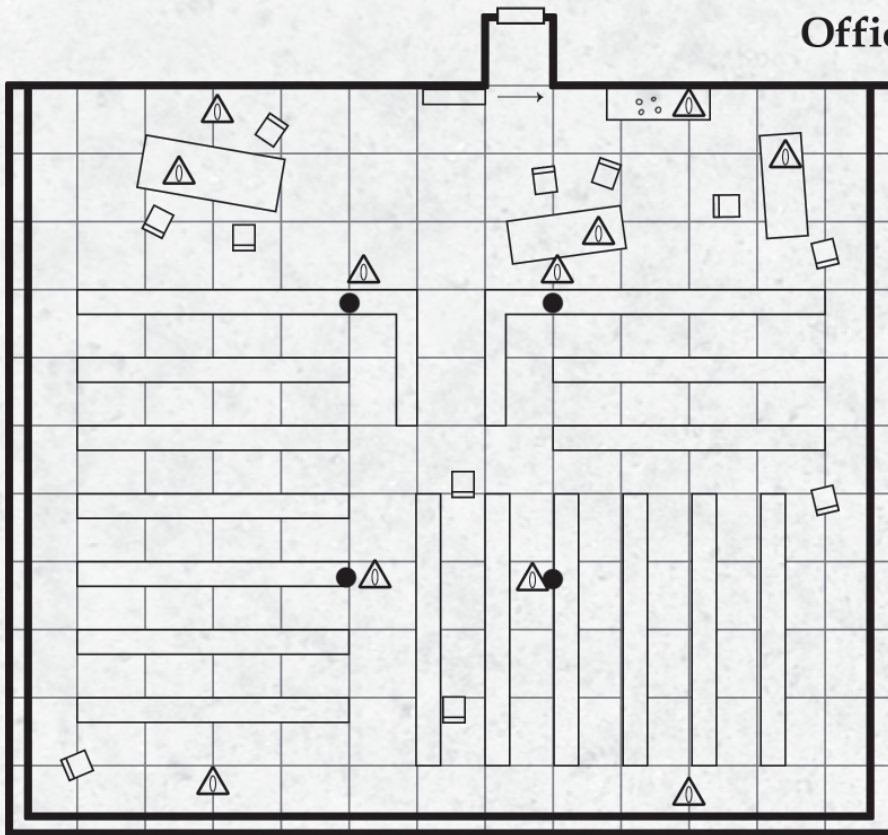

 Oil Lamp



PCs will recognize with a DC 5 Intelligence check as a Crown Justice and senior member of the triad of Crown Justices that rule the city in the name of the Queen. If asked, the clerk can identify him but will state it was only a Least Justice working as under-secretary to the Crown Justice that came. The clerk has no idea why His Resplendent Grand Justice would be interested the archives, nor did he consider it any of his business. He only knows that the Least Justice spent no more than an hour within the archives and then left without a word.

If for some reason the PCs preferred to, they could break into the archives to conduct their search of its files covertly. Doing so would have to occur at night and would require each PC involved to make two DC 10 Dexterity (Stealth) checks and one PC to make a DC 15 Dexterity check with thieves' tools to pick the lock on the door to the closed office. A failed Stealth check causes a patrol of 4 Capitol **Guards** to hear something and come to the area to investigate, requiring a third DC 10 Dexterity (Stealth) check to avoid them. A second failed check means that the PCs have been spotted and must either make a run for it (DC 15 Dexterity [Stealth] check to elude) or stand and fight. It need not be said that getting caught killing a patrol of Capitol Guards is not in the best interests of the party. However, if the PCs do not resist and are just caught breaking in, they will be held over night while their credentials are checked. They will then be released with a warning to return during business hours if they wish to consult the archives. Successfully breaking into the archives reveals all of the same information available as if they had entered during the day.

### Inner Stacks

The repository of the archive opens into a wide, low-ceilinged, stone-walled chamber. Shelves run from floor to ceiling along the far walls and stacks stand like sentinels in ranks going to the back of the room. It seems that every inch of available shelving is crammed with dusty and mildewed

scrolls, sheaves of parchment, books, bundles of papers, and boxes of documents. Tables have been set up haphazardly in the forecourt of the room with a few shelves to allow the documents within the room to be perused. Several oil lamps stand on these tables and hang in sconces throughout the room, carefully shielded from the flammable materials around them. The omnipresent fire danger existing in this chamber is highlighted by the presence of a heavy iron fire door that stands to the side of the entrance ready to be closed in case of emergency.

Despite all the clutter and mustiness, the chamber does contain one point of some note. Small metal spheres built to resemble eyeballs with forceps-like grippers extending from their undersides hover in the air and fly in between the stacks, the low buzz of tiny gears and pistons working furiously to maintain the magical fields that keep them afloat. They move throughout the room tending to the oil lamps and shelving and organizing books and scrolls with their forceps clamp hands. Occasionally they return to a metal box that stands next to the door with small circular holes cut into the top through which they enter and leave.

This massive archive holds the case files of the Office of the Watch going back hundreds of years. The more recent files have a sort of haphazard arrangement, but this organization breaks down as one delves further into the past until finding the most aged documents is a very hit-or-miss affair. Assisting in searches, however, are the **clockwork filers** that orbit around the room. These are clockwork drones that have been outfitted with delicate appendages capable of picking up scrolls and books but little else. They are designed to take orders from users of the archives and then go and retrieve the requested files in addition to shelving materials and just maintaining general upkeep. Care and observation of the oil lamps is one of their primary roles to prevent fires, though these can be used as the equivalent of alchemist's fire if necessary (see "Development" below). The positions of the oil lamps are marked on the map.

## BLOODY JACK

The metal box near the door is the filers' gearbox. There are dozens of the constructs within, but their duties are so taxing upon their magical fields that they must regularly return to this metal box to recharge and receive minor repairs from the mechanisms within. There are no more than 6 of the filers buzzing around the room at any given time. The clockwork filers respond to particular command codes programmed into them and expect users of the archives to give the proper verbal code. When the PCs fail to do so, they become confused and agitated. If a PC makes a DC 10 Intelligence (Arcana) check, he can deduce that they are waiting for some verbal command code. With a DC 15 Intelligence (Arcana) check, he can even determine what that command code is. Going back to ask the clerk is of no help because he seems to have stepped away for the moment.

If the PCs continue to fail to give the proper command code, the filers become agitated and aggressive. They start buzzing around the PCs and bumping into them hostilely. As soon as a PC makes any sort of aggressive move, the 6 clockwork filers attack. They are joined in the next round by 6 more flying out of the apertures of the gearbox, though no others join in after that as they are not sufficiently recharged to fight. Though the filers have metal clamp appendages, these are too weak to use in combat, and they instead rely on slamming themselves into their foes. Once the PCs have destroyed all 12 filers, they have no further trouble with the constructs.

**Clockwork Filers (12):** AC 14; HP 7 (2d4+2); Spd 20ft, fly 60ft; **Melee** slam +1 (1d4-1 bludgeoning); **Immune** charm, exhaustion, fright, paralysis, petrify, poison, psychic; **Str** -1, **Dex** +4, **Con** +1, **Int** -5, **Wis** +2, **Cha** -2; **Senses** darkvision 60ft; **Traits** flyby (no opportunity attack when it flies out of reach); **AL** N; **CR** 1/8 (25 XP).

With a few hours of searching, the PCs can locate all of the Bloody Jack files. They can learn the following information from them:

- There were 74 children that disappeared from East Ending during that time that could not be attributed to other causes. Of those, only the mutilated remains of 21 were ever found.
- No two crime scenes were exactly alike, and other than the use of sharp knives, the gory remains that were sometimes found, and the fact that they were centred on East Ending, there were no other commonalities.
- At least four townspeople were lynched by angry mobs during that time on suspicion that one of them was Bloody Jack (all were butchers or worked in slaughterhouses), but the killings always continued.
- The disappearances began 32 years ago and lasted 38 months before they suddenly stopped for no explicable reason.
- There were occasional copy cat murders over the years, but all were solved and the perpetrators proven that they could not possibly have been the original killer.
- Theories as to the identity of Bloody Jack Carver ranged from a butcher, to a wild animal, to a member of the Royalty, to a demonic outsider. None was ever proven or disproven.
- One report mentions the abandoned Seaside Larder eatery as a possible location of interest for investigation, but it appears that the lead was never followed up.
- The Bloody Jack case went through 14 lead investigators over the three-year period and ruined the careers of at least four of them, but none ever got any closer to solving the case or capturing the perpetrator.
- When the killings stopped, the case was finally closed and forgotten — apparently to the great relief of the Office of the Watch.

If the PCs search for information on Inspector Muncy, they find very little of interest but eventually turn up the case file for the murder of 20 years ago that he mentioned. Even if the PCs don't think to look for information on Inspector Muncy, they find the same case file apparently mistakenly clipped to one of the Bloody Jack files (courtesy of their unknown benefactor). The case file consists of the official report (**Handout F**) which is strangely vague on details but does indicate that the crime scene was placed under an Order of Sequestration to seal it from



any possible contamination of clues. A DC 10 Intelligence (Investigation) check is sufficient to realize that the report does not include a writ lifting the sequestration, so it is possible that the crime scene at Muncy's flat is still undisturbed after all these years. In addition to the report, the PCs find Inspector Muncy's own heavily redacted statement (**Handout G**). It appears to largely be a dead end until the PCs discover that an unredacted copy of his statement is stuck to the back of the redacted one where apparently someone spilled tea on it long ago and didn't realize they had become glued together by the spillage. Carefully peeling the unredacted statement from the back of the redacted one reveals **Handout H**.

**Development:** One of the studies tables to the side of the room bears a number of books over mundane matters stacked precariously next to an upturned metal wastebasket that sits atop the table. There are several stacks of material like this waiting to be shelved, the only difference being that this one sits next to a wastebasket. The PCs should not even notice this unless they have expressed some suspicion over what may be found in the archives. However, at some point before the PCs leave, the vibrations of the PCs movement (and combat) around the room finally causes the stack to give way. It crashes into the wastebasket knocking it off the table and revealing a large rough sphere within that appears to be composed of some greyish papier-mâché. This is actually a hornets nest that has been left here as a trap.

As soon as the nest is disturbed (possibly even by inquisitive PCs), an enraged **hornet swarm** emerges and immediately attacks. Unfortunately for the PCs, the antiquated and none-too-perceptive animated fire security system which consists of a **steam-operated fire door** perceives the cloud of emerging hornets as a cloud of smoke and immediately fires its piston and slides across the doorway, sealing the room. The animated door has malfunctioned over the years, and after sealing, the steam piston breaks loose and becomes a wildly swinging bludgeoning arm that the door uses to make slam attacks against anyone that comes within reach. Only if the animated door is destroyed can the PCs break through to escape the archives, though fortunately for them years of rust and lack of maintenance has reduced its hardness somewhat.

## THE BLIGHT: RICHARD PETT'S CROOKED CITY

**Swarm of Hornets (2):** AC 14; HP 44 (8d10); Spd 5ft, fly 30ft; **Melee** stings (+4, 0ft, 6d4 piercing or 3d4 if the swarm has 50% hit points or fewer); **Immune** charm, fright, paralysis, petrify, prone, restraint, stun; **Resist** bludgeoning, piercing, slashing; **Str** -4, **Dex** +2, **Con** +0, **Int** -5; **Wis** -2, **Cha** -5; **Senses** blindsight 10ft; **AL** U; **CR** 1 (200 XP).

**Steam-Operated Fire Door (Animated Object):** AC 16; HP 44 (8d10); Spd 0ft; **Melee** slam (+4, 2d6+2 bludgeoning); **Immune** blind, charm, deaf, fright, paralysis, petrify, poison, psychic; **Resist** fire, bludgeoning, piercing, slashing; **Str** +2, **Dex** +0, **Con** +0, **Int** -5, **Wis** -5, **Cha** -5; **Senses** blindsight 10ft (blind beyond this radius); **AL** U; **CR** 2 (450 XP).

If the PCs choose to seek information in regards to the hornets nest apparently left for them and the involvement of Crown Justice Braken's office, they quickly discover that His Resplendent Grand Justice sits far too high above them in the hierarchy of things for them to have any chance at finding out information about him or his staff. Any such endeavors are met with impenetrable walls of obfuscation and possibly even veiled threats for attempting to harass the Crown Justice.

## Behind the Scenes

Unbeknownst to the populace of Castorhage, Crown Justice Braken is actually the leader of the Veil, a secret consortium of doppelgangers from Between that are not directly linked to The Spiteful but nevertheless take a sympathetic attitude towards their fellow Betweeners' endeavors. Certainly, they don't want any of the city's ordinary citizens finding out about doppelgangers and other creatures from Between infiltrating the ranks of the city. As a result, Justice Braken uses his considerable influence within the government to monitor happenings within the city that might involve the Veil or other denizens of Between. When he learned of the investigation being headed up by Inspector Muncy and involving deputized specialists, he quickly realized it probably involved The Spiteful (30 years ago he was well-aware that whoever Bloody Jack was, he was waging a personal war against The Spiteful, though he had no better luck in tracking down the killer than anyone else). He also quickly surmised that the PCs would likely at some point be intending to peruse the archives for more information into the Bloody Jack killings or Inspector Muncy's own personal tragedy. As a result, he decided to arrange a little warning to try and persuade the PCs to abandon the investigation.

## What Next

From the archives, the PCs possibly learned many details of the Bloody Jack Carver killings, though none that provide any real additional clues to their investigation. More importantly, they have learned of Inspector Muncy's own personal tragedy from two decades before and the conspiracy to have the matter covered up — at least a start in understanding the inspector's own hidden motives in the investigation. Finally they will know beyond a shadow of a doubt that someone or something with possible connections to Crown Justice Braken is out to get them, because the hornet swarm trap left behind was certainly no accident.

If the PCs wish to head over to Grindlylow's, this is covered in **Chapter 2**. If they have already completed **Chapter 2**, they can follow up the leads discovered there by visiting the sewers of East Ending in **Chapter 3** or Madam Larua in **Chapter 4**. To learn more about the murder of Inspector Muncy's wife and child, the PCs can investigate that old crime scene in **Chapter 6**.

# Chapter Six: The Muncy Flat

## The PCs can reach this chapter in the following ways:

- After discovering the truth of the murder of Inspector Muncy's wife and child and the subsequent cover-up in **Chapter 5**.

## Clues that should be found in this chapter include:

- Whatever occurred in the alleged murder-suicide of Inspector Muncy's wife and child, it certainly involved agents from Between and likely meant that his child had been replaced by a changeling monster.
- Inspector Muncy has not been idle this time and for some reason has returned to the scene of his family's murder ahead of the PCs.
- Inspector Muncy entered Between ahead of the PCs and was badly injured. It is unknown if he survived or was able to escape Between.
- A *mirror-portal* to Between existed near Madam Larua's stall and could have had something to do with her death (if that has already occurred).

## The PCs' investigation can proceed to the following chapters from here if they have not already done so:

- **Chapter 2** to investigate any connections with Grindlylow's Grinders.
- **Chapter 3** to investigate the sewer entrance if they have already completed **Chapter 2**.
- **Chapter 4** to locate Madam Larua if they have already completed **Chapter 2**.
- **Chapter 7** as events proceed behind the scenes if they have already completed **Chapters 3, 4, and 6**.

By this point in the adventure, the PCs are likely very interested in finding Inspector Muncy to ask him some questions of their own, though up to this point he has been frustratingly elusive. At last in this chapter the good inspector makes an appearance, though not in the way the PCs likely had in mind.

The investigation into Inspector Muncy's own background brings the PCs to the flat he once rented with his wife and their infant daughter. As discovered in **Chapter 5**, it was the scene of a "murder-suicide" 20 years ago and has remained sealed off ever since. The flat is in a tenement building on the edge of East Ending not far from Theatre Town. Muncy's wife was an ardent fan of the theatre (when they could afford to go on his meagre constable's salary), and he was willing to pay a bit more in rent in order to have a residence somewhat close to the centre of her passion.

The tenement is a four-storey building of flats that are let out for rent. The building has seen better days. Some of its apartments are still occupied, but a great many are empty as the building has become run-down and many of the flats are too dilapidated to be habitable. A fire escape ladder runs up the backside of the tenement building, but only leads to a sagging, low-pitched roof of rotting shingles and several large stack-like chimneys that vent off the many fireplaces within the building. The old Muncy flat lies on the third floor and is still sealed off by the Watch cordons. The sequestration was never technically lifted, and the landlord was never

## Muncy Flat

1 square - 5 feet



Mirror Portal



able to rent it out anyway due to the rumours of murders, curses, and palpable aura of wrongness that seemed to surround it. As a result it has lain undisturbed through the decades until now. Read the following when the PCs reach the flat.

The floor of the hallway creaks as you leave the warped stairs and make your way down towards the door you are seeking. You find it quickly, the brass number "34" hanging askew from the paneling. A faded, dusty, red rope still hangs across the door, nailed into its surface, sealing the apartment beyond by order of the Office of the Watch. It appears that the crime scene truly has been left undisturbed all these years.

The door is locked and the key long since lost (DC 10 Strength check to break open, DC 20 to unlock due to rust), and opening it will require pulling the nailed rope away from the door — a simple-enough task but one that will leave obvious signs that the seal was broken.

Anyone touching or passing through the doorway immediately feels a sense of unease and terrible wrongness. He must make a DC 10 Wisdom save or be frightened for as long as he remains in the apartment. Once the save has been made, he is immune to the effects of this aura, but he can still feel it. This is a fear effect that cannot be dispelled and is the result of a portal to Between within having long been left open.



## 1. Living Room

The door opens into a small living area. A fireplace at the far end is flanked by a small table with two stools and a worn, overstuffed leather chair. Nearer the door is a wooden rocker, the cheap carpet around it marred by dark brown stains. More of the stains can be made out on the wood of the chair itself. Two doors exit on the left, and a doorway opens into a small kitchen on the right. Everything is blanketed in a thick layer of dust from long years of abandonment.

This living room is where the horrific events leading to the death of Inspector Muncy's wife occurred. The body of Mrs. Muncy was found sprawled in the rocker, the body of her baby lying upon her lap. The baby's fingers were sunk deep into the woman's neck as it strangled her, and her fingers were wrapped around the handle of a kitchen knife that was stabbed deeply just below the child's ribcage and causing it to bleed out onto the rocker and floor. The investigating inspectors could make no sense of the crime scene and unconvincingly declared it a murder suicide before closing the case.

### The Truth of the Crime Scene

The truth of the matter was that a spite-waif had just replaced the Muncy's infant in room 4 when Rebecca Muncy walked in on it. She had been cutting vegetables for dinner when she thought she heard a cry from the nursery, so the knife was in her hand when she entered. Finding the spite-waif consuming her child, she immediately attacked it with the knife. The smaller spite-waif was nevertheless extremely strong and managed to overpower her. Their struggles took them into this room where she collapsed in the rocking chair, repeatedly stabbing the spite-waif as its own childlike fingers remained locked around her neck. With a final wrenching jerk, it snapped Rebecca's spine, killing her instantly. However, she had already stabbed it multiple times so that its own life's blood drained out only moments later. Neighbors that had heard screaming entered shortly thereafter to find the dead mother and supposed infant and immediately summoned the Watch to the perplexing scene. The bodies were long since removed, but the crime scene has otherwise remained undisturbed for all these years.

Searching the room reveals little evidence of the crime from two decades ago other than the blood stains. However, a DC 12 Wisdom (Perception) check reveals a telltale line of footprints leading to the door to room 4 from the north end of the room. Traces of soot can be seen in the footprints. A DC 10 Wisdom (Survival) check (or a modicum of common sense) can trace this trail of footprints back to the fireplace. An examination of the fireplace itself does not require a Perception check that it has recently been disturbed. Soot has been knocked from the open flue showing where someone recently clambered down from the smokestack above and entered the apartment at this point. The footprints in the soot of the fireplace further confirm this. The fact that no dust has accumulated over these footprints confirms that this intrusion occurred very recently.

In addition to the strange clues found in this room, it is also occupied by a **dust vargouille**. This creature resembles a disembodied head with batlike wings for ears composed entirely of dust. In fact, it only forms from the thick dust of the room's northeast corner after the PCs spend more than a round in the room. It is a visitor that came through the still-open portal to Between long ago and took a liking to the dusty surroundings. The recent intrusion from the fireplace awoke it from a long sleep, but not until the PCs start poking around does it become aggravated and coalesce into a semi-solid form in order to attack. It fights until destroyed.

**Dust Vargouille:** AC 13; HP 44 (8d6+16); Spd fly 30ft; **Melee** bite (+5, 2d6+3 piercing plus hit point drain); **SA** dust blast (Recharge 5–6, 20ft line, 3d6 slashing, DC 12 Dex half), exude dust (bonus, blindness while within the 10ft radius cloud, DC 12 Dex avoid each round in the cloud), shriek (Recharge 5–6, 60ft, paralysis, DC 12 Con repeat); **Resist** normal attacks; **Str** –2, **Dex** +3, **Con** +2, **Int** –3, **Wis** +1, **Cha** –2; **Skills** Perception +3, Stealth +5; **Senses** darkvision 60ft; **Traits** hit point drain (permanent until *greater restoration*); **AL** NE; **CR** 2 (450 XP).

## 2. Kitchenette

This small area comprises a cramped kitchen. A door opens into a small pantry on the right. A stone wash basin stands against one wall, and next to it a wooden counter runs the length of the room. Atop it can be seen the shriveled and dried remains of some sort of tubers that it appears someone was slicing at the time the flat was sealed. Like everywhere else, this room is covered in an undisturbed layer of dust.

There is nothing of note here. The pantry holds the long-decayed remains of foodstuffs but nothing of interest or value.

## 3. Bedroom

This bedroom is modestly furnished with a double bed covered by a somewhat threadbare quilt that was likely a family heirloom. A chest stands at the foot of the bed, and a small dresser and mirror stand against the wall. The ubiquitous dust covers everything.

Inspector Muncy and his wife shared this bedroom for the few short years of their marriage. The trunk and dresser hold only mundane clothing and accessories typical to a young family of the Blight with little money to spend on finery. Anything of value was removed by Inspector Muncy before the crime scene was sealed. There is nothing of interest here.

## 4. Nursery

This room is noticeably cooler than the rest of the flat, and the sense of wrongness that seems to pervade the entire place is strongest in here. This is clearly the centre of whatever troubles occurred here long ago. The room, however, is nothing more than a tidy little nursery. The paint on the walls is faded and cracked with the years but was once a merry shade of yellow with a pattern of small blue flowers. A cradle rests next to the door, and across the room is a wardrobe painted white, its door slightly ajar. There is noticeably less dust in here.

Once Baby Adelaide's nursery, it was here that The Spiteful made their presence known to the unfortunate family of Inspector Muncy. Anyone searching the floor for footprints can see the faint traces of soot with a DC 15 Wisdom (Perception) check. A DC 10 Wisdom (Survival) check can trace them from the room's door to the door of the child's wardrobe. A DC 20 Wisdom (Perception) check is sufficient to notice a pattern of dispersal in the sparse dust on the floor, as if blown by a wind coming from the west. This is actually a result of the open portal to Between (as is the colder temperature), but this information is not readily apparent.

Opening the wardrobe reveals that it has a low chest-of-drawers holding old garments and toys suitable for an infant, and atop the chest-of-drawers stands a gilt, 3ft-by-2ft, looking glass. Strangely, the looking glass has been pushed aside in its frame so that it leaves a gap of a few

## BLOODY JACK

inches between the frame and the edge of the glass (even though the glass doesn't protrude from the other side of the frame — as if a portion of the mirror pane has simply ceased to exist), and within the gap can be seen only darkness, though an occasional puff of cold air blows through. The soot stains show that someone recently stood in the wardrobe before this mirror and clearly show the shoe print of a sturdy, government-issue brogan, slightly worn with use like those worn by many a city working man in Castorhage.

Anyone examining this mirror finds that they can easily slide the pane completely to the side revealing an extradimensional opening behind it — an open *mirror-portal* left long ago by the spite-waif that killed the inspector's wife. If anyone slides the mirror all the way closed, it closes the *mirror-portal* and cannot be reopened. This likewise occurs if the mirror is broken. If the PCs do this and fail to obtain the information available beyond, they can still successfully complete the adventure, they will just lack some clues to help them further understand everything going on. In that case, continue with **Chapter 7**. Read the following to anyone that looks into this strange portal.

The land beyond the magic mirror is a nightmare vortex of colours and sounds, with an icy breeze blowing through sporadically. As your eyes adjust to the chaos before you, they begin to pick out details until finally a coherent picture emerges. The landscape is like that of an arctic forest; tall, black pine trees rise into a starless night sky. Their boughs, laden with snow, creak and shift in the wind, the same wind that carries upon it the sounds of a nocturnal forest, but one unlike you've ever heard. The normal sounds of a winter forest are joined by strange screeches and howls that raise the hairs on the back of your necks. Floating randomly across this scene are iridescent bubbles, some singly and some in clusters. They seem to range from inches across to up to a foot or two in diameter and have

no pattern to their flight — some seem to move with the wind and some against — though it is unclear if they are some sort of living creature or just a manifestation of the magic of this strange realm. Regardless, wherever they roam, whatever is behind them is magnified when seen through their bulbous membranes, giving everything a distorted, surreal quality.

Just beyond the mirror a trail of footprints can be seen in the newly fallen snow, leading into the distance between the trees. At the far end of this path, several hundred yards away or possibly more — it is difficult to tell in this tortured landscape — struggles a humanoid figure wearing a bowler and dark coat. One of the bubbles floats across your line of sight just as the distant figure looks back towards this *mirror-portal*, and for a fleeting moment in its magnified curvature you catch a glimpse of the face of Inspector Hogan Muncy before he turns and disappears behind a stand of trees.

Anyone viewing this nightmare landscape and making a DC 8 Intelligence (Arcana) check recognizes it as *Between*, a fabled realm of nightmares and bogeymen used by parents to frighten naughty children and featuring prominently in the nightmares and ghost stories of children good and naughty alike. While most people in the *Blight* have heard of *Between*, it is almost universally considered to be nothing more than children's stories — certainly not an actual physical realm.

Anyone making a DC 12 Intelligence (Arcana) check gains not only the above information but also the greater understanding that some scholars quietly speculate that *Between* actually does exist. It is the land behind the shadows of dark, dusty corners and abandoned attics and what lies in between the waking world and outer planes; a realm of madness and dread that lies on the backsides of the city's mirrors. No one has ever actually visited *Between* as far as most scholars know.



## THE BLIGHT: RICHARD PETT'S CROOKED CITY

A DC 15 Intelligence (Arcana) check confirms that Between is very much real and populated by many malevolent beings that would like nothing more than free access to prey upon the unsuspecting citizens of Castorhage. A DC 20 on the check (a truly monumental accomplishment) confirms all the above plus the whispers that a secret society of the city's elite and powerful (see The Illuminati in *The Blight*) are fully aware of Between and seek to harness its resources and power for their own benefit.

As mentioned, this is a *mirror-portal* left open 20 years ago by the spite-waif that Rebecca Muncy killed. It has remained open and undisturbed since then, though Inspector Muncy discovered it and stepped through it only moments before the PCs arrived at his former flat. If the PCs enter the mirror, they find themselves in the Winter Wood of Between. Inspector Muncy's footprints are clearly visible in the snow for them to follow, but going in any other direction will result in them quickly becoming lost in the trackless forest. If that occurs, proceed with **Encounters 1, 2, 4, and 5** and ignore the **Encounter 3**. They will miss a few clues but should still be on the right track in their investigation. As mentioned, if they fail to enter Between at all, they will likewise miss out on some information as well as XP, but will still proceed to **Chapter 7** for the adventure to continue.

Anyone stepping through the *mirror-portal* finds themselves transported to Between.

## Between

Between is a vast plane of existence, possibly infinite, that exists upon the verges and in the corners of the Blight. Whether Between has connections with the rest of the Material Plane or just a particular affinity with Castorhage is unknown, and some posit that it is actually nothing more than a dark and twisted reflection of the already dark and twisted city. Regardless, Between is an expansive realm, and this adventure touches only upon a small portion of it in an area known as the Winter Wood. Read the following when someone enters the *mirror-portal*.

---

Stepping through the looking glass is like slowly submerging in an icy pond. Once through you find yourself in the twisted, windswept forest that you beheld in the mirror, the dark pines looming all around you and placing ominous shadows upon the snowy landscape. No stars adorn the night sky above, and a single moon, somehow blacker in colour than the surrounding night sky but nevertheless giving off a wan radiance, provides the only illumination other than the faint light given off by the strange floating bubbles. The wind is fiercely cold and bears a strange odor that you cannot quite put a name to. The trail of footprints remains crisp and clear leading deeper into the forest.

---

The temperature in the Winter Wood hovers around 20-degrees and requires the PCs to make a DC 10 Constitution save each hour or gain 1 level of exhaustion unless they use magic or have cold weather outfits to offset this. The wind is considered strong (21–30 mph) and causes disadvantage ranged attacks, extinguishes open flames, and makes nonmagical flying impossible. The snow is less than a foot deep. The lighting is dim for those without darkvision or a light source.

The *mirror-portal* is still open behind the PCs and resembles a pane of mirrored glass propped into the low-hanging bough of a pine tree and giving a view of the Muncy's nursery beyond. If they wish, the PCs can easily crawl back through out of Between, but the wind is slowly but surely eradicating the footprints left by the inspector, so if the PCs wish to pursue him they will need to do so now.

As the PCs follow the trail of footprints through Between, they will have set encounters in the order given below.

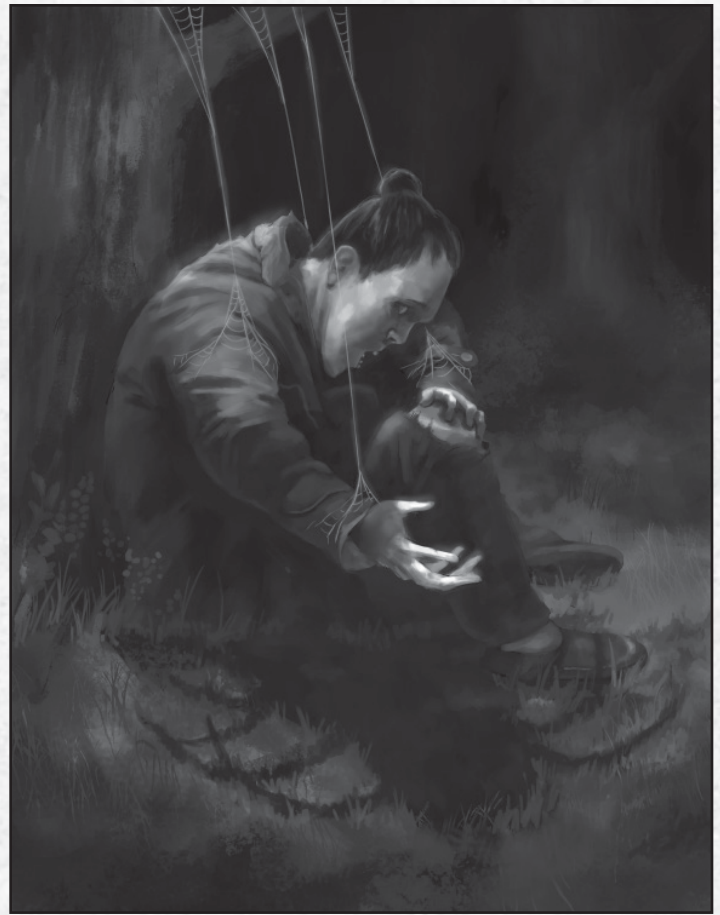

### Encounter 1: Master of Nothing

This encounter occurs whether the PCs are following Muncy's trail or not. It happens less than an hour after the PCs enter Between.

---

As the trail wends through a thick copse of trees, you see a figure kneeling at the base of one of them. He wears the tattered overcoat and crumpled bowler of the typical East Ending street sharps running a shell game or a confidence scam on nearly every street corner. This fellow, however, is extremely out of place as he huddles against the cold at the base of the tree, his back toward you, and appears to be digging into the turf there.

---

Muncy's trail (if present) goes directly past the huddled figure without stopping. The street sharp is actually a decomposing corpse (detectable with a DC 10 Wisdom [Perception] check once the PCs are within 10ft of it) snatched from the streets of the Blight weeks ago. It is being manipulated by the near-invisible web strands of a **grim puppeteer** hiding in the boughs of the tree 20ft above. This large arachnoid creature has thick grey fur that protects it from the cold. It was hunting elsewhere when Muncy came by, and has only recently returned to its lair in this tree. It attacks as soon as anyone approaches its decoy and pursues the PCs if they try to escape.

**Grim Puppeteer:** AC 14; HP 52 (8d10+8); Spd 30ft, climb 30ft; **Melee** bite (+5, 1d8+3 piercing plus 2d10 poison plus paralysis); **Ranged** 2 spines (+5, 20/40ft, separate targets within 30ft, 1d4 piercing plus 2d10 poison plus paralysis); **SA** web (Recharge 5–6, +5, 30/60ft, restraint, DC 12 Str check to escape); **Str** +2, **Dex** +3, **Con** +1, **Int** –2, **Wis** +2, **Cha** –1; **Skills** Perception +6, Stealth +7; **Senses** blindsight 10ft, darkvision 60ft; **Traits** paralysis poison (1 min, DC 11 Con repeat); **AL** N; **CR** 2 (450 XP).

## BLOODY JACK

**Treasure:** Anyone climbing the tree (DC 10 Strength [Athletics] check) finds the creature's lair in a hollow between two branches. Along with drained animal husks and assorted detritus can be found 42gp, a *scroll of gaseous form*, and a *wand of magic detection*.

### Encounter 2: Vengeful Waifs

This encounter occurs half an hour after **Encounter 1**, so that the PCs should have had to make their first Constitution save against the cold.

Small shadows lurch among the trees, just beyond the extent of your vision. It is difficult to count how many because of their rapid movement. The sound of shuffling among the foliage is broken by now and again by a high-pitched giggle, like that of a child. Suddenly you can see them; a line of small children emerging from the shadows into view. But it is quickly apparent that they are not true children because their grey skin seems particularly malleable, and needle-sharp teeth protrude from their widely distended jaws.

The PCs have run afoul of a gang of 3 **spite-waifs** that ran across their trail in the woods and began stalking them. These spite-waifs have not yet visited the Blight in order to take on the role of a changeling, so they have not yet adopted a more humanlike form. They are ravenous and quickly attack in an attempt to overpower and devour the PCs.

**Spite-Waif (3):** AC 13; HP 36 (8d6+8); Spd 20ft; **Melee** bite (+5, 1d6+3 piercing), claws (+5, 2d4+3 slashing); **SA** innate spells (Cha, DC 11), multiattack (bite, claws); **Immune** charm; **Str** -1, **Dex** +3, **Con** +1, **Int** +0, **Wis** +0, **Cha** +1; **Skills** Deception +5, Insight +2; **Senses** darkvision 60ft; **Traits** create mirror portal, perfect copy; **AL** NE; **CR** 1 (200 XP).

**Innate Spells:** at will—*alter self*; 1/day—*sleep*

### Encounter 3: A Grim Find

This encounter occurs an hour after **Encounter 2**.

The trees grow particularly thick in this area, allowing little of the dim light to even reach the forest floor. As a result, there is only a light dusting of snow showing little in the way of tracks. However, just ahead is a small area where one of the forest's ancient trees has toppled over, leaving a snow-covered opening among the trunks. The tracks you follow are clearly visible entering this clearing, but suddenly stop in the middle. There the snow is disturbed as if by a struggle and much of it bears splattered red stains.

Inspector Muncy made it this far in Between when he was attacked by one of the monstrous denizens of the forest. The creature swooped in and attacked him here, severely injuring him and then carrying him off. Examination of the snow shows that his tracks come to a stop at the centre of the clearing where the snow has been churned and thrashed. The footprints never resume and copious amounts of blood can be seen on the snow. Looking around the clearing reveals a single blood-stained left shoe lying near the edge. It is a leather brogan identical to those issued to Inspectors of the Watch. Of more concern is the fact that a severed foot still remains inside the shoe. The PCs have no way of knowing for sure, but the shoe and foot did indeed belong to Inspector Muncy.

With no further trail to follow, the PCs are directionless in the Winter Wood. Attempting to retrace their trail shows that the stormy winds have erased their tracks a few miles behind leaving no trace as to how to reach the *mirror-portal* through which they entered Between. There is no way to retrace their route. The PCs are lost in Between.

### Encounter 4: The Wild Hunt

After wandering aimlessly in the Winter Woods for 2 hours, this encounter occurs.

The forest breaks here into a huge snow-covered clearing nearly a mile across and several miles long. A lonely howl rises on the wind and is carried down the valley. Far to your left, a single figure comes striding over the hill. At nearly half a mile away, it is difficult to make out details, but as you watch, several stiff-legged hounds come loping over the hill after him. One lets out a soul-shattering howl as they all veer towards you.

The PCs have been discovered by a pack of 4 **ghoul hounds** and their houndmaster, a **fetch**. The fetch is typical of its kind with icy blue eyes and a layer of ice crystals in its hair and over its skin. Beneath, the skin is black with frostbite. The creature wears a fur headdress set with the antlers of a stag, though one is nothing more than a broken stump. A half mile away, the PCs can make a run for it if they wish, though the pack will pursue relentlessly and eventually catch up to the PCs. However, the PCs can use the time to prepare for battle on the ground of their choosing. If the houndmaster is killed, the remaining ghoulish hounds retreat and regroup, though they continue to follow the PCs, and their howls attract the attention of other hunting ghoulish hounds roaming the woods. One ghoulish hound will always retreat from battle in order to summon these reinforcements.

**Ghoul Hound (4):** AC 14; HP 60 (8d10+16); Spd 50ft; **Melee** bite (+5, 2d6+3 piercing plus paralysis plus trip); **Immune** charm, exhaustion, fright, poison; **Str** +3, **Dex** +2, **Con** +2, **Int** -2, **Wis** +2, **Cha** +0; **Skills** Perception +4, Stealth +4; **Senses** darkvision 60ft, keen hearing and smell; **Traits** pack tactics (attack advantage with ally within 5ft of target), paralytic bite (1 min, DC 12 Con repeat), trip (knock prone, DC 13 Str to avoid); **AL** NE; **CR** 1 (200 XP).





**Fetch:** AC 14; HP 45 (6d8+18); Spd 30ft; **Melee** claws (+5, 2d6+3 slashing plus 2d8 cold); **Immune** charm, cold, exhaustion, fright, poison; **Vulnerable** fire; **Str** +3, **Dex** +3, **Con** +3, **Int** +0, **Wis** +2, **Cha** +2; **Skills** Intimidation +4; **Senses** darkvision 60ft; **AL** LE; **CR** 1 (200 XP). (*Fifth Edition Foes* 100)

**Development:** Even if the PCs defeat the pack and the houndmaster, they will soon find themselves being pursued by dozens of the undead horrors, certainly enough to overwhelm them and drag them down. Flight is really their only recourse, though with the pack gaining it seems like a temporary solution at best. See **Encounter 5** for more information on the pursuit.

## Encounter 5: A Way Out

This encounter occurs 30 minutes after **Encounter 4**. The sound of baying ghoulish hounds has grown as more of the creatures join the pursuit constantly and, worse still, their calls seem to have grown closer as they close in.

It won't be long before the growing pack of ghoulish hounds catches up to you. The howling has grown as more of their number join the pursuit, and now the sounds of answering howls come from ahead. It seems that the pack has you surrounded with many times your numbers and now waits only to close in for the kill. It appears that your time is running out.

That is what you think, anyway, until you see a reflected glint coming from a tree nearby. Crammed among the roots of an old beech tree is a sliver of glass. It is actually a piece of a mirror, and in the darkness beyond it, you can make out a distorted scene from the Great Fayre in Castorhage.

The PCs in their good fortune have stumbled upon another open *mirror-portal*. This one opens through a funhouse mirror in Festival and is only open the slightest bit. The PCs can easily slide it the rest of the way open and climb through, which places them just outside a funhouse in the Great Fayre. Read the following:

The howls of the hounds echo behind you as you tumble through what turns out to be a curved mirror hanging on the side of one of the many rundown funhouses standing at the edge of Festival's Great Fayre. It is late in the night, but the festivities are in full swing. Above you, you can hear the sound of delighted screams as the Great Wheel carries its passengers hundreds of feet above the fayre, giving them the most spectacular view of the city, short of climbing to the top turrets of the Capitol. In front of you is the edge of the drop-off where the Skew descends down the side of the overbuilt Festival pier. No one seems to have noticed your emergence from the mirror, but you can hear the sounds of the pursuing beasts getting closer.

Unless the PCs want to release a pack of ghoulish hounds into the Great Fayre, they should be thinking of closing the *mirror-portal*. This can be accomplished easily enough by sliding it shut. As before, once this is done it is closed permanently. The PCs can easily manage this before the dozens of ghoulish hounds burst through.

One stall nearby partially hanging over the edge of the drop to the Skew is recognizable as that of Madam Larua — Teller of Fortunes and Diviner of Secrets (see **Chapter 4**). If the PCs have already completed **Chapter 4**, then it is still shattered to ruins and searching it yields no additional clues. If the PCs have not yet visited her and have already completed **Chapter 2**, then they may want to take this opportunity to stop in and see the old gypsy. Regardless, once the PCs realize the proximity of this open *mirror-portal* and the fate of Madam Larua (either in the past or in the future), it may raise questions about the coincidence of its location. Let the players question this and develop a sense of paranoid foreboding; there are no answers forthcoming.

## Behind the Scenes

While the PCs have been busy pursuing their leads, Inspector Muncy has not sat idle. He has been conducting the investigation on his end of things as well. His diligence has kept him away from his Watch Station, which is why the PCs have been unable to make contact with him if they attempted to do so. The inspector's investigation has taken him to certain fringe scholars of the Seminary. There he made his own discoveries about Between and his own deductions. His conclusions led him to the same idea as the PCs, and he decided to break into his old flat to confirm if there might be some connection between the murder of Bill Hughe and that of his wife and child. Still a conscientious member of the Watch, he did not wish to break the sequestration seal and chose instead to clamber down through one of the building's smokestacks. When he discovered the *mirror-portal*, an obsessive need for vengeance, pent up for 20 years, overcame him, and he plunged within, heedless of the danger, in order to take his revenge on those that he rightly assumed were responsible for the deaths of his wife and daughter. Unfortunately, Inspector Muncy's sojourn into Between was far from successful. After eluding several threats, he was beset by a byakhee and carried away after losing his foot in the struggle. While he did eventually manage to escape, badly maimed, his sanity was likewise wounded. The PCs will remain unaware of his fate until he reappears in **Chapter 8**.

## What Next

Clearly something from Between was somehow involved in the death of Inspector Muncy's family. If the PCs have completed **Chapter 3**, then they likely have concluded something of the nature of spite-waifs and their connection to both the Muncy murders and the death of Old Bill. There is a good chance they have even guessed at the motives for the Bloody Jack killings.

If the PCs have not followed up with Grindlylow's Grinders, they can proceed to **Chapter 2** to do so. Likewise, investigations into the sewer entrance or Madam Larua can be conducted in **Chapters 3** and **4**, respectively. If all of these leads have been followed and those chapters completed, then it is time to proceed with **Chapter 7**.

# Chapter Seven: Kechler's Drop

## The PCs can reach this chapter in the following ways:

- The events of **Chapter 7** occur only after the PCs have completed **Chapters 3, 4, and 6**.

## Clues that should be found in this chapter include:

- There are shapechangers loose in the city, and they are aware of both the PCs and Inspector Muncy's involvements in the investigation.
- The shapechangers consist of doppelgangers and spite-waifs (at the least) and they run an organized infiltration out of Currington Clothiers.
- Inspector Muncy is connected to the resurgence of the Bloody Jack killings, apparently to take up the knife and resume where Bill Hughe left off.
- An undead spirit of killed children has been assisting the PCs in their investigation and appears to want to prevent a resumption of the Bloody Jack Carver murders.
- The scene of Bill Hughe's murder is of significance in the resumption of the Bloody Jack Carver killings.

## The PCs' investigation can proceed to the following chapters from here:

- The events of **Chapter 7** lead directly into **Chapter 8**.

After completing **Chapters 3, 4, and 6**, the PCs have essentially gathered all the available clues and determined that Inspector Muncy had likewise discovered the truth of *Between*. However with his disappearance and with all the trails gone cold, the PCs have nothing else to do really. Attempts to find other *mirror-portals* or spite-waif changelings prove fruitless and reports of the threat that the spite-waifs represent or of Inspector Muncy's apparent demise are met with bureaucratic incredulity and/or indifference. The death of a Watch inspector is a matter requiring a great deal of paper work, and with no evidence other than a severed foot in a government shoe, no one is going to be anxious to dive into the process. As a result, the PCs are likely to be frustrated in their efforts to progress further in their investigation and possibly resigned to moving on from the case. However, this state of affairs will not last long.

The morning after the PCs have completed **Chapters 3, 4, and 6** they are approached by a pair of Constables of the Watch at their respective residences (if separated) and gathered together. These two constables advise that Inspector of the Watch Hogan Muncy has discovered a crime scene relevant to their current investigation on the shore of the Great Lyme River and has requested their presence immediately in regards to some break in the case.

If told of the inspector's apparent demise or questioned as to what kind of physical condition he was in, the constables are confused and state that they haven't seen the inspector. His message was delivered to the Watch Station by a courier, and they were immediately dispatched to round up the PCs and bring them to the inspector's location to meet him as soon as possible. No further information was given. In addition, no one at the Watch Station has any further information, the courier having long since departed.

If the PCs question the constables about the crime scene they are being taken to, they will explain it is at one of the old river temples — called the Ghats. This one in particular is known as Kechler's Drop and has been out of use as a temple for years. It gets its current name from the fact that for many years it was used as a prominent smugglers' landing for getting goods into the Bazaar without paying the proper tariffs. The smuggling operation was busted years ago and Odus Kechler was subsequently imprisoned in the Sinks, but the name stuck. Plus it is likely that the location is still used for occasional smuggling, owing to its remote location and the relative infrequency of Watch patrols.

Once the PCs have gathered their gear and are ready, the constables guide them through East Ending and the Bazaar to the Ghats.

## The Ghats and Holy Water Temples of the Great Lyme

Many folk of Castorhage worship river gods and spirits, some imported from the exotic Eastern realms of Libynos. As a result, temples sprang up along this section of the Lyme and became known as the Holy Water District. The Ghats themselves are not temples so much as ritual sites associated with the nearby temples. They consist of stone stairs that descend the river banks to the surface of the Lyme and were once used for ritual ablution ceremonies. However, the quality of the water in the river has so deteriorated, and the quality of the dangers of its aquatic predators so magnified, that they rarely serve this function any longer. Only the extremely brave or extremely foolish choose to enter the waters of the Lyme of their own free will. Now the Ghats are primarily used for cremations, where the deceased are placed on log rafts and pushed into the waters to burn to ash while spectators are safely on shore. When the runoff from some of the manufactories in East Ending is particularly thick, these cremations have been known to set portions of the river's surface on fire. Fortunately, none of these fires has ever spread enough to inflict much damage to property or populace — or at least not any of importance — so the practice is still legally tolerated, though this is largely likely due to the fact that most citizens can't afford the burial fee to be interred in the Lych Field, and the authorities would like to keep the number of decomposing corpses lying in the streets to a bare minimum for the sake of public health. The cremations on the other hand are a cheap and easy alternative to dispose of the dead.

# THE BLIGHT: RICHARD PETT'S CROOKED CITY

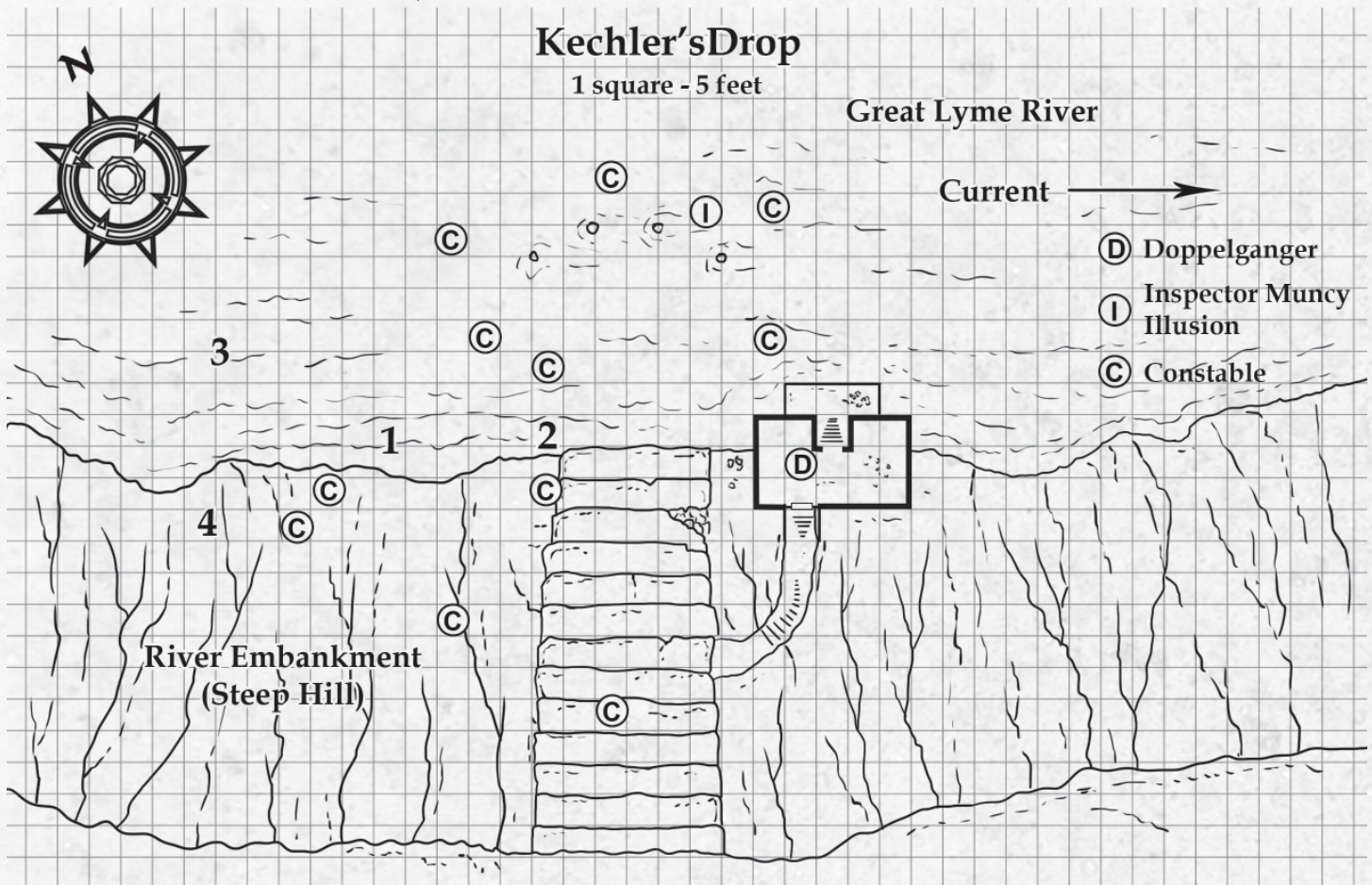

## Ambush at Kechler's Drop

The constables guide the PCs unerringly to the proper Ghat. When they arrive, read the following:

The wind blows off the sea today making the stench of the riverside much more bearable than usual beneath the haze of the late morning sun. The constables guide you to one of the river Ghats. Whichever god it was once dedicated to is a mystery since the standing stone at its top that once identified the deity is worn smooth from years of erosion and acidic rains. The Ghat itself descends in a series of wide stone steps next to a partially collapsed temple building, long abandoned. The tide is out in the estuary so that the lowest steps are exposed and a few yards out into the river can be seen old stone pilings — perhaps from an old pier — that normally lie below the waterline. Wading through the waist-deep water around the pilings are a half-dozen constables. Occasionally one will shout, “I’ve got another one,” to his comrades before marking the spot with a tall willow rod bearing a small red fanion at its tip. There are already more than a dozen of the flagged rods protruding from the water around the pilings, and the wading constables carry several more. Another handful of constables walk along the banks and upon the steps of the Ghat scanning the ground before them.

Standing out in the water near one of the pilings is the familiar figure of Inspector Muncy, looking none the worse for wear. As you arrive, one of the accompanying constables gives a whistle causing those down below to look up. As the inspector catches sight of you, he waves and shouts a “hello” before calling you down to join him and see what he’s found.

Despite what the PCs witnessed in *Between*, Inspector Muncy seems fine. They can’t see his foot because he is hip deep in the river, but he moves without any sort of a limp implying his foot is whole and intact. The PCs may well be suspicious, but there is no evidence to point to anything nefarious. If they ask the constables why anyone is daring to wade into the waters of the dangerous river, he’ll respond that a freshening ocean current for the last few weeks has kept the pollution of the river down to a minimum lately. Plus it being low tide, when the larger predators stay confined to the deeper reaches in the centre of the river, the inspector felt that the risk was negligible to a large and well-armed group of constables. Asking any of the constables on the river bank what has been discovered only gets the clipped reply, “Bones...lots of ‘em.”

Inspector Muncy does not venture to the bank, being too engrossed in his discoveries, so some or all of the PCs will have to wade out to his position. The water here is 3ft deep and is considered deep bog and therefore, difficult terrain. As the constables have discovered, gathered around the base of the stone piers are bones — hundreds of them, all child-sized, and most with vicious gnawing marks. They could easily be three decades old and fit the details of one the *Bloody Jack* nursery rhymes (see **Handout C**). It appears that he secured kidnapped children to the piers and let the estuary monsters consume them as the tide arrived. The bones are far too degraded to determine if any bear the non-human features found on others, but there are easily bones enough for several dozen children. This isolated ruin may well have been *Bloody Jack*’s primary killing ground.

Once the PCs arrive at the piers, Muncy greets them cheerfully and says he discovered this crime scene early this morning. He seems confused if asked about the events of the previous night. He’ll even raise his leg to show his fully intact foot if the PCs like, in order to prove that he is not injured. However, before the PCs can question or interact with him further or get a better look, they are interrupted by screams from a constable as a giant, pale eel bursts from the water to entwine him with its coils. This is followed moments later by more of the eels assaulting the constables with fanged maws.

The Watch force and PCs are under attack by a school of sough-eels. In addition, the moment the attack occurs Inspector Muncy disappears. He

## BLOODY JACK

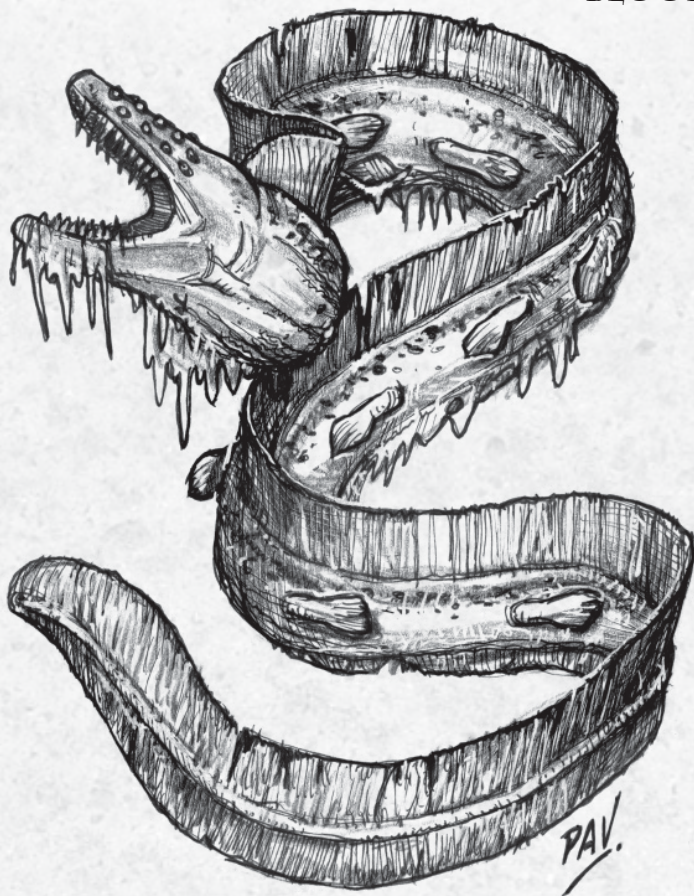

was actually a *major image* created by a **doppelganger sorcerer** that lurks in the ruins of the nearby collapsed temple building. He was disguised as the good inspector, and it was he that had kept the eels at bay and now brings them on in force by having charmed a dominant member of the eel colony. While the constables are being slaughtered by additional eels, the PCs will have to deal with a **sough-eel** on their own. The doppelganger attacks any PCs that remained on shore or uses *fly* to travel out over the river and attack the PCs there from 20ft above if the shore has no likely targets. The doppelganger is overconfident in his abilities and will not think to flee until it is too late, fighting to the death.

**Sough-Eel:** AC 15; HP 126 (12d12+48); Spd 10ft, swim 30ft; **Melee** bite (+9, 10ft, 2d10+6 piercing plus restraint plus sight rot, DC 15 Con avoid); **SA** gnaw (bonus, restrained target, +9, 1d10+6 piercing), swallow whole (bite against restrained target, 4d6 acid); **Immune** blindness, poison; **Resist** piercing; **Str** +6, **Dex** +0, **Con** +4, **Int** -5, **Wis** +1, **Cha** -1; **Skills** Perception +7, Stealth +6; **Senses** tremorsense 60ft, blindsight 30ft; **Traits** water dependency; **AL** U; **CR** 5 (1800 XP).

**Doppelganger Sorcerer:** AC 17 (with *mage armor*); HP 88 (16d8+32); Spd 30ft; **Melee** slam (+7, 1d6+5 bludgeoning); SA multiattack (slam x2), read thoughts, spells (Cha, +6, DC 14); **Immune** charm; **Str** +0, **Dex** +4, **Con** +2, **Int** +0, **Wis** +1, **Cha** +3; **Skills** Arcana +3, Deception +9, Insight +4, Persuasion +6; **Senses** darkvision 60ft; **Traits** ambusher, shapechanger, surprise attack +3d6; **AL** NE; **CR** 6 (2300 XP).

**Spells (slots):** 0 (at will)—*blade ward*, *chill touch*, *fire bolt*, *poison spray*, *ray of frost*; 1st (4)—*mage armor*, *magic missile*; 2nd (3)—*cloud of daggers*, *mirror image*; 3rd (3)—*fireball*, *fly*, *magic image*

**Gear:** silver brooch (150gp), leather scrip with 37gp and book of accounts (see below)

**Development:** The constables in the water are all quickly slain, and their attacking eels disperse to feed upon them. The constables on shore at first try to help their comrades in the water but soon give up after a few of

their number are pulled in. They then retreat back to their Watch Station to bring reinforcements, so that the PCs are left on their own against the doppelganger and their own sough-eel. Any reinforcements only arrive after the battle is over.

In the aftermath of the battle, the PCs find that six constables are dead and at least three were dragged off into the depths of the river and are beyond recovery. However, the body of the fake Inspector Muncy — now revealed as a doppelganger — should be present. Searching through his pockets reveals the items listed under his stat block above. However, one coat pocket also contains a leather scrip holding his cash and book of accounts and identifying him as a floor supervisor of a textile manufactory called Currington Clothiers.

Watch reinforcements will have arrived by the time the PCs begin searching through the doppelganger's belongings, so they will witness the discovery of his scrip and its contents as well. The Watch force for this district is well-familiar with Currington Clothiers, as it is a sweat shop run on child labour that lies not far from the river. Outraged over the loss of so many constables and concerned over the fate of the missing Inspector Muncy, they are equally concerned over the obvious infiltration of their force by a shapechanger. The parish commander is soon on the scene and, after questioning the PCs for as much information as they are willing to give, determines that Currington Clothiers appears to be the source of a doppelganger infiltration of the Office of the Watch that must be immediately stamped out. Before the PCs so much as have a chance to plan their next move, a constable force is underway to make a raid on the manufactory. The PCs can choose to not take part in the hastily assembled affair, but the manufactory is their only existing clue to Inspector Muncy's fate and is as likely a stop as any. In addition if they accompany the raid, they may be able to glean some additional clues during all of the confusion. The parish commander is not averse to them accompanying the raid based on their credentials of working for Inspector Muncy as well as with how they acquitted themselves against the eels and doppelganger.

## Raid on Currington Clothiers

In less than 30 minutes, over 100 Constables of the Watch and Auxiliary Constables of the Watch have been gathered at the Watch Station nearest to Currington Clothiers. The parish officers go over the plan with a handful of sergeants who will be leading the raid. The PCs are free to sit in on this briefing, though they are not formally included in the plans for the raid.

Forty of the auxiliary constables will move from side streets to quickly form a cordon around the manufactory. They are issued longswords from the Watch armory to maintain this cordon and prevent any escapes. Any suspects who flee the manufactory but immediately surrender are to be manacled and hooded for processing. Those who resist are to be killed on sight under the assumption that they are shapechangers and will attempt to impersonate Officers of the Watch if given the chance. While the auxiliary-constables form the cordon, 60 constables led by 12 sergeants will enter the premises from the front and back to conduct the raid. They have been issued shortswords and nets to attempt to eliminate any suspects that show signs that they may be shapechangers and capture any others present so they can be taken into custody and magically tested to determine if they are doppelgangers, with any appropriate charges to be brought against them at a later date. The PCs can join either, both, or neither of these breaches as they see fit but will need to get into the building themselves if they wish to continue their investigation. Regardless, their assistance will not be necessary on the main raid itself. Encounters have been specially prepared for their involvement.

A map of Currington Clothiers has been provided. The Watch officers gain entry by means of a portable ram administered to the front and rear doors and catch the inhabitants of the textile mill by surprise. The front breach enters the front office of the mill where a surprised human security guard attempts to resist and is quickly slain. The raid then carries through onto the main manufactory floor. The back breach goes directly onto the



## THE BLIGHT: RICHARD PETT'S CROOKED CITY

main manufactory floor. Regardless of which means by which they enter, as soon as the PCs (assuming any are present) make it to the main floor of the mill, read the following:

With the piercing shrill of Watch whistles ringing in your ears and the crash of a broken door, the surge of blue-coated constables pours onto the main manufactory floor of the clothier. The room is huge and spacious with the raftered ceiling over 30ft above. The entire floor is crammed with battered wooden tables, their legs cut short to make them lower, wherein scores of ragged children labour away at cutting from bolts of cheap cloth and stitching together clothing. Walking watchfully among these wretched urchins are a dozen or more scowling, burly men holding short whips or caning rods for encouraging greater production from their charges.

As the Constables of the Watch come crashing through the door, the startled children let out a wailing cry of fear almost as one. The foremen on the floor are equally startled by the sudden entrance, and for a moment the face of more than one of them ripples into a featureless plane before resuming their grizzled human appearance, unintentionally giving themselves away as shapeshifters among the crowd. Seeing this, the constables howl out cries for blood against the duplicitous beasts and charge into the crowd, spear points bared.

Soon the floor of the manufactory is a massive scrum, as constables throw nets over scrambling children and adults alike and overbear any of the foremen that appear the least bit resistant in flurry of stabbing spears. Above this chaos, a stair rises along one wall of the manufactory to the second floor offices located behind a row of doors and windows overlooking the work floor. For just a moment you catch a glimpse of movement in those darkened windows, as if something took a furtive peek out at the melee below. None of the constables seems to have noticed this movement in the windows or are the least bit concerned with the rooms above in fact, so consumed are they in their vengeance over the loss of their fellow officers down at the river.



Currington Clothiers is a sweat shop run on child labour (perfectly legal within Castorhage) and serves as a front for The Spiteful to operate within the city. All of the supervisors, managers, foremen, and shift bosses are actually doppelgangers. Hundreds of indigent children are employed on the work floor of the manufactory and dozens of them are actually spite-waif moles that were not able to be successfully placed into Castorhage homes as changelings. There are currently a total of 7 **doppelgangers** and 15 **spite-waifs** on the work floor along with 126 human children. The constables are dealing with these, though, so the PCs are free to explore the upper reaches of the manufactory. All of the windows looking out over the manufactory floor are thickly curtained from the other side, so the PCs cannot look in through them.

### 1. Upper Office

The door to this room is locked (DC 15 to open), though the window in the brick wall beside it can be easily broken. Anyone attempting to climb in through the window is attacked by the room's occupants.

A thickly curtained window looks out over the balcony, and another window in an outside wall lets in a dust-laden stream of sunlight. Two large desks sit before an exit in the far wall, and several battered chairs are arranged around the room. Wooden filing cabinets line the back wall.

The shift bosses use this room as their office. The furnishings are mundane, but the filing cabinets hold records on every employee of the manufactory. This seems innocuous enough, but with the knowledge that

all of the adult employees appear to be doppelgangers, this will provide the Watch with the means to track down many members of The Spiteful quickly before they are made aware of the raid and have a chance to assume new identities. It can also help them track down child employees with discrepancies in their household information to pin down some of them that may be spite-waifs. Regardless of the outcome of the PCs' investigation, the information contained herein reveals to the Watch a greater plot of infiltration into the city by shapechangers and sets the plans of The Spiteful back by generations.

Two men occupy this room dressed as shift bosses for the manufactory in thick dungarees and work boots. These are actually 2 **doppelgangers** that retreated to this room when the raid began. As soon as the PCs enter, one throws an alchemist's fire at the filing cabinets while the other attacks. The first then joins in the attack. The PCs have 2 rounds to put out the burning filing cabinet (an action requiring a DC 10 Dexterity save to beat it out with a cloak or similar tactic) before all of the files are destroyed. The doppelgangers each carry keys to the manufactory's front and rear doors as well as the doors to this room and room 3.

**Doppelganger (2): AC 15; HP 52 (8d8+16); Spd 30ft; Melee slam (+6, 1d6+4 bludgeoning); SA multiattack (slam x2), read thoughts 60ft; Immune charm; Str +0, Dex +4, Con +2, Int +0, Wis +1, Cha +2; Skills Deception +6, Insight +3; Senses darkvision 60ft; Traits ambusher (advantage on attack with surprise), surprise attack +3d6; AL NE; CR 3 (700 XP).**

**Ad Hoc XP Award:** Award each PC 1500 XP if they manage to save the personnel files from being burned.

# Currington Clothiers

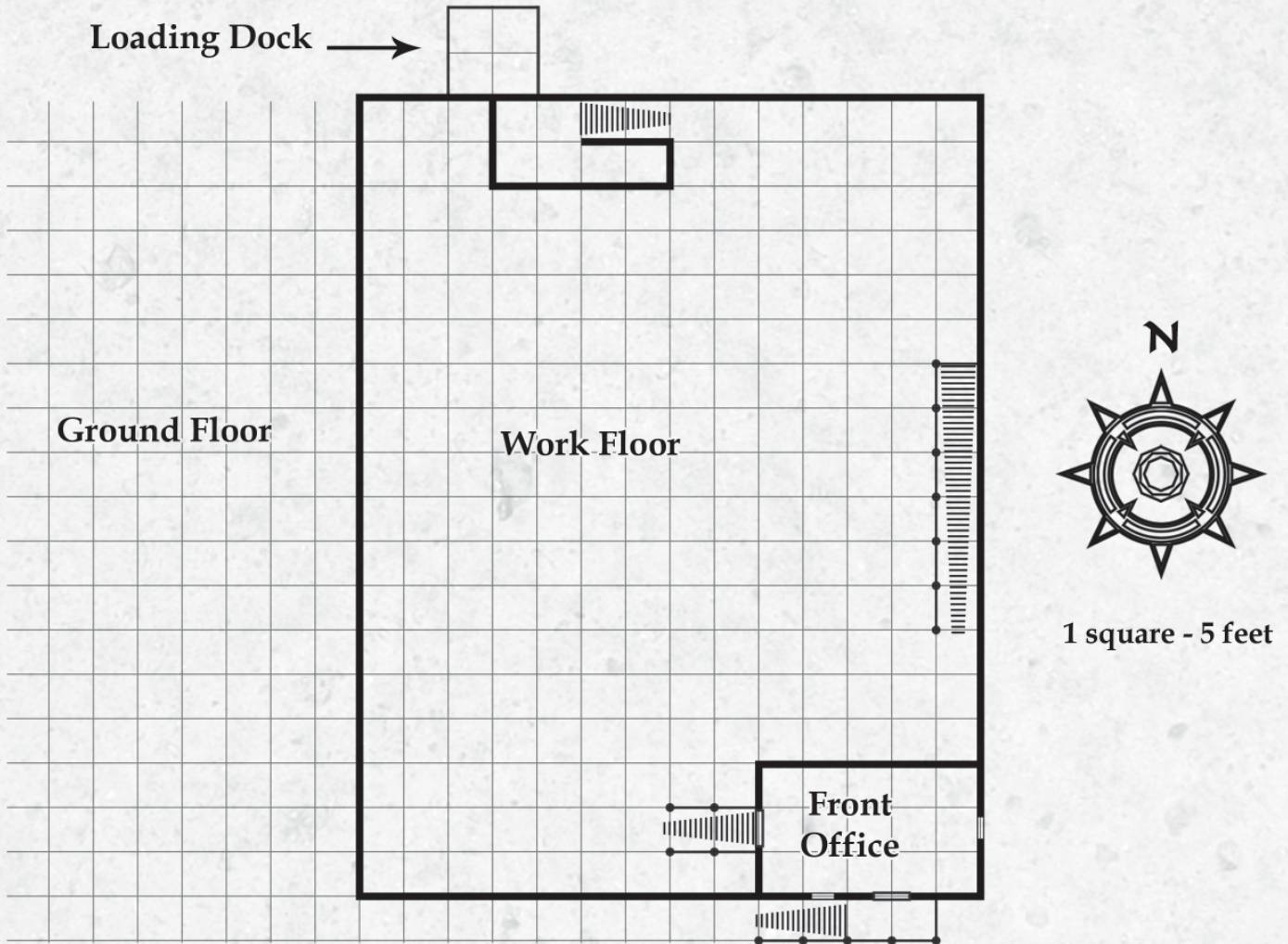
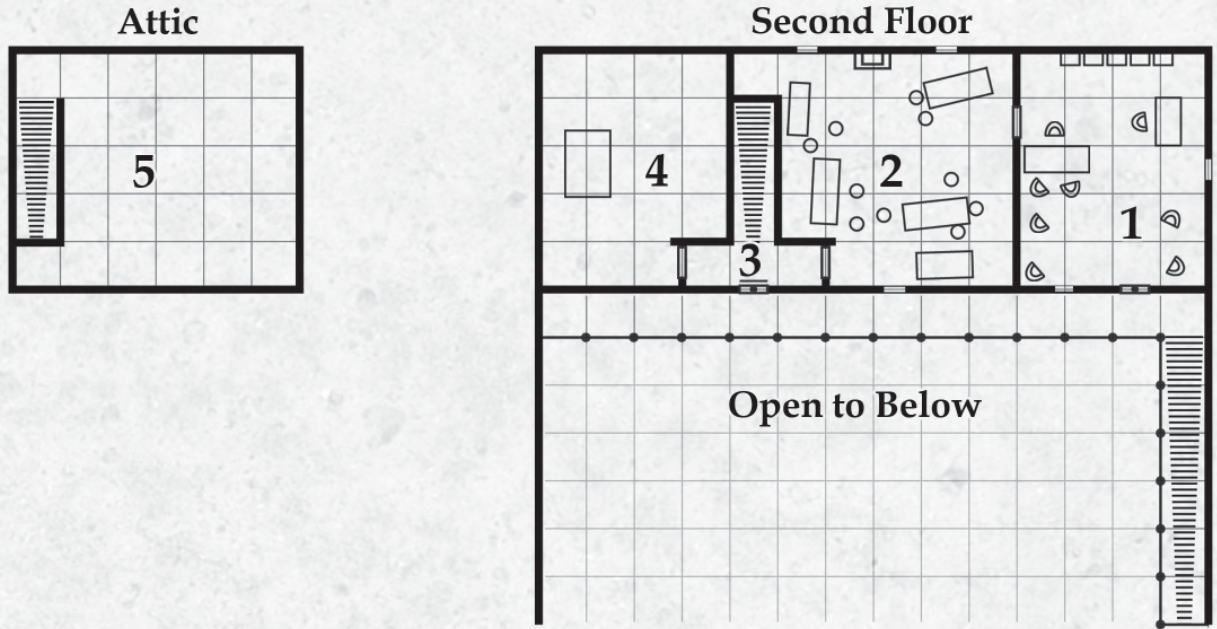

## 2. Foremen's Breakroom

Several tables are set around this room, with stools scattered among them. Dirty crockery sits atop some of the tables, and more is stacked in a porcelain sink basin. A pipe leading from a rooftop cistern ends at a spout just above this basin.

The doppelgangers of The Spiteful often take a break in here and plan their further strategy. There are currently none here, though 4 **spite-waifs** cower under one of the tables trying to appear as normal frightened children. They wait until the PCs have let their guard down or can otherwise get close enough to attack unarmored PCs before dropping their pretense of innocence.

**Spite-Waif (4): AC 13; HP 36 (8d6+8); Spd 20ft; Melee** bite (+5, 1d6+3 piercing), claws (+5, 2d4+3 slashing); **SA** innate spells (Cha, DC 11), multiattack (bite, claws); **Immune** charm; **Str** -1, **Dex** +3, **Con** +1, **Int** +0, **Wis** +0, **Cha** +1; **Skills** Deception +5, Insight +2; **Senses** darkvision 60ft; **Traits** create mirror portal, perfect copy; **AL** NE; **CR** 1 (200 XP).

**Innate Spells:** at will—*alter self*; 1/day—*sleep*

## 3. Storage Access

This door is locked and barred from the inside and does not have any nearby window for easy access.

## 4. Manager's Office

The stench of decay is almost overpowering in here, mixed with the ammonia smell of tanning hides. Piles of leather in various stages of tanning, from bloody and fresh to well-preserved and supple, are piled about the room or hang from hooks set in the ceiling rafters. Closer observation, however, reveals that those tanned hides that are still intact enough to identify bear a humanoid shape. Across the room, a large work table has been set up where these hides are in the process of being stitched into skillfully made shirts, jackets, and trousers.

The manager overseeing this manufactory on behalf of The Spiteful is an aberrant creature from Between known as a **skin stitcher**. In its natural form it appears to be a humanoid without skin, merely moist, corded muscles, coated in a purplish slime, grown over exposed bones and sinew. However, it uses the harvested skin of humanoids to create elaborate skin suits for itself, so that at first glance it appears to be a portly human with sagging jowls and a thick swatch of grey hair atop its head wearing a loose-fitting robe and sandals. A DC 15 Wisdom (Perception) check reveals the true nature of its skin suit as does approaching within 5ft to reveal the many lines of stitching comprising the raiment.

The skin stitcher designs the clothing patterns for the manufactory using the harvested skins of indigents it hunts on the streets, and these patterns then form the basis for the cheap clothing produced by the manufactory. When the PCs enter, unless they see through its disguise, the skin stitcher plays the part of an outraged tailor being interrupted at his work and claims ignorance to any nefarious goings-on within the manufactory. However, its Deception check due its low Charisma (reflected in its croaking inhuman voice), and the presence of the many humanoid skins in the room further belie its story. Once it has been found out, it grabs its spiked chain from beneath its robes and fights to the death.

**Skin Stitcher: AC 16; HP 91 (14d8+28); Spd 30ft; Melee** spiked chain (+6, 2d4+3 slashing); **SA** multiattack (spiked chain x2), rage (after damage on following round, +2 damage bonus, advantage on Str checks and saves, resistant to bludgeon-

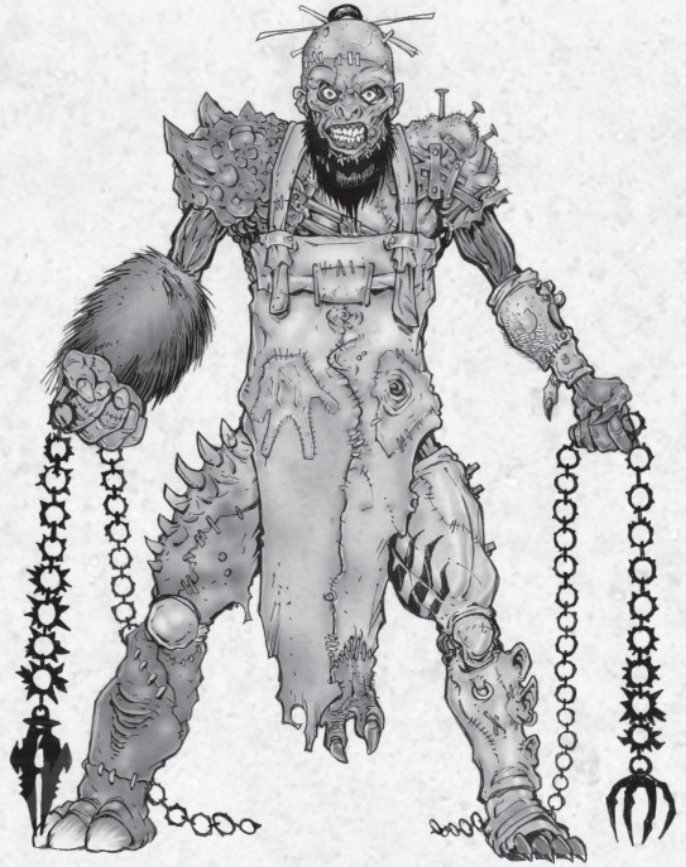

ing, piercing, and slashing); **Str** +3, **Dex** +2, **Con** +2, **Int** +0, **Wis** +1, **Cha** -2; **Senses** darkvision 60ft; **Traits** improved critical (19 or 20); **AL** CE; **CR** 5 (1800 XP).

## 5. Storage Loft

This attic is dark and quiet. It is quite hot and stuffy from all the body heat rising from the work floor below and being captured beneath the gable of the building's roof. Piles of finished textiles, forgotten in the back corners of the manufactory, are stacked along the walls waiting for sales or deliveries that will likely never happen. These huge mounds of clothing muffle all sound, and everything lies beneath a fine layer of textile down given off by the constant cutting and working of fabrics in the workshop below.

If the PCs search the chamber, they find in one of the back corners, amidst a drift of textile down, an **attic whisperer**. It resembles an amalgamation of thin children's bones, infants' bed clothes, and bits of dust and fuzz, all with the hand-painted head of a dolly atop it. PCs making a DC 10 Intelligence (Investigation) check recognize the dolly from having seen it in a corner of Adelaide Muncy's nursery (room 4 in Chapter 6), causing them to realize that the attic whisperer was present when they were there. The mud-stained stockings on its child-sized feet likewise allow a DC 15 Intelligence (Investigation) check to realize it must have left the prints in the drainage tunnel (area 3 of Chapter 3) of the Sewagers' Guild as well when they discovered the nursery rhyme on the signboard. It suppresses its aura of sobs to prevent any discomfort to the PCs. The attic whisperer was formed from the essences of the many innocent children murdered over the years by Bloody Jack and The Spiteful, all bound together by the tiny conscience of the infant Adelaide Muncy. It has served as a hidden benefactor to the PCs throughout their investigation and has one final piece of information to give. Its actions are detailed under "Development" below.

## BLOODY JACK

### What Next

**Development:** The attic whisperer does not speak, but if not attacked, it produces a piece of charcoal from its rags and writes an inscription on the floor, a never-before-seen final verse to the Bloody Jack Carver nursery rhyme (see **Handout I**). It then hands the PCs **Handout E** recovered from the rubble of Madam Larua's stall in **Chapter 4** and a small pair of blood-stained tinker's pliers that the PCs recognize as having come from the scene of William Hughe's murder. If the PCs attack the attic whisperer, it unleashes its aura of sobs and quickly retreats under a nearby pile of textiles. If the PCs dig for it, they are unable to find it but do find the message inscribed in charcoal (**Handout I**) and the crumpled paper that is **Handout E** lying beneath. It does not reappear in this adventure.

The Spiteful have been dealt a major blow and largely nullified in the city for the time being, but the PCs are now aware that the Bloody Jack killings may resume at the hands of Inspector Muncy. As such, the only course before them if they wish to prevent this from happening is to track down the inspector and stop him. The only lead they have is Madam Larua's admonition to return to the scene of the crime, and the hint from the attic whisperer that the crime in question was the murder of Old Bill. The PCs must head back to where the adventure began in order to try and stop Inspector Muncy before the killings begin anew. Doing so brings the PCs into **Chapter 8**.

### Behind the Scenes

The Spiteful have become fully aware of both Inspector Muncy and the PCs and their involvement in investigating the murder of William Hughe, as well as the fact that they are gaining information that could lead to the exposure of The Spiteful and their plot within Castorhage. While Inspector Muncy managed to escape Between, even though maimed, and The Spiteful subsequently lost track of him, they did not lose track of the PCs and chose to imitate the missing inspector to lead the PCs into a trap. In doing so, however, they grew careless and caused their operation at Currington Clothiers to be discovered. The resulting raid inflicts considerable damage upon The Spiteful and their plots and largely removes them from the adventure as adversaries of the PCs. Those members who survived the raid quickly go to ground and assume new identities to avoid the subsequent Watch round-up that occurs soon after, and those changelings already in place are no longer receiving instruction from The Spiteful for the time being and must carefully remain static in their assumed roles without exposing themselves. The PCs have no further means to track The Spiteful at this time.

However, the final prophecy of Madam Larua to Bill Hughe has come to pass, and Inspector Hogan's sojourn into Between was sufficient to both destroy the rest of his sanity — already strained since the murder of his wife and child 20 years ago — and make him aware of the threat that The Spiteful changelings represent to the city. He has therefore determined to take up the mission of Bloody Jack Carver, and it is up to the PCs to stop him before he begins indiscriminately slaughtering the children of Castorhage.

# Chapter Eight: The Bloody Business

The PCs can reach this chapter in the following ways:

- The events of **Chapter 7** lead directly into **Chapter 8**.

After the events of **Chapter 7**, the PCs are led by the information found there back to the hovel of William Hughe, where their investigation began. Upon arriving they find that little has changed at the scene other than that the body was removed by the Watch. In addition, the red cordon nailed across the door has recently been removed, showing that someone has been here since they left.

A careful search of the hovel does reveal the following items of interest with the appropriate Wisdom (Perception) DC listed next to it, however. Each discovery requires a separate check.

DC	Find
0	A swath of bandages covered in fresh blood lies wadded atop Bill's bed. Next to it is a small hack saw and the sawed-off handle of a wooden mallet. The head of the mallet cannot be found.
5	Lying on one of the work benches is a rolled parchment ( <b>Handout J</b> ), a note left for the PCs by Inspector Muncy.
10	A dried blood spatter on the floor near where the body lay has a clear spot in its centre shaped like a knife. One of the tinker's knives that lay here (and was likely used during the murder) has been removed. A DC 15 Intelligence (Investigation) check can identify the shape of the knife as a kermabit, a sharp, scythelike blade that can be worn around the pinky by a loop and easily concealed in a coat sleeve, yet remain ready for quick use.
15	Two empty potion bottles have rolled under the bed. A DC 15 Intelligence (Arcana) check can identify the dregs as having been <i>potions of greater healing</i> .
20	A floorboard under one of the work benches is slightly askew. Below it is a secret compartment with a few blue stains marring its floor. A DC 10 Intelligence check identifies the stains as essence of ether poison — Bill's stash, sealed away for all these years.

These finds should be sufficient for the PCs to deduce that Inspector Muncy has survived Between (though obviously badly injured) and intends to assume the role of Bloody Jack Carver in hunting spite-waifs within the city...and apparently with the same lack of discrimination between the monsters and real children. The PCs can choose to report their findings to the Watch, but they are implicating an inspector in good standing for a crime that, in all likelihood, he hasn't even committed yet. Even with his confessional note, if they can find a sympathetic ear it will still likely be far too late to save his initial victims. A resurrected serial killer is on the loose, and the PCs are the only ones in a position to stop him before his bloody work begins.

Therefore, the PCs' first task is to try and determine where the inspector is likely to strike first in his newly adopted crusade. There are innumerable

orphanages, alms houses, blind alleys, and street corners where he could gain access to unsuspecting and poorly tended children, however, anyone making a DC 10 Charisma (Persuasion) check to gather information among the inhabitants of the Blight will recall that this very night is the beginning of the Annual Children's Carnival at the Great Fayre — an event where there will be thousands of unsuspecting, unattended children just ripe for the depredations of a monster like Bloody Jack to begin writing new nursery rhymes in blood. It officially opens at sundown, which, after the chaotic events of the day, is only an hour away. It'll take at least that long to get there from Bill's place in East Ending, but if the PCs hurry, they may be able to make it in time.

## The Annual Children's Carnival

The Children's Carnival is an event that occurs annually at the Great Fayre on the Festival pier. For 5 days, the parents of the Blight take leave of their senses and drop their children off at the Fayre to romp and play late into the night among free rides and concessions. The parents of the Blight would normally never do this sort of thing, but since its inception 20 years ago, the Children's Carnival has been remarkably safe and free of incidents if only because the villainous and ghastly inhabitants of the city simply haven't thought of any depredations to inflict on the Carnival yet. That is all about to change as the reign of Bloody Jack Carver is renewed at this festive occasion. It is up to the PCs to prevent this from happening.

The Carnival starts at sundown each night of the 5 days and lasts until 2 hours before dawn. Due to the crowds and the difficulty in getting around the city, at the PCs' best speed they cannot make it until an hour after the Carnival has opened. By then, thousands of children are already in attendance. Read the following as they reach the top of the Skew and behold the scene of the Carnival.

Whereas the Great Fayre was crowded before, with the advent of the Children's Carnival it has become absolutely packed with humanity — mostly in the age range of 6 to 14. Colourful streamers have been added to the faded and garish décor of the Fayre and wide banners proclaim the Children's Carnival open to the children of Castorhage. The sight of packs of children running towards you screaming makes you grab weapons in alarm at what may be chasing them, until you realize they are only at play among the amusements and engrossed in the games and the vast quantities of sugared treats they are consuming. Locating a child killer among these children will be like locating a needle in a stack of needles.

The Great Fayre is surrounded by a wooden palisade 8ft high, its inner and outer faces painted with all manner of advertisements for attractions and rides. Unless the PCs try to sneak into the Carnival requiring a DC 20 Dexterity (Stealth) check and creating all sorts of problems for them if they are caught, they will need to enter through one of the gate turnstiles. Entry is free, but access is controlled at these points to turn

## BLOODY JACK

away ne'er-do-wells. The following encounters occur as the PCs explore the Carnival, culminating as they locate Inspector Muncy atop the Great Wheel (**Encounter 5**). Unless otherwise specified, any combats that occur are considered a part of the show and general chaos of the Carnival, so that while those in the immediate vicinity move to get out of the way, no alarm is raised or Watch officers called in. The PCs will likewise find that they are also unable to raise the hue and cry among the pandemonium of the Carnival.

### Encounter 1: Carnival Gate

---

The nearest entrance into the Carnival is a gate with a ticket booth and iron turnstile. To either side are the wooden palisades that surround the Fayre. Painted to the right of the gate is an elaborate illustration advertising the "Infamous Four-armed Ape of the Veiled Isle: Captured and Brought Live From the Razor Sea and Put On Display for the Discriminating Audience of Castorhage." The fencing on the other side of the entry gate simply bears a painted advertisement for "Dr. Turgaband's Miraculous Medicating Ointment — the Miracle Cure for Rashes, Piles, and Rheumatic Fever." Standing in the ticket booth and admitting children one at a time through the turnstile is a bored-looking guard.

---

The gate is manned by a hired security **guard** who looks askance at a group of armed and armored adults attempting to enter the Children's Carnival. Unless the PCs make a successful DC 15 Charisma (Deception or Persuasion) check or use their credentials as deputies of the Watch, he attempts to prevent them from entering, resorting to combat if necessary. He quickly surrenders if reduced below 10 hp, however.

**Development:** If the guard is made cooperative or beaten in combat, the PCs can question him. While thousands of children attend the Carnival, very few adults do so. As a result, those that do enter stick out conspicuously. If the PCs ask the guard about any adults that may have entered, the guard remembers them pretty well. None matches the description of Inspector Muncy, but he does recall a one-legged clown that entered a half-hour earlier. (The clown is actually a red herring [see **Encounter 3**]; Muncy managed to sneak in by climbing over the palisade.)

### Encounter 2: Ubiquitous Animal Escape

This event occurs shortly after the PCs enter the Carnival, possibly on the tail of a one-legged clown.

---

With so few adults in attendance among the throngs of children, it is relatively easy to pick them out from among the crowd. Thus it is not long before you catch sight of the clown. Though you can only see his upper body among the crowds, you can tell he walks with a short, stutter hop at every step. He is ushering a group of children into a petting barn when his eyes scan across the crowd and make contact with yours. He quickly ducks inside, but not before reaching out and releasing the latch on a nearby animal cage. The giant hyena lounging within suddenly perks up as the cage door slowly swings open, and it begins looking expectantly at the many delicious children milling about as it paces towards the aperture.

---

The clown (described further in **Encounter 3**) has just released the cage door holding a **hyaenodon** kept on display for the crowds. The PCs cannot get to the cage in time before thehyaenodon escapes, but they can arrive before it has a chance to start eating any bystanders. If the PCs think to use a *mage hand*, they can close and latch the cage before the beast escapes and obtain XP just as if they had defeated the creature. Otherwise they'll



have to fight it to prevent it from victimizing the children nearby. The massive hyena stands nearly as tall as a man at the shoulder, with a blunted face and vicious fangs.

**Hyenodon:** AC 12; HP 45 (6d10+12); Spd 50ft; **Melee** bite (+5, 2d6+3 piercing); **SA** rampage (reduce target to 0hp with melee, bonus to move half speed and make a bite); **Str** +3, **Dex** +2, **Con** +2, **Int** -4, **Wis** +1, **Cha** -2; **Skills** Perception +3; **AL** U; **CR** 1 (200 XP).

### Encounter 3: Machinations of an Evil Clown

This event occurs if the PCs follow the one-legged clown into the petting zoo barn.

---

The square barn is 50ft on a side and quartered into four animal pens with a 5ft aisle running between them. Each pen's rail is only 3ft high allowing even small children to climb them, and a small gate provides access for those toddlers too small to hop the fence. The pens hold an assortment of sheep, poultry, small calves, and strangely large toads the size of a food platter, respectively. Milling along the aisles and among the pens are numerous small children. One group of children is huddled near the toad pen, looks of confusion and fear on their faces. A clown flees across that pen towards an exit door in the rear wall of the barn. The clown has one leg, the stump of his brightly panted left leg ending in a heavy, coiled spring giving him an odd hopping motion to his gait.

---

## THE BLIGHT: RICHARD PETT'S CROOKED CITY

The fleeing clown is not Inspector Muncy, though beneath the baggy clown clothes and face paint this will not be evident until he talks or is disabled and examined. Rather this painted entertainer is actually a criminal (**spy**) named Gimlet. Gimlet led a group of well-heeled children from affluent families in Castorhage into this barn in order to kidnap them and hold them for ransom (a covered wagon holding bindings and gags waits out back to stow them in and sneak them out as a cartload of garbage when the Carnival closes for the night). Gimlet spied the conspicuous-looking PCs at the same time they saw him and assumed they were onto his plans and fled. When the PCs enter, he is 30ft away and making for the back door, but his old maiming injury from long ago ensures that he moves only slowly and the PCs will have a good chance to catch him before he makes his escape. Assuming they are assassins hired by one of his many enemies, Gimlet fights for his life, only surrendering when he is reduced below 20 hp, at which point he confesses everything if still alive. He actually knows nothing about Bloody Jack or the spite-waifs and is dumb-founded by any stories the PCs tell of such things.

**Development:** If the PCs capture Gimlet alive and force his confession, they can turn him over to a nearby security guard for the Carnival who will deliver him to the Watch. The grateful families of the children Gimlet nearly absconded with send the PCs a reward of 200gp each the next day.

### Encounter 4: Children of the Damned

This event occurs as the PCs are crossing the Midway.

You scan the crowds, moving down the Midway, as you continue to search for Inspector Muncy. Ahead, a small group of children messily eats a batch of freshly made, pulled taffy. At your approach, two of them notice you. They bare vestigial fangs hidden in their gumlines and hiss menacingly as the other children run in fear from this sudden display.

The PCs have run across 2 **spite-waifs** on the Midway. They are members of The Spiteful and have been made aware of the PCs' presence in the city through that group's network of informants, but are unaware of the recent raid on their headquarters at Currington Clothiers or that Bloody Jack is hunting them again. Therefore, they know only that the PCs represent a threat that must be eliminated. They attack and fight to the death, beginning by throwing their taffy which act as tanglefoot bags. Any witnesses to this battle quickly flee to find a guard, but the PCs will have the opportunity to be long gone before any members of the Watch arrive to try and sort out an apparent child murder.

**Spite-Waif (2): AC** 13; **HP** 36 (8d6+8); **Spd** 20ft; **Melee** bite (+5, 1d6+3 piercing), claws (+5, 2d4+3 slashing); **SA** innate spells (Cha, DC 11), multiattack (bite, claws); **Immune** charm; **Str** -1, **Dex** +3, **Con** +1, **Int** +0, **Wis** +0, **Cha** +1; **Skills** Deception +5, Insight +2; **Senses** darkvision 60ft; **Traits** create mirror portal, perfect copy; **AL** NE; **CR** 1 (200 XP).

**Innate Spells:** at will—*alter self*; 1/day—*sleep*

### Encounter 5: Bloody Jack Unveiled

This event can occur at any time you are ready to bring the adventure to its climactic conclusion.

It is beginning to seem impossible to find the inspector among the teeming masses of thousands of children in the dimly lit carnival. There are simply too many places he could be and too many shadows to hide in. Despair is just beginning to set in when you are distracted by the sound of metal gears squealing and grinding to a halt. At the south edge of the

Fayre the Great Wheel, a Ferris wheel that towers 300ft over Festival, lurches to a shuddering stop in its revolutions. The screams of glee from its occupants become screams of fear as the occupants of its topmost gondolas realize they are now stuck on the swaying contraption hundreds of feet above the pier. Just barely visible in the gloom of night, a single figure can be seen laboriously climbing among the many girders that comprise the Great Wheel. The figure moves awkwardly as if one leg was lamed.

The figure is too far away for the PCs to be able to shoot at with ranged attacks, and by the time they arrive at the base of the Great Wheel he has already disappeared among the tangle of girders far above. At the base they find everything in confusion. The operator of the giant machinery points out a crowbar wedged into the gears that operated the machine's revolutions. Its insertion has stripped and jammed the gears so that the Great Wheel will not turn again until major repairs have been undertaken. He has just shut down the steam furnace to prevent a pressure overload and is coaxing children to climb down from the lower gondolas, but is at a loss as to how to get the children in the upper gondolas safely out. If asked about how the crowbar got there, he says a limping man dressed like a Watch inspector just came up and shoved it in before beginning to scale the Great Wheel itself. The screams of the children trapped above can still be heard from below, but those in the topmost gondola continue with the most frequency and urgency. Something is being done to the children in that gondola.

### The Great Wheel

The Great Wheel is something of an anomaly in Castorhage in that it lies in a city powered by flesh and necromancy, yet it is instead a contraption of steam power and gas — a true oddity of oddities in the spectacle that is the Great Fayre. A great steam engine lies buried below the boardwalk directly beneath the Great Wheel. Here a gas-powered furnace heats water pumped up from deep in the depths of the Lyme (where it is cleanest and least damaging to the pipes) to create the steam the propels the motions of the Great Wheel. In addition, unlike the pyre-beetle lamps that illuminate the rest of the vast city, the builders of the Great Wheel installed another novelty. Hundreds of gas lamps fed by lead tubing that runs up through the support girders of the entire structure. While highly unusual for the city-state, this arrangement prevents the need for workers to climb about on the girders and replace the pyre-beetles every night. This creates a convenience for the operators of the Great Wheel but an unusual danger for the PCs and they pursue their quarry.

The gondolas of the Great Wheel are covered affairs made of tin, 15ft long, by 4ft high, by 3ft wide. A wooden bench runs down the back of them from end to end and the front is completely open except for an iron bar that runs across at a height of 2ft for anyone seated on the bench to hang onto as they look out over the urban sprawl of Castorhage. The entire contraption hangs from a great iron swivel joint suspended from the iron girders that comprise the Great Wheel. The gondola benches can hold 5 adults comfortably, but during the Children's Carnival it is not unusual for as many as a dozen kids to be squeezed into one, and here on opening night the gondolas are all full to capacity.

The Wheel itself is composed of iron girders a foot thick held together by great rivets. As a result, it can be scaled with only a DC 10 Strength (Athletics) check. Walking on the girders does not require an Acrobatics check to balance, but moving at greater than half speed or melee combat requires a DC 5 Dexterity (Acrobatics) check (DC 7 on the girder if it is sloped at less than a 45-degree angle, DC 10 if sloped at a greater angle). If a PC takes damage while balancing on a girder, a new check is necessary to avoid falling off.

# The Great Wheel

1 square - 5 feet

Side View

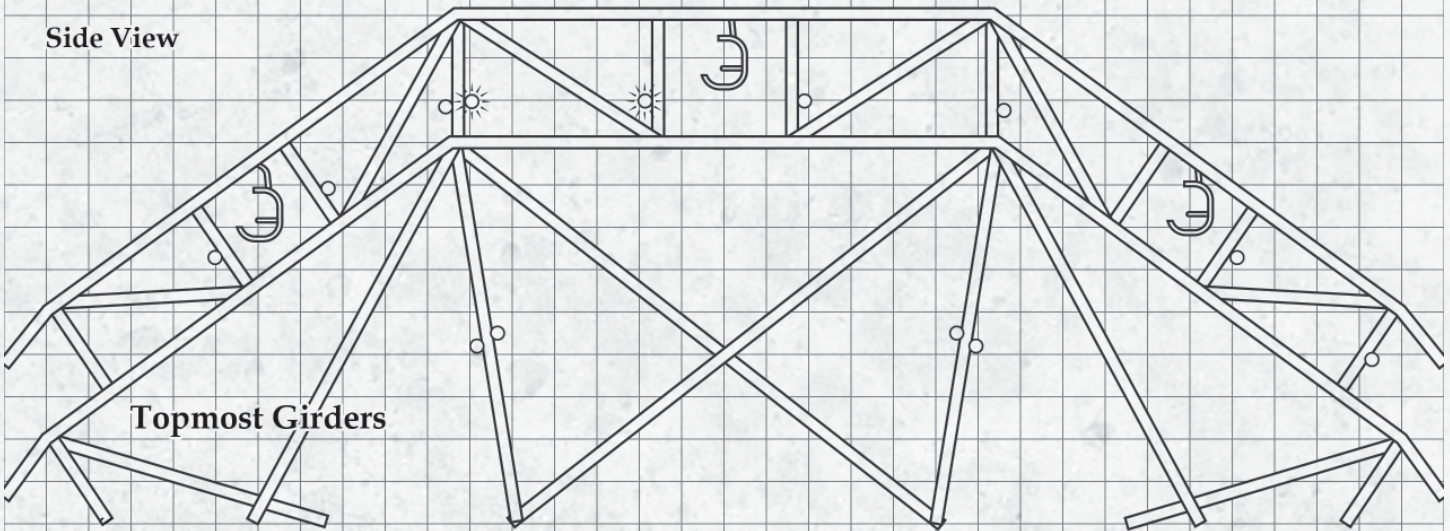

Topmost Girders

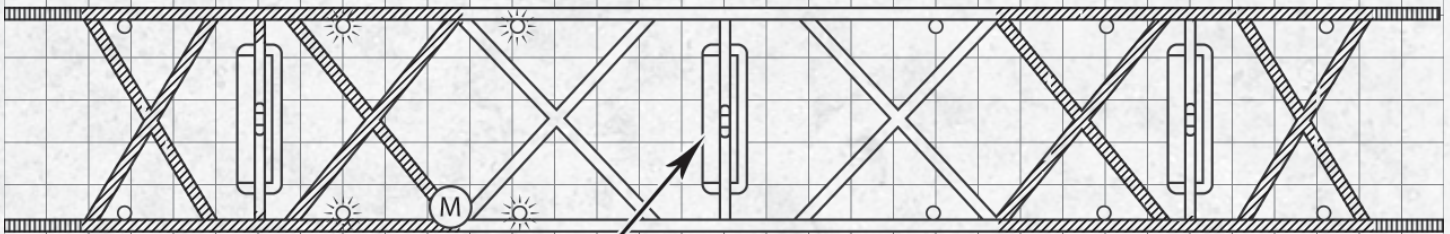





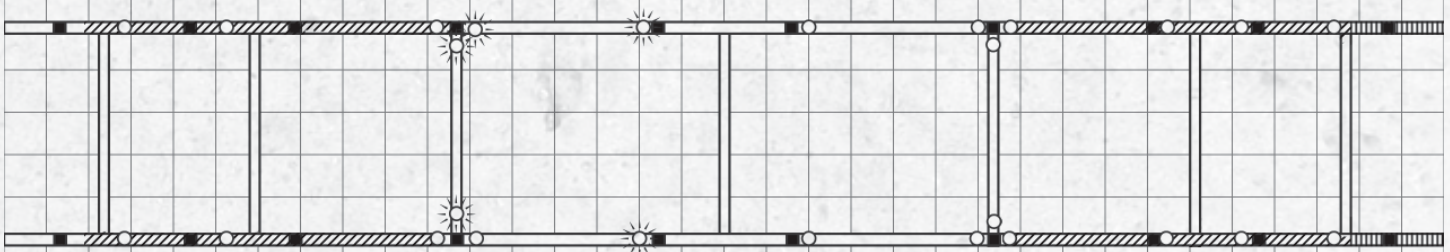

Gondola with Children

Girders 15 Feet Below



## Key for Top View

-  Horizontal Girder (DC 5 Acrobatics)
-  Less Than 45° Sloped Girder (DC 7 Acrobatics)
-  Greater Than 45° Sloped Girder (DC 10 Acrobatics)
-  Vertical Girder (DC 10 Climb CHECK)
-  Gas Lamp
-  Damaged Gas Lamp
-  Inspector Muncy



## THE BLIGHT: RICHARD PETT'S CROOKED CITY



**Falling:** Anytime anyone falls from the Wheel while climbing or balancing, they only fall 1d3x10ft before hitting another girder. Falling damage is taken as normal for this fall, but then allow a DC 15 Dexterity save to grab hold of the girder. If the check is failed, the individual falls another 1d3x10ft before hitting another girder and having another chance to stop the fall, and so on. Anyone stopping his fall in this way must use a move action to climb back up onto the girder he grabbed before being able to otherwise act or climb back up to the battle.

Lighting the entire Wheel are gas lamps built into the supporting girders at regular intervals. They are continuously lit providing normal illumination. If a gas lamp is broken, it explodes in a 10ft radius that deals 2d6 fire damage within its area of effect (DC 15 Dexterity save for half) and requires a DC 10 Dexterity save to avoid catching fire. After the initial explosion, the thin lead pipe feeding that gas lamp melts and seals itself, ending any threat it poses.

**Tactics:** Now thoroughly insane and engrossed in his plot to hunt spite-waifs, **Inspector Muncy** has jammed the Great Wheel in place and taken the occupants of the entire top gondola hostage. He intends to scare a confession out of them as to which are real children and which are spite-waifs in order to only kill the proper ones, but he is prepared to kill them all if no confessions are forthcoming. Of the 12 children in the gondola one of them actually is a **spite-waif**, but it has no intention of dropping its ruse and drawing the ire of this madman, playing its part to the finish unless somehow unmasked by the PCs. If exposed while free, it immediately attacks the closest opponent in a bid to escape in the confusion.

Inspector Muncy wired the wooden head of a mallet to the exposed bones of his severed ankle, and then drank *potions of greater healing* to seal the wound shut as well as he could. He now wears a heavy work boot over that foot and has smeared both it and his other shoe with thick, sticky pitch. As a result, he does not have to make Dexterity (Acrobatics) checks to stay balanced on the girders.

Inspector Muncy has tied all of the children to the bench with hemp rope and applied a vial of acid to the swivel joint holding the gondola aloft. When the PCs arrive atop the Wheel, they can see the smoking, slowly dissolving joint and have 10 rounds before it gives way, dropping

the entire gondola to a crashing fall among the girders before coming to a rest 300ft below. Anyone still tied into the gondola when this occurs will not survive. A single PC with a slashing weapon can free 2 children per round with an action. Once free, a child immediately climbs out of the gondola onto the nearby girders and is safe from the danger of the falling gondola. Anyone in the gondola when it falls that is not secured somehow to the girders above follows the procedures for catching a nearby girder and escaping the gondola as described under “Falling” above.

In addition, Inspector Muncy has damaged several of the nearby gas lamps (marked on the map) so that they are ready to explode with the slightest disturbance. Muncy can activate them by throwing a dart at the girder in that square (AC 10) and will do so if any of the PCs happen to be standing in a rigged lamp’s area of affect.

Throughout the battle Muncy screams apologies to the PCs and makes near-incoherent ramblings of the justification of his cause in order to urge the PCs to join him in his hunt, but he is obviously too far gone mentally. He attacks any PCs that approach him or try to free the children from the gondola, claiming they have to stay there until the monsters confess. He prefers to fight with ranged attacks but will freely engage in melee with anyone that approaches (though still pausing to throw darts at gas lamps when effective, even at the cost of taking attacks of opportunity). A successful DC 20 Charisma (Persuasion) check will cause him to be dazed for 1 round as he momentarily questions his actions, though in the following round he shakes off whatever argument the PCs may have made and attacks again. This check can be made multiple times throughout the battle and will cause him to pause as described above every time it is successful, but the DC of each successive attempt increases by 2. If all the children are freed before the gondola falls, Muncy cries out in despair and attempts to leap into the river far below and make his escape. Unfortunately for him his jumping abilities are not that pronounced, and he will simply crash into the uppermost roofs of the Skew just beyond the edge of the Wheel 300ft below — a fall that will almost certainly be fatal. Otherwise, he fights to the death. Either way, Muncy will not escape the battle alive, and the reign of the new Bloody Jack Carver ends before it truly began.

## BLOODY JACK

**Inspector Muncy:** AC 16; HP 90 (12d8+36); Spd 10ft; **Melee** rapier (+5, 1d8+3 piercing); **Ranged** dart (+5, 1d4+3 piercing); **SA** multiattack (rapier x3 or dart x3); **Immune** charm; **Str** +2, **Dex** +3, **Con** +3, **Int** +2, **Wis** +0, **Cha** +0; **Skills** Athletics +4, Stealth +5; **CR** 3 (700 XP).

**Gear:** breastplate, rapier, 10 darts, *potion of greater healing*, clay pipe, flint and steel, pouch of pipeweed, Watch Inspector's outfit, pouch with 14gp and 23sp

**Spite-Waif:** AC 13; HP 36 (8d6+8); Spd 20ft; **Melee** bite (+5, 1d6+3 piercing), claws (+5, 2d4+3 slashing); **SA** innate spells (Cha, DC 11), multiattack (bite, claws); **Immune** charm; **Str** -1, **Dex** +3, **Con** +1, **Int** +0, **Wis** +0, **Cha** +1; **Skills** Deception +5, Insight +2; **Senses** darkvision 60ft; **Traits** create mirror portal, perfect copy; **AL** NE; **CR** 1 (200 XP).

**Innate Spells:** at will—*alter self*; 1/day—*sleep*

## Won't Somebody Please Think of the Children?!

There are many descriptions that hint how Bloody Jack victimized children during his reign of terror, but only at this point are any children actually in jeopardy during the game. During this encounter, the players must have their characters both battle Bloody Jack and at the same time rescue a group of children about to fall to their deaths. Its intention is to force the players to work together and split up their resources so that they cannot all simply gang up on the killer for an anticlimactic conclusion and is designed so that the children can be rescued fairly easily if the party opts to commit themselves to the rescue.

It should be noted, however, that in the encounter the jeopardy to the children is what is important, not the injury to them. The players must feel the time crunch and the sense of impending doom if they do not act. There is an arbitrary 10-round clock set before the children fall to their deaths if the players have not saved them. If you are not comfortable with this or think that your players will not be, feel free to lengthen the time limit on the clock or abolish it altogether. Likewise, you can reduce the clock if necessary if you feel like your players would enjoy the increased level of tension. Our purpose is not to traumatize you or your players but to keep everyone on the edge of their seats in an exciting session of game play. It is a simple matter to not have the children fall, giving the players all the time they need to rescue them. What is important is that the players do not know that and that they are making all the efforts they can to rescue them from the clutches of the monster and save the day in a dramatic and hair-raising thrill ride of an encounter.

## Concluding the Adventure

For killing an Inspector of the Watch, even one possibly on the verge of committing mass murder, the PCs will quickly find themselves surrounded by constables and arrested. They are thrown in a cell deep in the Capitol and denied access to a barrister, with no real means of getting their story out, since the one member of the Watch who could vouch for them was Inspector Muncy himself. However, after cooling their heels for a couple days, they see an unknown visitor speaking to the desk sergeant before departing. A few moments later, the desk sergeant unlocks their cell, returns their possessions, and informs them that all charges against them have been dropped because he has just received orders that their actions were clearly for the good of the city. If asked who the visitor was who brought this news, he informs them that they should feel extremely lucky because that was an official from a high city office. It was Crown Justice Braken himself who ordered their release...

# Appendix One: Events in the Blight

The events in this appendix are not keyed to any specific location. Rather, they occur based on what the PCs have already done and how much time has elapsed since the party's investigation began. Each event describes when and how it can occur. These encounters are fairly difficult, so don't spring them on the PCs when they have not had a chance to recover from previous battles unless you're willing to risk the untimely demise of several PCs.

## Event 1: First Night

This event occurs the first night after the PCs have begun their investigation. By this time The Spiteful have become aware of their presence and decided that perhaps removing them in an unfortunate accident might be in their best interests. To this end, after the PCs have bedded down for the night The Spiteful release some of their foul beasts from Between to lure the PCs into an ambush and kill them. This event works best if the PCs have all retired for the night to a single location, but you can easily change it to accommodate them splitting up for the evening by just having a single ghoulish hound attack each one.

Whether asleep or with someone on watch, the PCs are disturbed by the sound of a visitor at the door of their abode. If they are at an inn, assume that they have rooms on the first floor near the common room and are the only souls up and around when the event occurs. If sleeping, they should not have armor and most equipment on, but if they wish to take the time to arm and armor themselves (always wise at night in the Blight), they can do so.

The silence of the night is interrupted by the sound of a scratch at the street door. It ceases, and you begin to wonder if it was just your imagination, a faint scratching at the wood, when suddenly it begins again — softly but insistent. The faint sound of a whimper just reaches your ears through the heavy portal.

The scratching and whimpering continues until the PCs decide to look out a window or open the door to see who is there. When they do so, read the following.

The whimpering and scratching has faded by the time you are able to get a look at what is outside. The night street is quiet, free from the bustle and noise of the day. A light mist wafts along the cobbles, and you at first believe that no one is there when you suddenly catch sight of it. A short way down the street, just rounding the nearest corner is a mangy dog, likely one of the many strays that wander the city. This one is emaciated with hunger, its ribs showing prominently, and appears to be limping, favoring one of its front paws. Even as it rounds the corner out of sight, you catch the unmistakable glimpse of fresh blood dripping from its injured paw. A quick glance at the cobbles and door shows that bloody smears and paw prints mark where it approached the door, scratched at it, and has now wandered away.

Attempts to call to the dog go unheeded and it is soon out of sight. If the PCs choose not to follow, the rest of the night passes uneventfully and they hear news of a mauled constable the next morning (see below). If they follow the dog, continue by reading the following:

The bloody paw prints of the pitiful dog are easily followed and, after rounding the first corner, they turn down an alley. However, the sight within the alley is one of horror rather than pity. Lying on the cold cobbles of the street, face up, his face a death mask of fear and pain, is a Constable of the Watch, his throat savagely torn out. The blood pooled around his still form is the source of the paw prints, and many more are scattered around the scene as a pack of emaciated hounds worries at the corpse — including the one you so recently followed that now looks back at you hungrily.

Feasting upon the recently slain constable are 3 **ghoulish hounds** that resemble normal dogs but with matted fur torn away in places and sickly grey flesh stretched tight over bone, so that at a distance in the dark they could be mistaken for starving stray dogs. These creatures have just killed the night constable who was on patrol and now attack the PCs. They pursue and fight to the death.

**Ghoul Hound (3):** AC 14; HP 60 (8d10+16); Spd 50ft; **Melee** bite (+5, 2d6+3 piercing plus paralysis plus trip); **Immune** charm, exhaustion, fright, poison; **Str** +3, **Dex** +2, **Con** +2, **Int**



## BLOODY JACK

–2, **Wis** +2, **Cha** +0; **Skills** Perception +4, Stealth +4; **Senses** darkvision 60ft, keen hearing and smell; **Traits** pack tactics (attack advantage with ally within 5ft of target), paralytic bite (1 min, DC 12 Con repeat), trip (knock prone, DC 13 Str to avoid); **AL** NE; **CR** 1 (200 XP).

Though horrors are not uncommon in the streets of the city at night, there have been no reports of packs of ghoul hounds roaming them lately. Where these came from remains mysterious to the PCs. If the PCs search the constable's body, they find his Office of the Watch shield pinned to his long blue coat, his night stick, a police whistle, a +1 *short sword* belted under his coat, and a pouch holding 5gp and 23sp.

**Development:** The next morning the PCs will be questioned by constables whether they discovered the corpse or not, as the investigation canvasses the neighborhood. The slain constable was not involved in the investigation the PCs are currently handling and was not known to any of them. They will not be asked about any missing items from the constable (some vagrant robs him if the PCs don't), but they will receive a 10gp reward if they return any taken items to the investigators (saying they found it or some other minimal attempted fiction — the authorities are not interested in prosecuting the PCs for misdemeanors with ghoul hounds apparently loose in the city).

### Event 2: A “Friendly” Warning

This event occurs during the day at some point after the first night (some time after **Chapter 3** is completed would work particularly well as it involves the first real interaction between The Spiteful and the PCs). It occurs during the day while the PCs are on the streets, preferably in East Ending or one of the other lower class districts of the city. If near the docks, then the thugs are dock workers; if elsewhere, they are simply street toughs.

---

Through the crowds of people milling about the streets, one group of tough-looking individuals seems to have focused on you. The eight men wear the shabby work clothes of the lower class residents of the district, but theirs seem perhaps a bit shabbier, as if they hadn't done many honest days of work in order to maintain their attire. The leader of the group, a man with a dented bowler cocked low on his head, points at you and demands, “Out with your coin now, guv. An' keep yor 'ands away from those shivs.” He and the others produce sawed-off spear butts as clubs from beneath their rags and hold them inconspicuously to their sides

---

The toughs are actually 4 **fey-touched thugs** from Between. They are each using *silent image* to create the illusion of one extra thug to bolster the appearance of their numbers, though they drop this illusion as soon as combat begins. Of partial human ancestry, The Spiteful frequently employ them as muscle hidden among the downtrodden and disenfranchised of the Blight. While they appear to be robbing the PCs, they are in fact sent to give a none-too-subtle warning.

As soon as the PCs begin to acquiesce to their demand for money (probably not likely) or draw weapons of their own, the thugs attack. If the PCs have acquiesced, then the initial attack is a surprise round and allows them to make sneak attacks. Regardless of how it starts, in the first round of battle, the leader of the group (as a free action) leans conspiratorially close and whispers to one of the PCs and says, “There's some as don't want you on the investigation. Probably best if you leave it be, guv.” He attacks despite this warning. Other than their initial *silent images*, they refrain from using their spell-like abilities to avoid their true nature being discovered. However, any thug reduced to 10 hp attempts to flee and disappear into the crowds, turning invisible as soon as he is out of sight. The crowds, meanwhile, stay out of the fight but do gather to watch the spectacle.

**Fey-Touched Thug (4): AC** 15; **HP** 65 (10d8+20); **Spd** 30ft; **Melee** greatclub (+5, 1d8+3); **Ranged** dart (+5, 1d4+3 piercing); **SA** innate spells (Cha, DC 11), multiattack (greatclub x2 or

dart x2); **Resist** cold; **Str** +3, **Dex** +3, **Con** +2, **Int** –1, **Wis** +0, **Cha** +1; **Skills** Intimidation +5, Stealth +5; **Senses** darkvision 60ft, keen smell; **AL** NE; **CR** 2 (450 XP).

**Innate Spells:** at will—*invisibility*; 2/day—*silent image*, *minor illusion*; 1/day—*alter self*, *sleep*

**Development:** Anyone making a DC 10 Wisdom (Perception) check while interacting with the thugs notices that they seem to have slightly pointed ears and pug noses that are a bit more upturned than would be expected on a human. Anyone making this observation can then make a DC 15 Intelligence (Nature) check to surmise that they seem to have a bit of fey blood in them (an unexpected lineage in an urban setting like Castorhage). The thugs will give no further information even if captured and questioned, feigning the part of ignorant street toughs out to make a few silvers the “old-fashioned” way (with a sap to the side of a mark's skull). Any comments on their appearance or lineage causes them to claim they are all cousins and brings a belligerent response of “What did you say about me mum?” The Watch predictably arrives shortly after the battle has ended and takes statements from the PCs with little further action. They know nothing of the thug's cryptic warning.

### Event 3: There Will Be Blood

This event can occur any time after **Event 2** and before **Chapter 8**. It can occur day or night at any point when the PCs are near the Great Lyme River (at least within a few blocks of it). By now The Spiteful have determined that they want the PCs dead and have called upon horrors brought forth long ago from Between bent on murder.

---

The sky had been fairly clear, considering the usual smog of the city, but now a fog seems to have drifted in off the river engulfing the street in a thick, soupy mist. The cobbles are slick with moisture, and the eaves drip from the sudden condensation. A faint clicking sound can be heard and a low vibration in the ground. Suddenly cobblestones shift and slide around as they are displaced by something emerging from the earth beneath them. Climbing forth from the gaping pits in the road are three dog-sized beetles with large pincers, their shells a bleached white colour that seems to blend with the enshrouding fog.

---

The fog that has enshrouded the PCs actually only covers the street that the PCs are upon and is the result of three *fog cloud* spells cast in a line by a Spiteful sorcerer on a nearby rooftop. The unnatural fog can be recognized for what it really is with a DC 15 Intelligence (Arcana) check.

Attacking the PCs are 3 **mist murderers**, strange creatures brought forth from Between years ago that have lain dormant as pupae beneath this street ever since. The fog clouds provide invisibility to the creatures even when they are within 5ft of the PCs. They attack relentlessly and fight to the death. The Spiteful sorcerer does not join in the battle, instead remaining in hiding to report his results to his superiors. If the PCs begin to look for the caster of the *fog clouds*, he turns invisible and flees with a *fly* spell.

**Mist Murderers (3): AC** 15; **HP** 55 (10d6+20); **Spd** 10ft, burrow 5ft, fly 40ft; **Melee** claw (+6, 1d6+4 slashing plus 2d6 poison plus paralysis, 1 min, DC 12 Con repeat); **SA** multiattack (claw x2), sneak attack +1d6; **Immune** charm; **Str** +1, **Dex** +4, **Con** +2, **Int** –5, **Wis** +1, **Cha** +0; **Skills** Stealth +8; **Senses** blindsight 30ft, tremorsense 60ft; **Traits** mist masking (invisible in misty or foggy conditions); **AL** NE; **CR** 2 (450 XP).

# Appendix Two: New Monsters

## Sough-Eel

*This massive eel, nearly 20ft long, has pale hide almost translucent like a fish's belly that is marred by great areas of sloughing flesh that hang loose in rotten folds. It is eyeless, with a row of small black nodules extending back from its snout, and has several small vestigial fins growing sporadically along the length of its body. Its mouth however, is the most noticeable feature, occupying nearly a quarter of its length and splayed wide with a crowd of jagged fangs.*

### Sough-Eel

Huge beast, unaligned

**AC** 15 (natural armor)

**HP** 126 (12d12 + 48)

**Speed** 10ft, swim 30ft

STR	DEX	CON	INT	WIS	CHA
22 (+6)	10 (+0)	18 (+4)	1 (-5)	12 (+1)	8 (-1)

**Skills** Perception +7, Stealth +6

**Damage Resistances** piercing

**Damage Immunities** poison

**Condition Immunities** blinded, poisoned

**Senses** tremorsense 60ft, blindsight 30ft, passive Perception 11

**Languages** —

**Challenge** 5 (1800 XP)

**Water Dependency.** Sough-eels can survive out of the water for 20 minutes after than they begin to suffocate.

### ACTIONS

**Bite.** Melee Weapon Attack: +9 to hit, reach 10ft, one creature. *Hit:* 17 (2d10 + 6 piercing damage). The bite causes the disease sight rot unless the target makes a successful DC 15 Constitution save. If the target is Medium or smaller, it is grappled (escape DC 17). Until this grapple ends, the target is restrained and the sough-eel continues biting it and can't bite another target.

**Gnaw.** If a sough-eel begins a round with a grappled foe, it can attack as a bonus action with a second set of jaws in its throat that aid in swallowing. A bite attack as above except 10 (1d8+6) piercing damage to the grappled target. After a sough-eel has used its gnaw attack against a grappled foe for 2 rounds, it will attempt to swallow that foe on its next attack.

**Swallow.** The sough-eel makes one bite attack against a Medium or smaller creature it is grappling. If the attack hits, the creature takes the bite's damage, and is swallowed, and the grapple ends. While swallowed, the creature is blinded and restrained, it has total cover against attacks and other effects outside of the sough-eel, and it takes 14 (4d6) acid damage at the start of each of the sough-eel's turns.

If the sough-eel takes 30 damage or more on a single turn from a creature inside it, the sough-eel must succeed on a DC 14 Constitution save at the end of that turn or regurgitate all swallowed creatures, which fall prone in a space within 10ft of the slough-eel. If the sough-eel dies, a swallowed creature is no longer restrained by and can escape from the corpse using 15ft of movement, exiting prone.

These vile predators are found exclusively in the dark, filthy waters of the Great Lyme River and Fetid Sea in the vicinity of the City-State of Castorhage. Some have speculated that they were once a temperate water variety of moray eel that was indigenous to the area until the Lyme was tainted by the noxious effluvia from the metropolis known colloquially as The Blight. Unlike most aquatic species that were unable to survive the poisoning of the waters, the sough-eel population managed to endure the deadly but were changed in the process. Immune to most disease and poison, the sough-eels as carriers of their own endemic pathogen, are now affected by it chronically so that their hide is in a constant state of dying and sloughing off in large swaths and layers. This has not seemed to affect their ability to survive in their harsh environment, and every native of the Blight knows better to enter the water of the Lyme for fear of the voracious attacks of the ever-present sough-eels.

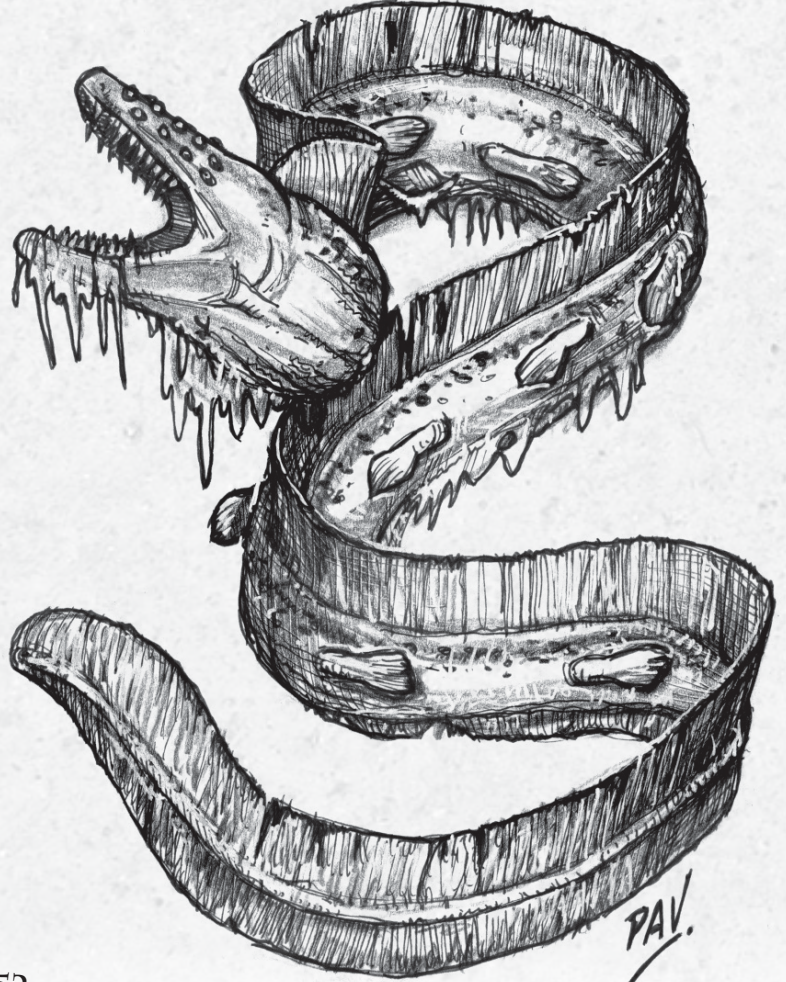

# Spite-Waif

The figure is childlike, but any sense of innocence is immediately overshadowed by the aura of malevolence that seems to almost palpably exude from it. Its flesh is grey and pasty, seemingly too loose for its body. Its head is hairless with a wide mouth and distended jaw full of needle sharp teeth, and, though humanoid in shape, when it moves it scuttles about on all fours like some kind of an insect with too many joints in its limbs.

## Spite-Waif

*Small monstrosity (Between, shapechanger), neutral evil*

**AC** 13

**HP** 36 (8d6 + 8)

**Speed** 20ft

STR	DEX	CON	INT	WIS	CHA
9 (-1)	16 (+3)	12 (+1)	10 (+0)	11 (+0)	13 (+1)

**Skills** Deception +5, Insight +2

**Condition Immunities** charmed

**Senses** darkvision 60ft, passive Perception 10

**Languages** Common

**Challenge** 1 (200 XP)

**Create Mirror-Portal.** A spite-waif can, once per day, turn a normal mirror into a portal between the Material Plane and Between. To use this ability a mirror must be obtained from the Material Plane and taken to Between where the spite-waif must first conduct a 1-hour ritual to attune the mirror and turn it into a device for scrying. It is then able to scry through any Material Plane mirror for a suitable location to use as a portal. Once a location has been determined, the mirror-portal is created and fixed between the two mirrors, and the spite-waif's mirror cannot be attuned to any other mirror. Once the mirrors have been attuned, the portal can be opened from either end by simply sliding the mirror aside as a move action and revealing the extradimensional portal behind it. Anyone can pass through the mirror-portal as long as they can fit through the dimensions of the mirror's pane. Once created, a mirror-portal remains open indefinitely until closed. If closed, it can no longer be opened except by the spite-waif that created it. If either mirror is destroyed, the mirror-portal is closed permanently.

**Innate Spellcasting.** A spite-waif's spellcasting ability is Charisma (spell save DC 11). The spite-waif can innately cast the following spells, requiring only verbal components:

**At will:** *alter self*

**1/day:** *sleep*

**Perfect Copy.** When a spite-waif uses *alter self*, it can assume the appearance of a specific individual. Unlike a doppelganger, when a spite-waif is killed it remains in its assumed form unless a dispel magic is cast on the corpse.

## ACTIONS

**Multiaffack.** The spite-waif makes a bite attack and claws attack.

**Bite.** Melee Weapon Attack: +5 to hit, reach 5ft, one target. Hit: 6 (1d6 + 3) piercing damage.

**Claws.** Melee Weapon Attack: +5 to hit, reach 5ft, one target. Hit: 9 (2d4 + 3) slashing damage.

These creatures are insidious changelings and infiltrators from Between. Spite-waifs are an immature stage in the development of a doppelganger that are native to that bizarre realm. While they have the doppelganger's ability to change shape, they lack its physical power and ability to read minds. As a result, they are used primarily as changelings to replace children of the Material Plane and then grow up within that child's household and live its life. The reasons for these switches are manifold, but they are universally of malign intent. This is especially evident in the fact that unlike hags, who swap changelings out for real children and then raise the true child as its own, the switched child of a spite-waif is usually devoured by the creature at the time of the switch.

Spite-waifs superficially physically resemble a small humanoid child but with a doppelganger's characteristic grey and formless skin and features. Its jaw is able to distend to allow it to swallow creatures of up to Tiny size, and a mouthful of needle-sharp teeth help it grip its prey. Internally, the spite-waif's abdomen is almost entirely occupied by a greatly elastic stomach allowing it to hold swallowed prey, and the corrosive digestive acids dissolve it quickly to prevent any telltale distention to give away the truth of its recent meal. Horrifically, the parents of children that have been switched are frequently concerned about a possible stomach ailment afflicting their "child" when they change its bedclothes not aware of the true source of its exceptionally soiled diapers.

A spite-waif can maintain its charade for years, keeping its altered form continuously, and will usually do so for the entire childhood and adolescence of the replaced child. In many ways they become that child, assuming all of its roles and eventual responsibilities, though it always maintains some form of contact with its own kind — even if only a quick meeting once every few years — to stay current on the planned reasons for the switch. The reasons and plans for a changeling switch are always extremely far-reaching, taking decades to develop, and frequently involve replacing a child from a prominent family in order to attain a powerful position in government later in adulthood.

When a spite-waif reaches physical maturity (usually within 10–12 years) it attains Medium size and completes its transformation into a full doppelganger, losing its bite and swallow whole abilities as well as its innate ability to create mirror-portals. It does develop the slam attacks, mimicry, and ability to cast detect thoughts, becoming in all ways a normal doppelganger.

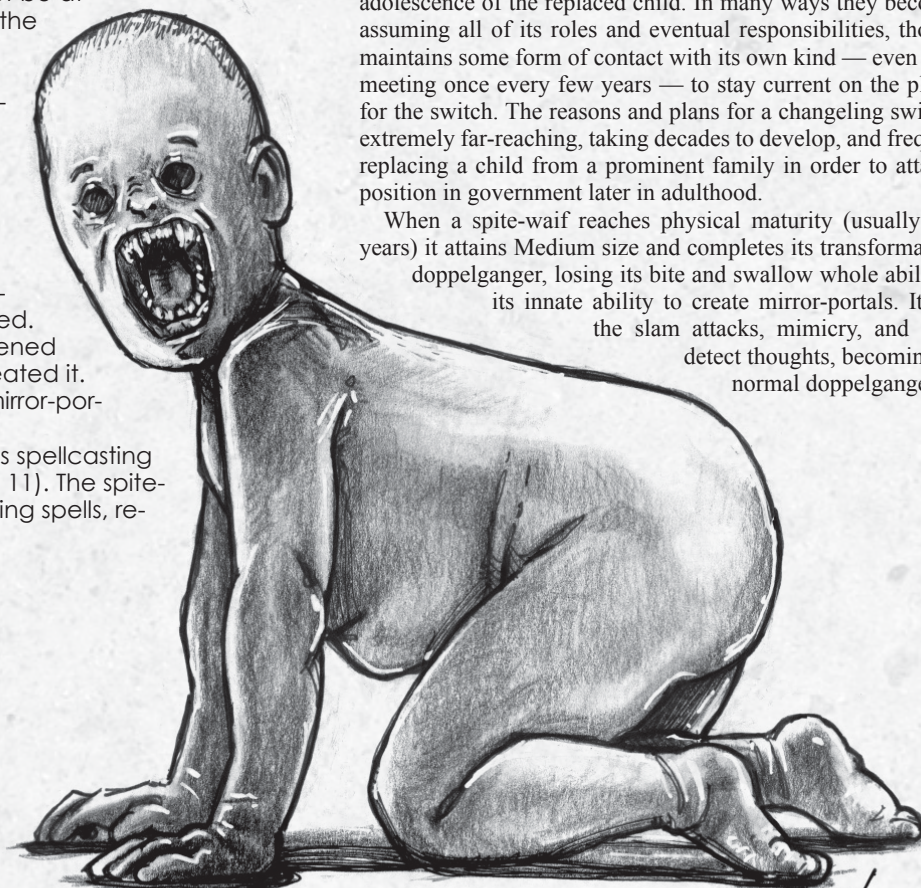

# Appendix Three: Player Handouts

---

**Handout A**

*RECEET — ISSUED BY OLD BILL*

*REPAIR — 1 GEAR MECHANISM*

*MAIN GEAR A TERTIARY TOGGLE SWITCH*

*20 PILASTERS*

*TO — EUSTUS GRINDLYLOW,  
GRINDLYLOW'S GRINDERS*



**Handout B**

**VISIT MADAM LARUA**

---

**TELLER OF FORTUNES AND  
DIVINER OF SECRETS**

**LEARN YOUR FATE  
LEARN YOUR FORTUNE**

**FESTIVAL SUMMIT BY THE SKEW,  
SOUTHWEST**

## Handout C

### The Legend of Bloody Jack Carver

*B*loody Jack Carver  
Went down to the harbour  
Taking some children to play.

*An eel popped up its head  
And ate them instead,  
While Jack tip-toed away.*

—*Children's Rhyme from the Blight*



Thirty years ago the citizens of the city were gripped in a nightmare. For three years the lunatic serial killer known as Bloody Jack Carver stalked the fog-shrouded streets of the Blight and abducted children to murder and mutilate. The Watch followed up every lead and rounded up countless suspects but never came any closer to their quarry or even developed a solid suspect. They assumed it was a labourer, probably a butcher by trade based on the bloody and mutilated condition that many of the victims were found in, and more than one innocent tradesman returning home from his work at the slaughterhouse was lynched by a mob of enraged and terrified parents mistaking him for the bloody killer.

The killing spree finally ended, though not before the number of dead and missing children had reached into the scores, but the perpetrator himself was never caught or identified. The parents and constabulary of the city gave a collective sigh of relief, hoping that one of the haunted city's other horrors of the night had perhaps claimed the life of the blood-drenched psychopath and ended his reign of terror once and for all. But the tales of Bloody Jack Carver never really faded, finding their way into nursery rhymes taught to misbehaving children and still heard on street corners where young children skip rope and play make-believe.

**Handout D**

Bloody Jack Carver  
Went down to the larder  
Taking some children to play.

He read them some books,  
And then hung them from hooks,  
And left them to age for a day.

**Handout E**

*You will soon lay down the knife  
as your time is done. Another is to  
come who will return to the scene of  
the crime and take up the bloody  
business again.*

Handout F

**REPORT OF CRIME**

<u>CLASSIFICATION</u>	<u>#VICTIMS</u>	<u>DATE OF CRIME</u>	<u>DATE OF DISCOVERY</u>
Murder-Suicide	2	4/23/57 ~1400 hrs	4/23/57 2055 hrs

<u>LOCATION OF CRIME</u>	<u>LOCATION TYPE</u>
Portmuth Building, #34	Tenement

VICTIM(S)

<u>NAME</u>	<u>AGE</u>	<u>GENDER</u>	<u>RESIDENCE</u>	<u>INJURY STATUS</u>
Rebecca Muncy	20	female	Portmuth Bldg, 34	neck fracture deceased
Adelaide Muncy	8 mo.	Female	Portmuth, 34	mult. stab wounds deceased

PERPETRATOR(S)

<u>NAME</u>	<u>AGE</u>	<u>GENDER</u>	<u>RESIDENCE</u>	<u>STATUS</u>
Rebecca Muncy	20	female	see above	deceased at scene

SUMMARY OF EVENTS

Perpetrator suffering depression, became despondent and took life of infant daughter with butcher knife. Took own life by wrenching neck hard to the side and crushing windpipe.  
No further description.

CASE STATUS

Closed/Solved

MATERIAL DISPOSITION

Order of Sequestration on crime scene      Sealed - 4/23/57      Lifted -  
Mortal remains removed to Lych Field for cremation - 4/25/57

LEAD INVESTIGATOR R. Phineus, Insp.

Handout G

MATERIAL WITNESS STATEMENT

[REDACTED] 34, Portmuth Building in Theatre Town [REDACTED] 2000 hours  
on 4/23/57 [REDACTED] my wife [REDACTED]  
[REDACTED] was dead when I checked for breathing [REDACTED] blood  
[REDACTED] drying. [REDACTED] Adelaide [REDACTED]  
[REDACTED] blood loss [REDACTED]  
[REDACTED] Rebecca [REDACTED]  
[REDACTED] wife and child [REDACTED]  
[REDACTED] murder-suicide [REDACTED]  
[REDACTED] depressed [REDACTED]

Hogan Muncy, Con.

## Handout H

### MATERIAL WITNESS STATEMENT

*I returned home to my flat at 34, Portmuth Building in Theatre Town at approximately 2000 hours on 4/23/57 at the end of my patrol beat. I observed my wife sprawled in a rocking chair in the living room. She was covered with blood and her neck was twisted to the side, clearly by the application of great brute force. She was dead when I checked for breathing and her limbs were already cold. The blood was tacky and drying. On her chest lay our infant daughter, Adelaide. Adelaide had been stabbed 14 times. Most were superficial, inexpert cuts, but three of them went deep and hit veins. She was also dead from blood loss and already cold when I checked. The kitchen knife that killed her was still clutched in Rebecca's hand which was beginning to stiffen with rigor. After calling for the Watch I examined the bodies and found no signs of stab wounds or cuts to Rebecca. All of the blood was apparently Adelaide's as if the baby had been stabbed many times while my wife was holding her. Adelaide's fingers were locked on my wife's neck around the windpipe area and were still clenched depressing the windpipe by at least two inches and apparently causing the twisting motion that caused the neck fracture. Rebecca likewise had many scrapes and bruises left by child size hands. I can only conclude that a fight occurred between Rebecca and our baby that resulted in Rebecca stabbing Adelaide repeatedly. In the process a tiny baby, not even a year old, managed to strangle and snap the neck of my wife. This entire tragedy is WRONG!!!! I don't know what happened here, but I will NOT have my wife and child accused of murdering each other. Rebecca was a wonderful wife and mother. Adelaide was the perfect baby girl. This case needs to be closed NOW. Call it a murder-suicide if you must but make it clear that Rebecca was not in her right mind. She was depressed and had to be on the verge of a breakdown. That has to be what happened. Nothing else makes sense.*

*Hogan Muncy, Con.*

**Handout I**

Bloody Jack Carver  
Decided, "No farther,  
The blood was enough for now."

He gave up the knife,  
And the inspector his wife,  
So another could take the blood vow.



## Handout J

*Dear Friends,*

*I see now that all of this was necessary... the old man's murder, your investigation, even the loss of my dear Rebecca and darling Adelaide. I have seen what lies on the Other Side and have felt its bite, and it must not be allowed to persist over here. Old Bill was right all along. And even if you get it wrong with a few of them, the good far outweighs the evil. I owe it to the city. I owe it to Adelaide.*

# Madame Larua's Stall - The Skew

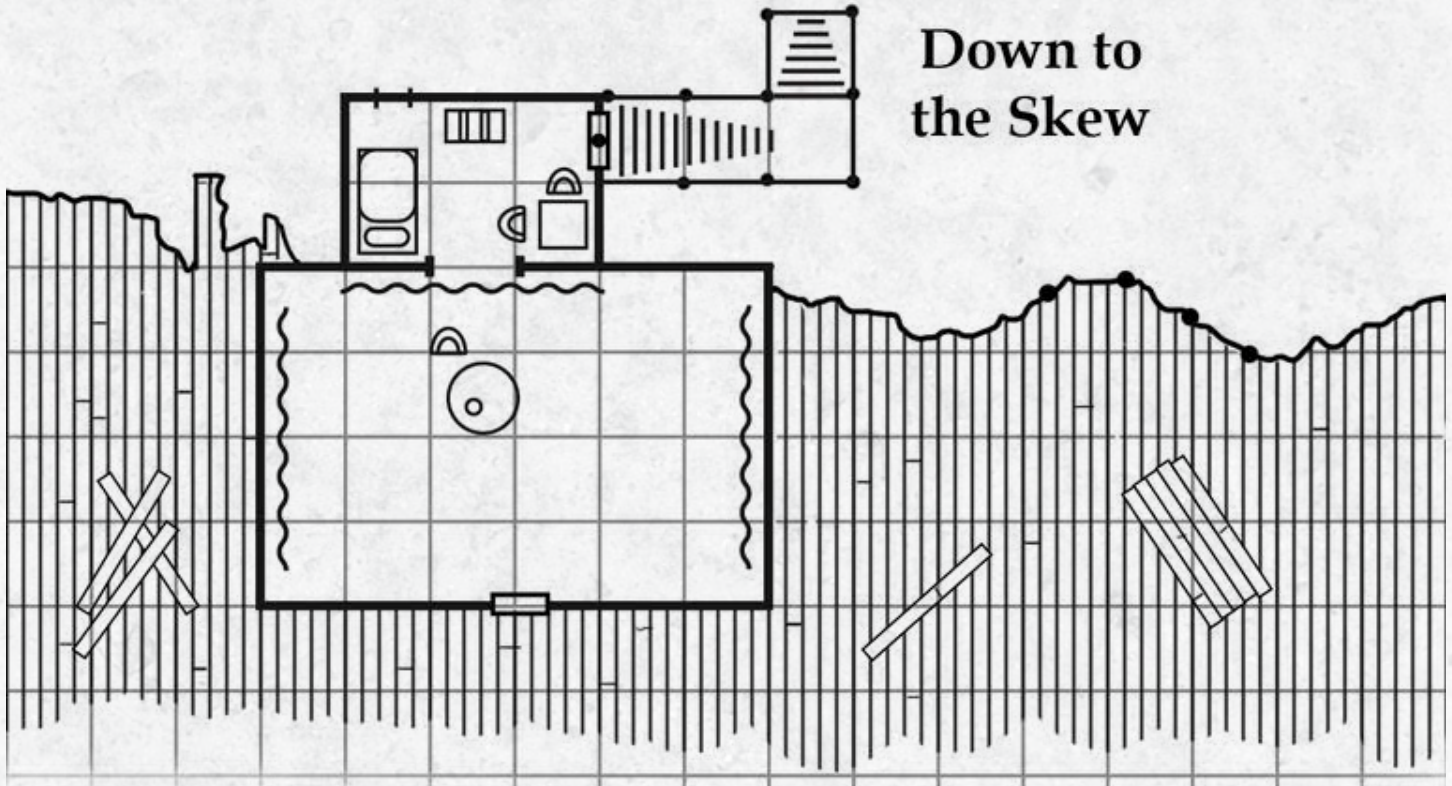

1 square - 5 feet

# Seaside Larder and Adjoining Tunnels

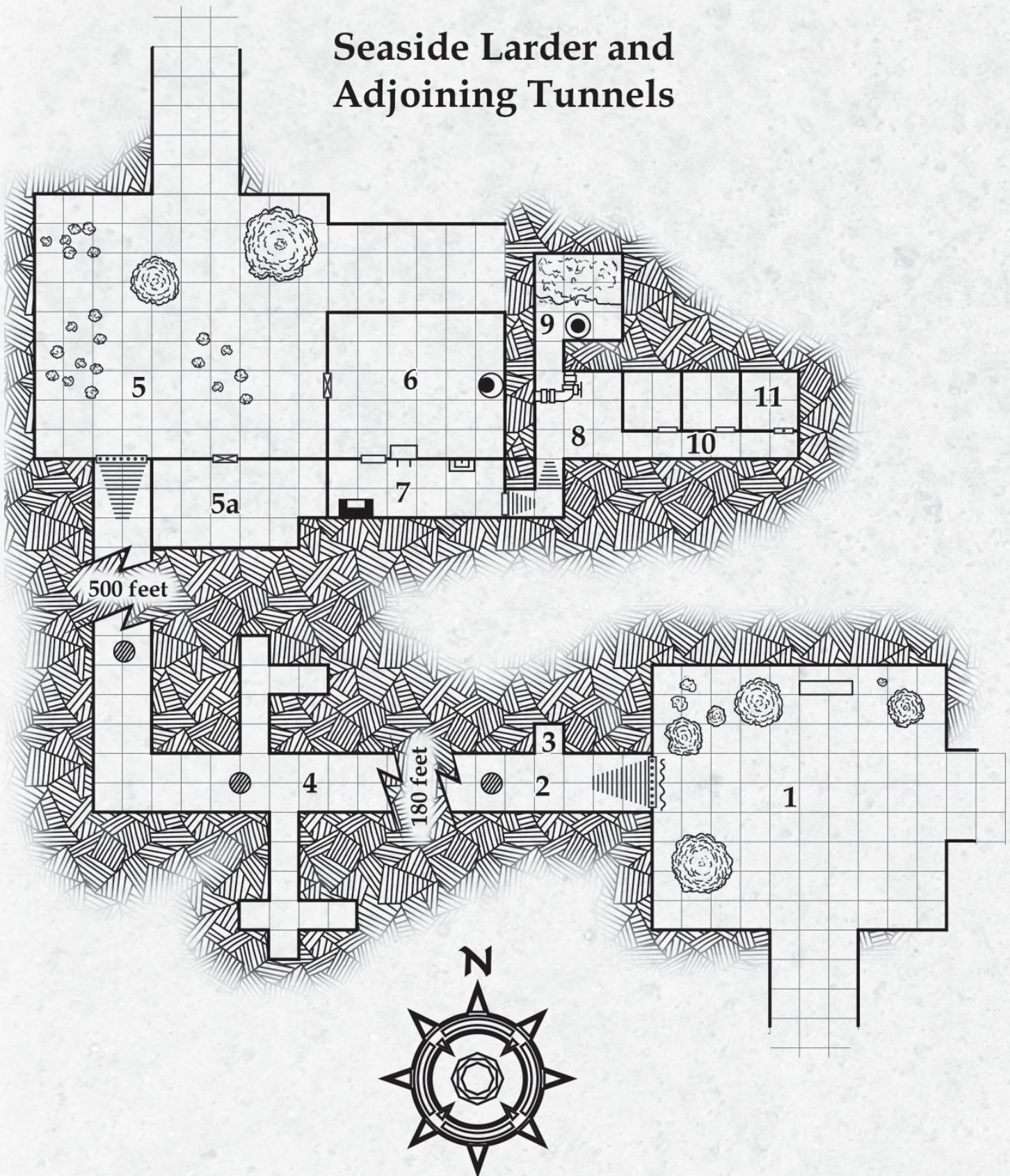

1 square - 5 feet

GM MAP

# Seaside Larder and Adjoining Tunnels

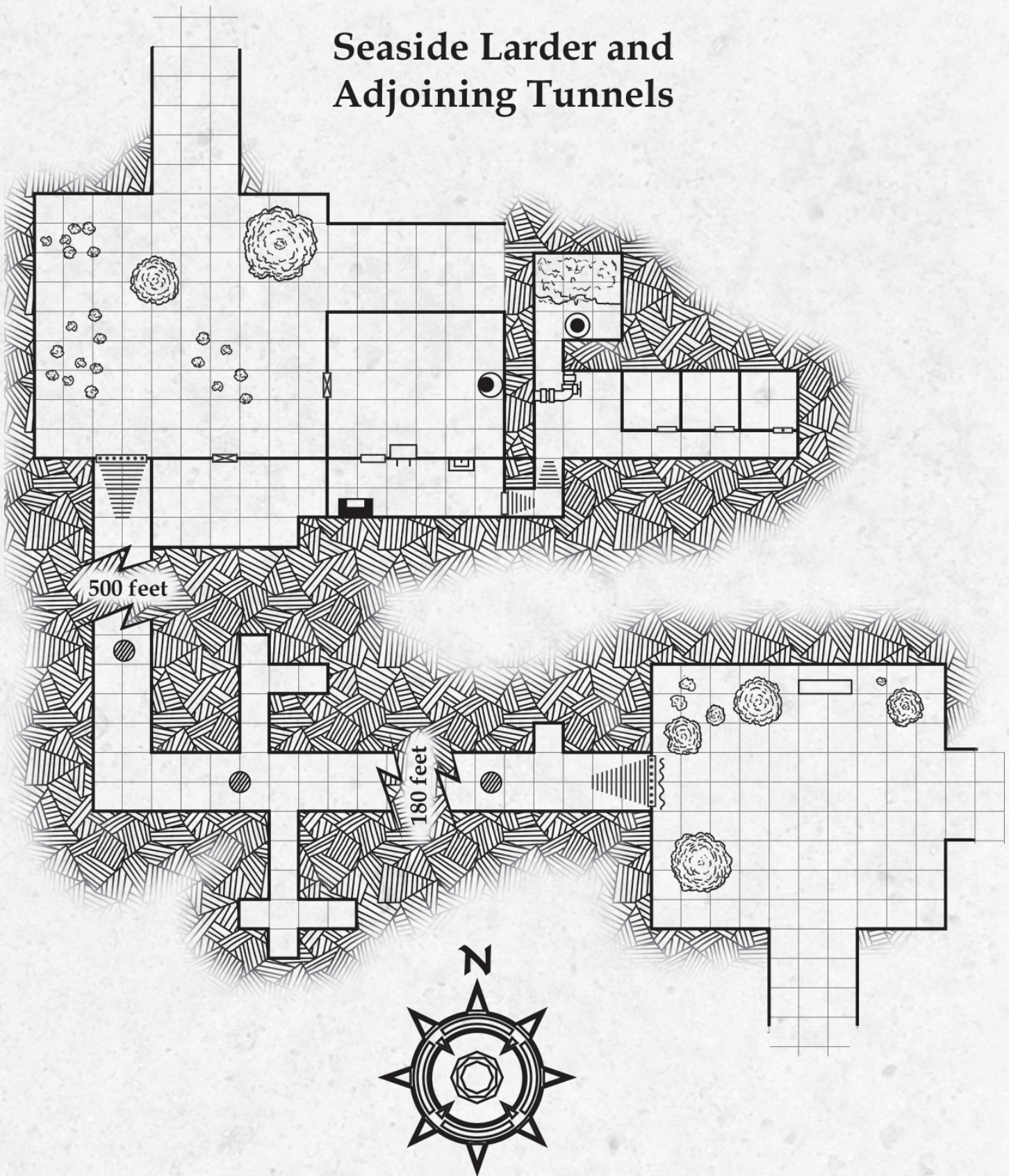

1 square - 5 feet

PLAYERS MAP

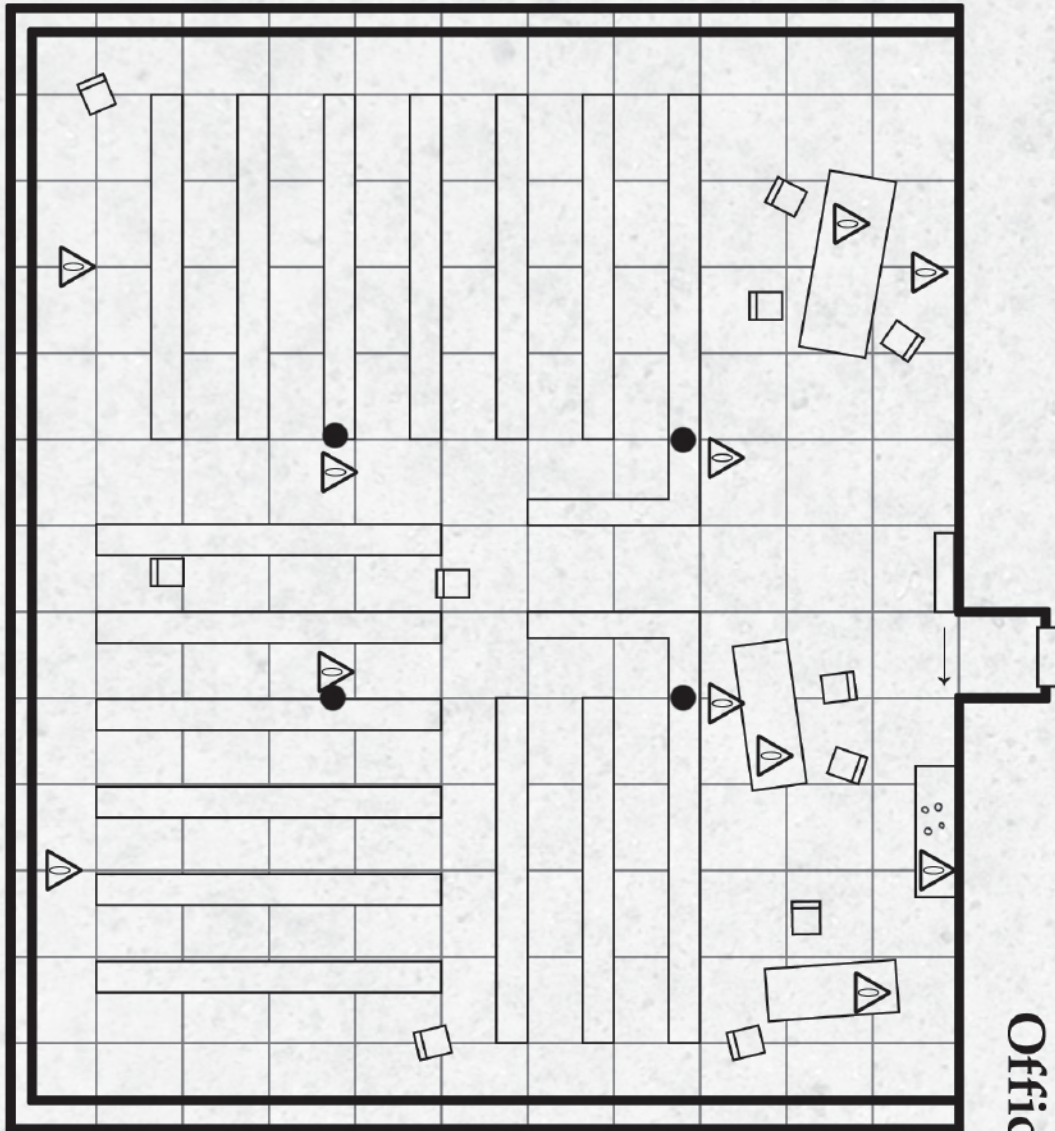

**Office of the Watch Archives**

**Inner Stacks**

1 square - 5 feet

 Oil Lamp



Office of the Watch Archives

Inner Stacks

1 square - 5 feet

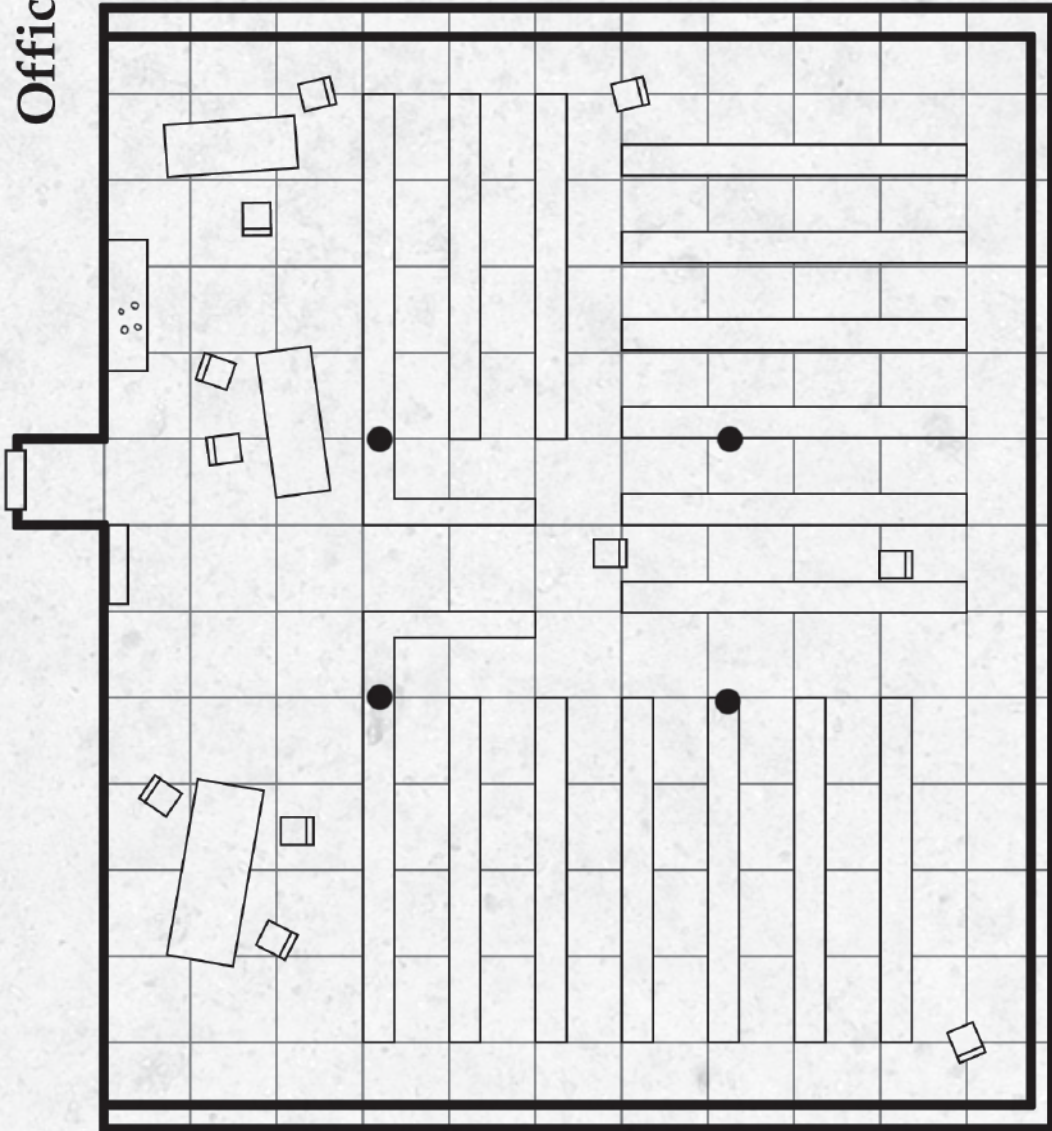

# Muncy Flat

1 square - 5 feet

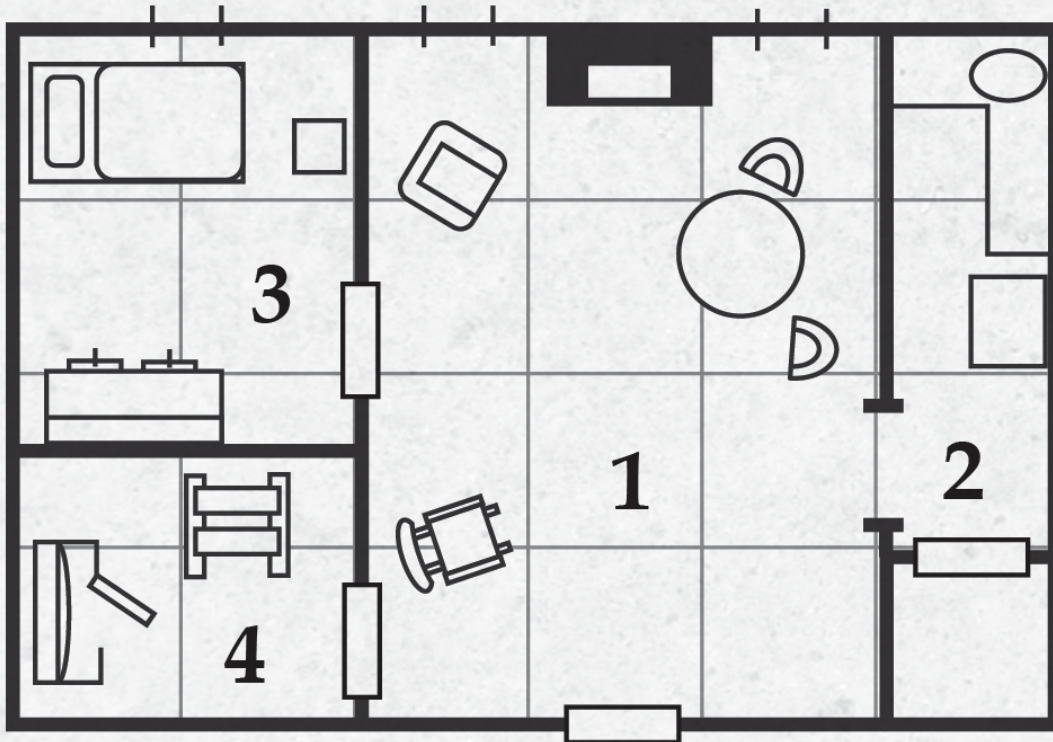

Mirror Portal



# Muncy Flat

1 square - 5 feet





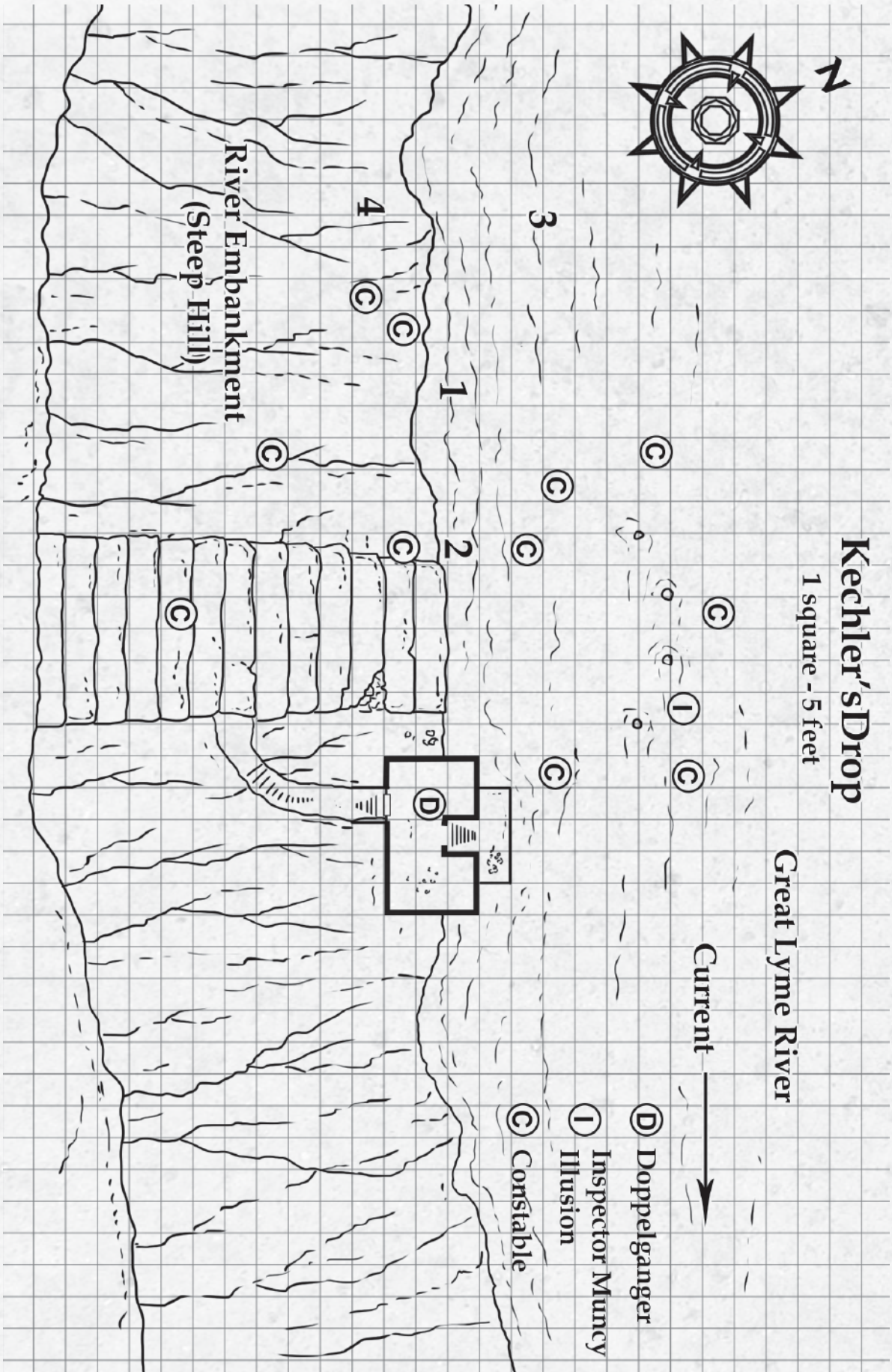

GM MAP

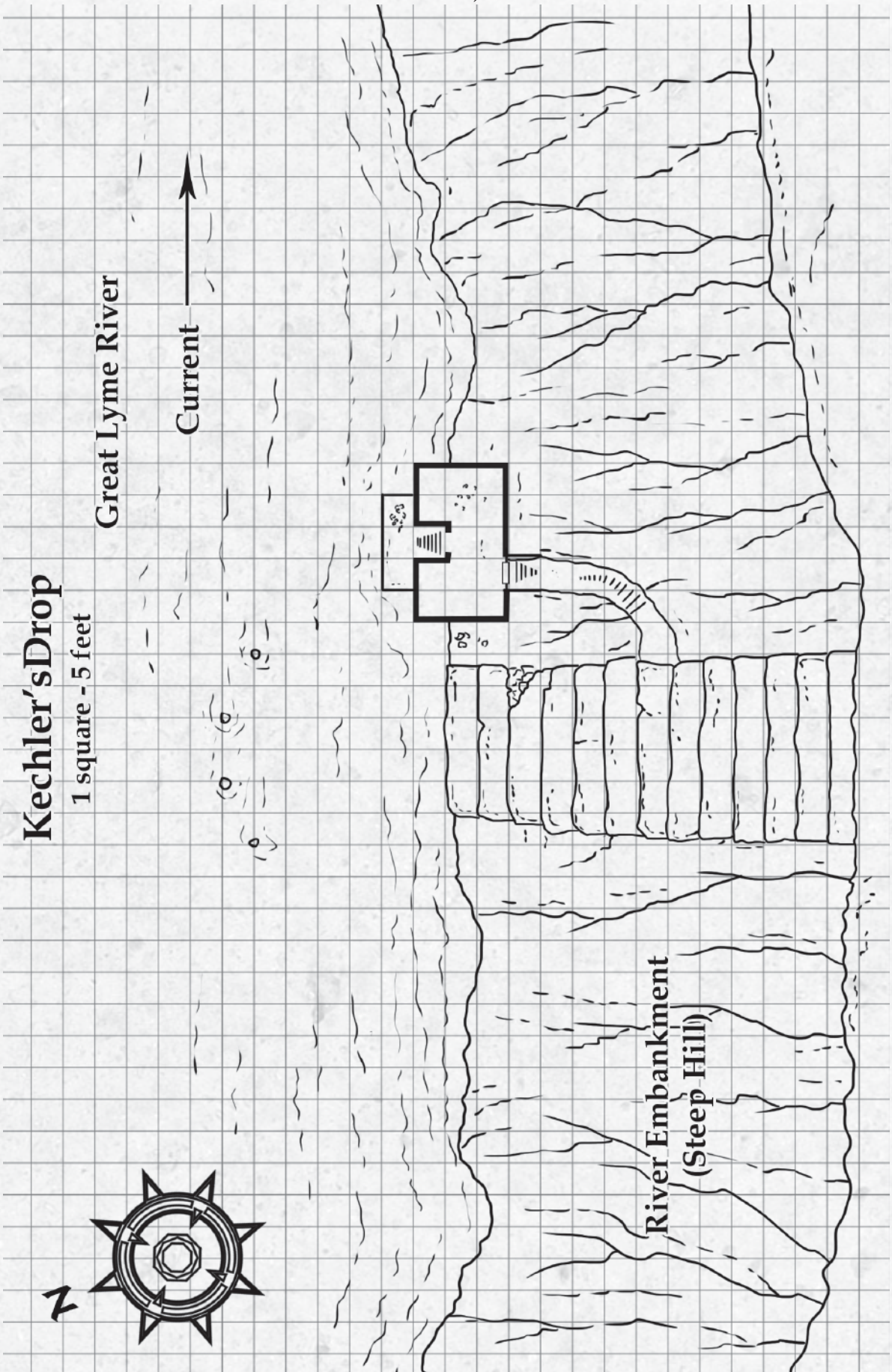

# Currington Clothiers

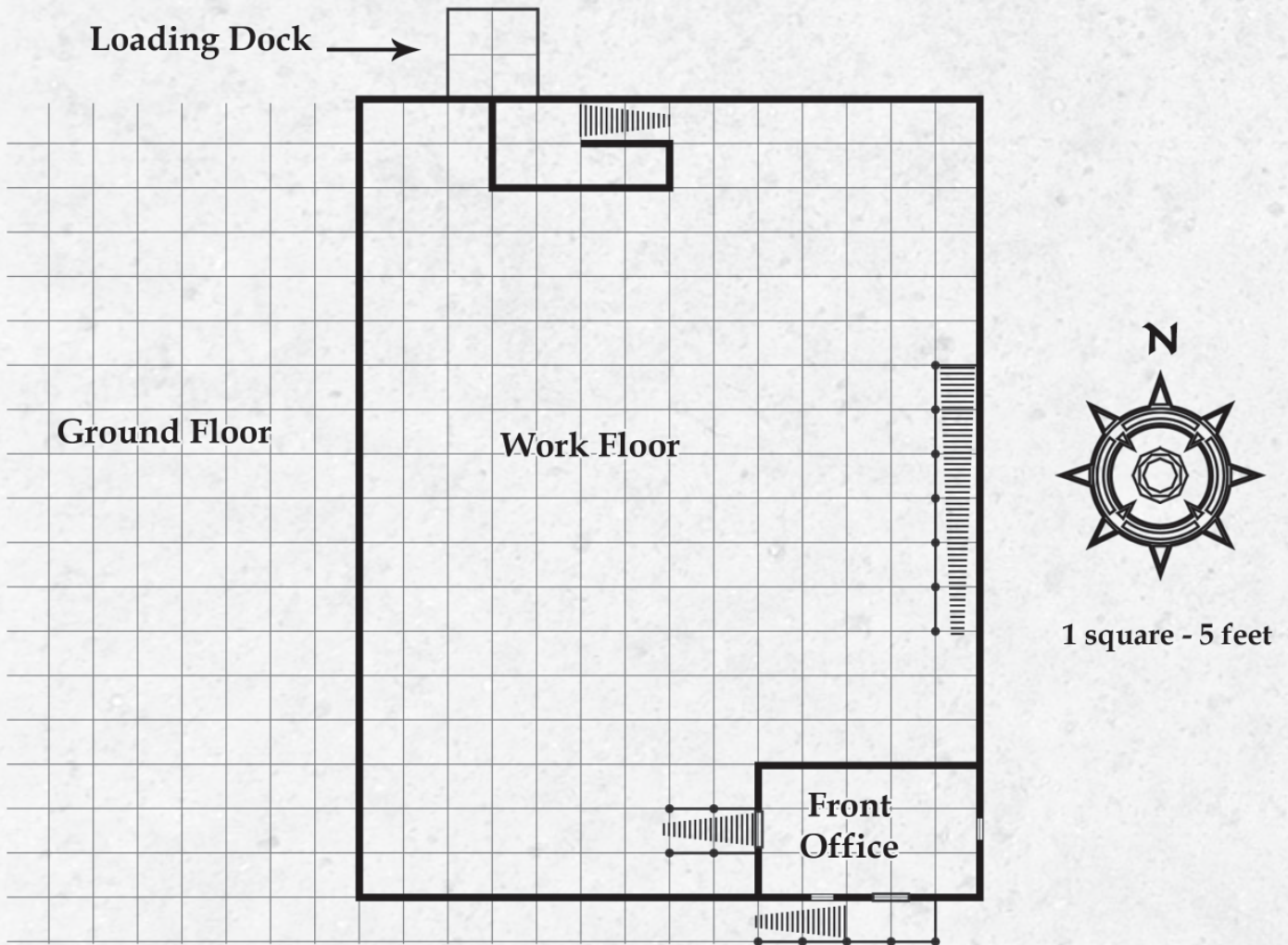
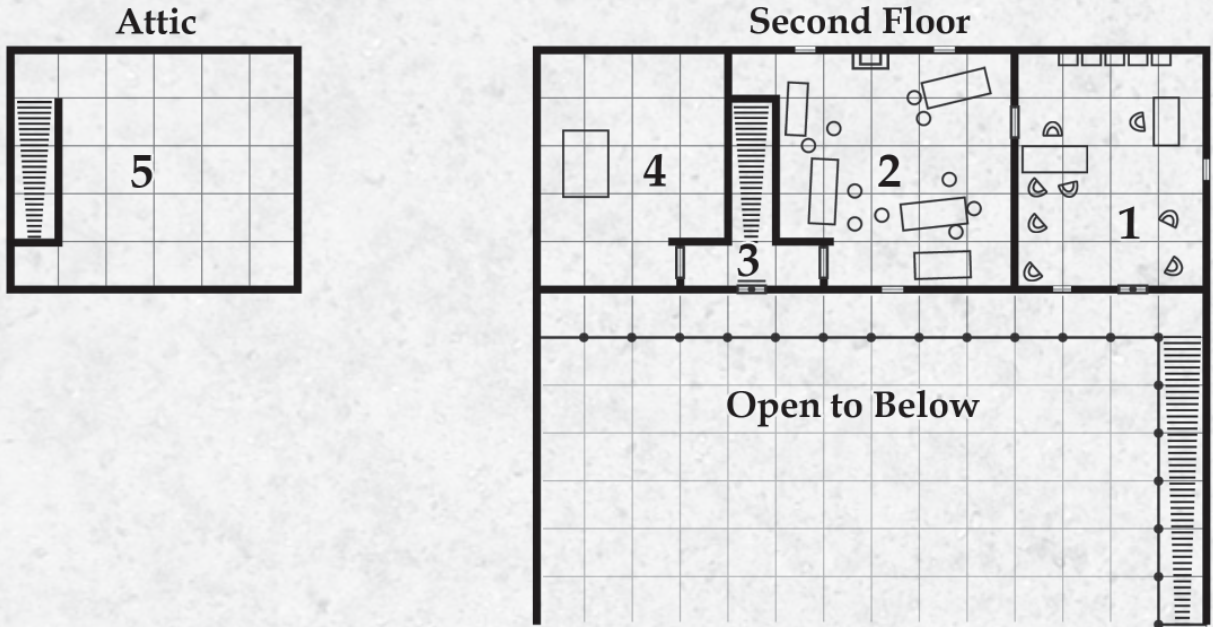

# Currington Clothiers

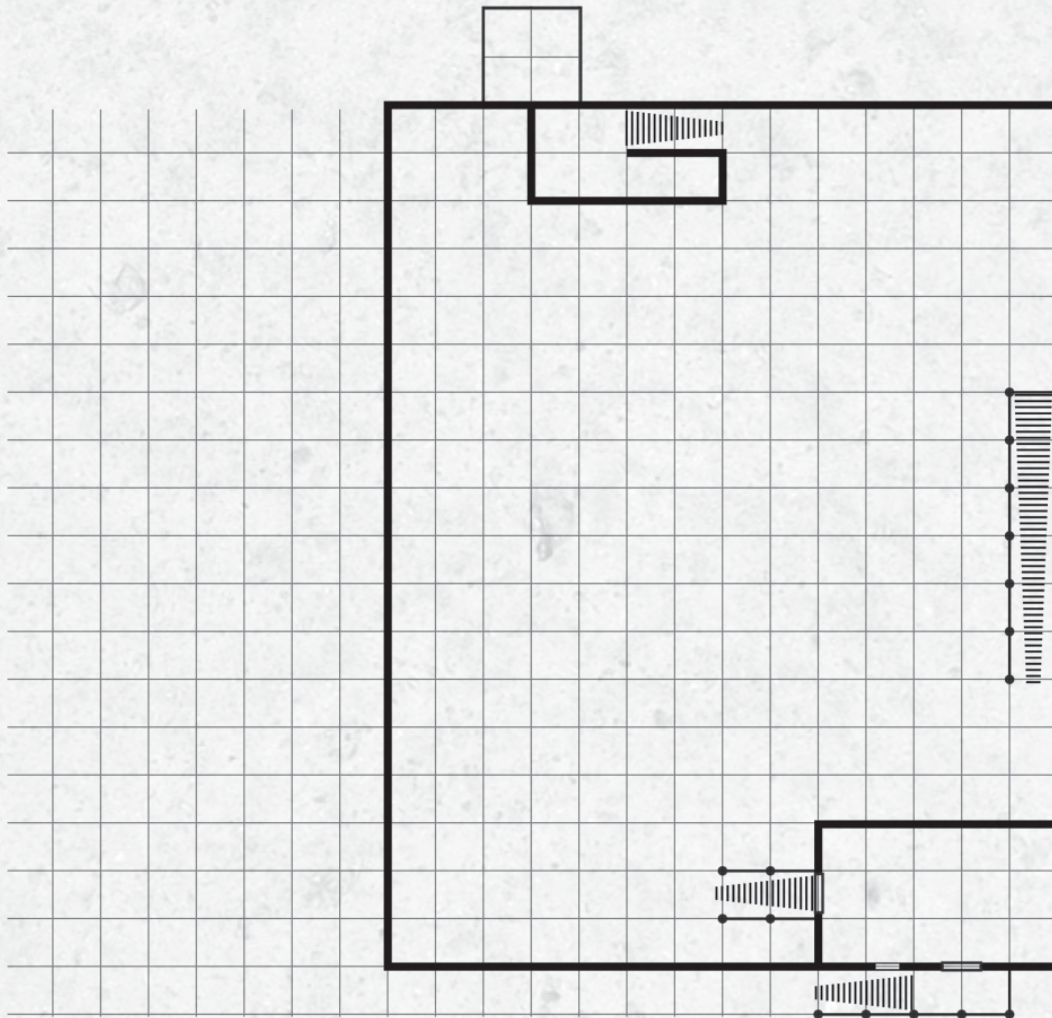
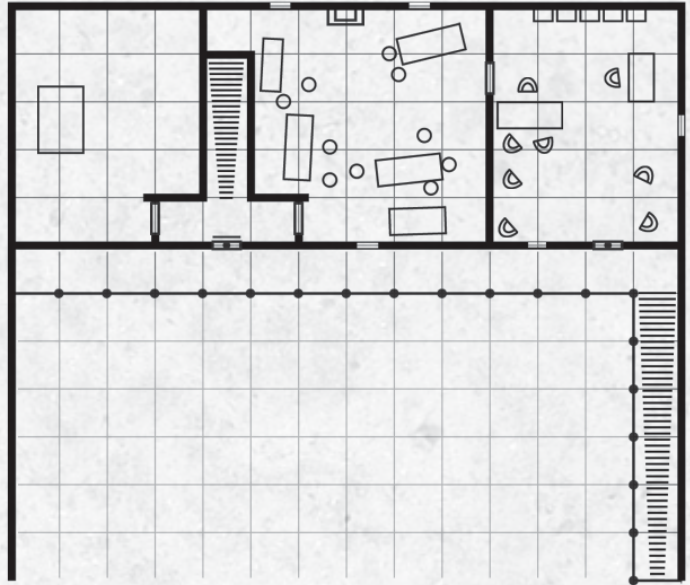
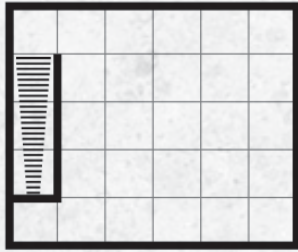

1 square - 5 feet

PLAYERS MAP

# The Great Wheel

1 square - 5 feet

Side View

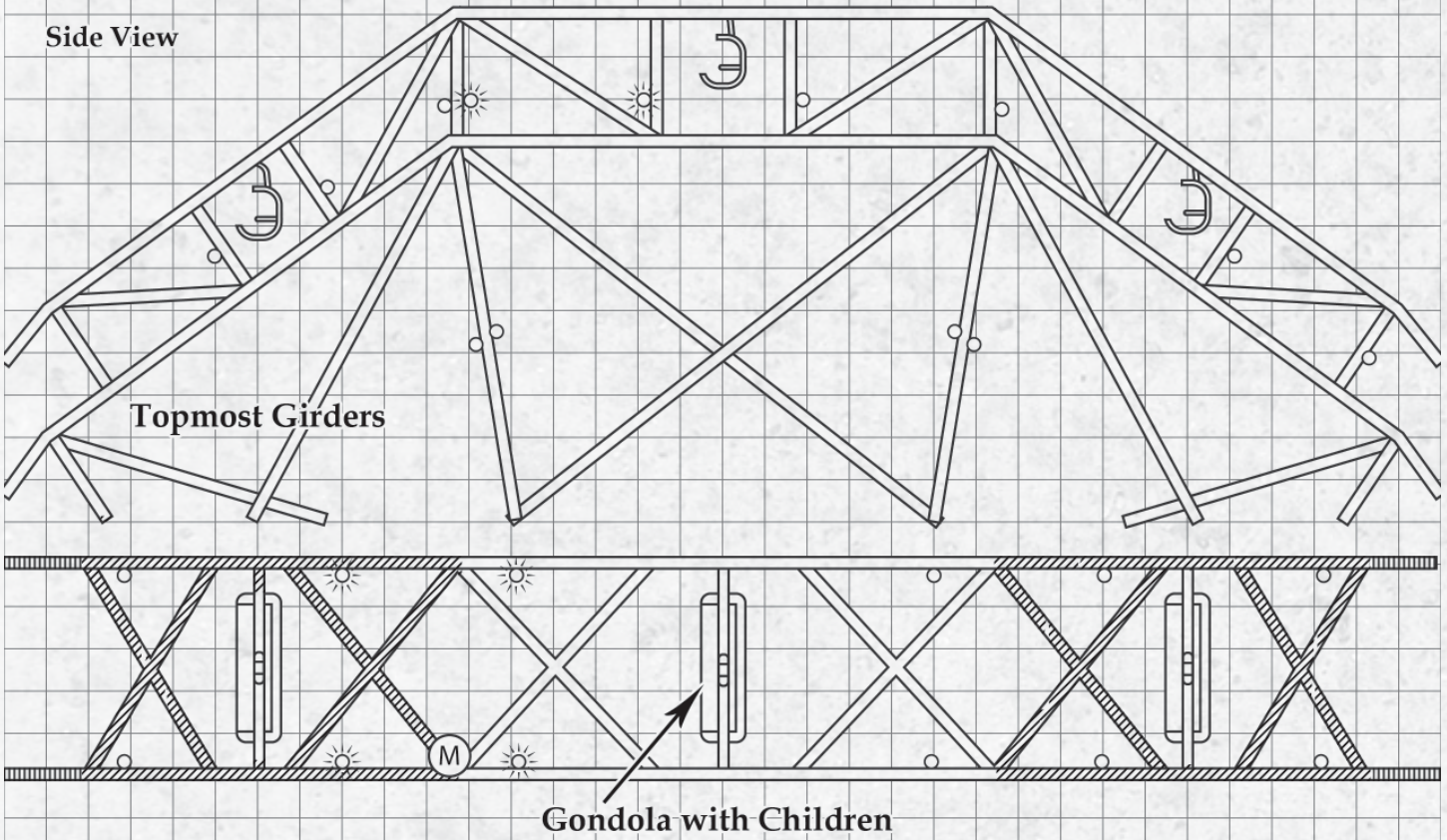





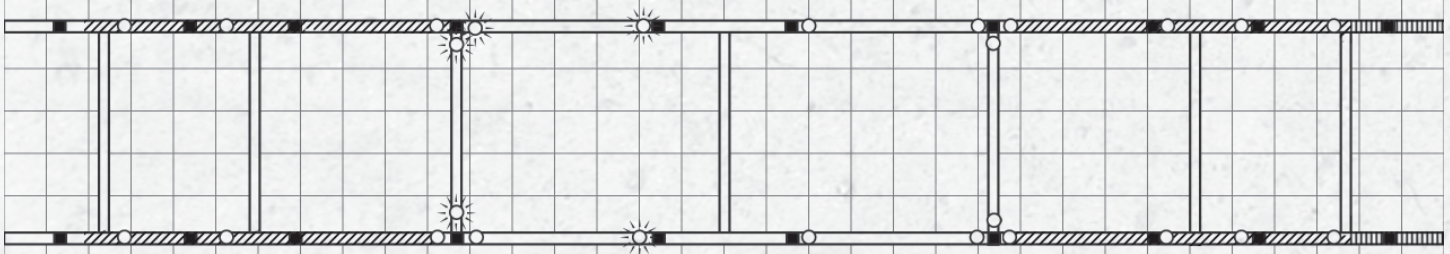

Topmost Girders

Gondola with Children

Girders 15 Feet Below



Key for Top View

-  Horizontal Girder (DC 5 Acrobatics)
-  Less Than 45° Sloped Girder (DC 7 Acrobatics)
-  Greater Than 45° Sloped Girder (DC 10 Acrobatics)
-  Vertical Girder (DC 10 Climb CHECK)
-  Gas Lamp
-  Damaged Gas Lamp
-  Inspector Muncy

# The Great Wheel

1 square - 5 feet

Side View

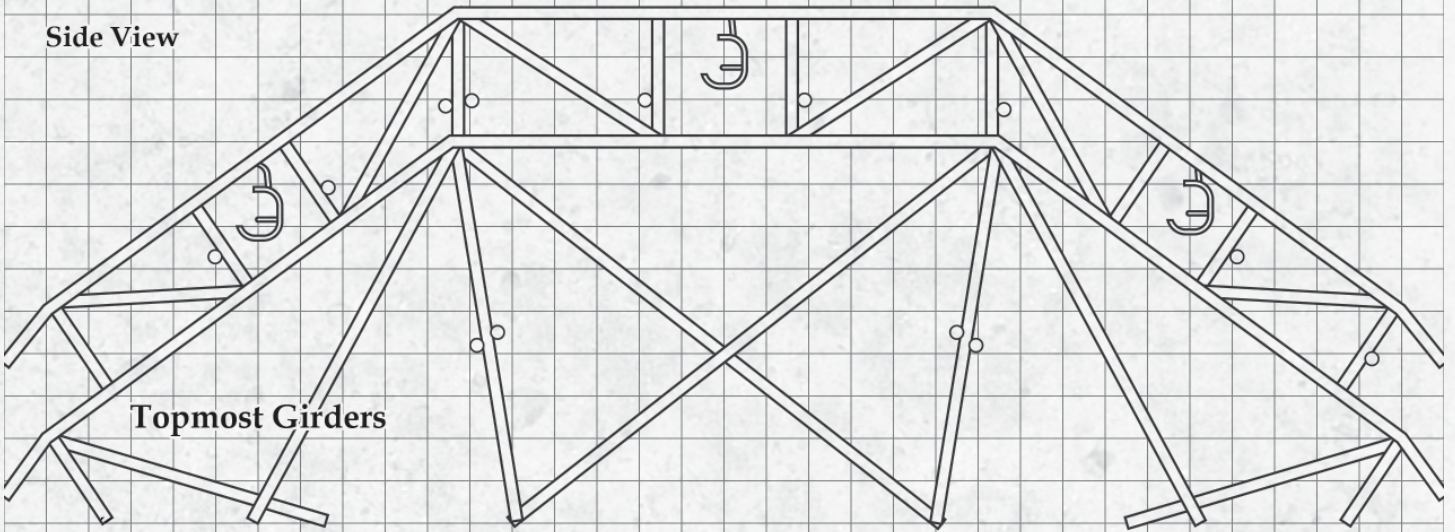

Topmost Girders

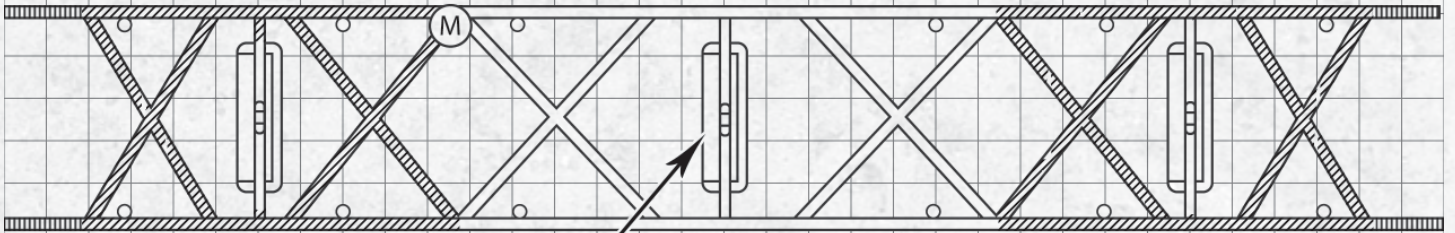

Gondola with Children

Girders 15 Feet Below

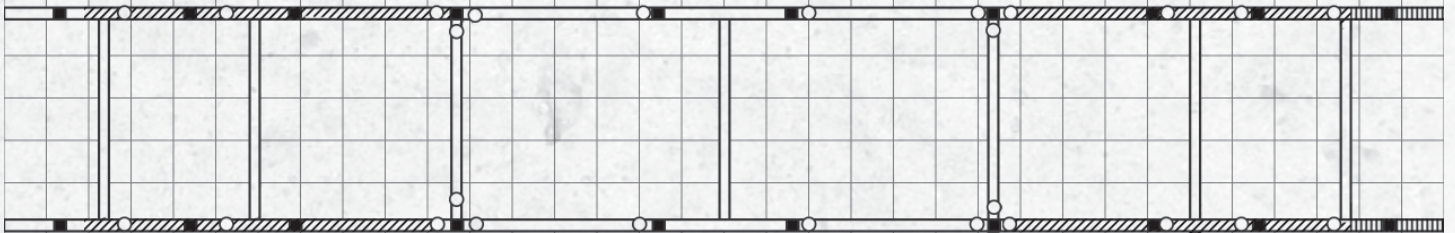

Key for Top View

○ Gas Lamp

## LEGAL APPENDIX

**Designation of Product Identity:** The following items are hereby designated as Product Identity as provided in section 1(e) of the Open Game License: Any and all material or content that could be claimed as Product Identity pursuant to section 1(e), below, is hereby claimed as product identity, including but not limited to: **1.** The name “Frog God Games” as well as all logos and identifying marks of Frog God Games, LLC, including but not limited to the Frog God logo and the phrase “Adventures worth winning,” as well as the trade dress of Frog God Games products; **2.** The product name “The Lost Lands,” “The Blight: Richard Pett’s Crooked City,” “The Blight,” “Between,” “Bloody Jack,” as well as any and all Frog God Games product names referenced in the work; **3.** All artwork, illustration, graphic design, maps, and cartography, including any text contained within such artwork, illustration, maps or cartography; **4.** The proper names, personality, descriptions and/or motivations of all artifacts, characters, races, countries, geographic locations, plane or planes of existence, gods, deities, events, magic items, organizations and/or groups unique to this book, but not their stat blocks or other game mechanic descriptions (if any), and also excluding any such names when they are included in monster, spell or feat names. **5.** Any other content previously designated as Product Identity is hereby designated as Product Identity and is used with permission and/or pursuant to license.

This printing is done under version 1.0a of the Open Game License, below.

**Notice of Open Game Content:** This product contains Open Game Content, as defined in the Open Game License, below. Open Game Content may only be Used under and in terms of the Open Game License.

**Designation of Open Game Content:** Subject to the Product Identity Designation herein, the following material is designated as Open Game Content. (1) all monster statistics, descriptions of special abilities, and sentences including game mechanics such as die rolls, probabilities, and/or other material required to be open game content as part of the game rules, or previously released as Open Game Content, (2) all portions of spell descriptions that include rules-specific definitions of the effect of the spells, and all material previously released as Open Game Content, (3) all other descriptions of game-rule effects specifying die rolls or other mechanic features of the game, whether in traps, magic items, hazards, or anywhere else in the text, (4) all previously released Open Game Content, material required to be Open Game Content under the terms of the Open Game License, and public domain material anywhere in the text.

**Use of Content from *The Tome of Horrors Complete*:** This product contains or references content from *The Tome of Horrors Complete* and/or other monster *Tomes* by Frog God Games. Such content is used by permission and an abbreviated Section 15 entry has been approved. Citation to monsters from *The Tome of Horrors Complete* or other monster *Tomes* must be done by citation to that original work.

OPEN GAME LICENSE Version 1.0a The following text is the property of Wizards of the Coast, Inc. and is Copyright 2000 Wizards of the Coast, Inc. (“Wizards”). All Rights Reserved.

**1. Definitions:** (a) “Contributors” means the copyright and/or trademark owners who have contributed Open Game Content; (b) “Derivative Material” means copyrighted material including derivative works and translations (including into other computer languages), potation, modification, correction, addition, extension, upgrade, improvement, compilation, abridgment or other form in which an existing work may be recast, transformed or adapted; (c) “Distribute” means to reproduce, license, rent, lease, sell, broadcast, publicly display, transmit or otherwise distribute; (d) “Open Game Content” means the game mechanic and includes the methods, procedures, processes and routines to the extent such content does not embody the Product Identity and is an enhancement over the prior art and any additional content clearly identified as Open Game Content by the Contributor, and means any work covered by this License, including translations and derivative works under copyright law, but specifically excludes Product Identity; (e) “Product Identity” means product and product line names, logos and identifying marks including trade dress; artifacts; creatures; characters; stories, storylines, plots, thematic elements, dialogue, incidents, language, artwork, symbols, designs, depictions, likenesses, formats, poses, concepts, themes and graphic, photographic and other visual or audio representations; names and descriptions of characters, spells, enchantments, personalities, teams, personas, likenesses and special abilities; places, locations, environments, creatures, equipment, magical or supernatural abilities or effects, logos, symbols, or graphic designs; and any other trademark or registered trademark clearly identified as Product Identity by the owner of the Product Identity, and which specifically excludes the Open Game Content; (f) “Trademark” means the logos, names, mark, sign, motto, designs that are used by a Contributor to identify itself or its products or the associated products contributed to the Open Game License by the Contributor; (g) “Use”, “Used” or “Using” means to use, Distribute, copy, edit, format, modify, translate and otherwise create Derivative Material of Open Game Content; (h) “You” or “Your” means the licensee in terms of this agreement.

**2. The License:** This License applies to any Open Game Content that contains a notice indicating that the Open Game Content may only be Used under and in terms of this License. You must affix such a notice to any Open Game Content that you Use. No terms may be added to or subtracted from this License except as described by the License itself. No other terms or conditions may be applied to any Open Game Content distributed using this License.

**3. Offer and Acceptance:** By Using the Open Game Content You indicate Your acceptance of the terms of this License.

**4. Grant and Consideration:** In consideration for agreeing to use this License, the Contributors grant You a perpetual, worldwide, royalty-free, non-exclusive license with the exact terms of this License to Use, the Open Game Content.

**5. Representation of Authority to Contribute:** If You are contributing original material as Open Game Content, You represent that Your Contributions are Your original creation and/or You have sufficient rights to grant the rights conveyed by this License.

**6. Notice of License Copyright:** You must update the COPYRIGHT NOTICE portion of this License to include the exact text of the COPYRIGHT NOTICE of any Open Game Content You are copying, modifying or distributing, and You must add the title, the copyright date, and the copyright holder’s name to the COPYRIGHT NOTICE of any original Open Game Content you Distribute.

**7. Use of Product Identity:** You agree not to Use any Product Identity, including as an indication as to compatibility, except as expressly licensed in another, independent Agreement with the owner of each element of that Product Identity. You agree not to

indicate compatibility or co-adaptability with any Trademark or Registered Trademark in conjunction with a work containing Open Game Content except as expressly licensed in another, independent Agreement with the owner of such Trademark or Registered Trademark. The use of any Product Identity in Open Game Content does not constitute a challenge to the ownership of that Product Identity. The owner of any Product Identity used in Open Game Content shall retain all rights, title and interest in and to that Product Identity.

**8. Identification:** If you distribute Open Game Content You must clearly indicate which portions of the work that you are distributing are Open Game Content.

**9. Updating the License:** Wizards or its designated Agents may publish updated versions of this License. You may use any authorized version of this License to copy, modify and distribute any Open Game Content originally distributed under any version of this License.

**10. Copy of this License:** You MUST include a copy of this License with every copy of the Open Game Content You Distribute.

**11. Use of Contributor Credits:** You may not market or advertise the Open Game Content using the name of any Contributor unless You have written permission from the Contributor to do so.

**12. Inability to Comply:** If it is impossible for You to comply with any of the terms of this License with respect to some or all of the Open Game Content due to statute, judicial order, or governmental regulation then You may not Use any Open Game Material so affected.

**13. Termination:** This License will terminate automatically if You fail to comply with all terms herein and fail to cure such breach within 30 days of becoming aware of the breach. All sublicenses shall survive the termination of this License.

**14. Reformation:** If any provision of this License is held to be unenforceable, such provision shall be reformed only to the extent necessary to make it enforceable.

### 15. COPYRIGHT NOTICE

**Open Game License v 1.0a** © 2000, Wizards of the Coast, Inc.

**System Reference Document 5.1** Copyright 2016. Wizards of the Coast, Inc; Authors Mike Mearls, Jeremy Crawford, Chris Perkins, Rodney Thompson, Peter Lee, James Wyatt, Robert J. Schwab, Bruce R. Cordell, Chris Sims, and Steve Townshend, based on material by E. Gary Gygax and Dave Arneson.

**Tome of Horrors**, Copyright 2002, Necromancer Games, Inc.

**Tome of Horrors**, Copyright 2005, Necromancer Games, Inc.;

**Swords & Wizardry Core Rules**, Copyright 2008, Matthew J. Finch

**Swords & Wizardry Complete Rules**, Copyright 2010, Matthew J. Finch

**Monster Compendium: 0e**, Copyright 2008, Matthew J. Finch

**Pathfinder RPG Core Rulebook** © 2009, Paizo Publishing, LLC; Author: Jason Bulmahn, based on material by Jonathan Tweet, Monte Cook, and Skip Williams.

**The Book of Experimental Might** © 2008, Monte J. Cook. All rights reserved.

**Pathfinder RPG Bestiary**, © 2009, Paizo Publishing, LLC; Author: Jason Bulmahn, based on material by Jonathan Tweet, Monte Cook, and Skip Williams.

**Pathfinder Roleplaying Game Bestiary 2**, © 2010, Paizo Publishing, LLC; Authors Wolfgang Baur, Jason Bulmahn, Adam Daigle, Graeme Davis, Crystal Frasier, Joshua J. Frost, Tim Hitchcock, Brandon Hodge, James Jacobs, Steve Kenson, Hal MacLean, Martin Mason, Rob McCreary, Erik Mona, Jason Nelson, Patrick Renie, Sean K Reynolds, F. Wesley Schneider, Owen K.C. Stephens, James L. Sutter, Russ Taylor, and Greg A. Vaughan, based on material by Jonathan Tweet, Monte Cook, and Skip Williams.

**Pathfinder Roleplaying Game Ultimate Equipment** © 2012, Paizo Publishing, LLC; Authors: Dennis Baker, Jesse Benner, Benjamin Bruck, Ross Byers, Brian J. Cortijo, Ryan Costello, Mike Ferguson, Matt Goetz, Jim Groves, Tracy Hurley, Matt James, Jonathan H. Keith, Michael Kenway, Hal MacLean, Jason Nelson, Tork Shaw, Owen KC Stephens, and Russ Taylor.

**Pathfinder Roleplaying Game Advanced Player’s Guide**, Copyright 2010, Paizo Publishing, LLC; Author: Jason Bulmahn.

**Pathfinder Roleplaying Game GameMastery Guide**, © 2010 Paizo Publishing, LLC; Authors Cam Banks, Wolfgang Baur, Jason Bulmahn, Jim Butler, Eric Cagle, Graeme Davis, Adam Daigle, Joshua J. Frost, James Jacobs, Kenneth Hite, Steven Kenson, Robin Laws, Tito Leati, Rob McCreary, Hal Maclean, Colin McComb, Jason Nelson, David Noonan, Richard Pett, Rich Redman, Sean K Reynolds, F. Wesley Schneider, Amber Scott, Doug Seacat, Mike Selinker, Lisa Stevens, James L Sutter, Russ Taylor, Penny Williams, Teeuwynn Woodruff.

**Advanced Bestiary**, © 2014, Green Ronin Publishing, LLC; Author: Jeff Hersh, Developer: Owen K.C. Stephens.

**Creature Collection III: Savage Bestiary** © 2003, White Wolf Publishing, Inc.

**Dead Man’s Chest** © 2005, Necromancer Games, Inc.; Authors: Lance Hawvermale, Rob Mason, Robert Hunter, Patrick Goulah, Greg Ragland, Matt McGee, Chris Bernhard, Casey W. Chistofferson, Chad Coulter, Skeeter Green, and Travis Hawvermale, with additional contributions by Erica Balsley, Lindsey Barrentine, Jay Decker, Rachel Mason, and Nadine Oatmeyer.

**The Blight: Richard Pett’s Crooked City**, © 2016, Frog God Games, LLC; Authors Richard Pett, Pete Pollard, Alistair Rigg, and Greg A. Vaughan.

**The Tome of Horrors Complete**, © 2011, Necromancer Games, Inc., published and distributed by Frog God Games; Author Scott Green.

**The Tome of Blighted Horrors**, © 2016, Frog God Games, LLC; Authors John Ling, Authors Richard Pett, Pete Pollard, Alistair Rigg, Jeffrey Swank, and Greg A. Vaughan.

**TB3: Bloody Jack**, © 2016, Frog God Games, LLC; Author: Greg A. Vaughan.

# The Blight

Richard Pett's Crooked City

## EB3: Bloody Jack

All the children of the Blight know the nursery rhymes about Bloody Jack Carver, cautionary tales for naughty or overly inquisitive children to mind their manners and obey their parents. However, their parents know the true horror of those times 30 years ago when the lunatic serial killer known as Bloody Jack Carver stalked the fog-shrouded streets of the Blight and abducted children. The killing spree finally ended, but the perpetrator was never caught.

When the PCs are deputized to assist in a homicide investigation, they find terrifying clues that point to the three-decade-old Bloody Jack killings and signs to indicate that they were just the beginning. Now the PCs are in a race against time across the breadth of the decrepit and deteriorating city that is the Blight as they attempt to stop a new killing spree before it can start. The PCs' investigation takes them from the halls of the Capitol and the seedy streets and alleys of Toiltown to the garish carnival piers of Festival and the pollutant-crusted banks of the Great Lyme River. Only they stand between the children of this decayed city and new nursery rhymes being written in their blood.

Bloody Jack is a stand-alone adventure set in the Blight for 4–5 5th-level characters.



FROG GOD  
GAMES

ISBN 978-1-62283-343-6

