

DAWNING STAR

OPERATION QUICK LAUNCH

HAMMOCK
BARR
JACOBSON
MORETTI

d20
system

DAWNING STAR



PRINCIPAL WRITING
LEE HAMMOCK

ART DIRECTION
DANILO MORETTI

ADDITIONAL WRITING
CHAD BARR & JUSTIN D. JACOBSON

EDITING
JUSTIN D. JACOBSON

TECHNICAL ADVICE
ROBERT J. GRADY

INITIAL CONCEPT
JOSEPH MARTIN

LAYOUT & SPECIAL FX
DISPARI.NET

PLAYTESTERS

DAVE AHERN, NICK BRITSKY, GREG BRYANT,
JOHN GRAHAM, NICK KELLEY, CHRIS LITTLE,
MARION NALEPA, BRIAN RODERMAN,
RON SHEPHARD, TIM THOMAS, DAVE WALTERS,
BECKETT WARREN, JAMES WHISNANT



d20 System and the d20 System logo are trademarks of Wizards of the Coast, Inc. and are used according to the terms of the d20 System License version 6.0. A copy of this License can be found at <http://www.wizards.com/d20>.

d20 MODERN and Wizards of the Coast are trademarks of Wizards of the Coast, Inc. in the United States and other countries and are used with permission.

All other content is ©2005 Justin D. Jacobson. Dawning Star, Operation Quick Launch, their corresponding logos, and all Blue Devil Games logos are trademarks of Justin D. Jacobson. This edition of Dawning Star: Operation Quick Launch is produced under version 1.0a of the Open Game License, version 6.0 of the d20 System License, version 5.0 of the d20 System Trademark Logo Guide, and the Modern System Reference Document by permission of Wizards of the Coast, Inc. Subsequent versions of this product will incorporate later versions. All rights reserved.

Author's Note: The velin myth that appears at the beginning of Chapter 5 is a re-imagining of a Cherokee Tribe myth.

d20 SYSTEM logo art by George Edward Purdy.

TABLE OF CONTENTS • • •

Salutation of the Dawn	4
INTRODUCTION: THE BREAK OF DAWN	5
Contributor Bios.	8
CHAPTER I: HISTORY	9
Timeline	20
CHAPTER II: CHARACTERS	21
Species	22
Talent Trees	28
Occupations	36
Skills	39
Feats	45
Species Classes	48
Advanced Classes.	50
Prestige Classes	67
CHAPTER III: TECHNOLOGY	73
Adventuring Gear	74
Weapons	77
Ammunition	89
Weapon Gadgets	90
Armor.	90
Computers	95
Terraforming Equipment	96
Cybernetics	97
Relics.	99
Atmospheric and Surface Vehicles	101
Vehicle Weapons.	107
Mecha	109
Starships	110
CHAPTER IV: WORLD OF EOS	119
Time on Eos	120
Geography.	120
Climate/Atmosphere	120
Map of Eos	122

The Terraforming Process	124
Important Locations on Eos	125
Map of Dawning Star	126
Other Points of Interest	132
Factions and Federations	133
Personalities of Eos	135
CHAPTER V: GALACTIC SURVEY	141
The Helios System	142
Map of Helios System	144
CHAPTER VI: XENOMORPHS	147
Eotian Wildlife	148
Tentaari	162
Vaasi	166
CHAPTER VII: MASTER CONTROL	173
The Secret History of Dawning Star	174
The Tentaari	175
The Velin	176
The Vaasi	176
The Ruins of Eos	176
Campaign Concepts	179
Adventure Hooks	180
CHAPTER VIII: A DAY IN THE LIFE	183
Adventure Background	184
Synopsis	184
Adventure Hooks	185
Appendix: Sample Velin Runes	201
Appendix: Character Sheet	202
Index	204

THE SALUTATION OF THE DAWN

*Listen to the Exhortation of the Dawn!
Look to this Day!
For it is Life, the very Life of Life.
In its brief course lie all the
Verities and Realities of your Existence;
The Bliss of Growth,
The Glory of Action,
The Splendor of Beauty;
For Yesterday is but a Dream,
And Tomorrow is only a Vision:
But Today well lived makes
Every Yesterday a Dream of Happiness,
And every To-morrow a Vision of Hope.
Look well therefore to this Day!
Such is the Salutation of the Dawn!*

INTRODUCTION

THE BREAK OF DAWN

Diego rested his chin on his clenched fist and sighed. Sitting in this quiet plain, it occurred to him that this was the farthest he had ever been from Dawning Star in ... well, in his entire life. As the sun crept over the mountain range before him, he looked back over his shoulder and could just make out the gleam of the city-ship, a familiar star to his back.

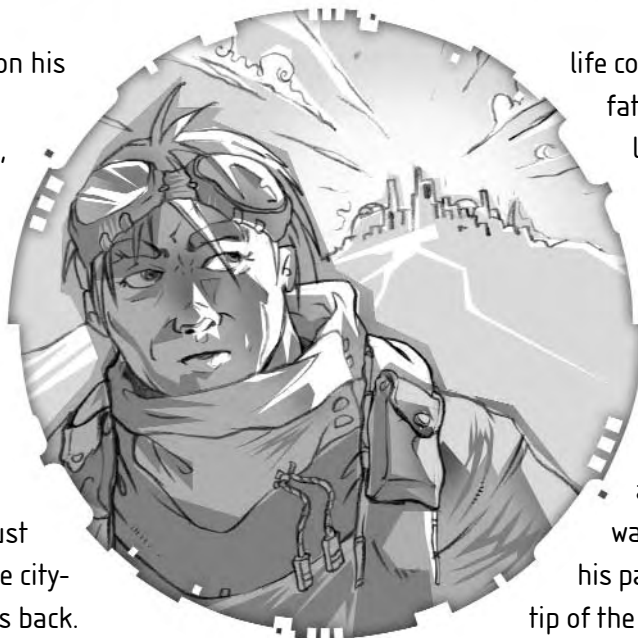

His belly rumbled. Diego pulled a plump, rose-colored pectar from his backpack and took a large bite from its flank. It was high season for pectar, and this one was particularly juicy and smelled as sweet as it tasted. He chuckled, thinking how his abuelo could not stomach them, holding out for a terran apple or nothing at all. A few feet away, Diego's murcow grunted and clicked its hooves on the rocky path. Diego took a few more bites from the pectar and tossed it back to his mount.

Then, it happened. The first few rays of the white sun were cast down from the mountains, instantly bathing the field in their brilliance. Diego squinted, not wanting to turn away, his eyes tearing up. Life inside Dawning Star could be comfortable, safe, even cosmopolitan, but how could it match the beauty of the dawn itself? At that moment, Diego knew he had made the right decision, eschewing a

life cobbling footwear in his father's shop, a safe life. A life outside the city walls was one of adventure, danger to be accurate, but it had its rewards. Diego vowed then that he would never miss another sunrise so long as he drew breath. He watched as the sun marked his path, skirting the southern tip of the Omeo Mountains and turning south to the Bergan Lowlands, to the Council Ruin and whatever danger it might harbor, whatever treasures it might yield.

Diego looked at his forearm and read the Homeric hymn tattooed on it. From the day he first read it—a passage from one of his mother's prize collection of books—it held a special meaning with him. He knew the words by heart, of course, but there was something reaffirming in seeing them imprinted on his skin:

**EOS THE EARLY-BORN WAS RISING
FROM DEEP-FLOWING OCEAN,
BRINGING LIGHT TO MORTALS.**

Diego rose, stretched his arms, and took a position in the saddle upon the murcow. There was farther yet to go.

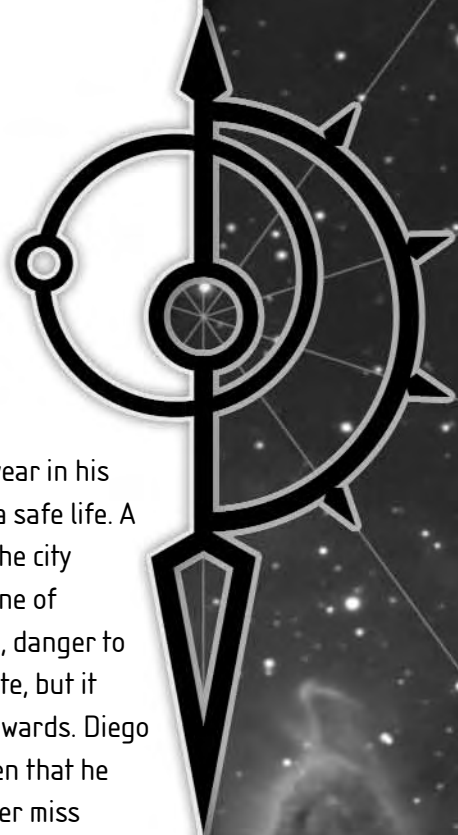

IN CREATING THIS WORLD, WE ADHERED TO TWO RULES

1 IT MUST BE FUN
Some settings are so preoccupied with impressing you by the detail of the campaign world that they forget it's supposed to be fun. DAWNING STAR goes further. When considering each element of the setting—from the overarching concept to the last feat—we asked ourselves: Is this contributing to an enjoyable gaming experience? If the answer was "no," it was cut. If our playtesters found something to be boring, it got reworked. Everything in this book (and the soon-to-be-released DAWNING STAR: HELIOS RISING) is in here because it got a firm "yes."

2 IT MUST BE BELIEVABLE
Among the first people brought in on the project was our technical advisor, Robert J. Grady. He played an instrumental role in shaping the back story for the setting to ensure a level of verisimilitude necessary to a science-fiction setting. Everything in this book is theoretically possible. Some of it may seem wild or even far-fetched, but it is, in fact, the result of studied reasoning. You may have heard the term "hard science." This normally refers to a setting that is utterly grounded in science. Unfortunately, strict adherence to the iron grip of science can make role-playing tedious. That's why we refer to DAWNING STAR as a "firm science" setting. It's hard science up until it encroaches on **Rule 1**; then, we take a step back. The result, we are confident, is a science-fiction setting that will provide you with years of role-playing enjoyment.

THE BREAK OF DAWN • • •

Blue Devil Games is proud to present DAWNING STAR: OPERATION QUICK LAUNCH, the first volume of and the introduction to the DAWNING STAR: CAMPAIGN SETTING, focusing on the planet Eos in the Helios system. DAWNING STAR is a science-fiction setting of high adventure, carefully constructed to provide a myriad of possibilities for players and GMs alike. It was built on the rules from D20 MODERN, including the recently released rules for future settings, and is published under the terms of the Open Game License and the d20 System License.

HOW TO USE THIS BOOK • • •

DAWNING STAR: OPERATION QUICK LAUNCH is an introduction to the setting as a whole. It focuses on the planet Eos, the site of the new human civilization. As you will soon learn, it operates admirably as a standalone product. It was designed to allow you to launch your campaign on the planet of Eos and enjoy a rich role-playing experience. When DAWNING STAR: HELIOS RISING is released, a host of new material will be added, which will permit you to take your existing DAWNING STAR campaign in new directions. Alternatively, having gotten a feel for the DAWNING STAR world, you might decide to begin an entirely new campaign. Within that broad boundary, there is still a lot to choose from.

It is recommended that, if you have not done so already, you familiarize yourself with the D20 MODERN rules. Additionally, players and GMs alike should read the first six chapters of this book. (Players wishing to maintain an air of mystery would do well to avoid reading the vaasi section in chapter 6.) Chapter 8 includes a full adventure for 1st level characters and provides a good introduction to the setting. However, you may find that it does not suit the type of campaign you wish to run. If so, feel free to create your own adventure. In doing so, try to accentuate the defining features of DAWNING STAR, highlight the differences and similarities between Eos and Earth, and above all commit to high adventure.

You will note that some chapters, particularly Chapter 5, are not fully detailed and that some material refers to species, places, and other data not fully explained in DAWNING STAR: OPERATION QUICK LAUNCH. All of this information will be incorporated into DAWNING STAR: HELIOS RISING.

However, if you can't wait that long, some of this information will be released as previews on our website, <http://www.bluedevilgames.com>. You can also post any specific questions on the Dawning Star message boards located at:

<http://p212.ezboard.com/fbluedevilgamesfrm8>.

The Dawning Star creative team frequently appears on these boards to answer such questions.

THE OPEN GAME LICENSE • • •

DAWNING STAR: OPERATION QUICK LAUNCH is published under the terms of the Open Game License and the D20 SYSTEM License. These licenses are the brilliant product of Wizards of the Coast, Inc. and permit anyone to use well-established core rules as a foundation for any type of role-playing game. These rules are released to the System Reference Document (SRD) and are available for free on the internet at www.wizards.com/default.asp?x=d20/article/msrd.

DAWNING STAR uses the basic rules from D20 MODERN and the recently published open content for future settings. The latter will be referred to in this book as Future SRD. Under the terms of these licenses, we are not permitted to present rules for character creation or applying the results of experience to a character. Thus, you will need D20 MODERN to properly run a DAWNING STAR campaign.

One of the benefits of the licenses, is that any open content we publish can also be used under their terms as well. The following material is open content within the meaning of the licenses: All of the species, feats, skills, advanced class-

es, and prestige classes contained in Chapter 2, except for specific references to proper names of individuals and locations and references to the vaasi; all of the equipment names and game mechanics contained in Chapter 3; and all of the xenomorph names and game mechanics contained in Chapter 4, except for the material contained under the vaasi heading. As long as you adhere to the requirements of the licenses, you may use this material in your own publications.

All of the other material in this book is "closed" content, meaning that it cannot be republished, copied or distributed without the express permission of Blue Devil Games. This includes all of the DAWNING STAR logos and titles, all of the artwork, and all other content not specifically enumerated above. In particular, please note that the vaasi are closed content.

The DAWNING STAR character sheet is also subject to these restrictions, except that you have specific permission to make copies of it for your personal use.

The interior of this book is in black and white. However, color versions of some of the maps and illustrations are available to view and download on our website,

<http://www.dawningstar.com>.

WHAT IS DAWNING STAR ALL ABOUT? • • •

DAWNING STAR was created to support a number of campaign models with equal aplomb. Like adjusting the levels on your stereo to accentuate a particular piece of music, a few minor tweaks will result in just the kind of role-playing experience you're looking for.

DAWNING STAR has a strong undercurrent of the early frontier or the Wild West. Setting your campaign outside the walls of Dawning Star and focusing on interaction with the velin or the faction-camps, will augment this aspect. Playing the velin as an analog to Native Americans is also easily accomplished.

With the existence of numerous ruins and unexplored territories, DAWNING STAR can take on a strong pulp feel. To accentuate this quality, send the PCs on adventures to the remotest regions of the

planet on a hunt for the rarest of alien artifacts. The number of off-world encounters should be limited.

To undertake a grim and gritty campaign, increase the presence of the vaasi. They might swarm across the open plains just beyond the Dawning Star walls. It is up to the PCs to turn back the tide. Alternatively, making the Eotian environment more inhospitable, requiring technological advances to merely survive, also serves that goal.

For a campaign with more space opera tones, you can simply use the *Dawning Star* city-ship as a launch point, a home world to which the PCs can return after rigorous space battles. Add additional alien species from other sources or of your own devising. Even by the standard of such campaigns, Dawning Star is megalopolis and can provide a vibrant locale.

WHAT ARE YOU WAITING FOR?
YOU ARE GO FOR LAUNCH!

Born and raised in Atlanta, Georgia, **Lee Hammock** cut his teeth on Star Frontiers at age seven and never looked back. After graduating from the University of Georgia he moved to the frozen north of New York City, where after killing a robotic polar bear as part of an initiation ritual he worked at DC Comics for a time. (You'd be surprised how many robotic polar bears have to be killed every day in the comics industry.) He's worked on over 20 gaming products for companies such as AEG, Bastion Press, Holistic Design, and Louis Porter Jr. Designs, and all he had to kill for those assignments was an emperor penguin. Now Lee lives in Raleigh, North Carolina, where he works as a fulltime freelance game writer and all around professional geek.

Danilo Moretti was born and raised in Turin, Italy, where after an unlucky foray in game-design (just before the Collectible Card craze that nearly wiped out any trace of Rpgs in Italy) reverted to his passions: good music and great food. Unfortunately good music and great food aren't the primary ingredients of the "recipe of life" in the modern world. So, once again, he had to start with something socially useful: work. So pencils, pens, paper, and tablet at hand he became what he became: Artist by day, gamer by night.

When asked, "How long have you been gaming?," **Chad Barr** would have to answer, "I'm not sure anymore, but if you find my red cover Dungeons & Dragons Basic book, I would be mighty grateful". Born and raised in California and currently living in the island community of Alameda, in the San Francisco Bay, **DAWNING STAR: OPERATION QUICKLAUNCH** is his first foray into freelance RPG work. Currently job hunting, in his free time he enjoys writing, playing in one of his three gaming groups, taking care of his sister's dog-don't tell her that - and the occasional CRPG or videogame.

Robert J. Grady has been playing RPGs for more than two decades, and has been reading classic science-fiction and fantasy for as long. A former operator-engineer for a major Internet provider, Robert is now studying clinical psychology while working on various fiction and gaming projects. His greatest joy in life is parenthood. Robert knows over one thousand sublime techniques for cooking with onions.

An avid gamer since early childhood, **Justin D. Jacobson** started Blue Devil Games as an outlet for his gaming passion. He has truly sold his soul; he is an attorney by trade, with a busy Florida law practice in the area of debt collection. The name of the business is a thinly veiled reference to his law degree from Duke University. He met his wife Jeannine in law school, which leads to some heated (and simultaneously quite boring) dinner-table conversation. Justin's writing has been published in works by Malhavoc Press and Bastion Press, and he's just finished his first novel. Know any good agents?

CHAPTER 1 HISTORY

Fifty-five years ago, the colonists on the Dawning Star embarked on the greatest adventure mankind has ever undertaken: Traveling to the stars in the hopes of surviving the destruction of Earth. These brave explorers found a home in the end, but not the one they were looking for. Settling far from where Earth once was, the Dawning Star and her crew set about making a new life on the planet Eos. The human condition has changed drastically over the last fifty-five years since the Earth was destroyed and a new world found, and much has happened in that time. The old world of Earth is now only a memory held in the minds of the older colonists. Its stories will soon be the myths of some faraway world. But in many ways, Eos is a lot like Earth.

The same people. The same problems.
The same need for heroes.



This chapter details the history of Dawning Star as understood by the humans of Eos. This history does not include everything that has transpired in the past, because humans are not aware of the entirety of the history of Eos and the Helios System in which it resides. More information on the history of Eos, the tentaari, the vaasi and the other alien species will appear in the DAWNING STAR: HELIOS RISING.

HISTORICAL OVERVIEW,
PREPARED BY THE DAWNING
STAR REPUBLIC DEPARTMENT
OF STATE FOR NEW
DELEGATE TRAINING

THE FALL OF DARK • • •

In its final years, Earth was a planet of peace and prosperity, where man had long ago learned that fighting himself would be disastrous for everyone involved. Instead, man looked to taming the environmental and medical problems of the day, and Mother Nature arose with quite a vengeance in the second half of the 22nd century. Plagues, flood, and storms struck all regions of the Earth in reaction to centuries of pollution and abuse. Viruses and diseases, previously mastered by science proved more resilient than originally expected, cropping up in new and more virulent strains. Man persevered through these trials, taming nature to his will, but at no small cost. Millions died before the plagues of the time had been banished, and entire nations were lost to shifts in climate. But by the 2180s, the Earth's environment had finally stabilized, and the future looked to be full of prosperity and hope.

It was this hope that first blinded man to the threat posed by the dark object. When it was first detected by amateur astronomers in 2184, everyone ignored the claims of impending catastrophe. Humanity was far too busy celebrating the fact that decades of environmental turbulence seemed to be over. It was not until 2189 that mankind finally sat up and took notice of the dark object's threat. In that year, the existence of the dark object was finally acknowledged by respected scientists the world over, proving right what conspiracy theorists and rumor-mongers had said for years. In one day, the dark object went from being tabloid rubbish to hard, cold fact, and the Earth was left stunned by the conclusions.

The dark object, approximately the size of the moon, would strike the Earth in seven years' time, destroying all life on the planet in the resulting shockwave and firestorm. The source of the object was unknown and its composition was impossible to determine, but more important issues were evident: the human race had only seven years to find a means to save itself from disaster. Corporations were nationalized, martial law was instituted, and every human being on the planet did what they could to try and avert the destruction of the human race. In short order it was determined that there was no way to destroy the dark object before it reached earth and no means to lessen its impact. Indeed, there was only one means for humanity to survive.

Flee.

Research into extra-solar exploration had been on hold since 2169, in response to the destruction of the *U.S.S. Washington*, the first ship designed to travel to Pluto. The *U.S.S. Washington* exploded as

it activated its ion propulsion drives for the first time, destroying the entire ship in the process. While the

official explanation for the explosion was crew error,

some feared the loss of the *U.S.S. Washington*

was simply the unfortunate result of science

hitting a wall it could not overcome. The

velocities needed to reach another habitable

world in anything less than a few centuries

were impossible. Despite these fears,

researchers and scientists the world over

threw themselves at the problem, and by

2186 the Davinger Ion Propulsion

Drive was complete.

A marvel of advanced engineering and physics, the Davinger Ion Propulsion drive used a

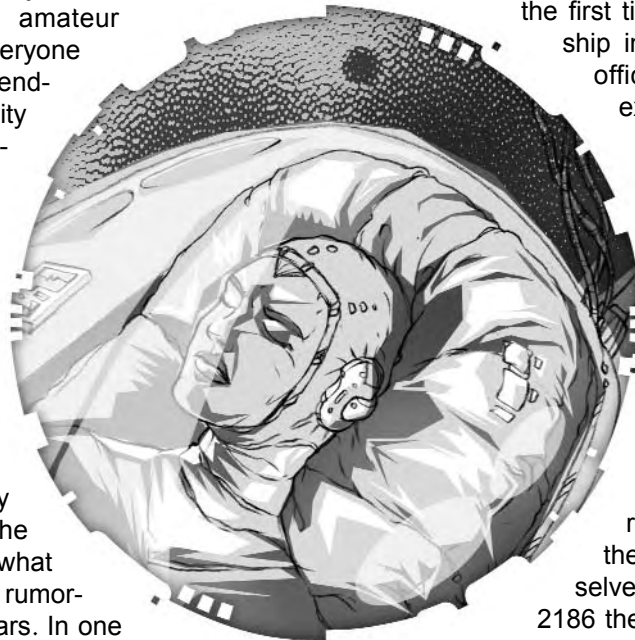

stream of ions created from a laser-controlled fusion process to propel a ship to a significant percentage of the speed of light. A moon suitable for terraforming was found 8.3 light years away from Earth, orbiting a gas giant in the Lalande 21185 system. Even with the Davinger Ion Drive, the trip would take over 80 years.

Plans were quickly drawn up for the construction of a number of massive evacuation ships, each over five miles in length. These ships were each capable of holding two million passengers in cryogenic suspended animation. Meanwhile, the crew would stay awake over the decades of transit, passing on their duties from one generation to the next. Unfortunately, only 20 of these huge ships could be constructed before the dark object was to strike, even with the combined resources of the entire world. Able to save only forty million from a planet of over eight billion inhabitants, the governments of the world used combination of selection methodologies. Some candidates—military personnel, terraformers, space pilots—were chosen for their skills. The remaining available slots were filled by random lotteries. Unfortunately, it was later learned that government corruption and graft sullied these lotteries, and more than a handful of people made it onto the ships that had no business being there. Many of these people are now living outside *Dawning Star*, in Roger's Point or one of the other faction-camps, valuing a small amount of personal power more than the greater good.

The list of evacuees was announced on April 23, 2196, only a month before the dark object was to strike. Amidst riots and chaos, those selected were shuttled up to the evacuation ships, secured in the orbital dry-docks where they had been constructed. Each evacuation ship had a number of smaller escort ships to accompany it, including military vessels to help keep the peace and protect the fleet. The fleet launched on May 1, 2196, leaving Earth and all those on it behind them. This day is now acknowledged on Eos as Remembrance Day, to remember all those who were left behind, who made our survival possible.

On May 25, 2196, the Earth was struck by the dark object and its surface wiped clean of all life by the resulting firestorm and shockwave. Again this day is commemorated on Eos as Lastday, but few among the Eos-born take part in the ceremonies.

FALSE DAWN • • •

The fleet of evacuation ships and support craft set course for Lalande 21185 after observing the final moments of Earth. They never arrived.

On September 2, 2197, while traversing the Oort cloud, the fleet encountered a strange energy signal just off their planned course. A group of escort ships were dispatched to investigate. The ships found a spherical device made of an unknown

LANGUAGES

The evacuation fleet that left Earth used English as its standard language, but Chinese, Spanish, Hindi, and Russian were also commonly used among both the passengers and crew. Most ships carried members of a number of nations. Accordingly, most of the crew on those ships possessed two or three secondary languages. The *Dawning Star's* crew spoke English, Hindi, Swahili, German, Spanish, French, and a smattering of Mandarin Chinese.

These languages have remained in use on Eos, but mostly in small ethnic neighborhoods or settlements.

English remains the *lingua franca* of Eos. In some areas of Eos, regional dialects are beginning to develop, most of which are influenced by the non-English languages common in the region. These dialects are often interspersed with non-English words that do not translate well. The strongest dialects are found in Iron Scar and Hapeville.

material roughly one kilometer in diameter. It appeared to be some sort of space station or outpost. Before the ships could perform an in-depth scan, the device unexpectedly activated, spewing enormous amounts of energy around the fleet. In a blinding flash of light, the fleet suffered severe sensor and computer damage, but the first clue something else had happened was found by simply looking out the window.

The stars had changed.

The evacuation ship *Dawning Star* and its support ships found themselves alone in an uncharted region of space, the rest of the fleet nowhere to be seen. The *Dawning Star* was the primary ship for transporting the terraforming equipment and personnel necessary to make the human race's new home habitable. While repairs were carried out, the crew of the *Dawning Star* tried to get their bearings but found no known points of reference. They could only determine that they were several thousand

light years closer to the galactic core of the Milky Way. Once their sensors were back online, they detected that they were on the edge of a stellar system containing several habitable worlds, a stroke of luck no one could believe at the time. Near their position, a similar object to the one encountered in the edge of Earth's solar system was detected. However, it showed no signs of the massive energy output experienced with the first object, and it responded to no form of communication or scan. It seemed completely dead, abandoned, or broken. Having nowhere else to go, Captain Brandes Jonah of the *Dawning Star*, now senior officer of the remaining fleet, set course for the closest habitable world in the stellar system. Arriving in orbit on August 28, 2198, the colonists found more than they could have hoped for.

The world below them had an atmosphere breathable by humans, though prolonged exposure did cause rashes and agitation of the lungs. The world also had large bodies of water, arable land, and vegetation, which was a far more inviting environment than their original destination in Lalande 21185. Thinking themselves lucky beyond measure, Captain Jonah ordered the *Dawning Star* and its escort ships to land on the planet immediately and begin the terraforming process. While some officers disagreed, saying they should look for the rest of the fleet or examine the other worlds first, Captain Jonah pointed out that they left Earth to find a world just like this one. Better the fleet should come find the *Dawning Star*.

Captain Jonah named the planet Eos after the Greek goddess of the dawn, and the colonists thanked their lucky stars that they had found it. A beacon was left in orbit, broadcasting a message to the rest of the fleet on standard emergency channels. Some still hold out hope that the rest of the fleet will one day find its way to Eos.

DAYBREAK • • •

The *Dawning Star* touched down on August 30, 2198. It rests in that same location today, reconfigured as the city, Dawning Star. This day is celebrated across Eos as Landfall Day and is the most widely celebrated holiday on the planet. The initial landing was not as easy as expected, as the ships encountered a previously unknown form of mildew in the upper atmosphere of Eos. This condition caused metal to rust at an amazing rate. Several ships were lost to this mildew, now called rust spores, before they were able to reach the surface. It was evident that none of the ships would survive a return trip through the upper atmosphere. It wasn't until 2210 that a special hull coating was developed that made spacecraft immune to rust spores.

Initially only the crew of the *Dawning Star* and her support ships along with the terraformers were active, leaving the two million passengers asleep in

order to conserve resources. Within a few weeks, the terraforming process was underway with a projected timeline of 50 years to make the world fully supporting of human life. Luckily, the process was easier than forecast and took just over 30 years. The terraforming changes to the environment of Eos caused some problems for the indigenous life forms, but other than a few changed migration routes and some temperature changes, the effects of terraforming on the native flora and fauna were negligible. In the years since, terran life forms have been introduced to Eos in controlled conditions, and a number have successfully adapted to the new world. Unfortunately, several native Eotian species have been rendered extinct in the process.

The *Dawning Star* itself was partially disassembled and the parts used to build the central city of the new colony. Taking apart the *Dawning Star* was seen by the citizens and crew as the ultimate sign of faith, as they dismantled the only means they had of leaving Eos *en masse*. This process made available a huge amount of resources for building the central city of the colony. This city, also called Dawning Star, is by far the largest settlement on the planet. Constructed of titanium, polymers, and other advanced materials, it looks like a shining jewel in the morning sun, its many reflective surfaces welcoming the day.

Less than a year after landing on the planet, the first human was born on Eos. Amanda Polk made her way into the world January 22, 2199 and quickly became a symbol of the tenacity of the human race and a celebrity in the colony. Her parents were both terraformers who had fallen in love and married in the earliest days of the colony. Their story is now a common topic of romance novels and is soon to become one of the first movies produced on Eos. Amanda Polk now serves as the Director of Education in the Dawning Star Republic and is one of our most decorated citizens.

While the initial orbital scans of Eos turned up some signs of past habitation, organized investigation of these ruins did not occur until 2200 due to all the work going into the early colonization and terraforming efforts. Once the investigation began, the colonists were shocked at the number, size, and complexity of the ruins they found. Many of the ruins were built of titanium, steel, and even some materials they did not recognize. Towering buildings taller than any skyscraper on Earth were found along with smaller, simple stone buildings. The ruins were normally found in large, city-like clumps, of which there are dozens spread out across Eos. The remnants of advanced technologies were found as well, but most were too damaged to function. The few pieces that were useful provided enough encouragement for hundreds of colonists to spend their spare hours hunting for lost relics. The current theory is that Eos was home to a number of

sentient species-much like the hominids of Earth's past-which eventually wiped each other out in a cataclysmic war tens of thousands of years before we arrived. Our archaeologists have been working for decades now on piecing together the secrets of the past inhabitants of Eos. Their findings could easily fill this entire briefing, so you'd be better served reading some of their actual reports on the subject at a later date.

In addition to the older structures, a number of newer ruins were found in 2202 scattered across the planet. These second-order ruins were not found in clumps like the older ruins. These new structures were, in fact, the wreckage of crashed spacecraft of non-human design. Later investigation found that at least four different design styles were present in the wrecks discovered. Most of these wrecks seemed to have been brought down by the rust spores, but others carried marks of battle damage. Using these materials and designs, the colonists were able to construct a small fleet of ships capable of achieving orbit around Eos. However, until 2210, they had no means of leaving the atmosphere due to the rust spores. This piecemeal starting point continues to influence human spacecraft design. Even today, many human ships look like a mishmash of different design styles.

In 2210, a wrecked ship of a markedly different design was found in the fields of the Bergan Lowlands, east of Dawning Star. This circular, saucer-like craft was nearly intact despite the crash. The only real damage appeared to be caused by weapons-fire as opposed to crash damage. There was no sign of the ship's crew, and investigators eventually assumed they were killed elsewhere on the planet after leaving the wrecked ship. Within this ship were found technologies far in advance of the other wrecks on the planet. From this ship, we received our first hints of the existence of the *tentaari* and were able to leap decades ahead in terms of metallurgy, spacecraft technology, and energy weaponry. It is from information found on this ship that the first plasma weapons were created, and some of the materials salvaged from the ship led our colony's researchers to perfect the metal treatment that makes the hulls of our ships resistant to rust spores.

During this time of heightened exploration, there were a number of sightings of creatures that came to be called "darklings." These creatures were principally sighted by small groups of explorers working in the ruined city areas. While these creatures were said to rarely approach and usually avoided interacting with humans, their presence was found by most to be deeply disturbing. Sometimes darklings were blamed for missing groups of explorers. However, there are numerous other tangible threats faced by explorers of Eos, so undocumented bogeymen sightings were hardly needed to explain the disap-

pearance of those brave souls. While most citizens wrote off stories of the darklings as products of an exhausted or paranoid mind, the sightings have occurred regularly for almost 50 years. No one has yet captured a darkling for study and there are a wide variety of theories as to what they are, though few are backed by respectable scientists. To many, the darklings are simply the "Loch Ness monster of Eos," seen most by those who want to see them.

While the darklings are generally considered a myth, there are several dangerous creatures on Eos that were encountered in the early days of exploring the planet. The most commonly encountered is the Dawson dragon, a large reptilian creature named after the first citizen known to be killed by one. Dawson dragons are over ten feet long and are sometimes domesticated by ranchers for use as mounts; their preference for murcow meat can make domestication difficult. Another common hostile species is the spitter spider, an insect species found in many ruins that is capable of spitting a powerful acid over 50 feet. These creatures prefer the meat of creatures indigenous to Eos as opposed to humans or other Earth species, but they have been known to make exceptions when hungry.

There are numerous other kinds of fauna found on Eos that are dangerous, but those are covered in the Department of Science's Common Life Forms of Eos report.

THE WAKING • • •

On August 30, 2228, Landfall day 30 years after the day the *Dawning Star* set down on Eos, the terraforming process was declared complete, and the first passengers were revived from their cryogenic stasis. The process of waking the passengers from their cryogenic sleep continued for ten years as the colonists adjusted to having a larger population; new buildings were constructed, and new fields were planted. The newly awakened colonists increased the variety and breadth of skills available to the colony, which had previously been primarily inhabited by the Dawning Star crew, military personnel, and terraformers. Numerous agricultural engineers, planetologists, and biologists helped improve the quality of life on Eos. Soon thousands of acres of transplanted earth crops were being cultivated, and by 2232 the colony was self sufficient with regard to food sources.

One of the indigenous life forms, a bovine-like creature called a murcow, was the first native life form officially proclaimed fit for human consumption by colony scientists. The murcow was the first source of food native to Eos used by the colonists, and it remains a mainstay of the colonial diet. Soon

THE CREATURE TANKS

North of the city of Dawning Star lies the Terraforming Fields, a massive network of atmospheric converters, storage tanks, and powerful computer-controlled centers. From here, the entire terraforming process of Eos is directed. One of the most important parts of the Terraforming Fields are the creature tanks, a series of massive, deep-freeze tanks. These containers house the genetic information for thousands of earth species, which can be cloned and introduced into the ecosystems of Eos.

Introduction of species is carefully planned and dependant on various factors including the relevant stage of the terraforming process. The creature tank facility is the only cutting-edge genetic engineering facility on the planet and the only one where human genetic modification can be performed safely. However, human bioengineering is quite rare due to the scarcity of the resources involved. The terraformers need to conserve what resources they have for populating the planet.

thereafter, organized ranching of the murcow began, leading to the creation of a frontier-style culture of ranchers and mur-herders, who direct herds of thousands of murcows across the fields of Eos. Most say murcow meat tastes similar to pork, though a small number of humans find the flesh of the murcow indigestible and suffer from violent nausea when the meat is consumed. This condition is called Fisher's Syndrome after the first colonist to show its symptoms.

While some of the Eotian vegetation has been found useful as a seasoning or garnish, only the pectar fruit is suitable for human consumption in large quantities. This large, yellow fruit is common in the jungles of the equatorial region of Eos just to the South of Dawning Star. Its taste is principally equated to a mixture of orange, apple, and star fruit. The pectar fruit's vibrant flavor has made it a

avored food among our citizens and the faction-camps. Plantations growing pectar fruit have begun to spring up in the regions to the south, and the pectar fruit industry is considered one of the great growth industries of the next few years. While humans find few indigenous plants or animals on Eos edible, our planetary neighbors, the velin, eat a wide variety of plants native to Eos. Their physiology, though only slightly different than our own, is more accepting of the native flora.

THE BIRTH OF THE REPUBLIC • • •

The crew and passengers of the *Dawning Star* were mostly citizens of the United States of the Americas, the Euro-African Union and the Indian Consortium before their trip to the stars. After most of the passengers were awakened, it became clear that a change in government was needed due to the vastly expanded population, few of whom were accustomed to operating under military direction. To this end, the Dawning Star Republic was founded in 2230, creating a representative democracy to rule the city of Dawning Star and its allied settlements. The crew of the *Dawning Star*, which had ruled the colony for 32 years as a military oligarchy, passed over the reins of power to the fledgling Republic without incident. On February 1, 2230, the Constitution of the Dawning Star Republic was ratified by overwhelming popular vote. This resulted in the creation of a three-branch government much like the United States of old, though with a unicameral legislative body instead of a bicameral one. Six months later, on August 1st, the first elections occurred. Brandes Jonah, the original captain of the *Dawning Star* but now retired from active service, was elected as president to a six-year term. The people of Dawning star also elected 21 senators to serve in the Colonial Congress. In short order district sheriffs and judges were selected, and the ten colonial departments were established (Agriculture, Defense, Education, Emergency Management, Health, Industry, Law Enforcement, Science, State, and Trade).

For the most part, the elections were peaceful, and the vast majority of citizens took part enthusiastically. However, a vocal minority attempted to stop the elections. Some claimed the Constitution did not do enough to guarantee personal freedoms, lacking a Bill of Rights as broad as they enjoyed on Earth; others feared the shift of emphasis away from military rule would doom the colony. While many of these naysayers were content to try and change the system from the inside, others were not and left Dawning Star completely. These dissidents formed the various faction-camps spread across Eos. Most of these camps border the territory claimed by the Republic and make their own territorial claims. Few of these camps are little more than fortresses run by power-hungry fools whose legiti-

macy is found at the end of a gun barrel. While a few are more orderly and even trade with the Republic, most faction-camps are places where Republic citizens should watch their money and their backs. The Republic defends itself from the faction-camps when required and retaliates severely against any hostility, but generally prefers to coax these settlements back into the fold with a promise of prosperity rather than force.

The largest of these faction-camps is Roger's Point, founded in 2232 by Patricia Rogers. From here, the Eos Freedom League (EFL), a loose conglomeration of faction-camps aligned against our Republic, seek to undermine the order and prosperity of our colony. Roger's Point is the first coastal settlement on Eos. Some of our less than honorable citizens have helped fuel its economy with their demand for black-market seafood, most of which is made up of transplanted species from Earth that were stolen from the creature tanks. The inhabitants of Roger's Point claim there are a number of native sea creatures that are digestible by humans, but the Department of Health has thus far disputed their claims.

THE HARD YEARS • • •

While the earliest days of the colony were not easy, they were made less difficult by the unity and discipline of the colonists. In the years after the elections, the faction-camps caused significant erosion in the unity and discipline of the colony, and dissent began to spread throughout the colony. Our people forgot that prosperity has its price. This time is called the "Hard Years" by most colonists and remembered with great regret and tales of rough times. Many colonists consider the Hard Years to have begun in 2231 with the first reported case of the blood blisters, but some say they began as soon as the faction-camps were founded.

Sometime in October of 2231, a group of Dawning Star explorers released a virus trapped in an ancient ruin and spread the infection while purchasing supplies in various faction-camps before returning to Dawning Star. A few days after their return, the explorers broke out in blood-filled blisters. All were dead within a week of the blisters first appearing, their skin sloughing off in large chunks. The virus, nicknamed "the blood blisters" by the citizens of Dawning Star, quickly spread throughout the city and several of the faction-camps. By the time a cure was developed in late November, 10% of the human population of Eos was killed, and 65% of that season's murcow harvest was lost. Many citizens still carry scars from the blood blister epidemic. Since that time, Dawning Star has instituted strict guidelines for exploration of the ruins found across the surface of Eos. Unfortunately, not all the faction-camps have such well-thought out guidelines.

In the wake of plague striking Eos, war followed

NAMING CONVENTIONS

After 55 years, many of the nationalities and ethnicities that arrived on the Dawning Star have mixed together, producing a hodge-podge society. It is common to have an English or German first name mixed with an Indian or Swahili last name and vice-versa. English first names are the most common. Also many families have forsaken their old surnames and taken up new ones to represent their new homes on Eos. Some have begun using the names of their home settlements as their surname. For example, a man from Dawning Star might take the name "John Dawning." This is usually done by more nationalistic colonists and is especially common among the faction-camps. "Eos" itself has become a rather popular name for girls.

shortly thereafter on a foggy March morning. While the faction-camps had spoken out against our Republic from their earliest days and sought to undermine our economy, none were brave enough to actually attack the Republic. At least until 2235. On the morning of March 12th, a group of raiders from the faction-camp of Red Hill attacked a group of Republic agriculturalists, stealing their harvesting vehicles and killing two of their number. When reports of the attack reached Dawning Star, the populace was outraged. Since the creation of the Republic, there had been no standing army, with most law enforcement and military duties handled by sheriffs, deputies, and the elite Republic Rangers, who patrolled the outlying settlements that remained loyal to the Republic. In response to the attack, a posse headed out to Red Hill to arrest the attackers, but was met with a surprising amount of resistance as several other faction-camps, all members of the Eos Freedom League, came to defend Red Hill. Forced to retreat, the posse returned to Dawning Star empty handed, causing even more outrage among the people of the Republic.

Surrounded by people calling out for justice, President Jonah ordered the few military vehicles the colony had prepared for war. This fleet consisted of 30 armored vehicles, low-altitude assault aircraft,

and hover scouts. They had not been used since the *Dawning Star* landed on Eos except in training drills, and none of their crew had any real combat experience. Along with these vehicles, the Department of Defense created a volunteer military force, the Republic Militia, to collect and organize individuals who wanted to serve their colony and strike back against Red Hill and the Eos Freedom League. Two months later when the 1st Armored Company, 1st Air Company, and 1st Infantry Company of the Republic Militia marched out of Dawning Star, they did so to cheers and adulation.

A week later, the dissidents of Red Hill and the Eos Freedom League found they had drastically underestimated the courage and tenacity of our Republic and its citizens. Many of those in the faction-camps think our citizens are weak and slothful, having grown soft from easy living, but that is their mistake, for on Eos there is no easy living. When the Republic Militia marched on Red Hill, they met the bulk of the Eos Freedom League forces just outside the settlement and routed them handily. The Freedom League had no proper armored vehicles, only converted farm vehicles and cargo trucks with a few crop dusters for air support, leaving them vastly outclassed by the Republic Militia's forces. The battle lasted a single day. By evening, Red Hill was officially annexed by the Dawning Star Republic, and the Eos Freedom League had lost much of its military equipment. Although Red Hill remains part of our Republic, it has never completely taken to the touch of law and order, and it remains a rough and tumble place. To this day, there are constantly rumors of Eos Freedom League agents operating from within the town.

THE EXPANSION YEARS • • •

After the Battle of Red Hill, it became apparent to the leaders of the Republic that they must secure their own resources before the Eos Freedom League and other hostile groups beat them to it. Surrounded by faction-camps on many sides, the Republic risked being cut off from resources in the immediate area. The colony had a steady but small stream of raw materials coming in from scavenged ruins in the vicinity, but these resources were obviously finite. To this end the Departments of Science and Defense launched a joint project to locate sources of mineral wealth in the areas surrounding Dawning Star that

were not already claimed by faction-camps, hoping to avoid conflict with the camps if possible. In 2238, the resource teams found a vast supply of iron ore in the Sander Mountains several hundred miles to the west of Dawning Star. In short order, a mining post was established by the Republic. The fledgling settlement was named Iron Scar by its inhabitants due to the unpleasant environment of the Sander Mountains. Bordered on all sides by deserts and mountains, Iron Scar was hot, dusty and arid. Despite the harsh surroundings, the settlement boomed due to the rich iron deposits in the surrounding mountains and soon became the second largest settlement on Eos. However, this prosperity also made it a prime target for the Eos Freedom League and the faction-camps. The Republic Militia established an outpost in Iron Scar and gave them a pair of armored vehicles for defense, but the city remains a less orderly place than Dawning

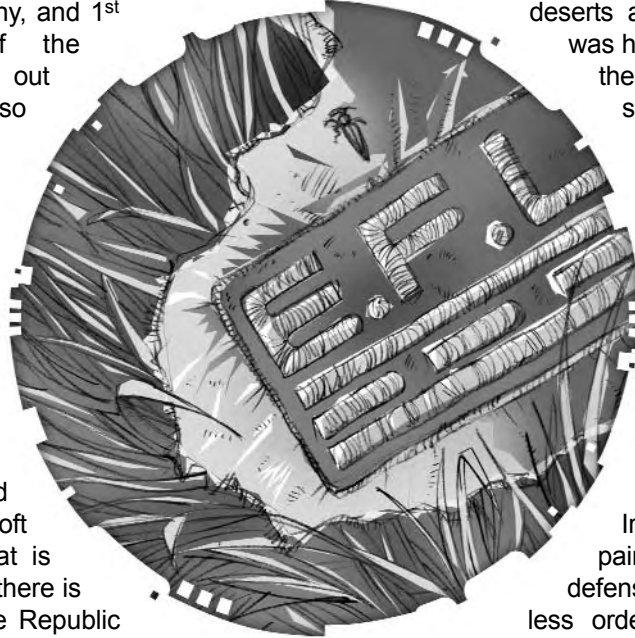

Star. It has become something of a haven for loyal citizens of the Republic who want a little more excitement or personal responsibility in their daily lives, though it is not the hotbed of dissident activity that Red Hill can be.

Shortly after the founding of Iron Scar in 2238, the Dawning Star Resource Zones were also established, laying out the exact areas claimed by the Republic outside the city. These zones encompassed much of the plains and mountains to the north, the jungles to the south, and the plains to the east. Named the Northern, Southern, and Eastern Resource Zones respectively, these areas became new focus points for the agricultural and mining operations of the Republic. Additionally, they quickly became a popular place to settle for those leaving the city of Dawning Star. The Resource Zones have become some of the most productive regions of the planet in terms of raw materials and are regularly patrolled by the Republic's military forces. Despite this attention, the Resource Zones are rough and tumble places, where one must be tough and willful to survive. Like Iron Scar, they have become havens for the more individualistic among our citizens.

MAJOR EVENTS • • •

The influx of iron from Iron Scar and other resources from the Resource Zones brought a much needed boon to our Republic. But what real-

ly raised the people's spirits was the first season of the Eos Professional Baseball League in 2239. Only two teams played, the Dawning Star Patriots and the Iron Scar Scrapers, but the event was widely celebrated both in the Republic and some of the faction-camps. Providing a sense of unity, the League has continued to play each year and now boasts six teams from around the Republic. Not to be left out, 2240 saw the inaugural season of the Eos Professional Football League, playing European football with a starting roster of eight teams. There is a fierce competition between these two leagues for the attention of fans, and they provide one of the most popular entertainment options on the planet. While both leagues claim to be professional, most athletes have a job in addition to their athletic career. While our economy is strong, it cannot support full-time artists or athletes as of yet.

Unfortunately, the good times were quickly overshadowed by the murder of almost a dozen agriculturalists and resource agents over a period of two weeks in the summer of 2240. The Eos Freedom League was initially suspected as the culprit in these crimes, a charge they deny to this day. In response to public outcry, the Department of Defense created the first full time, volunteer standing army in the Republic's history. The Eos Defense Force (EDF) was formed from the more experienced officers of the Republic Militia and the troops trained in operating the Republic's limited pool of military vehicles. These troops became full-time soldiers and began regular patrols around the edges of Republic territory looking for the perpetrators of the murders. The culprits were never found in the end, but the murders stopped as soon as the Eos Defense Force began its patrols. Many still blame the faction-camps for the murders, only adding to the long list of grievances each side holds against the other. Some more paranoid citizens say the darklings were to blame, but such ideas are considered little more than poorly thought out gossip at best. Despite the murders and the stepped-up military activity, our Republic continued moving ahead.

While the Department of Education had been operating a newspaper, radio station, and television studio since 2226, the first private newspaper began operation in 2241. Owned and operated by the entrepreneur Catherine Grunch, The **Daily Star** soon became the premiere newspaper on the planet, all but putting the government paper out of business. Later in the same year Ms. Grunch, launched the Dawning Star Video Network, the first privately-owned video channel on Eos. Again, it proved more popular than the Department of Education's video offering.

In 2242, the first major industrial facility went into operation, producing farming equipment and ground vehicles. Until that point, most manufacturing had been done by hand using a cottage indus-

LAW IN THE DAWNING STAR REPUBLIC

While Dawning Star proper possesses police departments, including such specialized units as SWAT teams, the security forces in the Resource Zones and Iron Scar are not as organized or numerous. Instead, most settlements rely on a locally elected sheriff and his deputies for law and order. These sheriffs are usually locals with military or law enforcement experience, who are popular with the locals. Most sheriffs do their best to live up to their duties, but not all are immune to corruption. In regions where they are the only law, a few have become *de facto* despots.

Deputies are usually citizens who are members of the Republic Militia and are called upon by the sheriff to regularly help with patrols, posses, and similar functions. Local judges or mayors usually handle trials with lawyers being a rarity in most frontier settlements. In some settlements, the sheriff serves double-duty as judge.

In addition to sheriffs and deputies, the citizens of the Republic's outlying settlements rely on the Republic Rangers to maintain law and order. These brave individuals are all veteran sheriffs, judges, or military officers who have taken up the cause of providing law and order to those citizens beyond the walls of Dawning Star. Wandering from place to place, they help citizens with all sorts of matters, from deciding property rights to hunting down dangerous creatures or fugitives. The Republic Rangers have authority over all local officials except for mayors. Among the people of the Dawning Star Republic, the Republic Ranger is a romantic figure, like the Canadian Mounties of Earth, wandering alone through the wastes bringing justice to all.

try model, a practice which has not died out on Eos despite the return of mass production. The Styler Vehicle Plant remains one of the most important industrial centers in the Republic. However, many colonists prefer to purchase handmade goods over those built in a factory.

The year 2247 was ushered in by a string of murders in Dawning Star that shocked the colony. Murders had happened in the city previously but never in the number or with the brutality of these killings. Over a dozen individuals were murdered by an unknown assailant. The **Daily Star** named the killer Shadow Jack for his ability to disappear without a trace after committing his hideous crimes. For most of the year, the city lived in fear of Shadow Jack, but his crimes finally stopped when the Eos Defense Force was called in to patrol the city. To this day, the identity and motive for Shadow Jack's killing spree remains unknown, but it is a common topic for speculation.

CONTACT • • •

2248 stands out as one of the most important years in human history. While we knew there were aliens somewhere in the galaxy due to all the ruins and crashed spacecraft on Eos, it was commonly thought that they had long ago left or died off. In our first fifty years on Eos, none of them had made themselves known to us. This all changed on December 1, 2248 at 8:00 AM when a saucer-like vehicle carrying a delegation of tentaari touched down outside Dawning Star.

The tentaari approached under a banner of peace, wearing masks that seemed to be a crude or ceremonial depiction of a human face. Beneath these masks, the tentaari were slight, small humanoids with grey skin and large, pupil-less eyes. They resembled one of the more common depictions of aliens that had been around since the 20th century. This was no coincidence. It was quickly learned that the tentaari had visited Earth many times. Their delegation of six diplomats addressed the leaders of the Dawning Star Republic in perfect American English, and they showed a passing familiarity with our technology and society. While

the first visit from the Tentaari lasted only a week, it revealed enough information to change the human race forever.

The tentaari were a "guardian" race that had over the centuries taken a number of less advanced species under their wing. They had visited Earth to keep track of our progress. However, due to technical difficulties with their faster-than-light gateway network, they had not able to travel to Earth for the last century. This gateway network, we came to learn, was the same device that had transported the *Dawning Star* to Eos. According to the tentaari, the network had suffered catastrophic damage in the recent past and they were no longer able to access the network from this area of space. They had set up the jump gate in our solar system to usher any ships that came near it to Eos to ensure their survival, something of an emergency escape route for mankind. Unfortunately the gateway system was too damaged to send the entire fleet to Eos. The revelation that the tentaari were at least in part responsible for the loss of the rest of the fleet has earned them the ire of some of our citizens, creating an undercurrent of mistrust that continues to this day.

The tentaari were not disposed to share much information or technology with our leaders, fearful of what we would do with said knowledge. When we demonstrated our mastery of the technology we had salvaged from the tentaari ship that crashed in the Bergan Lowlands they became alarmed. Apparently, they did not know that a ship had crashed on the surface of Eos. They demanded we turn over all information on the technology gained and destroy the devices we had already built based on what we learned, but our leaders refused. Eventually, the tentaari relented in exchange for an agreement to share what advances we made with the tentaari so they could make sure we were not progressing in a dangerous fashion. With their toys already in our hands, it was better to make sure we played with them safely than try and take them away. The tentaari are the only other race with the means to protect ships from the rust spores.

The tentaari's first visit only lasted a week, but they returned regularly to exchange information on



other planets in exchange for diplomatic agreements and resources mined from Eos. The tentaari revealed that the other planets of the Helios system contained a high concentration of intelligent life, thanks mainly to the efforts of the tentaari to save species under threat of extinction as we once were. The tentaari seek to encourage the technological and industrial development of the Helios system for the good of all.

Just after we had gotten over the shock of contact with the tentaari, we were in for another shock, but this one came from our own backyard. In 2249, reports began to filter in from outlying Republic outposts and some faction-camps about strange humanoids lurking in some of the larger ruin complexes. Some thought these creatures to be darklings finally attempting to make contact with humans, but this was quickly proven wrong. Equipped with primitive weapons and clothes, these purple-gray skinned aliens approached the first group of Republic Rangers sent to find them, bearing gifts and making gestures of peace but speaking a language no one could understand. After some lengthy pantomime and weeks of hard work by the Republic's finest linguists, it was discovered that these humanoids, calling themselves the velin, were native to Eos. They claimed to have been hiding the entire time since the humans arrived, an idea many colonists found highly dubious. The velin are a nomadic hunter-gatherer society that mainly use tools made from the ruins of Eos. This has led some to speculate that they are the primitive descendants of the original inhabitants of Eos, a theory backed up by the fact the velin themselves claim to have always been on Eos. Unfortunately, the velin do not seem to understand time as humans do, for they claim that humans have always been on Eos as well.

As with the tentaari, the first contact with the velin proved peaceful and informative for all parties. An alliance between the velin tribes and the Dawning Star Republic was signed, and most of the ruined areas of the planet were ceded to the velin as their territory. Mining and salvaging rights were reserved for certain areas. Fearing a repeat of the treatment of indigenous peoples on Earth, the Republic has been extremely careful in treating the velin fairly. This treatment was encouraged by the discovery that in addition to looking very similar to humans, the two species share a similar genetic structure. This has led some to theorize that the two are somehow related, possibly a tentaari effort to seed different worlds with human genetic material. The tentaari have not commented on such ideas, but the velin believe the idea completely and see humans as being a lost tribe of velin. While some humans do not trust the velin, blaming them for the murders of 2240, the velins seem to trust humans implicitly. Unfortunately, not all the faction-camps

THE TENTAARI

The tentaari are a very mysterious species. They only have limited contact with humanity. They share little of their history, technology, or culture with humans. While they appear in many ways beneficent, the tentaari often appear scared of humans. Their continuous effort to keep things hidden makes many humans suspicious.

Despite these feelings, the tentaari are allies of the Dawning Star Republic, though they have no permanent diplomatic staff on Eos.

Tentaari are not generally available as a species for player characters. The tentaari know a great deal other races do not, and their progress level familiarity is 9. Permitting a tentaari PC would be too unbalancing without a great deal of work. Industrious GMs with an experienced player might allow an outcast tentaari as a PC.

deal fairly with our new planetary neighbors.

The velin have shown an immense natural capacity for working with the indigenous creatures of Eos, and some have become highly respected murcow ranchers. The velin unfortunately have helped spread rumors about the existence of darklings by claiming to have encountered them many times throughout history. Other than some faded artwork and supposed darkling teeth, however, they have no more concrete proof than anyone else.

CONCLUSION • • •

So our fledgling colony of three million humans now stands at a crucial crossroads: We are surrounded by faction-camps and strange alien neighbors. We need adventurers capable of searching the ruins for lost technologies. We need explorers willing to brave the vacuum of space for science and knowledge. We need leaders to keep our colony together in the dark days ahead. We need scientists to unlock new technologies and ancient secrets.

In short, we need heroes.

TIMELINE • • •

- 2169** Destruction of the *U.S.S. Washington*, the first deep space exploration vessel to reach the outer planets.
- 2184** The dark object is first detected, though initially dismissed by most scientists.
- 2189** The truth of the dark object, that it will strike Earth, is revealed by an international group of scientists.
- 2196** The Earth is destroyed by the dark object, with only a small percentage of the population escaping on evacuation ships.
- 2197** The evacuation fleet encounters the tentaari gateway device at the edge of Earth's solar system. The fleet is sent through the gateway network to random locations throughout the galaxy. Only the *Dawning Star* reaches the Helios system.
- 2198** The *Dawning Star* lands on Eos and begins the process of settling and terraforming the world. Only the crew and necessary personnel are active at this time, the rest of the crew remaining in cryogenic sleep to preserve resources.
- 2199** A human is born on Eos for the first time, Amanda Polk.
- 2200** The colonists begin exploring the ruins scattered across Eos, finding evidence of an advanced society living on the world tens of thousands of years ago.
- 2202** The first of dozens of crashed alien ships are found on Eos, giving the colonists parts and technology to build their own spacecraft.
- 2210** The remains of a tentaari spacecraft are found on Eos, and the humans are able to reverse-engineer portions of its systems, leading to plasma weapons and materials that resist the rust spores.
- 2228** The terraforming process on Eos is mostly complete, and the majority of the *Dawning Star's* passengers in cryogenic sleep are awoken to begin a new life on Eos.
- 2229** The colonists begin raising the indigenous murcow, a large, wooly, bovine creature. Organized cultivation of crops begins.
- 2230** The Dawning Star Republic is formed by the colonists as the new government of Eos. The capital is the new city of Dawning Star, built from the remains of the ship that brought them to Eos. A vocal minority objects to the new government and leaves Dawning Star to found other settlements.
- 2231** A group of explorers unleash a virulent disease from a ruin near Dawning Star. Called the blood blisters by the colonists, this disease kills 10% of the colony's population before a cure is found. Small eruptions of blood blister cases continue to occur on Eos.
- 2232** The first coastal settlement on Eos, Roger's Point, is founded by Patricia Rogers. Roger's Point is run by the Eos Freedom League, one of the factions aligned against the Dawning Star Republic, and quickly becomes a haven for dissidents.
- 2232** The agriculture efforts on Eos produce enough food for the entire population for the first time, eliminating the need to rely on rations from the *Dawning Star*.
- 2235** The Eos Freedom League attacks Republic farmers. The Republic Militia is formed to deal with the threat and annex Red Hill.
- 2238** Huge deposits of iron ore are found in the mountains west of Dawning Star. The second largest settlement on Eos, Iron Scar, is founded.
- 2239** The first game in the Eos Professional Baseball League is played in Dawning Star. The Eos Professional Football League starts up the following year.
- 2240** In response to a number of murders outside Dawning Star, the Eos Defense Force is established.
- 2241** The **Daily Star** and Dawning Star Video Network are founded, providing the first non-government media outlets in the colony.
- 2242** The first industrial facility on Eos is completed and immediately begins producing ground vehicles and construction equipment.
- 2247** A series of violent murders shock Dawning Star, as more than a dozen individuals are killed within a week by an unknown assailant. The killings stop, but "Shadow Jack" is never caught.
- 2248** The tentaari make contact with the colonists on Eos.
- 2249** The velin are first encountered on Eos. A wary friendship develops between humans and the Velin.
- 2251** Current year.



CHAPTER 11

CHARACTERS

Mwituni stepped out of the chilled water of the lake and stretched out his arms. He groaned, letting the aches of a weeklong journey dissipate with the echo. The icy beads glistened on his dark, naked flesh. A breeze rushed by and brought a shiver. Mwituni laughed and reached down to grab his clothes off the rocky shore.

Just then, a rustle issued from the row of bushes not 20 paces beyond. Mwituni dropped his shirt and dove for the stubby firearm beside his pack. He tumbled to one knee and aimed the barrel into the brush. With both hands gripping the gun tightly, his arms were tensed. He squinted.

"*Show yourself!*" he barked in English. His accent had faded over the intervening years. Then, "*iko nini pale?*" The Swahili flowed from his lips without a second thought.

The bushes rustled again, and Mwituni stood up.

"*Show yourself,*" he repeated.

A figure emerged from behind the plants. The silhouette was still darkened by the long shadows cast from the forest trees, but Mwituni could see it was a human.

Or so he thought.

The velin scout stepped forward. He kept the tip of his shortspear pointed down to the rockbed. He cocked his head to the side, eyeing the dark-skinned human before him. He beat his free hand on his chest and said: "*Tampu.*" Then, he repeated his name again. "*Tampu.*"

Mwituni regarded the velin standing before him. A negative image of himself. A reflection, differing only in color, not in shape. The gray skin and long, white ponytail illuminated now in the early morning sun. He had heard of the velin often enough, but he had to admit surprise. He couldn't shake just how much alike he and the stranger were. Mwituni eased his grip on the gun, lowering it a shade. With his right hand, he pointed to his chest and said his name loud enough.

Tampu must have thought it some grand joke, for he burst into laughter, a rolling, choking fit just as a human would upon the telling of a legendary joke.

Mwituni repeated his name, jabbing his chest emphatically.

Tampu's laugh subsided. He lowered his spear to the ground, raised his hands to his mouth, and made a curious sound not unlike a terran woodchuck. "Mee-too-nee," Tampu said, chuckling softly again.

Mwituni himself laughed now, lowering his gun to his side. He repeated his name to the velin, sure to emphasize every syllable.

Tampu nodded and said Mwituni's name correctly.

Mwituni scanned the velin head to toe, noting his soft, leather boots, the throwing knives, the lean, corded figure. He smiled. Tampu, he was certain, was a scout.

Just like him.

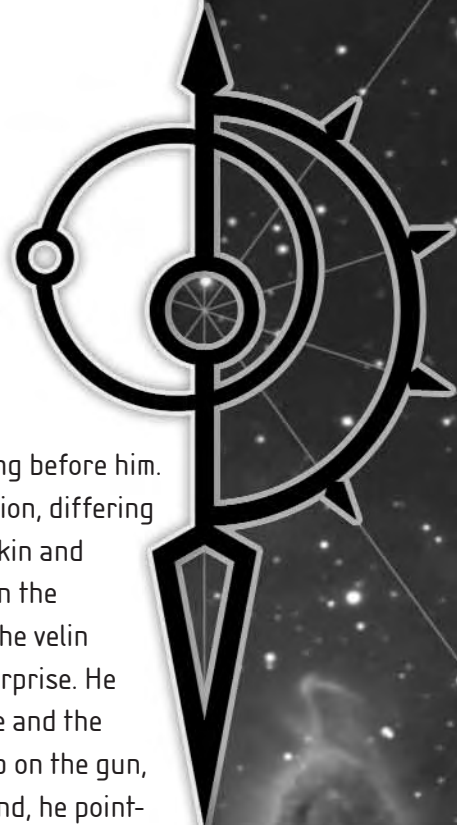

The heroes of DAWNING STAR are rugged individuals, who have already helped carve out a new home for their people and are ready for new challenges. From space explorers to Republic Rangers to ruin explorers, heroes come from a wide variety of backgrounds in DAWNING STAR and have skills covering an equally wide number of areas. But even the most experienced hero has to start somewhere.

The rules for creating and advancing characters in DAWNING STAR are found in D20 MODERN.

The Future SRD includes additional, character-related rules—such as feats and advanced classes. DAWNING STAR uses these same rules. This chapter offers a host of new options for characters, including new feats, talent trees, skills, and advanced and prestige classes. Not all of the feats, advanced classes, and prestige classes in D20 MODERN and the Future SRD are suitable for use in DAWNING STAR. These exceptions are noted in the appropriate sections of this chapter.

SPECIES • • •

While the human colonists of Eos are the primary race in Dawning Star, the other species of the region, except the tentaari, are also available as player characters. While only the velin are detailed below, eight other races will be available in DAWNING STAR: HELIOS RISING. Additionally, at the GM's discretion, any other species of your devising could be suitable with an appropriate back-story.

Species other than humans begin with one fewer feat, four fewer skill points at 1st level, and earn one fewer skill point each additional level.

♦ HUMANS

The humans of Dawning Star are a mixture of several different cultures, ethnicities and nations, all nestled together in a very small area. Most humans of Dawning Star are of North American, European, African, or Indian heritage, leading to a wide variety of skin tones, hair colors, and facial features. With humankind teetering on the brink of extinction and a ready selection of bizarre aliens to be suspicious of, most feelings of racism have faded with time. Children now born in the colonies are often of mixed ethnic heritage. Many ethnologists theorize that, in due time, humanity will consist primarily of a single, indistinguishable racial profile. Despite this shift, many of the different ethnicities work hard to preserve their cultures, and there are many ethnocentric neighborhoods in Dawning Star.

Much like on Earth, the humans of Eos run the gamut as individuals from hard-working laborers to lying con men; scheming politicians to honest law enforcement officers. Those selected for the evacuation effort were mostly individuals with skills that could assist the colony, plus a small number of randomly selected citizens chosen by lottery. Due to the emphasis on taking individuals who would be a boon to the colony, most colonists have a strong work ethic, and there are few criminals among the population of Eos. The faction-camps have become the main homes of dissension and lawlessness on Eos and are populated by those too independent,

too greedy, or too power-hungry to live in Dawning Star itself. They have become something of a relief valve for Dawning Star, a place where troublemakers are allowed to go instead of causing havoc. This is one of the chief reasons they have been allowed to exist despite their opposition to the Dawning Star Republic and the Republic's military superiority.

Despite encountering a number of alien environments, humans have reacted surprisingly well to space travel and the oddities therein. Showing great flexibility, humans are able to survive on all the inhabited alien worlds they have discovered thus far with minimal discomfort. Humans could have lived on Eos before the terraforming process, but it would have been an uncomfortable existence that ultimately would have decreased life expectancy and increased the rate of cancer and other maladies. Life on Eos has not been easy, even in the city of Dawning Star, and many labor saving devices once common on Earth are completely unknown now. It is not uncommon to see people sweeping out their homes instead of vacuuming even in the steel towers of Dawning Star. Because of the level of physical activity, the human population has grown more fit than it had been on Earth.

Many of the older humans still carry memories of Earth in their hearts and are prone to fits of depression, though this problem has abated with time. During the earliest days of the colony, a large-scale counseling program was instituted within Dawning Star in an attempt to combat this problem. Most of the original crew of the Dawning Star are now retired or passed on, and most of the colonists who came through in cryogenic sleep are reaching retirement age as well. The first full generation of mankind born on Eos is coming of age currently, providing new energy and hope for the human colony. These first-generation colonists have no memories of Earth hanging over their heads and have never known a world without space travel. The second generation of colonists from Eos will grow up with aliens being a part of their everyday lives. Within two generations, there can be no doubt, the entire human race will be irrevocably changed.

HUMAN FEMALE



THE VELIN ARE A NOBLE LIFE FORM OF THE PLANET SOG THAT BEAR AN OBTUSE RESEMBLANCE TO HUMANS. VELIN ARE GENERALLY TALLER AND BROADER THAN HUMANS, BUT SHARE THE SAME BASIC SHAPE AND PROPORTIONS. THEIR FEATURES ARE WIDER, ESPECIALLY THEIR NOSES AND MOUTH. THE PRINCIPAL DIFFERENCE BETWEEN THE TWO RACES IS THE GREAT LEATHER SKIN OF THE VELIN, WITH A TEXTURE SIMILAR TO GOAT LEATHER. THE VELIN ARE WELL REPAIRED FOR A LIFE EXPOSED TO THE ELEMENTS. MOST HUMANS FIND THE TOUCH OF VELIN SKIN LIKE THAT OF SANDPAPER.



HUMAN MALE

BUT SOME VELIN WHO DEAL WITH HUMANS HAVE LEARNED TO SOFTEN THEIR SKIN BY USING SOAPS AND MOISTURIZERS. THE VELIN HAVE HAIR SIMILAR TO HUMANS, BUT MOST ONLY HAVE IT ON THE TOP OF THEIR HEADS. A FEW OF THE OLDER VELIN SPORT BEARDS, BUT IT SEEMS FACIAL HAIR DOES NOT DEVELOP UNDER EXTREME OLD AGE. VELIN HAIR IS THICK AND COARSE AND OFTEN SHAPED INTO LONG BRAIDS BY THE VELIN. ALL VELIN WEAR THEIR HAIR LONG DUE TO LONG-ESTABLISHED BELIEFS THAT HAIR IS A SIGN OF WISDOM AND THE MORE THE BETTER. MANY VELIN DO WEAR SHIRT LIVES WITHOUT CUTTING THEIR HAIR, WHICH IS POSSIBLE

Species Traits:

Humans share the following species traits.

Type: Humanoid

Size: Medium. Humans have no special bonuses or penalties due to their size.

Ability Modifiers: None.

Speed: 30 ft.

Bonus Feat: Humans get one bonus feat at character creation.

Skill Bonus: Humans get four additional skill points at character creation and one additional skill point each level thereafter. Additionally, at character creation, a human character gets either one more additional skill point or one additional bonus language (see below); this skill point, if selected, may only be spent on a Craft or Profession skill.

Free Language Skills: Read/Write English, Speak English. Humans, who elect to take an additional bonus language may choose any teran language appropriate to their background, e.g., Russian, Chinese, Farsi, etc.

PL Familiarity: 6.

Level Adjustment: +0.

PROGRESS LEVELS

As introduced in the Future SRD, Progress Level (PL) measures the level of technology available, ranging from PL 0 (the Stone Age) to PL 9 and beyond. The default Progress Level of DAWNING STAR is 7, but there are wide variances within the setting. The technology level of some species, such as the tentaari, exceed this level, while the velin are far below it.

Each character begins with a PL familiarity level based on their species. Humans have a base PL familiarity of 6.

◇ VELIN

The velin are a native life form of the planet Eos that bear an eerie resemblance to humans. Velin are generally taller and broader than humans, but share the same basic shape and proportions. Their features are wider, especially their noses and mouths. The principal difference between the two races is the gray, leathery skin of the velin. With a texture similar to rough leather, the velin are well prepared for a life exposed to the elements. Most humans find the touch of velin skin like that of sandpaper, but some velin who deal with humans have learned to soften their skin by using soaps and moisturizers. The velin have hair similar to humans, but most only have it on the tops of their heads. A few of the oldest velin sport beards, but it seems facial hair does not develop until extreme old age. Velin hair is thick and coarse and often shaped into long braids by the velin. All velin wear their hair long due to longstanding beliefs that hair is a sign of wisdom and the more the better. Many velin go their entire lives without cutting their hair, which is possible because it grows at a fraction of the speed of human hair.

The velin live in a tribal culture made of large family groups that are all interrelated due to the practice of choosing mates from other tribes. Velin mate for life and reproduce in a similar fashion to humans, except that velin have a ten-month gestation period and, in general, age slower. Among the velin, twins are very common, while triplets are less common but still occur more often than in human births. Velin value family bonds strongly, but for the most part consider all velin to be family. Crime among the velin is not unheard of, but it is rare, usually the product of mental derangement. The velin have a tradition of harsh punishments to keep those who break both laws and cultural taboos in line. This results in a very disciplined society, but unfortunately these punishments often force those who would push boundaries away from their tribe. To many, while the velin seem very loving, disciplined, and loyal among themselves, they are also stagnant. Their culture seems frozen in stone and unlikely to change, for those who attempt change are often banished for their efforts.

The velin see no difference between genders and also have difficulty with the idea that humans are not simply a different tribe of velin. They believe that humans originated on Eos as they did and are simply returning home after living on Earth for a time. All attempts to dissuade them of this idea have thus far failed. These feelings of kinship among the velin lead them to treat humans as close allies, even though many humans do not share such feelings. Some blame the velin for the murders of 2240 and the Shadow Jack killings, which the velin consider a gross insult. Since first meeting humanity, the velin have learned that not all

VELIN MALE

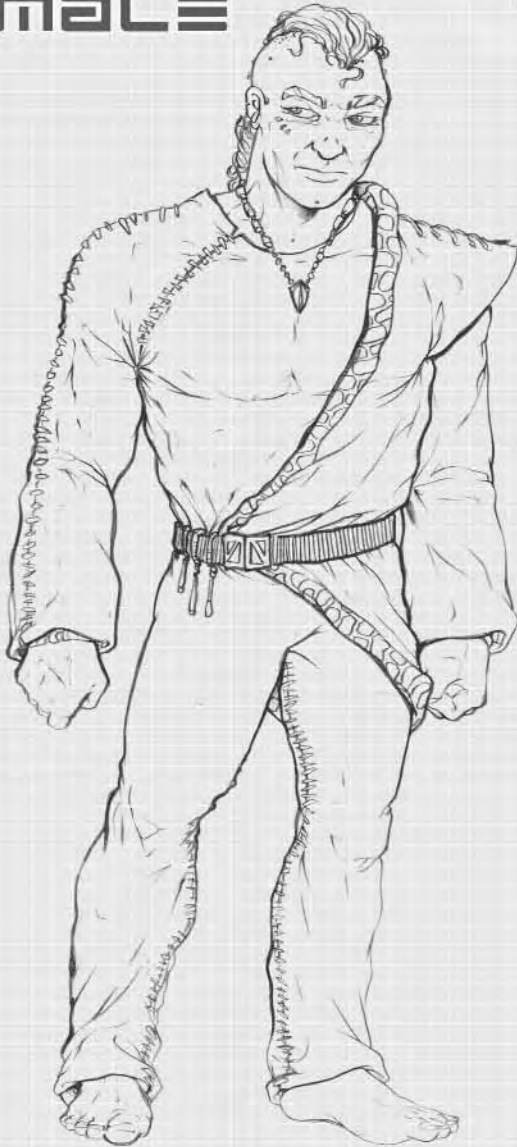

But some Velin who deal with harsh planets have learned to soften their skin by using soaps and moisturizers. The Velin have hair similar to humans, but most only have it on the tops of their heads. A few of the oldest Velin sport beards and a few have facial hair. Velin hair does not develop until age 15. Velin hair is thick and coarse and often shaped into long braids by the Velin. All Velin wear their hair long due to long-standing beliefs that hair is a sign of wisdom and the more the better. Many Velin go their entire lives without cutting their hair, which is possible.

The Velin are a native life form of the planet, so they bear an eerie resemblance to humans. Velin are generally taller and broader than humans, but share the same basic shape and proportions. Their features are wider, especially their noses and mouths. The principal difference between the two races is the gray, leathery skin of the Velin, which has a texture similar to rough leather. The Velin are well adapted for a life exposed to the elements. Most humans find the touch of Velin skin like that of sandpaper.



VELIN FEMALE

AGE CATEGORIES BY SPECIES

Species	Child	Young Adult	Adult	Middle Age	Old	Venerable
Human	11	15	40	70	90	130
Velin	12	16	44	80	120	150

humans are to be trusted and many are now wary of the faction-camps, some of whom have dealt with the velin very harshly.

The technology of the velin tribes is of a Bronze Age level, and they obtain most of their metal materials from the many Eotian ruins. Velin are commonly found in the ruins, and most tribes make their homes in these ancient cities. By using scraps of metals and other materials dug up in the ruins, they are able to create spears with steel heads and daggers that will cut through most forms of armor. They are experts at picking out the best materials for weapons, armor, and crafts, and they are able to form these materials into useable items even if they cannot mine and process the materials themselves. Velin outfitted for war carry entire suits of armor made of castoff steel and straps made of synthetic materials, all scavenged from the old cities of Eos. Often these primitive weapons are underestimated by humans, but the velin are very skilled at making do with what they have.

Velin are not comfortable with most forms of technology and shy away from computers, high-tech weapons, and spacecraft. Some have managed to overcome this aversion, but it is rare to see a velin who readily carries anything more than his tribal implements. Despite this lack of technical inclination, the velin have begun integrating with the human population of Eos, serving as ranchers, farmers, and guides. Due to their detailed knowledge of the ruins, some tribes have begun trading salvaged materials with merchants in exchange for food, clothes and other needed goods. The velin do not react well to being tricked or cheated, usually attacking the perpetrator and dragging them to the nearest Republic Ranger. The Dawning Star Republic has done its best to be attentive to the needs of the velin people, not wanting a repeat of the tragic injustices suffered by many indigenous peoples on Earth.

While humans can only consume a small number of the indigenous plants and animals of Eos, velin are able to eat a wide variety of the planet's flora and fauna. Although humans had domesticated

Dawson dragons before meeting the velin, the latter were able to take that process to a new level. Dawson dragons trained by the velin are highly sought after mounts by most ranchers due to the intelligence, endurance, and discipline such mounts possess. While only a number of horses have been introduced to Eos from the creature tanks, the velin have taken to them as well and have quickly mastered horsemanship. The velin also make use of a small, dog-like creature called spetsin to guard their camps. The spetsin is a small, leather-skinned quadruped with a strong jaw and sharp teeth that has already earned a reputation among humans as a creature whose bite is as bad as its bark.

The velin speak a language that makes use of many grunts and clicking sounds, leading some linguists to assert similarities between it and terran languages of Africa and Australia. Most velin who deal with humans also speak English, which they can pick up very quickly and have no trouble pronouncing. Velin as a people are very interested in language, partly due to the fact that their history is contained in an oral tradition.

Velin names are created by taking sounds from their language and modifying them based on a complex system of prefixes and suffixes involving ancestry, tribal allegiance, and past deeds. Each name retains its original meaning in addition to all the modifications.

So the velin name "Kastiv," based on the velin word for strength, "ast," and modified by a "k" to represent a warrior lineage and "iv" to represent the Ivistos Tribe, means: "A strong warrior of the Ivistos Tribe." Velin take their names very seriously and do not understand why human names do not share the deep meaning of velin names. Indeed, it is a great source of humor, for example, when a velin meets a man named Fletcher, who has no idea of how to craft an arrow.

While most humans dismiss the darklings as little more than paranoia, drunken stupors, or just Eos's version of the Loch Ness Monster, the velin believe completely in the darklings. Calling them the vaasi, the velin claim they are a race of ancient evil that fought in a war against the velin many



years ago. It was this war, the legends continue, that laid waste to the great cities of Eos. While most researchers suspect there are some nuggets of truth in that story, they expect on the whole it is merely a mythological tale passed down through the ages. Regardless, the velin still post guards every night to keep an eye out for the vaasi, fearing they will come in the night and exterminate them.

Species Traits:

Velin share the following species traits.

Type: Humanoid

Size: Medium. Velin have no special bonuses or penalties due to their size.

Ability Modifiers: +2 Constitution, +2 Wisdom, -2 Intelligence, -2 Charisma: Velin are hardy and possess strong wills, but their mental faculties are otherwise underdeveloped.

Speed: 30 ft.

Low-Light Vision (Ex): Velin have low-light vision. A velin can see twice as far as a human in starlight, moonlight, the light of a glow-stick, and similar conditions of shadowy illumination. He retains the ability to distinguish color and detail under these conditions.

Detect Vaasi (Ex): A velin may inspect his surroundings to determine if a vaasi or any member of their servitor races is present within 30 feet. This requires a Wisdom check (DC 15). The DC is reduced by -1 for each vaasi above one within the area. If successful, the velin knows the location and number of the Vaasi in range. This ability relies not just on sight but smell and other extraordinary senses that humans do not yet understand. This ability is usable a number of times per day equal to the velin's Wisdom bonus, but not less than once per day. Using this ability requires a full-round action that provokes an attack of opportunity.

Skill Bonus: Velin enjoy a +2 species bonus to Survival checks while on Eos.

Skill Aptitude: Craft (Tribal) is always considered a class skill for velin.

Bonus Feats: Velin receive Improved Massive Damage Threshold and Archaic Weapon Proficiency as bonus feats.

Vaasi Hatred: Velin hate the vaasi with a primal and instinctual anger. They can never have the vaasi allegiance.

Limited Occupations: Velin may only select from the following occupations: Adventurer, Explorer, Hunter, Nomad, Ranch-Hand, Rural, and Tribal Leader.

Free Language Skills: Speak Velin, Speak English.

PL Familiarity: 3.

Level Adjustment: +0.

PSIONICS

Psionics are not currently found in humans in any measurable quantity or power. Before the exodus, a few studies of latent psionic talents had made some headway; however, humans were a long way from developing what could be called true psionics. The evacuation ship *Eternal Hope* included several researchers from the most significant of these studies, The European Psionic Institute. The *Eternal Hope* was lost with the rest of the fleet through the tentaari gateway network.

The colonists of Eos have no psionic talents to speak of. Some velin spiritual leaders have exhibited a few basic abilities. The tentaari have mastered several psionic disciplines but only use them rarely. The tentaari have said that humans have the capacity to learn psionic abilities, but have made little effort to help with this process.

For now, psionics on Eos are only the province of the tentaari, the vaasi, and a few velin. More details for psionics will be included in *DAWNING STAR: HELIOS RISING* and *DAWNING STAR: HEROES OF HELIOS*.

HEIGHT AND WEIGHT

Species and Gender	Base Height	Height Modifier	Base Weight	Weight Modifier
Human				
Male	5 ft. 0 in.	+2d10 in.	120 lb.	x1d4 lb.
Female	4 ft. 7 in.	+2d10 in.	85 lb.	x1d4 lb.
Velin				
Male	6 ft. 0 in.	+1d10 in.	150 lb.	x1d4 lb.
Female	6 ft. 0 in.	+1d10 in.	150 lb.	x1d4 lb.

TALENT TREES • • •

The talent trees presented in this section are available to the appropriate basic classes. Most of these talents deal with the strange environments encountered in planetary exploration, combating hostile xenomorphs found on an alien world, or organizing groups to become efficient communities. All of the talent trees from **D20 MODERN** are also permitted in **DAWNING STAR**.

PLUS FEATS

The Future SRD added the new “plus” feats, which allow the player taking them to gain two talents from a selected list. The following talents, from this book, are available to the various Plus feats described in the Future SRD:

Dedicated Plus: Defense Training, Improved Defense Training, Survival Save, Improved Sworn Enemy, Advanced Sworn Enemy, Revive, Improved Revive, Treat Disease.

Charismatic Plus: Rally, Improved Rally, Advanced Rally, Universal Communication, Improved Universal Communication, Cultural Grasp, Bargain Mastery, Improved Bargain Mastery.

Fast Plus: Improved Zero-G Maneuvering, Wall Run, Improved Footwork, Advanced Footwork, Improved Sharpshooter, Advanced Sharpshooter.

Tough Plus: Improved Tough Rage, Advanced Tough Rage, Improved Radiation Resistance, Advanced Radiation Resistance, Stun Resistance, Stun Reduction, Stun Breaker.

Smart Plus: Utilize Alien Technology, Repair Alien Technology, Perceptive, Notice, Safe passage, Alert Passage, World Knowledge, Improved World Knowledge, Region Knowledge.

Strong Plus: Improved Gravity Resistance, Strong Natural Weaponry, Improved Strong Rage, Advanced Strong Rage, Improved Throwing Arm, Advanced Throwing Arm.

STRONG HERO TALENT TREES • • •

◇ HEAVY GRAVITY RESISTANCE

The Strong hero can improve his effectiveness on high-gravity worlds through strenuous exercise performed in a high-gravity environment, building up his tolerance by way of this talent tree.

GRAVITY RESISTANCE

While in a high-gravity environment, the Strong hero can carry $\frac{3}{4}$ of his normal carrying capacity, and the penalty to Strength checks to lift or move heavy objects and to Strength-based skill checks is reduced to -5.

Prerequisite: Extreme Effort.

IMPROVED GRAVITY RESISTANCE

While in a high-gravity environment, the Strong hero's penalty to Strength checks to lift or move heavy objects and to Strength-based skill checks is reduced to -2, and the penalty on attack rolls is reduced to -1.

Prerequisite: Gravity Resistance.

◇ STRONG RAGE

The Strong hero is able to channel his anger into destructive energies through this talent tree, making him stronger for a short time.

Strong Rage

A Strong hero with this talent can fly into a rage a certain number of times per day. In a rage, the Strong hero temporarily gains a +4 bonus to Strength, a +2 bonus to Constitution, and a +2 morale bonus on Will saves, but he takes a -2 penalty to Armor Class. The increase in Constitution increases the Strong hero's hit points by 1 point per level, but these hit points go away at the end of the rage when his Constitution score drops back to normal. (These extra hit points are not lost first the way temporary hit points are.)

Entering the rage takes no action but may only be done during the Strong hero's turn. While raging, a Strong hero cannot use any Charisma-, Dexterity-, or Intelligence-based skills (except for Balance, Escape Artist, Intimidate, and Ride), the Concentration skill, or any abilities that require patience or concentration. He can use any feat he has except Combat Expertise and similar feats that require concentration. A fit of rage lasts for a number of rounds equal to 3 + the Strong hero's (newly improved) Constitution modifier. A Strong hero may prematurely end his rage. At the end of the rage, the Strong hero loses the rage modifiers and restrictions and becomes fatigued (-2 penalty to Strength, -2 penalty to Dexterity, can't charge or run) for the duration of the cur-

rent encounter. The Strong hero can only use Strong Rage once a day.

If a hero has both Strong Rage and Tough Rage he may use them simultaneously, but their benefits do not stack. Instead he takes the best Strength and Constitution bonuses of both talents. Afterwards, the hero is fatigued as normal. If the hero has any of the Improved Rage or Advanced Rage talents they follow the same limitations when used simultaneously.

Prerequisite: Extreme Effort, Ignore Hardness, or Melee Smash.

Improved Strong Rage

When raging, the Strong hero gains an additional +2 bonus to Strength and Constitution, increasing the total bonuses to a +6 and +4 respectively. This means the Strong hero gains 2 hit points per level when raging. The Strong hero may also rage twice a day.

Prerequisite: Strong Rage.

Advanced Strong Rage

The Strong hero may use Strong Rage three times a day.

Prerequisite: Improved Strong Rage.

◆ THROWING ARM

Using the Strong hero's raw strength he can hurl objects farther than most using this talent tree.

THROWING ARM

The range increment of all weapons thrown by the Strong hero increases by 10 feet, and he receives a +1 bonus to damage with thrown weapons.



IMPROVED THROWING ARM

The range increment of all weapons thrown by the Strong hero increases by an additional 10 feet (20 feet total), and he receives an additional +1 bonus to damage (+2 total) with thrown weapons.

Prerequisite: Throwing Arm

ADVANCED THROWING ARM

The range increment of all weapons thrown by the Strong hero increases by an additional 10 feet (30 feet total), and he receives an additional +1 bonus to damage (+3 total) with thrown weapons.

Prerequisite: Improved Throwing Arm

FAST HERO TALENT TREES • • •

◆ FOOTWORK

Using fancy footwork and agility, the Fast hero can avoid certain attacks with this talent tree.

FOOTWORK

The Fast hero may use her Dexterity bonus instead of her Strength bonus to avoid bull rush attacks and when making grapple checks. The Fast hero cannot use this talent when flat-footed or when she would otherwise lose her Dexterity bonus to her Defense.

IMPROVED FOOTWORK

The Fast hero receives a +1 bonus to grapple checks and to ability checks to avoid being disarmed, tripped, or bull rushed. The Fast hero loses this bonus when flat-footed or when she would otherwise lose her Dexterity bonus to her Defense.

Prerequisite: Footwork.

ADVANCED FOOTWORK

The Fast hero receives an additional +1 bonus to grapple checks and to ability checks to avoid being disarmed, tripped or bull rushed (+2 total). The Fast hero loses this bonus when flat-footed or when she would otherwise lose her Dexterity bonus to her Defense.

Prerequisite: Improved Footwork.

◆ SHARPSHOOTER

The Fast hero has a keen eye and steady hand that allow her to do extra damage with ranged weapons with this talent tree.

SHARPSHOOTER

The Fast hero receives a +1 bonus to damage on ranged attacks.

IMPROVED SHARPSHOOTER

The Fast hero receives an additional +1 bonus to damage on ranged attacks (+2 total).

Prerequisite: Sharpshooter.



ADVANCED SHARPSHOOTER

The Fast hero receives an additional +1 bonus to damage on ranged attacks (+3 total).

Prerequisite: Improved Sharpshooter.

TOUGH HERO TALENT TREES • • •

◇ TOUGH RAGE

The Tough hero is able to channel his anger into destructive energies through this talent tree.

TOUGH RAGE

A Tough hero with this talent can fly into a rage a certain number of times per day. In a rage, the Tough hero temporarily gains a +2 bonus to Strength, a +4 bonus to Constitution, and a +2 morale bonus on Will saves, but he takes a -2 penalty to Armor Class. The increase in Constitution increases the Tough hero's hit points by 2 points per level, but these hit points go away at the end of the rage when his Constitution score drops back to normal. (These extra hit points are not lost first the way temporary hit points are.) Entering the rage takes no action but may only be done during the Tough hero's turn. While raging, a Tough hero cannot use any Charisma-, Dexterity-, or Intelligence-based skills (except for Balance, Escape Artist,

Intimidate, and Ride), the Concentration skill, or any abilities that require patience or concentration. He can use any feat he has except Combat Expertise. A fit of rage lasts for a number of rounds equal to 3 + the Tough hero's (newly improved) Constitution modifier. A Tough hero may prematurely end his rage. At the end of the rage, the Tough hero loses the rage modifiers and restrictions and becomes fatigued (-2 penalty to Strength, -2 penalty to Dexterity, can't charge or run) for the duration of the current encounter. The Tough hero can only rage once a day.

If a hero has both Strong Rage and Tough Rage, he may use them simultaneously, but their benefits do not stack. Instead, he takes the best Strength and Constitution bonuses of both talents. Afterwards, the hero is fatigued as normal. If the hero has any of the Improved Rage or Advanced Rage talents they follow the same limitations when used simultaneously.

Prerequisite: Damage Reduction, Remain Conscious, or Robust.

IMPROVED TOUGH RAGE

When raging, the Tough hero gains an additional +2 bonus to Strength and Constitution, increasing the total bonuses to a +4 bonus to Strength and +6 bonus to Constitution. This means the Strong hero gains 3 hit points per level when raging. The Tough hero may also rage twice a day.

Prerequisite: Tough Rage.

ADVANCED TOUGH RAGE

The Tough hero may rage three times a day.

Prerequisite: Improved Tough Rage

◇ RADIATION RESISTANCE

The Tough hero is highly resistant to radiation thanks to this talent tree.

RADIATION RESISTANCE

When the Tough hero takes Constitution damage from radiation sickness, the damage is reduced by 1, and the Tough hero receives a +1 bonus to Fortitude saves against radiation.

IMPROVED RADIATION RESISTANCE

When the Tough hero takes Constitution damage from radiation sickness, the damage is reduced by an additional 1 point (2 total), and the Tough hero receives an additional +1 bonus (+2 total) to Fortitude saves against radiation.

Prerequisite: Radiation Resistance

ADVANCED RADIATION RESISTANCE

When the Tough hero takes Constitution damage from radiation sickness, the damage is reduced by an additional 1 point (3 total), and

rent encounter. The Strong hero can only use Strong Rage once a day.

If a hero has both Strong Rage and Tough Rage he may use them simultaneously, but their benefits do not stack. Instead he takes the best Strength and Constitution bonuses of both talents. Afterwards, the hero is fatigued as normal. If the hero has any of the Improved Rage or Advanced Rage talents they follow the same limitations when used simultaneously.

Prerequisite: Extreme Effort, Ignore Hardness, or Melee Smash.

Improved Strong Rage

When raging, the Strong hero gains an additional +2 bonus to Strength and Constitution, increasing the total bonuses to a +6 and +4 respectively. This means the Strong hero gains 2 hit points per level when raging. The Strong hero may also rage twice a day.

Prerequisite: Strong Rage.

Advanced Strong Rage

The Strong hero may use Strong Rage three times a day.

Prerequisite: Improved Strong Rage.

◆ THROWING ARM

Using the Strong hero's raw strength he can hurl objects farther than most using this talent tree.

THROWING ARM

The range increment of all weapons thrown by the Strong hero increases by 10 feet, and he receives a +1 bonus to damage with thrown weapons.



IMPROVED THROWING ARM

The range increment of all weapons thrown by the Strong hero increases by an additional 10 feet (20 feet total), and he receives an additional +1 bonus to damage (+2 total) with thrown weapons.

Prerequisite: Throwing Arm

ADVANCED THROWING ARM

The range increment of all weapons thrown by the Strong hero increases by an additional 10 feet (30 feet total), and he receives an additional +1 bonus to damage (+3 total) with thrown weapons.

Prerequisite: Improved Throwing Arm

FAST HERO TALENT TREES • • •

◆ FOOTWORK

Using fancy footwork and agility, the Fast hero can avoid certain attacks with this talent tree.

FOOTWORK

The Fast hero may use her Dexterity bonus instead of her Strength bonus to avoid bull rush attacks and when making grapple checks. The Fast hero cannot use this talent when flat-footed or when she would otherwise lose her Dexterity bonus to her Defense.

IMPROVED FOOTWORK

The Fast hero receives a +1 bonus to grapple checks and to ability checks to avoid being disarmed, tripped, or bull rushed. The Fast hero loses this bonus when flat-footed or when she would otherwise lose her Dexterity bonus to her Defense.

Prerequisite: Footwork.

ADVANCED FOOTWORK

The Fast hero receives an additional +1 bonus to grapple checks and to ability checks to avoid being disarmed, tripped or bull rushed (+2 total). The Fast hero loses this bonus when flat-footed or when she would otherwise lose her Dexterity bonus to her Defense.

Prerequisite: Improved Footwork.

◆ SHARPSHOOTER

The Fast hero has a keen eye and steady hand that allow her to do extra damage with ranged weapons with this talent tree.

SHARPSHOOTER

The Fast hero receives a +1 bonus to damage on ranged attacks.

IMPROVED SHARPSHOOTER

The Fast hero receives an additional +1 bonus to damage on ranged attacks (+2 total).

Prerequisite: Sharpshooter.

A Smart hero may not take 10 or take 20 on this check; this sort of knowledge is essentially random. The DC of the check depends on the type of knowledge sought, as indicated on the table below.

Type of Knowledge	DC
Common, known by at least a substantial minority; common legends of the local population. What the major faction-camps on Eos are.	10
Uncommon but available, known by only a few people. The leaders of a specific faction-camp.	20
Obscure, known by few, hard to come by. The name of a faction-camp leader's son.	25
Extremely obscure, known by very few, possibly forgotten by most who once knew it, possibly known only by those who don't understand the significance of the knowledge. Where Eos Freedom League agents hang out in Red Hill.	30

SECTOR KNOWLEDGE

The Smart hero can make a world knowledge check concerning knowledge of a number of different worlds equal to his Intelligence bonus. These worlds must be selected when this talent is taken.

Prerequisite: World Knowledge.

IMPROVED WORLD KNOWLEDGE

The Smart hero receives a +5 bonus when making world knowledge checks.

Prerequisite: World Knowledge.

IMPROVED SECTOR KNOWLEDGE

The Smart hero can make a world knowledge check concerning knowledge of a number of different worlds equal to twice his Intelligence bonus. These worlds must be selected when this feat is taken.

Prerequisite: Sector Knowledge

◇ XENO-TECH

This tree helps a Smart hero puzzle out the purpose, use, and creators of alien artifacts.

IDENTIFY ALIEN TECHNOLOGY

By spending a move action and observing a piece of alien technology in use, the Smart hero may make an Intelligence check (DC 10+ the

device's progress level) to determine the abilities of the device. This Intelligence check enjoys a bonus equal to the Smart hero's Smart levels. If successful, the Smart hero knows the observed abilities of the item, such as damage and range increment for weapons or speed for vehicles.

UTILIZE ALIEN TECHNOLOGY

By spending an action point and ten minutes investigating a piece of alien technology, the Smart hero can attempt to figure out how to operate the basic functions of the alien device. This requires an Intelligence check against the DC listed on the table below, and a separate check is required for each device. The Smart hero receives a bonus to this check equal to his Smart hero level. If successful, the Smart hero can use the basic functions of the device—such as driving a vehicle or firing a weapon—without the normal penalties associated with using a device of a higher progress level than the Smart hero is familiar with. The Smart hero still suffers from any other penalties due to not having the proper feats to use the item, such as a lack of proficiency with a particular weapon class. The Smart hero must know what the device does before using this Talent and can gather this information from a Knowledge (Technology) skill check or another source, such as an instruction manual or technical schematic.

Type of Object	DC
Device of same or lower progress level as Smart hero's culture	10
Device 1 progress level above the Smart hero's culture	15
Device 2 progress levels above the Smart hero's culture	20
Device 3+ progress levels above the Smart hero's culture	25
Device has an unusual interface, such as mental controls	+5
Device is particularly complex	+5
Device is Large size	+2
Device is Huge size	+4
Device is Gargantuan size	+6
Device is Colossal size	+8

Prerequisite: Identify Alien Technology

REPAIR ALIEN TECHNOLOGY

By spending an action point and ten minutes examining the damage to an alien device, the Smart hero can attempt to repair technology he barely understands. This requires an Intelligence check against the same DC as

using the Utilize Alien Technology talent. A separate check is required for each device. The Smart hero receives a bonus to this check equal to his Smart hero level. If successful the Smart hero can use Computers, Craft, and Repair skills without any penalty due to the device being of a higher progress level than the Smart hero is familiar with. This effect lasts for 24 hours or a single repair attempt, whichever is shorter. As with any repair attempt, the GM may determine that some devices are irreparably damaged.

Prerequisite: Utilize Alien Technology

DEDICATED HERO TALENT TREES • • •

◇ SURVIVAL

The Dedicated hero's determination allows her to survive in alien environments and encounter alien creatures with little difficulty thanks to this talent tree.

SURVIVAL TRAINING

The Dedicated hero receives a bonus to her Survival skill equal to her Dedicated level.



DEFENSE TRAINING

After 1 round of combat the Dedicated hero can designate one opponent to keep an eye on and stay alert of their actions. The Dedicated hero uses a move action and makes a Wisdom check (DC 15), with a bonus equal to her Dedicated level. If the check succeeds, for the rest of the combat, the Dedicated hero adds her Wisdom bonus instead of her Dexterity bonus to her Defense against that one opponent. The Dedicated hero may use this talent against other opponents in the same combat, but it is only effective against the last opponent against whom it is used.

Prerequisite: Survival Training, any talent from the Insightful talent tree.

IMPROVED DEFENSE TRAINING

This talent acts like Defense Training, but the Dedicated hero uses her Wisdom bonus against all attacks in a single combat instead of against a single opponent.

Prerequisite: Defense Training

SURVIVAL SAVE

By spending an action point the Dedicated hero gains a bonus to Fortitude saves equal to her Dedicated level to resist natural, environmental threats, such as severe weather or the effects of starvation and dehydration.

Prerequisite: Survival Training

◇ SWORN ENEMY

The Dedicated hero has spent her life fighting a specific group or type of creature and has developed special insights because of this experience as represented by this talent tree.

SWORN ENEMY

The Dedicated hero may select a type of creature from among those listed below. If the Dedicated hero chooses humanoid as a sworn enemy, she must also choose an associated subtype, as indicated on the table. Alternatively, the Dedicated hero may choose creatures that have specific features or templates, such as cyborgs or mutants, as her sworn enemy. Such choices must be approved by the GM. Other choices may be approved by the GM.

A Dedicated hero may not select her own species as her sworn enemy, but she may select a certain group or organization that includes members of her own species. For example, a human Dedicated hero may select the Eos Freedom League or the Republic Rangers as her sworn enemy.

Against her sworn enemy, the Dedicated hero gains a +2 bonus on Bluff, Listen, Sense Motive, Spot, and Survival checks. Likewise, she gets a +2 bonus on weapon damage rolls

against them.

This talent may be selected more than once. Its effects do not stack. Each time it is selected, a new sworn enemy is chosen.

Sworn Enemy Options

Aberration

Animal

Cyborg

Humanoid (*Humans*)

Humanoid (*Tentaari*)

Humanoid (*Velin*)

Mutants

Plant

Robot

Ooze

Vermin

IMPROVED SWORN ENEMY

The bonuses the Dedicated hero receives from the Sworn Enemy talent increase to +4. This only applies to one type of creature if the Sworn Enemy talent has been taken multiple times.

Prerequisite: Sworn Enemy.



ADVANCED SWORN ENEMY

The bonuses the Dedicated hero receives from the Sworn Enemy talent increase to +6. This only applies to one type of creature if the Sworn Enemy talent has been taken multiple times.

Prerequisite: Improved Sworn Enemy.

◇ TREATMENT

The Dedicated hero is skilled in advanced medical treatment through this talent tree.

REVIVE

The Dedicated hero receives a bonus to Treat Injury checks equal to her Dedicated level when reviving dazed, stunned, or unconscious characters.

Prerequisite: Healing Knack.

IMPROVED REVIVE

The Dedicated hero may revive dazed, stunned or unconscious characters as a move action instead of an attack action.

Prerequisite: Revive.

TREAT DISEASE

When treating the effects of disease (including radiation sickness) or poison, the Dedicated hero receives a bonus to her Treat Injury skill equal to her Dedicated level.

Prerequisite: Revive.

CHARISMATIC HERO TALENT TREE • • •

◇ ANIMAL HUSBANDRY

The Charismatic hero has a special gift for dealing with animals thanks to this talent tree.

ANIMAL TOUCH

The Charismatic hero receives a bonus equal to half his Charismatic level to Ride and Handle Animal skills.

WILD EMPATHY

The Charismatic hero can improve the attitude of an animal. This ability functions just like a Diplomacy check to improve the attitude of a person. The Charismatic hero rolls 1d20 and adds his Charismatic level and his Charisma bonus to determine the wild empathy check result. The typical domestic animal has a starting attitude of indifferent, while wild animals are usually unfriendly. To use wild empathy, the Charismatic hero and the animal must be able to study each other, which means that they must be within 30 feet of one another under normal visibility conditions. Generally, influencing an animal in this way takes 1 minute, but, as with influencing people, it might take more or less time.

Prerequisite: Animal Touch.

IMPROVED WILD EMPATHY

The Charismatic hero adds double his Charismatic level to his Wild Empathy check.

Prerequisite: Wild Empathy.

◇ COMMAND

With this talent tree, the Charismatic hero is trained to keep people organized, even in combat.

COMMAND

When commanding soldiers or other members of an organized group that are under your leadership, you gain a bonus to all Charisma-based skill checks involving these soldiers equal to your Charismatic level.

RALLY

By spending a full round action and making a Charisma check (DC 10), the Charismatic hero can rally troops who are shaken. All allied characters within 30 feet of the hero are no longer shaken. The Charismatic Hero receives a bonus equal to his Charismatic level to the Charisma check.

Prerequisite: Command.

IMPROVED RALLY

By spending a full round action and making a Charisma check (DC 15), the Charismatic hero can rally troops who are panicked. All allied characters within 30 feet of the hero who are panicked become shaken, and those characters already shaken are no longer shaken. The Charismatic Hero receives a bonus equal to his Charismatic level to the Charisma check.

Prerequisite: Rally.

ADVANCED RALLY

By spending a full round action and making a Charisma check (DC 20) the Charismatic hero can rally troops who are cowering. All allied characters within 30 feet of the hero who are cowering become shaken, while allies already panicked or shaken are no longer panicked or shaken. The Charismatic Hero receives a bonus equal to his Charismatic level to the Charisma check.

Prerequisite: Improved Rally.

◇ DIPLOMATIC

The Charismatic hero can overcome linguistic barriers and cultural rules in order to carry out delicate diplomatic negotiations with this talent tree.

DIPLOMATIC TONGUE

When running a diplomatic negotiation, such as finalizing a trade contract or organizing a cease-fire between warring factions, the Charismatic hero receives a bonus to all Charisma-based skills equal to his Charismatic level.

UNIVERSAL COMMUNICATION

When dealing with intelligent creatures with which the Charismatic hero shares no common language, the Charismatic hero may make a Charisma check (DC 15) to which he receives a bonus equal to his Charismatic level. If successful, the Charismatic hero can engage in crude communication with the creatures. Generally, a single “sentence” using this talent takes a full action and can be no more than six words long. Charisma-based skills employed while using this talent suffer a -2 circumstance penalty.

IMPROVED UNIVERSAL COMMUNICATION

The Charismatic hero suffers no penalty to his Charisma-based skills when dealing with beings with whom he does not share a common tongue. His empathic hand motions and bright smile are enough.

Prerequisite: Universal Communication.

CULTURAL GRASP

The Charismatic hero is an expert at apologizing, be it for unknowingly insulting a velin chief or for using the wrong fork at a ceremonial feast. In such situations the Charismatic hero



can make a Charisma check against a DC listed on the table below, receiving a bonus equal to his Charismatic level. If successful, the social faux pas is forgiven. If not, the Charismatic hero must find another way out of the situation.

Social Faux Pas	DC
Common mistake.	10
Using the wrong fork	
Uncommon mistake.	15
Not raising a glass to toast the party host	
Insulting mistake.	20
Disrespecting a local leader	
Suicidal mistake.	30
Disparaging a sacred velin custom	

◆ MERCANTILE

The Charismatic hero is well skilled in the arts of negotiation through this talent tree.

BARGAIN MASTERY

The Charismatic hero receives a bonus on all Charisma-based skill checks when carrying out a mercantile discussion, such as bartering trade goods or trying to haggle down the cost of an item. The bonus is equal to the Charismatic hero's Charismatic level.

IMPROVED BARGAIN MASTERY

The Charismatic hero's bargaining skills are such that the purchase DCs of all items are reduced by one when he interacts face-to-face with the seller. Also, when selling an item the Charismatic hero's Wealth bonus increases by +1 in addition to the increase normally gained from selling the item.

Prerequisite: Bargain Mastery.

ADVANCED BARGAIN MASTERY

The Charismatic hero's bargaining skills are such that the purchase DCs of all items he purchases are reduced by the Charismatic hero's Charisma bonus when he interacts face-to-face with the seller.

Prerequisite: Improved Mastery.

OCCUPATIONS • • •

While the inhabitants of Dawning Star live in a highly-advanced, space-faring civilization, many of the same jobs remain from their prior life on Earth. Only in the upper echelons of science and technology do noticeable differences arise; the common man works in much the same manner as people did

on Earth for the last century. These occupations are mirrored in most of the alien races encountered by the people of Eos, though not in the same proportions.

All of the occupations from *d20 MODERN* and the *Future SRD* are also permitted.

◆ BUREAUCRAT

Bureaucrats make sure the day-to-day functions of government continue to operate properly. They deal with paperwork, inspections, issuing permits, and similar everyday governmental activities without which society would grind to a halt. Few appreciate the skills of the bureaucrat until they need something from the government. In a colonial environment like Eos, bureaucrats are often forced to deal with problems in a hands-on way, using whatever means are required to enforce government regulations, as the sheriff is not always available to strong-arm the locals.

Prerequisite: Age 23+.

Skills: Choose two of the following skills as permanent class skills. If a skill you select is already a class skill, you receive a +1 competence bonus on checks using that skill.

Bluff, Barter, Computer Use, Diplomacy, Forgery, Intimidate, Investigate, Knowledge (Business, Civics, Current Events, History), Read/Write Language, Research, Search, Sense Motive, Speak Language, Spot.

Bonus Feat: Attentive or Meticulous.

Wealth Bonus Increase: +2.

◆ COURTIER

Within the Dawning Star Republic, they may be called lobbyists or political advisors. Courtiers advise rulers in their daily decisions, ranging the gamut from wise councilors to "yes" men and toadies. Many courtiers are trained entertainers in addition to advisors, mastering skills such as oratory or music. Courtiers are often sent on diplomatic missions and can lead quite the life of exciting court intrigue.

Prerequisite: Age 23+, Charisma 13.

Skills: Choose three of the following skills as permanent class skills. If a skill you select is already a class skill, you receive a +1 competence bonus on checks using that skill.

Bluff, Diplomacy, Gamble, Gather Information, Intimidate, Investigation, Knowledge (Civics, Current Events, History, Popular Culture, Tactics, Technology), Listen, Perform, Read/Write Language, Sense Motive, Speak Language.

Wealth Bonus Increase: +4.

◆ DISSIDENT

Not everyone is happy with the government that stands over them. These rebellious souls seek to tear down the establishment—perhaps in order to replace it with a better society, perhaps simply for

the fun of tearing it down. Dissidents are found among every race, but on Eos they are mainly found in the faction-camps outside the Dawning Star Republic.

Prerequisite: Age 15+.

Skills: Choose three of the following skills as permanent class skills. If a skill you select is already a class skill, you receive a +1 competence bonus on checks using that skill.

Bluff, Craft (Chemical, Mechanical, Pharmaceutical), Demolitions, Disable Device, Disguise, Drive, Forgery, Gather Information, Hide, Intimidate, Knowledge (Civics, Current Events), Move Silently, Pilot, Repair, Search, Sense Motive, Spot, Survival.

Bonus Feat: Cautious or Deceptive.

Wealth Bonus Increase: +1.

◇ EXPLORER

Eos and the other planets of the Helios system have thousands of unexplored regions, many of which bristle with ancient ruins and resources. Explorers are the intrepid individuals who brave the dark corners of the uncharted wastes, the unforgiving vacuum of space, hostile life forms, and deadly weather conditions in pursuit of the unknown. They are always looking for the next adventure.



Prerequisite: Age 18+.

Skills: Choose three of the following skills as permanent class skills. If a skill you select is already a class skill, you receive a +1 competence bonus on checks using that skill.

Climb, Disable Device, Drive, Handle Animal, Hide, Jump, Knowledge (History, Local, Species), Listen, Move Silently, Navigate, Pilot, Repair, Ride, Search, Speak Language, Spot, Survival, Swim, Treat Injury.

Bonus Feat: Guide.

Wealth Bonus Increase: +1.

◇ HUNTER

Not all the cultures in the Helios system are world-spanning civilizations with cutting edge technology. Some are still tribal nations living closer to nature, such as the velin. Hunters are the providers of food and defenders of these civilizations.

Prerequisite: Age 15+.

Skills: Choose three of the following skills as permanent class skills. If a skill you select is already a class skill, you receive a +1 competence bonus on checks using that skill.

Climb, Craft (Tribal), Handle Animal, Hide, Intimidate, Jump, Knowledge (Local, Species), Listen, Move Silently, Navigate, Ride, Search, Spot, Survival, Swim, Treat Injury, Tumble.

Bonus Feat: Archaic Weapon Proficiency, Endurance, or Stealthy.

Wealth Bonus Increase: +0.

◇ NOMAD

Whether a velin without a tribe or a human hoping to find himself in the wilderness, nomads wander for the sake of the journey. With no set place to go and driven by no great need to see new things, they instead journey for more personal reasons. Nomads are most common among the velin.

Prerequisite: Age 18+.

Skills: Choose three of the following skills as permanent class skills. If a skill you select is already a class skill, you receive a +1 competence bonus on checks using that skill.

Climb, Craft (Tribal), Drive, Gamble, Gather Information, Handle Animal, Knowledge (Current Events, Local), Listen, Navigate, Ride, Search, Speak Language, Spot, Survival, Swim, Treat Injury.

Bonus Feat: Endurance or Guide.

Wealth Bonus Increase: +1.

◇ PILOT

With the lack of roads on Eos, transportation is largely done through the air. This requires a large number of trained pilots, who carry out tasks varying from military duty to mail delivery.

Prerequisite: Age 18+.

Skills: Choose two of the following skills as per-

manent class skills. If a skill you select is already a class skill, you receive a +1 competence bonus on checks using that skill.

Computer Use, Drive, Knowledge (Current Events, Local, Popular Culture), Navigate, Pilot, Repair, Speak Language, Spot, Survival.

Bonus Feat: Aircraft Operation.

Wealth Bonus Increase: +2.

◇ RANCH-HAND

The raising and harvesting of murcows is a major industry on Eos, providing the main source of meat on the planet. This industry has brought about a rebirth of the old Earth cowboy. Murcow ranch-hands are an independent lot used to spending their days on the trail while taking care of hundreds of murcows.

Prerequisite: Age 18+.

Skills: Choose three of the following skills as permanent class skills. If a skill you select is already a class skill, you receive a +1 competence bonus on checks using that skill.

Barter, Drive, Gamble, Handle Animal, Jump, Knowledge (Local), Listen, Navigate, Pilot, Ride, Spot, Survival, Swim, Treat Injury.

Bonus Feat: Animal Affinity.

Wealth Bonus Increase: +1.



◇ SCIENTIST

All the nations of the Helios system work feverishly to develop and perfect technologies that can give them an edge over their neighbors or may help them find lost members of their race. Trained scientists are a valuable commodity, so much so that some faction-camps make a regular practice of kidnapping them.

Prerequisite: Age 23+.

Skills: Choose one of the following skills as permanent class skills. If a skill you select is already a class skill, you receive a +1 competence bonus on checks using that skill.

Computer Use, Craft (Any), Disable Device, Drive, Investigate, Knowledge (Life and Earth Science, Physical Sciences, Technology), Read/Write Language, Pilot, Repair, Research, Search, Terraforming.

Bonus Feat: Builder, Educated, or Gearhead.

Wealth Bonus Increase: +3.

◇ SPACER

Spacers are those rare breed of people who find nothing wrong with weightlessness and find the vast darkness of space comforting. They spend most of their lives on space craft and orbital stations, finding the touch of a world's surface distinctly disconcerting.

Prerequisite: Age 20+.

Skills: Choose two of the following skills as permanent class skills. If a skill you select is already a class skill, you receive a +1 competence bonus on checks using that skill.

Balance, Computer Use, Disable Device, Drive, Jump, Knowledge (Current Events, Local, Popular Culture), Navigate, Pilot, Repair, Search, Spot.

Bonus Feat: Zero-G Training or Starship Operation.

Wealth Bonus Increase: +2.

◇ TERRAFORMER

The Dawning Star's primary cargo aside from people was terraforming equipment that was designed to turn Lalande 2118 into a habitable world. Instead, it was used to fine-tune the environment of Eos. Since then, the terraformers have worked on perfecting it.

Prerequisite: Age 23+.

Skills: Choose two of the following skills as permanent class skills. If a skill you select is already a class skill, you receive a +1 competence bonus on checks using that skill.

Computer Use, Craft (Any), Drive, Investigate, Knowledge (Earth and Life Science, Local, Physical Sciences, Technology), Navigate, Pilot, Repair, Search, Terraforming.

Bonus Feat: Builder, Educated, or Terraforming Training.

Wealth Bonus Increase: +3.

◇ TRIBAL LEADER

In the tribal societies of the velin, leaders often rule as much by strength as by wisdom. Such rulers are personable, having to establish a personal connection with their followers. Tribal leaders tend to either inspire intense loyalty or quickly lose their position to a better liked or stronger candidate.

Prerequisite: Age 20+, Wisdom 13.

Skills: Choose two of the following skills as permanent class skills. If a skill you select is already a class skill, you receive a +1 competence bonus on checks using that skill.

Bluff, Craft (Tribal), Climb, Diplomacy, Gather Information, Handle Animal, Hide, Intimidate, Knowledge (History, Local), Listen, Move Silently, Navigate, Perform (Any), Ride, Search, Speak Language, Spot, Survival, Swim, Treat Injury.

Bonus Feat: Guide or Trustworthy.

Reputation Bonus Increase: +1.

Wealth Bonus Increase: +2

◇ XENO-EXPERT

While Lalande 21185 was expected to be devoid of life, Eos has instead offered up a veritable cornucopia of new life forms. There is a great deal of material for study by scientists specializing in other alien species. These xeno-experts are in high demand due to the all too common interactions with alien life forms on Eos and other worlds.

Prerequisite: Age 23+, Intelligence 13.

Skills: Choose two of the following skills as permanent class skills. If a skill you select is already a class skill, you receive a +1 competence bonus on checks using that skill.

Bluff, Computer Use, Decipher Script, Investigate, Knowledge (Any), Read/Write Language, Research, Sense Motive, Speak Language, Spot, Treat Injury.

Bonus Feat: Species Familiarity (of choice) or Xenomedic.

Wealth Bonus Increase: +3.

SKILLS • • •

The following section provides new uses and rules for skills, expanding the existing the d20 Modern rules to better fit DAWNING STAR. All of the skills and skill descriptions from D20 MODERN and the Future SRD are also used.

◇ SKILLS AND PROGRESS LEVEL

When a character seeks to use an item of a higher progress level than his PL familiarity, he suffers a circumstance penalty of -4 per progress level of difference between the two. This penalty comes into play most frequently for Computer Use, Craft, Demolitions, Disable Device, Drive, Pilot, and Repair skill checks, though the GM may determine that it applies to other skill checks as well. This

penalty can be reduced or avoided by some talents, feats, and class abilities.

◇ SKILLS AND ALIEN WORLDS

Characters trained in survival skills on one world may not find their experience so useful when stranded on another world. Each hero must designate a world as their home world. When not on his home world, the hero suffers a -4 circumstance penalty to Gather Information, Knowledge (Current Events, History, Popular Culture, Streetwise), Navigate, and Survival skill checks. This penalty may be modified or eliminated at the GM's discretion, depending on the circumstances. Some worlds, such as desert planets, may have greater penalties to Navigate and Survival checks. This penalty can be reduced with the Explorer Training and World Familiarity feats.

◇ NEW USES FOR OLD SKILLS

CRAFT (TRIBAL) (INT)

Trained Only

This sub-skill gives you training in making primitive goods like tents, spears, religious figurines, beaded jewelry, and clothes from skins, wood, and other unrefined materials.

Check: Craft (Tribal) functions like other Craft skills. However, it can be used to make a variety of goods of a variety of materials, but it cannot be used to craft items above Progress Level 3. Crafting items with this skill requires a crude toolkit and appropriate raw materials, and you may take 10 but not 20 on a Craft (Tribal) check.

The primary differences are that Craft (Tribal) allows a variety of goods to be made, from saddles to tents to weapons, but items above progress level 3 may not be made with Craft (Tribal). Additionally, items composed of advanced materials, such as steel or plastic, may not be made with Craft (Tribal), although crude metal items, such as a simple, iron arrowhead, may be crafted. In lieu of purchasing the raw materials for a Craft (Tribal) check, you may harvest the resources on your own. Generally this

CRAFT (TRIBAL)

Type of Tribal Object	Purchase DC	Craft DC	Time
Simple (club, spear, tunic)	4	10	1 hr.
Moderate (leather armor, axe, tent)	10	15	12 hr.
Complex (bow, sword, boat)	14	20	24 hr.
Advanced (metal armor, crossbow)	18	25	60 hr.

takes quadruple the amount of time required to actually craft the item, and requires an appropriate Knowledge (Local), Profession, Search, or Survival check equal to the DC of the Craft (Tribal) check. If the raw materials as destroyed during a Craft (Tribal) check due to failure, they must be harvested again.

Special: A character without a tribal tool kit takes a -4 penalty on Craft (Tribal) checks. A character with the Builder feat gets a +2 bonus on all Craft (Tribal) checks. Craft (Tribal) is always considered a class skill for velin.

DISGUISE (CHA)

You can use the Disguise skill to appear like a member of another species.

Check: Using the Disguise skill in this way is a difficult process. Despite the fact that the two other races encountered thus far are humanoid, they are of different size, skin color, or build from each other. When making a Disguise check to pass as a member of an alien race the Disguise check suffers a -5 circumstance penalty.

FORGERY (INT)

You can use this skill to create a fake craftmark.

Check: Much of the industry on Eos is done in the home, using the cottage model. In such a system, a craftsman's reputation is vitally important. For this reason, most craftsmen sign or mark their work in some manner to avoid others passing off shoddy work as theirs. These are known as craftmarks. The creations of skilled craftsmen bring a high price at market, leading some disreputable types to fake craftmarks so they may convince unwary buyers an item is of much better quality than it actually is.

Forging a craftmark requires two separate checks. In addition to the Forgery check, the forger must make an appropriate Craft check to mark the item without damaging it and to make the item look like the workmanship of the craftsman whose mark will be forged. The DC of this Craft check is equal to 10 + 5 for each size category larger than Small the item is.

Most craftmarks are considered simple or complex documents, though masters may mark their works with difficult or extreme marks just to make a forger's life difficult. Most merchants are familiar with the well-known craftmarks.

Forging a craftmark in this way takes 1d4 hours.

KNOWLEDGE (LOCAL) (INT)

Trained Only

This sub-skill gives you knowledge of the general history, culture, politics, economy and important

personalities of a specific area chosen when the skill is selected.

Check: Generally, a Knowledge (local) skill applies to an area of 100 square miles or less, but particularly heavily populated dense areas may shrink this size while lightly populated areas covered by a single skill could be much larger. For example, Knowledge (Dawning Star) and Knowledge (Iron Scar) are both viable selections.

Using Knowledge (local), you can find places to buy certain goods in your specific area, you know who the local leaders are, you are familiar with any important local customs, you know the best place to eat in town, and you know what resources the area produces and demands. This skill does not provide knowledge of secrets known by only a few, such as the name of the mistress of the local sheriff or where a long-lost artifact resides.

If you need a particular piece of information, make a Knowledge (local) check against a DC listed on the table below. If the check succeeds you know the piece of information sought; if it fails, you do not. If you fail the check by more than five points, the GM may give you false information.

Situation	DC
Knowing what neighborhoods to avoid at night.	5
Knowing where for the best restaurant in town is.	10
Knowing who the local police chief or other somewhat important personality is.	15
Knowing where illegal drugs may be purchased.	20
Knowing where illegal firearms may be acquired.	25

Try Again?: Maybe. As with most Knowledge checks, the check represents what you know, and thinking about a topic a second time doesn't let you know something you never knew in the first place. However, re-tries may be permitted by the GM in certain circumstances. For example, if you are trying to remember where a particular restaurant is located and fail, you might go to the incorrect location and realize the error. The GM may then permit you to try again, but not until you investigate the result of the first Knowledge (local) check.

Special: Ranks in this skill may be purchased for multiple locales. Ranks for each locale are purchased separately.

Time: A Knowledge check can be a reaction, but otherwise requires a full-round action.

KNOWLEDGE (SPECIES) (INT)

Trained Only

This sub-skill gives you knowledge of the cultural practices, history, legends, and important personages of a specific species other than your own, such as velin or tentaari.

Check: Knowledge (Species) entails knowledge of that species' history, customs, social structure, and biology. Knowledge (Species) can be used to recall social mores so as not to commit an unintentional faux pas, identify political and mythic figures for use in diplomatic endeavors, or for other similar functions.

A successful Knowledge (Species) check (DC 15) reduces by -2 penalties for other actions related to that species. For example, a successful check would reduce the penalty for a human attempting surgery on a velin or the penalty for a human attempting to operate a tentaari blaster. Penalties cannot be reduced below 0 in this manner.

Try Again?: No. The check represents what you know, and thinking about a topic a second time doesn't let you know something you never knew in the first place.

Special: Ranks in this skill may be purchased for different species. Ranks for each species are purchased separately. Knowledge (Species) is considered a class skill for all basic classes.

Time: A Knowledge check can be a reaction, but otherwise requires a full-round action.

READ/WRITE LANGUAGE AND SPEAK LANGUAGE (NONE)

Trained Only

Most of the citizens of the Dawning Star Republic and the faction camps speak English as it was the most common tongue among the nations that crewed the Dawning Star. There are other languages that are spoken among the various neighborhoods of Dawning Star and the faction camps, with Spanish, Paki, Hindi, Bengali, French, and German being the most common. Many of the citizens of Eos are bilingual.

The tentaari speak their own tongue they call tentaarima, which is difficult for humans to pronounce due to differing mouth structures. The tentaari rarely speak tentaarima while around humans and, in fact, seem worried that humans may eventually figure out the language. While some humans have attempted to learn tentaarima, there has not been much effort put into the research because of the tentaari's desire to impede that goal. The tentaari usually use English when conversing with humans, but they have also begun teaching some inhabitants of Eos another tongue, called Unispeak. According to the tentaari, Unispeak is a specially crafted language that almost all alien races are able to speak and understand, and it has become the

lingua franca of those planets protected by the tentaari. Unispeak may be selected as a language for Speak Language and Read/Write Language by starting Dawning Star characters. Tentaarima may only be learned with GM approval.

The velin speak their own language, which is currently being studied by a number of linguists in Dawning Star. Many humans who interact regularly with the velin have picked up the tongue, just as velin who work with humans have picked up English. For the most part, the two races have an easy time learning the languages of the other. Velin may be selected as a language for Speak Language, but it has no written version. (Similarly, a velin character may select English for the Read/Write Language or Speak Language skills.)

TREAT INJURY (WIS)

This skill is also for using the cryogenic freezing process.

Check: Putting a person into or waking someone from cryogenic freezing is a dangerous process that can cause damage to the cells of the subject's body if not done correctly. Most cryogenic sleep beds have the technology for installing and waking the occupant built in; normally, there is no additional equipment required.

Entering Cryogenic Sleep: Putting a person into cryogenic sleep requires a Treat Injury check, (DC 15). If this check fails by five or less, the occu-



part is successfully frozen but must make a Fortitude save (DC 20) or suffer 1d6 points of Constitution damage. If the check fails by more than five, the freezing process fails and the occupant must make a Fortitude check (DC 20) or take 2d6 points of Constitution damage. Constitution damage caused by improper freezing is not healed until the subject is removed from the cryogenic freezing device.

Exiting Cryogenic Sleep: When waking someone from cryogenic freezing, the operator of the cryogenic device must make a Treat Injury check (DC 15) to successfully awaken the occupant. If the operator fails the Treat Injury check, the occupant must make a Fortitude saving throw, DC 15 + the amount the Treat Injury check was failed by. If the Fortitude saving throw is successful, the occupant takes 1d6 points of Constitution damage. If the Fortitude saving throw fails, the occupant takes 3d6 points of Constitution damage.

Retry: For entering cryogenic sleep, yes, but each additional attempt may inflict Constitution damage. For exiting cryogenic sleep, no.

Time: 6 hours.

◆ NEW SKILLS

The following two skills have been added to the skill list to reflect the specifics of and their importance in Dawning Star.

BARTER (CHA)

This skill allows you to talk your way into a better deal when buying or selling goods.

Check: This skill combines fast-talking, knowledge of goods, and the general state of the economy. The ancient art of haggling has found new life on Eos due to the limited usage of credits, especially outside the Dawning Star Republic. After centuries of simple cash exchanges for fixed retail prices, the stark nature of the colonial economy has brought about the return of a barter-based economy in many locales. While credits are commonly traded in Dawning Star itself, most of the faction-camps and the outer settlements of the Dawning Star Republic rely on barter. This has forced just about everyone to develop a keen eye and wit for wheeling and dealing.

Haggling: A Barter check is made between parties when they are trying to come to an equitable decision about the value of goods they wish to buy or sell. One party is designated as the buyer; the other is designated as the seller. Both parties make Barter checks. If the seller wins, the amount the buyer's Wealth bonus decreases as a result of the purchase is doubled, and the amount the seller's Wealth bonus increases as a result of the sale is also doubled. If the purchaser wins, he has two options: He may reduce the Purchase DC of the



item by the amount his check exceeded the seller's, or he may cut the amount his Wealth bonus will be reduced by the purchase in half.

The party that loses the check generally still completes the transaction, unaware that he has been taken. In rare cases, the GM may determine that a party can refuse to go through with the deal. In such cases, they cannot make another contested Barter check involving the same goods in the same market for 24 hours.

Exchange of Goods: In some cases, two parties may wish to exchange goods rather than engage in a traditional purchase and sale. Generally, characters may trade any good for another good of equal or approximate value. Of course, a character can trade anything they have for anything they want, assuming they can find a taker. Using the Barter skill successfully improves their result when trying to exchange something for a good of greater value.

The two parties to the transaction make opposed Barter checks. The character who wins the check may add the difference in the checks to the purchase DC of the goods he is trying to trade for purposes of evaluating the deal. This may make the other side more likely to accept the trade, if it makes the purchase DCs of the two items fairly close, or it may make the other side eager to complete the deal if it pushes the purchase DC well above what the other side is offering. The party that loses the check generally still completes the transaction, unaware that he has been taken. In rare cases, the GM may determine that a party can refuse to go through with

the deal. In such cases, they cannot make another contested Barter check involving the same goods in the same market for 24 hours.

If the deal is completed, the parties' Wealth bonuses are affected based on the actual purchase DCs of the goods exchanged. The party giving up the good with the higher actual purchase DC is treated as if he sold an item to the other party with a purchase DC equal to the difference between the actual purchase DCs of the two items. For example, if Scott trades his EDF-9 auto-pistol (DC 18) for Jennifer's binoculars (DC 7), their Wealth bonuses will be changed as if Scott sold Jennifer an item with a purchase DC of 11.

Puffery: A party to a transaction may try to falsely represent the value of his goods. To do so, he makes a Bluff check opposed by the other party's Sense Motive check. If he succeeds, he gets a +2 circumstance bonus to his Barter check. If he fails, the deception is discovered and now the character has to deal with a merchant he just tried to fleece. This may impact his attempts to barter in that market as well, resulting in a circumstance penalty as determined by the GM.

Valuation: Barter can be used to determine the market value of goods and service according to fluctuations in the local economy. This allows you to keep up with the latest demand for different items and be aware of reports of product scarcity or flooded markets. Properly utilized, this might allow you to make a tidy profit moving goods from flooded markets to scarce markets. The value found in this skill check is not just the book value of the item in question, but how much the item will fetch on the open market given current market conditions.

To estimate the true market value of an item you must make a Barter check against a DC based on the rarity of the item and other factors.

Condition	DC
Common item (food)	10
Uncommon items (motorized vehicles)	15
Rare items (high-tech weapons)	20
Very Rare items (armored vehicles)	25
Extreme market turbulence	+5
No recent contact with other markets or similar sources of information	+5

If successful, you determine what the market value for the item in question should be given your current situation and the specific market forces there. If the check fails, you estimate the value of the item at 60-150% (50 + 1d10*10) of its actual value.

Try Again?: Sometimes. Generally, on a failed Barter check, the other party becomes entrenched in their position. However, the GM may permit retries in certain cases. You can try again when using the Barter check to determine the value of a particular item by visiting other local markets, but you may get different results each time and will have no way of knowing which answer is correct.

Special: You can take 10 when making a Barter check, but you can't take 20.

A character with the Master Trader feat gets a +2 bonus on all Barter checks.

Barter is a class skill for Charismatic heroes and advanced and prestige classes favored by Charismatic heroes.

Time: 5 minutes.

BARTERING EXAMPLE

Phillip Hine, a faction-camp agent, is bargaining with a weapons dealer, Argo Jones, to purchase a brand new EDF-9 auto-pistol, purchase DC 18. Phillip has a Barter skill bonus of +8 and a Wealth bonus of +10. Argo has a Barter skill bonus of +10 and a Wealth bonus of +12. Phillip is the purchaser, while Argo is the seller.

Both make their skill checks.

Argo's check results in a 23 and Phillip a 15. Normally, completing the sale would cause Argo's Wealth bonus to increase by +1. Because he won the check, his Wealth bonus goes up by +2 instead (double the normal amount), assuming the sale is completed. Also Phillip's Wealth Bonus will decrease by -4 (again double the normal amount of decrease).

If Argo's check results in a 13 and Phillip an 18, Phillip would win and could either reduce the purchase DC of the pistol by 5 (the difference in the checks) or reduce the amount his Wealth bonus will be decreased by the transaction by half to -1.

TERRAFORMING (INT)

Trained Only

Terraforming allows you to reshape planets in such a way that they become suitable for life. Actual terraforming usually takes decades, so the most common use of this skill is to examine the work of past terraformers and obtain ecological information about a given area.

Check: You can transform environments to suit your needs, such as changing them to be more suitable for a specific race. This may include alterations in temperature, gas composition, wildlife interaction, and weather pattern alteration. Using the skill in this way requires a massive amount of equipment and supplies, and generally takes years. At the beginning of the attempt you must make a Terraforming check. The base DC of the check is 10, modified according to the table below.

Task	DC
Minor changes (diverting or damming rivers, temperature changes of a few degrees, etc.)	+0
Moderate changes (introducing new plant species, clear-cutting forests, temperature changes of 10+ degrees)	+5
Major changes (exterminating animal species, leveling mountains, temperature changes of 50+ degrees)	+10
Extreme changes (wholesale alteration of atmospheric conditions, major shifts in prevailing winds, temperature changes of 100+ degrees)	+15
Change 10 square miles or less	+0
Change an entire region	+5
Change an entire continent	+10
Change an entire planet	+15
The environmental conditions are somewhat volatile	+5
The environmental conditions are extremely volatile	+10

If the check is successful, you have developed a plan that will make the desired changes to the environment. Once you have a plan you may begin ter-

raforming using whatever equipment is on hand. If the check fails you can still make the changes, but they take twice as long as expected. If the check fails by more than five, your plan is flawed and will not work.

Terraforming Evaluation: By examining past changes made to an environment, you can determine how it was terraformed and the original condition of the environment before terraforming. This requires a Terraforming check, DC 25. If the check succeeds, you learn what the environment was like before terraforming, what methods and technologies were used in making the changes, and what race made the changes if you are familiar with that species' technology. If the check fails, you are not able to discern the above information. If the check fails by more than five points you come to false conclusions about the planet's terraforming past.

Ecological Evaluation: Terraformers need to know about existing worlds before they can alter them. You can take an in-depth look at an area and determine the principal life forms, the regional climate, major weather patterns, etc. This information is by no means complete, but gives you an excellent idea of the ecological makeup of the area studied. This requires a Terraforming skill check, DC 20. If you succeed, you and your allies gain a +2 circumstance bonus to Survival checks and a +1 circumstance bonus to Fortitude saving throws against severe weather conditions or hostile atmospheric conditions, assuming you have the means to take advantage of the information you gain. If the check fails, you may gather the necessary information but it takes twice the normal amount of time. If the check fails by more than five you gather incorrect information and your results are grossly flawed.

Try Again?: Yes. However, unsuccessful terraforming attempts may damage the environment or make subsequent attempts more difficult.

Special: You can take 10 on a Terraforming check, but you cannot take 20. Terraforming is only a class skill for characters who take the Terraformer occupation, the Terraforming Training feat, or the Master Terraformer prestige class.

Time: Coming up with a terraforming plan takes a number of days equal to the DC of the Terraforming check to make the plan. The actual terraforming process generally takes a number of years equal to the DC of the Terraforming check to plan the process. Particularly good equipment can reduce this time. Generally speaking, however, actual terraforming should be a rare activity for PCs, and the specifics of the process are left up to the GM to tailor the process to fit the specific campaign. Terraforming evaluation and ecological evaluation take 6 hours for 10 square miles or less, 5 days for a region, 15 days for a continent, and 30 days for a planet.

FEATS • • •

This section presents a host of new feats relating to the world of Eos. Additionally, characters in DAWNING STAR have access to all the feats described in D20 MODERN and the Future SRD.

◇ ALIEN FRIEND

You are comfortable dealing with alien species.

Benefit: You receive a +1 bonus on all Charisma-based skills when interacting with members of species besides your own.

Special: This feat is available as a bonus feat to Charismatic heroes and advanced and prestige classes that they favor.

BLOOD BLISTER SURVIVOR

You survived an outbreak of the blood blisters and have the scars to prove it.

Prerequisite: Constitution 11.

Benefit: You are immune to blood blisters and gain a +4 bonus to Fortitude saving throws against disease.

◇ CRAFTSMAN

You are a noted craftsman on Eos.

Prerequisite: Craft (any) 4 ranks.

Benefit: You gain a +2 bonus to one Craft skill of your choice in which you have enough ranks to meet the prerequisite for the feat. Also, your Reputation bonus increases by +1, and your Wealth bonus increases by +2.

◇ DAWNING STAR FAMILIARITY

You have spent many years behind the steel walls of Dawning Star.

Prerequisite: Must have spent at least three years living in Dawning Star.

Benefit: You gain a +1 bonus to Diplomacy, Gather Information, Knowledge (Civics, Current Events, History, Local, Popular Culture, Streetwise), Navigate, and Spot checks while inside Dawning Star due to your familiarity with the area. Your Wealth bonus also increases by +2.

◇ EOS FREEDOM LEAGUE MEMBER

You have taken up arms against the Dawning Star Republic and joined the Eos Freedom League.

Prerequisite: Must have spent time training with the Eos Freedom League, Eos Freedom League Allegiance.

Benefit: You gain a +1 morale bonus on attack and damage rolls against law enforcement and military officers of the Dawning Star republic. You get a +1 bonus on Charisma-based checks when the GM determines that your membership would be a benefit, and you suffer a -1 penalty on Charisma-based checks when the GM determines that your membership would hurt you.

◇ EXPLORER TRAINING

In preparation for humanity reaching other worlds, you are trained in surviving in a wide variety of environments.

Prerequisite: Survival 6 ranks.

Benefit: You halve any penalties to Survival or Navigate skill checks due to being on an alien world. You also gain a +2 bonus to Fortitude saves against environmental conditions.

Special: This feat is available as a bonus feat to Dedicated heroes and the advanced and prestige classes they favor.

◇ FACTION-CAMP FAMILIARITY

You have spent many years living among the faction-camps and know their people, politics and geography well.

Prerequisite: Must have spent at least three years living in one of the faction-camps.

Benefit: Select one of the faction-camps. You gain a +1 bonus to Diplomacy, Gather Information, Knowledge (Civics, Current Events, History, Local, Popular Culture, Streetwise), Navigate, and Spot checks while inside the selected faction-camp due to your familiarity with the area. You also receive a +2 bonus to Bluff skill checks.

◇ IRON SCAR FAMILIARITY

You have spent many years living in Iron Scar among the scrapers and other frontiersmen.

Prerequisite: Must have spent at least three years living in Iron Scar.

Benefit: You gain a +1 bonus to Diplomacy,



Gather Information, Knowledge (Civics, Current Events, History, Local, Popular Culture, Streetwise), Navigate, and Spot checks while within Iron Scar due to your familiarity with the area. You also receive a +1 bonus to Fortitude saves.

◇ **MASTER CRAFTSMAN**

You are one of the most renowned masters of your craft on Eos, drawing great acclaim and wealth for your work. Your creations are considered to be of the highest quality and the waiting list for your work is quite long.

Prerequisites: Craft (Any) 10 ranks, Craftsman.

Benefit: You receive a +1 bonus on a Craft skill of choice, your Reputation bonus increases by +2, and your Wealth bonus increases by +3.

◇ **MASTER TRADER**

Your silver tongue has made you a master bargainer, always able to get the best deals.

Prerequisite: Charisma 13.

Benefit: You receive a +2 bonus to Barter and Profession (Trader) skill checks.

Special: This feat may be selected as a bonus feat by Charismatic heroes and the advanced and prestige classes they favor.

◇ **MEASURE OF THE CITY**

When you enter a settlement, you are able to quickly size it up.

Prerequisites: Intelligence 13, Gather Information 6 ranks, Spot 6 ranks.

Benefit: When you enter a settlement, you can make a Gather Information check to learn about the cultural, economic and political situation in the settlement. The DC for the check is 10 + 1 per 10,000 inhabitants in the settlement plus any additional modifiers based on how familiar you are with the dominant culture of the city. If the check is successful, you learn the population of the city, the goods that can be purchased there, any power centers in the city, and who the authorities are. Also, if successful, you gain a +2 bonus to Bluff, Diplomacy, Gather Information, Knowledge (Civics, Current Events, History, Popular Culture, Streetwise), and Navigate skill checks made concerning the settlement for the next five days. If the check fails, you may try again, but the base DC increases by +5 for each subsequent attempt.

◇ **MOUNTED COMBAT**

You are trained to fight from the back of a riding beast, such as a Dawson dragon.

Prerequisite: Ride 1 rank.

Benefit: Once per round, when your mount is hit in combat, you may attempt a Ride check (as a reaction) to negate the hit. The hit is negated if your Ride check result is greater than the opponent's attack roll. (Essentially, the Ride check result

becomes the mount's Armor Class if it's higher than the mount's regular AC.)

Special: This feat may be selected as a bonus feat by Fast heroes and the advanced and prestige classes they favor.

◇ **MOUNTED GUNPLAY**

You are skilled in using ranged weapons while on a riding beast.

Prerequisites: Ride 3 ranks, Mounted Combat.

Benefit: The penalty you take when using a ranged weapon while mounted is halved: -2 instead of -4 if your mount is taking a double move, and -4 instead of -8 if your mount is running.

Special: This feat may be selected as a bonus feat by Fast heroes and the advanced and prestige classes they favor.

◇ **PUBLIC SPEAKER**

You can play a crowd as if it were a finely tuned musical instrument.

Benefit: You gain a +2 bonus to Charisma-based skill checks when speaking in front of a group of ten or more people who understand the language you are speaking.

Special: This feat may be selected as a bonus feat by Charismatic heroes and the advanced and prestige classes they favor.

◇ **REPUBLIC MILITIA MEMBER**

You are a trained member of the Republic Militia, spending several weeks a year protecting your fellow citizens from wild alien creatures, bandits, faction-camps, and other dangers.

Prerequisite: Must have spent time training with the Republic Militia, Republic Militia Allegiance.

Benefit: You gain a +1 bonus to Charisma based skill checks when dealing with citizens of Dawning Star. You are also considered proficient with the EDF-9 auto-pistol and EDF-15 assault rifle.

◇ **SPECIES FAMILIARITY**

You are very familiar with a specific alien species, such as the velin or tentaari.

Benefit: Select a species other than your own. The species selected does not need to be a sentient species. You receive a +2 bonus on Knowledge, Sense Motive, Treat Injury, and Charisma-based skill checks involving that alien species.

◇ **STREET IRREGULARS**

Through bribes, gifts and genuine friendship you have recruited a small group of locals who will help you in times of need.

Prerequisites: Charisma 13, one of Dawning Star Familiarity, Faction-Camp Familiarity, or Iron Scar Familiarity.

Benefit: On a successful Charisma check (DC 10) in an area your familiarity feat applies to, you can gather 1d6 locals to help you. The locals are ordinaries with 1d4 levels and arrive within ten minutes. These locals will run errands, help with labor, or do other minor favors for the character for a period of not more than four hours. While they can be used to intimidate people or engage in criminal activity as appropriate to the character, they will not join combat unless their neighborhood or livelihood are directly threatened.

◇ TECHNOLOGICAL APTITUDE

You are familiar with a level of technology beyond that of most humans.

Prerequisites: Intelligence 13, either Utilize Alien Technology talent or Knowledge (Technology) 10 ranks.

Benefit: Your technology familiarity increases by +1.

Special: This feat may be taken multiple times. Its effects stack. This feat may be selected as a bonus feat by Smart heroes and the advanced and prestige classes they favor.

Normal: You suffer a -4 penalty per progress level on skill checks when using items above a progress level you are accustomed to.

◇ TENTAARI APPROVED DIPLOMAT

You have managed to qualify for the small pool of tentaari approved diplomats.

Prerequisites: Charisma 13, Intelligence 13, Wisdom 13, Diplomacy 6 ranks.

Benefit: You receive a +1 bonus on all Charisma-based skill checks involving tentaari, and they are always considered to begin with an initial attitude of friendly towards you. Also, your Reputation and Wealth bonuses increase by +2.

◇ TERRAFORMING TRAINING

You are trained in the art of changing the environments of worlds on a massive scale, making them more suitable for species to inhabit.

Prerequisite: Intelligence 15.

Benefit: Terraforming is always a class skill for you, and you receive a +2 bonus to Terraforming and Knowledge (Earth and life sciences) skill checks.

◇ VELIN EXORCISM DANCER

You are trained in the velin tradition of dances and rituals to drive off the vaasi who threaten their tribes.

Prerequisites: Velin species or Velin Tribal Guest feat, Perform (Dance) 6 ranks.

Benefit: You may perform a velin exorcism dance to inspire those who perform with you as well as those who watch the dance. Performing the dance requires 30 minutes and a Perform (Dance) check (DC 10 + the total number of people in the dance including you). Everyone else who takes part in the dance must make a Perform (Dance) check, DC 10. If you are successful, you and everyone who succeeded on their check receive a +1 morale bonus to attack and damage rolls against the vaasi and a +1 morale bonus on Will saving throws. This effect lasts for six hours. Anyone merely watching the dance receives a +1 morale bonus to Will saving throws for six hours. Only those who believe the dance has some kind of power, even if it is just psychological, can gain these benefits. Those who do not believe gain nothing.

◇ VELIN TRIBAL GUEST

Despite not being a velin you have gained the acceptance and trust of a velin tribe and been made an honorary member.

Prerequisite: Velin allegiance.

Benefit: You are considered a member of a velin tribe and will be protected by that tribe if threatened. You will always have a home with them and can get basic supplies, such as food or basic archaic weapons, from the tribe at no cost. You also receive a +1 bonus to Charisma-based skill checks involving your tribe.

Special: You are expected to follow tribal law as a part of a velin tribe and may not harm the tribe, its members, or neighboring tribes. Doing any of these things results in expulsion from this tribe and loss of the feat's benefits. Thereafter, you suffer a -2 penal-



ty on all Charisma-based skill checks involving velin who know of your banishment. You may only rejoin the tribe by undertaking a long and dangerous quest for the tribe, such as recovering materials from a ruin area known to be overrun by vicious monsters.

SPECIES CLASSES • • •

Although new to D20 MODERN, other game systems have explored the concept of racial classes. This concept fits well in the world of DAWNING STAR. Each PC species in DAWNING STAR has a special class available to them. A species class represents a character's progression, in which they grow to embody the core ideals of that species. The character becomes more in tune with the most basic and integral parts of that species, such as the velin connection with nature and hatred of vaasi or the human will to survive and adapt.

A character may take levels in their species class any time they advance a level. The only pre-requisite for a species class is that the character be of the appropriate species. Levels gained in species classes do not count when determining the effects of level-based talents gained from other classes.

◆ HUMAN SURVIVOR

Human Survivor levels make a character more adaptable and able to survive in adverse conditions, while also granting a respectable amount of skill points. Humans who test themselves daily against climate, combat, or other threats are most likely to take levels in the Human Survivor class.

Class Information

The following information pertains to the Human Survivor species class.

Hit Die

The Human Survivor class gains 1d8 hit points per level. The character's Constitution modifier applies.

Action Points

The Human Survivor class gains a number of action points equal to 5 + one-half his character level, rounded down, every time he attains a new level in this class.

Class Skills

The Human Survivor class skills are as follows.

Bluff (Cha), Climb (Str), Drive (Dex), Jump (Str), Knowledge (Current Events, History, Local, Popular Culture) (Int), Listen (Wis), Profession (Wis), Search (Int), Speak Language, Spot (Wis), Survival (Wis), Swim (Str), Treat Injury (Wis).

Skill Points at Each Level: 7 + Int modifier

Class Features

The following class features pertain to the Human Survivor species class.

Adaptable

At 1st level, the Human Survivor may spend an action point to gain the ability to make a single, untrained skill check for a skill that cannot normally be used untrained. The Human Survivor may add his appropriate ability modifier as normal.

Survival Instinct

Beginning at 1st level, the Human Survivor gains a species bonus equal to his species class level to all Survival skill checks and all saving throws to resist the effects of weather and other natural environmental conditions.

Bonus Feat

At 2nd level the Human Survivor gains a bonus feat that must be selected from the list below.

Alertness, Alien Friend, Archaic Weapons Proficiency, Armor Proficiency (Light), Brawl, Dawning Star Familiarity, Dodge, Endurance, Faction Camp Familiarity, Great Fortitude, Guide, Improved Damage Threshold, Iron Scar Familiarity, Iron Will, Lightning Reflexes, Personal Firearms Proficiency, Technological Aptitude, Toughness.

Last Man Standing

Whenever the Human Survivor spends an action point to boost a saving throw or Survival check, he rolls two dice and takes the better of the two results.

HUMAN SURVIVOR

Class Level	Base Attack Bonus	Fort Save	Ref Save	Will Save	Special	Defense Bonus	Reputation
1 st	+0	+1	+1	+1	+1 Constitution, Adaptable, Survival Instinct	+1	+0
2 nd	+1	+2	+2	+2	+1 Wisdom, Bonus Feat	+2	+0
3 rd	+2	+2	+2	+2	+1 Charisma, Last Man Standing	+2	+0

◇ VELIN HUNTER

Velin Hunter levels help a character deal more readily with living in the Eotian wilds and dealing with its flora and fauna. Many velin have several levels of this class.

Class Information

The following information pertains to the Velin Hunter species class.

Hit Die

The Velin Hunter gains 1d8 hit points per level. The character's Constitution modifier applies.

Action Points

The Velin Hunter gains a number of action points equal to 5 + one-half his species level, rounded down, every time he attains a new level in this class.

Class Skills

The Velin Hunter's class skills are as follows.

Climb (Str), Craft (Tribal), Handle Animal (Cha), Hide (Dex), Jump (Str), Knowledge (Local), Listen (Wis), Move Silently (Dex), Navigate (Int), Perform (Dance, Percussion Instruments, Sing, Wind Instruments)(Cha), Ride (Dex), Spot (Wis), Survival (Wis), Swim (Str).

Skill Points at Each Level: 2 + Int modifier

Class Features

The following class features pertain to the Velin Hunter species class.

Wilderness Training

At 1st level, the Velin Hunter gains a species bonus to all Handle Animal, Ride, Navigate, and Survival skill checks equal to his species level. This bonus stacks with the velin's innate species bonus to Survival checks.

Bonus Feat

At 2nd level the Velin Hunter gains a bonus feat that must be selected from the list below.

Agile Riposte, Animal Affinity, Armor



Proficiency (Light), Armor Proficiency (Medium), Athletic, Cleave, Combat Expertise, Combat Reflexes, Dodge, Endurance, Exotic Weapon Proficiency, Great Fortitude, Guide, Improved Initiative, Power Attack, Stealthy, Toughness, Track, Weapon Focus.

Improved Detect Vaasi

At 3rd level, A Velin Hunter may use his vaasi sense species ability a number of times per day equal to double his Wisdom bonus (minimum 2/day). The range of his ability increases to 60 feet.

Tribal Collective Memory

At 3rd level, the Velin Hunter gains the ability to tap into the collective memory imprinted in all

VELIN HUNTER

Class Level	Base Attack Bonus	Fort Save	Ref Save	Will Save	Special	Defense Bonus	Reputation
1 st	+1	+1	+0	+0	+1 Wisdom, Wilderness Training	+1	+0
2 nd	+2	+2	+0	+0	+1 Constitution, Bonus Feat	+2	+0
3 rd	+3	+2	+1	+1	+1 Strength, Improved Detect Vaasi, Tribal Collective Memory	+2	+0

velin. This memory encompasses all matters pertaining to the Star Confederation and the ancient days of Eos. This ability may be used to identify Star Confederation technology, read ancient texts, identify the enemies of the Confederation, and recall basic information about the Confederation. Technical or detailed information, such as data on individual people or how to operate specific devices, is not available. To use this ability, the Velin Hunter must spend an action point and make a Wisdom check with a bonus equal to his character level. The DC for this Wisdom check depends on the type of information being sought as indicated on the table below. If the check is successful, the Velin Hunter is able to recall the information desired. Information conveyed by this ability may have to be translated or deciphered through legend and myth. A starship might be described as a sky chariot that fired bolts of lightning, while a mech might be identified as a walking war god of ancient days built in the form of its creators. Text is likely to be expressed with flowery additions, and historical information passed on in the form of parable or legend. Using this ability is usually a full round action, but in some instances the GM may rule it a free action.

Information Sought	Wisdom Check DC
Identify technology source and type	10
Read ancient text	15
Recall historical information	20

ADVANCED CLASSES • • •

The following advanced classes are uniquely suited for DAWNING STAR and involve elements and themes intrinsic to the world. In addition to these classes, the advanced classes in Chapter Six of *D20 MODERN* and those presented in the Future SRD (with the exception of the *Helix Warrior* advanced class) are suitable for a DAWNING STAR campaign.

◆ AIR RUNNER

With the lack of paved roads on Eos, most long-distance travel is done by air, using a variety of rotorwing and vector-thrust aircraft that do not require runways to function. The pilots of these vehicles have to be able to navigate over hundreds of miles of uninhabited and poorly-mapped terrain, deal with local xenomorphs, and run their vehicles in less than ideal conditions. Nicknamed “air runners”



by most colonists, these pilots are a hardy and brave breed ready to risk a howling storm just to deliver the mail. Air runners are a close-knit community in and of themselves. Letting a rumor get around that you failed to make a delivery on time is sure to earn months of derision and jokes at your expense; on the other hand, a downed air runner in hostile territory will find a host of his brothers speeding to his aid. Air runners take great pride in their jobs and most couldn't imagine doing anything else.

Select this class if you want your character to be a pilot who is capable of making it through any storm or xeno-form attack and still make it to the destination on time.

The fastest path into this advanced class is from the Fast hero basic class, though other paths as possible.

Requirements

To become an Air Runner, a character must fulfill the following criteria.

Skills: Navigate 4 ranks, Pilot 6 ranks, Survival 4 ranks.

Feat: Aircraft Operation.

Class Information

The following information pertains to the Air Runner advanced class.

Hit Die

The Air Runner gains 1d8 hit points per level. The character's Constitution modifier applies.

Action Points

The Air Runner gains a number of action points equal to 6 + one-half his character level, rounded down, every time he attains a new level in this class.

Class Skills

The Air Runner's class skills are as follows.

Barter (Cha), Bluff (Cha), Computer Use (Int), Craft (Electronic, Mechanical), Drive (Dex), Knowledge (local) (Int), Navigate (Int), Pilot (Dex), Repair (Int), Search (Int), Sense Motive (Wis), Speak Language, Spot (Wis), Survival (Wis).

Skill Points at Each Level: 5 + Int modifier (4 + Int modifier for nonhumans).

Class Features

The following class features pertain to the Air Runner advanced class.

Any Place, Any Time

At 1st level, an Air Runner halves any penalties to Pilot checks due to severe weather or landing in sub-standard conditions.

Push It!

Beginning at 1st level, an Air Runner can temporarily increase the speed of an air vehicle he is piloting, but doing so damages the vehicle. While using this ability, the speed of the vehicle increases by 25%. For each round the Air Runner uses this ability, the vehicle takes 1 hit point of damage. Damage from this ability ignores the vehicle's hardness.

She'll Make It

At 2nd level, when an air vehicle the Air Runner is piloting is reduced to negative hit points the Air Runner can keep the vehicle moving until it reaches -10 hit points. Each round the Air Runner operates the vehicle while it is at negative hit points it suffers and additional 1 hit point of damage, which ignores hardness. While at negative hit points, the vehicle's maneuverability is reduced to poor, and piloting the vehicle requires a full action instead of a move action. In order to maintain control over a vehicle at negative hit points, the Air Runner must make a Pilot check against the total number of negative hit points. If this check fails, the vehicle breaks up, loses power, and begins to free-fall.

Bonus Feats

At 3rd, 6th and 9th level, an Air Runner gets a bonus feat. The bonus feat must be selected from the following list, and the Air Runner must be able to meet all the prerequisites of the feat to select it.

Action Boost, Aircraft Operation, Alertness, Brawl, Confident, Dawning Star Familiarity, Deceptive, Dodge, Endurance, Faction-Camp Familiarity, Gearhead, Guide, Iron Scar Familiarity, Iron Will, Jack of All Trades, Personal Firearms Proficiency, Salvage, Surface Vehicle Operation, Trustworthy, Vehicle Expert.

Brace for Impact!

Beginning at 4th level, when a vehicle the Air Runner is piloting crashes or is part of a collision, the passengers of the vehicle, including the Air Runner, only take half damage.

Region Familiarity

At 5th and 8th level, an Air Runner becomes very familiar with a specific geographic region. This region should be no more than 10,000 square miles and contain no more than 100,000 people. The region should be a recognizable area, such as the lands surrounding Roger's Point, the Bergan Lowlands, or the Northern Resource Zone. When traveling in this region, the Air Runner receives a +2 competence bonus to Barter, Gather Information, Knowledge (Local), Navigate, and Survival skill checks.

AIR RUNNER

Class Level	Base Attack Bonus	Fort Save	Ref Save	Will Save	Special	Defense Bonus	Reputation Bonus
1 st	+0	+1	+2	+0	Any Place, Any Time, Push it!	+1	+0
2 nd	+1	+2	+3	+0	She'll Make It	+1	+0
3 rd	+2	+2	+3	+1	Bonus Feat	+2	+0
4 th	+3	+2	+4	+1	Brace for Impact!	+2	+1
5 th	+3	+3	+4	+1	Region Familiarity	+3	+1
6 th	+4	+3	+5	+2	Bonus Feat	+3	+1
7 th	+5	+4	+5	+2	Steady Hand	+4	+2
8 th	+6	+4	+6	+2	Region Familiarity	+4	+2
9 th	+6	+4	+6	+3	Bonus Feat	+5	+2
10 th	+7	+5	+7	+3	Old Reliable	+5	+3

Steady Hand

Beginning at 7th level, while piloting an air vehicle with which he is proficient, the Air Runner gets a +1 bonus to the vehicle's Initiative and Defense.

Old Reliable

At 10th level, an Air Runner has proven himself one of the most reliable and trustworthy of his profession. His Reputation bonus increase by +2, and he gains a +2 circumstance bonus to Bluff, Barter, Gather Information and Intimidate checks against those who would be familiar with his reputation.

◆ BARTER JACK

Barter Jack is a nickname for the traveling merchants of Eos, who spend their days carrying finished goods from Dawning Star to other settlements and returning with raw materials, food, and other supplies the city needs. These intrepid merchants are named after a quasi-mythological figure from the first days of the colony, Jack McKusky. Barter Jack, as he was known, is said to have braved snow storms, sand storms, earthquakes, and floods to get his wares to market. Barter Jack is now a common subject of tall tales among the outer settlements of Eos, and those who carry on his mantle are well respected for the risks they take transporting goods to outlying settlements. Barter Jacks are also often responsible for carrying mail shipments.

Select this class if you want to be a rough and tumble merchant who can both cut a good deal and survive in the wilds.

The fastest path to this advanced class is through the Charismatic Hero class though other routes are possible.

Requirements

To become a Barter Jack, a character must fulfill the following criteria.

Skill: Barter 6 ranks.

Feat: Great Fortitude.

Charismatic Hero Talents: Bargain, Bargain Mastery.

Wealth Bonus: +8.

Class Information

The following information pertains to the Barter Jack advanced class.



Hit Die

The Barter Jack gains 1d8 hit points per level. The character's Constitution modifier applies.

Action Points

The Barter Jack gains a number of action points equal to 6 + one-half his character level, rounded down, every time he attains a new level in this class.

Class Skills

The Barter Jack's class skills are as follows.

Barter (Cha), Bluff (Cha), Craft (Any)(Int), Diplomacy (Cha), Disable Device (Int), Drive (Dex), Forgery (Int), Gamble (Wis), Handle Animal (Cha), Intimidate (Cha), Knowledge (Business, Civics, Current Events, Popular Culture, Streetwise, Technology), Listen (Wis), Navigate (Int), Pilot (Dex), Profession (Wis), Repair (Int), Ride (Dex), Search (Int), Sense Motive (Wis), Sleight of Hand (Dex), Speak Language, Spot (Wis), Survival (Wis).

Skill Points at Each Level: 9 + Int modifier (8 + Int modifier for nonhumans).

Class Features

The following class features pertain to the Barter Jack advanced class.

Big Money

Whenever a Barter Jack gains a level (including his 1st level in the class), he gets a bonus to his Profession or Craft check to increase his Wealth bonus equal to his class level.

Region Familiarity

At 1st and 8th level, a Barter Jack becomes very familiar with a specific geographic region. This

region should be no more than 10,000 square miles and contain no more than 100,000 people. The region should be a recognizable area, such as the lands surrounding Roger's Point, the Bergan Lowlands, or the Northern Resource Zone. When traveling in this region, the Barter Jack receives a +2 competence bonus to Barter, Gather Information, Knowledge (Local), Navigate, and Survival skill checks.

Haggling King

At 2nd level, a Barter Jack gains a competence bonus to his Barter skill equal to half of his class level, rounded down.

License Permit

Beginning at 2nd level, a Barter Jack has the necessary permits and paperwork to own and transport weapons that require a license to purchase. He may carry any number of such items without licenses for them as long as he can prove his intent to sell them legally to people with licenses. This permit only applies to one political body, such as the Dawning Star Republic, the Eos Freedom League, or one of the non-aligned faction-camps. Outside the influence of that political body, the Barter Jack faces the normal penalties for transporting regulated items without a license.

Bonus Feats

At 3rd, 6th and 9th level, a Barter Jack gets a bonus feat. The bonus feat must be selected from the following list, and the Barter Jack must be able to meet all the prerequisites of the feat to select it.

Alertness, Animal Affinity, Armor Proficiency (Light), Armor Proficiency (Medium), Attentive, Brawl, Builder, Charismatic Plus, Confident,

BARTER JACK

Class Level	Base Attack Bonus	Fort Save	Ref Save	Will Save	Special	Defense Bonus	Reputation
1 st	+0	+1	+0	+1	Big Money, Region Familiarity	+1	+1
2 nd	+1	+2	+0	+2	Haggle King, License Permit	+2	+1
3 rd	+1	+2	+1	+2	Bonus Feat	+2	+1
4 th	+2	+2	+1	+2	Find the Goods, Deliveryman	+3	+2
5 th	+2	+3	+1	+3	Black Marketer, Hardy	+4	+2
6 th	+3	+3	+2	+3	Bonus Feat	+3	+2
7 th	+3	+4	+2	+4	Restricted Permit, Windfall	+4	+3
8 th	+4	+4	+2	+4	Region Familiarity	+4	+3
9 th	+4	+4	+3	+4	Bonus Feat	+5	+3
10 th	+5	+5	+3	+5	Military Permit, Windfall	+5	+4

Craftsman, Dawning Star Familiarity, Deceptive, Educated, Endurance, Faction-Camp Familiarity, Great Fortitude, Guide, Master Trader, Personal Firearms Proficiency, Public Speaker, Renown, Surface Vehicle Operation, Track, Trustworthy, Windfall.

Find the Goods

Beginning at 4th level, when a Barter Jack visits a settlement, the maximum purchase DC of goods available in that settlement is increased by the Barter Jack's class level. This represents his ability to convince people to sell items to him that are not normally for sale.

Deliveryman

At 4th level, a Barter Jack gains a +2 bonus to Navigate and Survival skill checks.

Black Marketer

At 5th level, a Barter Jack gains a +5 competence bonus to Knowledge (Streetwise and Local) checks to find the black market in a settlement.

Hardy

At 5th level, a Barter Jack gains a +4 bonus to Fortitude saves to resist severe weather conditions.

Restricted Permit

At 7th level, the Barter Jack's License Permit ability improves. He can now transport restricted items.

Windfall

At 7th level and 10th level, a Barter Jack receives Windfall as a bonus feat.

Military Permit

At 10th level, the Barter Jack's License Permit ability improves. He can now transport military items.

◆ COLONIAL LEADER

Colonial leaders are those with the leadership skills, dedication, and organizational ability to lead a group of people from a struggling settlement to a society of peace and prosperity. Colonial leaders are always among their people and do not separate themselves from those they rule. The colonial leader works alongside everyone else, doing whatever needs to be done to keep the colony alive. The colonial leader must also make decisions about the whole of the colony and cannot be afraid to make hard decisions. In newly settled colonies, often a few must suffer so many may live.

Select this advanced class if you want to be an effective leader for a people of limited means and to eventually hold a position of power among them. This



advanced class eventually grants a number of followers and an entire community to lead, so this class is not a good choice for characters that wander widely or spend lots of time off-world.

The fastest path to this advanced class is the Charismatic and Dedicated hero classes, and levels must be taken in both to meet the requirements of this class.

Requirements

To become a Colonial Leader, a character must fulfill the following criteria.

Skills: Diplomacy: 4 ranks, Intimidate: 4 ranks, Sense Motive: 4 ranks.

Charismatic Hero Talent: Coordinate.

Dedicated Hero Talent: Empathy, Improved Aid Another.

Allegiance: The Colonial Leader must pledge his primary allegiance to a group that has interests in helping the colonies of Eos survive, such as the Dawning Star Republic, the faction-camps, or the Eos Freedom League.

Class Information

The following information pertains to the Colonial Leader advanced class.

Hit Die

The Colonial Leader gains 1d6 hit points per level. The character's Constitution modifier applies.

Action Points

The Colonial Leader gains a number of action points equal to 6 + one-half his character level, rounded down, every time he attains a new level in this class.

Class Skills

The Colonial Leader's class skills are as follows.

Barter (Cha), Bluff (Cha), Computer Use (Int), Craft (Any)(Int), Diplomacy (Cha), Drive (Dex), Gather Information (Cha), Intimidate (Cha), Knowledge (Behavioral Sciences, Business, Civics, Current Events)(Int), Pilot (Dex), Profession (Wis), Repair (Int), Ride (Dex), Search (Int), Sense Motive (Wis), Spot (Wis), Survival (Wis), Treat Injury (Wis).

Skill Points at Each Level: 7 + Int modifier (6 + Int modifier for nonhumans).

Class Features

The following class features pertain to the Colonial Leader advanced class.

Organization

Beginning at 1st level, when the Colonial Leader is involved in a skill check where characters are using the Aid Another option, he can direct the efforts of the entire group, reducing the time needed to make the check by 25%, instead of lending his aid to the skill check.

Force of Law

At 1st level, the Colonial Leader is a recognized officer of a political entity, such as the Dawning Star Republic or the Roger's Point faction-camp. Within the bounds of that area, the Colonial Leader is considered an officer of the law with the power to arrest lawbreakers and try them, if the circumstances prevent a jury trial. If

the Colonial Leader is found to have abused this power, it will be stripped and the character cannot advance in this class until he proves to the political entity sponsoring him he can be trusted again. If the Colonial Leader is caught breaking the law, his powers are likely to be stripped as well, though extenuating circumstances may spare him from such punishment.

Aid the Workers

Beginning at 2nd level, if the Colonial Leader spends a day among the workers of a community encouraging and helping the workers, they get a +2 morale bonus to Craft and Profession skill checks made that day. If the Colonial Leader continues this activity for a month in the same community, those benefiting from his influence get a +2 bonus to their Craft or Profession checks to increase their Wealth score next time they go up a level.

Bonus Feats

At 3rd, 6th and 9th level, the Colonial Leader gets a bonus feat. The bonus feat must be selected from the following list, and the Colonial Leader must be able to meet all the prerequisites of the feat to select it.

Aircraft Operation, Attentive, Brawl, Builder, Confident, Dawning Star Familiarity, Deceptive, Educated, Endurance, Faction-Camp Familiarity, Great Fortitude, Gearhead, Iron Scar Familiarity, Iron Will, Oathbound, Personal Firearms Proficiency, Public Speaker, Renown, Republic Militia Member, Street Irregulars, Surface Vehicle Operation, Trustworthy, Windfall.

Attaché

At 4th level, the Colonial Leader is assigned an attaché to act as his assistant. This attaché is

COLONIAL LEADER

Class Level	Base Attack Bonus	Fort Save	Ref Save	Will Save	Special	Defense Bonus	Reputation
1 st	+0	+1	+0	+2	Organization, Force of Law	+0	+2
2 nd	+1	+2	+0	+3	Aid the Workers	+1	+2
3 rd	+1	+2	+1	+3	Bonus Feat	+1	+2
4 th	+2	+2	+1	+4	Attaché	+1	+3
5 th	+2	+3	+1	+4	Security Team	+2	+3
6 th	+3	+3	+2	+5	Bonus Feat	+2	+3
7 th	+3	+4	+2	+5	Community Leader	+2	+4
8 th	+4	+4	+2	+6	Prosperity	+2	+4
9 th	+4	+4	+3	+6	Bonus Feat	+3	+4
10 th	+5	+5	+3	+7	Word of Law	+3	+5

an Ordinary NPC, with a character level equal to the Colonial Leader's class level. The Colonial Leader can create the attaché with gamemaster approval. The attaché comes equipped with six items of the Colonial Leader's choice none of which can have a higher purchase DC than 20, but these may not be sold without the approval of the governing political entity. The attaché is a bureaucrat, diplomat, law enforcement officer, or some similar occupation that will assist the Colonial Leader in his duties. The attaché will be loyal to the Colonial Leader as long as the Colonial Leader treats the attaché well and is loyal to the political entity that they both serve. The attaché will not enter combat unless he has proper training and will not give his life for the Colonial Leader, but may risk it if the Colonial Leader has treated the attaché well. If the attaché is killed, he will not be replaced unless the Colonial Leader can convince the political entity he works for that the death was unavoidable or not his fault.



Security Team

At 5th level, the Colonial Leader is assigned a squad of security personnel to assist in his duties. This security team is primarily made up of law enforcement officers, but may also have medics, computer experts, or other specialists approved by the gamemaster. The security team members are Strong, Fast, or Tough Ordinaries with a level equal to the Colonial Leader's class level -1. The security team has a number of members equal to the Colonial Leader's Charisma bonus. Each security team member comes equipped with six items of the Colonial Leader's choice none of which can have a higher purchase DC than 20, but these may not be sold without the approval of the governing political entity. The security team will risk their lives for the Colonial Leader, but will not engage in suicidal behavior. If any members of the security team are killed, they will be replaced within 1d4 weeks, assuming the Colonial Leader can convince his sponsoring political entity that their deaths were unavoidable or served the greater good.

Community Leader

At 7th level, the Colonial Leader assumes leadership of a particular settlement. The settlement has 3d4 x 100 inhabitants and has been recently settled in a previously unclaimed region of the planet. The Colonial Leader must spend at least 20 hours a week seeing to the needs of the community. As long as he does so, he receives a +2 bonus to all Charisma-based skill checks when dealing with members of the community, and his Wealth and Reputation bonus both increase by +2. For each week the Colonial Leader completely neglects his community, his Wealth and Reputation decrease by -1. This penalty is reversed at a rate of -1 for each consecutive week the Colonial Leader spends tending to the needs of the community. Within the community, the Colonial Leader is the top governmental authority and can pass and enforce simple laws, act as judge and jury as required, collect taxes, and declare states of emergency. The community initially starts with an attitude of friendly towards the Colonial Leader and his allies, but despotic behavior, poor law enforcement, or high taxes can quickly erode this goodwill. Each week the community is ignored by the Colonial Leader, their attitude towards him worsens by one level. If it ever reaches hostile the Colonial Leader is removed by the governing political entity or by revolt, and he is not assigned another community until he gains another level and proves himself to be a better leader.

The exact behavior of the community and its

inhabitants need not be dealt with in great detail. The community should provide the Colonial Leader with a place to rest, a number of helpful allies among the populace, and a possible source of revenue if he works on making the community productive.

Alternatively, the Colonial Leader may elect not to become a community leader. Instead, he chooses a pay increase, and his Wealth bonus increases by +3.

Prosperity

At 8th level, the Colonial Leader is a master of organization and economic skills. If he is a community leader, the Wealth bonus of everyone in his community increases by +2, and their attitude towards him improves by one level as the Colonial Leader's mercantile savvy helps the local economy. This bonus affects the Colonial Leader and any of his allies who reside in the town for six months or more. If the Colonial Leader is not a community leader, his Wealth bonus increases by +3.

Word of Law

At 10th level, the Colonial Leader can nationalize businesses and vehicles, deputize posses, and take control of emergency situations within the boundaries of the political entity he works for. In essence, his word is law within the region. If this ability is abused or used in any situation other than a dire emergency, this class ability is stripped from him along with the following class abilities if the transgression is serious: Community Leader, Prosperity, Security Team, and Attaché.

◆ GUNHAND

Part outlaw, part security guard, part lawman for hire—gunhands are wandering mercenaries who make their living selling their skills with firearms to the people of Eos. Gunhands are hired to carry out all manner of duties, from raiding rival settlements to guarding Eos Freedom League facilities to serving as temporary deputies in Dawning Star Republic settlements. Much like the ronin of old, gunhands are masterless warriors who must follow their own morals when choosing and refusing jobs. Some follow strict rules and only work for certain honorable clients, while others are little more than professional bandits looking for a veneer of respectability. Most gunhands take their reputations very seriously, and most have equal concern for the reputation of their profession as well. It is not uncommon for gunhands to duel over blown contracts, client betrayals, or simple incompetence. The life of a gunhand is often short and violent, but equally often it is a life of wealth and adventure.

Select this advanced class if you want your char-

acter to be a gun-toting wanderer who walks both sides of the law.

The quickest path to this advanced class is through the Tough Hero basic class.

Requirements

To become a Gunhand, a character must fulfill the following criteria.

Base Attack Bonus: +3.

Skills: Intimidate 4 ranks.

Feat: Weapon Focus (Any Firearm).

Class Information

The following information pertains to the Gunhand advanced class.

Hit Die

The Gunhand gains 1d8 hit points per level. The character's Constitution modifier applies.

Action Points

The Gunhand gains a number of action points equal to 6 + one half his character level, rounded down, every time he attains a new level in this class.

Class Skills

The Gunhand's class skills are as follows.

Bluff (Cha), Craft (Mechanical), Drive (Dex), Gamble (Wis), Gather Information (Cha), Intimidate (Cha), Knowledge (Local, Streetwise), Listen (Wis), Ride (Dex), Sense Motive (Wis), Spot (Wis), Survival (Wis), Treat Injury (Wis).

Skill Points at Each Level: 5 + Int modifier (4 + Int modifier for nonhumans).

Class Features

The following class features pertain to the Gunhand advanced class.

Quick Draw

At 1st level, a Gunhand gains the Quick Draw feat as a bonus feat.

Tough as Nails

Beginning at 1st level, a Gunhand may spend an action point to add his class level to his Massive Damage Threshold for one round. This bonus lasts until the Gunhand's next turn. Using this ability is a free action and may be done in reaction to an attack. The Gunhand may decide to use this ability after the amount of damage is determined.

Weapon Specialization

At 2nd level, a Gunhand gains weapon specialization with a specific firearm type that he has

GUNHAND

Class Level	Base Attack Bonus	Fort Save	Ref Save	Will Save	Special	Defense Bonus	Reputation
1 st	+1	+1	+0	+0	Quick Draw, Tough as Nails	+1	+0
2 nd	+2	+2	+0	+0	Weapon Specialization	+1	+0
3 rd	+3	+2	+1	+1	Bonus Feat	+2	+0
4 th	+4	+2	+1	+1	Signature Firearm (+1)	+2	+0
5 th	+5	+3	+1	+1	Frightening Presence	+3	+1
6 th	+6	+3	+2	+2	Bonus Feat	+3	+1
7 th	+7	+4	+2	+2	Speed Draw	+4	+1
8 th	+8	+4	+2	+2	Signature Firearm (+2)	+4	+1
9 th	+9	+4	+3	+3	Bonus Feat	+5	+2
10 th	+10	+5	+3	+3	Danger Sense	+5	+2

applied the Weapon Focus feat to, e.g., EDF-9 auto-pistols. He gets a +2 bonus on damage rolls with the chosen type of firearm.

Bonus Feat

At 3rd, 6th and 9th level the Gunhand gets a bonus feat. The bonus feat must be selected from the following list, and the Lawman must be able to meet all the prerequisites of the feat to select it.

Advanced Firearms Proficiency, Alertness, Archaic Weapon Proficiency, Armor Proficiency (Light), Armor Proficiency (Medium), Blind-fight, Brawl, Combat Expertise, Combat Reflexes, Confident, Dodge, Endurance, Eos Freedom League Member, Faction-Camp Familiarity, Great Fortitude, Improved Brawl, Improved Damage Threshold, Improved Initiative, Lightning Reflexes, Low Profile, Mounted Combat, Mounted Gunplay, Point Blank Shot, Precise Shot, Quick Reload, Renown, Surface Vehicle Operation, Toughness, Track, Weapon Focus.

Signature Firearm

At 4th level, a Gunhand selects a specific firearm, which becomes his signature weapon. This must be a specific weapon, such as a Gunhand's favorite EDF-9 auto-pistol, not all EDF-9 auto-pistols. When using the signature weapon, the Gunhand gets a +1 bonus on attack and damage rolls. This bonus increases to +2 at 8th level.

If a Gunhand loses his signature firearm, he loses this class ability until he chooses another firearm and uses it for at least six months.

Frightening Presence

At 5th level, a Gunhand gains the Frightful Presence feat even if he does not meet the prerequisites for it.

Speed Draw

Beginning at 7th level, a Gunhand can add a bonus to his initiative check by subtracting a penalty from all his attacks during the first round of combat. For each -1 penalty he subtracts from his attacks, the Gunhand gains a +1 bonus to his initiative check. The Gunhand may gain a maximum +5 bonus to initiative in this manner.

Danger Sense

At 10th level, the Gunhand gains a +4 bonus to all Listen and Spot checks to avoid being surprised.



◆ **LAWMAN**

Outside the bounds of the city of Dawning Star, the rule of law is like that of the Wild West. Justice is usually served only by the strong. Being sheriff means you have to be fast on the draw and able to stare down a crowd of angry drunks instead of shooting them full of holes. The job of lawman on Eos is a rough one. Often, you must act as judge, jury and executioner and explain yourself after the fact to some Dawning Star bureaucrat who's never had a bullet in his gut. Lawmen don't always do things by the book, but they get results. It requires people of strong character and morals to enforce the laws outside of Dawning Star.

Select this class if you want to be a hard-edged lawman who deals out justice with an icy stare, a clenched fist, and sometimes through the barrel of a gun.

The fastest path to this class is from the Tough hero basic class, though other paths are possible.

Requirements

To become a Lawman, a character must fulfill the following criteria.

Base Attack Bonus: +3.

Skills: Intimidate 4 ranks, Knowledge (Streetwise or Civics) 4 ranks.

Feat: Personal Firearms Proficiency.

Class Information

The following information pertains to the Lawman advanced class.

Hit Die

The Lawman gains 1d8 hit points per level. The character's Constitution modifier applies.

Action Points

The Lawman gains a number of action points equal to 6 + one half his character level, rounded down, every time he attains a new level in this class.

Class Skills

The Lawman's class skills are as follows.

Bluff (Cha), Demolitions (Int), Diplomacy (Cha), Disable Device (Int), Drive (Dex), Forgery (Int), Gather Information (Cha), Intimidate (Cha), Investigate (Int), Knowledge (Civics, Current Events, History, Streetwise)(Int), Listen (Wis), Pilot (Dex), Research (Int), Ride (Dex), Search (Int), Sense Motive (Wis), Spot (Wis), Survival (Wis), Treat Injury (Wis).

Skill Points at Each Level: 5 + Int modifier (4 + Int modifier for nonhumans).

Class Features

The following class features pertain to the Lawman advanced class.

Force of Law

At 1st level, the Lawman is a recognized officer of a political entity, such as the Dawning Star Republic or the Roger's Point faction-camp. Within the bounds of that area, the Lawman is considered an officer of the law with the power to arrest lawbreakers and try them, if the circumstances prevent a jury trial. If the Lawman is found to have abused this power, it will be stripped and the character cannot advance in this class until he proves to the political entity sponsoring him he can be trusted again. If the Lawman is caught breaking the law, his powers are likely to be stripped as well, though extenuating circumstances may spare him from such punishment.

Weapon Focus

At 1st level, a Lawman gains the Weapon Focus feat as a bonus feat.

Legwork

At 2nd level, a Lawman receives a +2 competence bonus to Gather Information, Investigate, and Research skill checks.

Bonus Feats

At 3rd, 6th and 9th level the Lawman gets a bonus feat. The bonus feat must be selected from the following list, and the Lawman must be able to meet all the prerequisites of the feat to select it.

Advanced Firearms Proficiency, Alertness, Archaic Weapons Proficiency, Armor Proficiency (Light), Armor Proficiency (Medium), Attentive, Brawl, Confident, Dawning Star Familiarity, Deceptive, Faction-Camp Familiarity, Frightful Presence, Great Fortitude, Heroic Surge, Improved Brawl, Improved Damage Threshold, Improved Initiative, Iron Scar Familiarity, Iron Will, Mounted Combat, Mounted Gunplay, Oathbound, Point Blank Shot, Renown, Republic Militia Member, Quick Draw, Surface Vehicle Operation, Track, Trustworthy, Weapon Focus.

Weapon Specialization

At 4th level, a Lawman gains weapon specialization with a specific melee or ranged weapon that he has applied the Weapon Focus feat to. He gets a +2 bonus on damage rolls with the chosen weapon.

Grit Your Teeth

At 5th level, a Lawman gains damage reduction 1/-. This stacks with damage reduction from other sources. Also, the Lawman's Constitution

LAWMAN

Class Level	Base Attack Bonus	Fort Save	Ref Save	Will Save	Special	Defense Bonus	Reputation
1 st	+0	+2	+0	+1	Force of Law, Weapon Focus	+1	+0
2 nd	+1	+3	+0	+2	Legwork	+2	+0
3 rd	+2	+3	+1	+2	Bonus Feat	+2	+1
4 th	+3	+4	+1	+2	Weapon Specialization	+3	+1
5 th	+3	+4	+1	+3	Grit Your Teeth	+3	+1
6 th	+4	+5	+2	+3	Bonus Feat	+3	+2
7 th	+5	+5	+2	+4	Deputy	+4	+2
8 th	+6	+6	+2	+4	Word of Law	+4	+2
9 th	+6	+6	+3	+4	Bonus Feat	+5	+3
10 th	+7	+7	+3	+5	Improved Reaction	+5	+3

score enjoys a +2 bonus for purposes of determining his massive damage threshold.

Deputy

At 7th level, a Lawman is assigned a deputy from the ranks of those awaiting assignment to their own region as a sheriff or other officer of the law. This deputy is a Hero of equal level to the Lawman's class level. The deputy comes equipped with a sidearm, a suit of light armor, and 6 other items of the sheriff's choice, none of which can have a higher purchase DC than 18. The deputy will not sell any of these items unless absolutely necessary. The deputy will be loyal to the Lawman as long as he is well treated and will risk his life for the Lawman and to enforce the law. If the deputy leaves because of poor treatment or if he is killed, the Lawman does not receive a replacement.

Word of Law

At 8th level, the Lawman can nationalize businesses and vehicles, deputize posses, and take control of emergency situations within the boundaries of the political entity he works for. In essence, his word is law within the region. If this ability is abused or used in any situation other than a dire emergency, this class ability is stripped from him along with the following class abilities if the transgression is serious: Force of Law and Deputy.

Improved Reaction

At 10th level, a Lawman gains a +2 competence bonus on initiative checks.

◇ RANCHER

With the rise of the murcow industry, ranchers have become one of the mainstays of food production on Eos. Charged with tending and protecting herds of thousands of murcows as they travel from

one grazing area to the next, ranchers have to keep an eye out for wild Dawson dragons, poachers, storms, and numerous other threats to the herd. Most are excellent riders, and it is rare to find a rancher without a sidearm strapped to his hip. Ranchers are self-reliant outdoorsmen, many of whom would never be at home in the steel canyons of Dawning Star. Instead, they prefer the open plains and sleeping under the stars, even if it means getting rained on occasionally.

Select this class if you want to be an outdoor oriented character with strong riding and combat skills. If you think riding the range on another planet herding alien cows sounds like an interesting life, this class is for you.

The fastest path into this advanced class is from the Fast hero basic class, though other paths are possible.

Requirements

To become a Rancher, a character must fulfill the following criteria.

Base Attack Bonus: +3.

Skills: Ride 6 ranks, Survival 4 ranks.

Feats: Mounted Combat, Personal Firearms Proficiency.

Class Information

The following information pertains to the Rancher advanced class.

Hit Die

The Rancher gains 1d10 hit points per level. The character's Constitution modifier applies.

Action Points

The Rancher gains a number of action points equal to 6 + one-half his character level, rounded down, every time he attains a new level in this class.

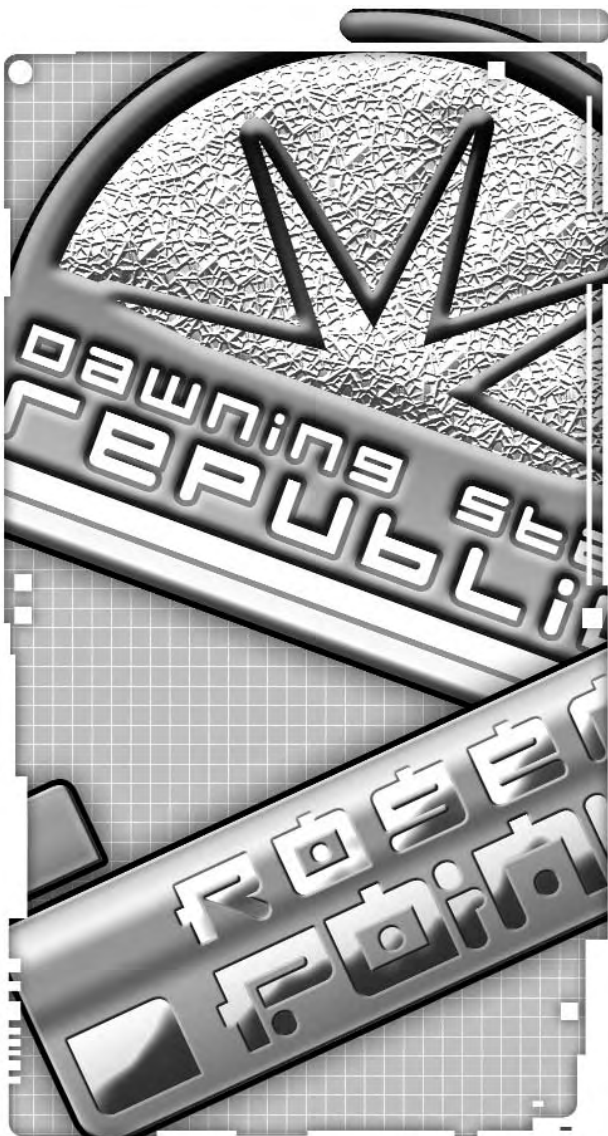

Rancher's guidance. At 1st level, the Rancher's primary mount, which he must have owned for at least six months, receives bonuses according to the table below based on the Rancher's level. These bonuses represent constant training on the part of the Rancher and are not supernatural abilities. A Rancher's special mount may be taught twice as many tricks as normal for a creature of its Intelligence. When riding his special mount, the rancher gains a +2 bonus to Ride checks.

SPECIAL MOUNT

Rancher Level	Bonus HD	Natural Armor Bonus	Str/Dex Bonus
1-2	+2	+2	+1
3-5	+4	+4	+2
6-10	+6	+6	+3

Riding Mastery

Beginning at 1st level, the Rancher may take 10 on Ride checks even when distracted or under duress.

Region Familiarity

At 2nd and 8th level, a Rancher becomes very familiar with a specific geographic region. This region should be no more than 10,000 square miles and contain no more than 100,000 people. The region should be a recognizable area, such as the lands surrounding Roger's Point, the Bergan Lowlands, or the Northern Resource Zone. When traveling in this region, the Rancher receives a +2 competence bonus to Barter, Gather Information, Knowledge (Local), Navigate, and Survival skill checks.

Bonus Feats

At 3rd, 6th and 9th level, a Rancher gets a bonus feat. The bonus feat must be selected from the following list, and the Rancher must be able to meet all the prerequisites of the feat to select it.

Advanced Firearms Proficiency, Alertness, Animal Affinity, Archaic Weapons Proficiency, Armor Proficiency (Light), Armor Proficiency (Medium), Brawl, Confident, Dodge, Endurance, Faction-Camp Familiarity, Great Fortitude, Heroic Surge, Improved Brawl, Improved Damage Threshold, Improved Initiative, Iron Scar Familiarity, Iron Will, Mounted Gunplay, Point Blank Shot, Republic Militia Member, Resource Zone Familiarity, Quick Draw, Quick Reload, Run, Surface Vehicle Operation, Toughness, Track, Weapon Focus.

Class Skills:

The Rancher's class skills are as follows.

Barter (Cha), Climb (Str), Drive (Dex), Gamble (Wis), Handle Animal (Cha), Hide (Dex), Intimidate (Cha), Jump (Str), Knowledge (History, Local) (Int), Listen (Wis), Move Silently (Dex), Pilot (Dex), Ride (Dex), Search (Int), Spot (Wis), Survival (Wis), Swim (Str), Treat Injury (Wis).

Skill Points at Each Level: 5 + Int modifier (4 + Int modifier for nonhumans).

Class Features

The following class features pertain to the Rancher advanced class.

Special Mount

A mount chosen by a Rancher is of the highest quality, or quickly becomes so under the

RANCHER

Class Level	Base Attack Bonus	Fort Save	Ref Save	Will Save	Special	Defense Bonus	Reputation
1 st	+0	+2	+0	+1	Special Mount, Riding Mastery	+1	+0
2 nd	+1	+3	+0	+2	Region Familiarity	+2	+0
3 rd	+2	+3	+1	+2	Bonus Feat	+2	+0
4 th	+3	+4	+1	+2	Wild Empathy	+3	+0
5 th	+3	+4	+1	+3	Improved Mounted Combat	+3	+1
6 th	+4	+5	+2	+3	Bonus Feat	+3	+1
7 th	+5	+5	+2	+4	Region Familiarity	+4	+1
8 th	+6	+6	+2	+4	Survival Mastery	+4	+1
9 th	+6	+6	+3	+4	Bonus Feat	+5	+2
10 th	+7	+7	+3	+5	Weather Resistant	+5	+2

Wild Empathy

At 4th level, a Rancher can improve the attitude of an animal. This ability functions just like a Diplomacy check to improve the attitude of a person. The Rancher rolls 1d20 and adds his Rancher level and his Charisma bonus to determine the wild empathy check result. The typical domestic animal has a starting attitude of indifferent, while wild animals are usually unfriendly. To use wild empathy, the Rancher and the animal must be able to study each other, which means that they must be within 30 feet of one another under normal visibility conditions. Generally, influencing an animal in this way takes 1 minute, but, as with influencing people, it might take more or less time.

If the Rancher already has the Wild Empathy ability from the Animal Husbandry Talent Tree, he adds his Rancher and Charismatic Hero levels together when making Wild Empathy checks.

Improved Mounted Combat

Beginning at 5th level, a Rancher may make two Ride checks a round to block attacks against his mount via the Mounted Combat feat. He uses the higher of the two rolls to determine if he is successful.

Survival Mastery

Beginning at 8th level, a Rancher can take 10 on Survival skill checks regardless of duress or distraction.

Weather Resistant

At 10th level the Rancher gains damage reduction 2/- against damage caused by weather or other environmental conditions.

◇ REBUILDER

While the job description of a Dawning Star Rebuilder seems boring, the job itself rarely is. Dawning Star Rebuilders are city employees charged with keeping the city in good repair, adding new areas to the city as resources become available, responding to power outages and similar issues, and keeping the city free of pests. Due to the makeshift nature of many of Dawning Star's buildings and the wide variety of alien life forms that have flourished in the city, Rebuilders often do a lot more than shore up roofs and repair wiring. Without the Rebuilders, the city would quickly grind to a halt. Unfortunately, Rebuilders do not get much respect for their hours of hard work, most people thinking them simple handymen or sanitation workers. Any sanitation worker who has to clear out a lair of spitter spiders to get his job done is one tough sanitation worker.

Select this advanced class if you want to be a rough and tumble technician always ready to whack troublesome critters with a wrench and perfectly at home fixing machines in the middle of a firefight.

The quickest route to this advanced class is the Smart Hero basic class, but other routes are possible.

Requirements

To become a Rebuilder, a character must fulfill the following criteria.

Skills: Repair 6 ranks, Craft (Structural) 4 ranks.

Feat: Dawning Star Familiarity.

Allegiance: Dawning Star Republic.

Class Information

The following information pertains to the Rebuilder advanced class.

Hit Die

The Rebuilder gains 1d8 hit points per level. The character's Constitution modifier applies.

Action Points

The Rebuilder gains a number of action points equal to 6 + one-half her character level, rounded down, every time she attains a new level in this class.

Class Skills

The Rebuilder's class skills are as follows.

Climb (Str), Computer Use (Int), Concentration (Con), Craft (Any)(Int), Demolitions (Int), Disable Device (Int), Drive (Dex), Investigate (Int), Jump (Str), Knowledge (Current Events, Local, Popular Culture, Technology) (Int), Navigate (Int), Pilot (Dex), Profession (Wis), Repair (Int), Research (Int), Search (Int), Spot (Wis), Swim (Str).

Skill Points at Each Level: 7 + Int modifier (6 + Int modifier for nonhumans).

Class Features

The following class features pertain to the Rebuilder advanced class.

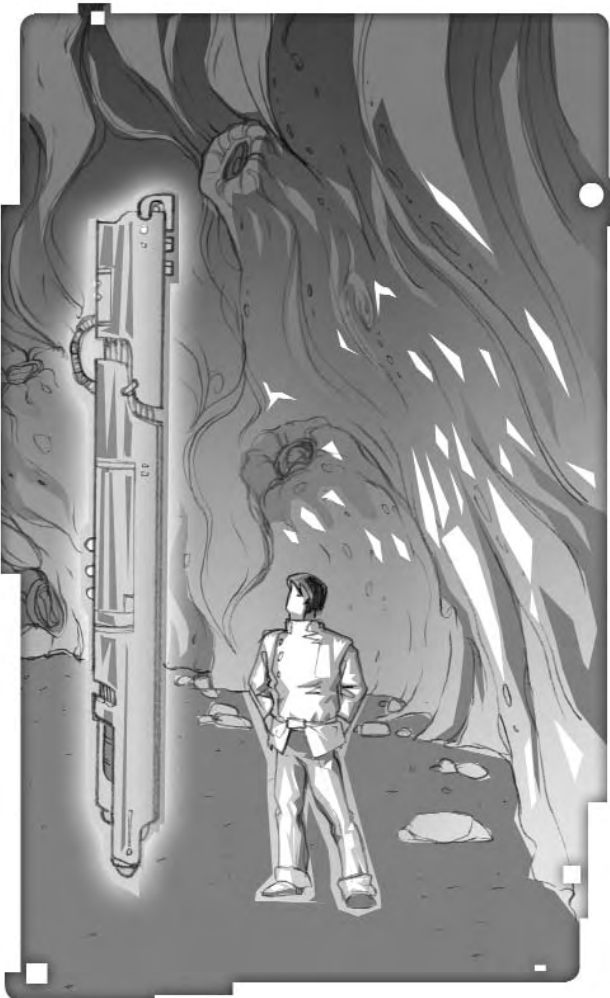

Blind-Fight

At 1st level, a Rebuilder gains the Blind-Fight feat as a bonus feat.

Dawning Star Systems Expert

Beginning at 1st level, a Rebuilder gains a bonus to all Repair and Craft checks to repair damage to Dawning Star equal to his Rebuilder level.

Government Issue

At 1st level, a Rebuilder is issued a small amount of equipment by the Dawning Star government to assist her in her job. This includes a Rebuilder uniform, a suit of light combat armor, display glasses, 100 ft. of duracable, a portable glow lamp, a fusion torch, a knife, a daypack, a PDA, a two-way radio set, bolt-cutters, a demolitions kit, a basic electrical toolkit, a basic mechanical toolkit, a search-and-rescue kit, climbing gear, gas mask, GPS receiver, an EDF-9 auto pistol with 3 clips, and a large aluminum travel case to carry it all in. Technically, the equipment is owned by the government, so it may not be sold. If lost or damaged, it will be replaced, but losing items repeatedly may mean the Rebuilder stops receiving replacement equipment.

Tool Weapons

Beginning at 2nd level, a Rebuilder may wield ordinary tools, such as screwdrivers and wrenches, as weapons without suffering any penalties for using an improvised weapon. Essentially, the Rebuilder gains weapon proficiency in tools. Generally, these weapons do 1d6 points of damage for medium wielders or 1d4 for small wielders, are considered light weapons, and have a critical threat of 20

Bonus Feats

At 3rd, 6th and 9th level, a Rebuilder gets a bonus feat. The bonus feat must be selected from the following list, and the Rebuilder must be able to meet all the prerequisites of the feat to select it.

Armor Proficiency (Light), Brawl, Builder, Cautious, Combat Expertise, Combat Reflexes, Craftsman, Defensive Martial Arts, Dodge, Educated, Endurance, Gearhead, Great Fortitude, Improved Initiative, Lightning Reflexes, Mastercrafter, Master Craftsman, Personal Firearms Proficiency, Quick Draw, Street Irregulars, Surface Vehicle Operation, Toughness.

Improved Dawning Star Familiarity

At 4th level, the Rancher's skill bonuses from the Dawning Star Familiarity feat are increased to +2. This ability has no effect on the Rebuilder's Wealth bonus.

REBUILDER

Class Level	Base Attack Bonus	Fort Save	Ref Save	Will Save	Special	Defense Bonus	Reputation
1 st	+0	+1	+0	+1	Blind-fight, Government Issue, Dawning Star Systems Expert	+1	+0
2 nd	+1	+2	+0	+2	Tool Weapons	+2	+0
3 rd	+2	+2	+1	+2	Bonus Feat	+2	+0
4 th	+3	+2	+1	+2	Improved Dawning Star Familiarity	+3	+0
5 th	+3	+3	+1	+3	Quick Fix, Unflustered	+3	+1
6 th	+4	+3	+2	+3	Bonus Feat	+3	+1
7 th	+5	+4	+2	+4	Skilled Searcher, Surprise Sense (+2)	+4	+1
8 th	+6	+4	+2	+4	Sworn Enemy	+4	+1
9 th	+6	+4	+3	+4	Bonus Feat	+5	+2
10 th	+7	+5	+3	+5	Disease and Poison Resistance, Surprise Sense (+4)	+5	+2

Quick Fix

At 5th level, the Rebuilder can repair a mechanical or electrical device in half the normal time. Cutting the repair time in this way increases the Repair check DC by +5.

Unflustered

By concentrating, a 5th-level Rebuilder can perform complicated tasks without provoking attacks of opportunity from adjacent foes. During any round in which the Rebuilder uses the Computer Use, Craft, Demolitions, Disable Device, or Repair skill, she can first make a Concentration check (DC 15) to use the desired skill without provoking attacks of opportunity. Making the Concentration check doesn't cost the Rebuilder an action. She may take 10 on the Concentration check, but she cannot take 20.

Skilled Searcher

When actively searching for secret doors, traps, or similar features, a Rebuilder of 7th level or higher gains a bonus on her Search checks equal to one-half her Rebuilder class level (rounded down).

Surprise Sense

At 7th level, a Rebuilder gains a +2 bonus to Spot and Listen checks to avoid being surprised. This bonus increases to +4 at 10th level.

Sworn Enemy

At 8th level, a Rebuilder can select either vermin or animals as creatures that have earned his ire and scorn. The Rebuilder gains a +2 bonus on

Bluff, Listen, Sense Motive, Spot, and Survival checks when using these skills against the chosen creature type. Additionally, she gets a +2 bonus on weapon damage rolls against those of the chosen creature type.

Disease and Poison Resistance

At 10th level, a Rebuilder gains a +2 bonus to Fortitude saves against poison, disease, and toxic materials.

◇ VELIN GUARDIAN

The velin live in the wilds of Eos where there are numerous dangers unknown to the human colonists. For protection and leadership in times of conflict, the velin tribes look to the Guardians, a group of warriors trained to become elite hunters. The Guardians are some of the best trained trackers, hunters, and guerilla fighters on Eos, second only to the velin vaasi hunters. While traditionally the Guardians deal with wildlife and similar threats, more and more in the past year they have had to deal with human transgressions. Despite their primitive technology the Guardians can pose quite a threat to humans, especially given their knowledge of the area and ability to move quickly and quietly. A few humans have been honored with the title of Guardian among the velin in exchange for great favors done for the tribes.

Select this advanced class if you want your character to be skilled in archaic weapons, stealth, and survival skills in addition to special training against the hated vaasi.

The fastest path into this advanced class is from the Strong or Dedicated hero basic classes, though other paths are possible.

Requirements

To become a Velin Guardian, a character must fulfill the following criteria.

Special: Must be velin or have the Velin Tribal Guest feat.

Base Attack Bonus: +3.

Skills: Hide 4 ranks, Move Silently 4 ranks, Survival 6 ranks.

Allegiance: Velin Tribe or Velin Tribal Council.

Class Information

The following information pertains to the Velin Guardian advanced class.

Hit Die

The Velin Guardian gains 1d8 hit points per level. The character's Constitution modifier applies.

Action Points

The Velin Guardian gains a number of action points equal to 6 + one-half his character level, rounded down, every time he attains a new level in this class.

Class Skills

The Velin Guardian's class skills are as follows.

Balance (Dex), Climb (Str), Concentration (Con), Craft (Tribal) (Int), Handle Animals (Cha), Hide (Dex), Intimidate (Cha), Jump (Str), Knowledge (History, Local) (Int), Listen (Wis), Move Silently (Dex), Navigate (Wis), Ride (Dex), Spot (Wis), Survival (Wis), Swim (Str), Treat Injury (Wis).

Skill Points at Each Level: 5 + Int modifier (4 + Int modifier for nonhumans).

Class Features

The following class features pertain to the Velin Guardian advanced class.

Guardian Reputation

Beginning at 1st level the Velin Guardian receives a +2 bonus to all Charisma-based skills when interacting with velin; such is the reputation of the Guardians. If the Velin Guardian does something to betray the Guardians or the velin people, such as conspire against them with known enemies, the Velin Guardian will be hunted by his comrades and cannot take more levels in this advanced class until he finds some way to atone. This is unlikely though, since the velin do not forgive treachery easily.

Oathbound

At 1st level the Velin Guardian gains the Oathbound feat. This feat may only be applied

to a Velin Tribal Allegiance or the Velin Tribal Council allegiance.

Region Familiarity

At 2nd, a Velin Guardian becomes very familiar with a specific geographic region. Usually, this is the region inhabited by the Velin Guardian's tribe. This region should be no more than 10,000 square miles and contain no more than 100,000 people. The region should be a recognizable area, such as the lands surrounding Roger's Point, the Bergan Lowlands, or the Northern Resource Zone. When traveling in this region, the Velin Guardian receives a +2 competence bonus to Barter, Gather Information, Knowledge (Local), Navigate, and Survival skill checks.



VELIN GUARDIAN

Class Level	Base Attack Bonus	Fort Save	Ref Save	Will Save	Special	Defense Bonus	Reputation Bonus
1 st	+1	+2	+0	+0	Guardian Reputation, Oathbound	+1	+0
2 nd	+2	+3	+0	+0	Region Familiarity	+2	+0
3 rd	+3	+3	+1	+1	Bonus Feat	+2	+0
4 th	+4	+4	+1	+1	Weapon Focus	+3	+0
5 th	+5	+4	+1	+1	Wilderness Camouflage	+3	+1
6 th	+6	+5	+2	+2	Bonus Feat	+3	+1
7 th	+7	+5	+2	+2	Weapon Specialization	+4	+1
8 th	+8	+6	+2	+2	Sworn Enemy (Vaasi)	+4	+1
9 th	+9	+6	+3	+3	Bonus Feat	+5	+2
10 th	+10	+7	+3	+3	Greater Weapon Specialization	+5	+2

Bonus Feats

At 3rd, 6th and 9th level, a Velin Guardian gets a bonus feat. The bonus feat must be selected from the following list, and the Rancher must be able to meet all the prerequisites of the feat to select it.

Acrobatic, Agile Riposte, Alertness, Alien Friend, Animal Affinity, Armor Proficiency (Light), Armor Proficiency (Medium), Athletic, Blind-Fight, Brawl, Cleave, Combat Expertise, Combat Martial Arts, Defensive Martial Arts, Dodge, Exotic Melee Weapon Proficiency, Frightful Presence, Great Fortitude, Guide, Heroic Surge, Improved Damage Threshold, Improved Initiative, Improved Critical, Improved Combat Martial Arts, Improved Disarm, Iron Will, Mobility, Power Attack, Stealthy, Toughness, Track, Weapon Focus.

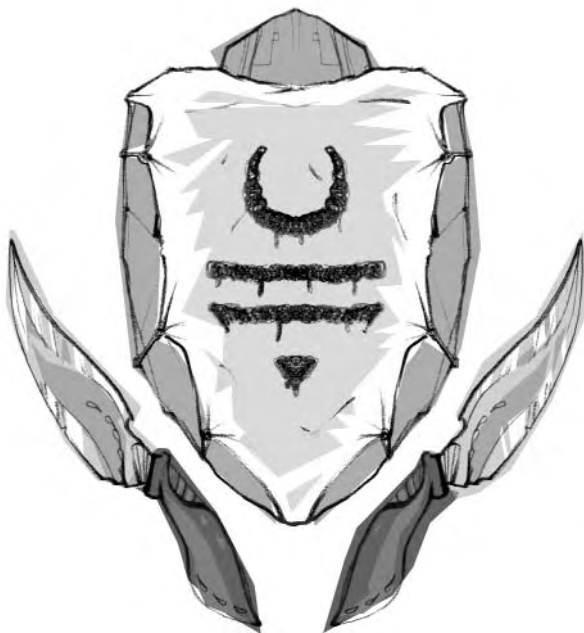

Weapon Focus

At 4th level, a Velin Guardian gains the Weapon Focus feat as a bonus feat. The weapon may not be a firearm.

Wilderness Camouflage

Beginning at 5th level, the Velin Guardian gains a +3 bonus to Hide and Move Silently checks while in wilderness areas. These bonuses do not apply in any type of settled area, such as Dawning Star or a faction-camp, but they do apply to uninhabited ruins.

Weapon Specialization

At 7th level, a Velin Guardian gains weapon specialization with a specific melee or ranged weapon that he has applied the Weapon Focus feat to, e.g., kertaff spear. He gets a +2 bonus on damage rolls with the chosen weapon.

Sworn Enemy (Vaasi)

At 8th level, a Velin Guardian receives special training for fighting against the vaasi and learns much of the lore the velin have about this evil race. The Velin Guardian gains a +2 bonus on Bluff, Listen, Sense Motive, Spot, and Survival checks when using these skills against vaasi creatures, including their servitor species. Additionally, he gets a +2 bonus on weapon damage rolls against vaasi creatures.

Greater Weapon Specialization

At 10th level, a Velin Guardian gains greater weapon specialization with the weapon he selected at 7th level. This ability increases the bonus on damage rolls to +4 when using the selected weapon.

PRESTIGE CLASSES • • •

Prestige classes represent the pinnacle of character development. Only the elite of their chosen path will achieve such heights. Following are two prestige class specifically tailored for life on Eos. DAWNING STAR: HELIOS RISING and DAWNING STAR: HEROES OF HELIOS will introduce other prestige classes.

♦ REPUBLIC RANGER

The elite law officers of the Dawning Star Republic, the Republic Rangers, have jurisdiction anywhere in the Dawning Star Republic's territory. Like the Texas Rangers or Federal Marshals of old, they cross jurisdictional boundaries without a care and have an enormous amount of clout at their command. Most of the Republic Rangers spend their time in the outer territories of the Dawning Star Republic, preferring the freedom of the less settled areas and because they are more needed there. Republic Rangers spend most of their days traveling from settlement to settlement, helping the locals deal with whatever threats or legal issues they have, and then moving on. In addition to being empowered as officers of the peace, Republic Rangers can also act as judges in a pinch in both civil and state matters, deciding matters as mundane as grazing rates, property damage, and conducting marriage ceremonies. While many inside Dawning Star think the Republic Rangers are a leftover of the colony's earliest days, those outside the city often idolize them as heroes. It is a common dream among the youngsters of the Dawning Star Republic to grow up and become a Republic Ranger. All Republic Rangers are recruited from the ranks of veteran lawman from the Dawning Star Republic and most have a wide variety of skills under their belts, having spent time as anything from ranchers to miners to air runners in their days before becoming a lawman.

Select this prestige class if you want your character to be the elite of the Dawning Star Republic's law enforcement officer, a wandering hero always ready to help keep the peace, or just deliver a baby murcow.

The fastest path into this prestige class is from the Dedicated, Tough, or Charismatic Hero basic classes and some levels must be taken in the Lawman or Colonial Leader advanced classes.

Requirements

To become a Republic Ranger, a character must fulfill the following criteria.

Base Attack Bonus: +8

Class Ability: Force of Law.

Skills: Drive, Pilot or Ride 6 ranks, Intimidate 8 ranks, Knowledge (Civics) 6 ranks.

Feat: Weapon Focus.

Allegiance: Dawning Star Republic.

Class Information

The following information pertains to the Republic Ranger prestige class.

Hit Die

The Republic Ranger gains 1d10 hit points per level. The character's Constitution modifier applies.

Action Points

The Republic Ranger gains a number of action points equal to 7 + one-half his character level, rounded down, every time he attains a new level in this class.

Class Skills

The Republic Ranger's class skills are as follows.

Bluff (Cha), Climb (Str), Computer Use (Int), Demolitions (Int), Diplomacy (Cha), Drive (Dex), Gather Information (Cha), Intimidate (Cha), Investigate (Int), Jump (Str), Knowledge (Civics, History, Local, Streetwise, Tactics), Listen (Wis), Navigate (Int), Ride (Dex), Search (Int), Sense Motive (Wis), Sleight of Hand (Dex), Spot (Wis), Survival (Wis), Swim (Str), Treat Injury (Wis).

Skill Points at Each Level: 5 + Int modifier (4 + Int modifier for nonhumans).

REPUBLIC RANGER

Class Level	Base Attack Bonus	Fort Save	Ref Save	Will Save	Special	Defense Bonus	Reputation
1 st	+1	+2	+0	+2	Word of Law, Ranger Reputation	+1	+2
2 nd	+2	+3	+0	+3	Frightful Presence, Region Familiarity	+1	+2
3 rd	+3	+3	+1	+3	Greater Weapon Focus, Posse	+2	+2
4 th	+4	+4	+1	+4	Improved Region Familiarity, Chosen Quarry	+2	+3
5 th	+5	+4	+1	+4	Shield of the Law	+3	+3

Class Features

The following class features pertain to the Republic Ranger advanced class.

Word of Law

At 1st level, the Republic Ranger can nationalize businesses and vehicles, deputize posses, and take control of emergency situations within the boundaries of the Dawning Star Republic. In essence, his word is law within the region. If this ability is abused or used in any situation other than a dire emergency, this class ability is stripped from him along with the Posse class ability if the transgression is serious.

Ranger Reputation

Beginning at 1st level, a Republic Ranger gains a +2 bonus to all Charisma-based skill checks involving citizens of the Dawning Star Republic.

Frightful Presence

At 2nd level, a Republic Ranger gains the Frightful Presence feat as a bonus feat even if he does not meet the prerequisites for it. If the Republic Ranger already has this feat, the saving throw DC to resist the feat increases by +2.

Region Familiarity

At 2nd level, a Republic Ranger becomes very familiar with a specific geographic region. This region should be no more than 10,000 square miles and contain no more than 100,000 people. The region should be a recognizable area, such as the lands surrounding Roger's Point, the Bergan Lowlands, or the Northern Resource Zone. When traveling in this region, the Republic Ranger receives a +2 competence bonus to Barter, Gather Information, Knowledge (Local), Navigate, and Survival skill checks.

Greater Weapon Focus

At 3rd level, the Republic Ranger selects a weapon for which he has the Weapon Focus. He gets an additional +1 bonus on attack rolls made with that weapon.

Posse

Beginning at 3rd level the Republic Ranger may recruit and deputize a posse at any Dawning Star Republic settlement. Doing so requires at least an hour of talking to the inhabitants of the settlement to convince them of the need for the posse. The Republic Ranger makes a Diplomacy or Intimidate check (DC 20). If the reason for the posse poses no imminent threat to the settlement (such as bandits attacking a far off settlement), the check suffers a -4 penalty. If the reason for the posse poses an imminent threat to the settlement (such as bandits



who have attacked the settlement in the past), the check gains a +4 bonus. If the check succeeds, the Republic Ranger has successfully rounded up a posse. If the check fails the Republic Ranger may spend another hour to make another attempt, but each additional attempt suffers a cumulative -2 penalty.

A posse contains a number of citizens equal to the Republic Ranger's character level + his Charisma bonus. A number of the posse members equal to the Republic Ranger's class level are 3rd level heroes, most of whom are Tough heroes, though there may be other character types at the GM's discretion. The remainder of the posse is comprised of 3rd level ordinaries, most of whom are Tough ordinaries, though there may be other character types at the GM's discretion. Hero posse members come equipped with a knife, a suit of rough-outs, and either an EDF-9 pistol, an EDF-15 rifle, or a Brase Arms Shotgun. The settlement will supply enough vehicles or mounts for the entire posse. The posse will remain loyal to the Republic Ranger for 24 hours, after which the Republic Ranger must succeed in a Diplomacy or Intimidate check (DC 20) each day to keep the posse together. This check has a cumulative -2 penalty for each day that passes. If the check fails, the posse packs up their gear and heads home immediately.

The posse will fight at the direction of the Republic Ranger but will not engage in suicidal behavior. If any members of the posse are killed, the Republic Ranger suffers a -2 penalty for each person killed on all Diplomacy or Intimidate checks keep the posse together or to form a new posse at the same settlement. Subsequent attempts to call a posse in the same town within one month suffer a -4 penalty.

Improved Region Familiarity

At 4th level, a Republic Ranger's bonus from Region Familiarity increases to +4. If the Republic Ranger has multiple instances of Region Familiarity he may only raise one region's bonus.

Chosen Quarry

Beginning at 4th level, a Republic Ranger may declare a specific outlaw or group of outlaws as his chosen quarry. This requires the Republic Ranger to spend an action point and to make a public declaration of his intention, such as stating *"I will not rest until the Besby Boys are all behind bars!"* If the quarry is a group, the group cannot be larger than 50 people in size. Once the action point is spent and the declaration made, the Republic Ranger gains a +2 bonus on Bluff, Listen, Sense Motive, Spot, and

Survival checks when using these skills against the chosen quarry. Additionally, the Republic Ranger gets a +2 bonus on weapon damage rolls against the chosen quarry.

The chosen quarry can be changed at any point, but a new action point must be spent and all benefits against the previous chosen quarry are lost. A Republic Ranger can only have one chosen quarry at a time.

Shield of the Law

Beginning at 5th level, the Republic Ranger may spend an action point to use Frightful Presence as a free action and to gain a bonus to his defense equal to his class level for one round. The Republic Ranger announces his identity and that he is an officer of the law in a loud voice, during which the Republic Ranger's badge must be visible.

◆ VELIN CHIEF

The velin are a peaceful and content people, but this does not mean leading them is easy. They are a people going through a time of dramatic change and their entire world shifts around them. Ancient evils stir, lost cousins return, and still the velin must carry on. Bearing the title of chief of a velin tribe is a solemn even holy responsibility, one that is not easily taken up and rarely cast aside.

Velin tribal chiefs are chosen by their predecessors for their wisdom, patience, and knowledge with little regard for age, sex, or profession. Most chiefs are chosen from among the war leaders, the tale-spinners, or the shamans of a tribe, but this is not a steadfast limitation. In the past, hunters, salvagers, and even outcasts have led velin tribes. Velin chiefs are selected for leadership years before they assume the formal title. During this time, the chief to be trains and prepares for that fateful day. All velin chiefs have levels in this prestige class, but not all who have levels in this class are actual leaders of tribes. Some tribal advisors and other high-ranking members within a tribe have levels in the velin chief prestige class.

If you want to play a wise tribal leader, knowledgeable of ancient lore, skilled in the ways of the wild, and steeped in the path of war, select this prestige class.

Requirements

To become a Velin Chief, a character must fulfill the following criteria.

Special: Must be velin or have the Velin Tribal Guest feat.

Skills: Diplomacy 12 ranks, Knowledge (Tribal) 12 ranks, Survival 6 ranks.

Base Will Save: +4

Allegiance: Velin Tribe or Velin Tribal Council.

Reputation Bonus: +5.

Class Information

The following information pertains to the Velin Chief advanced class.

Hit Die

The Velin Chief gains 1d6 hit points per level. The character's Constitution modifier applies.

Action Points

The Velin Chief gains a number of action points equal to 7 + one-half his character level, rounded down, every time he attains a new level in this class.

Class Skills

The Velin Chief's class skills are as follows.

Bluff (Cha), Climb (Str), Concentration (Con), Craft (tribal), Diplomacy (Cha), Handle Animals (Cha), Hide (Dex), Intimidate (Cha), Knowledge (Civics, History, Local, Velin) (Int), Listen (Wis), Move Silently (Dex), Navigate (Wis), Perform (Art, Dance, Oratory, Percussion Instruments) (Cha), Ride (Dex), Search (Int), Sense Motive (Wis), Speak Language, Spot (Wis), Survival (Wis), Swim (Str), Treat Injury (Wis).

Skill Points at Each Level: 7 + Int modifier (6 + Int modifier for nonhumans).

Class Features

The following class features pertain to the Velin Chief advanced class.

Chief Reputation

Beginning at 1st level, the Velin Chief receives a bonus equal to his class level to all Charisma-based skill checks when interacting with velin or anyone with the Velin Tribe or Velin Tribal Council allegiance. If the Velin Chief does something to betray his tribe or the velin people - such as conspiring against them with known enemies - the Velin Chief loses all class abilities except for Region Familiarity and bonus feats. Furthermore, he will be hunted as a traitor by his tribe and cannot take more levels in this advanced class until he finds some way to atone. Such atonement is unlikely though, since the velin do not forgive treachery easily.

Tribal Authority

Beginning at 1st level, the Velin Chief gains the authority to enact tribal laws, pass judgment on criminals, lead the tribe to war, and make decisions on behalf of the tribe. These decisions may be overruled or modified by higher-ranking chiefs. Initially, these decisions will be followed by the tribe without question. However, repeated bad decisions will erode the support for the Velin Chief within the tribe. Too many bad deci-



sions, especially ones that get tribe members killed, will lead to the Velin Chief losing all his class abilities except for Region Familiarity and bonus feats until he can atone for his mistakes.

Region Familiarity

At 2nd level, a Velin Chief becomes very familiar with a specific geographic region, inhabited by the Velin Chief's tribe. This region should be no more than 10,000 square miles and contain no more than 100,000 people. The region should be a recognizable area, such as the lands surrounding Roger's Point, the Bergan Lowlands, or the Northern Resource Zone. When traveling in this region, the Velin Chief receives a +2 competence bonus to Barter, Gather Information, Knowledge (Local), Navigate, and Survival skill checks.

Protect the Tribe

Beginning at 2nd level, the Velin Chief gains a +1 morale bonus on attack and damage rolls when fighting side-by-side with members of his tribe or when fighting to protect them directly. This bonus applies as long as the tribe member is within the Velin Chief's line-of-sight.

Bonus Feats

At 3rd, 6th and 9th level, a Velin Chief gets a bonus feat. The bonus feat must be selected from the following list, and the Velin Chief must be able to meet all the prerequisites of the feat to select it.

Alertness, Alien Friend, Animal Affinity, Armor Proficiency (Light), Armor Proficiency (Medium), Athletic, Blind-Fight, Brawl, Confident, Creative, Deceptive, Dodge, Exotic Weapon Proficiency, Frightful Presence, Great Fortitude, Guide, Heroic Surge, Improved Damage Threshold,

Iron Will, Medical Expert, Renown, Stealthy, Toughness, Track, Trustworthy, Weapon Focus.

Shield of Will

Beginning at 4th level, any member of a Velin Chief's tribe forced to make a Will save within 30 feet of the chief receives a morale bonus to the save. This bonus is equal to half the Velin Chief's class level. If the effect requiring the Will save also affects the Velin Chief, the tribe member only receives this bonus if the Velin Chief is successful at his Will save. This bonus does not apply to Will saves forced by the Velin Chief, such as by the Frightful Presence feat.

Lead the Way

At 5th level, tribe members following the Velin Chief cover 25% more distance during long-distance travel, receive a +2 morale bonus to saving throws against severe weather, and receive a +2 morale bonus to Constitution checks to resist starvation and dehydration.

Tribal Guard

At 7th level, the Velin Chief gains a loyal cadre of guards who have recognized the Velin Chief's greatness and seek to protect him for the good of the tribe and the velin people. The guards are all Strong, Tough, or Fast ordinaries with total character levels equal to the Velin Chief's class level. The Velin Chief gains one guard per point of Charisma bonus (minimum one). These guards come equipped with up to six items, all of which must have a purchase DC of 16 or below. All other equipment must be provided by the Velin Chief.

The guards are fanatically loyal to the Velin Chief and will remain so unless he does something to betray them or the velin people. They

VELIN CHIEF

Class Level	Base Attack Bonus	Fort Save	Ref Save	Will Save	Special	Defense Bonus	Reputation
1 st	+0	+1	+0	+1	Chief Reputation, Tribal Authority	+0	+2
2 nd	+1	+2	+0	+2	Region Familiarity, Protect the Tribe	+1	+2
3 rd	+2	+2	+1	+2	Bonus Feat	+1	+2
4 th	+3	+2	+1	+2	Shield of Will	+1	+3
5 th	+3	+3	+1	+3	Lead the Way	+2	+3
6 th	+4	+3	+2	+3	Bonus Feat	+2	+3
7 th	+5	+4	+2	+4	Tribal Guard	+2	+4
8 th	+6	+4	+2	+4	Chief of Legend, Sense Link	+3	+4
9 th	+6	+4	+3	+4	Bonus Feat	+3	+4
10 th	+7	+5	+3	+5	Crusade	+3	+5

will fight to the death to protect the Velin Chief and will sacrifice themselves willingly to serve their tribe or the velin people.

Chief of Legend

At 8th level, all velin allies within 30 feet of the Velin Chief and with line-of-sight to the Velin Chief receive a +1 morale bonus on attack and damage rolls. This bonus doubles to +2 when combating vaasi or their servitor races.

Sense Link

At 8th level, whenever any velin member of the Velin Chief's tribe detects a vaasi using the detect vaasi species ability, the Velin Chief is also aware of the vaasi presence. Additionally, if any of the Velin Chief's tribe is killed, he is instantly aware of the death and knows the distance and direction to the corpse. This ability has a range of one mile.

Crusade

At 10th level, the Velin Chief has gained enough stature and respect within the Velin Tribal Council that he can call for a crusade against the enemies of the velin. Such a crusade might be called for upon the discovery of a vaasi nest or similar threat. Doing so requires an official proclamation of a crusade, which must be carried by couriers, such as the Velin Chief's tribal

guard, to other velin settlements. For each day the Velin Chief spends assembling his army after making the call, 1d6 velin warriors arrive, with the number arriving increasing by 1d6 each day. So on the second day 2d6 arrive, 3d6 on the third day, etc. The maximum number of warriors that will answer the call is equal to the Velin Chief's character level x100.

These warriors are 3rd-level Strong, Fast, Tough, and/or Dedicated ordinaries that come equipped with velin archaic weapons and armor. These warriors will follow the orders of the Velin Chief for the first month of the crusade without question. After that time, the Velin Chief must make a Diplomacy check each day to keep the crusade together. The DC for the Diplomacy check is equal to the number of months since the call for the Crusade x 5. Also each time the warriors suffer a major defeat the Velin Chief must make another Diplomacy check against the same DC as his last monthly check to keep the crusade together.

Each month the Velin Chief keeps the crusade active his Wealth Bonus decreases by -3 due to the expense of supporting the Crusade. The Velin Chief can end the crusade at any time, but doing so without a victory under his belt or some other worthwhile accomplishment may negatively impact future calls for crusades issued by the Velin Chief.





CHAPTER 4 TECHNOLOGY

Samaire scanned the curious tableau before her. A soft melody filled her ears, some Irish folk tune with which she was not familiar. A hundred different items were laid out like jigsaw pieces on the wooden plank that served as her workbench. In fact, it was the old door from her tool shed propped up on two barrels. Springs, pins, and small bits of metal and wood were strewn about, giving no hint at what function they might serve. Samaire knew them all quite well, despite the deep crease in her brow.

She pulled one of the candles closer to gain a better look. It was scented with the oil from some native plant—a gift from Ms. Hampshire—a soothing scent, not unlike sandalwood. She plucked a smooth, metal ring from the table and rolled it between her fingers, blowing briskly to clean some of the dust from it before replacing it. Then she picked up a four-inch spring and examined it with equal scrutiny. She pursed her lips and pulled an implement from her belt. With a delicate touch, she adjusted the spring and placed it back on the workbench.

Then, she picked up the trigger plate and her small-gauge file. For a full ten minutes, she worked on the plate. The song ended, and a ghostly voice whispered to her: *"Shall I play another?"*

For a moment, Samaire was lost in a reverie, focused as she was on the task before her.

"Samaire," the voice repeated, *"shall I play another?"*

"Something different," she replied. *"Something ... electronic."*

"I've got just the thing for you." After a few moments of silence, a tune filled her ears, haunting and complex. She tapped the small, plastic bud nestled in her ear and the volume increased. Again, it was not a song she had ever heard before, but then why would she have? With every song known to man stored within the Music Bud-E™, it was a circumstance she'd grown quite accustomed to. And yet, the App-3 software technology somehow knew exactly what she would enjoy. Even, it seemed at times, more than she knew herself.

Satisfied with the state of all the components before her, Samaire began gathering them together, interlocking screws and pins, loading springs, securing pistons. When she had finished, she smiled, looking over the shotgun she held in her hands. It bore the filigreed single barrel for which she had become famous.

She placed the firearm on the workbench and strode to the fire raging at the center of her camp. A long-handled, iron brand lay orange-hot in its flames. She pulled it out and headed back to the workbench. As she burned her craftmark into the wooden stock, a gleaming light streaked across the night sky.

A star, perhaps? Or a starship?

So often, it was hard to tell the difference.

The technology of DAWNING STAR is a curious assortment of advanced tools and 19th - century devices. Ranchers ride horses armed with laser pistols, while outlying settlements often rely on candles and lanterns to save on power. Only in Dawning Star itself is the level of technology more consistent, but even there it is not uncommon to see a horse drawn wagon in the street. Due to the lack of a strong distribution system and limited industrial capacity, prices tend to fluctuate greatly on Eos. This is especially true in Iron Scar and the faction-camps, which have to purchase much of their supplies from merchants in Dawning Star.

Eos is generally at PL 6, but there are some items of PL 7 that have just come into use, such as plasma weapons. The tentaari are principally at PL 8 but have some equipment of PL 9. Additionally, the PL of items discovered in the Eotian ruins varies widely. When such items come on the market, they usually fetch very high prices.

In Dawning Star, Purchase DCs of items from the next highest PL are increased by +10 instead of the normal +5. This is because such highly advanced equipment is very rare and can only be acquired from the tentaari or as relics from the ruins of Eos.

made by hand. Despite this limitation, many colonists prefer the handmade goods of craftsmen to factory-made goods, thinking them to be higher quality. This has allowed many craftsmen to make a name for themselves as masters of their craft, such as the Brase family of gunsmiths.

Generally speaking, if an item was brought over from Earth, its purchase DC increases by +5. The purchase DCs of items made by craftsmen on Eos can vary from -5 to +5 depending on the quality and reputation of the craftsmen. Items built in factories are usually at their normal purchase DC. However, due to the fragile economy of Eos, market fluctuations are extreme, and purchase DCs can change by -5 to +5 within a few weeks.

Within Dawning Star, items can be easily purchased at the many specialty stores located around the city. Somewhere in the city most any good can be found, except for Military or Illegal goods, which require some footwork to find. Firearms are sold in the city, but one must be a citizen of the Dawning Star Republic and have the appropriate licenses or special dispensation from the government to purchase one. In Iron Scar, conditions are similar. In the faction-camps, Military items can often be purchased without any hassle. In Roger's Point, for example, just about anything can be had for the right price. Weapons purchased outside of the Dawning Star Republic are still illegal within the Republic, so characters carrying them must conceal them or face arrest.

Outside of Dawning Star, most settlements have few specialty shops and instead make do with a number of general stores that sell a wide variety of goods. These stores rarely have much stock or more than one kind of a single product, but they do provide convenience as a one-stop shopping environment. Chapter 4 identifies the maximum purchase DC of items found in each major settlement. To find the black market in a particular locale requires a successful Knowledge (Streetwise or Local) check. The DCs for these checks are also listed in Chapter 4.

EQUIPMENT FROM D20 MODERN

All the equipment listed in the D20 MODERN is readily available on Eos except for vehicles and heavy weapons. These may be present in limited numbers in the hands of collectors or some faction-camps, but are not common.

EQUIPMENT • • •

With the lack of industrial capacity on Eos, most items are hand-constructed by craftsmen or are made in the few factories in Dawning Star. The more advanced items found among the human population of Eos are generally items brought over from Earth or produced in one of the factories. The cottage industries of Eos tend to concentrate on items of a lower tech level that do not involve items like microchips or similar small parts that cannot be

ADVENTURING GEAR • • •

Dawson Dragon Harness

A specially made saddle for riding Dawson dragons, its design was perfected by the velin but is now commonly used by both velin and humans. The harness includes a backshield to protect the rider from accidental tail slaps and a heavy leather bridle arrangement to control the Dawson dragon's head and make it difficult for the animal to nip at the rider. While using a Dawson dragon harness, the rider receives a +2 equipment bonus to Ride checks and receives a +5 bonus to defense against attacks from that Dawson dragon.

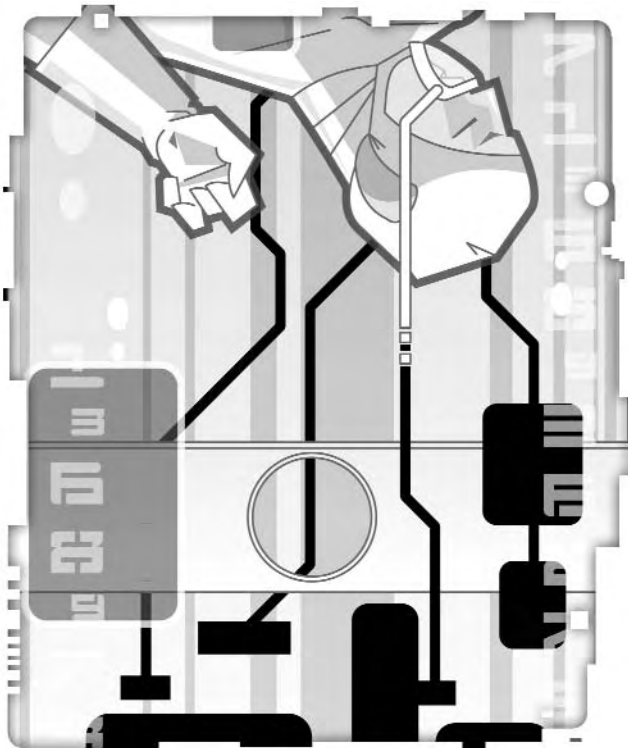

tion on important landmarks and settlements in these areas. Local weather patterns are also displayed on the navigator, and the device automatically sounds an alarm when hazardous weather comes within 10 miles of the navigator. The device also contains a laser rangefinder and an emergency locator beacon that is effective to 100 miles. These devices are common among all those who work in the outdoors on Eos. A hand-held navigator grants a +6 equipment bonus to Navigate and Knowledge (Local) checks made on Eos and a +2 equipment bonus to Survival checks to gain a bonus to Fortitude saving throws against severe weather.

Emergency Cryogenic Freezing Tank

The cryogenic freezing tanks on the Dawning Star have been disassembled and cannibalized for parts or moved to areas of the planet where they may be of use. These tanks have been modified to cut down on their size and only require two rounds to activate instead of the normal six hours. However, these emergency cryogenic tanks can only hold an occupant for 24 hours. After that time, the occupant begins to suffer permanent damage as the cryogenic environment deteriorates at an uncontrolled rate. These tanks follow the standard procedure listed under the Treat Injury skill in Chapter 2, but only require two rounds to put someone in the tank. Once the person is inside, they are considered stabilized and suffer no ability damage while frozen. Similarly, the effects of poison, disease, radiation sickness, and other conditions are held in stasis until the occupant is removed from the cryogenic state.

If the subject is left in the emergency cryogenic freezing tank for more than 24 hours, they suffer 1 permanent point of Constitution drain each hour until they are dead or they are removed from the tank.

Hand-Held Navigator

An enhanced version of a global positioning system, the hand-held navigator is a small, palm sized computer that can determine its location using a number of satellites orbiting Eos. These satellites were originally used in the terraforming process, but have since been converted to other uses. The hand-held navigator also contains maps of most of the inhabited areas of the planet and contains informa-

Portable Condenser

A common device in the arid regions of Eos, a portable condenser collects water vapor from the surrounding air and condenses it to provide potable water. In most environments, it can produce a quart of water each day, but particularly dry or humid conditions can cut this amount in half or double it.

EQUIPMENT FROM THE FUTURE

The Future SRD includes a host of new equipment. The availability of this equipment varies by progress level.

PL 5: All the weapons, armor, and equipment are available on Eos.

PL 6: All the weapons, armor and equipment are available on Eos, except for laser weapons. Only the EDF line of laser weapons, presented in this chapter, is available.

PL 7+: The only items available on Eos are medium combat armor, the space combat suit, seeker ammunition, plasma-coated ammunition, and dissolver grenades. All other equipment may be found in the hands of the tentaari or among the ruins of Eos.

ADVENTURING GEAR

Name	PL	Size	Weight	Purchase DC	Restriction
Dawson dragon harness	2	Small	25 lb.	15	-
Emergency Cryogenic Freezing tank	6	Large	80 lb.	26	-
Hand Held Navigator	6	Tiny	1 lb.	17	-
Portable Condenser	5	Tiny	1 lb.	10	-
Smart link	6	Tiny	.5 lb.	21	Res (+2)
Stun Fence	6	Medium	12 lb.	18	-

There is an optional breather mask, which collects water vapor from the wearer's breath and increases the amount of water collected by 50%. Many explorers of desert regions carry several of these machines.

Smart-Link

Smart-Links are computer-assisted aiming mechanisms that project a crosshairs on something within the user's field of vision, representing exactly where the weapon is pointed. Usually, the image is projected on the interior of a pair of goggles. The Smart-Link comes in two pieces; a gyroscopic computer attached to the weapon and a medium through which the info is displayed. The information is relayed between these two points using either

radio or infra-red broadcasts, eliminating the need for a cable.

The medium for a Smart-Link can be any type of device which has a heads-up display built in, such as display glasses. Alternatively, the Smart-Link can feed directly into a cybernetic eye or heuristic combat cortex. As a whole, the Smart-Link and "smart gun" as it is sometimes called, provide additional targeting data to the user. Using a weapon equipped with this item grants a +1 equipment bonus to attacks.

Smart-Link Cybernetic Implant

The recipient's eye is interfaced with a Smart-Link.

Benefit: This implant is purchased for Smart-Links that interface with cybernetics. It must be implanted into an existing artificial eye and must be purchased separately from the Smart-Link. It comes with a radio transceiver to connect the cybernetic implant to the Smart-Link to the weapon. Using this implant eliminates the need for goggles or another medium.

Type: Internal.

Hardness/Hit Points: -/2 hp.

Base Purchase DC: 26.

Restriction: Restricted (+2).

Stun Fence

Stun fences are mainly used by ranchers to keep their herds together at night, but in some areas they are used as a security measure. A stun fence consists of a number of posts, each two inches in diameter and six feet tall, that are set up in any shape no more than 50 feet apart. Once the stun fence is activated by a remote control anything that crosses the stun fence without avoiding the infra-red lasers projected between each post is shot with a Taser dart by the closest fence post. Also anything that approaches within 10 feet of a post is shot with a Taser dart to prevent tampering with the fence. Stun fences are considered to have a +6 attack bonus and the Taser darts inflict 1d4 points of electricity damage. Targets struck by the Taser darts must make a Fortitude save (DC 16) or be stunned for

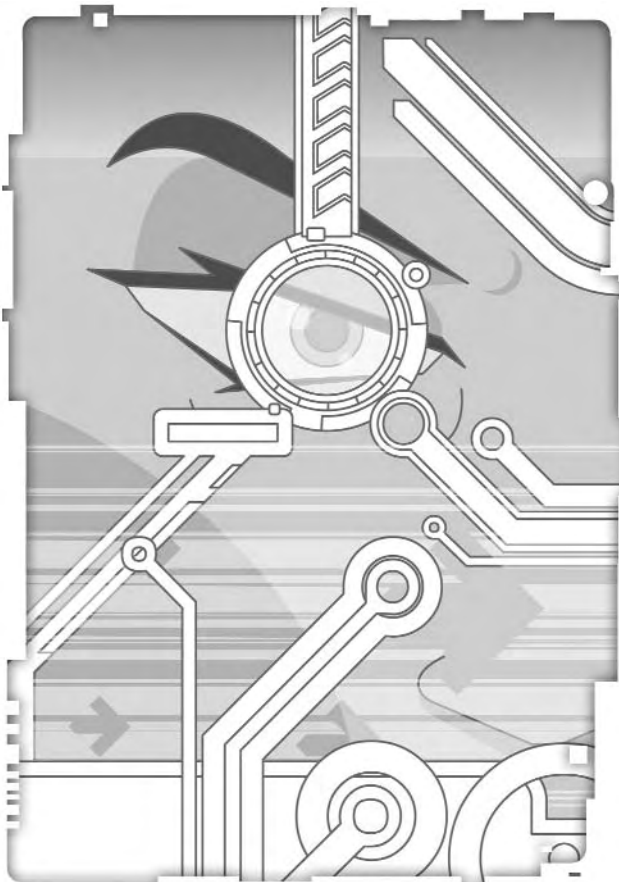

1d4 rounds. Each post can fire one dart per round. Each post holds 20 Taser darts.

It is possible to avoid the infra-red lasers by using infra-red goggles and making a Tumble check (DC 15).

The posts collapse to small metal tubes two feet long and weigh 3 pounds each. The cost is for a set of four posts.

WEAPONS • • •

◆ MELEE WEAPONS

While firearms are the most commonly used type of weapon on Eos, melee weapons are also common due to the fact they do not require ammunition. Especially in the areas beyond Dawning Star, ammunition is not always cheap or available. If you can make due with a knife, do so. Additionally, some craftsmen have developed a sterling reputation as weaponsmiths, turning out beautiful and functional swords and other weapons for those customers who can afford them. Most professional soldiers carry a melee weapon of some type as a backup, and all members of the Eos Defense Force are issued swords and bayonets with their standard equipment. Like firearms, melee weapons are not allowed in many settlements, but most allow knives and other simple weapons. In some faction-camps, duels have returned as a suitable way to settle disputes. This is normally accomplished with melee weapons to save ammunition and avoid accidental casualties.

While the humans of Eos see melee weapons as a reasonable backup weapon, the velin favor them over all other weapon types. Velin can field the best-trained melee fighters on the planet. Most velin carry several melee weapons when away from their camp.

◆ WEAPON MATERIALS

Several alternative weapon materials are available in the Dawning Star Republic. These materials may not be used to create atomic blades, bazer swords, smart sticks, plasma cutter weapons (described below) or high-frequency swords and stun sticks from the recently released future rules.

Durasteel

Durasteel is an advanced, composite material made of steel and several other materials. Weapons made from durasteel have double their normal hardness. The Purchase DC of a durasteel weapon is increased by +2.

Additionally, durasteel edged weapons can be honed more effectively than normal steel weapons. This extra treatment adds a further +6 to the weapon's Purchase DC (for a total of +8) and can only be applied to weapons that deal slashing or piercing damage. Honing a durasteel weapon

increases the weapon's damage die by one step as detailed on the following table and increases the critical threat of the weapon by +1.

Old Damage	New Damage
1	1d2
1d2	1d3
1d3	1d4
1d4	1d6
1d6	1d8
1d8	1d10
1d10	2d6
2d6	2d8

Crafting velin battle armor and shields out of durasteel increases the armor bonus of the item by +2 and increases the purchase DC of the item by +4.

Ceramics

Ceramic weapons are made of specially processed clay that is combined with metals and numerous other materials to create an incredibly strong composite material. Ceramic weapons are immune to fire damage and have double their normal hardness. The Purchase DC of a ceramic weapon is increased by +4.

Armor can also be reinforced with ceramic plating. The unique design of ceramic armor disperses heat harmlessly away from the wearer, granting him fire resistance 5. The purchase DC of ceramic armor is increased by +4.

Luminstone

A unique material scavenged from some of the ruins of Eos, this material has a tensile strength similar to steel but glows in the dark. It does not require exposure to bright light or any other type of energy input to glow, instead relying on a very slow chemical process within the material itself. Luminstone is mildly radioactive but not in a sufficient quantity to harm those even with a prolonged exposure to it. A Tiny-sized luminstone object emits a light radius of 5 feet. The radius doubles each increase in object size. Luminstone has a hardness of 12 and 30 hit points per inch of thickness.

Luminstone weapons inflict an additional +1d6 damage vs. vaasi. Luminstone weapons are only made by the velin. Luminstone increases the Purchase DC of a weapon by +5.

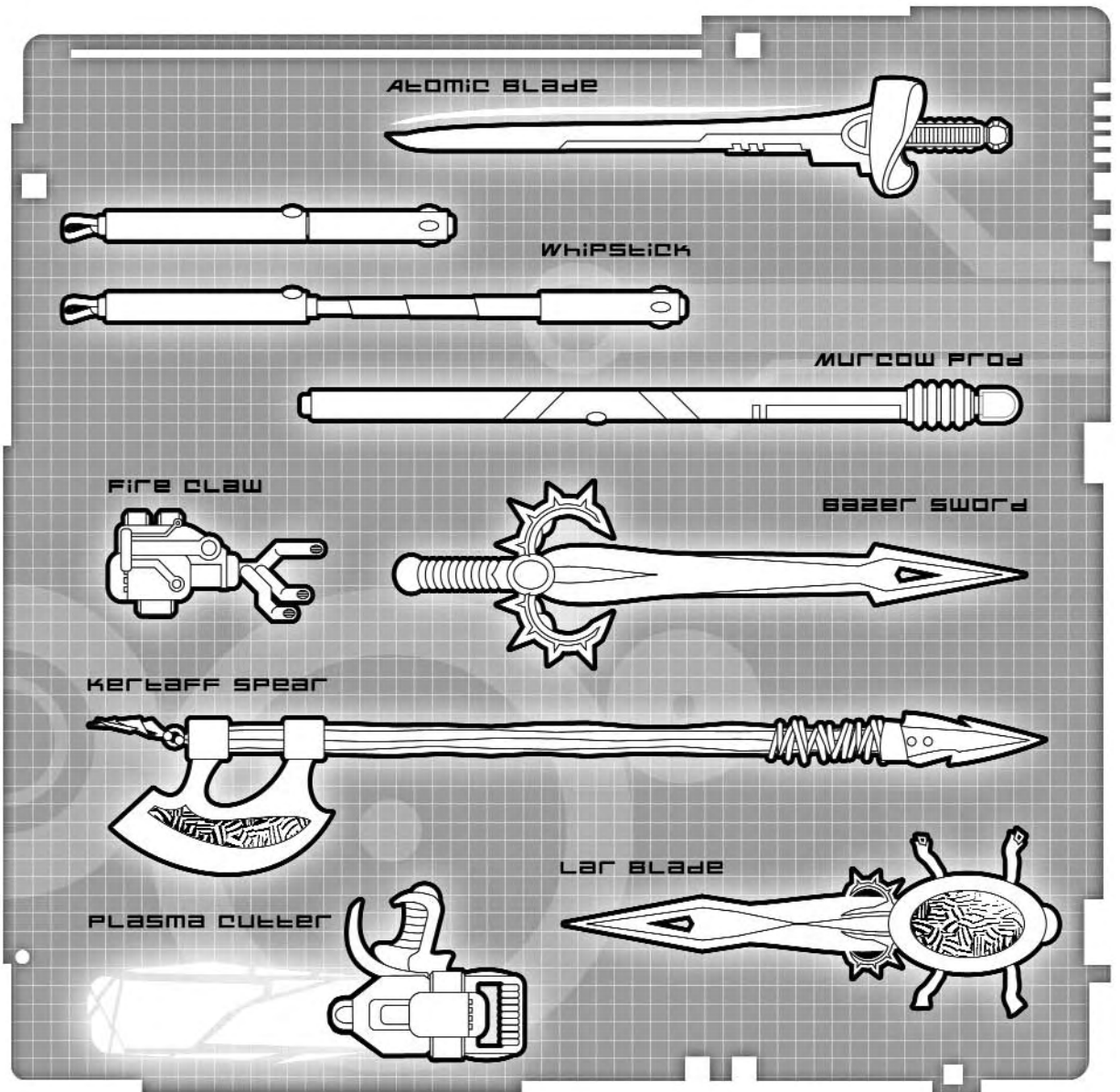

MELEE WEAPONS

Weapon	PL	Damage	Critical	Damage Type	Size	Weight	Purchase DC	Restriction
Atomic Blade (Exotic)	7	2d6	18-20 x3	Slashing	Med	3 lb.	26	Res (+2)
Bazer Sword (Exotic)	2	1d6/1d6	19-20	Slashing/Fire	Med	5 lb.	21	-
Fire Claw (Exotic)	6	+1d6*	20	Fire	Tiny	2 lb.	13	-
Kertaff Spear (Exotic)	2				Large	12 lb.	12	-
		blade 1d10	19-20	Slashing				
		spike 1d8	19-20x3	Piercing				
Lar Blade (Exotic)	2	1d8	19-20	Slashing	Small	4 lb.	10	-
Murcow Prod (Simple)	5	1d4	20	Electricity	Large	15 lb.	10	-
Plasma Cutter (Exotic)	7	2d12	20	Fire	Med	4 lb.	27	Res (+2)
Whipstick (Simple)	5	1d8	19-20	Bludgeoning	Med	5 lb.	14	-

* See weapon description for more information

◇ SIMPLE MELEE WEAPONS

Murcow Prod

A modified version of a terran cattle-prod, a murcow prod's electrical discharge is higher to penetrate the murcow's thick skin. You can strike opponents 10 feet away with it, but you can't use it against an adjacent foe. On a successful hit the murcow prod deals 1d4 points of electricity damage and the target must make a Fortitude saving throw (DC 17) or be paralyzed for 1d6 rounds.

Whipstick

The whipstick is very similar in appearance to a collapsible metal baton, but inside the whipstick is far more complicated. When extended, it is able to sense what direction it is being swung and when it is approaching the target. Right before striking the target the weapon whips forward quickly, granting extra force to the blow. This feature can be deactivated as a free action, in which case the whipstick functions as a standard metal baton. Whipsticks are favored by law enforcement officers because it gives them a little extra power when needed.

◇ EXOTIC MELEE WEAPONS

Atomic Blade

A fancy sounding name for a simple idea, the cutting edge of an atomic blade is only a single molecule thick. This enables the weapon to easily cut through many surfaces, but it is very dangerous to those not trained in its use. When striking an inanimate object, an atomic blade ignores half the object's hardness when determining damage. When striking a living being, the atomic blade halves any defense bonuses due to armor or natural armor.

If the user of the atomic blade is knocked prone, grappled, disarmed, bull rushed or suffers any effect that moves his position against his will, he must make a Reflex save (DC 15) to avoid hitting himself with the atomic blade. Additionally, if the wielder is not proficient with the weapon, he must make Reflex save (DC 15) after each missed attack to avoid hitting himself with the atomic blade. Even the slightest touch of the cutting surface can inflict serious injuries. Failure means the wielder hits himself and takes normal damage from the weapon but does not add in any modifiers derived from Strength, feats, or similar sources.

An atomic blade must receive daily treatment, which takes a half-hour and uses a special cleaner to keep it from losing its keen edge. An atomic blade that has not been treated within the past 24 hours deals 1d8 damage and has a critical threat of 20.

Bazer Sword

Bazer swords are made of a rare metal from the ruins of Eos that burns living flesh on contact. The

velin craft bazer swords using a special process known only to their craftsmen. Bazer swords always have an unusual balance that is hard to master, making them exotic weapons. Velin rarely trade bazer swords to humans, but occasionally humans who have proven themselves great allies of the velin, are gifted with such a weapon. Bazer swords inflict 1d6 points of normal damage and 1d6 points of fire damage on a successful hit.

Fire Claw

A weapon devised by members of the Eos Freedom League, this dangerous device is made up of a tank of flammable gas with, three metal tubes that run over the back of a heavy, flame-proof glove. When not in use, the tubes look like metal claws coming out of the back of the wearer's hand. When activated, the flammable gas is projected out of the three tubes, creating a gout of flame that the wearer can use when punching. A target punched by someone using an active fire claw suffers 1d6 points of fire damage in addition to the punch damage. The target's clothes catch on fire unless he makes a Reflex saving throw (DC 15). Activating the fire claw is a full-round action that provokes an attack of opportunity. A full fuel tank contains enough fuel to keep the fire claw active for ten minutes.

Kertaff Spear

Kertaff spears are the traditional weapon of the Velin Guardians and Vaasi Hunters. The spear holds a piercing spike on one end and a slashing axe-like blade on the other. The slashing blade is held aloft from the haft of the weapon. When using the weapon as a spear, the wielder holds the weapon beneath the blade, which serves as a hand guard. The kertaff spear cannot be used as a double weapon, but can be used to strike foes 10 feet away with the spiked end and adjacent foes with the blade. Alternating between using the spike and the blade is a move action that does not provoke an attack of opportunity.

Lar Blades

Lar blades are a metal buckler with a two-foot blade affixed to it that extends over and beyond the hand it is strapped to. Velin warriors favor these weapons in duels and usually use them in pairs. A lar blade adds a +1 equipment bonus to the Defense of the wearer. This bonus is lost for one full round after any attack with the weapon. The equipment bonus to Defense does not stack when wearing two lar blades, but a dual wielder does not lose the bonus of one blade while using the other to attack.

Plasma Cutter

A modified version of a fusion torch, the plasma cutter is an unstable weapon favored by the inhab-

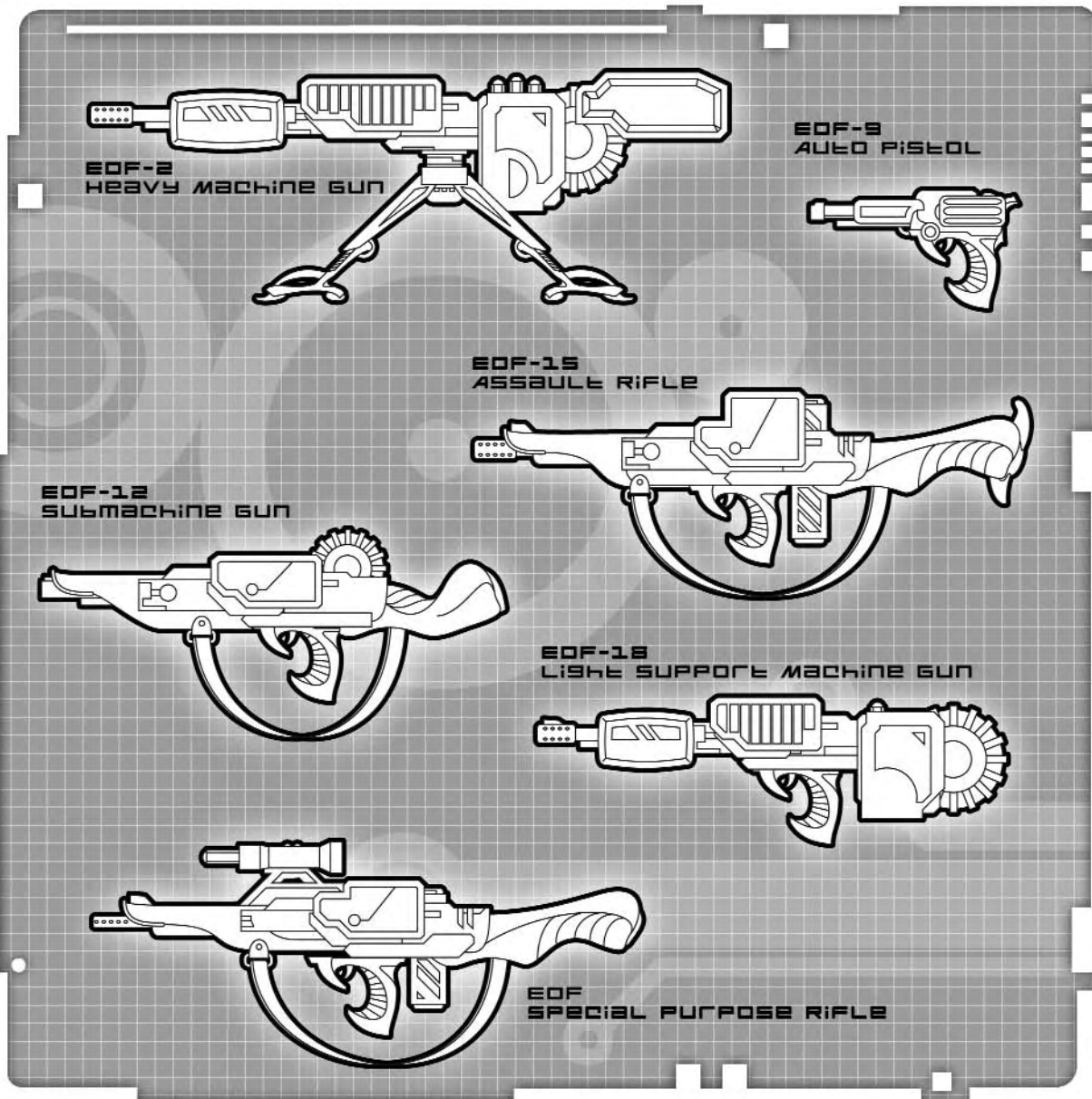

EOS DEFENSE FORCE FIREARMS

Weapon*	PL	Damage	Critical	Damage Type	Range Increment	RoF	Magazine	Size	Weight	Purchase DC	Restriction
EDF-2 Heavy Machinegun	5	2d12	20	Ballistic	100 feet.	A	Linked	Huge	40 lb.	27	Mil (+3)
EDF-9 Auto pistol	5	2d6	20	Ballistic	30 ft.	S, A	21 box	Small	4 lb.	18	Lic (+1)
EDF-12 Submachine gun	5	2d6	20	Ballistic	40 ft.	S, A	50 box	Med	7 lb.	20	Res (+2)
EDF-15 Assault Rifle	5	2d8	20	Ballistic	60 ft.	S, A	60 box	Large	16 lb.	22	Res (+2)
EDF-18 Light Support Machinegun	5	2d10	20	Ballistic	60 ft.	A	Linked	Large	20 lb.	22	Mil (+3)
EDF SPR	5	2d12	20	Ballistic	130 ft.	S	6 Int.	Large	22 lb.	25	Res (+2)

* The weapons on this chart require the Personal Firearms Proficiency.

itants of Roger's Point. This powerful weapon projects a three foot blade of plasma that can be used to cut through many materials and inflict terrible damage on living things. Unfortunately for the welder, much like the atomic blade the plasma cutter can be as dangerous to the person holding it as to the target.

If the user of the plasma cutter is knocked prone, grappled, disarmed, bull rushed or suffers any effect that moves his position against his will, he must make a Reflex save (DC 15) to avoid hitting himself with the plasma cutter. Additionally, if the welder is not proficient with the weapon, he must make Reflex save (DC 15) after each missed attack to avoid hitting himself with the plasma cutter. Even the slightest touch of the cutting surface can inflict serious injuries. Failure means the welder hits himself and takes normal damage from the weapon but does not add in any modifiers derived from Strength, feats, or similar sources.

By taking a full-round action that provokes an attack of opportunity, a plasma cutters can be used to cut through stationary objects with great ease. Using the plasma cutter in this way inflicts full damage against the object, ignoring any hardness.

Plasma cutters are powered by plasma power packs and drain 2 charges per round of use.

◇ **RANGED WEAPONS**

Ranged weapons are the preferred method of solving violent disputes among the humans of Eos. Guns are quite common in areas outside of Dawning Star, and few ranchers, air runners, traders, or farmers stray more than a few feet from a ready firearm just in case. While the actual level of violence is relatively low among the colonists, the many creatures on Eos are not always so accommodating.

Generally speaking, firearms are not used in zero-G environments due to recoil, which causes a character to move in the opposite direction of the shot at a cumulative rate of 10 feet per round per attack until the character hits a fixed object. Energy and gyro-jet weapons do not suffer this problem.

◇ **EOS DEFENSE FORCE FIREARMS**

Most of the firearms carried by the Republic Militia and EDF infantry are firearms that were brought over from Earth in the Dawning Star's cargo hold. Most of these weapons are over 50 years old but have been well cared for. A limited number of new weapons have been manufactured at the EDF munitions plant in Dawning Star, but their efforts have recently been concentrating on producing plasma and laser weapons in lieu of firearms. Some craftsmen have taken to making replicas of the EDF line due to the solid design and reliability of the weapons, and thousands of these replicas have made it into the market over the years. Over time, the EDF line of weapons have

become the most common firearms on Eos and are used in the faction-camps and, indeed, across the entirety of the Dawning Star Republic.

EDF-2 Heavy Machine Gun

A descendant of the M2 .50 caliber machinegun, the EDF-2 is a 13mm machine gun that primarily functions as a vehicle-mounted support weapon. It is too heavy to carry easily by less than three men, making it a difficult weapon to transport without a vehicle or mount of some sort. The EDF-2 is the rarest of the EDF line of firearms and there are less than 1,000 on the entire planet.

The EDF-2 comes with a built in tripod that takes a move action to set up and halves all penalties due to firing bursts. While the tripod is deployed, characters using the weapon cannot move and use the EDF-2 in the same round.

EDF-9 Auto Pistol

The most common firearm on the entirety of Eos, the EDF-9 is synonymous with simplicity and durability. Replicated by dozens of craftsmen, the EDF-9 holds 21 rounds of 10mm ammunition. The original design had an integral laser sight, but most no longer carry that accessory. The laser sight increases the purchase DC of the weapon by +1.

EDF-12 Submachine Gun

A favored weapon of the Eos Defense Force Marines and Special Forces, this small weapon is designed to function well in tight spaces, such as urban environments and spaceships. It is rarely used outside of Dawning Star and does not have the popularity of the other weapons in the EDF line. The EDF-12 uses 10mm ammunition in 50 round clips that snap into a port on the top of the weapon.

EDF-15 Assault Rifle

Many farmers and ranchers consider owning an EDF-15 a sign of wealth, prosperity, and patriotism. Illegal for citizens of Dawning Star to own without a license, it is often issued to members of the Republic Militia. Seeing an EDF-15 hanging over the mantle of a house is usually a sign the house is loyal to the Dawning Star Republic. Like the EDF-9, this weapon has been widely copied, and after the EDF-9 is the most common weapon of the EDF line. The Eos Freedom League has deployed their own version of the EDF-15 they call the FL-Eagle, which is essentially identical.

The EDF-15 is built in a bullpup style and holds 60 rounds of 10mm ammunition. The weapon comes with an integral combat scope, a laser sight, and an interface to link it to a suit of armor equipped with an onboard computer system.

EDF-18 Light Support Machine Gun

The newest member of the EDF family, the EDF-

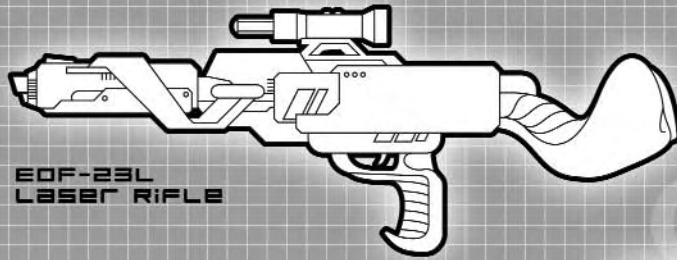

**EDF-23L
LASER RIFLE**

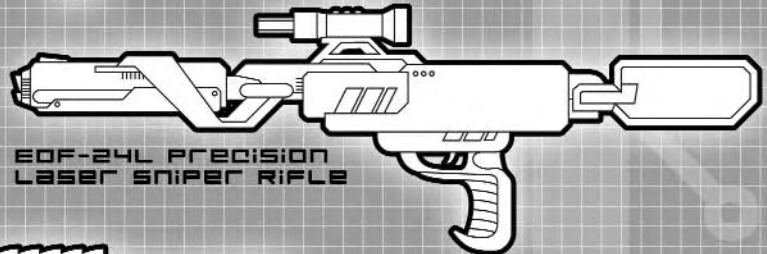

**EDF-24L PRECISION
LASER SNIPER RIFLE**

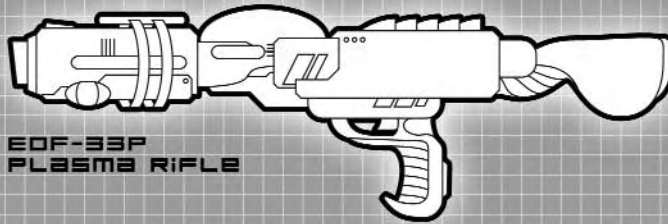

**EDF-33P
PLASMA RIFLE**

**EDF-33P
PLASMA CANNON**

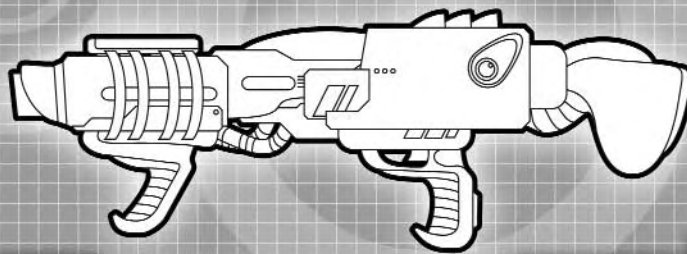
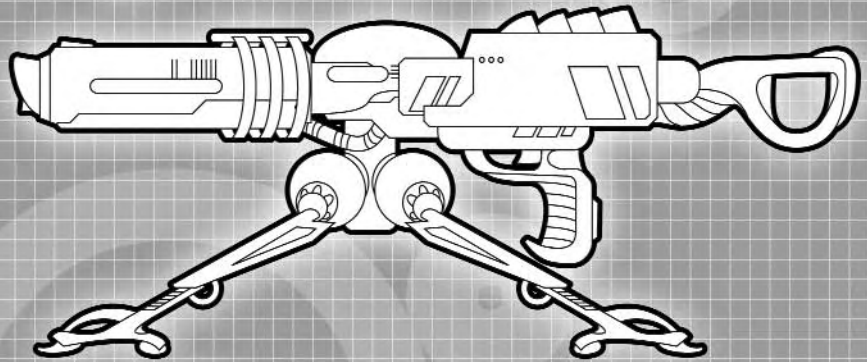

**EDF-35P
PLASMA SPRAYER**

EOS DEFENSE FORCE LASER WEAPONS

Weapon*	PL	Damage	Critical	Damage Type	Range Increment	RoF	Magazine	Size	Weight	Purchase DC	Restriction
EDF-23L Laser Rifle	6	3d8	20	Fire	100 ft.	S, A	Power pack	Large	10 lb.	23	Mil (+3)
EDF-24L Precision Laser Sniper Rifle	6	3d10	20	Fire	150 ft.	S, A	Power pack	Large	20 lb.	26	Mil (+3)

* The weapons listed on this table require the Personal Firearms Proficiency feat.

18 is the only one developed and manufactured on Eos. It was created to provide an easily portable machine gun for the EDF infantry to use against alien creatures that attack en masse, such as spitter spiders. Most EDF infantry squads are assigned one of these weapons to be operated by two soldiers, one for firing the weapon and one for loading. Ammunition for the EDF-18 comes in 100-round belts.

EDF Special Purpose Rifle

The most valued weapon of the EDF firearms, the SPR is one of the most accurate and reliable long-range weapons on the planet. A sniper rifle with few peers on Eos, it is reserved for special sharpshooter troops in the Eos Defense Force and Dawning Star Police Department. None of these rifles have been manufactured on Eos due to the precision machining needed to produce them; however, numerous knockoffs have been made and are available on the black market. These knockoffs generally have a range increment of 100 ft. The SPR uses 13mm ammunition.

SPRs come with a silencer and sound suppressor that can be attached to the weapon in one minute for each. Also, SPRs come with an integral laser sight, range finder. Genuine SPRs are considered mastercrafted weapons and grant a +1 equipment bonus on attack rolls.

◆ EOS DEFENSE FORCE LASER WEAPONS

When the Dawning Star left Earth, laser weapons were just starting to become the norm for the elite troops of the wealthier nations of the world. Only a few dozen were included in the Dawning Star's cargo hold and weapons lockers. In the last two years, the Dawning Star Republic has directed its munitions factory to build more of these weapons. The two laser weapons used by the Eos Defense Force are both of a design developed on

Earth over 50 years ago, and many of the weapons brought over in the Dawning Star are still in service with them.

EDF-23L Laser Rifle

The EDF-23L is currently the standard-issue weapon of the Eos Defense Force infantry, and they frequently use a belt power pack. Troops operating far from supply lines are usually equipped with less cumbersome firearms, but soldiers near Dawning Star are usually equipped with this weapon. The EDF laser rifle fires a short group of laser pulses each time it is fired. It comes with an integral laser sight, a scope, and a range-finding laser. The EDF-23L uses 2 charges per shot.

EDF-24L Precision Laser Sniper Rifle

A new weapon in the Eos Defense Force arsenal, it has not yet replaced the EDF SPR due to the many rare components used in its construction. The EDF-24L has superior range and accuracy but requires an enormous amount of power. It is currently only used by EDF elite snipers, and it has yet to be duplicated by any of the faction-camps. The EDF-24L comes standard with a combat scope and laser rangefinder. It is considered a mastercrafted weapon, granting a +1 equipment bonus on attack rolls. The EDF-24L uses 5 charges per shot.

◆ EOS DEFENSE FORCE PLASMA WEAPONS

After the discovery of the crashed tentaari ship in the Bergan Lowlands in 2210, plasma weapons have slowly been entering the arsenal of the Eos Defense Force. Hand-held plasma weapons became a reality in 2245. Only EDF special forces and heavy combat units were equipped with them. Recently though, with the shift of the Dawning Star Republic's munitions industry, it is expected that the number of troops equipped with plasma weapons

EOS DEFENSE FORCE PLASMA WEAPONS

Weapon*	PL	Damage	Critical	Damage Type	Range Increment	RoF	Magazine	Size	Weight	Purchase DC	Restriction
EDF-33P Plasma Rifle	7	4d8	20	Fire	60 ft.	S, A	Power pack	Large	22 lb.	25	Mil (+3)
EDF-35P Plasma Sprayer	7	4d6**	—	Fire	**	S	Power pack	Large	28 lb.	27	Mil (+3)
EDF-38P Plasma Cannon***	7	8d10	20	Fire	100 ft.	S	Heavy Power pack**	Huge	90 lb.	30	Mil (+3)

* The weapons listed on this table require the Personal Firearms Proficiency feat.

** See the weapon description for the special abilities of this weapon.

*** This weapon requires the Exotic Firearms Proficiency feat.

will grow quickly. Roger's Point has created a knockoff of the Eos Defense Force's plasma weapons, but these are highly unstable. Whenever a natural 1 is rolled on an attack roll using a Roger's Point plasma weapon, it explodes, inflicting 5d6 fire damage on the wielder and anyone else within a 10-foot radius; a successful Reflex save (DC 13) halves the damage. The explosion can be avoided with a successful Repair check (DC 15) within one round of the malfunction.

Plasma weapons require special power packs that cannot be used with other weapons, though their cost and weight are the same as other power packs.

EDF-33P Plasma Rifle

Eventually, this weapon will be the standard issue of the Eos Defense Force, but for now it serves as the weapon of the 1st Ground Assault Company and 1st Urban Combat Company. It is a powerful, short-range weapon well-suited for urban combat. Due to the rarity of urban combat environments, this has led some military leaders to doubt the wisdom of switching over to plasma weapons. The EDF-33P uses 5 charges per shot.

EDF-35P Plasma Sprayer

Still in the experimental stages, a handful of these weapons have been issued to the 1st Ground Assault Company for testing purposes. Similar to standard flamethrowers, these weapons spew a cone of plasma out to a maximum range of 80 feet long and 20 feet wide. The range of the cone can be changed by the weapon's wielder as a free action and can be set anywhere from 10 feet to 80 feet in length. Adjusting the area of the cone is a move action that provokes an attack of opportunity. Everything inside the cone takes 4d6 points of fire damage. A successful Reflex save (DC 15) halves the damage.

The EDF-35P uses 10 charges per shot and is usually used with a back power pack.

EDF-38P Plasma Cannon

A crew-served version of the EDF-33P, the EDF-38P is simply a larger model of that weapon. The

EDF-38P requires three people to carry it (one for the power supply, one for the barrel, and one for the trigger assembly, each representing one-third of the cannon's total weight) and takes one minute to assemble or break down. The EDF-38P relies on a heavy power pack especially built for the weapon; it cannot run on a standard power pack. These heavy power packs hold 500 charges, weigh 30 lbs. and have a purchase DC of 23.

◇ GYRO-JET WEAPONS

Gyro-jet weapons were first developed for use in space as a recoilless weapon, but they have since proved useful on Eos due to their long range. Because the ammunition is expensive, the Eos Defense Force does not make large use of gyro-jet weapons, but they are common in Iron Scar and the faction-camps. While the cost of the ammunition for a gyro-jet weapon is higher than that of an energy weapon, the gyro-jet weapon itself is cheaper and is easier to maintain. Using Craft (Mechanical) to build a gyro-jet weapon or using Repair to fix a gyro-jet weapon enjoys a +4 circumstance bonus to your skill check.

Most gyro-jet weapons are currently made by a group of craftsmen based out of the Steel End faction-camp. Gyro-jet weapons are available for sale in Dawning Star and most faction-camps. They are a favorite of ranchers and air runners.

The standard round for gyro-jet ammunition is a metal slug propelled by a tiny rocket engine. Flechette rounds don't do as much damage but can easily pierce many forms of armor. Explosive rounds inflict more damage but do not have the armor-piercing ability of the flechette round.

GP-02 Gyro-Jet Pistol

Based on a design carried over from Earth, most GP-02's today are a pared-down version of the original weapon. The original GP-02 was more accurate and had a longer range, but available manufacturing methods have impacted weapon quality. These original GP-02s are difficult to find on Eos. An original GP-02 has a range increment of 80 feet and is considered a mastercrafted weapon, granting a +1 equipment bonus to attack rolls. An original GP-02 has a purchase DC of 24.

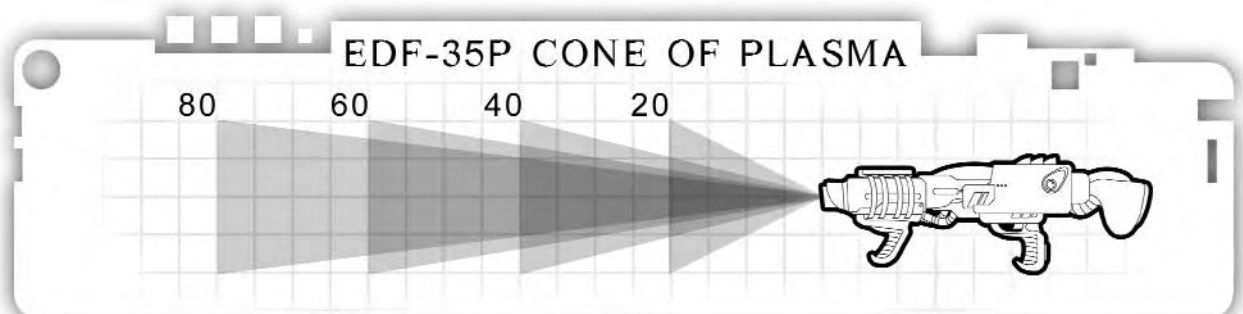

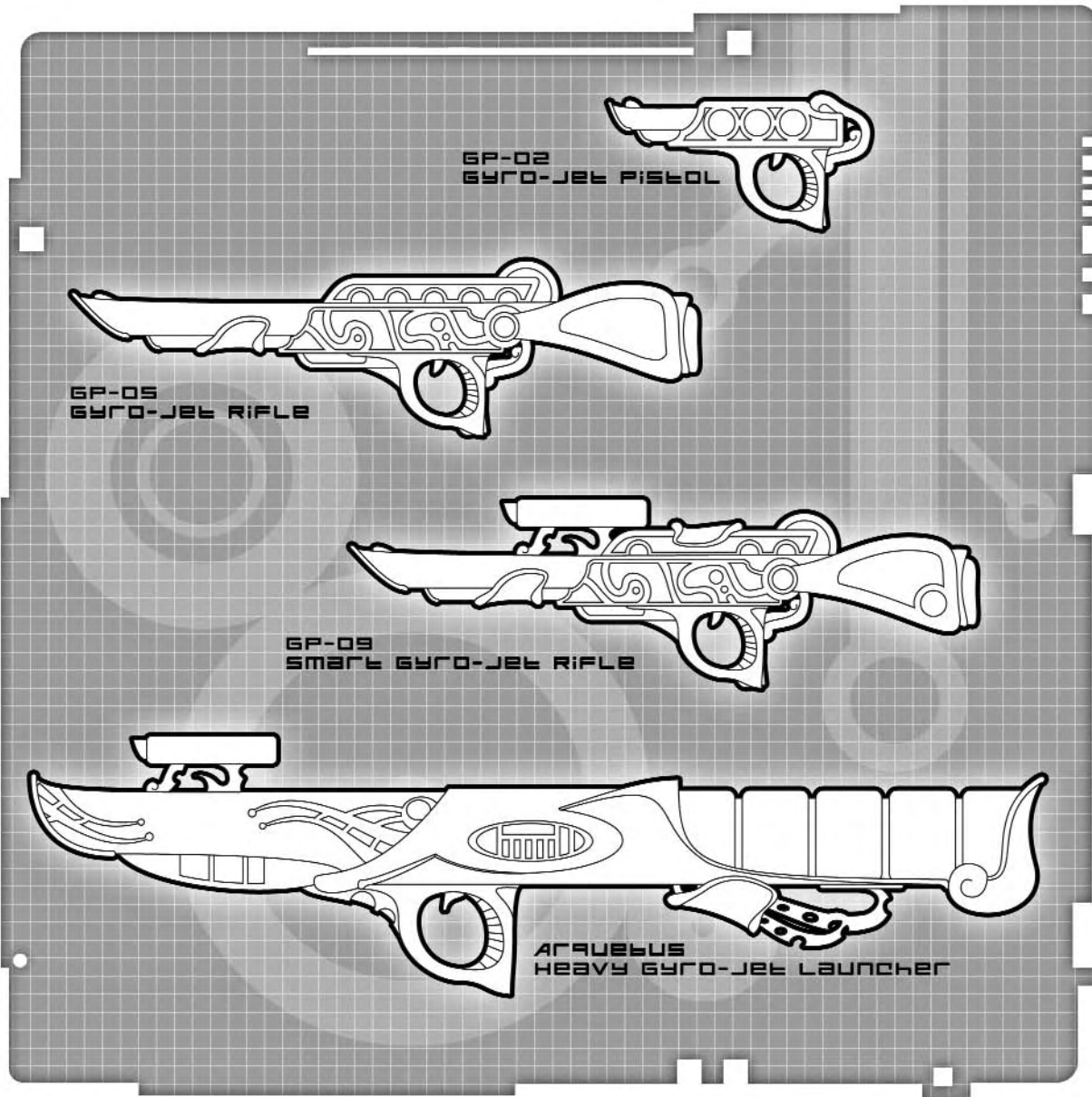

GYRO-JET WEAPONS

Weapon*	PL	Damage	Critical	Damage Type	Range Increment	RoF	Magazine	Size	Weight	Purchase DC	Restriction
GP-02 Gyro-Jet Pistol	6	2d6	20	Ballistic	60 feet.	S	10 box	Medium	6 lb.	17	Lic (+1)
GR-05 Gyro-Jet Rifle	6	2d8	20	Ballistic	80 feet	S	20 box	Large	9 lb.	19	Res (+2)
GR-09 Gyro-Jet Smart Rifle	6	2d8	20	Ballistic	100 feet	S	20 box	Large	10 lb.	24	Res (+2)
Arquebus Heavy Gyro-Jet Launcher**	6	***	20	***	***	S	6 box	Large	26 lb.	30	Mil (+3)

* The weapons listed on this table require the Personal Firearms Proficiency feat unless otherwise noted.

** This weapon requires the Exotic Firearms Proficiency feat.

*** See weapon description for details

BRASE FAMILY FIREARMS

Weapon*	PL	Damage	Critical	Damage Type	Range Increment	RoF	Magazine	Size	Weight	Purchase DC	Restriction
Shotgun	4	2d10	20	Ballistic	30 feet	S	5 int.	Large	12 lb.	17	-
Combat Shotgun	4	2d10	20	Ballistic	30 feet	S, A	20 box	Large	20 lb.	20	Res (+2)
Hunting Rifle	4	2d8	20	Ballistic	70 feet	S	Single	Large	10 lb.	17	-

* Weapons listed on this table require the Personal Firearms Proficiency feat.

GP-05 Gyro-Jet Rifle

A pared-down version of the GP-09, this rifle is the most common gyro-jet weapon on Eos. It is favored by many ranchers and farmers for its accuracy and range, excellent for dealing with dangerous animals and the like. Some GP-05s are adaptive, meaning that they can accept standard ammunition or GP-02 ammunition. When using GP-02 ammunition, the weapon's range increment and damage are the same as the GP-02. An adaptive GP-05 has special sliders in the workings of the gun, which have a purchase DC of 6 and require Craft (Mechanical) or Repair check (DC 10) to install. Alternatively, the interior of the gun can be manually changed to accept GP-02 ammunition, which requires a Craft (Mechanical) or Repair check (DC 20).

GP-09 Smart Gyro-Jet Rifle

The original gyro-jet rifle design from Earth, this model uses a special built-in laser guidance system to work in conjunction with guided gyro-jet rounds. While the rifle can also fire the "dumb" rounds of the GP-05, its strength is in using the guided rounds. Unfortunately, due to the electronics needed to produce the guided rockets they are very rare on Eos. Smart rounds confer a +2 equipment bonus on attack rolls. The GR-09 also comes standard with a scope and laser rangefinder.

Arquebus Heavy Gyro-Jet Launcher

Similar in design and function to a bazooka or grenade launcher, the Arquebus Heavy Gyro-Jet Launcher fires a large rocket round at its target. This man-portable launcher is used against vehicles and other hard targets and uses a cylinder that carries 6 rounds. When an Arquebus round hits its target, it explodes like a grenade or other explosive, dealing 10d6 points of damage to all creatures within a 10-foot radius (Reflex save, DC 18, for half damage). Its warhead features a shaped charge designed to penetrate the armor of military vehicles, ignoring up to 10 points of hardness of any vehicle, building, or object it strikes. The Arquebus has a minimum range of 20 feet, when using explo-

sive ammunition. If fired against a target closer than 20 feet, the warhead does not arm and will not explode but does inflict 2d6 points of bludgeoning damage on a successful hit.

In addition to explosive rounds, an Arquebus can use a flechette canister that, when fired, projects a massive cloud of flechettes over a short distance. This ammunition creates a cone 60 feet long and 30 feet wide at its base. Everything in this area takes 6d6 points of slashing damage. A successful Reflex save (DC 18) halves the damage.

◇ BRASE FAMILY FIREARMS

The Brase family is a family of gunsmiths, who live in Red Hill and specialize in shotguns. They do most of their trade with citizens of the Dawning Star Republic and make every effort to appear as good, upstanding citizens. However, it is widely rumored that they sell a good part of their stock to the Eos Freedom League. After the Battle of Red Hill, it was discovered that most of those Freedom Leaguers who had been killed were carrying Brase weapons, setting many in Dawning Star against the family. The Brases asserted that these weapons must have been obtained in the secondary market. Despite this incident, the Brase family does a brisk business, and behind the EDF line of firearms, theirs are the most common guns on the planet.

Brase Arms Shotgun

This ten-gauge, pump-action shotgun is common among ranchers, farmers, and the faction-camps. Ammunition in most areas is plentiful, and most who use these shotguns pack their own shot.

Brase Arms Combat Shotgun

Based on a centuries-old Earth design, this weapon combines the power of a shotgun with the speed of an assault rifle. Firing with the burst or automatic options suffers an additional -2 penalty on the attack roll. The Brase Arms Combat Shotgun is the favored weapon of the Eos Freedom League's assault troops.

Brase Arms Hunting Rifle

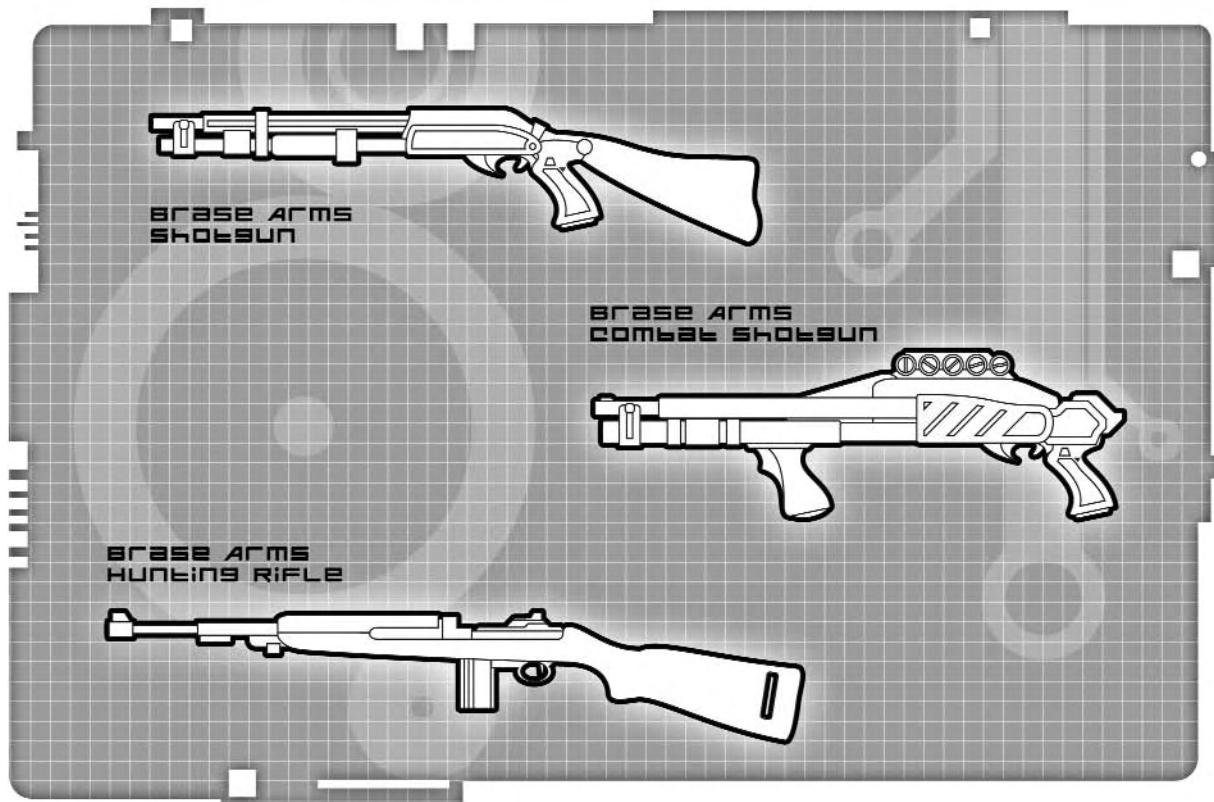

Another common weapon among farmers and ranchers, it sees little use in actual warfare. Some have derisively referred to it as the “hillbilly’s sniper rifle.” This weapon was designed primarily for taking out animals that may threaten a herd or farm. While it has stopping power, the single-shot nature of the weapon limits its combat potential. This weapon fires 7.62mm ammunition.

◆ **TANGIER FAMILY
SPECIAL PURPOSE FIREARMS**

The Tangier family is the only large weapon manufacturer to openly and blatantly deal with the Eos Freedom League. Based in Roger’s Point, they are the prime supplier of weapons to the Eos Freedom League, including knockoffs of the various EDF line of weapons. In addition to copying the weapons of the Eos Defense Force, they have their own group of heavy weapons. The Tangier family is considered one of the major threats to the continued peace of the Dawning Star Republic, and the Republic has been looking for a diplomatic way to get rid of the company, without success. If a large scale conflict were to break out between the faction-camps and the Dawning Star Republic, the Tangier family weapons plant would be one of the first targets. In addition to their heavy weapons, the Tangier family is the main source of tangler guns on Eos.

Tangier Grenade Launcher

The size of a small rifle or carbine, this launcher

fires specially made shells using a revolving rack to hold its ammunition. All types of grenades are available for this weapon. A full grenade rack has a purchase DC equal to the purchase DC of the grenade type +8. Loading a new rack requires a full-round action that provokes an attack of opportunity.

Tangier Missile Launcher

The primary anti-armor weapon on Eos, the Tangier Missile Launcher is the principal weapon used by the Eos Freedom League against armored vehicles of the Dawning Star Republic. These weapons come with a built-in guidance system that grants a +2 equipment bonus on attack rolls against vehicles. There are two types of warheads available for the Tangier missile launcher: explosive and armor-piercing. Both of these types of missiles come in four missile clips that require a full round action to reload, which provokes an attack of opportunity.

Explosive warheads do 6d6 points of damage to all creatures in a 20-foot blast radius (Reflex save, DC 16, for half damage). This damage is half concussive, half fire damage. Explosive warheads have a purchase DC of 14 per missile, and each missile weighs 3 pounds (a clip weighs 14 pounds).

Armor-piercing warheads do 12d6 points of damage to the target they strike and 3d6 points of damage to all creatures in a 10-foot radius (Reflex save, DC 14, for half damage). The armor-piercing warhead uses a shaped charge that ignores 10 points of hardness of any object it strikes. Explosive war-

TANGIER FAMILY SPECIAL PURPOSE FIREARMS

Weapon*	PL	Damage	Critical	Damage Type	Range Increment	RoF	Magazine	Size	Weight	Purchase DC	Restriction
Grenade Launcher	5	*	*	*	60 feet	S	12 box	L	18 lb.	20	Mil (+3)
Missile Launcher	5	*	*	*	200 feet	S	4 box	L	30 lb.	26	Mil (+3)

* See weapon description for details.

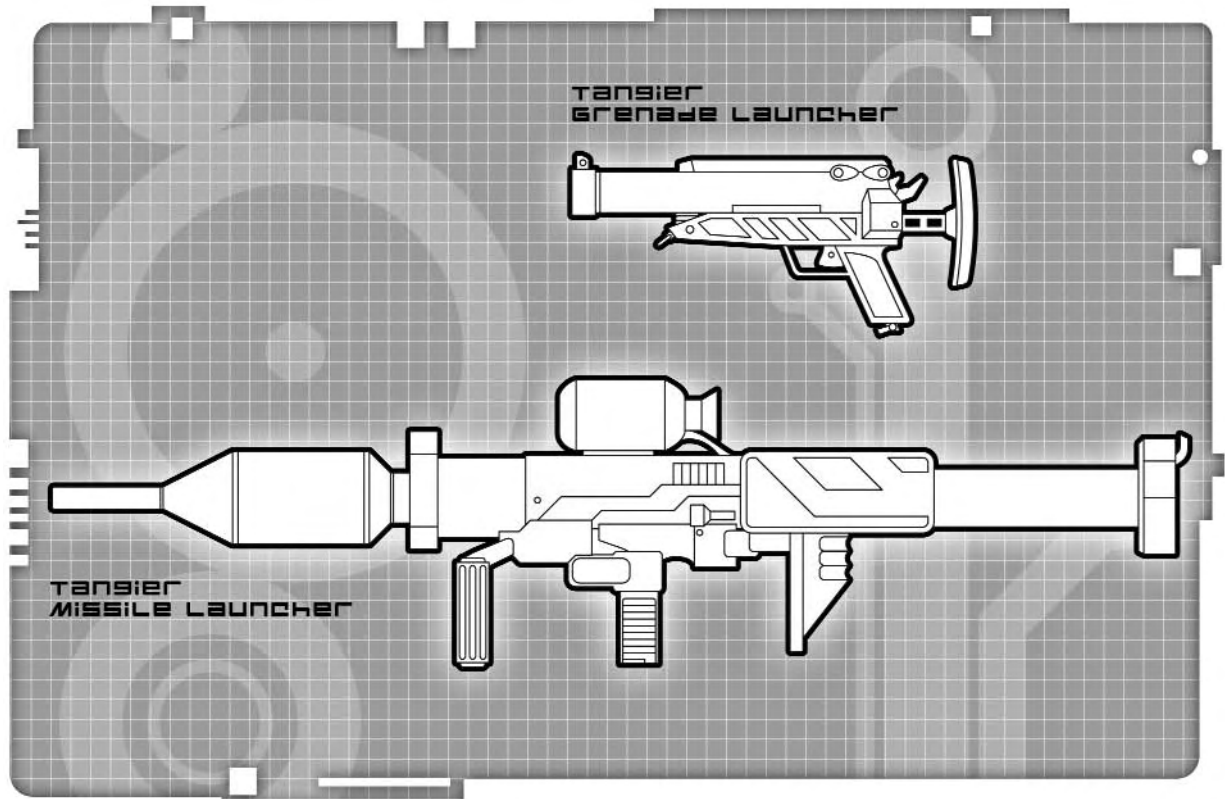

heads have a purchase DC of 16 per missile, and each missile weighs 3 pounds (a clip weighs 14 pounds).

◆ OTHER RANGED WEAPONS Tantas Frontier Hold Out

Originally one of the first professors of archaeology at Dawning Star University, Mina Tantas retired ten years ago. One of the trinkets she had brought from Earth was a gift from her grandfather, an old derringer pistol. After hearing about several groups of explorers being caught unprepared by spitter spiders, she started looking at her resources at hand for a solution. The result is this derringer-style firearm, each one a unique masterpiece of craftsmanship. The first was gifted to one of her students, and others are given only to those who've done something significant for the city.

This weapon is considered mastercrafted and

provides a +1 equipment bonus to attack rolls. Due to the small size and special design of the Frontier HO, Sleight of Hand skill checks made to conceal the weapon enjoy a +4 circumstance bonus.

Velin Hunting Bow

Made of the rib bones of the murcow and several species of plant life native to Eos, the velin hunting bow favors range and accuracy over knock-down power. The string of the velin hunting bow is normally made out of several dozen velin hair strands, all taken from different friends and allies of the velin who will use the bow. Because of this, velin hunting bows are very personal items, and velin treaties or alliances are often cemented with a gift of hunting bows.

Velin Throwing Blade

Velin throwing blades are made of the various

OTHER RANGED WEAPONS

Weapon*	PL	Damage	Critical	Damage Type	Range Increment	RoF	Magazine	Size	Weight	Purchase DC	Restriction
Tantas Frontier HO	4	2d4	20	Ballistic	20 feet	S	6 int.	Tiny	2 lb.	-	-
Velin Hunting Bow (Archaic)	2	1d8	20/x3	Piercing	60 feet	S	-	Large	4 lb.	10	-
Velin Throwing Blade (Archaic)	2	1d6	19-20	Piercing	10 feet	S	-	Small	2 lb.	6	-
Velin War Bow (Exotic)	2	1d8	20/x3	Piercing	50 feet	S	-	Large	5 lb.	11	-

* The weapons listed require the Personal Firearm Proficiency unless otherwise noted.

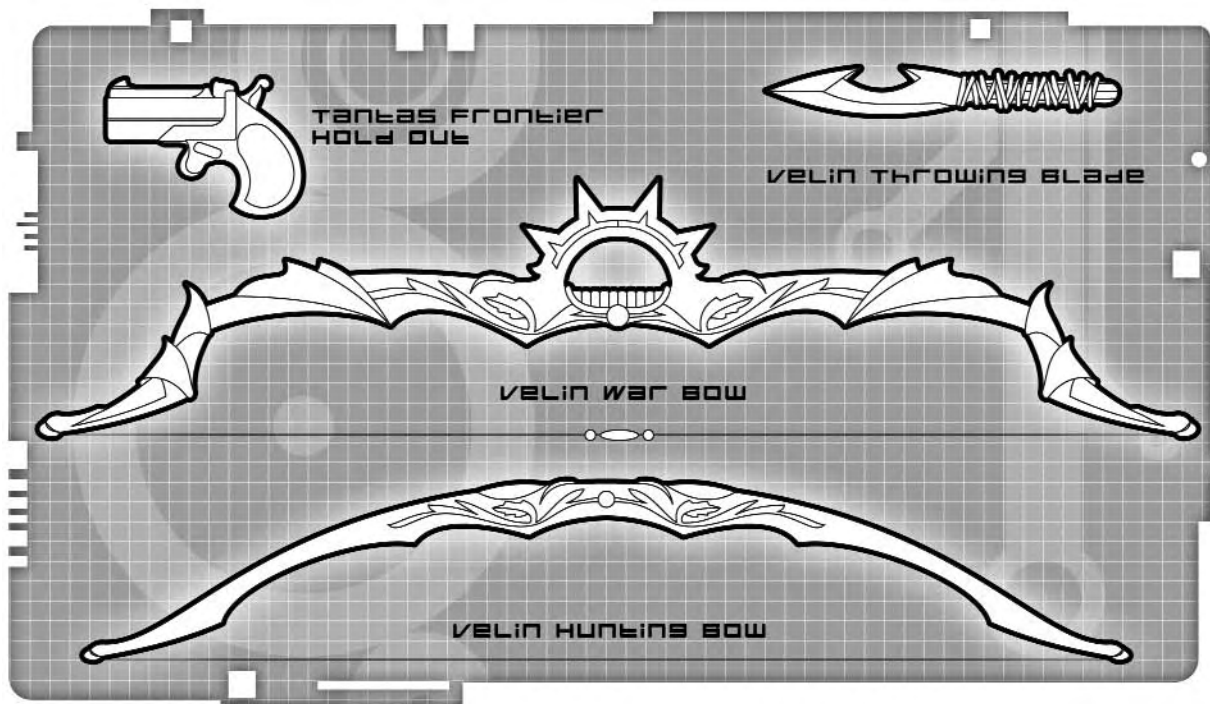

metals scavenged from the ruins of Eos. These metal shards are sharpened and then affixed to a leather-wrapped handle. The weapon is hurled by the handle at an enemy at close range, usually right before melee combat is entered. Velin throwing blades are also sometimes used as grappling hooks in a pinch and can be used in melee combat as well. Velin throwing blades used in melee combat inflict 1d4 points of piercing damage but suffer a -2 penalty on attack rolls.

Velin War Bow

While velin hunting bows are all about community, war bows are strictly about combat. The weapon is made of Dawson dragon bones and hide, and the bowstring is made of wrapped hair taken from the heads of the velin's slain enemies. War bows are usually hidden away by velin in their dwellings, only brought out when stories of great victories are told

or when war comes to their doorstep. Most of the time, they are ignored due to the heavy cloud of violence that follows them.

Velin war bows are covered in spikes and blades that allow the weapon to be used in melee combat, inflicting 1d8 points of slashing damage and having a critical of 19-20/x2. When used in this way the war bow is treated just like a melee weapon.

AMMUNITION • • •

Several new types of ammunition are available in Dawning Star.

Gyro-Jet Ammunition

Gyro-Jet rounds appear like regular rounds, but they contain tiny rocket systems, which are ignited after launch. In this way, the projectile has constant acceleration from the moment it is fired until it hits its target.

AMMUNITION

Ammunition Type (Quantity)	Damage Type	Purchase DC
ARQUEBUS HEAVY GYRO-JET		
◊ Explosive	Concussion	15
◊ Flechette	Piercing	16
BRASE 10-GAUGE		
◊ shotgun shell (20)	Ballistic	6
Brase 7.62mm (50)	Ballistic	5
EDF 10mm (50)	Ballistic	5
EDF 13mm (50)	Ballistic	6
Frontier HO (10)	Ballistic	4
GP-02 GYRO-JET PISTOL		
◊ Normal (10)	Ballistic	6
◊ Flechette (10)	Piercing	7
◊ Explosive (10)	Concussion	8
GP-05 GYRO-JET RIFLE		
◊ Normal (20)	Ballistic	7
◊ Flechette (20)	Piercing	8
◊ Explosive (20)	Concussion	9
GR-09 SMART GYRO-JET RIFLE		
◊ Normal (20)	Ballistic	9
◊ Flechette (20)	Piercing	10
◊ Explosive (20)	Concussion	11
Power Pack	Special	10
Power Pack, Back	Special	12
Power Pack, Belt	Special	14
TANGIER MISSILE LAUNCHER		
◊ Explosive (1)	Concussion	14
◊ Armor Piercing (1)	Concussion	16

Flechette

Flechette ammunition reduces the effectiveness of armor, but it deals one less hit point of damage per damage die. Any attack with flechette ammunition ignores up to a +2 of any equipment bonus from armor. It has no benefit against targets that are not wearing armor.

Explosive

Explosive gyro-jet ammunition is very expensive and difficult to come by in most areas. Explosive ammunition deals 1 extra die of damage of the appropriate type for the weapon.

Power Packs

In addition to standard power packs, described in the Future SRD, energy weapons in Dawning Star can be powered by larger, mobile power packs housed in belts and backpacks. These devices con-

nect to the weapon via a cable that has a hardness of 8 and 6 hit points. Power packs for plasma weapons are not interchangeable with those for other energy weapons, such as the EDF line of laser weapons.

Belt Power pack

These power packs come in the shape of plastic boxes the size of a hip pouch that clip onto the belt. They have four ports for plugging in weapons or other items. Belt power packs hold 100 charges and weigh 4 pounds. They must be specified as plasma or energy power packs at the time of purchase.

Back Power pack

The size of a small backpack, these hard plastic power packs have a number of straps that go over the back and around the waist in order to be fully secured. They have four ports for plugging in weapons or other items. Back power packs contain 200 charges and weigh 6 pounds. They must be specified as plasma or energy power packs at the time of purchase.

WEAPON GADGETS • • •

The Future SRD introduced the gadget system for customizing weapons. All of those weapon gadgets are available on Eos, though some are more common than others. The following gadgets are also present.

Plasma Efficiency Matrix

Weapons fitted with this gadget require less energy to create and control plasma and use one less charge from the power pack when used.

Restrictions: Plasma weapons only.

Purchase DC Modifier: +4.

Reflecting Spread Module

This modification increases the crystal focusing matrix of a laser weapon so that the beam has a larger cross section, increasing the chance of hitting a target. This mod gives the weapon a + 1 attack bonus, but reduces the damage by -1 per die.

Restrictions: Laser weapons only.

Purchase DC Modifier: +3.

ARMOR • • •

While armor is rarely worn inside Dawning Star or its immediate environs, the farther you get from the city the more prevalent it becomes. While few people wear actual combat armor, armor that protects from the elements or is particularly light, including rough outs and exposure suits, are very common among those who work in the Eotian wilds. Among the more militant or dangerous faction-camps, combat armor is more common. Many ranchers and other independents have an old suit of light combat armor or something similar, which is

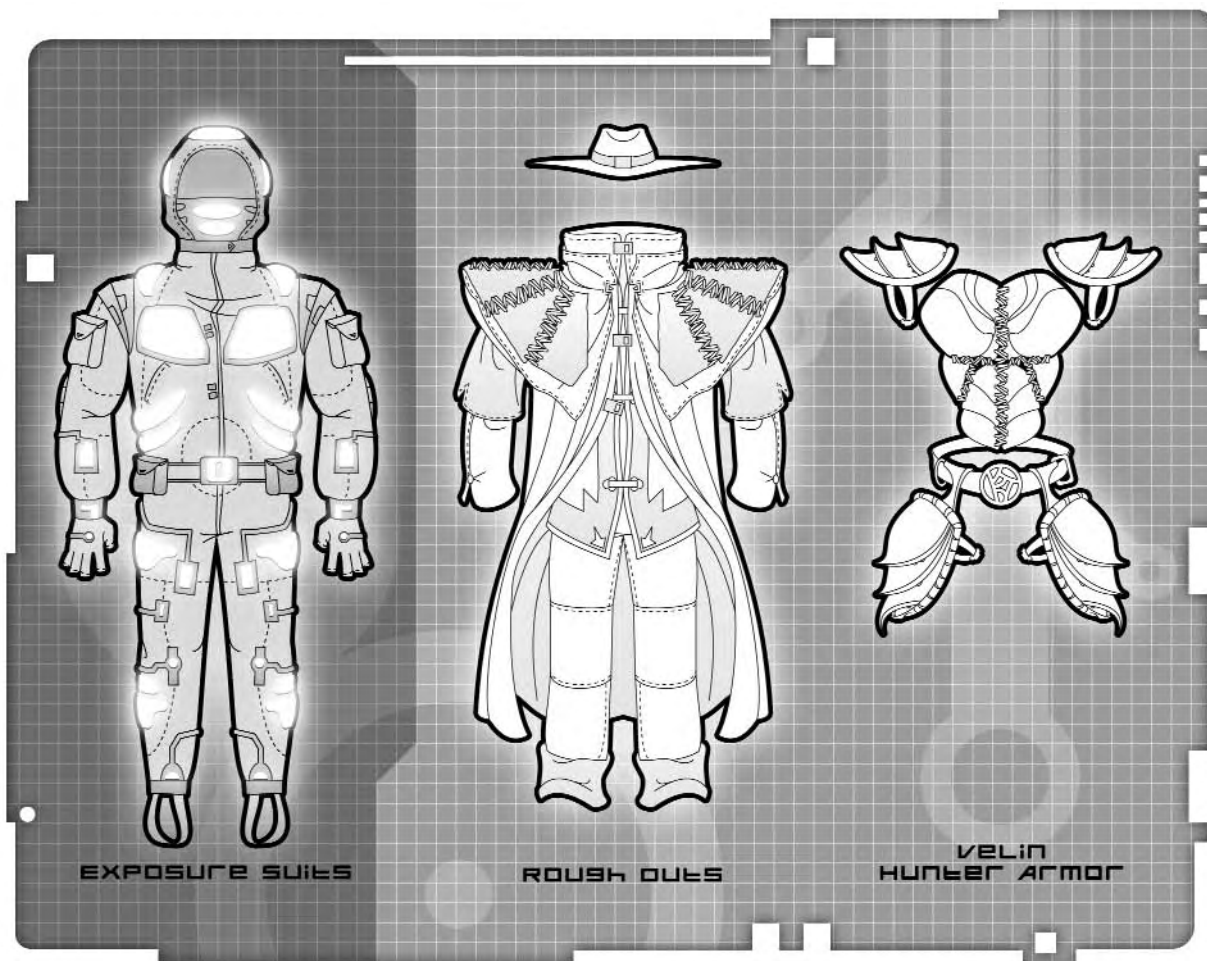

stowed away until it is needed.

Within Dawning Star, only the police, the Republic Militia, and the Eos Defense Force wear armor. Generally speaking, a civilian openly wearing armor in Dawning Star is seen as rude, suggestive of a faction-camp thug. The velin often wear armor when hunting, when going to war, or for certain rituals. Wearing armor casually is a common practice among their tribes, something that throws off many citizens of the Dawning Star Republic.

◆ LIGHT ARMOR Exposure Suits

Exposure suits are made of a number of advanced fabrics controlled by a central processing unit built into the suit that allows the fabrics to heat up, cool down or constrict to lessen the impact of incoming attacks. Exposure suits look like a full-body jumpsuit with a large number of pockets and several patches of glow in the dark material, which provide a 10 foot light radius when activated. Exposure suits are primarily designed to protect against severe weather, but they also provide some protection against attacks. Due to their expense, exposure suits are usually only found among the wealthiest air runners and ranchers, though they are less expensive than survival suits. The fabrics and electronics used in the exposure suit are very rare and most of such materials are used to pro-

duce other goods. The only regular source of exposure suits is Willem Brender, a resident of Dawning Star who spends most of his days as a tailor.

Wearing an exposure suit confers a +6 equipment bonus to Fortitude saves against severe weather.

Rough Outs

A mixture of Kevlar, murcow hide, and some plastic plating, rough outs consist of a pair of pants, a long sleeve shirt and a long coat, and occasionally a hat thrown in for good measure. Rough outs are the most common form of armor among ranchers, and most ranchers in the wild live in their rough outs for days on end. Rough outs are made by a number of craftsmen both in Dawning Star and the faction camps. Even some velin are getting into the business; although their armor tends to have a purplish hue that many ranchers do not prefer compared to the normal grays and browns of human rough outs.

Wearing a rough out confers a +2 bonus to Fortitude saves against severe weather.

Velin Hunter Armor

Made primarily from murcow plating and Dawson dragon bones, velin hunting armor is a suit of leather armor with bone plating sewn onto many of the larger pieces of the suit. The armor is light and

very quiet, but does not provide as much protection as more advanced armors. Only the velin wear this armor normally. Some humans have taken to wearing it, but this choice tends to get a lot of raised eyebrows from other humans. Some velin have taken to wearing human armor, but most prefer their own designs.

◆ MEDIUM ARMOR EDF Combat Armor

The standard issue of the Eos Defense Force, EDF Combat Armor is a full-body suit of ceramic armor with a built-in computer system and heads-up display in the helmet. All suits of EDF Combat Armor are equipped with built-in hand-held navigator, night-vision goggles, flashlight, radio, and satellite hookup. This level of communication allows the Eos Defense Force to easily coordinate infantry maneuvers and get necessary information to its soldiers in the field. This armor is occasionally made available to Republic Militia members, though it is rarely seen outside the Eos Defense Force.

The Eos Freedom League occasionally gets suits of EDF Combat Armor second hand, but the electronic features are usually not functional in such cases. These suits have a Purchase DC 18.

Velin Battle Armor

Made from metal scraps found in the ruins of Eos and murcow hide, velin battle armor is usually only

worn when a tribe is going to war or when a warrior expects to face large, hostile creatures in the near future. The velin do not show the same disdain for wearing armor that humans do, but a velin wearing his battle armor sends a message to all that he intends to do serious battle soon. Velin battle armor is somewhat cumbersome, but many of the materials used in its construction defy human knowledge of metallurgy and are incredibly tough. Some humans have taken to purchasing their own suits of velin battle armor after seeing how effective it can be, even against firearms.

◆ HEAVY ARMOR EDF Assault Armor

Only a limited number of troops on the Eos Defense Force are equipped with this type of armor, largely due to its bulk, weight, and expense. EDF Assault Armor is made out of old armor plating from the Dawning Star herself, and wearing it is considered a great honor within the Eos Defense Force. Currently the 1st Ground Assault Company is the only unit to be completely outfitted with EDF Assault Armor, though a limited number of suits have shown up in other Eos Defense Force units and some police forces around the Dawning Star Republic for special situations. The armor is not generally available to the public, and the faction camps lack the technology to create EDF Assault Armor due to its singular source of materials. The EDF Assault armor

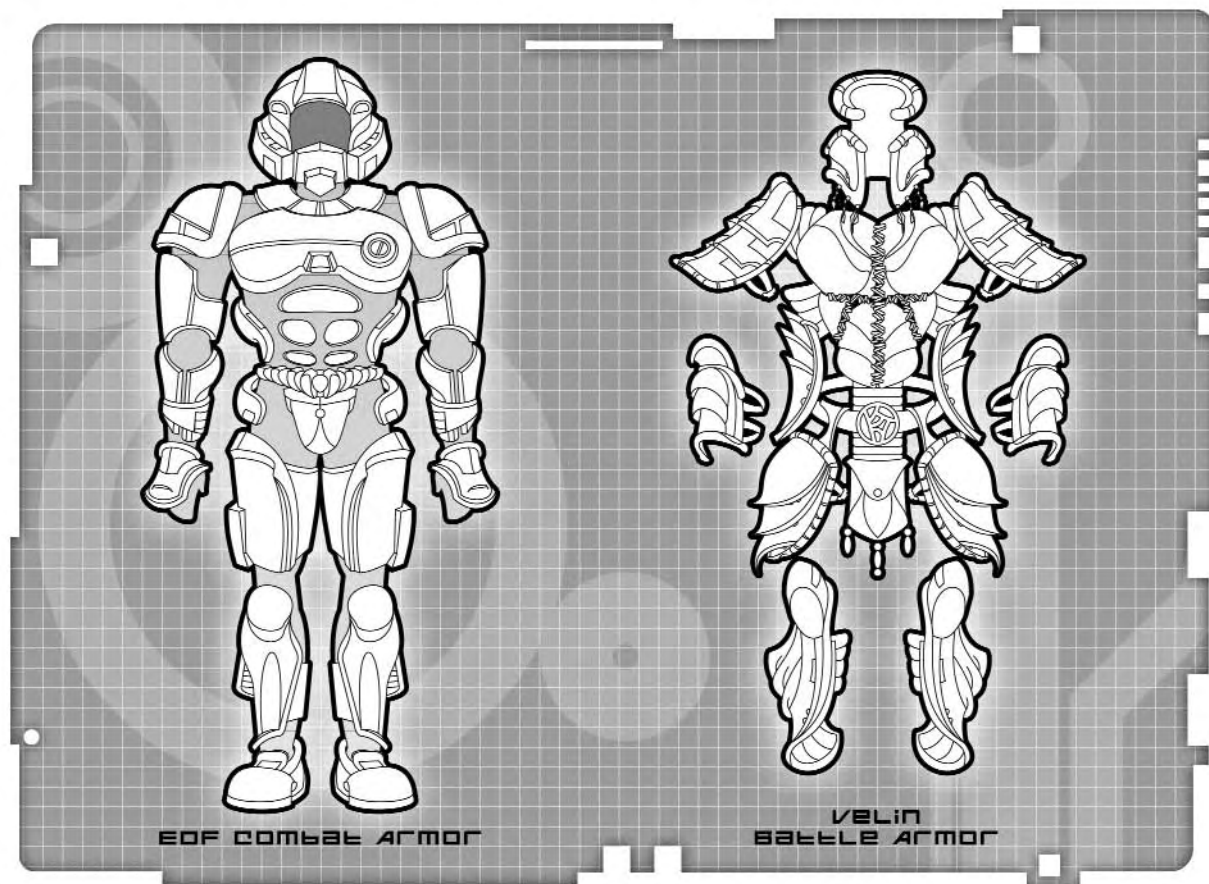

has the same electronic features as EDF Combat Armor: hand-held navigator, night-vision goggles, flashlight, radio and satellite hookup.

Heavy Combat Armor

The Eos Freedom League's answer to EDF Assault Armor, this rare suit of armor is primarily made from specially prepared durasteel plates and metals scavenged from the ruins of Eos. While it does not have the protection of the EDF Assault Armor, it does come close and is more effective than most lighter forms of armor. The armor is plated in several areas with luminstone, including the gauntlets. These luminstone plates provide a light radius of 20 feet but can be covered up as a move action to eliminate the radiance. Heavy combat armor comes equipped with a radio but does not have the other advanced functions of the EDF armors.

◆ POWERED ARMOR DS Construction Unit

Originally not designed to be used as a suit of armor, the DS construction unit was created as a robotic suit to help with repairs to the Dawning Star and her escort ships. Three dozen were assigned to the Dawning Star and most remain in active service. They are a common sight in many of Dawning Star's cargo ports and construction areas. In the early days of the Republic, when clashes with hostile wildlife were more common, a number of DS

construction units were modified to add armor plating and mounts for weapons, turning them into suits of powered armor for a single occupant. These suits never saw much action—the Battle of Red Hill being the only notable engagement in which they took part—but they have been a steady presence in Dawning Star. The sight of a ten-foot-tall suit of robotic armor is enough to put most criminals and dissidents to flight. DS construction units are almost never available for sale and any sighting of an unauthorized user within the borders of the Dawning Star Republic is sure to end in arrest.

The DS construction unit comes standard with a heads-up display with target HUD software, radio, a large glow lamp (double normal range), 200 feet of duracable, and ten grapple tags for dragging objects too heavy to lift. The DS construction unit also has a built-in back power pack containing 200 charges for laser weaponry. The DS construction suit can only be used by Medium characters. Individual suits are often equipped with built-in weapons, such as lasers, grenade launchers, or tangler guns. The DS construction unit grants a +10 equipment bonus to Strength.

While wearing a DS construction unit, the operator is considered Large. Wearers suffer a -1 size penalty to Defense, a -1 size penalty on attack rolls, and a -4 size penalty on Hide checks. Wearers gain a +4 size bonus on grapple checks. Lifting and carrying limits are twice those of a Medium character.

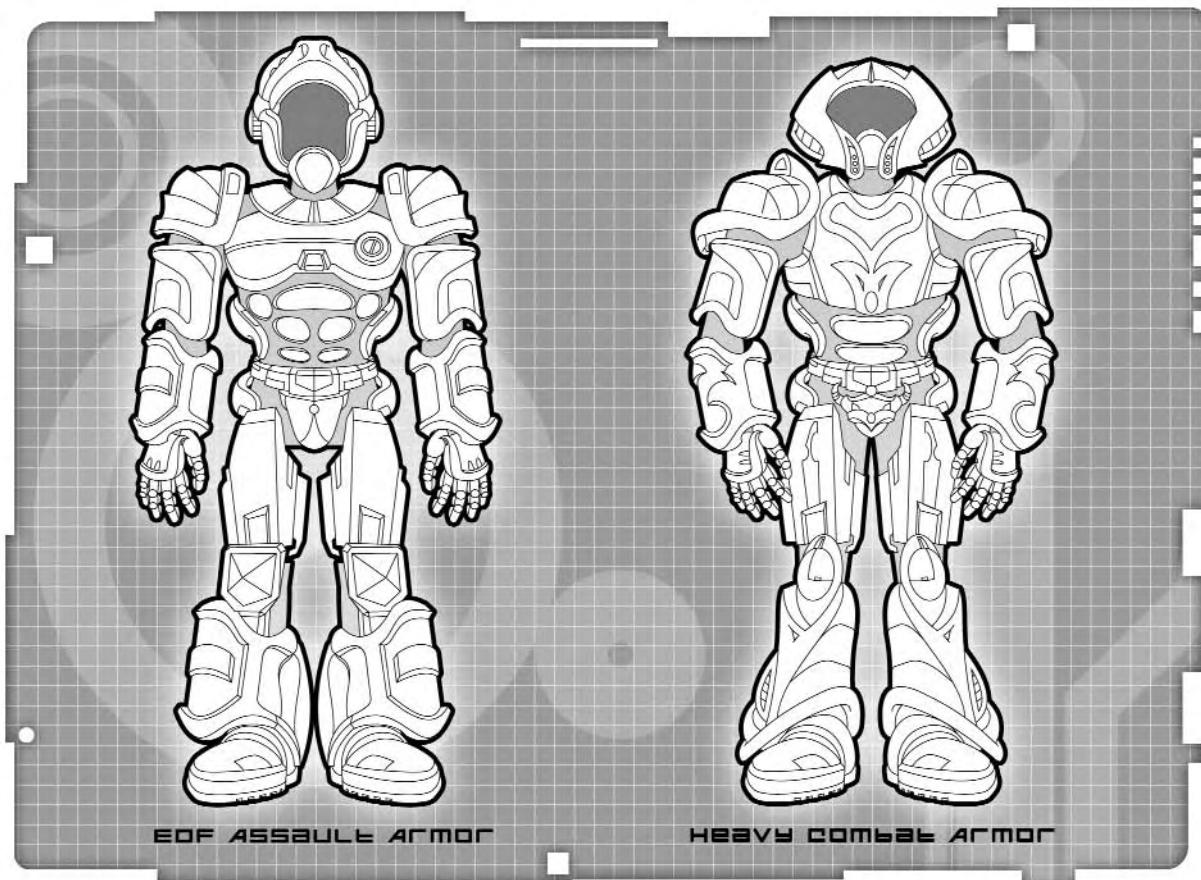

ARMOR

	PL	Type	Equipment Bonus	Nonprof. Bonus	Maximum Dex Bonus	Armor Penalty	Speed	Weight	Purchase DC	Restriction
LIGHT ARMOR										
Exposure Suits	5	Tactical	+2	+1	+7	-0	30 ft./20 ft.	6 lb.	16	-
Velin Hunter Armor	3	Archaic	+3	+1	+8	-0	30 ft./20 ft.	14 lb.	15	-
Rough outs	4	Tactical	+3	+1	+5	-2	30 ft./20 ft.	30 lb.	15	-
MEDIUM ARMOR										
EDF Combat Armor	6	Tactical	+6	+2	+3	-2	25 ft./15 ft.	28 lb.	22	Res (+2)
Velin Battle Armor	3	Archaic	+6	+2	+3	-3	25 ft./15 ft.	34 lb.	20	-
HEAVY ARMOR										
Heavy Combat Armor	5	Tactical	+8	+3	+1	-6	20 ft./15 ft.	45 lb.	24	Res (+2)
EDF Assault Armor	6	Tactical	+9	+3	+1	-6	20 ft./15 ft.	35 lb.	26	Mil (+3)
POWERED ARMOR										
EFL Robotic Combat Armor	6	Tactical	+9	+3	+0	-8	20 ft./-	240 lb.	27	Mil (+3)
DS Construction Unit	6	Tactical	+10	+3	+0	-16	20 ft./-	400 lb.	29	Mil (+3)
Space Suit, Assault	6	Tactical	+10	+3	+0	-10*	20* ft./-	269 lb.	27	Mil (+3)
SPECIAL ARMOR										
Velin War Shield	4	Tactical	+2	+0	+6	-2	30 ft./ 20 ft.	15 lb.	16	
* This is for zero-g conditions.										

Huge weapons may be wielded with two hands, and Medium weapons are treated as light weapons. DS construction units occupy a 10-foot-by-10-foot fighting space and have a natural reach of 10 feet.

Unarmored DS construction suits have an armor bonus of +5 and no target HUD software. These suits have a Purchase DC of 25.

EFL Robotic Combat Armor

Constructed using a number of hydraulic units, some servomotors and whatever armor plating could be scrounged together, the Eos Freedom League has managed to produce a number of suits of powered armor. Although they do not have all the features of the DS construction unit, they are less cumbersome and easier to manufacture. Only a handful of these suits have been built, and most are stored in Roger's Point in case of an attack by the Dawning Star Republic. Outside of Roger's Point, they are often used by faction-camp scavenger squads that pick through the ruins of Eos looking for useful items due to the strength of the suit and its impressive protective abilities.

The EFL robotic combat armor comes equipped with a glow lamp. It can only be used by Medium characters. The EFL robotic combat armor grants a +8 equipment bonus to Strength.

While wearing a suit of EFL Robotic Combat

Armor, the operator is considered Large. Wearers suffer a -1 size penalty to Defense, a -1 size penalty on attack rolls, and a -4 size penalty on Hide checks. Wearers gain a +4 size bonus on grapple checks. Lifting and carrying limits are twice those of a Medium character. A Huge weapon may be wielded with two hands, and Medium weapons are treated as light weapons. EFL Robotic Combat Armor suits occupy a 10-foot-by-10-foot fighting space and have a natural reach of 10 feet.

Space Suit, Assault

Assault space suits were carried on the Dawning Star and several of her military escort ships to be used in case of boarding actions against other ships. Since the deconstruction of the Dawning Star, these have remained in storage because they are too large and bulky to be easily used on a planet's surface and there is currently little use for them in space. The Eos Freedom League continues to pursue development of their own fleet of spacecraft. In such an eventuality, assault space suits will likely see use again.

An assault space suit consists of a thick bodysuit and a tight-fitting armored helmet. Over this base, an exoskeleton is attached, on which are mounted numerous plates and pads. Despite the ease of moving in zero-g conditions, one must still over-

come inertia, and moving in such a heavy suit would be very difficult without some type of powered assistance. The suit contains a full life support system and is self-sealing if punctured. The helmet contains a heads-up display, and the suit's computer can interface through a radio or satellite hookup with other suits and computers to coordinate attacks. The heads-up display also shows the current oxygen levels and biological information on the wearer of the suit; this information is also broadcast to other suits in the same unit. The assault space suit also comes with a jet pack, 200 feet of duracable, and 5 grapples. It holds 24 hours of oxygen, food, and water; once expended, the supply tanks must be changed.

The assault space suit grants a +6 equipment bonus to Strength. If the suit is worn in a non-zero g environment, its Maximum Dexterity Bonus becomes +0, it actually confers a -4 penalty to Dexterity, and its base speed (30 ft.) is reduced to 10 feet.

◆ SPECIAL ARMOR Velin War Shields

The velin often use metal shields made from scavenged materials taken from the ruins they inhabit. These metal shields are painted to denote which tribe the user is from and any important deeds he has accomplished using a primitive system of heraldry. Due to the strong materials used in these shields, they are even effective against firearms and energy weapons. The Archaic Weapon proficiency is needed to use a velin war shield. The equipment bonus provided by the war shield stacks with the equipment bonus from other armor worn, and the Armor Penalty is cumulative with any penalty from other armor worn.

COMPUTERS • • •

Despite being the backbone of a PL 7 society, computers are surprisingly rare on Eos. Due to the limited industrial capacity of the colony, the ability to manufacture microchips is hampered. Most computers were brought over from Earth on the Dawning Star. The majority of the Dawning Star's systems have been disassembled for parts, and many of these have since gone into the few computers scattered around the colony. Outside the Dawning Star Republic, computers are only found in the larger faction-camps, such as Roger's Point. This is one of the primary limiting factors in expanding communication, industrial capacity, and the colonists' comprehension of the planet. There is hope that tentaari nanotechnology will help with this problem and make creation of computer parts easier, but so far the lack of progress in understanding nanotechnology has darkened these hopes.

Most of the computers are linked through cables or wireless networks to the Eos version of the internet (Eonet). This shared computing environment is

filled with information on various areas of the planet, communication streams, and files on important topics like history and survival techniques. The Eonet remains strictly information-oriented and contains very little of commercial interest. The Eonet is controlled by the Dawning Star Republic, but it can be accessed by any computer with an appropriate hook-up. Due to this fact, the Dawning Star Republic does not store any vital information in Eonet-accessible locations due to fear of the faction camps hacking into their systems. Despite the Dawning Star Republic's safeguards, their computer defenses have been occasionally defeated. In general, however, there are few hackers among the people of Eos.

There are no artificial intelligence systems on Eos, and programming has not progressed to the point of enabling programs to become self-aware. Many programs are created with a "personality" and limited self-direction in an attempt to make programs more efficient. Such programs try to guess the wants of their users and try to carry out commands and generate new commands even when their user is not present. Such programs, called "app-3" for Artificial Personality Program, version 3, are created with an interface that can be used verbally, by keystroke, or through neural links that are programmed to respond in a fashion that seems like-life but are really just a set of preprogrammed responses. These advanced programs are used primarily in areas where they must interface often with humans who are not skilled with computers, creating a facade of humanity on the part of the computer to provide a sense of security. App-3 programs can run on most any computer currently used on Eos.

Computer Cataloger

A combination computer and scanning device, these handheld computers were used by the terraformers of the Dawning Star to gather information on the indigenous creatures of Eos. These devices are able to scan any life form within 5 feet and give basic information on the creature, such as what type of creature it is, its most recent meal, likely habitat, any natural weapons, etc. With a successful Computer Use skill check (DC 15) the user can identify five of the creature's qualities, including size, natural armor bonus, ability scores, and special qualities. It cannot determine hit dice, hit points, Defense, or saving throws. It also grants a +4 equipment bonus to Knowledge (Earth and Life Sciences) and Treat Injury skill checks.

DS Belt-Comp

A common device among the members of the Dawning Star Republic's military and civilian employees, belt-comps are made out of parts of the Dawning Star's computers inside the housing of old

spacesuit control belts. Capable of running for 96 hours before recharging, these belt computers are extremely powerful, portable computers that are capable of interfacing with most other computers. They come equipped with wireless network connections and can easily connect to the Eonet.

Info-Comp

One of the few common types of computers on Eos, info-comps were assigned to every passenger and crew member on the Dawning Star as a means of quickly dispersing information through the colony, enabling communication, and providing a diversion during the long and boring days of the early colony. An info-comp is a fairly basic computer that can access the Eonet through a wireless network connection, send text messages, receive news reports via the Eonet and video broadcasts, and has a small selection of video games. Many people still use their info-comps regularly and they are ubiquitous in most areas of the Dawning Star Republic.

users rarely develop a fondness for the program. The App-3 basic is considered to have a +4 skill bonus in Computer Use and can make skill checks at the direction of the user, including making checks to aid another when directly aiding the user.

App-3 Program, Advanced

A more advanced and thorough version of the App-3 program, the App-3A has a sufficiently complex personality and logic system that some users begin to think of the program as something of an electronic pet. The App-3A can communicate verbally or through text at the discretion of the user. The App-3A is considered to have a +6 skill bonus in Computer Use and Research. The App-3A can make skill checks at the discretion of the user or at its own discretion if it thinks the skill check would be advantageous to its user. When using the aid another action to assist the user, the App-3A grants a +4 circumstance to the user's Computer Use or Research skills.

App-3 Program, Expert

The current height of programming, the App-3X has an almost life-like personality that adapts over time to different users, based on their feedback. The App-3X has a +8 skill bonus in Computer Use, Knowledge (Civics, History, Local), and Research. The App-3X can make skill checks at the discretion of the user or at its own discretion if it thinks the skill check would be advantageous to its user. When using the aid another action to assist the user the App-3X grants a +6 circumstance to the user's Computer Use, Knowledge (Civics, History or Local), or Research skills.

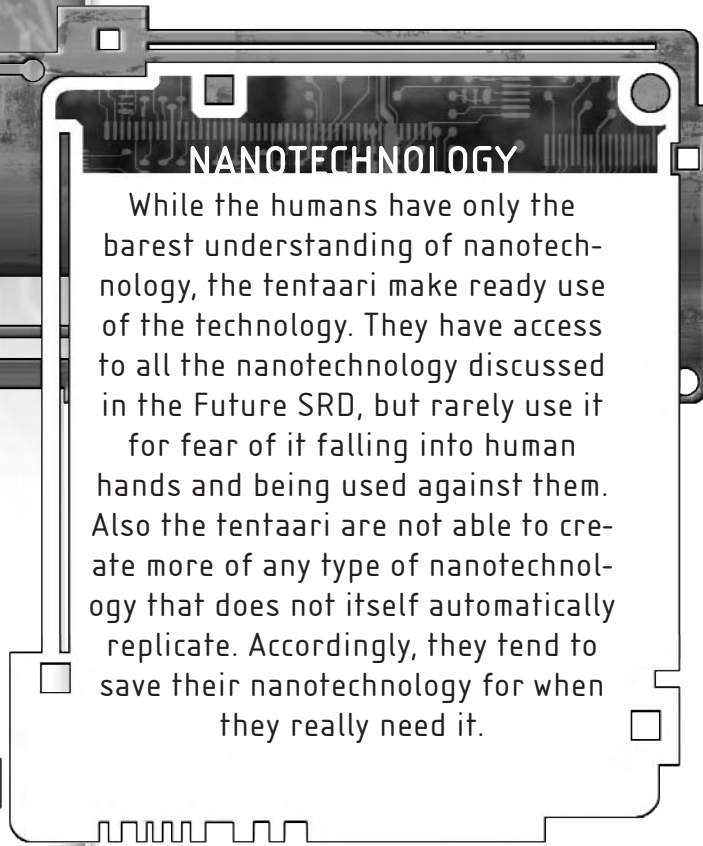

NANOTECHNOLOGY

While the humans have only the barest understanding of nanotechnology, the tentarii make ready use of the technology. They have access to all the nanotechnology discussed in the Future SRD, but rarely use it for fear of it falling into human hands and being used against them. Also the tentarii are not able to create more of any type of nanotechnology that does not itself automatically replicate. Accordingly, they tend to save their nanotechnology for when they really need it.

App-3 Program, Basic

This large and complex program is essentially a very-user friendly operating system and user interface combined with limited artificial intelligence programs to predict and accommodate the user. This basic level App-3 program communicates primarily through text and has limited abilities when not directly receiving commands from its owner. The artificial personality of the App-3 basic is blunt, and

COMPUTER EQUIPMENT				
Name	Weight	Size	Purchase DC	Restriction
Computer Cataloger	2 lb.	Tiny	22	-
DS Belt-Comp	4 lb.	Small	20	-
Info-Comp	1 lb.	Tiny	14	-
App-3				
Basic	-	-	17	-
Advanced	-	-	20	-
Expert	-	-	26	-

TERRAFORMING EQUIPMENT • • •

Situated just to the north of Dawning Star, the Terraforming Fields are the second largest man-made construction on Eos, behind the city of Dawning Star itself. Covering several square miles and comprised of huge atmospheric converters,

chemical refineries, extensive research stations, the creature tanks, and several chemical storage tanks, the Terraforming Fields are an impressive sight. Now, they sit mostly idle, the major terraforming processes having long since finished on Eos.

The terraforming process on Eos was much easier than was anticipated with the original destination in Lalande 21185. On Eos, it was simply a matter of altering the content of the atmosphere slightly and introducing new Earth life forms to Eos, a process that is still ongoing. Giant atmospheric converters released oxygen into the atmosphere for over thirty years while removing excess carbon-monoxide and other chemicals, a process that eventually made the world completely suited for Earth life forms. In the process, several native species were disrupted and it is expected that a handful went extinct due to the changes in their environment. Most terraformers consider the losses negligible and claim that they will not unduly threaten the environment.

The goal of the terraformers now is the controlled introduction of terran life forms into the Eos ecosystem without causing any major disruptions. This is a process that is expected to take over a hundred years, as the *Dawning Star* brought specimens and samples for cloning of over five thousand species of creatures that were thought necessary to support a human-friendly ecosystem. While some species, such as domestic cats and cows, have already been introduced, they are carefully studied by the terraforming science team. Historically wild animals, such as large felines or ursines, have not yet been introduced into the environment due to the fact the terraformers do not feel comfortable with their ability to observe the lives of such creatures.

The creature tanks have the capacity to clone dozens of creatures from stored genetic material brought from Earth, but the resources for doing so are very limited. Only those species that provide a boost to the colony are being cloned currently, a procedure that is not likely to change until the colony gets much larger. The creature tanks are the only fully functional genetic engineering facility on the planet. While they could theoretically engage in human genetic engineering, such procedures have not been cleared by the Dawning Star Republic. Some of the faction-camps have struggling genetic engineering facilities that claim to offer gene therapy treatments, but such places invariably suffer a high mortality rate.

CYBERNETICS • • •

Limited by their lack of industrial power, cybernetics are a rarity on Eos. Those that do exist are mostly items brought over from Earth by colonists or as part of the *Dawning Star's* medical supplies. Due to the lack of cybernetics, they are normally reserved for those who need them for medical reasons, such as amputees. Cybernetics that simply

GENETIC ENGINEERING

The humans of *DAWNING STAR* are in the infancy of PL 7 technology. However, they are hampered from using the extent of that knowledge due to their limited resources.

Due to this limitation, genetic engineering, while technologically feasible, is very rare on Eos and usually very dangerous.

Scientists on Eos are capable of instilling templates and special qualities through genetic engineering.

This process is very dangerous unless done at the creature tanks (which is unlikely because of the limited resources at the creature tanks). If a character receives gene therapy at one of the clinics in the faction-camps, each Fortitude save failed while acclimating to the treatment causes 1d6 points of

Constitution damage.

More specific information on genetic engineering, including the genetic engineering abilities of the *tentaari* and Eos-specific templates, will be covered in

DAWNING STAR: HEROES OF HELIOS.

augment the recipient are usually cannibalized for parts. Those who use implants for non-medical reasons are usually looked down on for taking up resources that could be used by someone who really needs them. This feeling is less present regarding those who had their implants installed on Earth, but even many of those colonists have willingly had their implants removed and used for parts, when the cybernetic supplies of the *Dawning Star* ran out. It is a common practice to remove cybernetic implants from the recently deceased so they may be passed on to someone who needs them, and some families even have hereditary implants that have been passed down through two generations of colonists. Even in the faction-camps, gratuitous cybernetic implants are seen as a sign of wealth and indifference to others.

Those who have cybernetic implants because they need them are not treated so, but the general lack of cybernetics has caused a resurgence of discomfort around those who have them. On Earth, cybernetics was common enough that most humans had gotten over the initial reaction of being put off by the mere concept of it. On Eos, however, this feeling has resurfaced. When combined with the rarity of cybernetics, many disabled people have opted for less advanced alternatives, such as crutches or seeing-eye dogs.

As a general rule, the purchase DCs of cybernetic implants contained in the Future SRD should be increased by +3-+5 to represent their scarcity. The Purchase DCs of the implants described below already include this factor.

Astrogation Cortex

This implant stores astronomical data and continuously compares it to the visual cues recorded by the implantee to provide navigational aid. This is useful for stellar navigation as well as ground navigation, but due to the small number of spacecraft active on Eos it is mainly used for surface navigation. It is a favorite among air runners, giving them a back-up in case their vehicle's navigation systems fail.

Benefit: As long as the user is in a stellar system for which the Astrogation cortex has been programmed, the user may take 10 on any Navigation roll as a move action.

Type: Internal.

Hardness/Hit Points: -/2 hp.

Base Purchase DC: 23.

Restriction: Lic (+1).

Heuristic Combat Cortex

Programmed with combat, bio-metric, and environmental statistics, this cybernetic enhancement forecasts likely movements and tactics used by a targeted enemy. This gives the user insight that will help him successfully strike his target. These devices were originally installed in many of the shipboard security personnel of the Dawning Star and have since passed to the elite members of the Eos Defense Force.

Benefit: This implant takes a few seconds to absorb new battle data, requiring one round to acquire information about any target within 60 feet. Any Dexterity and dodge bonuses to Defense of any target within range for at least one round are reduced by -2. These bonuses cannot be reduced below 0.

Type: internal.

Hardness/Hit Points: -/2 hp

Base Purchase DC: 28

Restriction: Mil (+3)

◇ WEAPON DIGITS

These cybernetic devices replace fingers or sometimes toes and can house a number of different weapons. While replacing digits was originally meant for vanity purposes, once weapons were added, it became more popular with those performing clandestine activities. They are especially favored among the Eos Freedom League. The Dawning Star Republic has declared all weapon digits illegal, and those entering its territory with them must submit to surgery to remove them or leave immediately. Most people consider weapon digits the sign of an assassin or insurgent.

Explosive

Considered by most to be the most dangerous and absurd of all digit weapons, the user can pull off the digit and use it as an explosive device.

Benefit: This finger is usually detached before being used as it carries a powerful explosive charge. It came be used as a set explosive, (see Demolition skill) or thrown as a grenade with a 10 foot range increment dealing 3d8 damage in 10' radius.

Type: External.

Hardness/Hit Points: 2/3.

Base Purchase DC: 21.

Restriction: Illegal (+4).

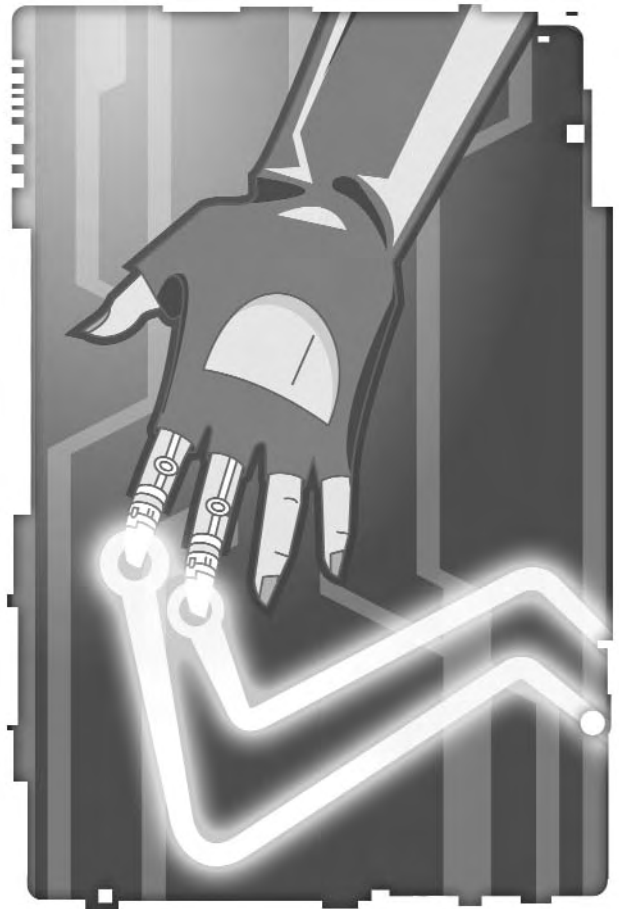

Micro-Laser

The digit can fire a small laser beam a short distance, but it only has a limited number of charges.

Benefit: Using the laser finger is an attack action that does not provoke an attack of opportunity. A micro-laser digit deals 3d6 points of fire damage, has a critical of 20/x2, and has a range increment of 10 feet. The internal battery provides enough power for 3 shots before it must be recharged. Recharging a micro-laser requires a special adapted plug and a laser power pack. The micro-laser requires 3 power pack charges per shot to recharge.

Type: External.

Hardness/Hit Points: 2/3.

Base Purchase DC: 18.

Restriction: Illegal (+4).

Poison Darts

The digit fires a small, poison-covered dart a short distance.

Benefit: With this weapon digit, a single dart can be fired as an attack action that does not provoke an attack of opportunity. The dart deals 1 point of piercing damage, has a critical of 20/x2, and has a range increment of 10 feet. A target damaged by the dart is exposed to any poison that might coat it.

Type: External.

Hardness/Hit Points: 2/3.

Base Purchase DC: 23.

Restriction: Illegal (+4).

RELICS • • •

Every year, scavengers from both the Dawning Star Republic and the faction-camps venture out into the ruins of the ancient cities of Eos in the hopes of finding some scrap of ancient technology that still functions—something that will make them rich. Every year, some disappear, while others spend the entire year searching and find nothing, forcing them back to their past lives as ranchers, farmers, or craftsmen. For the lucky few who actually find something of value, selling the object can be as hard as the hunt itself. Every group on Eos is after the advanced technologies scattered about the planet, and not everyone plays fair in acquiring them.

These relics are incredibly rare. To date, only a handful of functional relics have been found each year. These devices can fetch a small fortune and always have a purchase DC of 40+. There is no set pricing scale for relics as they are so rare. Generally, only governments and the wealthiest citizens of Eos can afford them. Often, the unearthing of a relic can lead to several weeks of wheeling, dealing, running, and fighting as those who found it try and stay alive while also making a profit on their discovery.

Relics can be any item of PL 8 or PL 9 or with FX abilities. Relics always have some sort of techno-

logical basis. While they may seem magical to humans, they are, in fact, the product of super-advanced science. Suitable pieces of technology are gravity-based or energy-age weapons, mecha, advanced cybernetics, or most any item that is portable. Relics are rarely larger than Large size (except for mech relics); most are hand-held. All relics are built to be used by races with a physiology similar to that of humans or velin.

A character using a relic suffers the normal penalties for using a device of a higher progress level than their technology familiarity. The Purchase DCs for technological relics are increased by +10 in addition to the standard increase for being of a higher progress level. For example, a PL 9 pulse rifle has a purchase DC of 49 (19 + 20 for being a 2 progress levels higher than 7 + 10 for being a relic).

If the device is an FX item, it follows the standard guidelines for FX items described in d20 Modern. Generally, relics are command-word or use-activated, and most have a limited number of uses of a specific spell or power each day. Armor, weapons, potions (normally in the form of injections or pills), rings, staffs, and wondrous items are all suitable as relics. All FX item relics should feel like objects that are possible through science and not like magical items that defy explanation. The spells and powers listed on the table on the following page are not suitable for use in FX item relics.

The Big Pill

A large, silvery, egg-like object, it is roughly an inch long and one half-inch wide. Its surface is flawless and highly reflective with no noticeable seams. Half a dozen Big Pills have been found among fortress ruins scattered across Eos, making them one of the more common types of relics. Big Pills do nothing until they are swallowed.

Once swallowed, the Big Pill activates in the user's throat, melting into a metallic gel and affixing to the walls of the throat and the esophagus. Although it is a little uncomfortable, it does not adversely affect eating or drinking. Once installed, the Big Pill filters all incoming food, liquid, and air for harmful elements, such as poisons or pollutants. The user receives a +4 bonus to Fortitude saving throws against poison, food-borne diseases, and other contaminants. The Big Pill also magnifies the nutritional content of anything consumed. This doubles the user's natural healing rate and increases his maximum age by 20 years, as long as the Big Pill remains in place.

The Big Pill remains active until the user dies. After death, it reforms into its inert form and can be removed and reused.

The Egg Stone of the Tundra Ruins

An egg-shaped stone found in a ruined city in the northern tundra regions of Eos, the only marks on

UNSUITABLE SPELLS AND POWERS • • •

ARCANE SPELLS

0 Level Arcane Spells

Detect Magical Aura
Message
Prestidigitation
Read Magic

1st Level Arcane Spells

Magic Weapon

2nd Level Arcane Spells

Arcane Lock
Glitterdust
Locate Object
Magic Mouth

3rd Level Arcane Spells

Dispel Magic
Flaming Projectiles
Greater Magic Weapon
Halt Undead

4th Level Arcane Spells

Animate Dead
Bestow Curse
Dimension Door
Remove Curse
Stoneskin

5th Level Arcane Spells

Phantom Watchdog
Wall of Iron
Wall of Stone

DIVINE SPELLS

0 Level Divine Spells

Detect Magical Aura
Read Magic
Virtue

1st Level Divine Spells

Bane
Bless
Magic Weapon
Shield of Faith

2nd Level Divine Spells

Aid
Augury
Zone of Truth

3rd Level Divine Spells

Animate Dead
Bestow Curse
Dispel Magic
Glyph of Warding
Prayer
Remove Curse
Searing Light

4th Level Divine Spells

Discern Lies
Faith's Fury
Greater Magical Weapon

5th Level Divine Spells

Break Enchantment
Flaming Wrath
Wall of Stone

PSIONICS

0 Level Telepath Powers

Detect Psionics

1st Level Telepath Powers

Attraction
Charm Person
Object Reading

2nd Level Telepath Powers

Sensitivity to Psychic Impressions

3rd Level Telepath Powers

Negate Psionics

4th Level Telepath Powers

Forced Mindlink

5th Level Telepath Powers

Power Resistance
Sending

0 Level Battle Mind Powers

Detect Psionics
Valor
Verve

1st Level Battle Mind Powers

Combat Precognition
Lesser Bioweapon

2nd Level Battle Mind Powers

Claws of the Bear

3rd Level Battle Mind Powers

Metaphysical Weapon
Negate Psionics

4th Level Battle Mind Powers

Greater Bioweapon
Psychofeedback

its surface are a series of glyphs and a set of five slight indentations, running along one face of the stone and spaced to accommodate a normal, human- or velin-sized set of fingers. If someone places their fingers in the holes, the device activates, levitating some four feet off the ground. The device remains active as long as the fingers are kept in place and for ten minutes afterward. While the device is levitating, it will support up 200 pounds of weight.

If a wounded person is placed under the device while active, it deploys a large number of spindly robotic arms concealed under its surface and quickly treats the wounded subject. It uses several unknown chemicals to speed the healing process, which it spontaneously generates within the housing.

The egg is one and one-half feet long and a foot wide at its widest point. It weighs 6 pounds, has a hardness of 15 and 10 hit points. The device will not levitate more than four feet above the ground. The stone's healing function is a full-round action that provokes an attack of opportunity. The person being treated must remain stationary beneath the stone while he is being healed. After one full round, the person being treated is healed 3d8+15 hit points, as cure serious wounds. This ability is usable five times per day.

Roger's Staff

A large, metal staff covered in metal plates of different materials, buttons, some runes, and topped off with a half-circle head piece, this device is said to be the source of Roger's Point's relative prosperity. Found by Patricia Rogers in 2029 while exploring some ruins to the west of Dawning Star, it has been at her side or in her presence almost constantly since. Rumors abound about the device; some saying it is itself intelligent and advises her on leading Roger's Point, while others hint that it gives her power over the minds of others. Regardless, her fortunes have improved dramatically since she found it. When she found the device, she was a lowly scout and surveyor for the Dawning Star terraforming program. Now, she leads the largest settlement outside of the Dawning Star Republic.

The Roger's Staff has a hardness of 30 and 10 hit points and may be used as a staff in combat. The Roger's staff psychically bonds to a single user, a process requiring the old user to willingly relinquish the bond. Alternately, if the old user is killed or is separated from the staff for 30 consecutive Eotian days, it will attune to the next person who touches it. Using ultra-low frequency broadcasts and certain subliminal effects, it grants its user a +4 bonus to Charisma as long as she holds it. Additionally, while held, the user may use the *mind darts* power. This power is usable 8 times per day. The staff doubtlessly has other powers as well, and more may be added at the discretion of the GM.

ATMOSPHERIC AND SURFACE VEHICLES • • •

The *Dawning Star* arrived on Eos with less than five hundred atmospheric and surface vehicles, ranging from tractors to tanks to high-altitude aircraft for collecting atmosphere samples. Most of these vehicles were for farming or transportation of terraforming personnel, but there were also 30 military vehicles for initial security purposes. In the early days of the colony, these devices were very well cared for, but due to a lack of spare parts many had to be cannibalized over time. This scarcity was finally solved in 2242, when the Styler Vehicle Plant came online in Dawning Star. The plant has been steadily churning out vehicles and spare parts since, limited only by the scarce resources of the Republic. The Styler Vehicle Plant is one of the largest users of iron from Iron Scar and is the primary consumer of rubber from the rubber fields in the Southern Resource Zone.

Most ground vehicles on Eos remain farming vehicles, and nearly all are equipped for off-road travel. Only Dawning Star, Iron Scar, and Roger's Point have paved roads. Dawning Star and Iron Scar are linked by a four-lane paved highway, but most other settlements are linked by dirt roads if at all. Nearly all ground vehicles on Eos are wheeled, though there are a small number of tracked vehicles. The latter are largely heavy industrial equipment or military vehicles, and they are rarely used on paved streets due to the damage such heavy vehicles inflict. Ground vehicles are a highly-valued possession on Eos, though their decreasing rarity is helping lower their prices. In many of the smaller settlements, animals and wagons are the most common forms of transportation.

The major coastal settlement on Eos is Roger's Point and most of the boats on the planet are concentrated there. A number of underwater ruins have been found on Eos in addition to ruins on some of the islands around Roger's Point. When combined with the thriving seafood market, these discoveries have created a boom in demand for boats and submersibles. No boats were brought on the Dawning Star, so all the watercraft have been built on Eos using makeshift supplies. Most of the boats are fairly small and rely on sails or small outboard motors, but a number of high-tech hydrofoils and large fishing boats have begun to appear in the area. In order to compete with Roger's Point's growing naval influence, the Dawning Star Republic is considering development of a coastal settlement on the edge of the Eastern Resource Zone, intending to use the Republic's industrial power to overcome Roger's Point's head start. There are a number of large, navigable rivers on Eos, several of which pass through the Dawning Star Republic, and the Republic employs a few barges to make use of these rivers. Given the lack of roads on Eos, these

VEHICLES FROM THE FUTURE

The Future SRD presents a host of new vehicles. The following vehicles are available in varying degrees in the DAWNING STAR setting.

Appel-Siems Gyrocopter
Bendel Motors Spirit
Cretan Motors Kentaur
Cretan Motors "Hecaton"
EU2A1 Mendez
Harris-Musselman Dirt Bike
IS-2000 Ifrit
Kirsh Sunflower
M-300 Hovertank
TM Willow
UN-500 Turtledove
WGM Wyoming

All these vehicles are built at the Styler Vehicle Plant or some smaller workshop and not the companies listed in the Future SRD. All vehicle gear of PL 6 and 7 is available on Eos.

rivers and the seas beyond are likely to play a growing part in the economy of Eos. Right now, the Dawning Star Republic is not well positioned to take advantage of this opportunity.

Due to the lack of infrastructure, air travel is a common means of traveling between settlements not connected by roads. While initially there were only a few survey, military, and transport aircraft on Eos, such vehicles have been of primary concern at the Styler Vehicle Plant, second in priority only to the military vehicles produced there. Most aircraft on Eos are rotorwing or vector thrust craft that do not require extensive runway facilities to function. The Styler Vehicle Plant has only recently developed the capacity to produce hovercraft, and there are very few of them available currently. Over time, it is expected that they will become the primary form of air travel. Aircraft are favored for their ability to reach secluded locations, not for their speed, so there are few jet aircraft on Eos. Usually, more efficient methods of propulsion are used. Several faction-camps and the Dawning Star Republic have aircraft outfitted for combat, but most consider the vehicles too valuable to risk lightly.

◇ VEHICLES

The following vehicles are the most common ones found on Eos.

DS G-3 Survey Vehicle

The DS G-3 survey vehicle was the standard middleweight, off-road vehicle carried by the *Dawning Star*. It was primarily designed as a cargo and exploration vehicle, and it excels at these tasks, even if its cargo capacity is not abundant. The G-3 remains a ubiquitous vehicle on Eos, and they are found in nearly every settlement. In addition to the Styler Vehicle Plant, several faction-camps build their own versions of the G-3, but they suffer from notoriously poor reliability. Most G-3s have a covered cargo area behind the passenger compartment, but some have had the cover removed to allow for additional storage space. The G-3 comes both in a two- and four-door model and is 2 squares wide and 3 squares long.

DS G-12 Basil APC

A dozen of these medium-armored vehicles were brought to Eos on the *Dawning Star*. An older design, the Basil APC was scheduled to be phased out completely two years after the Earth was destroyed. Accordingly, many of its systems are now out of date. The EDF has tried to upgrade the Basil as best they can, but with limited success. The Basil has mainly served as a police vehicle while on Eos. While not cutting-edge military technology, the Basil APCs are more than capable of dealing with most civilian vehicles that have been converted to military use. The Basil APC is powered by a mini-reactor with a lifetime of 20 years.

The crew of the Basil APC consists of a pilot and a gunner/communications officer. It has two top-mounted hatches, one for each crew position, which require a full round action to enter or disembark through. The Basil has three additional hatches that can be used to disembark troops: a rear hatch, a left hatch, and a right hatch. These side hatches are sometimes folded out and used for cover by troops accompanying the Basil to enable them to fire forward and retain cover. All occupants of the Basil APC receive full cover. Those hiding behind the folded out side doors of the Basil APC enjoy three-fourths cover.

The Basil APC is armed with an EDF-2 heavy machine gun, a Tremor 40mm cannon, and a pod of 6 Falcon guided missiles. The Basil APC comes standard with duralloy armor. The Basil APC is 5 squares long and 3 squares wide.

DS G-14 Armadillo Heavy Tank

Arguably the most powerful ground combat vehicle on Eos, these mobile weapons are the heart of the EDF's armored forces. These large tanks were

S-10E STYLER
SCOUT BIKE

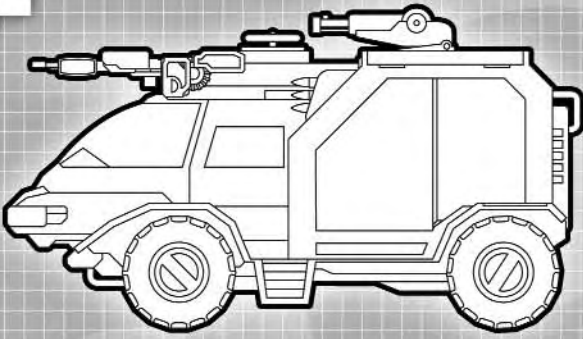
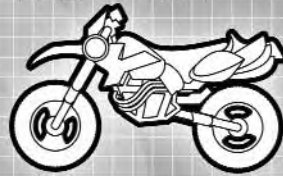

OS G-12
BASIL APC

OS AC-18 MYRMIDON
VECTORED THRUST
ASSAULT CRAFT

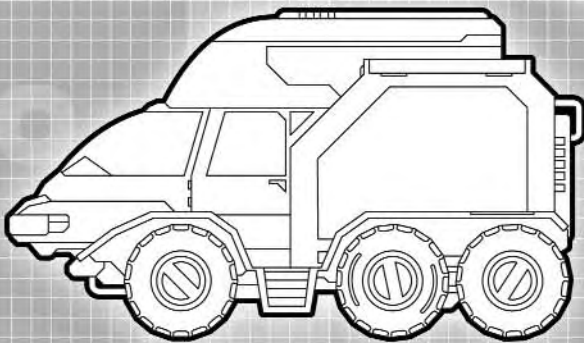
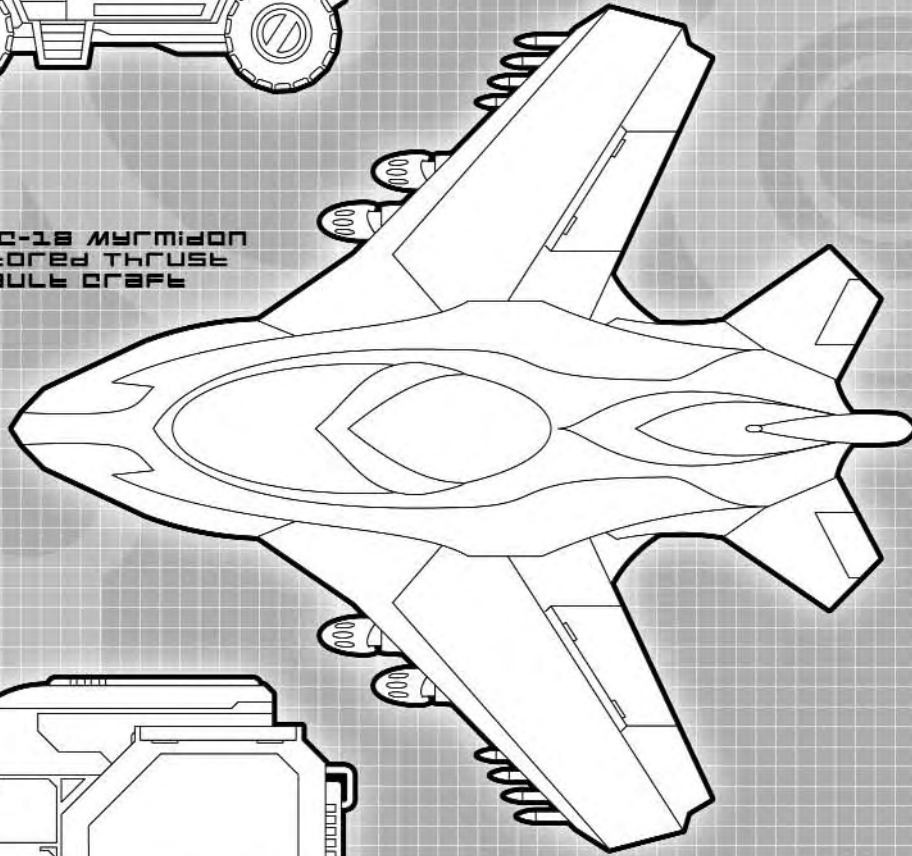

OS G-3
SURVEY VEHICLE

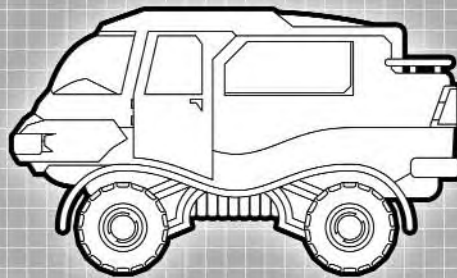

S-15 STYLER
GROUND TRANSPORT

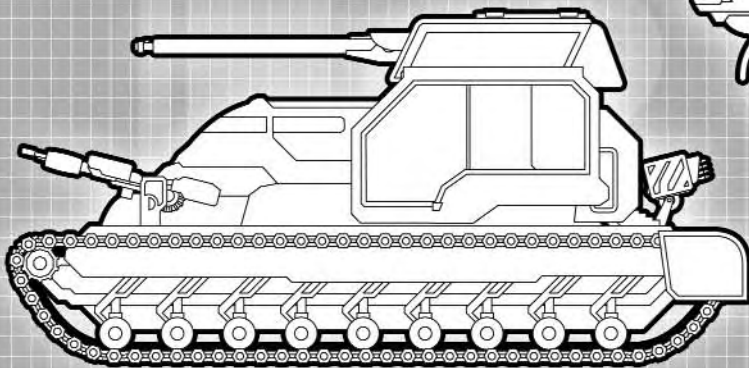

OS G-14
ARMADILLO HEAVY TANK

cutting-edge when they were built on Earth sixty years ago, and have been upgraded since with plasma weapons. The Armadillo Heavy Tank is currently the king of the battlefield, for there are no ground vehicles on Eos that can challenge it. Unfortunately for the EDF, they only have four of these monsters, and due to the scarcity of spare parts they are rarely used. Only the direst of emergencies causes the EDF to roll out the Armadillos. The Armadillo is powered by a mini-reactor with a lifetime of 40 years.

The Armadillo has a crew of four: two gunners, a commander, and a driver. One gunner operates the main cannon while the other manages the secondary weapons. The driver also has access to a small secondary turret equipped with a plasma sprayer for clearing away ground troops from in front of the vehicle. There are two hatches on the Armadillo, one located on the top of the main turret while the other is atop the secondary turret that sits above the driver's position. Entering or disembarking from the DS-G14 requires a full-round action. The Armadillo is 5 squares long and 4 squares wide.

In addition to the plasma sprayer, the Armadillo is equipped with a turret-mounted Magna-6 100mm rail cannon as its main gun, an EDF-2 heavy machine gun on pintle-mount atop the main turret, 4 Falcon guided missiles, and a battery of 12 grenades (most of which are normally smoke grenades). The grenades have a range increment of 50 feet. The Armadillo comes standard with neovulcanium armor.

DS AC-18 Myrmidon Vectored Thrust Assault Craft

The primary aircraft of the Eos Defense Force, the Myrmidon is a vector-thrust aircraft that looks like a boxy fighter. Capable of Vertical Take-Off and Landing (VTOL), it requires only a reasonably flat square of terrain to land or take off. Ten of these vehicles were on the *Dawning Star* when it arrived on Eos. Eight of them remain active, and the other two have been disassembled for spare parts. The Myrmidon has seen extensive use across Eos and is the first response vehicle of the Eos Defense Force. Anywhere a conflict is reported, a flight of four Myrmidons are usually the first EDF vehicles on the scene. Other units are called in only when the Myrmidons cannot handle the situation. Usually the Myrmidons can handle whatever situations they come across, as there are few air vehicles or anti-aircraft weapons on Eos that are their equal. As yet, no Myrmidon has been shot down while on duty; however, given the Tangier missile launchers that are now common among the Eos Freedom League, many expect this will change soon. Anyone who shoots down a Myrmidon is likely to get an overwhelming retaliatory strike from the EDF. The Myrmidon is powered by a mini-reactor with a lifetime of 20 years.

Myrmidons can carry a wide variety of weapon loads, but the most common is a pair of linked, front-mounted EDF-2 heavy machine guns, 4 Falcon guided missiles, 4 heavy rockets, and 8 light rockets. Alternately, Myrmidons may be equipped with a Tremor 40mm cannon, bombs, or energy weapons. The Myrmidon comes standard with resiliium armor.

The Myrmidon is 5 squares long and 5 squares wide.

S-8 Styler Heavy Ground Transport

Several of these immense ground vehicles were brought over on the *Dawning Star* for cargo hauling, but many times the original number have been manufactured since. The S-8 HGT is 30 feet long and raised almost four feet off the ground by six immense tires and an impressive suspension system. Built to carry many tons of cargo across nearly any terrain, the HGT is amphibious, capable of crossing calm bodies of water using its massive tires as flotation devices. The S-8 HGT is powered by a mini-reactor with a lifetime of 20 years. The S-8 HGT is one of the most highly valued ground vehicles on Eos, other than military vehicles, due to the large amount of cargo it can carry and its ability to deal with poor terrain. While most of the S-8 HGTs are owned by the Dawning Star Republic and its citizens, a number are owned by faction-camps, several of which have been turned into makeshift personnel carriers.

The S-8 HGT is six squares long and three squares wide. It has two doors on each side of the main cab and a large rear cargo door at the back of the cargo space. Entering the vehicle through any of these doors requires a move action. Some owners have taken the roofs off their S-8 HGT's cargo area to expand their capacity.

When traveling over water, the S-8 HGT's top speed is 30 (3). While in water, the driver of the S-8 HGT suffers a -4 equipment penalty to all Drive checks. While on land, the S-8 HGT reduces all terrain penalties by half. The S-8 HGT is 6 squares long and 3 squares wide.

S-10E Styler Scout Bike

A recent addition to the Styler Vehicle Plant, the S-10E was developed as a means of conserving resources while still providing transportation to a large number of people. In addition to requiring fewer resources to build, motorcycles also consume less energy, and most scout bikes run on rechargeable fuel cells rather than the mini-reactors that power larger vehicles. The S-10E is meant to be a cheap alternative to larger vehicles, while still being a vehicle suitable for the rough terrain found outside Dawning Star. The vehicle has proven immensely popular with both citizens of the Dawning Star Republic and the faction-camps—the Styler Vehicle Plant can barely make them fast

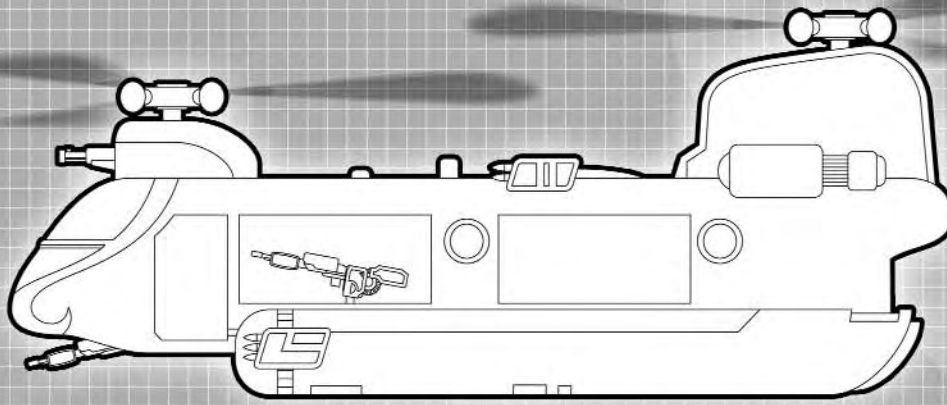

SA-20 ARES
HEAVY ASSAULT
ROTORWING

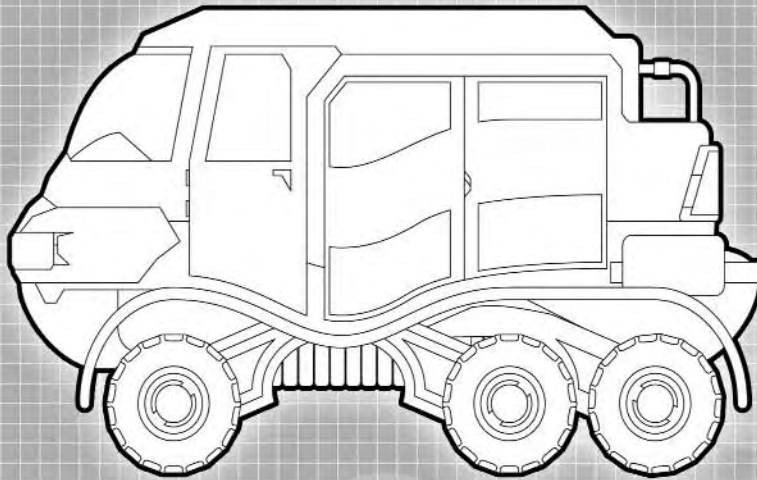

S-8 STEELER
HEAVY GROUND
TRANSPORT

SA-6 DROMEDARY
AIR CARGO HAULER

SH-32 SKY-SKIPPER
HOVERBIKE

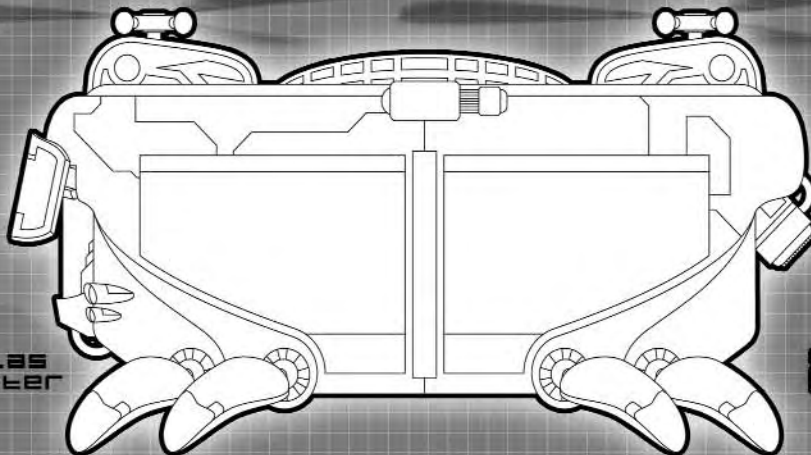
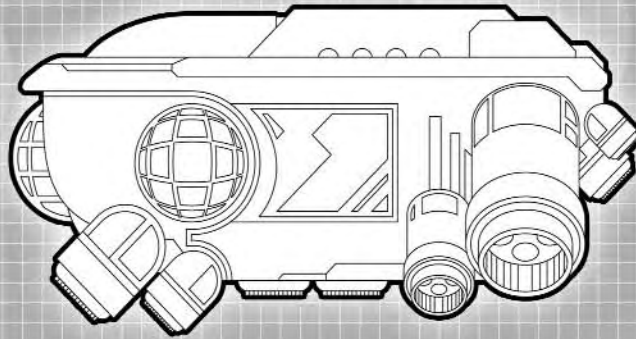

SA-18 ATLAS
CARGO LIFTER

25%

VEHICLES

Name	PL	Crew	Pass	Cargo	Init	Maneuver	Top Speed	Defense	Hard	Hit Points	Size	Purchase DC	Restriction
DS G-3 Survey Vehicle	6	1	3	L	-1	+0	120 (12)	8	10	40	H	28	Lic (+1)
DS G-12 Basil APC	6	2	8	M	-1	-1	100 (10)	14	15	60	G	45	Mil (+3)
DS G-14 Armadillo Heavy Tank	7	4	0	S	-4	-4	50 (5)	16	25	74	G	49	Mil (+3)
DS AC-18 Myrmidon Vectored Thrust Assault Craft	6	2	0	M	+2	+2	540 (54)	12	15	46	G	47	Mil (+3)
S-8 Styler Heavy Ground Transport	6	1	7	H	-6	-4	80 (8)	2	15	92	C	35	Lic (+1)
S-10E Styler Scout Bike	6	1	1	S	+4	+2	220 (22)	10	10	24	L	24	Lic (+1)
S-15 Styler Ground Transport	6	1	7	L	-1	+0	140 (14)	8	10	52	G	29	Lic (+1)
SH-32 Sky-Skipper Hoverbike	7	1	1	S	+4	+4	480 (48)	10	10	28	L	32	Lic (+1)
SA-6 Dromedary Air Cargo Hauler	6	1	3	L	-2	-2	400 (40)	8	10	34	H	39	Lic (+1)
S-18 Atlas Cargo Lifter	6	6	6	G	-4	-8	300 (30)	2	20	102	C	51	Lic (+1)
S-20 Ares Heavy Assault Rotor Wing	6	2	0	S	-2	-4	320 (32)	8	20	88	C	47	Mil (+3)

enough. Despite their popularity, many on Eos, particularly ranchers, prefer live mounts because of the noise the SE-10 creates.

The SE-10 is 2 squares long and 1 square wide. It can travel 500 miles on a single charge and takes 2 hours to charge at most fuel-cell depots. Recharging an S-10E fuel cell has a Purchase DC of 4 at most fuel depots.

S-15 Styler Ground Transport

The little brother of the S-8 HGT, this smaller pickup-like vehicle is common in Dawning Star and Iron Scar. While built with off-road capabilities, it is not as well-suited to such endeavors. Accordingly, the S-15 HGT has largely been used in urban environments. The S-15 is one of the cheaper enclosed vehicles on Eos and is popular with cargo companies, farmers, delivery services, and the Dawning Star Republic Postal System. The Eos Defense Force makes use of S-15s as small-scale cargo vehicles, and the Republic Militia often uses them as makeshift troop transports. A flexible vehicle, it fulfills a great number of roles on Eos. Because of this high demand for the S-15, it is one of the more commonly produced vehicles from the Styler Vehicle Plant, and spare parts for it are easy to come by. The S-15 is powered by a mini-reactor with a lifetime of 20 years.

The S-15 is 2 squares wide and 4 squares long.

SH-32 Sky-Skipper Hoverbike

The smallest vectored thrust vehicle on the market, the SH-32 Sky-Skipper is an attempt to reduce the high cost of vectored thrust vehicles by reducing their size. The result is a cheaper vehicle that is more fuel efficient than most vectored thrust vehicles. However, this effort is still in its infancy, and the Sky-Skipper is fairly expensive, especially considering its limited cargo room and passenger space. Some air runners have taken to using the Sky-Skipper, but most feel it is not suitable for long-range runs. The Eos Defense Force has taken to using it as a scout vehicle, and several delivery services in Dawning Star have bought a handful of Sky-Skippers and put them to use with great success. While it has not seen much success as a general purpose vehicle, for short-range missions with a small cargo it seems an excellent craft.

The Sky-Skipper is two squares wide and two squares long. It runs off of a fuel cell that lasts for 400 miles of travel and takes 2 hours to charge at most fuel-cell depots. Recharging a fuel cell has a Purchase DC of 4 at most fuel depots.

SA-6 Dromedary Air Cargo Hauler

The original vectored thrust cargo vehicle, the SA-6 Dromedary is based on the design of the DS AC-6 Air Cargo Unit, a cargo and gunship that has since been phased out as other more specialized

vehicles proved more efficient. The SA-6 has stripped-down armor plating and no weapons as standard features, but it is still a quick vehicle with a rugged frame and a very reliable drive system. Among air runners, it is the most popular vehicle commonly available, and it sees heavy use in all the outlying areas of the Dawning Star Republic and the faction-camps. Roger's Point has a number of Dromedary's outfitted with weapons and armor plating, but they cannot compare with the firepower and protection of the AC-18 Myrmidons. The SA-6 Dromedary is powered by a mini-reactor with a lifetime of 20 years.

The Dromedary is 3 squares wide and 4 squares long. When it is equipped with weapons, the most common mounts are EDF-2 heavy machine guns and light rockets.

SA-18 Atlas Cargo Lifter

The biggest air vehicle on Eos, the Dawning Star Republic only has three of these massive vehicles. Four large double-rotors are mounted on this cargo rotorcraft, one on each corner of its square frame. The Atlas has a large interior cargo area and can use cargo winches to carry exterior cargo as well. The Atlas can carry two of just about any vehicle on Eos except for the Armadillo heavy tank, which is too heavy even for this behemoth. While the Atlas is not designed for combat, its sturdy frame has been reinforced with armor plating, and weapons have been added to make the Atlas suitable for combat drops of supplies and vehicles. Using the Atlas Cargo Lifter, the EDF can put down several vehicles and a number of support troops anywhere within a thousand miles of Dawning Star within a matter of hours.

The Atlas's now in service are armed with four turret-mounted EDF-2 heavy machine guns and 6 falcon missiles. The Atlas Cargo Lifter is 20 squares wide and 24 squares long.

SA-20 Ares Heavy Assault Rotorwing

Likely to be phased out of use in the next ten years, the EDF's two SA-20 Ares Heavy Assault Rotorwings have served as the heavy hammer of the EDF's air forces since its inception. In most situations, the simple presence of an Ares is enough to make faction-camp and dissident forces reconsider their actions, such is the firepower and precision control of the Ares. While the Ares carries an impressive weapon load, its speed is not great compared to vector thrust aircraft. For the time being though, the Ares is one of the most fearsome weapons on Eos.

The Ares is usually armed with a forward-mounted EDF-2 heavy machine gun and heavy plasma gun, 20 heavy rockets, two door-mounted EDF-2 heavy machine guns, and an automatic grenade launcher. These weapons can be easily changed out according to the needs of different missions. The Ares comes standard with resiliium armor.

The Ares is 10 squares long and 8 squares wide.

VEHICLE WEAPONS • • •

Falcon Guided Missile

The catch-all missile for the Eos Defense Force, this missile can be configured for both air and surface use. It is the standard missile issued across the Eos Defense Forces armored units, easing supply issues by having most units use a single missile design.

The Falcon's guidance system confers a +2 equipment bonus on attack rolls. Additionally, a character controlling the launch system can elect to cancel an attack against a vehicle after making the attack roll but before its result is announced.

Magna-6 Rail Cannon

The only commonly used rail gun in the Eos Defense Force arsenal, this device uses magnets to hurl a metal SABOT round at extremely high velocity, punching through most armored targets

VEHICLE WEAPONS

Weapon*	PL	Damage	Critical	Damage Type	Range Increment	RoF	Magazine	Size	Weight	Purchase DC	Restriction
Falcon Guided Missile	6	6d12	20	Concussion	1,000 ft.	S	1	L	190 lb.	21	Mil (+3)
Magna-6 Rail Cannon	7	7d12	20	Ballistic	600 ft.	S	1	H	850 lb.	29	Mil (+3)
Rocket Heavy	6	5d12	20	Concussion	500 ft.	S	1	L	120 lb.	17	Mil(+3)
Rocket Light	6	4d12	20	Concussion	300 ft.	S	1	L	80 lb.	15	Mil(+3)
Tremor 40mm Cannon	6	3d12	20	Ballistic	200 ft.	A	Linked	L	340 lb.	25	Mil(+3)

* The weapons on this list require the Exotic Firearms Proficiency feat. Both types of rocket fall are covered by Exotic Firearms Proficiency (rocket).

with ease. Ammunition for the Magna-6 is easy to create from ferrous metals, but the gun itself is rather fragile and prone to breakdowns. The Magna-6 rail cannon ignores half a target's hardness. Reloading a Magna-6 rail cannon is a move action and requires the Exotic Firearms Proficiency (Magna-6 Rail Cannon) feat.

Rocket, Heavy

An unguided projectile, the rockets used by the Eos Defense Force are mainly for use against slow-moving ground units and structures. With no guidance system, they are mostly ineffective against air targets due to the high rate of speed at which aircraft move.

Rocket, Light

A smaller version of the heavy rocket, it shares the same purpose, though tends to be used in greater quantities.

Tremor 40mm cannon

An automatic cannon of large size, this weapon is common on gun emplacements around Dawning Star itself, in addition to being the main gun on the Basil APC. It is primarily for use against lightly-armored vehicles but is effective against infantry as well. The Tremor 40mm cannon is named for the terrible racket and strong vibrations it creates when fired for extended periods of time.

MECHA • • •

Mecha were rare on Earth before it was destroyed, only seeing regular use in construction roles and orbital facilities. The humanoid shape is difficult to armor and provides a much larger target than a tank, making their use in ground combat questionable. In space, mecha were able to maneuver easily, making them a common part of space-borne military operations. While they did not have the speed of space fighters, they were excellent for boarding enemy ships and became the pre-eminent tool for boarding capital ships.

Twenty-four mecha were brought to Eos on the Dawning Star, and sixteen of those were construction units. Due to the high maintenance cost of mecha, some of these have been cannibalized for parts, leaving only a handful operational. The Eos Defense Force plans to construct more mecha once they have a working space navy, but that is several years off. Most of the mechs used by the Dawning Star Republic are construction mechs, with twelve construction mechs still in service in Dawning Star. Four space combat mechs are stationed on the *Nebraska*, but they have seen nothing but training exercises for many years.

In addition to the more mundane mechs brought by humans to Eos, a number of relic mechs exist

hidden in the ruins of Eos. Only one of these has surfaced so far, and it now resides in Steel End, one of the more troublesome faction camps, south of Dawning Star. Relic mechs are PL 8 and PL 9 items, and include a number of technologies never before seen by humans. The one mech that has been uncovered so far, called The Steel Wall by its pilot Hennessey Marks, includes biological system interfaces in addition to pure electronic components. The largest and most complicated relic yet found, the discovery of more relic mechs has the possibility of unlocking many secrets of the technologies that once ruled Eos. In addition to the mechs described below, additional mech rules, including new equipment and extensive rules for relic mechs, will appear in *DAWNING STAR: HEROES OF HELIOS*.

DSC-566 Construction Robot (PL 6)

A common construction machine during the last days of Earth, several DSC-566's were brought on the Dawning Star to assist in building terraforming facilities and other buildings. Many dozens more were on the *Iron Horse*, the evacuation ship that carried the fleet's industrial equipment. The DSC-566 robots, or "con-bots" as they are commonly called, were instrumental in building the city of Dawning Star from the remains of the ship of the same name. These machines were originally used in teams, but now they are spread out around the outer borders of Dawning Star, constantly adding more buildings to the budding metropolis. Con-bots have no combat equipment of note and are not designed to be used in combat.

Size: Gargantuan (-4 size)

Superstructure: Duralloy

Armor: Duraplastic

Armor Penalty: -4

Strength Bonus: +24

Speed: 50 ft.

Bonus Hit Points: 400

Hardness: 15

Bonus to Defense: +3

Reach: 15 ft.

Dexterity Penalty: -2

Base Purchase DC: -

Standard Equipment Package: Pilot's cockpit (head), Class II sensor system (visor), light fortification, comm system (shoulders).

DS-SCU-78 Nova Space Combat Robot (PL 7)

The cutting edge space-combat vehicle when the *Dawning Star* left Earth, these heavy combat robots were designed to engage and board capital ships, inflicting significant damage by landing on enemy capital ships and attacking them at point blank range. Such maneuvers required the mech pilots to avoid intense fire before reaching their target, meaning they all had to have a strong sense of

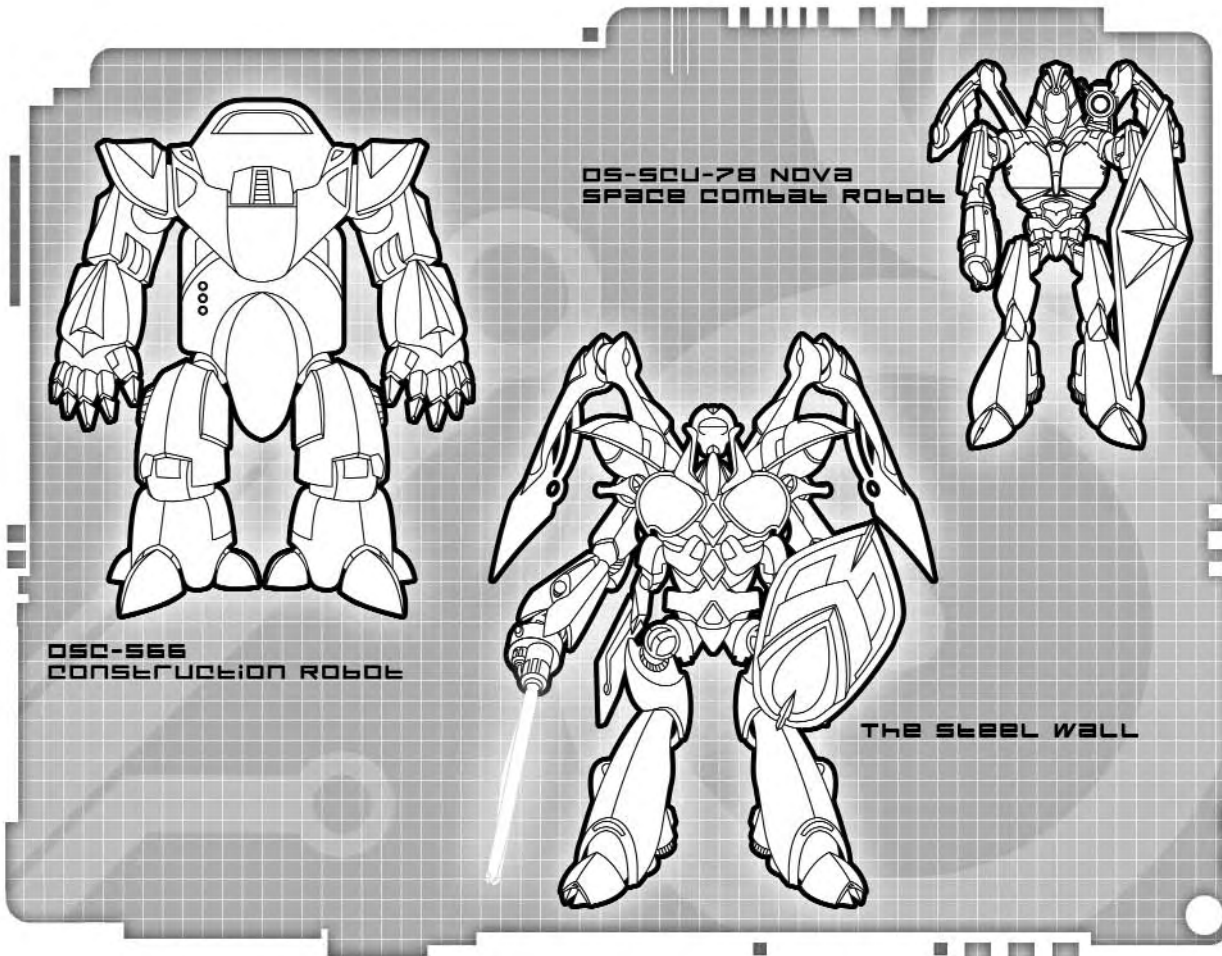

OS-SCU-78 NOVA
SPACE COMBAT ROBOT

DSC-566
CONSTRUCTION ROBOT

THE STEEL WALL

bravado and often a little madness to see their mission through. Unfortunately, these hotshot pilots have had nothing to do since their arrival in Helios and all have since retired, training a new generation of mech jockeys who have also done nothing but sit around waiting for things to happen. The six surviving Nova mechs are all stationed on the *Nebraska*, and none have received technology upgrades since the development of plasma weapons. They are scheduled to be upgraded in the next few years.

Size: Huge (-2 size)

Superstructure: Vanadium

Armor: Resilium Armor

Armor Penalty: -5

Strength Bonus: +16

Speed: 40 ft., 150 ft. (average)

Bonus Hit Points: 200

Hardness: 20

Bonus to Defense: +12

Reach: 10 ft.

Dexterity Penalty: -

Base Purchase DC: -

Standard Equipment Package: Pilot cockpit (torso), afterburner (back), thruster boots (boots), jet assist wings (shoulders), class III

sensor system (visor), mark IV oracle targeting system (helmet), bastion tactical shield (left hand), comm system, life support system, space skin, zero-g stabilizer, Typhoon 240 laser cannon (right arm), M87 Talon missile launcher (left arm).

The Steel Wall

Pulled from one of the fortress ruins near Steel End, *The Steel Wall* is the centerpiece of the faction camp's defenses. While the Dawning Star military could destroy the machine in a concerted assault, no vehicle on Eos other than an actual spacecraft could go head-to-head with the mammoth machine. This is one of the major aces in the hole possessed by the Eos Freedom League, and they are willing to go to great lengths to protect it. *The Steel Wall*'s owner, Hennessey Marks, is a former relic hunter who has now hit the big time and spends his days learning to better operate his mech.

This mech should serve as an example of a relic mech, but there are many other as yet undiscovered systems in *The Steel Wall*. Additional information on relic mechs will be presented in DAWNING STAR: HEROES OF HELIOS.

Size: Gargantuan (-4 size)
Superstructure: Megatanium
Armor: Megatanium
Armor Penalty: -10
Strength Bonus: +24
Speed: 40 ft.
Bonus Hit Points: 450
Hardness: 30
Bonus to Defense: +25
Reach: 15 ft.
Dexterity Penalty: -2
Base Purchase DC: -
Standard Equipment Package: Pilot cockpit, ramjet thruster boots (boots), jet assist wings (shoulders), class VI sensor system (helmet), mark V oracle targeting system (visor), mark V deflection field (belt), heavy fortification, mark V delphi defense suit (shoulder and back), barricade tactical shield (left arm), LT-5 Longshot mass driver (right hand and arm), 2 mass driver ammo clips (left and right legs), Avenger electro-scimitar (left hand), comm system, life support system, HV-5 Haven escape pod (torso), space skin, stealth suite, advanced diagnostics (back), structural enhancement, zero-G stabilizer (torso), crackerjack neural link.

STARSHIPS • • •

While the largest ship to reach Eos has been disassembled and used to construct the city of Dawning Star, the Dawning Star Republic still has a number of ships in its possession. The *Dawning Star* arrived on Eos with a dozen escort ships, nine of which are still functional. Additionally, seven ships have been built of the various scavenged spacecraft scattered across Eos, giving the Dawning Star Republic a total of sixteen ships at its disposal. These range from the flagship, the destroyer *Nebraska*, to a four-ship squadron of space fighters. These ships are normally docked at the spaceport at Dawning Star, at the *Sadler Orbital Facility* above Eos, or are carrying out some sort of cargo or scientific mission. The Dawning Star Republic does not yet feel comfortable sending its fledgling fleet to explore the nearby worlds despite the fact all signs indicate they are inhabited. The fleet is expected to field ten new ships in the next two years, drastically increasing the fleet's numbers. Given this bolstering of the fleet, the Dawning Star Republic hopes to launch its first round of exploratory missions in the next four years.

The ships of the Dawning Star Republic all fall under the command of the Eos Defense Force. In order to allow the fleet proper freedom to carry out operations without going through the entire EDF command structure, the EDF has created the Eos Space Force, under which all ships, their crews, and support staff fall. The Eos Space Force is based out of the *Sadler Orbital Station* under the

command of Admiral Rebecca Yates. Admiral Yates is an excellent bureaucrat and has finely-honed organizational skills. However, she lacks extensive military experience, leaving most tactical decisions to the captain of the *Nebraska*, Diana Pierce. Admiral Yates spends most of her time in Dawning Star, keeping the supplies and support for the Eos Space Force running smoothly, while Captain Pierce leads the forces in orbit.

Due to operational costs, most of the spacecraft on Eos are only used in situations that demand their services. In the past, they have been used to place satellites, conduct experiments, and occasionally transport personnel and supplies to remote areas of the planet. They have not yet been used in any military actions on Eos, though for many of the smaller ships this is a very real possibility if the Eos Defense Force becomes hard pressed. The weapons on the ships were originally all of Earth design and consisted largely of lasers and rail guns. Since landfall, many of these have been upgraded to plasma weapons, particle beam cannons, and other PL 7 systems taken from the crashed tentaari ship.

The faction camps have precious few ships to their name. Only Roger's Point has more than two: a pair of small scout ships that have little in the way of armaments and are not in good enough repair to make an interplanetary voyage and a single space fighter that is mainly used for atmospheric support duties. A few of the other camps have one or two small shuttles, but nothing capable of more than a quick atmospheric jaunt. The faction-camps have all but given up having space superiority over the Dawning Star Republic; they have fallen too far behind.

There is only one privately-owned ship in the Dawning Star republic. The ship is the property of Maximillian Dagos, a billionaire from Earth, who offered his gigantic, state-of-the-art luxury ship to the evacuation effort. Since arriving on Eos, he has invested heavily in the Dawning Star Republic and owns many companies within the Republic. His ship, *The Last Resort*, serves as his base-of-operations from its position in orbit over Dawning Star. Mr. Dagos rarely ever leaves his ship.

The tentaari are known to have at least two ships in the system, but it is widely suspected they have many more than that and are keeping their resources secret. In addition to the tentaari, long-range sensors have identified other ships in the system. Getting any concrete information on these vessels has been difficult at best. It is widely believed the third and fifth planets in the system are inhabited by races with space-faring technology, but without the capacity to reach Eos. These worlds are the first targets of the exploratory missions the Dawning Star Republic plans to launch in the near future.

The spacecraft on Eos are all currently ultralight or light space ships with the exception of the *Nebraska*,

which is a mediumweight spaceship. These ships are all equipped with ion engines and thrusters for atmospheric operation. Most have cerametal armor plating, but a few have been outfitted with experimental neutronite armor developed from scavenged tentaari technology. The rest of their features vary from ship to ship, but most have class III sensory arrays, laser transceivers, and a mixture of missiles, rail guns, and particle beam cannons for weaponry.

Information on the other spaceships of Eos and the ships used by other species including the tentaari, will be detailed in *DAWNING STAR: HELIOS RISING* and *DAWNING STAR: SILVER ECLIPSE*.

◆ THE NEBRASKA

The current flagship of the Dawning Star Republic, this destroyer was only a ship of moderate size among the fleets of Earth. It was the largest capital ship assigned to escort the Dawning Star that survived the trip to Eos, and it remains the cornerstone of Eos's defenses from extra-terrestrial threats. The *Nebraska* has never set down on the surface of Eos, maintaining a constant vigil in orbit near the *Sadler Orbital Facility*. It receives its supplies from Eos via shuttles each week, though the ship is usually kept on minimal power and the smallest crew complement possible in order to conserve resources. Because of this, it takes several hours to get the *Nebraska* up to full effectiveness, but the sensors on the *Sadler Orbital Facility* are powerful enough that most any object approaching the planet will be detected in sufficient time to warn up the *Nebraska*.

The *Nebraska's* current captain is Diana Pierce. She was only a newly recruited ensign when the ship left Earth, but now she is reaching her elder years. Some fear for her continuing capacity to live up to her responsibilities. Captain Pierce is the most experienced space navy officer the Eos Space Force has, and she has performed admirably in her duties. When the spacecraft of the Eos Defense Force are gathered together, Captain Pierce is usually given field command of the fleet, but such events occur very rarely. The *Nebraska* is the only ship that always remains in orbit. Supplemented with regular training simulations, its crew is the most experienced in the fleet. Serving on the *Nebraska* is considered the premiere assignment of the Eos Space Force.

While Captain Pierce knows her first duty is protecting Eos, it has been over 50 years, and no threats to the planet have appeared from space. Captain Pierce is one of the main proponents of exploring nearby worlds, and she hopes to set foot on those worlds before she retires. Unfortunately, the *Nebraska* is unlikely to be part of any exploration mission due to its prime position in the defense of Eos. Despite her unflinching service, she may never get her chance.

Type: Mediumweight

Subtype: Heavy Destroyer

Defense: 15

Flat Footed Defense: 9

Autopilot Defense: 7

Hardness: 40

Hit Dice: 220d20 (4,400 hit points)

Initiative Modifier: +6

Pilot's Class Bonus: +7

Pilot's Dex Modifier: +6

Gunner's Attack Bonus: +8/+3

Size: Colossal (-8 size)

Tactical Speed: 4,000 ft. (7 squares)

Length: 980 ft.

Weight: 32,400 tons

Targeting System Bonus: +5

Crew: 146 (ace +12)

Passenger Capacity: 200

Cargo Capacity: 8,000 tons

Grapple Modifier: +16

Base Purchase DC: NA

Restriction: NA

ATTACK

4 fire linked heavy particle cannons +5/+0 ranged (40d8/20) and

2 fire linked heavy plasma cannons +0 ranged (27d8/20) and

2 plasma missile launchers +0 ranged (18d8/20)

Attack of Opportunity:

Point Defense +5 ranged (3d12x10)

DESIGN SPECS

Engines: Ion Engines, thrusters

Armor: Neutronite

Defense Systems: Decoy Drone Launcher, Improved Autopilot System, Improved Damage Control, Light Fortification, Magnetic Field, Point Defense System, Radiation Shielding, Self-Destruct System

Sensors: Class IV Sensor Array, Improved Targeting System

Communications: Laser Transceiver, Radio Transceiver

Weapons: 4 fire linked heavy particle cannons (range incr. 4,000 ft.), 2 fire heavy plasma cannons (range incr. 4,000 ft.), 2 plasma missile launchers (16 missiles each)

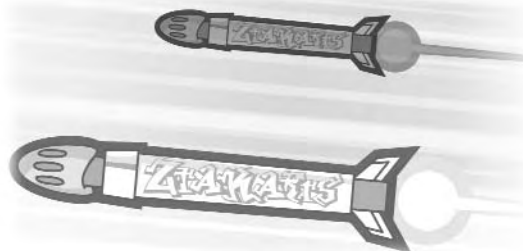

◇ DS SP-18 HUMMINGBIRD SHUTTLE

The *Hummingbird* was designed to be a fairly simple vehicle, built for transferring cargo from the *Dawning Star* to the surface of a world with few frills or luxuries. The *Hummingbird* is not capable of interplanetary travel because it has no ion drive and insufficient supplies to last the journey. Instead, it is merely equipped to fly from the surface of a world to ships in orbit and return.

The *Dawning Star* carried eight Hummingbirds to Eos, but only six of them are still functional. Two hummingbirds are in the possession of faction-camps, while the other four are part of the Eos Space Force. The Hummingbirds have become the workhorse ships of the Eos Space Force, making weekly cargo runs to the *Nebraska* and the *Sadler Orbital Facility*. They are occasionally used to run supplies to distant outposts on Eos, but this is done only rarely due to the expense. Hummingbirds have neither weapons nor the power systems sufficient to mount most weapons on them. Likewise, their armor plating is not very sturdy. Combined with the lack of armaments, the *Hummingbird* is a flying coffin anywhere near combat. Because of this, the Hummingbirds are the only ships in the Eos Space Force not expected to take part in defensive operations, if Eos were to be attacked.

Type: Ultralight

Subtype: Atmospheric Shuttle

Defense: 11

Flat Footed Defense: 9

Autopilot Defense: 7

Hardness: 20

Hit Dice: 8d20 (160 hit points)

Initiative Modifier: +2

Pilot's Class Bonus: +3

Pilot's Dex Modifier: +2

Gunner's Attack Bonus: +2

Size: Gargantuan (-4 size)

Tactical Speed: 2,500 feet

Length: 40 feet.

Weight: 85,000 lb.

Targeting System Bonus: —

Crew: 2 (trained +4)

Passenger Capacity: 20

Cargo Capacity: 5 tons

Grapple Modifier: +16

Base Purchase DC: NA

Restriction: NA

ATTACK

DESIGN SPECS

Engines: Thrusters

Armor: Alloy Plating

Defense Systems: Autopilot System, Chaff Launcher, Damage Control System, Radiation Shielding

Sensors: Class II Sensor Array

Communications: Laser Transceiver, Radio Transceiver

Weapons: —

◇ THE SADLER ORBITAL FACILITY

Originally designed as an orbital observation platform from which the terraforming personnel and equipment carried on the *Dawning Star* could be directed, the *Sadler Orbital Facility* now serves as Eos's primary scientific installation for interplanetary study. Its sensors have been upgraded extensively, a drydock added, and its weapons upgraded, creating a heavily fortified space station that also has repair facilities for the Eos Space Fleet. Currently, most of the drydock facilities are being used to construct new ships for the Eos Space Force, including another mediumweight destroyer similar to the *Nebraska*.

Despite its fortifications, the *Sadler Orbital Facility* was not designed to be a military facility, and it could not stand up to a determined assault for very long. Luckily, there are always at least four ships from the Eos Space Force in addition to the *Nebraska* nearby. The station's armor, weapons, and sensors have been upgraded using the technology gained from the *tentaari*. The *Sadler Orbital facility* has the most powerful sensor array in the Eos Space Force.

In addition to military operations, the *Sadler Orbital Facility* is the center of space-based scientific research for the *Dawning Star Republic*. It is equipped with a large number of research labs, a small industrial workshop, and one of the most powerful computer systems in the *Dawning Star Republic*. Scientists are only allowed to use the resources of the *Sadler Orbital Facility* for a few months before they are sent back to Eos. Such is the waiting list to make use of the station.



The *Sadler Orbital Facility* is technically under the direct command of Admiral Yates. Although it serves as her official command post, she is rarely ever there. In her stead, Captain Silas Morgan is the leader of the station. As much an engineer and scientist as a soldier, he has worked on various parts of the station over the years, from the dry docks to the research labs. He knows the whole place inside and out. Captain Morgan served for several years as the station's chief engineer before being promoted to captain. Captain Morgan fears actual combat and keeps his station in top fighting form, so it will be ready, if and when it does occur.

Type: Superheavy

Subtype: Space Station

Defense: 7

Flat Footed Defense: 5

Autopilot Defense: 7

Hardness: 40

Hit Dice: 900d20 (18,000 hit points)

Initiative Modifier: +4

Pilot's Class Bonus: +3

Pilot's Dex Modifier: +2

Gunner's Attack Bonus: +2

Size: Colossal (-8 size)

Tactical Speed: -

Length: 2,200 feet

Weight: 450,000 tons

Targeting System Bonus: +5

Crew: 320 (Trained +4)

Passenger Capacity: 4,000

Cargo Capacity: 12,000 tons

Grapple Modifier: +16

Base Purchase DC: NA

Restriction: NA

ATTACKS

3 fire linked plasma missile launchers -1 ranged (36d8/20) and

3 fire linked heavy plasma cannons -6 ranged (36d8/20)

Attack of Opportunity:

Point Defense +5 ranged (5d12x10)

DESIGN SPECS

Engines: None (stationary orbit)

Armor: Cerametal

Defense Systems: Decoy Drone Launcher, Improved Autopilot System, Improved Damage Control, Magnetic Field, Point Defense System, Radiation Shielding

Sensors: Class V Sensor Array, Improved Targeting System

Communications: Laser Transceiver, Radio Transceiver

Weapons: 3 fire linked heavy plasma cannons (range incr. 4000 feet), 3 fire linked plasma missile launchers (24 missiles each)

◇ THE RICKSHAW QUEEN

One of the first ships constructed from the crashed alien craft scattered across Eos, the *Rickshaw Queen* looks like several different ships were crammed together. The ship looks like it's ready to fall apart, and usually sounds that way too, but thus far has proven surprisingly resilient and effective. The *Rickshaw Queen* is officially designated a frigate, though it often serves double-duty as a cargo ship. The *Rickshaw Queen* is normally stationed at the Dawning Star Spaceport to defend the city in case of attack, but it occasionally makes trips to the *Sadler Orbital Facility* or goes into low orbit to carry out training maneuvers.

While the *Nebraska* is the most prestigious assignment in the Eos Space Force and the *Sadler Orbital Facility* the prime assignment for scientists, the *Rickshaw Queen* has become the home for promising screw-ups that are just skilled enough for their transgressions to be outweighed by their proficiency. Crewed by a mixture of non-conformists, rabble-rousers, and probationary officers, the *Rickshaw Queen* is used as a dumping ground for talented discipline problems and new recruits that need to learn the ropes. The crew of the *Rickshaw Queen* is a raucous bunch, who love their ship deeply and, against Eos Space Force regulations, modify it constantly. Largely due to the lack of trained spacecraft personnel on Eos, many of the crew of the *Rickshaw Queen* have only narrowly avoided being court-martialed. Despite their ram-bunctious nature, the crew of the *Rickshaw Queen* is loyal to the Republic. The one faction-camp spy that infiltrated the ship was ridden out of Dawning Star on a rail by her crew. Over the years and thanks to its many upgrades, the *Rickshaw Queen* has become the fastest ship in the Eos Space Force, although some fear it will eventually explode.

The captain of the *Rickshaw Queen* is Michael Stenner who ended up on the ship after losing command of the frigate *Harvest Moon* due to a drunk and disorderly charge. Captain Stenner hopes to eventually regain command of his old ship and leave the washouts of the *Rickshaw Queen* behind. To that end, he has tried to instill some order and discipline in his troops. So far, this effort has enjoyed only limited success and earned him a position as the butt of many practical jokes.

Type: Light

Subtype: Frigate

Defense: 11

Flat Footed Defense: 7

Autopilot Defense: 7

Hardness: 40

Hit Dice: 90d20 (1,800 hit points)

Initiative Modifier: +4

Pilot's Class Bonus: +5

Pilot's Dex Modifier: +4

SADLER ORBITAL FACILITY

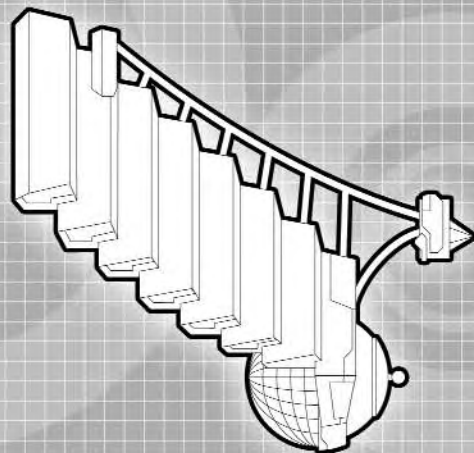
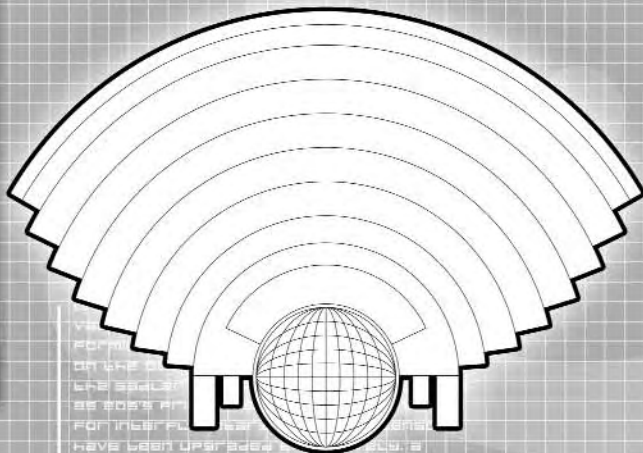

The current Sadler Orbital Facility is the largest and most advanced orbital facility in the galaxy. It was built by the Eos Space Force and is currently the primary orbital facility for the Eos Space Force. The facility is a heavily fortified space station that also has repair facilities for the Eos Space Fleet. Currently, most of the Eos Space Fleet is using the facility to construct new ships for the Eos Space Force, including the new Eos

NEBRASKA

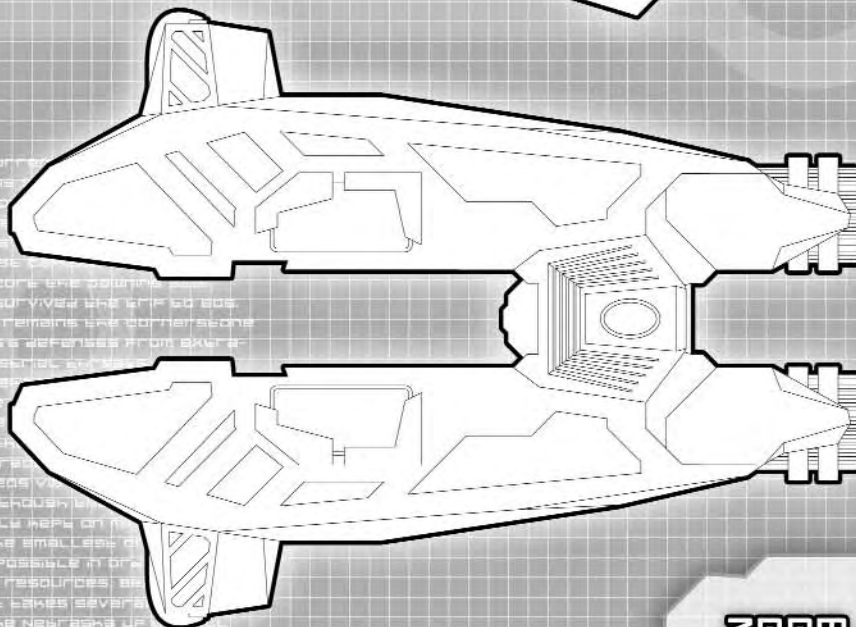
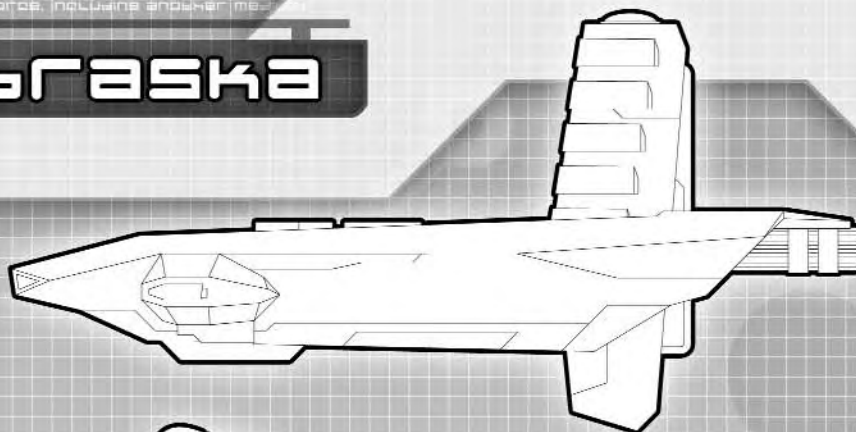

The current Nebraska is the largest and most advanced starship in the galaxy. It was built by the Eos Space Force and is currently the primary starship for the Eos Space Force. The ship is a heavily fortified space station that also has repair facilities for the Eos Space Fleet. Currently, most of the Eos Space Fleet is using the ship to construct new ships for the Eos Space Force, including the new Eos

zoom X3

Gunner's Attack Bonus: +4
Size: Colossal (-8 size)
Tactical Speed: 4,500 feet
Length: 400 feet
Weight: 5,000 tons
Targeting System Bonus: +5
Crew: 46 (expert +8)
Passenger Capacity: 40
Cargo Capacity: 220 tons
Grapple Modifier: +16
Base Purchase DC: NA
Restriction: NA

ATTACK

4 fire linked quantum cannons +1 ranged (40d8/20)
2 fire linked mass reaction missile launchers -4 ranged (30d8/19-20)
2 heavy mass cannons -4 ranged (10d12)
Attack of Opportunity:
Point Defense +5 ranged (2d12x10)

DESIGN SPECS

Engines: Thrusters, ion engine
Armor: Neutronite
Defense Systems: Decoy Drone Launcher, Improved Autopilot System, Improved Damage Control, Magnetic Field, Point-Defense System, Radiation Shielding, Self-Destruct System, Light Fortification
Sensors: Class IV Sensor Array, Improved Targeting Systems
Communications: Laser Transceiver, Radio Transceiver
Weapons: 4 fire linked quantum cannons (range incr. 6,000 feet), 2 fire linked mass reaction missile launchers (24 missiles each), 2 heavy mass cannons (range incr. 6,000 feet)

◆ THE WATCHMAN

Originally a picket ship, the *Watchman* was assigned to the *Tomorrow's Children*, a multinational evacuation ship carrying families and domestic personnel. After the incident with the tentaari gateway network, the *Watchman* found itself deposited with the *Dawning Star* in the Helios system. In fact, it was the *Watchman* that first penetrated the atmosphere of Eos. Lacking the mass of the *Dawning Star*, she quickly felt the effect of the rust spores and would have been lost if not for the skill of her captain, Commander Thomas Wilson. Commander Wilson managed to keep the thrusters operating to control descent and make a successful emergency landing.

Inspection revealed that her weapons and external sensors had been eaten away, but her internal systems were still in working condition and the engine could be repaired. She has since been refitted and is in active duty again, including weapons developed from technology gained from the tentaari wreck found in the Bergen Lowlands.

Commander Wilson retired several years ago and now acts as a freelance consultant to the Republic on matters of surface exploration. His last executive officer, James Meniffee Jr., is now captain of the *Watchman*. He is a bright, young officer and liked by his crew, one of the rising stars of the Eos Space Force.

While not as prestigious as the *Nebraska*, the *Watchman* is one of the few craft in the Eos Space Force to see combat duty, though not the type originally designed for. More than once she's been used as a gunship or dust-off vessel for survey expeditions who've found themselves facing hostile xenomorphs undeterred by hand weapons. In fact, her new captain keeps her stocked with one of the best inventories in the fleet and has even acquired and affixed anti-personnel weapons for use by highly trained gunners.

Type: Light
Size: Colossal (-8 size)
Subtype: Scout
Tactical Speed: 3,500 feet (7 square)
Defense: 11
Length: 500 feet
Flat Footed Defense: 7
Weight: 4,400 tons
Autopilot Defense: 7
Targeting System Bonus: +5
Hardness: 30
Crew: 35 (expert +8)
Hit Dice: 80d20 (1,600 hit points)
Passenger Capacity: 18
Initiative Modifier: +4
Cargo Capacity: 100 tons
Pilot's Class Bonus: +5
Grapple Modifier: +16
Pilot's Dex Modifier: +4
Base Purchase DC: NA
Gunner's Attack Bonus: +4
Restriction: NA

ATTACK

4 variable fire linked heavy lasers +1 ranged (16d8/20)
2 fire linked mass reaction missile launchers -4 ranged (30d8/19-20)
2 plasma cannons -4 ranged (14d8)
Attack of Opportunity:
Point Defense +5 ranged (2d12x10)

DESIGN SPECS

Engines: Thrusters, ion engine
Armor: Cerametal
Defense Systems: Chaff Launcher, Decoy Drone Launcher, Improved Autopilot System, Improved Damage Control, Magnetic Field, Point-Defense System, Radiation Shielding, Stealth Screen.

RICKSHAW QUEEN

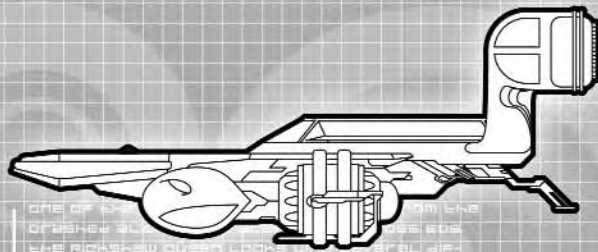

ONE OF THE MOST COMMONLY USED SHIPS IN THE RICKSHAW QUEEN CLASS, THE RICKSHAW QUEEN LOOKS LIKE A SMALL, FAST, AND MANEUVERABLE SHIP. IN REALITY, THE SHIP LOOKS LIKE IT'S ABOUT TO FALL APART, AND USUALLY SOUNDS THAT WAY TOO. BUT AS HAS BEEN PROVEN SURPRISINGLY MANY TIMES, THE RICKSHAW QUEEN IS A VERY EFFECTIVE AND RELIABLE SHIP. IT'S BEEN CALLED A FRIGATE, THOUGH IT DOESN'T HAVE THE SAME LEVEL OF ARMAMENT AS A FRIGATE. THE RICKSHAW QUEEN IS NOT A BATTLESHIP, BUT IT'S A VERY EFFECTIVE SHIP. IT'S BEEN CALLED A FRIGATE, THOUGH IT DOESN'T HAVE THE SAME LEVEL OF ARMAMENT AS A FRIGATE. THE RICKSHAW QUEEN IS NOT A BATTLESHIP, BUT IT'S A VERY EFFECTIVE SHIP. IT'S BEEN CALLED A FRIGATE, THOUGH IT DOESN'T HAVE THE SAME LEVEL OF ARMAMENT AS A FRIGATE.

zoom X5

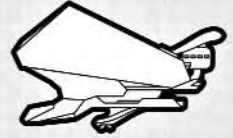

HUMMINGBIRD

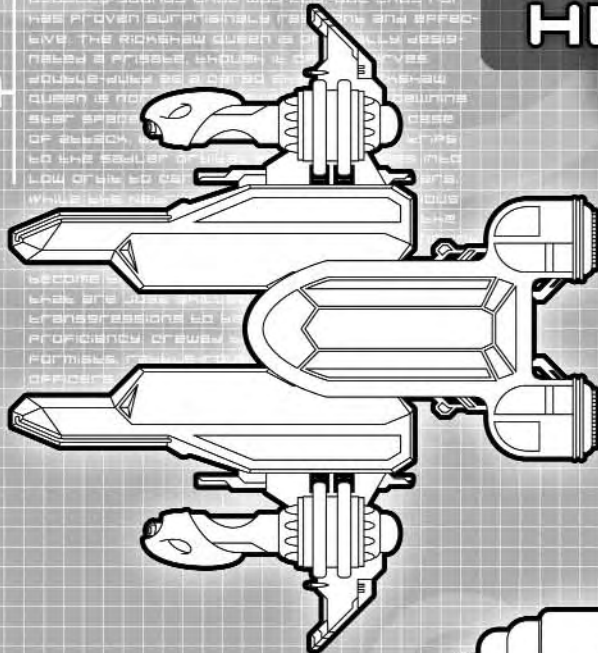

THE HUMMINGBIRD IS A SMALL, FAST, AND MANEUVERABLE SHIP. IT'S BEEN CALLED A FRIGATE, THOUGH IT DOESN'T HAVE THE SAME LEVEL OF ARMAMENT AS A FRIGATE. THE HUMMINGBIRD IS NOT A BATTLESHIP, BUT IT'S A VERY EFFECTIVE SHIP. IT'S BEEN CALLED A FRIGATE, THOUGH IT DOESN'T HAVE THE SAME LEVEL OF ARMAMENT AS A FRIGATE.

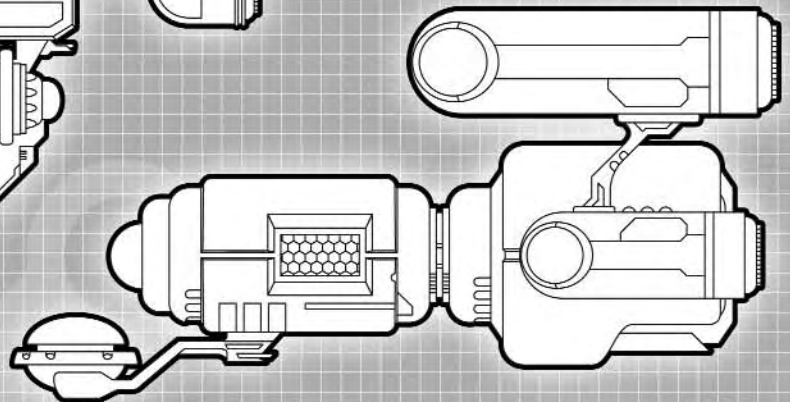
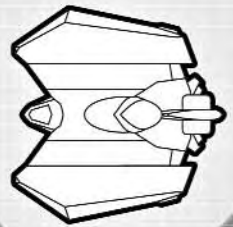

WATCHMAN

ORIGINALLY A RICKSHAW SHIP, THE WATCHMAN WAS DESIGNED TO BE A FAST, MANEUVERABLE SHIP. IT'S BEEN CALLED A FRIGATE, THOUGH IT DOESN'T HAVE THE SAME LEVEL OF ARMAMENT AS A FRIGATE. THE WATCHMAN IS NOT A BATTLESHIP, BUT IT'S A VERY EFFECTIVE SHIP. IT'S BEEN CALLED A FRIGATE, THOUGH IT DOESN'T HAVE THE SAME LEVEL OF ARMAMENT AS A FRIGATE.

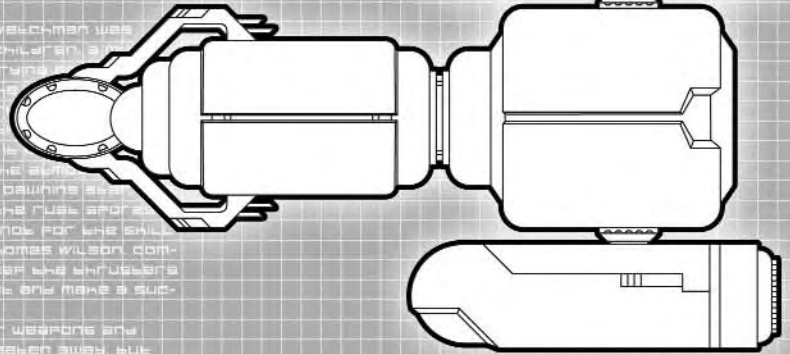

Sensors: Class IV Sensor Array, Improved Targeting Systems

Communications: Laser Transceiver, Radio Transceiver

Weapons: 4 variable fire linked heavy lasers (range incr. 4,000 feet), 2 fire linked mass reaction missile launchers (24 missiles each), 2 plasma cannons (range incr. 3,000 feet)

◆ THE DAWNING STAR

The *Dawning Star*, along with its fellow evacuation ships, was one of the largest structures ever constructed by mankind. Five miles in length and powered by laser controlled fusion engines that produced thrust via a stream of ions, they were able to accelerate to over 10% of the speed of light. The *Dawning Star* had a crew of 15,000 and carried over two million passengers in cryogenic sleep. In addition to its crew and passengers, it carried hundreds of ground vehicles, the creature tanks and other terraforming equipment, the *Sadler Orbital Facility* and thousands of other items needed to start a new life on another world. The *Dawning Star* had few weapons to speak of, and its armor was mainly designed to protect it from meteorite impacts, making its use as a warship questionable at best. It was designed to be a transport, and in that role it excelled.

The other evacuation ships had slightly different designs based on their intended roles. The *Arrowhawk* carried most of the military forces of the fleet and was equipped with numerous weapons, heavy armor plating, and multiple bays for space fighters, but its cargo load was smaller than the *Dawning Star*. The *Longest Road* was the fastest of the evacuation ships and was designed to reach Lalande 21185 before the other ships so it could survey the world, but lacked the crew and cargo capacity of other ships. The *Iron Horse*, on the other hand, was filled to capacity with industrial equipment, agricultural supplies, robots and vehicles, dwarfing even the cargo capacity of the *Dawning Star*. All the *Dawning Star's* sister ships are now lost somewhere in space, hopefully having found a world like Eos to inhabit. The *Dawning Star* Republic constantly broadcasts signals into deep space from orbital satellites in the hopes the rest of the fleet will one day find its way to Eos. Some scientists have been pushing for a diplomatic effort to gain access to the tentaari gateway network to see if it can be repaired. So far, this endeavor has failed.

When the *Dawning Star* landed on Eos, it suffered significant damage from the rust spores. While it could have taken off again, it would have required significant repairs to do so. Instead, the decision was eventually made to dismantle the *Dawning Star* and use it to build the city that now carries the same name. *Dawning Star's* space-borne origin is evident in its materials and architec-

ture. Heavy blast doors are found on storefronts, sheets of armor plating used are used as roofing, and old oxygen tanks serve as bathtubs. The *Dawning Star* provided an immense amount of resources for the colony to use, and items continue to be salvaged from the ship to this day. Needless to say, now that the ship has been totally disassembled, it will never be put back together again.

Although the details vary depending on the ship, the other members of the evacuation fleet have the following general statistics.

Type: Superheavy

Subtype: Evacuation Ship

Defense: 7

Flat Footed Defense: 5

Autopilot Defense: 7

Hardness: 20

Hit Dice: 9,000d20 (180,000 hit points)

Initiative Modifier: +4

Pilot's Class Bonus: +3

Pilot's Dex Modifier: +2

Gunner's Attack Bonus: +2

Size: Colossal

Tactical Speed: 2,000 feet.

Length: 27,500 feet

Weight: 5.5 million tons

Targeting System Bonus: +3

Crew: 15,000 (Trained +4)

Passenger Capacity: 2 million

Cargo Capacity: 12,000 tons

Grapple Modifier: +16

Base Purchase DC: NA

Restriction: NA

ATTACKS

5 groups of 4 fire linked rail cannons -3 ranged (15d12/20) and

10 CHE missile launchers -8 ranged (6d12/19-20) and

2 batteries of 4 fusion beams -5 ranged (10d8/17-20)

Attack of Opportunity:

Point Defense +3 ranged (3d12x10)

DESIGN SPECS

Engines: Ion engine

Armor: Alloy Plating

Defense Systems: Improved Autopilot System, Improved Damage Control, Point Defense System, Radiation Shielding, Self Destruct System

Sensors: Class II Sensor Array, Targeting System

Communications: Laser Transceiver, Radio Transceiver

Weapons: 5 groups of 4 fire linked rail cannons (range incr. 3,000 feet), 10 CHE missile launchers (40 missiles each), 2 batteries of 4 fusion beams (range incr. 3,000 ft.)

DAWNING STAR

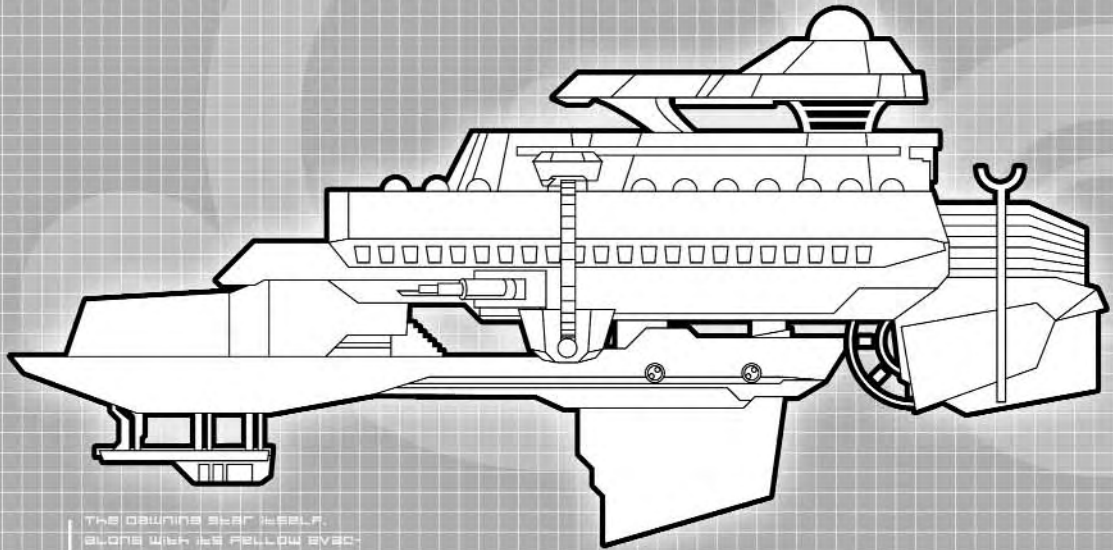

THE DAWNING STAR ITSELF, ALONG WITH ITS FELLOW EVACUATION SHIPS,

WAS ONE OF THE LARGEST STRUCTURES EVER CONSTRUCTED BY MANKIND.

FIVE MILES IN LENGTH AND POW-
ERED BY LASER-CONTROLLED
FUSION ENGINES THAT PRO-
DUCED THRUST VIA A STREAM

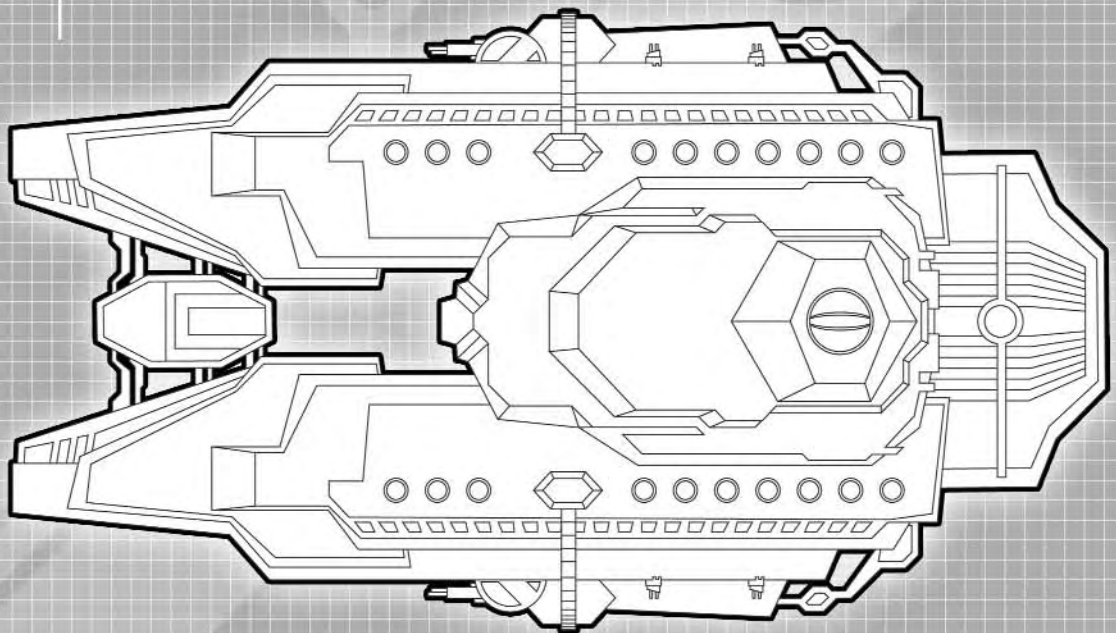

THE DAWNING STAR ITSELF, ALONG WITH
ITS FELLOW EVACUATION SHIPS,

WAS ONE OF THE LARGEST STRUCTURES
EVER CONSTRUCTED BY MANKIND. FIVE
MILES IN LENGTH AND POWERED BY LASER-
CONTROLLED FUSION ENGINES THAT PRO-
DUCED THRUST VIA A STREAM

THEY WERE ABLE TO ACCELERATE TO
OVER 30% OF THE SPEED OF LIGHT. THE
DAWNING STAR HAD A CREW OF 15,000 AND
CARRIED OVER TWO MILLION PASSENGERS
IN SEVERAL



CHAPTER IV

WORLD OF EOS



Ready to wipe off
the dust of Iron Scar
from your face?

Want to chase
the Ice Town from
your chattering
teeth?

Tired of swatting
bugs
in Greenville?

Then Sun City's
the place for you!

The first and still the best. Sun City offers unsurpassed luxury, security, and comfort in a pastoral setting. Relax on our 27 miles of pristine, white-sand beaches. Play our challenging, championship-level, 18-hole golf course. Capture all the exotic animals of Eos on a professionally guided video-safari. Strike it rich at one of our three casinos. Dine in one of our 24 delectable dining establishments, featuring the crown jewel, Chef Jacques Almand's critically acclaimed Ange Argenté.

Accommodations are available at our six signature properties: The rustic Golden Tusk Lodge, the quaint Saffron House B&B, the golf resort Golden Palms, the executive conference center Silver Towers, the family-friendly Sunshine Inn, and our exclusive, five-star Platinum Dawn Estates.

Booking available on-line at eos.suncity.com or contact our reservation department toll-free at 107.894.

©2251 SC Property Development LLC. Local taxes may apply. Velin welcome.

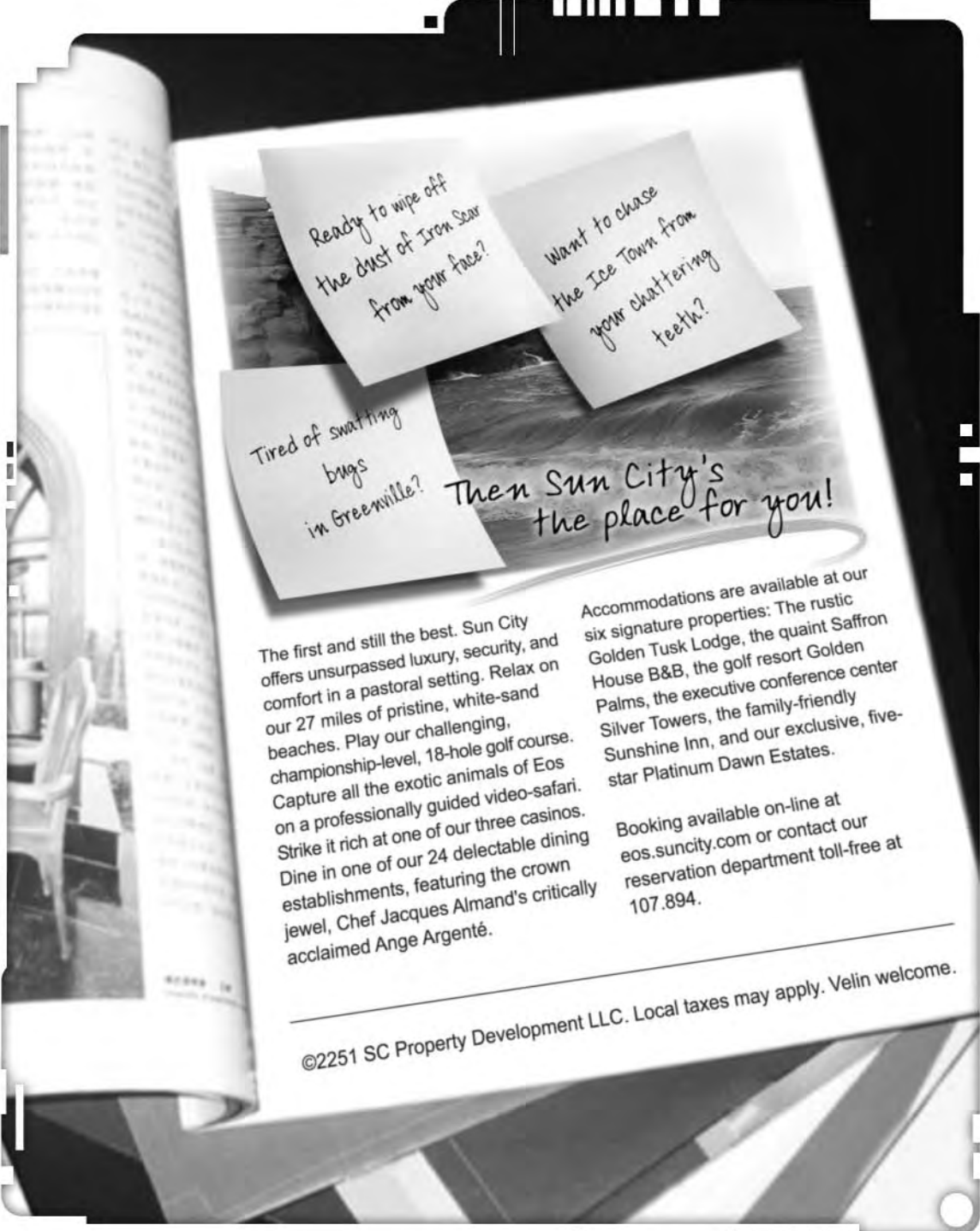

Earth is gone. Eos stands in its stead. Now, the first full generation of humans native to Eos is coming of age, knowing nothing of Earth but the tales of their grandparents. The planet was remarkably similar to Earth even before it was terraformed, and after years of effort the atmosphere and climate are now almost an exact match, creating a world that most humans consider very comfortable and pleasant. Most colonists consider finding Eos an immense stroke of luck—a blessing perhaps—and the human race has fared far better on Eos than it would have on Lalande 21185. While on the surface Eos seems a wonderful new home to humanity, it holds many dark secrets, and inhabiting it will take a toll that no one can foresee. There is a reason the world is covered in the ruins of a dead race.

Currently, the colonists inhabit and cultivate ten percent of the landmasses of Eos, which cover approximately 30 percent of the world's surface, meaning only three percent of the planet's total surface area has been explored by humans. The velin are a nomadic people, but most of their numbers are confined to the central continent of Dawnhome. Their numbers on other continents are very limited. Despite the ease with which the colonists have taken to Eos, the vast majority of its surface remains unexplored, and the world holds many secrets that its new inhabitants have only begun to discover. Most of the planet has been scanned from the Sadler Orbital Facility during the terraforming process, providing data on its general topography, the location of most surface ruins, and the areas of human habitation. However, many of the details of Eos remain unknown.

TIME ON EOS • • •

One revolution of Eos takes 25 hours, making an Eotian day slightly longer than an Earth day. Eos travels around its sun, Helios, in 351 days, making the length of the Eotian year only slightly shorter than one Earth year. Years are counted normally using the old Earth calendar with each Eotian year adding one to the current year count. The Gregorian calendar remains in use on Eos with one day removed from each month, except for May, July, and August, which have had two days removed. Most old Earth holidays, such as Christmas, are celebrated on the same days as previously, though national holidays have been forgotten and replaced with new holidays specific to Eos, such as Landfall Day.

GEOGRAPHY • • •

Seventy percent of the surface of Eos is covered by water. The largest body of water is the Sunset Ocean to the southwest of Dawning Star. Aside from the Sunset Ocean, there is the Amerigus Ocean to the northeast of Dawning Star, the Meridian Ocean to the southeast of Dawning Star,

the Greenwater Ocean north of Roger's Point, and the Antarctic Ocean in the region around the southern polar icecap. Of these, the Sunset Ocean and the Greenwater Ocean are the most heavily used by the human colonists for travel and fishing, though the Dawning Star Republic has little to do with either of these activities.

The central continent of Eos, on which Dawning Star is located, is called Dawnhome by most inhabitants of Eos, though some faction-campers call it Lawhome. The other four primary continents, from north to south, are named Europa, New India, Africus and Icemount. These are names primarily used by the Dawning Star Republic, while the faction-camps that have actually settled these regions often use other names. Currently, most human settlements are concentrated on Dawnhome, and the largest population centers are in or near the equatorial region. The velin are also mainly found on Dawnhome. Most velin do not care for water, leading them to remain on Dawnhome instead of branching out to the other continents. With human assistance, a few velin camps have been established on Europa and New India. The ruins of Eos are scattered across the planet, including the arctic ice fields, but most are located near the equatorial region. There are a surprising number of ruins in many of the deserts of Eos, leading some scientists to speculate the deserts were once fertile regions. The crashed spacecraft have mostly found in the equatorial area of Dawnhome.

Terraformers have found that Eos is several million years older than Earth, and thus its mountains are slightly more eroded than those of Earth. While Eos has numerous mountain ranges stretching for hundreds of miles on every continent, none of them reach above 23,000 feet. Most of these mountains are the creation of colliding tectonic plates, meaning many regions of Eos are earthquake prone. Ancient relics have been found in many of the fault areas, leading scientist to theorize that the original inhabitants had a method of preventing earthquakes; however, this technology no longer seems functional. In the 50 years since landing on Eos, five major earthquakes have struck Dawning Star, and most buildings are now constructed to be earthquake resistant.

The magnetic field of Eos is noticeably stronger than Earth's, and Eos suffers from severe electrical storms in the summer that play havoc with electronics. The Republic's researchers have yet to develop a shielding that is completely effective against these storms. This strong magnetic field also regularly creates beautiful displays of light in the northern arctic regions of the planet.

CLIMATE/ATMOSPHERE • • •

Eos's atmosphere is remarkably similar to that of Earth's. The principal difference is a higher nitrogen

and carbon dioxide content, though the carbon dioxide count has been noticeably reduced since terraforming. This has diminished the ability of the atmosphere to retain heat slightly, causing a general lowering of temperatures across the planet. As a result of this, the Eotian mean temperature is several degrees colder than Earth, though its temperature variation is not as great as Earth's. As one goes from the equatorial region to the polar regions, the temperature changes are much more gradual than on Earth. The lower temperatures mean humans find the equatorial regions the most comfortable region of the planet to settle, though such areas have quickly become crowded and largely claimed by the Dawning Star Republic. Thus, settlers looking for a new home are forced to look in other areas or on continents besides Dawnhome.

In addition to being cooler than Earth, Eos is slightly less humid as well. While Eos has a similar amount of water on its surface, it has less water vapor in its atmosphere. Because of this, many regions have a short rainy season, during which floods are commonplace, but remain mostly dry for the rest of the year. The Dawning Star Terraforming Corps is working on stabilizing the moisture content of the atmosphere in the hopes of creating more arable land.

Weather on Eos is prone to bouts of extreme activity surrounded by long periods of calm weather. In most regions, storms are rare, but when they do occur they are fearsome indeed. Hurricanes are common in the Sunset Sea during the summer months, and they often strike the western coast of Dawnhome. Thunderstorms are common across Eos in the summer months, and during winter they are replaced with snowstorms in most northern areas. Due to its proximity to the equator, it never snows in Dawning Star, but many of the faction camps experience snowstorms every year.

The polar regions of Eos are covered in thick sheets of ice, similar to the arctic regions of Earth. The northern polar region has no landmass below its ice pack, though the seas are covered with a thick layer of ice. The southern polar region has a landmass under its ice sheet, which includes the highest mountain on Eos, Mount Upward. Both of these regions are always subject to sub-freezing temperatures and strong winds, and they are only thinly inhabited by a small number of specially adapted animals. The Dawning Star Republic has a single research facility in the southern polar region, Icetown, located on the coast of Icemount, north of Mount Upward.

The northernmost reaches of Europa and both the northern reaches and southern islands of Dawnhome are tundra, where the temperature only rises above freezing for a few months in the summer. These regions are thick with animal life, and many velin tribes migrate northward to hunt during

the summer. There are no extensive human settlements in the tundra regions other than Shackelton, a small faction-camp east of Roger's Point. Their primary industry is hunting and exploring ruins in the tundra area.

On Europa and Dawnhome, south of the tundra regions, there are some of the largest mountainous regions of Eos, most of which are dominated by forest, scrub or tundra-like surface cover. Mountains are found in other regions of Eos, but the largest concentration is in the northern hemisphere. On New India and Dawnhome, the mountains are extremely inhospitable and are surrounded by largely tundra or deserts. The southern mountains of Dawnhome and the mountains on Europa are more favorable in climate and are predominantly forested.

Spread across all the continents of Eos, but principally in the central area, are large plains regions that are mostly flat with occasional areas of rolling hills. These are the most heavily populated areas of Eos and are the location of most of the crop cultivation. The Dawning Star Republic claims most of the plains on Dawnhome, driving faction-camps to other continents in search of suitable agricultural land. The plains are the most highly contested regions on Eos, and wars between faction-camps over territory are not unknown.

South of Dawning Star is the major jungle of Eos, called the Green Sea by most of the colonists. It is a rain forest-like environment, filled with a wide variety of life forms, only a handful of which have been cataloged. The jungles are much like those of Earth, only a few degrees cooler. They are filled with succulent plants, including immense cactus-like trees. There are non-succulent plants in the Green Sea, but they are mostly short shrubs or vines, lacking the water supply for larger growth. Succulent plants in the region have developed a wide diversity of shapes and sizes and have become the dominant type of plant in the Green Sea. The Green Sea has become one of the major areas of colonization due the wide variety of useful plants that grow there, such as pectar fruit. Rubber trees have been planted in the southern areas of the Green Sea with great success. The entire region is very hot, more humid than most areas of Eos, and full of insects, but it has proven so valuable that the colonists have been more than willing to put up with its annoyances.

On either side of the Green Sea are mountain ranges that are likewise covered in jungle and are home to a large concentration of ruins. These mountains, while having a climate most consider extremely unpleasant, are a common destination for relic hunters. In the southern reaches of the Green Sea and on western coast, the jungle gradually gives way to forest as the temperature drops. These forests are the main source of lumber for

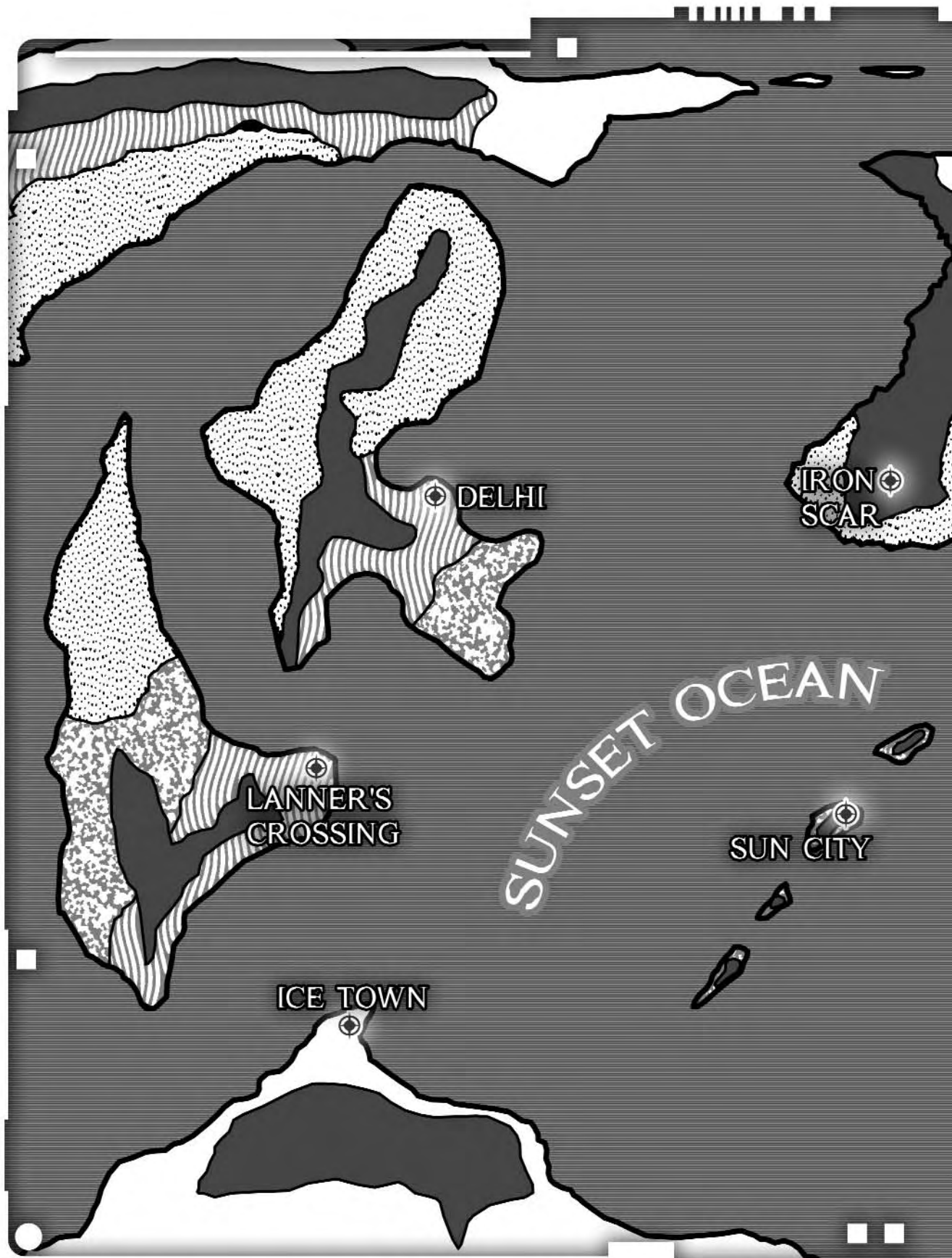

- | | | |
|---|--|---|
|  Desert |  Water |  Jungle/Forest |
|  Mountains |  Plains |  Tundra |

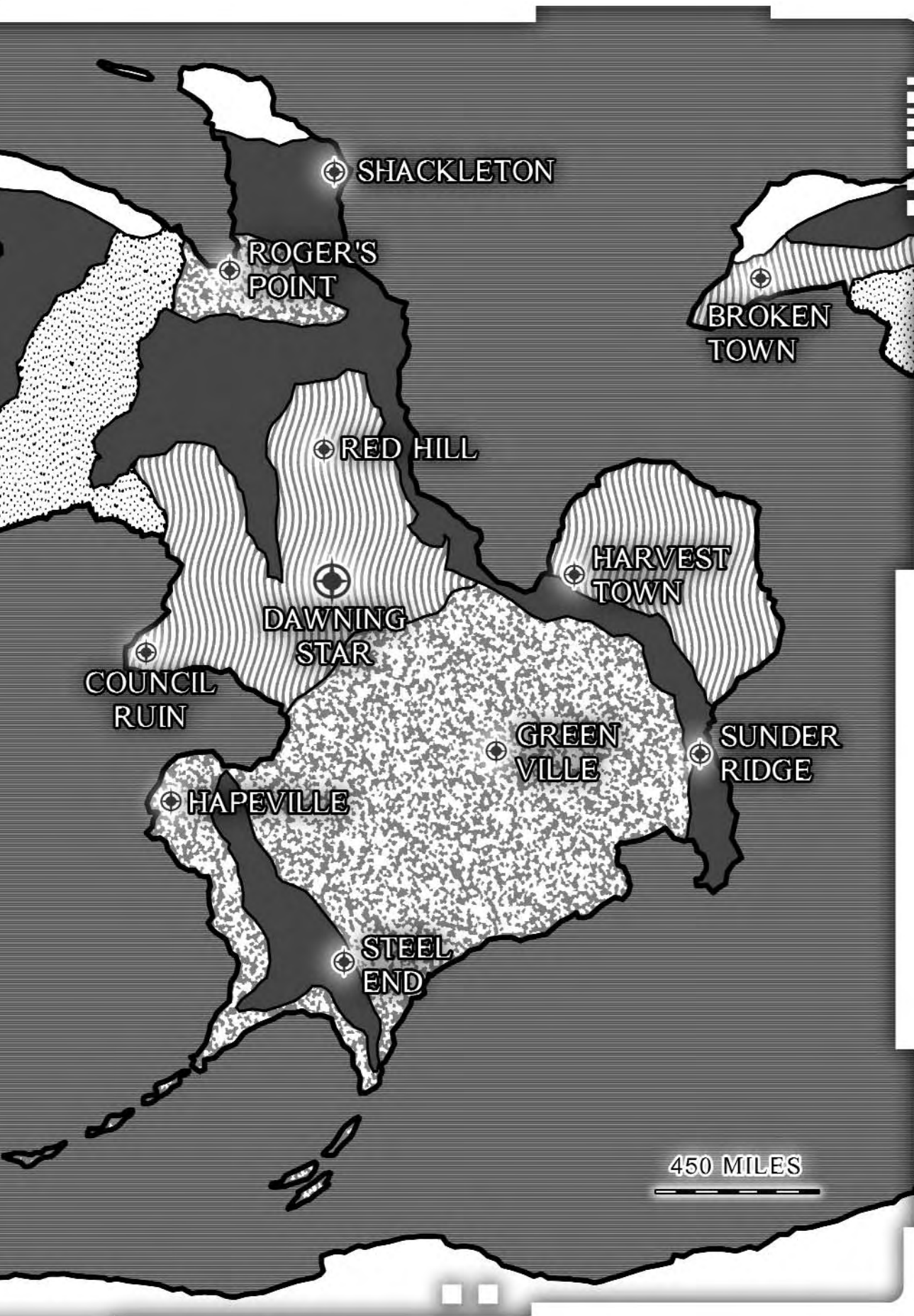

Dawning Star. There are jungles on other continents, but they have not been extensively explored. It is surmised that they are very similar to the Green Sea. There is also a forested area around Roger's Point, claimed by them and which they harvest for lumber for ships and sale to other faction-camps.

In the northern hemisphere, there are a number of deserts spread across Europa, Dawnhome, New India, and Africus. In the farther north areas, these are cold deserts, characterized more by lack of water than burning heat. The deserts of Dawnhome and Africus and the southern deserts of New India are more stereotypical deserts with miles of sand and a burning sun overhead. Both humans and velin avoid such areas. There are some desert areas littered with a large number of ruins, leading some to speculate they are a byproduct of the ancient war that killed off the original inhabitants of Eos.

THE TERRAFORMING PROCESS • • •

The terraforming process of Eos was much simpler than the expected task of terraforming Lalande 21185, but it still was not an easy task. Most of the process was done using massive atmosphere converters located just north of Dawning Star in the same Terraforming Fields that hold the creature tanks. These converters reduced the nitrogen and carbon dioxide levels in the atmosphere and increased the oxygen content. The carbon and nitrogen extracted in the process were later used in industrial procedures.

While the main terraforming equipment is near Dawning Star, there were smaller installations constructed across the surface of Eos and in low orbit. Some of these were monitoring stations, such as

the *Sadler Orbital Facility*, while others actually had their own converter units. Most of these have since been abandoned and their equipment returned to Dawning Star, but some settlers have taken up residence in the remaining structures at these terraforming camps.

In addition to the changes in atmosphere, the terraformers have slowly been introducing Earth organisms to the Eos ecosystem through the creature tanks. In addition to a number of creatures that were frozen for the trip, the creature tanks hold genetic material from thousands of earth species and are capable of creating clones of each. This cloning process is advanced enough that each clone has its own unique genetic makeup, making it possible to breed the clones without worrying about inbreeding. The terraformers have only introduced a few dozen species to Eos, seeking to maintain a balance between indigenous life forms and Earth life forms, but they plan to introduce thousands more over the next hundred years. Like all matters in terraforming, their plans are very long term.

Some terraformers have begun widening the scope of their operations, since the atmospheric processes are all but complete. Their new chosen task is attempting to sculpt the terrain of Eos to maximize its efficiency and productivity, such as rearranging weather patterns, soil, and climate so the deserts of Dawnhome can be turned into productive farmland. This concept has met with both support and opposition among the people of Dawning Star. Some favor doing whatever is necessary to survive and flourish on Eos, while others want to avoid changing a world that they feel belongs to the velin.



IMPORTANT LOCATIONS ON EOS • • •

Below are descriptions for the major locations on Eos. The following are explanations for some of the location features.

Progress Level: This is the general progress level of the settlement. While there may be individual items above this progress level, they are rare. Special effort has to be made to find items above this progress level.

Purchase DC Limit: Items with a purchase DC equal to or lower than this number are available in the location. Items with a higher purchase DC are not. This figure does not include the Purchase DC of any relics that might be available.

Black Market DC: This is the DC for a Knowledge (Local or Streetwise) check to find the black market in that location. Finding the black market follows the standard rules as described in **MODERN**.

Item Restriction Limit: In some places, the enforcement of weapon permits and the like is more lax than others. Items with a restriction level equal to or lower than the limit are available openly without resorting to the black market or requiring a license. When calculating the Purchase DC of a restricted item, ignore the restriction modifier if it is equal to or lower than the limit. Additionally, items with a restriction level equal to or lower than the limit will not attract the attention of the law. For example, one can carry energy weapons openly in Steel End, but Dawning Star is far stricter about such things.

◆ THE DAWNING STAR REPUBLIC

The following descriptions include the city of Dawning Star and the outlying areas that lie within the territory claimed by the Dawning Star Republic. They are subject to Dawning Star laws, receive public services, and otherwise enjoy the benefits offered by the Republic.

Dawning Star

Leader: President Sarah Pen

Population: 2 million

Major Exports/Products: Industrial products, vehicles, advanced technology

Major Imports: Food, raw materials

Progress Level: 7

Purchase DC Limit: 60

Black Market DC: 20

Item Restriction Limit: None

Dawning Star is very much the social, economic, and political center of Eos. It is the largest city on the planet, is home to the seat of government on

the planet, has most of the industrial capacity of any settlement on Eos, and has more military might than the rest of the planet combined. In short, Dawning Star is the most important place on Eos, at least in terms of human habitation.

The city itself was mostly built from the disassembled parts of the *Dawning Star* evacuation ship. The ship was over five miles long, so it provided a good deal of building material, all of which was very durable and resistant to the elements. Because of this, Dawning Star is a shining city of metal and glass, where buildings are constructed of old armor plating and doors are recycled airlock hatches. Due to the durable resources and desire to avoid sprawl, the city center of Dawning Star is filled with skyscrapers. The tallest of these is the House of Congress, which holds most of the governmental offices of the Republic. Other skyscrapers include the Hawson Domestic Complex, housing over ten thousand inhabitants, and the Dynax Research Center. The city center is considered the place-to-be for residents of Dawning Star. Both rent and demand for housing are highest there.

Around Eos runs the Perimeter Road, an eight-lane highway that circumnavigates the entire city. Numerous roads access the Perimeter Road, allowing quick transit to various parts of the city by traveling around the loop. Traveling through the city are several other highways of varying size, most of which continue beyond the Perimeter Road to locations outside the city: the Terraforming Fields, the resource zones, and the like. The roads in Eos are made of a very resilient recycled plastic that can support most any vehicle except for Armadillo tanks. While the major highways provide the quickest means of transportation, numerous smaller streets fill the city in a grid pattern. A few streets, leftovers from the earliest days of the colony, break the grid pattern.

In addition to roads, there is a light rail system that runs parallel to all the major highways, in addition to several subterranean tracks through the city's heart. Using either car or rail, it is very easy to get around Dawning Star. However, most citizens use the rail system to avoid accidents and the stress of city traffic. Despite the favor shown the rail system, Dawning Star's streets can get very hectic during some hours of the day, largely due to the fact the city is very densely settled, especially in the center of the city.

Between the city center and the Perimeter Road lay the many residential and commercial districts that make up the bulk of the city. Most inhabitants of Dawning Star live in apartment buildings, though a few have homes closer to the edge of the city or beyond the Perimeter Road. The most popular properties lay on the southeastern corner of the city close to the Jonah River, while the least favorable are in the northwestern and southwestern areas. In the northwestern corner of the city is the Earth

DAWNING STAR CITY



Memorial Park, in which the terraformers have tried to recreate a small area of the human's one-time home, replete with terran plants and animals. This area was once considered the pride and joy of the city, but it has recently fallen on hard times and is beginning to suffer.

To the north of the city, just outside the Perimeter Road, are the Terraforming Fields, including the creature tanks. Here, the entire terraforming effort is managed, and the genetic information for thousands of species is kept, ready to be introduced to the Eos ecosystem when the terraforming process has reached the proper point. This area is not popular with residents due to the many chemicals and strange smells the facility produces. Property values are notoriously low in the area.

To the east of the terraforming facility is the headquarters of the Eos Defense Force, a giant fortified camp with impressive exterior defenses, numerous subterranean facilities, a completely stocked motor pool, a landing strip, and limited industrial capacity. The largest concentration of arms on Eos, this base is one of the most secure locations on the planet. In times of emergency, almost the entire population of Dawning Star can be shielded in the fortress for a limited time. Food reserves would only last for a few weeks under such a situation, and the living conditions would not be ideal. Because of the proximity of the EDF fortress, EDF soldiers are a common sight in Dawning Star and are generally well treated and respected by the populace.

In the northwestern corner of the city is the remaining hull of the *Dawning Star*. Deconstruction of the ship continues, but at a slower pace because most of the easily used parts have already been stripped. The major remaining pieces are the engines and fuel cells. The Dawning Star is surrounded by a large scrap yard of cast-off pieces that some undesirable types have begun using as a hideout due to its vast size.

To the southwest of the city is the industrial sector, which is home to the Styler Vehicle Plant. This area contains most of the industrial power on Eos and is filled with workshops, factories, and processing plants. Numerous raw materials flow into this area from the Resource Zones to be turned into a wide variety of finished goods, from weapons to appliances to vehicles. These industrial plants are the heart of Dawning Star's economic power, and they are heavily defended by the Eos Defense Force. The industrial sector is kept clean, neat, and orderly at all times.

Further west of the industrial sector is the Dawning Star Spaceport, which is used almost exclusively by the Eos Space Force. There are usually half a dozen ships here at any given time, with the rest on missions planetside or in orbit. The spaceport has extensive repair and construction

facilities and is currently working on a number of small craft using technology scavenged from the wrecked spaceships found across Eos. The spaceport can handle 20 ships at maximum capacity, more than enough for the Eos Space Force's current needs. The spaceport is heavily guarded, and any vehicle entering its airspace without permission is shot down with little warning.

In addition to the EDF base, the city is patrolled by several thousand police officers based out of 20 precincts spread across the city. These police officers are equipped with EDF-9 autopistols, light combat armor, and a variety of ground vehicles. The police in Dawning Star are not completely above corruption or other problems, but by and large they are a dedicated force of law that many citizens support. Most members of the Dawning Star police are also members of the Republic Militia.

Dawning Star has the strictest guidelines for weapons and armor possession on Eos. For that matter, the city has the strictest law enforcement on the planet, which is one of the major reasons for the forming of faction-camps. Some people sought to leave Dawning Star, fearing it would become a police state. Citizens are not allowed to carry firearms without a license, and energy weapons and explosives are banned entirely. Only Republic Militia members may own automatic weapons and anything heavier than light armor. Outsiders, who come to the city, are asked to check their weapons at any of a half-dozen checkpoints around the edges of the city. While Dawning Star has the highest concentration of weapons and weapon factories on Eos, weapons are surprisingly hard to purchase in the city. Most gun merchants know a single violation of the law will end their business and scrupulously avoid making any improper transactions. Despite this, there is a thriving black market in automatic, energy, and heavy weapons. These weapons are usually slipped out of factories or from EDF facilities and then sold in back alleys. Because of the heavy presence of police in the city, the black market is difficult to contact for such a large settlement.

Iron Scar

Leader: Mayor Michael Willis

Population: 30,000

Major Exports/Products: Iron, minerals

Major Imports: Food, finished goods

Progress Level: 7

Purchase DC Limit: 40

Black Market DC: 25

Item Restriction Limit: Lic (+1)

Iron Scar was the first major settlement outside Dawning Star started by the Republic. (Red Hill existed for a time before being annexed by the republic.) Iron Scar is comprised of a mining town and its surrounding settlements, all of which are

considered part of Iron Scar despite the fact they are not part of the town proper. Iron Scar is the second biggest city on Eos, only barely keeping ahead of Roger's Point. The city also has a strong economy, and the quality of life is high due to regular trade with the industrial centers of Dawning Star. This prosperity is largely due to the wealth of iron deposits found in the mountains around Iron Scar. The mines of Iron Scar provide iron ore and numerous other minerals to Dawning Star and friendly faction-camps, though some miners with less concern for politics sell to any faction-camp that can meet their price. The Eos Freedom League is rumored to have a permanent presence in the city to buy up iron ore from pliant miners.

The city itself is fairly small, and only a quarter of Iron Scar's total population actually lives in the city proper. It is a ramshackle town that runs along three main streets stretching through a number of valleys. The buildings are mainly stone and wood. Accordingly, fire is a major concern, and Iron Scar has a number of volunteer fire departments. The city has little differentiation in its layout between commercial, residential, and industrial areas. Next to the principal refinery is a restaurant and a small theater. While Dawning Star is a well laid out work of civil engineering, Iron Scar is a confused mess of a city with few paved roads and little in the way of urban planning. Iron Scar came into existence almost overnight, and the city has never bothered to correct the mistakes made in those first few years. Water and sewage are often problems in Iron Scar, though the Republic has been placing an increasing amount of funding into fixing the city's problems to avoid public health concerns.

Iron Scar is under the control of Mayor Michael Willis, a savvy political figure. Although elected in a popular election, no one is quite sure how he prevailed, as few people in Iron Scar like him. Most inhabitants of the city consider him corrupt, guilty of trading with the faction-camps against Republic regulations, but thus far no proof has come to light. The main check to the mayor's power is Sheriff Wendy Singh, the elected constable of the city. A retired Republic Ranger of some renown, she does not put up with crime in her city and is not afraid to act as judge, jury, and executioner if she feels the crime warrants such a response. While Sheriff Singh knows miners are a rough lot that like to blow off steam, she meets anything besides a good natured brawl with guns drawn and precious little patience. She conflicts regularly with the mayor, who is constantly trying to find a way to replace her as sheriff.

Compared to Dawning Star, Iron Scar is a rough and rowdy town lacking a few of the trappings of civilized society. Brawls are common, and entertainment is usually found at the bottom of a bottle. Iron Scar is a place for Republic citizens to seek

their fortune when the laws of Dawning Star become too restrictive.

Harvest Town

Leader: Hemaraj Last

Population: 5,600

Major Exports/Products: Agricultural Products

Major Imports: Finished goods

Progress Level: 6

Purchase DC Limit: 35

Black Market DC: 25

Item Restriction Limit: Lic (+1)

The main agricultural settlement of the Dawning Star Republic, it also serves as the capital of the Eastern Resource Zone. Harvest Town's entire existence revolves around tending the fields of the Eastern Resource Zone, which provide the majority of the food consumed by the Dawning Star Republic. The city is very small and is very well ordered. Harvest Town is considered by many to be the sleepy, small town of the Dawning Star Republic, something its residents pride themselves on. Harvest Town rarely gets mentioned outside of food products in the rest of the Republic.

Red Hill

Leader: Mayor Johan Seral

Population: 12,700

Major Exports/Products: Agricultural products, relics, minerals

Major Imports: Finished goods

Progress Level: 6

Purchase DC Limit: 40

Black Market DC: 15

Item Restriction Limit: Res (+2)

The most dangerous town in the Republic, Red Hill was annexed years ago by the Dawning Star Republic and has never really recovered. A hotbed of activity for the Eos Freedom League and various faction-camps, it is a town filled with spies, black marketers, and desperate lawmen. While ostensibly the Republic controls the town through Mayor Johan Seral, the mayor has been intimidated into inaction by the forces at work in his city. The sheriff is widely rumored to have been bought off by the Eos Freedom League, leaving the responsibility for law and order in the hands of Sagel Harris, a Republic Ranger assigned to the region. Red Hill is a dangerous town that most citizens of the Republic do their best to avoid.

Greenville

Leader: Mayor Sylvia Pesnor

Population: 5,600

Major Exports/Products: Fruit, rubber

Major Imports: Finished goods, food
Progress Level: 6
Purchase DC Limit: 30
Black Market DC: 25
Item Restriction Limit: Lic (+1)

Greenville is the capital of the Southern Resource Zone and the center of the booming peccar fruit industry. Its plantations stretch for miles and put fruit on a significant number of the tables in the Republic. The local farmers also grow terran fruits and harvest rubber from rubber trees for use in various industries in Dawning Star. While Red Hill is the obvious hotbed of illegal activity in the Republic, Greenville is the hub of more covert illegal activities. Operating under an arcane system of favors, gentile behavior, and bribery, Greenville is the quiet town where relics, foods, and industrial goods can be easily bought and sold as government officials look the other way. The town does not suffer the tension of Red Hill. Instead, the corruption is an accepted part of living in Greenville, and most of its citizens have accepted this and decided to profit from it. While many “irregular” items are available to any buyer in Greenville, weapons and military goods are not. Although they may be interested in profit, the people of Greenville consider themselves loyal citizens of the Republic.

◆ FACTION-CAMPS

The faction-camps are settlements created by those who left the Republic after getting fed up with its laws, left for want of power, or left for a simple change in lifestyle. Most faction-camps are a curious combination: a den of thieves, a political movement, a black market, and a frontier town. More than anything, faction-camps value their independence, and they are inhabited by individuals who will readily fight to protect it. Most faction-campers affirmatively dislike and distrust the government of the Republic. Some hope to just live out their lives, free in their new home, while others seek to change the Republic, either through peaceful means or force,

into a country they can be a part of. Faction-camps are places of ideology, greed, and freedom all wrapped up under a guise of civilization. They are not for the timid or faint of heart, for such people will be eaten alive. Some say Dawning Star eats people up with its fast living and artificial qualities, but on a per capita basis, faction-camps put far more people into graves each year.

Broken Town

Leader: Thomas Dillon
Population: 15,600
Major Exports/Products: Relics, silicon
Major Imports: Finished goods, food
Progress Level: 7
Purchase DC Limit: 35
Black Market DC: 15
Item Restriction Limit: Mil (+3)

Broken Town is one of the faction-camps on friendly terms with Dawning Star—but just barely. The settlement was founded by its current leader, Thomas Dillon, who left the Republic in its earliest days because he favored military rule instead of the Republic. Initially, Thomas was alone in the wilderness, but over time other, like-minded individuals joined him, most of whom had military experience. Thus was born one of the most militant faction-camps on Eos. The entire population is part of the militia, and children begin receiving combat training at age eight. Broken Town trades with both the Eos Freedom League and the Dawning Star Republic, keeping both at arms-length to ensure its independence. The deserts to the east of Broken Town are some of the richest silicon deposits on Eos, making Broken Town an important part of the colonial economy. Without silicon, there are no computers. Both the Eos Freedom League and The Dawning Star Republic have a vested interest in keeping Broken Town productive and generally keep their squabbles out of the town. Thomas Dillon and his marshals do not take spies or malcontents well, and most crimes are punished by hanging.



Hapeville

Leader: Professor Mina Chandra
Population: 3,400
Major Exports/Products: Relics, minerals, pectar fruit
Major Imports: Food, finished goods
Progress Level: 6
Purchase DC Limit: 35
Black Market DC: 20
Item Restriction Limit: Mil (+3)

One of the quieter faction-camps on Eos, Hapeville is the prime location for relic hunters on Eos. Nestled in the middle of a grouping of a dozen ruins, all within a hundred miles, the faction-camp is a bustling place, full of visitors and treasure seekers. Most of the inhabitants make their living catering to these out-of-towners, with more than a few making a quick credit selling fake treasure maps to supposed relic hoards. Hapeville also has a number of mining operations and pectar plantations in its vicinity, providing the only source of pectar fruit outside the Dawning Star Republic. Hapeville is a member of the Eos Freedom League, but this stance is largely due to a desire to ignore the Republic's guidelines on searching ruins. Hapeville contributes little to the military efforts of the Eos Freedom League, but does occasionally donate supplies and interesting relics to the cause. The settlement was begun as an academic operation by its current leader Professor Mina Chandra, and many of its residents are scientists and researchers, who felt that the intellectual climate of Dawning Star was growing stale.

Lanner's Crossing

Leader: Uzoma Siler
Population: 9,900
Major Exports/Products: Agricultural products, murcow leather and meat
Major Imports: Finished goods
Progress Level: 5
Purchase DC Limit: 30
Black Market DC: 15
Item Restriction Limit: Mil (+3)

The only settlement on Africus, it was principally founded by a group of murcow ranchers, who felt that the plains around Dawning Star were becoming too crowded. Some were merely murcow rustlers, who wanted to get off Dawnhome before their crimes were discovered. They reached Africus with a mixture of rightfully purchased and stolen murcows and created a town that has become the biggest producer of murcow meat outside of the Dawning Star Republic. Lanner's Crossing meat is also considered to be of a higher quality than the meat in the Republic, and it is highly sought after by the upper class of Dawning Star. The fact that Lanner's Crossing is an outspoken member of the

Eos Freedom League and that trade with the settlement has been banned by the Colonial Congress has had little impact on the demand for their meat. Lanner's Crossing is a surprisingly well ordered and peaceful town, which survives on the murcow trade, but the Eos Freedom League and the criminal element have a strong presence in the city. For the most part they keep a low profile, as the residents of Lanner's Crossing are notoriously stubborn and do not suffer fools or troublemakers.

Delhi

Leader: Markal Keskar
Population: 16,200
Major Exports/Products: Corn, wheat, agricultural products
Major Imports: Finished goods
Progress Level: 5
Purchase DC Limit: 30
Black Market DC: 20
Item Restriction Limit: Mil (+3)

The primary settlement on New India, Delhi was founded by a group of terraformers, who were frustrated with the snail's pace used to introduce terran plants and animals to Eos. These settlers stole a number of creatures and seed samples from the creature tanks and moved to New India to try their hand at creating their own Garden of Eden. The results were mixed at best, but Delhi is the leading producer of terran agricultural goods on Eos, including wheat, corn, murcow meat, and several varieties of fruit. Needless to say, the Dawning Star Republic does not look kindly on Delhi. All trade with the settlement has been banned, though as expected a healthy black market exists for Delhi foods, especially among those elderly colonists who remember Earth fondly. Because of this, Delhi has been driven to the Eos Freedom League and has become a ready supporter of its actions. It provides many of the agricultural staples those in the Freedom League require in return for military equipment and industrial products. Delhi has also become the center of operations for the Terraformers Guild. From its very beginning, Delhi has been a settlement with a sense of hurry and controlled by the idea that things can always be done faster and better. Despite its small size, it can eat up unsuspecting immigrants with its fast pace and the many harsh lessons found on its streets.

Roger's Point

Leader: Patricia Rogers
Population: 28,400
Major Exports/Products: Fish, lumber, weapons, industrial goods
Major Imports: Raw materials, food
Progress Level: 7
Purchase DC Limit: 40

Black Market DC: 15
Item Restriction Limit: III (+4)

Roger's Point is the preeminent trouble-making member of the Eos Freedom League and the largest faction-camp on Eos. It is the third largest settlement on Eos and the largest outside the Dawning Star Republic. It ranks second only to Dawning Star in industrial power and has more weapons per capita than any settlement on the planet. It is a capitalistic paradise, where anything can be had for the right price and money rules government. Roger's Point is a dangerous town for the unwary, but those who know it well can walk the streets without fear. Everyone in the city is constantly busy working, sleeping, or going to work. More so than the Republic, work rules Roger's Point, and not working your hardest is considered a sin. Because of this ethic, Roger's Point is amazingly productive and is the main producer of seafood and lumber on Eos. It uses these products to trade for raw materials for its workshops and industrial plants, many of which are dedicated to making weapons.

Roger's Point is ruled by Patricia Rogers, a former inhabitant of Dawning Star and an organizational master and manipulator with few peers. She also is responsible for creating and leading the Eos Freedom League. On some levels, the EFL acts as her personal support network, helping Roger's Point become a power to rival the Dawning Star Republic. Patricia Rogers makes no secret she wants power and lots of it, gaining her a large number of sycophants and yes-men who try to ride on her coattails. Such rides are usually tragically short, because Patricia Rogers cannot stand ineptitude. She is well-known for carrying the most recognized relic on Eos at her side at all times, a six-foot staff called the Roger's Staff. This staff is suspected to alter the minds of those in its presence to make them more pliable to Patricia Rogers's ideas, but its only sure feature is an ability to fire darts of deadly mental energy on command. More than a few yes-men have found themselves relieved of duty by this device.

Shackelton

Leader: Ernie Sykes
Population: 2,700
Major Exports/Products: Furs, scientific information, minerals, fish
Major Imports: Food, industrial goods, lumber, boats
Progress Level: 5
Purchase DC Limit: 25
Black Market DC: 25
Item Restriction Limit: Mil (+3)

The northernmost settlement on Eos, Shackelton was originally founded as an exploratory settlement

by the Dawning Star Republic in the hopes of learning more about the tundra regions of Eos. Unfortunately, conflicts with Roger's Point caused the Republic to abandon the settlement after a few years. When the time for extraction came, not all the scientists and hunters were willing to go. Many remained to continue exploring the tundra regions of Eos, hunting the animals that live there, and searching for relics in the scattered ruins of the region. Shackelton is not a particularly wealthy settlement, and its populace has a reputation for mental instability owing to the months of night during the winter. However, the settlement has managed to survive several years now separate from the Republic. Shackelton trades regularly with both the Republic and the Eos Freedom League, but leans more toward the former than the latter. The inhabitants of Shackelton remember well the interference from Roger's Point that led the Republic to pull out of the settlement, and they still carry a grudge.

Steel End

Leader: Sebastian Crane
Population: 8,100
Major Exports/Products: Building materials, raw materials, lumber
Major Imports: Food, finished goods
Progress Level: 6
Purchase DC Limit: 35
Black Market DC: 20
Item Restriction Limit: Mil (+3)

Located just south of the Southern Resource Zone, Steel End is situated among a number of ruins that were the reason for its founding. While Hapeville is the leading source for relics on Eos, Steel End salvages more raw materials from its neighboring ruins than any other settlement. A mixture of a mining town, a scrap yard, and a lumberjack camp, Steel End also produces more building materials than any other faction-camps and trades often with all of the other faction-camps. Steel End is a rowdy town of miners and metal workers, where most disputes are settled with fists and duels. The city has no official leader, but the owner of the biggest store in town, Sebastian Crane, serves as a *de facto* peacemaker among the many inhabitants. Despite the lack of a central authority, the community has a large, well-trained militia equipped with firearms and armor from Roger's Point in addition to the gyro-jet weapons produced locally. Steel End is the leading producer of gyro-jet weapons on Eos, and they are ubiquitous in the settlement. Steel End is a loyal member of the Eos Freedom League and has been a more active member of the League since the regions of the Southern Resource Zone closest to Steel End have become more active in recent years. The inhabitants of Steel End fear they will be annexed in the near future and subjected to

all the laws and controls of the Dawning Star Republic—something they want to avoid. Because of this, some of the Steel Enders have begun making raids into the Southern Resource Zone to cause trouble for the Republic, hoping that the Republic will think the region more trouble than it's worth.

Sun City

Leader: Captain Michael Hennessy
Population: 4,500
Major Exports/Products: Fish, sugarcane
Major Imports: Finished goods, tourism
Progress Level: 5
Purchase DC Limit: 40
Black Market DC: 20
Item Restriction Limit: Lic (+1)

Of all the settlements outside of Dawning Star, Sun City is probably the most peaceful and law-abiding. Founded by Captain Michael Hennessy, a retired member of the Dawning Star's original marine detachment, the city is the first tourist town on Eos. Boasting beautiful beaches, a tropical climate, luxury accommodations (for Eos at least), and a wide variety of entertainment, Sun City has become the location of choice for those Eotians who can afford to take vacations. Captain Hennessy does his utmost to keep Sun City out of politics and make it accessible to all inhabitants of Eos regardless of political affiliation. Unfortunately for Sun City, not many people on Eos take vacations, so his business is somewhat limited. This has forced him to diversify into growing sugarcane, which he purchased legally from the creature tanks. Sun City has a fairly relaxed, inviting environment, but it has developed a darker underside as the welcoming nature of the place has made it a haven for spies and those doing black market business. Citizens of Dawning Star who wish to buy faction-camp goods usually come to Sun City to do it. Sun City has become the ultimate neutral ground on Eos, a situation that Captain Hennessy delicately preserves by showing no favoritism. Secretly, he fears someone will try and claim his island paradise.

Sunder Ridge

Leader: General Mortimer Cross
Population: 15,080
Major Exports/Products: Minerals, raw materials
Major Imports: Food, industrial goods
Progress Level: 5
Purchase DC Limit: 40
Black Market DC: 15
Item Restriction Limit: Mil (+3)

The most militant member of the Eos Freedom League besides Roger's Point, Sunder Ridge was also one of the first faction-camps. Settled shortly

after the founding of the Dawning Star Republic, it was in place before the creation of the Eastern and Southern Resource Zones, between which it is now stuck with little territory to its name. Sunder Ridge's primary industry is mining the mountains surrounding it. Before the Resource Zones were claimed by the Republic, it also did a strong business in agricultural goods and pectar fruit grown in the Green Sea. When the Republic claimed the Resource Zones, they thought they had given Sunder Ridge sufficient growth space and were surprised when the inhabitants of Sunder Ridge carried out attacks on the outlying regions of the Resource Zones. The Republic retaliated in the hopes of reducing the frequency of these raids, and the regions around Sunder Ridge have become a contested area, where the Eos Freedom League and the Eos Defense Force play cat and mouse, trying to outmaneuver one another without provoking an all out war. Sunder Ridge receives extensive support from Roger's Point in terms of military equipment.

OTHER POINTS OF INTEREST • • •

The following section describes the other notable areas on Eos.

◇ THE RESOURCE ZONES

Shortly after the founding of Iron Scar, the Dawning Star Republic solidified claims to surrounding regions of Dawnhome under the guise of the Northern, Southern, and Eastern Resource Zones. These zones were meant to be a clear signal to the faction-camps that the Republic would defend its now clearly defined territory in the hopes it would persuade future faction-camps to settle farther away from the Republic. Instead, the Resource Zones have, for the most part, inflamed the faction-camps. They see the Zones as nothing more than a land grab by the Republic. Less than ten percent of the current Resource Zones' total area is utilized by the Republic, the rest being claimed in the interest of future growth of the Republic. Unfortunately for the faction-camps, many of the prime areas of Dawnhome have been claimed, including most of the land suitable for large-scale agriculture. Because of this, raids on the outer areas of the Resource Zones are becoming more common, especially in the Southern and Eastern Resource Zones. The Eos Defense Force is sending more troops to deal with these attacks, but thus far they have had little luck eliminating them without escalating to a full-scale war, something the Republic is loath to do.

Resource Zones are patrolled by Republic troops from either the EDF or the Republic Militia. They have some decent roads to connect major settlements, and they receive civil support from Dawning Star in the form of money, resources, bureaucrats, leaders, and lawmen. Despite this civilized veneer, most Resource Zone settlements are very remote,

surrounded by dozens of miles of wilderness, creating a frontier feel reminiscent of some of the more organized faction-camps. Most settlements in the Resource Zones are no more than a few hundred people, Red Hill being the largest settlement. Between these settlements are dozens of single-family farms and homesteads, each claiming a few square miles of land. While the Republic patrols these regions, the patrols cannot be everywhere at once, and many of these areas are still wild. Almost every farmer owns at least one firearm for dealing with wild Dawson dragons and the like.

◆ THE RUINS OF EOS

Scientists have speculated that a full five percent of Eos's landmasses are covered with the ancient cities of the original inhabitants of Eos. This means Eos once held a civilization of immense proportion that probably counted many billions of individuals. Now, they are all gone and have left little record of their existence. With all the problems confronting the colony, there has been surprisingly little energy devoted to understanding the ruins. Instead, most people have been working on finding a way to exploit them by recovering relics and salvageable materials. There is little doubt that many items of historical import have been destroyed in these searches, and later generations may curse their ancestors for being so careless.

Most of these ruins are at least tens of thousands of years old and are in advanced states of decay. There have been precious little signs of living beings found. Instead there are just the ruins of buildings and other structures that have resisted wear. The few records, pieces of media, and bits of writing have not been successfully translated, but some basic facts have been ascertained. The civilization was wiped out by some manner of widespread natural disaster or attack, and the inhabitants all died within a few weeks of each other. Few signs of this event remain, leading many researchers to speculate it was some type of biological event linked to the rust spores. Signs of conflict have been found in some buildings, such as burns from plasma weapons, but any evidence of a large-scale invasion seems to have faded long ago.

The velin live among these ruins and often fight to protect them, but they do not have any particular knowledge of their function, construction, or original inhabitants. The velin claim the cities were destroyed in an ancient war against great evils and that the evils persist on Eos. These claims are dismissed as some sort of mythology that has the barest basis in fact. The velin do have knowledge of the materials found in the ruins and how to use them. They do not readily share this information with humans. Other than that, the technology that seems to have been so prevalent on Eos is largely lost.

There are three main types of ruins on Eos: city ruins, fortress ruins, and the Council Ruins. The city ruins are the most common and largest type of ruin, though they produce the least amount of relics or salvageable material. These structures are assumed to be the cities of ancient Eos, and most are of immense size, indicating a population of many million beings. Some of these ruins have oddly sized and shaped doors. This has led some scholars to speculate that multiple races once used these structures and that Eos was once inhabited by a number of sentient species and not just the ancestors of the velin. City ruins are the ones most frequented by relic hunters, salvagers, and velin due to their number. Unfortunately, these ruins are also often home to spitter spiders and similar creatures, making the exploration of them hazardous, though not as hazardous as fortress ruins.

Fortress ruins have more materials and more relics than city ruins but are rarer and more dangerous. Fortress ruins are so named due to the large walls that surround them and the sturdier construction used in their buildings. These ruins show more signs of battle damage than others. Fortress ruins represent only five percent of the total number of ruins on Eos, but they are notorious for being rich in relics and useful materials. Unfortunately, fortress ruins also claim more explorers than city ruins, and most who enter them never return. What exactly makes these ruins so dangerous has not been blamed on any common source, but some explorers who have survived cite a large number of traps and fearsome beasts. Only the hardest souls explore fortress ruins.

There is a single Council Ruins on Eos, located west of Dawning Star in the Bergan Lowlands. This is the single largest city ruin on Eos, measuring almost ten miles across in a circular shape. It is a truly immense construction, at the center of which is a large circular dome that contains a council chamber of sorts thought to be the capital of ancient Eos. Due to this discovery, the Council Ruins has been declared off-limits by the Republic until the proper archaeological studies can be carried out. Despite this declaration, a number of relic hunters are caught trying to sneak inside each year.

FACTIONS AND FEDERATIONS • • •

When the humans landed on Eos they were united in one cause, working together to help ensure the continued survival of the human race. In the decades that followed, as prosperity returned, the colonists began to bicker over power and how best to lead the remaining humans. This unrest led to the formation of the faction-camps. Now, where humanity once greeted challenges as a united force, a number of factions and groups stand, each struggling on their own towards their own goals. They still seek to protect the human race, but some

also desire power, wealth, or freedoms that others would take from them. Eos is a factionalized world, which seems to be growing more and more fractured with time.

◇ THE DAWNING STAR REPUBLIC

The most powerful political entity on Eos, the Dawning Star Republic controls most of the Dawnhome continent and is home to the largest population, most of the weaponry, and the major industrial facilities found on Eos. The Republic has a population of just over 2.5 million citizens, a standing army 20,000-strong, and a militia of over 400,000 that can be called up within a few hours notice.

Government is modeled on the American system. The Republic is a representative democracy led by a President elected to six-year terms with a two-term limit. The Colonial Congress, consisting of 21 senators elected to four-year terms with no term limits, serves as the law-making body of the Republic. Numerous judges oversee the judicial processes of the nation, and law enforcement is handled by a wide variety of police officers, sheriffs, deputies, and the elite Republic Rangers. The Republic has a high number of civil employees due to all the military, terraforming, and civil engineering projects that fall under its purview. To fund these efforts, the Republic has a flat income tax and a tax on exports to and imports from faction-camps outside the Republic.

Generally, the leaders of the Republic receive high approval ratings from their constituents, but these vary according to a wide variety of factors such economic climate or scandals. Despite this general approval of the government, the citizens of Eos are very outspoken when they feel wronged and do not brook what they see as poor treatment from the government. The citizens of the Republic are used to knowing their leaders personally, or at least feeling like they do, due to the small population of the colony. Accordingly, they expect a high amount accountability from their leaders. Paradoxically, most colonists have a strong independent streak, causing them to resist the government if they think the cause is right. While this feeling is stronger in the regions outside Dawning Star, the city's inhabitants also have a reputation for being stubborn when they feel they are in the right.

The current leader of the Republic is President Sarah Pen, who also serves as the mayor of Dawning Star. One of the original civilian organizational staff carried over on the *Dawning Star*, she is an expert in economics and diplomacy and has effectively surrounded herself with a number of very proficient advisors to cover her weak points. Her presidency is not known for daring or innovative policy but rather steady growth and effectiveness. President Pen enjoys popular support in the Republic.

The Eos Defense Force is currently led by General Jackson Small, one of the marine commanders on the *Dawning Star*. A career soldier he is well versed in most forms of combat but leaves matters involving space travel to the Eos Space Force and Admiral Yates. A stickler for details and discipline, he works constantly to keep his forces in shape and their equipment top-notch. While General Small is not a warmonger, he constantly warns that the faction-camps are plotting against the Republic and a preemptive strike is necessary.

◇ EOS FREEDOM LEAGUE

Founded and led by the leader of Roger's Point, the Eos Freedom League mainly serves as a loose organization to coordinate efforts to help its members thrive and to stymie the Dawning Star Republic. The Eos Freedom League's membership is made up of the faction-camps with greater animosity to the Republic; however, a number of more moderate settlements pay lip service to the group to avoid trouble with them. The Freedom League spends most of its resources building infrastructure between its member settlements and erecting a common defense, both against the Dawning Star Republic and whatever other threats may appear. While the Eos Freedom League has only a fraction of the power of the Dawning Star Republic, they are fervent believers in their cause and have a better knowledge of the planet beyond the Republic's borders.

The Eos Freedom League has few rules for its members, most of which are concerned with allocation of military resources and favored trade status of fellow league settlements. All League members are expected to spend a certain amount of resources each year on defense and be able to field a sizeable militia when called upon, which happens very rarely. The Eos Freedom League has never mobilized its entire force for any cause. The closest to such an event was the battle of Red Hill, when about three-fourths of the League took part. It would take an attack of overwhelming force to persuade the more moderate members of the League to such large-scale mobilization. If the entire League militia were called out and gathered, they could field 50,000 troops of varying experience, poor equipment, and few vehicles to speak of. The League militias do not pose much of a threat to Dawning Star outside of guerilla operations on their own territory, at which they excel.

The long-term goals of the Eos Freedom League are to become the preeminent power on Eos, eclipsing the Dawning Star Republic in time. While some members prefer to accomplish this through economic and political means, many members prefer military conflict as soon as the faction-camps have grown powerful enough. Despite the fact the faction-camps have almost double the rate of population growth of the Republic, it will take many

years for them to become a real threat. In the meantime, they look for whatever advantages they can find, such as relics, new industrial procedures, or new weapons technology.

◇ **TERRAFORMER'S GUILD**

The terraformers who originally landed on Eos were dedicated professionals, charged with making the new home of humanity habitable. For three decades, they labored tirelessly towards this end. Once the atmosphere was made suitable, the terraforming efforts of the Republic were curtailed, and the terraforming budget was cut. The next terraforming project, introducing Earth life forms to Eos, was scheduled with a timeline of scores of years. Eventually, some terraformers grew frustrated with this lack of support from the Republic, claiming they could have an exact duplicate of Earth in 50 years, if they were given the proper funding. Due to the respect for the velin and fears of causing dangerous disruptions in the ecosystem, the Republic did not back such a plan. This caused some terraformers to leave the government-sponsored programs to form the independent Terraformers Guild.

The Terraformers Guild has less than 50 members and limited equipment, now that they no longer have access to the creature tanks, but they wield a surprising amount of power on Eos. They have cobbled together a respectable amount of terraforming equipment on their own and now offer their services to anyone who can pay their prices. Want a desert changed into a grassland? They can do it. Want a river diverted and filled with terran fish to create a hatchery? They can handle that too. World-changers for hire, these terraformers have made a respectable amount of wealth working for various settlements both within and without the Republic. Generally, the Republic does not look favorably on the efforts of the Guild, who the government thinks are using their terraforming skills too carelessly, but they do not have the resources to stop their activities. Now, based out of Delhi, the Terraformer's Guild is quickly becoming an influential group on Eos, rivaling their old fellows in Dawning Star. They have even begun constructing their own version of the creature tanks in Delhi. If their activities continue, it is likely the Republic will take active steps to stop them.

◇ **THE VELIN TRIBAL COUNCIL**

The velin are not an organized people by nature. They live in tribes of several dozen members, each of which is related to several other tribes in the area through marriage. Each tribe travels a set migratory path over the year, spending time at various locations, which they share with other tribes for weeks at a time. Tribes generally settle disputes within the tribe themselves, and disputes between tribes are settled

by bringing in a third party to mediate a discussion between tribal leaders. When this fails, the tradition had been war. Now, the velin have created the tribal council to help lead their species as a whole.

The velin tribal council was created shortly after contact with the humans in order to present a unified diplomatic front. The velin tribes of Dawnhome sent messengers to a massive meeting near the Council Ruins, where a council of tribal elders was chosen to speak to the humans on behalf of the velin race. Most of the tribes of Dawnhome participated in the meeting, though a few boycotted, and the few tribes on Europa, Africus and New India did not take part either. These newly selected leaders met with the humans and did well, showing the velin the advantages of a central authority. After the diplomatic arrangements with the humans were completed, the tribal council remained in place to serve as a governing body for the velin, their main responsibility being to resolve disputes between tribes. The council could also gather the velin people together in times of great strife or war, but they have few actual powers delegated to them by the velin people. Instead, they serve as arbitrators and advisors, having little power to enforce their decisions except what the velin give them. Luckily, the members of the tribal council are very wise, and most velin respect their decisions. As of yet, there has been no substantial challenge to their authority. The tribal council continues to meet regularly in a permanent settlement near the Council Ruins, the first permanent settlement constructed by the velin.

The one thing the tribal council has actively worked towards is preparing the velin to go to war with the vaasi, which the council believes are a growing threat. The humans have been completely dismissive of the velin warnings about the vaasi, so the tribal council has decided it must fight the vaasi until the humans are convinced of their error. To this end, the council has been organizing groups of hunters to pursue vaasi sightings across Eos, concentrating on the areas around fortress ruins.

PERSONALITIES OF EOS • • •

Below are descriptions of some specific NPCs and a handful of generic NPC archetypes populating Eos. This section is meant to provide an example of some of the kinds of people found in DAWNING STAR.

◇ **WILMA FRIEDMAN, REPUBLIC RANGER**

Wilma Friedman was born fifteen years after the *Dawning Star* landed on Eos, the daughter of two marines that were part of the original crew of the *Nebraska*. During the colonization process, they transferred to the surface and helped run security for the terraforming operations, eventually becoming two of the first Republic Rangers after the founding of the Dawning Star Republic. Wilma eagerly fol-



lowed in her parent's footsteps, beginning her career in the police precincts of Dawning Star and eventually earning an assignment as a sheriff of a small farming town outside Dawning Star.

At 28, she earned her promotion to Republic Ranger by catching a group of smugglers running weapons from Dawning Star to Sunder Ridge, arresting the eight transgressors single-handedly. She was then transferred to the Republic Rangers, carrying on the family tradition of protecting the people of Eos. By this point, both of her parents had retired to Iron Scar, preferring the boisterous life of a frontier town to the urbanity of Dawning Star. Unfortunately, three years after her promotion to Ranger, Wilma's father was killed in a gun battle while assisting Sheriff Singh with a group of faction-camp spies. This has driven Wilma to spend much of her time in the area around Iron Scar trying to catch the faction-campers who have been working in the area.

Wilma Friedman is a no-nonsense officer of the law, who does not put up with rowdiness or disrespect. This has earned her the ire of some of the miners of Iron Scar, because they are used to some leeway from Sheriff Singh. She is developing a reputation for being hard on faction-campers, and some Eos Freedom Leaguers have considered trying to remove her from the picture. This would be difficult, because she is a skilled Ranger and has

many allies both in the Dawning Star Republic government and the Eos Defense Force.

Wilma Friedman
(Tough Hero 4/Lawman 7/Republic Ranger 2)
♦ CR 13

Medium-size Humanoid; HD 6d10+7d8+39; hp 107; MAS 18; Init +1; Spd 30 ft.; Defense 23, touch 19, flat-footed 22 (+1 Dex, +7 class, +3 armor); BAB +10; Grap +10; Atk +10 melee (1d10/x3, durasteel longsword), +11 ranged (2d8, EDF-15 Assault Rifle), +13 ranged (2d6+2, EDF-9 Autopistol); Full +10/+5 melee (1d10/x3, durasteel longsword), +11/+6 ranged (2d8, EDF-15 Assault Rifle), +13/+8 ranged (2d6+2, EDF-9 Autopistol); FS 5 ft. by 5 ft.; Reach 5 ft.; SQ Force of Law, Ranger Reputation, Region Familiarity (Northern Resource Zone), Weapon Specialization (EDF-9 Autopistol), Word of Law; AL Dawning Star Republic; SV Fort +14, Ref +4, Will +7; AP 13; Rep +7; Str 10, Dex 13, Con 16, Int 14, Wis 14, Cha 10.

Occupation: Law Enforcement.

Skills: Bluff +11, Drive +6, Gather Information +11, Intimidate +15, Investigate +12, Knowledge (Civics) +10, Knowledge (Streetwise) +16, Read/Write English, Research +6, Ride +4, Sense Motive +12, Speak English, Spot +12, Survival +12, Treat Injury +8.

Talents: Remain Conscious, Second Wind.

Feats: Advanced Firearms Proficiency, Archaic Weapon Proficiency, Armor Proficiency (Light), Attentive, Brawl, Great Fortitude, Frightful Presence, Improved Brawl, Iron Scar Familiarity, Personal Firearms Proficiency, Simple Weapon Proficiency, Surface Vehicle Operation, Weapon Focus (EDF-9 Autopistol).

Possessions: Rough outs, EDF-9 auto-pistol, EDF-15 assault rifle, badge, trail rations, SE-10 Styler Scout Bike.

♦ **MARCUS REYES,**
EOS FREEDOM LEAGUE DISSIDENT

Marcus Reyes was born 25 years ago in Dawning Star to a civil servant and a terraformer, both of whom always had someplace to be other than home. Growing up largely alone, he ended up getting involved with the street culture of Dawning Star, and in his late teens he joined a political movement whose goal was to get Dawning Star to relinquish claims to the Resource Zones so the planet's resources could be more equitably divided. This group's intentions and motives were peaceful, but one of its members was not so patient. During a demonstration, he lobbed a grenade into a formation of Eos Defense Force troops, causing a riot. During the riot, Marcus escaped but was later blamed by both the EDF and his political allies for



throwing the grenade, even though he had nothing to do with it. Fearing for his life, he fled Dawning Star to Roger's Point, convinced more than ever that Dawning Star was a corrupt state that would make up lies about innocent men to appease public outrage.

Upon reaching Roger's Point, Marcus put his organizational skills to work for Patricia Rogers, becoming a logistical officer for the Eos Freedom League. He organized the military supplies of the group and made sure each faction-camp was allocated the right amounts. He soon found himself missing the excitement of actually going out and doing things by hand. Eventually, he managed to convince Patricia Rogers to assign him a field detail. Now, he is organizing an Eos Freedom League cell within Iron Scar, right under the Dawning Star Republic's nose.

Marcus Reyes
(Charismatic Hero 3/Negotiator 3) ♦ CR 6

Medium-size Humanoid; HD 3d6+3d8+6; hp 31; MAS 12; Init +0; Spd 30 ft.; Defense 16, touch 13, flat-footed 16 (+3 class, +3 armor); BAB +3; Grap +3; Atk +3 melee (1d4, knife), +3 ranged (2d6, EDF-9 Autopistol); Full +3 melee (1d4, knife), +3 ranged (2d6, EDF-9 Autopistol); FS 5 ft. by 5 ft.; Reach 5 ft.; SQ Conceal Motive,

React First; AL Eos Freedom League; SV Fort +5, Ref +3, Will +7; AP 9; Rep +3; Str 10, Dex 10, Con 12, Int 14, Wis 13, Cha 16.

Occupation: Dissident.

Skills: Bluff +10, Diplomacy +9, Disguise +11, Gather Information +10, Intimidate +8, Knowledge (Current Events) +8, Knowledge (Streetwise) +8, Knowledge (Politics) +8, Listen +3, Perform (Fiery Oratory) +9, Read/Write English, Speak English, Spot +3.

Talents: Fast Talk, Coordinate, Inspiration, Dazzle.

Feats: Alertness, Armor Proficiency (Light), Charismatic Plus, Deceptive, Iron Will, Personal Firearms Proficiency, Trustworthy.

Possessions: Undercover vest, knife, EDF-9 Autopistol, info-comp, App-3 Basic program.

♦ **JALICK,**
VELIN HUNTER

The humans do not understand the velin, despite being so much like them. The humans laugh at the vaasi because they cannot see them. The humans see with eyes of logic, not eyes of truth. Thus, the velin must protect the humans—they cannot protect themselves.

Jalick is a guardian of the Black Wind tribe that lives in the plains near Dawning Star. Having interacted regularly with humans, he was chosen by the velin tribal council to travel the human territories and look for signs of vaasi activity. Thus far, he has spent most of his time in the vicinity of Dawning Star, but he plans to head for Iron Scar and then out to the faction-camps. Jalick has no plans to return home for at least a year, meaning he has a lot of wandering ahead of him. He hopes that his mission is ultimately a fool's errand and that the vaasi have left Eos, but he knows in his heart this is probably not true.

Jalick
(Strong Hero 3/Velin Guardian 3) ♦ CR 6

Medium-size Humanoid; HD 6d8+18; hp 46; MAS 19; Init +0; Spd 30 ft.; Defense 17, touch 14, flat-footed 17 (+4 class, +3 armor); BAB +6; Grap +8; Atk +9 melee (1d6+5 plus 1d6 fire, bazer sword), +6 ranged (1d6+2, velin throwing blade); Full +9/+4 melee (1d6+5 plus 1d6 fire, bazer sword), +6/+1 ranged (1d6+2, velin throwing blade); FS 5 ft. by 5 ft.; Reach 5 ft.; SQ low-light vision, detect vaasi, technology unfamiliarity, region familiarity (Northern Resource Zone); AL Velin tribal council; SV Fort +8, Ref +2, Will +4; AP 9; Rep +0; Str 15, Dex 10, Con 16, Int 10, Wis 15, Cha 8.

Occupation: Hunter.

Skills: Hide +5, Listen +4, Move Silently +5, Navigate +7, Speak English, Speak Velin, Spot +4, Survival +14.

Talents: Melee Smash, Improved Melee Smash.



Feats: Alertness, Alien Friend, Archaic Weapon Proficiency, Endurance, Exotic Weapon Proficiency (Bazer Sword), Guide, Improved Damage Threshold, Oathbound (velin tribal council), Track.

Possessions: velin hunter armor, bazer blade, luminstone spear, bundle of pectar fruit, 6 velin throwing blades.

◆ **EOS DEFENSE FORCE SOLDIER**

This archetype can be used to represent Republic soldiers or any martial or law enforcement personnel associated with the Republic.

EDF Soldier

(Strong Ordinary 2/Fast Ordinary 2) ◆ CR 3

Medium-size human; HD 4d8+4; hp 26; MAS 13; Init +2; Spd 30 ft.; Defense 21, touch 18, flat-footed 19 (+2 Dex, +6 class, +3 armor); BAB +3; Grap +6; Atk +7 melee (1d6+3 non-lethal, unarmed strike) or +6 melee (1d6, baton or 1d4, knife) or +4 ranged (2d8, EDF-15 or 3d8, EDF-23L); Full Atk +7 melee (1d6+3, non-lethal, unarmed strike) or +6 melee (1d6, baton or 1d4, knife) or +4 ranged (2d8, EDF-15 or 3d6, EDF-23L); FS 5 ft. by 5 ft.; Reach 5 ft.; AL Republic;

SV Fort +3, Ref +4, Will +0; AP 0; Rep +0; Str 16, Dex 14, Con 13, Int 12, Wis 10, Cha 8.

Occupation: Military.

Skills: Climb +5, Drive +7, Jump +5, Knowledge (Tactics) +8, Knowledge (Current Events) +6, Profession +5, Read/Write English, Repair +3, Speak English, Survival +4, Swim +5.

Feats: Armor Proficiency (Light), Armor Proficiency (Medium), Brawl, Simple Weapon Proficiency, Personal Firearms Proficiency.

Possessions: Uniform, light combat armor, knife or baton, EDF-15 rifle with 2 clips or EDF-23 laser rifle with 2 power packs.

◆ **EOS FREEDOM LEAGUE THUG**

This archetype is suitable for EFL couriers, hired guns, or even soldiers. Experienced EFL officers and intelligence agents will be of higher level.

EFL Thug

(Tough Ordinary 2/Strong Ordinary 2) ◆ CR 3

Medium-size human; HD 2d10+2d8+12; hp 37; MAS 16; Init +1; Spd 30 ft.; Defense 17, touch 15, flat-footed 16 (+1 Dex, +4 Class, +2 armor); BAB +3; Grap +5; Atk +5 melee (1d6+2 non-lethal, unarmed strike) or +4 ranged (2d6 EDF-09, knockoff or 2d10, Brase Arms, shotgun); Full Atk +5 melee (1d6+2 nonlethal, unarmed strike) or +4 ranged (2d6, EDF-09 knockoff or 2d10, Brase Arms shotgun); FS 5 ft. by 5 ft.; Reach 5 ft.; AL EFL; SV Fort +7, Ref +1, Will +1; AP 0; Rep +0; Str 14, Dex 13, Con 16, Int 10, Wis 12, Cha 8.

Occupation: Criminal.

Skills: Drive +5, Gamble +7, Jump +6, Intimidate +1, Knowledge (streetwise) +7, Read/Write English, Speak English.

Feats: Armor Proficiency (light), Brawl, Faction-Camp Familiarity, Personal Firearms Proficiency, Simple Weapons Proficiency.

Possessions: Scout armor, EDF-9 knockoff with 2 clips or Brase Arms shotgun with 10 rounds.

◆ **EXPLORER**

This archetype is suitable for adventurers, relic seekers, or xeno-biologists out in the field.

Explorer

(Smart Ordinary 2/Dedicated Ordinary 2) ◆ CR 3

Medium-size human; HD 4d6+4; hp 21; MAS 12; Init +1; Spd 30 ft.; Defense 17, touch 14, flat-footed 16 (+1 Dex, +3 class, +3 armor); BAB +2; Grap +2; Atk +2 melee (1d3 nonlethal, unarmed strike) or +3 ranged (2d6, EDF-09 knockoff); Full Atk +2 melee (1d3 nonlethal, unarmed strike) or +3 ranged (2d6, EDF-09 knockoff); FS 5 ft. by 5 ft.; Reach 5 ft.; AL any;

SV Fort +3; Ref +1; Will +6; AP 0; Rep +2; Str 10; Dex 13, Con 12, Int 16, Wis 14, Cha 8.

Occupation: Explorer.

Skills: Balance +8, Climb +8, Craft (of choice) +8, Decipher Script + 8, Disable Device +8, Drive +6, Escape Artist +6, Investigate +8, Knowledge (of choice) +8, Knowledge (of choice) +8, Navigate +13, Repair +8, Read/Write English, Search +8, Speak English, Speak Velin.

Feats: Dodge, Focused, Guide, Personal Firearms Proficiency, Simple Weapon Proficiency.

Possessions: Explorer outfit, rough out, portable glow lamp, handheld navigator, EDF-9 or knockoff with 2 clips, a few pieces of acquired junk.

◆ RANCHER

This archetype is suitable for ranch hands, murcow herders, and anyone making a living in the wilds taking care of herd animals.



Rancher

(Strong Ordinary 2/Tough Ordinary 2) ◆ CR 3

Medium-size human; HD 2d8+2d10+8; hp 33; MAS 14; Init +1; Spd 30 ft.; Defense 16, touch 15, flat-footed 15 (+1 Dex, +4 class, +1 armor); BAB +3; Grap +6; Atk +6 melee (1d6+3 nonlethal, unarmed strike) or ranged +4 (2d10, Brase Arms shotgun or 2d8, GP-05); Full Atk +6 melee (1d6+3 nonlethal, unarmed strike) or ranged +4 (2d10 Brase Arms shotgun or 2d8 GP-05); FS 5 ft. by 5 ft.; Reach 5 ft.; AL any; SV Fort +6, Ref +1, Will -1; AP 0; Rep +0; Str 16, Dex 13, Con 14, Int 12, Wis 8, Cha 10.

Occupation: Ranch-Hand.

Skills: Gamble +2, Handle Animal +10, Intimidate +3, Profession (Rancher) +3, Read/Write English, Ride +11, Speak English, Spot +3.

Feats: Athletic, Animal Affinity, Brawl, Personal Firearms Proficiency, Simple Weapons Proficiency.

Possessions: Brase Arms shotgun with 10 rounds or GP-05 gyro-jet rifle with 2 clips, Rough Out armor, Dawson dragon or murcow harness, murcow prod.

◆ REPUBLIC STARSHIP CREWMEMBER

This archetype can be used for starship pilots, gunners, sensor operators or other bridge or operating personnel. Officers, members of highly trained crews such as that on the *Nebraska*, and other experienced spacers will be higher level.

Starship crewmember

(Fast Ordinary 2/Dedicated Ordinary 2) ◆ CR 3

Medium-size human; HD 2d8+2d6+4; hp 26; MAS 13; Init +3; Spd 30 ft.; Defense 25, touch 19, flat-footed 22 (+3 Dex, +6 class, +6 armor); BAB +2; Grap +2; Atk +2 melee (1d3 nonlethal, unarmed strike) or +5 ranged (2d6, GP-02 or 3d8, EDF-23L); Full Atk +2 melee (1d3 nonlethal, unarmed strike) or +5 ranged (2d6 GP-02 or 3d8 EDF-23); FS 5 ft. by 5 ft.; Reach 5 ft.; AL DS Republic; SV Fort +3, Ref +5, Will +4; AP 0; Rep +1; Str 10, Dex 16, Con 13, Int 12, Wis 14, Cha 8.

Occupation: Spacer.

Skills: Balance +8, Computer Use +7, Craft (Mechanical) +3, Knowledge (earth and life science) +6, Pilot +9, Profession (Spacer) +7, Read/Write English, Speak English, Spot +6, Treat Injury +6, Tumble +8.

Feats: Armor Proficiency (Medium), Personal Firearms Proficiency, Simple Weapon Proficiency, Starship Operations or Starship Gunnery, Zero-G Training.

Possessions: EDF Combat Armor with Environmental Seal, GP-02 gyro-jet pistol with 2 clips or EDF 23 laser rifle with 2 power packs, display glasses or personal communicator.



◆ **TECHIE**

This archetype can be used to represent repair technicians, apprentice scientists, cyberneticists or others working with technology.

Techie (Smart Ordinary 2/Fast Ordinary 2) ◆ CR 3

Medium-size human; HD 2d6+2d8+4; hp 23; MAS 12; Init +2; Spd 30 ft.; Defense 17, touch 17, flat-footed 15 (+2 Dex, +5 class); BAB +2; Grap +2; Atk +2 melee (1d3 nonlethal, unarmed strike); Full Atk +2 melee (1d3 nonlethal, unarmed strike); FS 5 ft. by 5 ft.; Reach 5 ft.; AL any; SV Fort +1, Ref +4, Will +3; AP 0; Rep +2; Str 10, Dex 14, Con 12, Int 16, Wis 13, Cha 8.

Occupation: Technician.

Skills: Computer Use +13, Craft (of choice) +13, Craft (of choice) +8, Decipher Script +8, Disable Device +8, Drive +4, Forgery +5, Knowledge (Technology) +13, Knowledge (choose another) +10, Pilot +7, Profession (technician) +6, Read/Write English, Speak English, Repair +10, Research +8, Search +8.

Feats: Craftsman, Educated, Gearhead, Salvage, Simple Weapons Proficiency.

Possessions: Info-Comp computer or access to another computer, appropriate toolkit and lab equipment.

◆ **VELIN TRIBE MEMBER**

This archetype can be used to represent velin hunters, explorers, or other indigenous tribe members. Velin going to war will be wearing velin battle armor.

Velin Tribe Member (Tough Ordinary 2/Dedicated Ordinary 2) ◆ CR 3

Medium-size velin; HD 2d10+2d6+16; hp 37; MAS 21; Init -1; Spd 30 ft.; Defense 16, touch 13, flat-footed 16 (-1 Dex, +4 class, +3 armor); BAB +2; Grap +3; Atk +3 melee (1d3+1 nonlethal, unarmed strike or 1d6+1, spear) or ranged +1 (1d8, velin hunting bow); Full Atk +3 melee (1d3+1 nonlethal, unarmed strike or 1d4, knife) or ranged +1 (1d8, velin hunting bow); FS 5 ft. by 5 ft.; Reach 5 ft.; AL tribe; SV Fort +8, Ref -1, Will +5; AP 0; Rep +1; Str 13, Dex 8, Con 18, Int 10, Wis 16, Cha 8.

Occupation: Hunter.

Skills: Hide +5, Move Silently +5, Ride +2, Speak English, Speak Velin, Spot +7, Survival +8.

Feats: Improved Damage Threshold, Archaic Weapon Proficiency, Simple Weapon Proficiency, Stealthy, Armor Proficiency (light), Track.

Possessions: velin hunting bow with 20 arrows, velin hunter armor, barter goods, knife, satchel, spear.



CHAPTER IV

GALACTIC SURVEY

Helios was a young man and lived in the veil of the west. His sister, Epanos¹, lived in the veil of the east. The man had a mysterious lover who used to come every month in the dark of the night to seduce him and lay with him on silent soil. She would come at night, and always made sure to leave before the break of dawn. Although he whispered to her, he could not see her face in the darkness of the night veil, and she refused to tell him her name, no matter how much he begged nor what he promised.

Love and curiosity are like twin heffen².

Helios decided on a ruse to find out the identity of his secret lover. The next time she came to lay with him, beneath the darkness of the night veil, Helios slyly rubbed his hands in the midnight loam. *"You are lovely as the song of the tacado³,"* Helios whispered as he rubbed his hands over her face. His lover moved to speak, and Helios was afraid that she would see through his ruse.

Quickly, he kissed her and did so until dawn, so she would not know that she had dirt on her face. As always, she left before the night did. The following night, Epanos arose from the eastern waters, and her face was covered in dirt as black as the midnight veil. Helios knew then that his mysterious lover was his sister. Epanos saw her face reflected in the waters below. She felt so ashamed that she tried to drown herself in the waters. Helios called to her and offered her a jewel⁴ to make her happy.

Epanos was still so ashamed to have her brother know the truth that she stayed as far away from him as she could, hiding at the far end of the night veil. Helios chases after so he might apologize for his ruse, and Epanos stays always ahead. Some nights, when he does come near to her in the east, she makes herself as thin as a ribbon so that she can hardly be seen.

*Myth of the Amantuk Tribe, translated by
Dr. Benjamin F. Huang.*

¹ The moon, Phaeton, in human nomenclature.

² Heffen is the velin name for the winecat, which are said to be unable to live peacefully under the same house.

³ Tacado is the velin name for the flamethrush, noted for its melodious song.

⁴ Believed to be a reference to the moon, Selene.

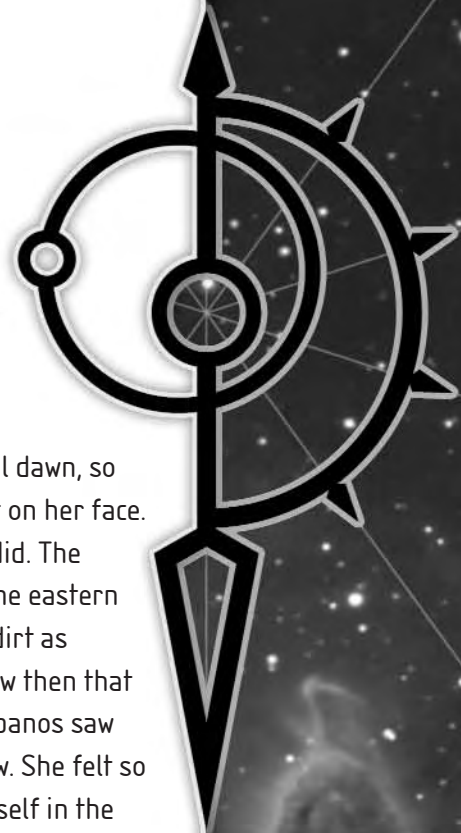

This chapter presents the most basic information about the system in which Eos is located. More detailed information about the system along with the other planets and their inhabitants will be introduced in *DAWNING STAR: HELIOS RISING*.

The colonists of Eos have dedicated little of their effort to areas beyond Eos, being more concerned with necessities—such as a breathable atmosphere and sustainable food supplies—than the events on other worlds. None of the other worlds in the Helios system have been explored, but they all have been subject to scrutiny from the *Sadler Orbital Facility*, using its advanced sensor array. The effort put into these operations has been minimal thus far but has grown in recent years, as the Eos Space Force plans to launch exploratory missions in the near future. These scans have also detected signs of intelligent inhabitants on the two closest planets, and occasionally spacecraft other than tentaari ships are detected in the system. It is readily apparent that the humans of Eos are not alone in the Helios system.

THE REST OF THE EVACUATION FLEET

The other nineteen evacuation ships of the fleet and their support craft are scattered across the galaxy in small groups. No more than two evacuation ships ended up in the same place. The fate of some of these ships will be dealt with in future *DAWNING STAR* supplements, including ideas for alternate campaigns. Not all of the ships will be detailed. Therefore, the sudden arrival of another evacuation ship is a viable campaign option.

Due to their limited mobility and technology, the settlers on Eos know much more about the planets closer to Eos than those on the far edge of the system. Also, they have virtually no information about neighboring stellar systems, having no equipment to gather such information at the present time. The

Helios system is in the middle of a large dust cloud, making astronomy difficult at the best of times, while viewing other stellar systems in detail is essentially impossible. The Eos Space Force hopes that eventually the tentaari can get their gateway network working again and the fleet can explore some of the neighboring systems. Until then the new inhabitants of Eos must remain close to Helios.

As far as the humans know, the other ships in the evacuation fleet are spread across the gateway network, and the tentaari have done and said nothing to discourage this conclusion. Both have little idea of their probable locations, though the humans hold out hope that some of the ships still survive and may possibly one day make it to Eos. Unfortunately, the gateway network extends for thousands of light years in every direction, so the number of possible locations is, well, astronomical. A formal search mission, most have concluded, would be sheer folly.

◆ THE HELIOS SYSTEM

A main sequence star of spectral type G0, Helios is slightly hotter and brighter than Sol. The star is at the midpoint of its life and is expected to have several billion years before it turns into a red giant, a process that will wipe out life in the stellar system. Helios is slightly more active than Sol in terms of solar flares and solar wind, and its solar flares regularly cause havoc with radio communications on Eos.

The Helios system is composed of eleven planets or the remains thereof and the tentaari gateway network entrypoint, located at the edge of the solar system. The sensors on the *Sadler Orbital Facility* have detected a large amount of debris in the system, which scientists speculate are asteroids from the Markin Belt that somehow broke orbit or, alternatively, pieces of some former planet that was destroyed.

The Helios system and the surrounding region of space are filled with dust and debris, making astronomical observation difficult. While the dust is not dangerous, it does impede surveys of nearby stars, further limiting the ability of the humans of Eos to determine their location in the galaxy.

Various other features of the system are described below.

Markin Belt

Rotation Period: N/A

Revolution Period: 67 Eotian days

Atmospheric Composition: None

Average Temperature: 430 Kelvin (314.6° F)

The Markin belt is a small belt of asteroids in close orbit around Helios. It is thought to have been created by an extra-stellar planetoid that entered the system, was caught by Helios's gravity, and eventually was destroyed when it came too close to Helios. The asteroid field is scattered about Helios in a ring formation, though it is at a 30-degree angle to the orbital plane of the rest of the stellar system. Most of the asteroids of the Markin Belt are several kilometers in size, and they are normally found in clumps with a single large asteroid surrounded by smaller ones. The amount of material in the Markin Belt suggests the planet that was destroyed in its creation was roughly one-fifth the size of Eos. The Eos Space Force has little interest in the Markin Belt due to its high temperature and lack of atmosphere, but some scientists suspect there may be valuable resources to be mined in the belt.

Hephaestus

Rotation Period: 16 hours

Revolution Period: 145 Eotian days

Atmospheric Composition: None

Average Temperature: 390 Kelvin (242.6° F)

A barren world with all semblance of an atmosphere burned off due to its proximity to Helios, Hephaestus is the closest planet to Helios that has not been destroyed by Helios's gravity. While it is cooler than the asteroids of the Markin Belt, it is not a planet that could be easily colonized even on a small scale. Sensor readings indicate Hephaestus is a very iron-rich planet, and the Dawning Star Republic hopes that with advances in technology it may be possible to mine Hephaestus, if the iron deposits on Eos ever begin to run out.

Verdant

Rotation Period: 19 hours

Revolution Period: 189 Eotian days

Atmospheric Composition: Nitrogen, carbon dioxide, hydrogen sulfide

Average Temperature: 420 Kelvin (788° F)

From Eos, Verdant appears to be a glowing green star, and it is commonly used by the velin as a navigational aid. In actuality, Verdant is a planet with a very thick, highly reflective atmosphere that traps a large amount of heat, creating a greatly magnified greenhouse effect. Verdant is a very hot world of acidic lakes and cloud-covered mountains that seems completely inhospitable to habitation. Despite these hurdles, scans have shown some orbital facilities above the planet. These facilities do not appear to be active, and their purpose is

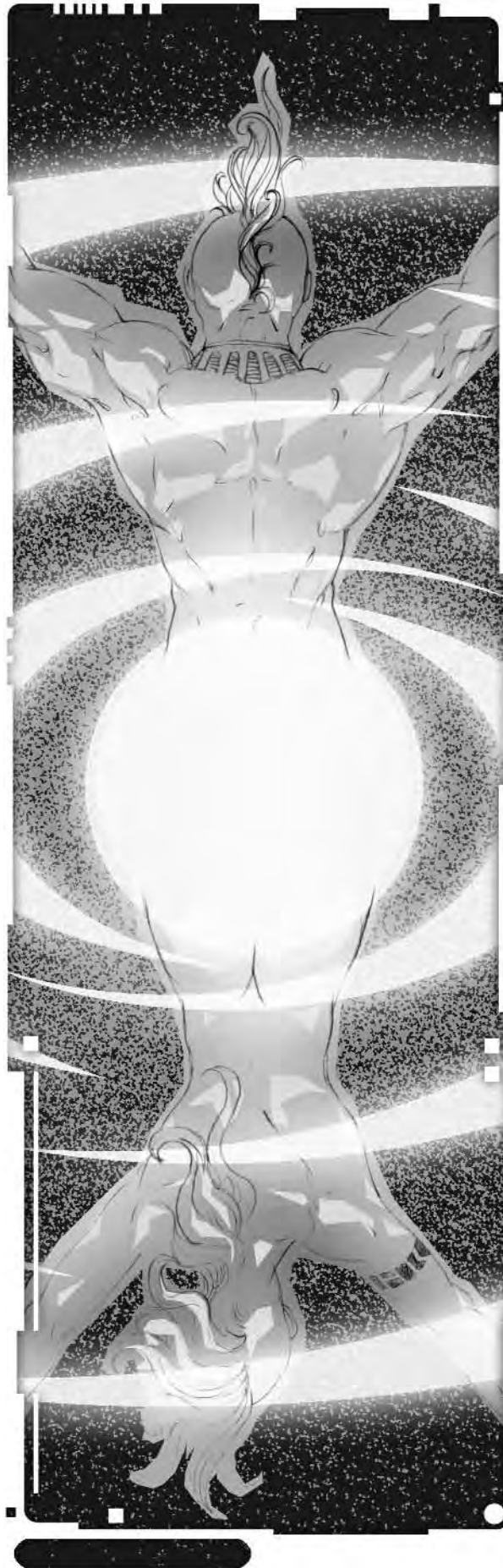

HELIOS SOLAR SYSTEM

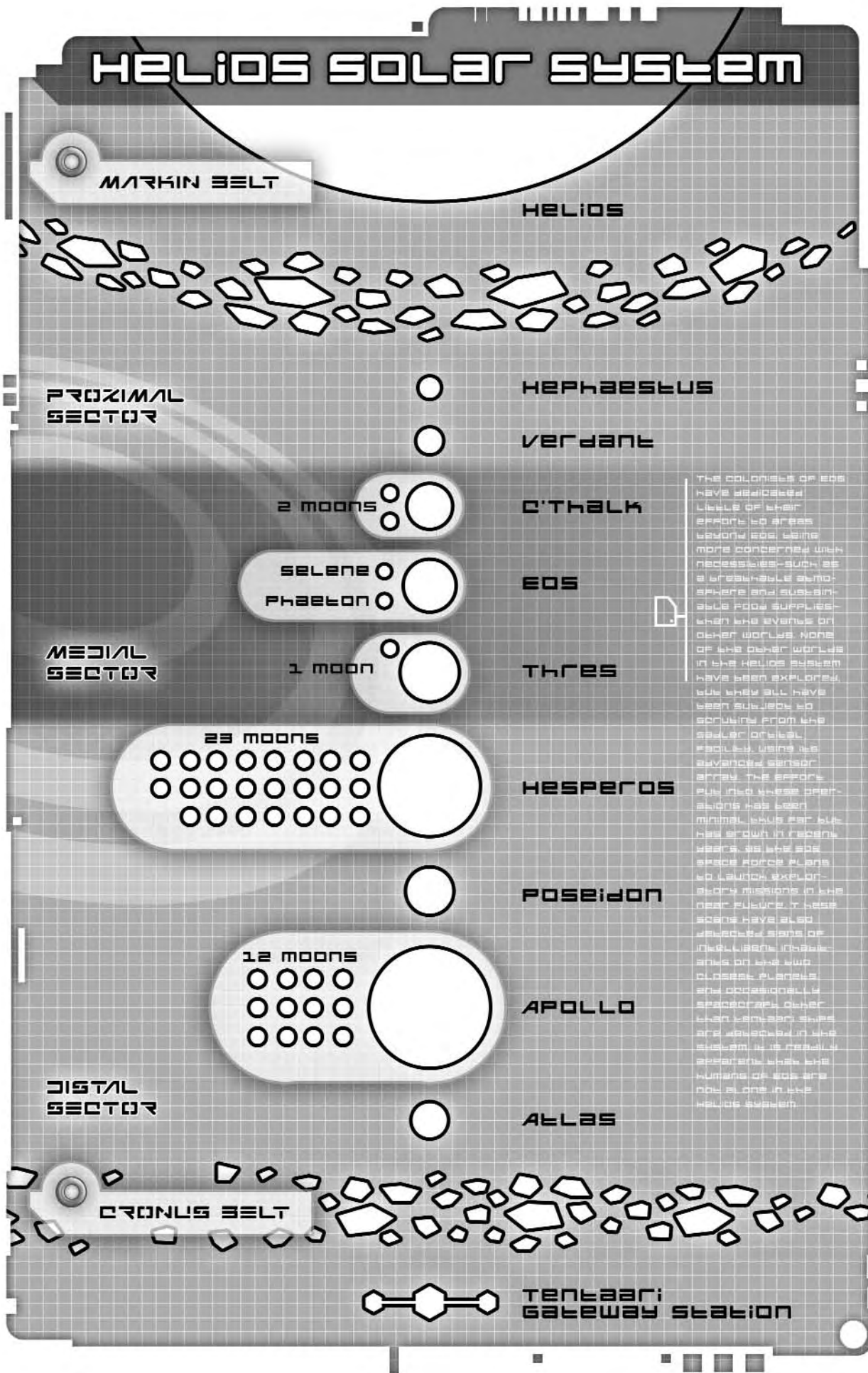

presently unknown. Because its surface is far too hostile to visit, Verdant currently holds no interest for the humans of Eos.

C'thalk

Rotation Period: 26 hours

Revolution Period: 345 Eotian days

Atmospheric Composition: Nitrogen, oxygen

Average Temperature: 285 Kelvin (53.6° F)

One of Eos's inhabitable neighbors, this planet is always covered in a thick, moisture-rich cloud layer, making observations of the surface difficult. What is known is that the world has lush ground vegetation and few large bodies of water. Instead, C'thalk is dotted with hundreds of lakes, each several miles across. The *Sadler Orbital Facility* regularly detects spacecraft in the vicinity of C'thalk, leading to the assumption that it is inhabited and that the residents are of a technological level similar to the Republic. There have been glimpses of large city settlements on the surface, but there is some disagreement on whether these are active settlements or just ruins like those found on Eos. The name C'thalk comes from the velin name for the world, which they claim is inhabited by a fearsome race of reptilian warriors. Given the designs of some of the crashed spacecraft on Eos and ancient remains found among them, many scientists think this story is more fact than mythology. This also raises the question of how the velin know about other worlds when they have no technology required to travel to them.

C'thalk has two moons, both of which are barren rocks that do not have any sort of settlements.

Eos

Rotation Period: 25 hours

Revolution Period: 351 Eotian days

Atmospheric Composition: Nitrogen, oxygen

Average Temperature: 279 Kelvin (42.0° F)

The new home of humanity, after 30 years of terraforming, Eos is a slightly drier and colder duplicate of Earth in terms of atmosphere. The most suitable world for human habitation in the system, the selection of Eos by the crew of the *Dawning Star* was largely a matter of luck: When the *Dawning Star* arrived in the system, the orbit of Eos brought it closer to the *Dawning Star* than either C'thalk or Thres. In the years since, this chance occurrence has proven to be a boon to the colonists, as Eos has become an excellent home for them.

Eos has two moons called Phaeton and Selene by the colonists. The velin refer to the former as **Specter** (that is, the velin word for specter) because its surface reflects very little light, making it difficult to see during cloudy nights. Often, the best way to find it is to simply look for the section of the night sky where the stars are blotted out. The velin legends speak of a great evil that assaulted

Eos from Phaeton long ago and stained the moon black to hide their evil from those on Eos. Selene on the other hand is a small moon that, at one point, seems to have been a terraforming project. There are several large structures in the planet similar to the ruins of Eos, and the moon has a very thin atmosphere. However, it is too cold and lacks a sufficient atmosphere to support life. There are several icesteroids on the surface of Selene. It is believed that they were intentionally loosed onto the planet as part of a terraforming effort, but these icesteroids never melted.

Thres

Rotation Period: 32 hours

Revolution Period: 380 Eotian days

Atmospheric Composition: Nitrogen, oxygen

Average Temperature: 276 Kelvin (37.4° F)

Eos's other habitable neighbor, Thres is slightly colder than Eos, and a large part of it is dominated by glaciers and snow. The central regions are primarily grasslands and forests, all of which seem very lush. Thres has several large oceans, and over 75 percent of the world's surface is covered in water. Huge storms are common on the planet, and its tidal forces are immensely powerful; the difference between low and high tide is measured in miles in most regions. This phenomenon is thought to be mainly due to Thres's single moon, which is in a remarkably close orbit to the planet. This moon has a very thin atmosphere, which some think it has stolen from Thres over time due to its proximity. Regardless, the moon is not capable of supporting life.

While there have been no signs of large scale civilization on Thres, several smaller settlements have been discovered on the surface, and several spacecraft have been detected traveling from C'thalk to Thres and vice-versa. Like C'thalk, Thres is the name the velin gave the world, which they claim is only inhabited by ghosts of some ancient race of beings. Unlike C'thalk, the velin seem to have no legends concerning the current inhabitants of Thres, assuming there are any.

Hesperos

Rotation Period: 35 hours

Revolution Period: 598 Eotian days

Atmospheric Composition: Hydrogen, helium, methane, water vapor

Average Temperature: 281 Kelvin (46.0° F)

A gas giant of immense size, Hesperos is slightly larger than Jupiter in the Sol system and has a diameter thirteen times that of Eos. The upper atmosphere of Hesperos is characterized by heavy clouds, powerful winds blowing at hundreds of miles an hour, and occasional storms covering thousands of square miles. There has been no in-depth study of the lower levels of Hesperos, but it is theorized that its core is liquid hydrogen, forced into

liquid state by the immense pressure of the atmosphere above. No life has been detected on Hesperos itself, though there appear to be some large, solid objects in its upper atmosphere that are assumed to be space stations of some sort.

Hesperos has 23 moons, most of which are airless rocks the planet captured as they passed through the stellar system. Two of these are of particular interest to the scientists of Eos. On the first of these two moons, something has been broadcasting radio signals in some form of code for the last ten years, but the code has not been successfully translated into any meaningful language. This moon also has a habitable atmosphere. Some scientists believe the world is inhabited, while others theorize that the signal is an automated beacon left over from the original inhabitants of the system. The second moon of interest, in addition to having a breathable atmosphere, has its own satellite, a large chunk of metal and stone that appears to change its orbit from time to time, leading many to believe it is a space station of some type. This new satellite only appeared a few decades ago, leading some to believe it is not a space station but an interstellar craft of sorts. The Eos Space Force eagerly hopes to visit both these moons after reaching Thres and C'thalk.

Poseidon

Rotation Period: 23 hours
Revolution Period: 605 Eotian days
Atmospheric Composition: Nitrogen, oxygen
Average Temperature: 245 Kelvin (-18.0° F)

The surface of Poseidon is covered in a layer of ice thought to be several miles thick, below which there is believed to be an ocean of water. The presence of water in vast quantities leads many scientists on Eos to speculate that life may exist on Poseidon below the ice, but thus far no signs of habitation or space travel have been detected on the world.

Apollo

Rotation Period: 12 hours
Revolution Period: 980 Eotian days
Atmospheric Composition: Hydrogen, helium
Average Temperature: 460 Kelvin (368.0° F)

A gas giant like Hesperos, Apollo is both larger and denser than Hesperos. It is less active in terms of winds and storms, but it has an unusual feature. Apollo is a surprisingly luminous object, giving off more energy than it takes in, something that normally only occurs in stars. The exact nature of this process is uncertain, but the planet does provide a steady light source to its twelve moons and the nearby worlds. The planet has several space sta-

tions in high orbit above it, leading some scientists to speculate that the space stations were part of an effort to change the planet into a small second sun to make the outer planets of the system habitable. The full measure of this process is, at present, completely unknown. The great distance between Eos and Apollo makes gathering more information very difficult.

Atlas

Rotation Period: 22 hours
Revolution Period: 1067 Eotian days
Atmospheric Composition: None
Average Temperature: 120 Kelvin (-243.4° F)

A barren world with no atmosphere to speak of, the *Sadler Orbital Facility* regularly detects strange bursts of intense radiation originating from its surface. Whether this is a sign of habitation or simply a natural phenomena remains to be seen.

Cronus Belt

Rotation Period: N/A
Revolution Period: 1245 Eotian days
Atmospheric Composition: None
Average Temperature: 90 Kelvin (-297.4° F)

The outer asteroid belt of the Helios system, its origin is unknown, but it is thought to be the product of a planetary collision or random debris collected by the system over time. The asteroids in the belt seem to have little mineral value, but an in-depth study of their composition has thus far been impossible. The most interesting fact about the asteroid field is a series of strange short-lived energy signatures detected on certain asteroids and a number of garbled radio transmissions that seem to be originating from the Cronus Belt in the last few years.

The Tentaari Gateway Station

Rotation Period: N/A
Revolution Period: N/A
Atmospheric Composition: Unknown
Average Temperature: Unknown

Several kilometers across and roughly elliptical in shape, the tentaari gateway station is almost a complete mystery to the scientists of Eos. The tentaari have shared hardly any information about it with the humans, and the sensors of the *Sadler Orbital Facility* have gleaned little. From what the tentaari have said, it is not currently functional, but all offers of assisting in its repair have been turned down. Gaining access to the tentaari gateway system is something the Eos Space Force wishes it could achieve, but fears making enemies of the tentaari in the process and is currently content to pursue access to the station through diplomatic channels.

XENOMORPHS

It had been a long day. Don Rosso and his crew had covered 50 miles of grass and desert, all the while keeping a thousand murcows from wandering off, getting killed by Dawson dragons, or falling prey to rustlers. In three days time, they would be in Dawning Star with money to spare from selling this year's herd. He could get a bath, sleep in a real bed, and maybe even take in a show. For now though, he was happy with hard dirt and a thin foam pad beneath him and a restful night under the stars ahead of him.

"Don."

Or not.

"Don," the voice repeated, laced this time with more insistence.

Groaning more than necessary, Don sat up in his bedroll, looking over at his ranch-hand, Pelleq. The velin stood with his back to the fire looking out into the moonless night, scanning for something beyond the orange glow. Don had hired Pelleq for his nigh-unnatural rapport with murcows, but that meant he also had to put up with Pelleq's occasional bouts of mystic mumbo jumbo.

"Pelleq, I'm in bed. My hat and boots are off. What do you think this means? Maybe that I'm trying to sleep?" Sarcasm was often lost on the velin, and had he been more alert, Don might not have bothered with it.

Pelleq ignored the man's words, crouched down, and pulled a bow and quiver from the saddle at his feet. His gaze did not veer from some point in the darkness on the edge of camp.

"Something comes. We need to arm ourselves." He spoke darn good English for a velin.

Don crawled out of his bedroll and reached for his gun belt. As he moved, he noticed hidden, just on the edge of the camp, a dozen more velin, all outfitted for war with spears, blades, and armor. They all looked in the same direction as Pelleq. They'd snuck not ten feet from him without so much as a whisper of a noise. The edges of Don's mouth turned down in a grimace. He half-expected the group to break out into some crazy war dance.

"Friends of yours?" Don asked. "Out lookin' for Dawson dragons?" Don strapped on his gun belt and started putting his boots on, careful to shake them out for sting cruppers beforehand.

"No," Pelleq replied, still looking into the darkness. "Vaasi."

"Vaasi? As in darklings?" Don sighed and rolled his eyes. He started pulling his boots off. "Sorry, I don't get out of bed for the bogeyman, Shadow Jack, or vaasi. Nothing personal, Pelleq, it's just—"

Reacting to something in the darkness, Pelleq quickly fired off his bow, a movement the other velin carried out with equal speed. Half a beat later, a black insectoid creature, easily the size of a man, stumbled on its six legs and fell into the light of the fire, riddled with arrows and bleeding a viscous, yellow liquid.

Pelleq said something to Don, but the human couldn't hear him over the war cries of his brothers.

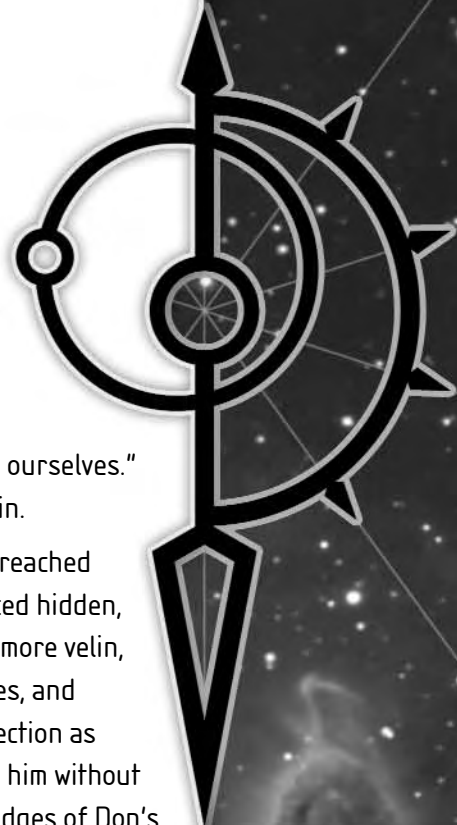

Eos is a world of wondrous variety much like Earth, and the xenobiologists of Dawning Star have only just begun to catalog the hundreds of thousands of species that call it home. Only the regions closest to Dawning Star have been heavily studied, leaving vast areas of the planet where only the most cursory orbital scans have been carried out. The xenobiologists work constantly to expand their knowledge of the creatures of Eos. Often, they work with the velin, who have a great deal of knowledge of the planet's life forms. Sometimes, they post bounties for specimens of previously undiscovered creatures. This practice has led to groups of hunters traveling across the planet looking for new species, some of whom work in concert with the velin to return them alive to Dawning Star. These hunters are usually professional soldiers or outdoorsmen and undertake these missions with the equipment and know-how to get the job done, but not all on Eos are so prepared.

Many creatures on Eos are dangerous to humans, and more than a handful seem to have developed a taste for human flesh. These dangerous creatures can be found in most wilderness areas including within a few miles of Dawning Star itself, though they are more common in outlying areas. Such creatures are a constant threat to ranchers, their herds, farmers, and

others who live away from population centers. Wild Dawson dragons are a common threat in the area surrounding Dawning Star, while sloth roaches and swamp hulks inhabit the Southern Resource Zone. The velin are adept at avoiding most of the more dangerous life forms on the planet, which is principally due to the fear and respect they have for them. Of all the creatures on Eos, the velin fear nothing more than darklings, which they call "vaasi," something that causes the humans nothing but amusement. Everyone knows the darklings are a local legend.

This chapter presents a handful of the known xenomorphs on Eos along with the vaasi and their servitor races. In addition to the xenomorphs presented in this chapter, many creatures from other sources, such as **D20 MODERN** and the Future SRD, can be incorporated into the setting. When adding creatures from other sources, keep in mind the following guidelines: **1** There should be no intelligent races native to Eos; **2** there should be no "inappropriate" creature types like undead and outsiders; **3** there may be animals that are alien and still very similar to terran animals; **4** there may be terran animals that have been introduced into the environment from the creature tanks. **DAWNING STAR: HELIOS RISING** will introduce more xenomorphs from other locations in the system.

EOTIAN WILDLIFE • • •

Many of the creatures native to Eos, despite their inherent alien qualities, are eerily similar to terran animals. This phenomenon is exacerbated by the human tendency to name the xenomorphs based upon their terran counterparts. This similarity is more than sheer happenstance. Although xenobiological studies are still in their infancy, the earliest reports show a genetic commonality in addition to the surface similarities. Scientists are simultaneously concerned and befuddled by this discovery.

◆ DAWSON DRAGON

Dawson dragons earned their name from Simon Dawson, the first colonist to be killed by one of the large beasts. He was killed quite gruesomely in 2213, while escorting a group of terraformers around the Eastern Resource Zone. For several years afterward, the Dawson dragons were hunted extensively in the region around Dawning Star, reducing their population dramatically. In 2230 it was learned that the Dawson dragons possessed intelligence on par with a terran horse and that they could be domesticated. This discovery was made

by a rancher named Brian Sayers who captured an immature Dawson dragon and raised it to follow commands and carry a rider. Since then, Dawson dragons have become a regular part of the ranching business. Indeed, they have become the most common type of mount on Eos due to the shortage of terran horses and fact that many ranchers see riding murcows as being undignified.

The genetic makeup of the Dawson dragon is very similar to several terran reptiles, including the Komodo dragon. This discovery has led researchers to speculate that the theorized connection between Earth and Eos—evidenced by the link between the velin and humans—may apply to other species as well. Still, there are significant differences between terran reptiles and Dawson dragons. For example, Dawson dragons have some ability to regulate their internal temperature instead of being purely cold-blooded. This quality allows the Dawson dragons to roam a wide area of Eos; however, they stay mainly on the plains and deserts of the equatorial region.

Dawson dragons average twelve feet from snout to tail and weigh some 2,500 pounds. It has cool,

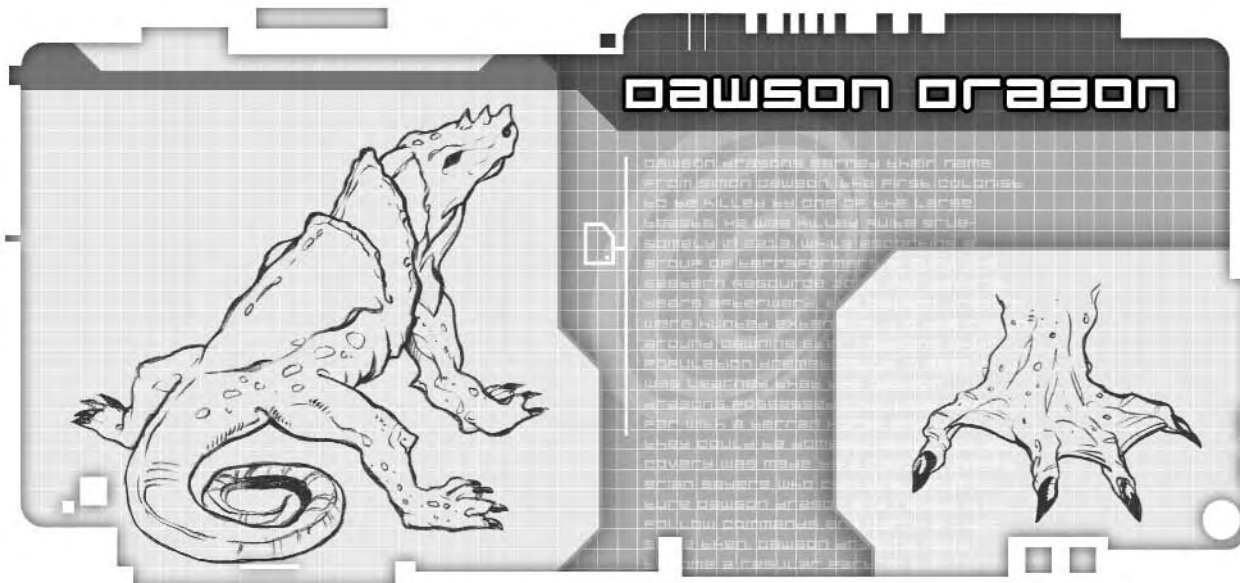

rubbery skin with small bumps lining its spine that some scientists theorize are vestigial fins. Its coloration ranges from a subtle pattern of blues and greens on its back to a pale, yellowish-green on its underbelly. The Dawson dragon travels on all four of its feet but can rear back and attack with its front claws if angered.

Raising Dawson dragons for use as mounts has become a large sub-sector of the ranching industry, and there are a half-dozen dragon ranches in the regions around Dawning Star. There are also a few in the faction-camps, and these more distant camps are earning a reputation as the preeminent breeders of Dawson dragons due to their inclusion of wild dragons in their breeding pools. A trained adult Dawson Dragon has a purchase DC of 24, though this number may vary for particularly well trained or hardy specimens.

Species Traits

Improved Grab (Ex): To use this ability, a Dawson dragon must hit an opponent of its size or smaller with its bite attack. If successful, the Dawson dragon grabs the target in its jaws and continues to gnaw on it until dead, inflicting bite damage each round the target remains grappled. See D20 MODERN.

Scent (Ex): This ability allows a Dawson dragon to detect approaching enemies, sniff out hidden foes, and track by sense of smell. See D20 MODERN.

Tail Slap (Ex): Dawson dragons do not usually use their tails in combat, but if they get annoyed with their rider they will try to slap the rider with it. If a rider fails a Ride check by 5 or more, the dragon will attempt to slap its tail at him, requiring a Reflex save (DC 17) to avoid being hit. On a failed save, the rider takes 1d4 points of bludgeoning damage and must make

another Ride check (DC 17) to avoid being thrown. Using a Dawson dragon harness prevents the rider from being struck by a tail slap.

Skill Bonus: A Dawson dragon receives a +10 species bonus to Jump checks.

Dawson Dragon ♦ CR 4

Large animal; HD 8d8+32; hp 68; MAS 18; Init +1; Spd 50 ft.; Defense 18, touch 10, flat-footed 17 (+1 Dex, +8 natural, -1 size); BAB +6; Grap +14; Atk +9 melee (1d8+4, bite); Full Atk +9 melee (1d8+4, bite) and +4 melee (1d6+2, 2 claws); FS 10 ft. by 10 ft.; Reach 10 ft.; SQ improved grab, scent, tail slap; AL none; SV Fort +10, Ref +7, Will +3; AP 0; Rep +0; Str 19, Dex 12, Con 18, Int 2, Wis 12, Cha 4.

Skills: Jump +17, Spot +4, Survival +6.

Feats: None.

Advancement: 9-12 HD (Large).

♦ DELHI BEACON

Caught by fishermen off the coast of Delhi these 5-foot-long, large-mouthed fish have become a staple in the diet of many on the new continent. Similar to carp, the Delhi beacon is a strange fish in many ways. Its name is derived from the 10-inch-long spear-like protrusion jutting forward from between its two, wide-set eyes. This protrusion has a luminescent glow that attracts smaller fish, which it spears or swallows whole. Decorating their otherwise pearlescent bodies is an azure stripe leading from tail to tip. During one experiment, when the stripe and protrusion glowed, the remainder of its body temporarily turned translucent.

The spear glows thanks to luminescent bacteria growing inside. The Delhi beacon also produces an electric charge, which it uses to stun its prey, which it then swallows. Larger life forms don't have to worry about being vacuumed into the beacon's gul-

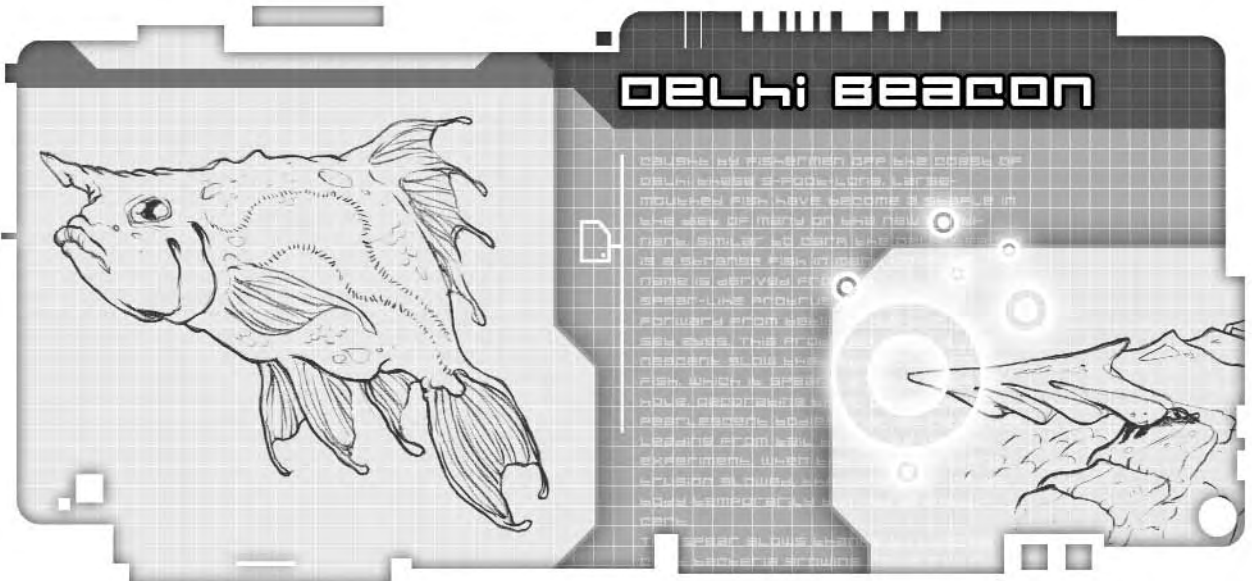

let, but they are still susceptible to being paralyzed, which can result in drowning.

The citizens of Delhi have since learned to clean the bacteria from the fish, yielding a luminescent substance for commercial applications and edible flesh. Cured beacon is common in markets. Full-grown beacons have been known to weigh in at 250 lbs.

Species Traits

Aquatic (Ex): Delhi beacons can move in water without making Swim checks and cannot drown in water.

Electricity Resistance (Ex): Beacons have electricity resistance 10.

Shocking Spear (Ex): The beacon can produce an electric shock once every 1d4 rounds. Anyone within a 5-ft. radius of the beacon is subject to the effect, which causes paralysis for 1d6 minutes. An opponent succeeding at a Fortitude save (DC 13) is unaffected. Delhi beacons are immune to their own shock and the shocks of other beacons. This ability is a free action that does not provoke an attack of opportunity.

Delhi Beacon ♦ CR 2

Medium animal; HD 3d8+6; hp 19; Mas 14; Init +4; Spd swim 60 ft.; Defense 16, touch 14, flat-footed 12 (+4 Dex, +2 natural); BAB +2; Grap +3; Atk +3 melee (1d6+1, spear); Full Atk +3 melee (1d6+1, spear); FS 5 ft. by 5 ft.; Reach 5 ft.; SQ aquatic, electricity resistance, low-light vision, shocking spear; AL none; SV Fort +5, Ref +7, Will +2; AP 0; Rep +0; Str 12, Dex 18, Con 14, Int 1, Wis 12, Cha 2.

Skills: Listen +6, Spot +6, Swim +9.

Feats: None.

Advancement: 4-6 HD (Medium), 7 HD (Large).

♦ IRON SCAR CHARGER

Rarely seen during the day, these predators spend most of their time in the upper reaches of the mountains around Iron Scar, coming down at night to hunt. These mammals appear to be something of a cross between a jackrabbit and a ram. They have strong-muscled bodies with white and khaki fur, heavy necks. Curved horns adorn the heads of these carnivores, who favor a ramming attack to stun opponents or knock them down. They also attack with their front claws and regularly tackle creatures larger than themselves; in fact, their disposition has been compared to that of the terran wolverine. Chargers are notoriously mean despite their small size and will attack anything they consider a threat or a meal, which includes just about any creature that is less than five times their size. Weighing in at 60 lbs., these animals can reach three-and-a-half feet in length, from nose to bobbed tail.

Chargers are often encountered in mated pairs, sometimes with a litter of young. Mating season is most likely year round though no in-depth study has confirmed this. Litters usually consist of four or five young. Their diet consists of rodents, reptiles, and larger prey, which they stalk under cover of darkness. Chargers have started to realize that men are dangerous foes, and they have started avoiding humans when possible. They always avoid enemy groups but will stand fast if a mate or pup is threatened. They are skilled at scaling mountains and enjoy perching in trees as well.

The meat of the charger isn't as tasty as murcow, but so far no humans have had the adverse reaction some have had with the herd animal. Their pelt is sometimes used for clothing, but hunting has been restricted until a more thorough ecological study can be done.

IRON SCAR CHARGER



Species Traits

Adept Climber (Ex): While in mountainous terrain, chargers may move at their full speed when making Climb checks and use their Dexterity bonus instead of their Strength bonus. Additionally, they need not move in a straight line while attempting a charge in such terrain. Chargers get a +8 racial bonus to Climb checks.

Burst of speed (Ex): Chargers are capable of attaining high speeds for short periods of time. Twice per day, a charger may take an extra move action. This ability cannot be used on consecutive turns.

Stunning Charge (Ex): When first attacking their prey, chargers prefer to butt the target with their large, ram-like horns. If it succeeds on a charge attack, the target must make a Fortitude save (DC 14) or be knocked prone and stunned for one round.

Trip (Ex): A charger that hits with a claw attack can attempt to trip its opponent as a free action without making a touch attack or provoking an attack of opportunity. If the attempt fails, the opponent cannot react to trip the charger.

Bonus Feat: Chargers receive Weapon Finesse (butt) as a bonus feat.

Iron Scar Charger ♦ CR 3

Small animal; HD 4d8+8; hp 26; MAS 15; Init +4; Spd. 50 ft., climb 20ft.; Defense 16, touch 15, flat-footed 12 (+1 size, +4 Dex, +1 natural); BAB +3; Grap +1; Atk +8 melee (butt 1d4+2); Full Atk +8 melee (butt 1d4+2) and +1 melee (1d3+1, 2 claws); FS 5 ft. by 5 ft.; Reach 5 ft.; SQ adept climber, burst of speed, low-light vision, stunning charge, trip; AL none; SV Fort +6, Ref +8, Will +2; AP 0; Rep +0; Str 14, Dex 19, Con 15, Int 2, Wis 12, Cha 6.

Skills: Climb +14, Spot +5, Hide +6, Move Silently +6, Listen +5.

Feats: Weapon Finesse (butt).

Advancement: 5-6 HD (Small).

♦ IRON SCAR SCRAPER

This animal is native to the Iron Scar mountain area and has become a favorite animal of the miners of Iron Scar due to its strength and determination. In fact, the Iron Scar baseball team takes its name from the creature. The Scraper itself got its name for its habit of cleaning its armor plates against large rocks and trees, leaving behind long gouges.

Scrapers average nine feet in length and top six feet at the shoulder. These quadruped herbivores have scalloped armored plates covering their backs. Their long-necked heads are crowned with a tremendous rack of antler-like bone spikes, with males generally having larger sets. An elongated proboscis helps them forage leaves and grass. Thick legs and strong padded hooves support their weight, in excess of 4,000 lbs.

Scrapers are usually found in families of four to seven, and their territory is easy to identify thanks to the scratch marks they leave on trees and whatever else may be present. Scrapers rub their armored plates against large rocks, tress, or even the antlers of other scrapers. This behavior is thought to provide three benefits: cleaning parasites and debris from between the plates, honing and grooming their antlers, and molting worn plates. Additionally, the practice provides an environmental benefit by clearing dead bark from trees. Scrapers are very social beasts, and while most families range in small groups, they occasionally come together in herds of over a hundred.

Xenobiologists theorize that the Iron Scar scrapers developed their armor and antlers as a direct counter to the ferocious chargers. Scrapers prefer

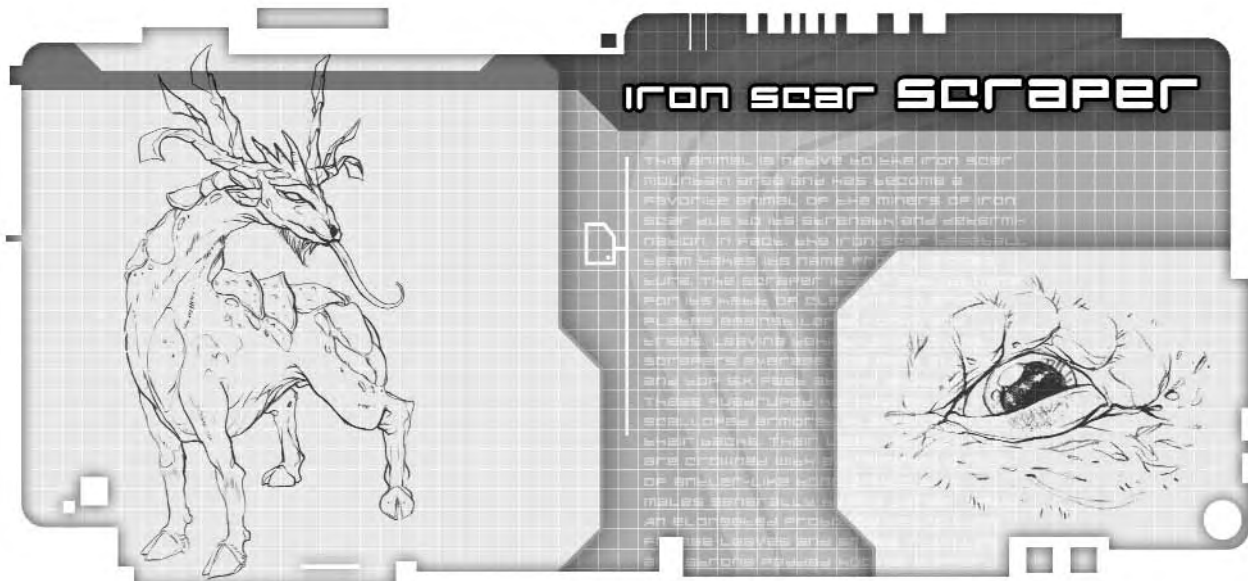

sunny days, as their plates collect heat to keep them warm during the night. Some rugged types have fashioned crude weapons from their antlers, but scraper meat is generally considered not worth the effort.

Species Traits

Antlers (Ex): In addition to using their antlers to gore opponents, scrapers use them to gain leverage. Scrapers get a +4 racial bonus to grapple checks. Additionally, their antlers have a critical of 20/x3.

Dampening Plates (Ex): The thick plates covering their bodies help resist damage and absorb the force of blows, such as those from the Iron Scar charger. Scrapers have damage reduction 2/- against attacks that deal bludgeoning damage. Additionally, the scraper enjoys a +4 racial bonus to saving throws against any special effects caused by concussive force—such as the stunning charge of the Iron Scar charger.

Iron Scar Scraper ♦ CR 3

Large animal; HD 8d8+32; hp 68; MAS 18; Init +3; Spd 30 ft.; Defense 19, touch 12, flat-footed 16 (+3 Dex, +7 natural, -1 size); BAB +6; Grap +18; Atk +9 melee (2d8+6, gore); Full Atk +9 melee (2d8+6, gore); FS 10 ft. by 10 ft.; Reach 10 ft.; SQ antlers, dampening plates, low-light vision; AL none; SV Fort +10, Ref +9, Will +3; AP 0; Rep +0; Str 18, Dex 16, Con 18, Int 2, Wis 12, Cha 5.

Skills: Listen +9, Spot +6.

Advancement: 9-12 HD (Large).

♦ MURCOW

The first native species on Eos raised for human consumption, the murcow has become a staple of

the colonial diet and economy. Murcows are valuable both for their meat and their leather like-hides, which are commonly used in clothing, armor, and numerous other applications. It surprised no one to discover that the murcow's genetic make-up most resembles the terran cow. There are tens of thousands of murcows in herds owned and protected by ranchers both in the Dawning Star Republic and the faction-camps. While murcows are not dangerous, they are easily spooked, and an ensuing stampede will not stop until the beasts tire themselves out.

Murcow herds usually consist of four- to five-hundred murcows, with two to six ranchers watching over them, but the biggest operations have ten times that many beasts and men. Different breeds of murcows have begun to appear, such as Southern Stout and Northern Prime, each part of a special breeding and feeding program to create a specific flavor and consistency of meat. Most ranchers brand their murcows to keep track of them and prevent poaching, but some have begun using tracking collars or implants.

While murcows do not have the speed of the Dawson dragons, they make suitable mounts for most purposes. They can walk all day and have a friendly disposition that makes them easy to ride. While most ranchers ride Dawson dragons, some velin use murcows to avoid the complications arising from the murcow's innate fear of the dragons.

The purchase DC of a murcow is normally 12, but this varies according the breed and health of the animal. A trained riding murcow has a purchase DC of 14.

Species Traits

Good Nature (Ex): Anyone working with a murcow enjoys a +2 circumstance bonus to Handle Animal and Ride checks.

Stampede (Ex): A frightened herd flees as a group in a random direction, but always away

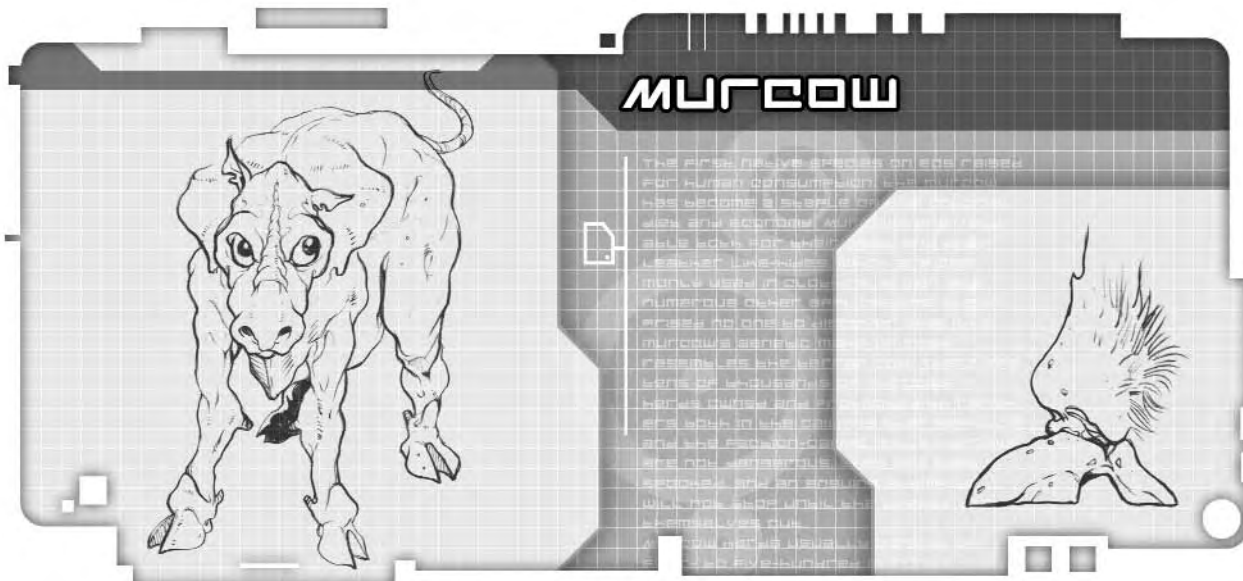

from the perceived source of danger. It runs over anything of Large size or smaller that gets in its way, dealing 1d12 points of damage for every five animals in the herd. A successful Reflex save (DC 14) halves the damage.

Bonus Feat: Murcows gain the bonus feat Improved Damage Threshold.

Murcow ♦ CR 2

Large animal; HD 7d8+14; hp 45; MAS 18; Init +0; Spd 40 ft.; Defense 15, touch 9, flat-footed 15 (+6 natural, -1 size); BAB +5; Grap +10; Atk +5 melee (1d4+1, bite); Full Atk +5 melee (1d4+1, bite); FS 10 ft. by 10 ft.; Reach 5 ft.; SQ good nature, stampede; AL none; SV Fort +7, Ref +5, Will +3; AP 0; Rep +0; Str 13, Dex 10, Con 15, Int 2, Wis 12, Cha 5.

Skills: Climb +2, Listen +6, Spot +5.

Feats: Improved Damage Threshold.

Advancement: 5-8 HD (Large).

♦ SAP TRAP

Many types of flora dot the surface of Eos, but sap traps are one of the more interesting specimens due to their hunting technique and preferred diet. Sap traps have primarily yellow and green coloration on their leaves and vines. Their chief feature is a central blossom, up to eight feet in diameter, shaped like a terran hyacinth. The blossom contains a shallow pool of scented viscous liquid. Spiny tendrils splay out from the blossom, which it uses to drag nearby creatures into its blossom. Opponents who suffer this fate risk becoming stuck and being digested over time. The blossom is in fact, a perennial, a permanent fixture that does not wither even in the colder months.

Some velin tribes harvest the plant's sap for use as a weapon and in crafts.

Species Traits

Digestive Sap (Ex): In the sap trap's blossom is a pool of sticky, smelly sap. Any creature of Medium size or smaller, who finds themselves within the blossom, must make a Strength check (DC 17) to break free. While stuck, creatures are considered prone, entangled, and unable to move. Creatures stuck in the sap take 1d4 points of acid damage each round.

Plant Traits: Sap Traps are immune to poison, paralysis, and stunning. They are not subject to critical hits, have no weapon proficiencies, and do not need to sleep.

Spiked Tendrils (Ex): The ground around the blossom is covered with spiky vines. These tendrils extend out from the blossom 20 feet. The sap trap may attack with up to four tendrils each round and no more than two against a single opponent. On a successful hit against an opponent of Medium size or smaller, the sap trap can start a grapple as a free action without provoking an attack of opportunity. The sap trap may move any opponent it has successfully grappled up to 10 ft. with another successful grapple check. The sap trap may continue to attack with up to four tendrils per round even while it is grappling with its other tendrils. Each additional tendril that is used to grapple an opponent grants a +2 bonus to the grapple check.

Tremorsense (Ex): Sap Traps automatically sense the movement of anything within 30 feet that is in contact with it or the ground.

Sap Trap ♦ CR 2

Large plant; HD 4d8+12; hp 30; MAS 16; Init -1; Spd 0 ft.; Defense 10, touch 8, flat-footed 11 (-1 Dex, +2 natural, -1 size); BAB +3; Grap +12; Atk +7 melee (1d4+5, tendril); Full Atk +7 melee (1d4+5, 4 tendrils); FS 10 ft. by 10 ft.; Reach 10

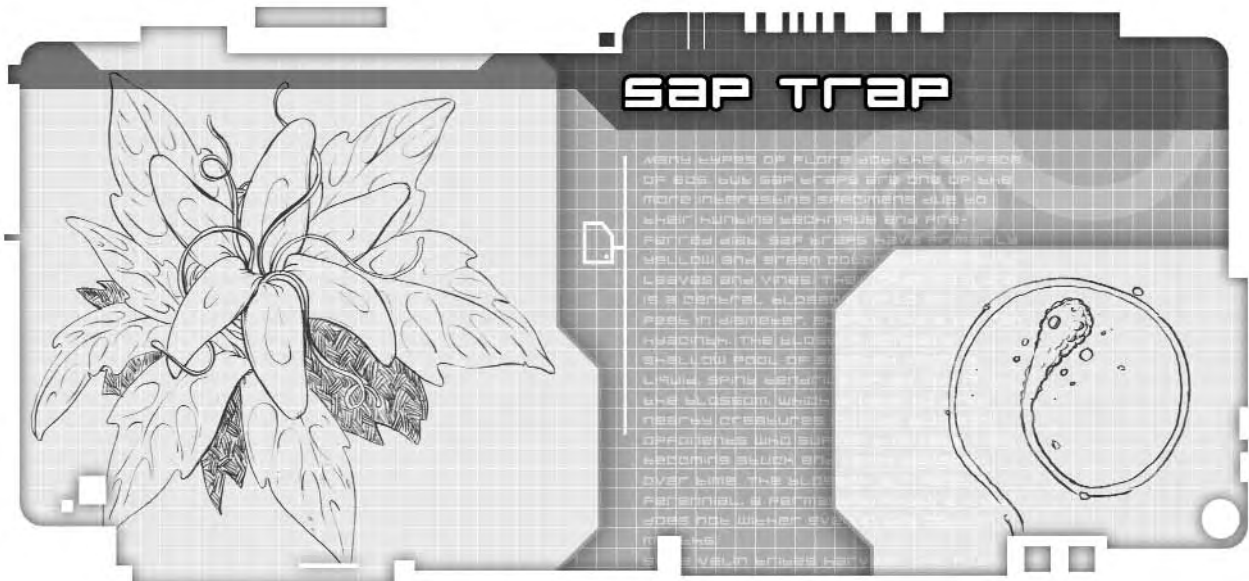

ft.; SQ digestive sap, plant traits, spiked tendrils, tremorsense; AL none; SV Fort +7, Ref +0, Will +1; AP 0; Rep +0; Str 20, Dex 8, Con 16, Int —, Wis 10, Cha 4.

Skills: None.

Feats: None.

Advancement: 5-15 HD (Huge), 16-32 (Gargantuan).

◆ SHOVEL-HEADED CENTIPEDE

Named for their distinctive, spade-shaped heads which help them burrow through the desert sands, these vermin are ambush hunters, inhabiting alluvial planes. The head is set upon a saffron-colored, segmented carapace. Some specimens have dark brown mottling. The name centipede is something of a misnomer, as they have merely 24 legs. Two short tentacles with pincers protrude from the edges of its head, providing a means of holding prey and injecting their poison. Their antennae are their only sensory organs. They can grow as long as 8 feet and weight up to 400 pounds.

The centipedes attack by lashing out with their tentacles, biting any who fall prey to their toxic touch. Once the intended meal is immobilized, they drag them off or bury them in the sand for later consumption.

The velin have been known to harvest their poison glands to coat their weapons.

Species Traits

Blindsight (Ex): With their sensitive antennae, shovel-headed centipedes have blindsight to a range of 60 feet.

Poison (Ex): On a successful tentacle hit, an opponent is exposed to the centipedes poison. The poison has a Fortitude save (DC 19) to resist. The poison deals initial and secondary damage of 1d6 Dex.

Polished Carapace (Ex): Digging through sand rubs their carapace to a shiny finish. This finish combined with natural adaptation grants the shovel-headed centipede fire resistance 5 and immunity to lasers.

Resistance to Massive Damage: Shovel-headed centipedes gain a +8 species bonus on Fortitude saves to negate the effects of massive damage.

Bonus Feat: Shovel-headed centipedes receive the bonus feat Multiattack.

Skill Bonus: Shovel-headed centipedes get a +6 racial bonus to Hide checks when in sandy environments.

Shovel-Headed Centipede ◆ CR 3

Medium vermin; HD 7d8+28; hp 59; Mas 18; Init +2; Spd 40 ft., burrow 20 ft.; Defense 17, touch 12, flat-footed 15 (+2 Dex, +5 natural); BAB +5; Grap +6; Atk +6 melee (1d6+1, bite); Full Atk +6 melee (1d6+1, bite) and +4 melee (1d4 plus poison, 2 tentacles); FS 5 ft. by 5 ft.; Reach 5 ft.; SQ blindsight, poison, polished carapace, resistance to massive damage; AL none; SV Fort +9, Ref +4, Will +2; AP 0; Rep +0; Str 12, Dex 14, Con 18, Int -, Wis 10, Cha 2.

Skills: Spot +6, Hide +6.

Feats: Multiattack.

Advancement: 8-12 HD (Large); 13-24 (Huge).

◆ SIREN MEGALODON

Stalking the blue depths of Eos's larger oceans, these monstrosities rarely approach the surface. They had escaped notice altogether until a pod of them were recently encountered by a fishing vessel from Roger's Point. Certainly a super-predator, these aquatic monsters resemble mythical sea serpents. Measuring more than 30 feet long, they look

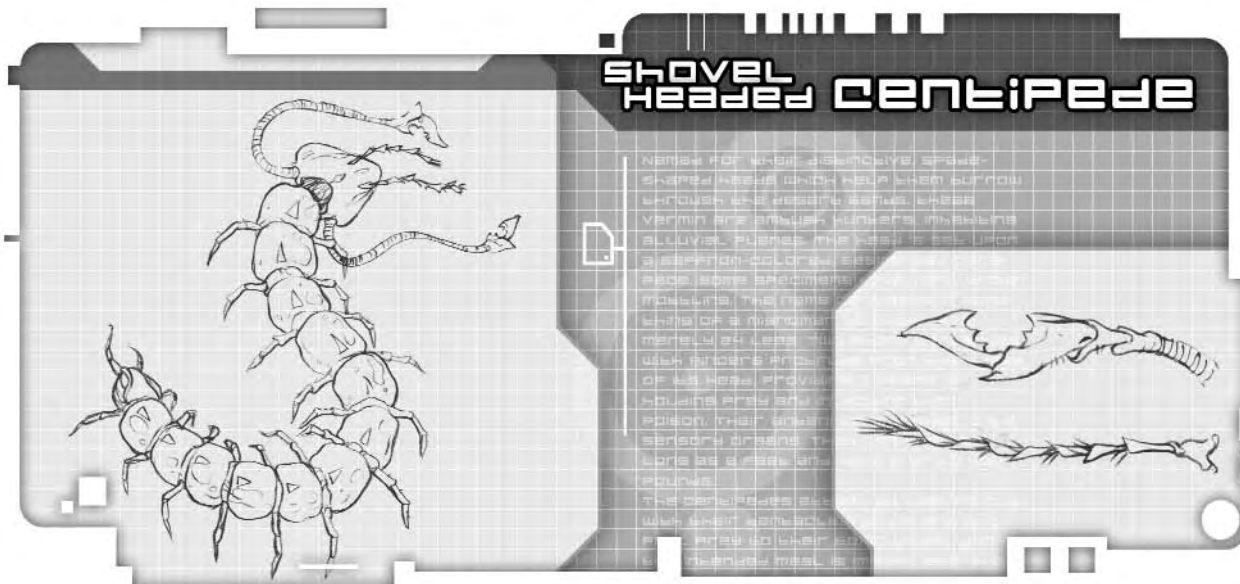

like aqua-hued, bullet-shaped sharks; however, their dorsal fins have been replaced with a membrane that stretches from head to tail and shimmers with vivid colors. Their ventral fins are covered in a series of barbs but still allow them to fly through the water. Massive teeth line the siren megalodon's hinged jaw, which are marked with short whisker-like features, possibly cartilaginous in nature. The creature can easily swallow a human being whole and feeds on some of the larger life forms present in Eos's oceans.

Because of its recent discovery and preference for the deeper regions of the ocean, little is known of the siren megalodon. Because the siren megalodon has only one confirmed sighting and has never been caught, it is impossible to divine its behavior. Whether they are ancient survivors from the age of the ruins or a newer animal remains a mystery.

The first sighting occurred from the air when some surveyors spotted a siren megalodon swimming near the surface off Roger's Point. A large patch of red-colored water was also visible, leading the crew of the aircraft to believe the siren megalodon had just killed something. Soon afterward, several more siren megalodons arrived and began eating off the first creature's kill. This has led some xenobiologists to suspect the siren megalodon has a tight social structure, similar to terran dolphins. The creature earned its name because it emitted a piercing wail at periodic intervals while it was feeding. The velin have legends of creatures similar in description to the siren megalodon that attacked velin ships.

Species Traits

Aquatic: Siren megalodons can move in water without making Swim checks and cannot drown in water.

Bio-electric Sense (Ex): The siren megalodon can sense living creatures by their bio-electric signature within a 180 foot radius.

Improved Grab (Ex): To use this ability, a siren megalodon must hit an opponent of its size or smaller with its bite attack. If successful, the siren megalodon grabs the target in its jaws and can try to swallow the target. See D20 MODERN.

Regenerative Metabolism (Ex): The siren megalodon regains 1 hit point per round unless it falls below -10 hps. Additionally, it repairs damaged flesh and can regrow body parts, including its fins and sail.

Siren's Sail (Ex): The creature's dorsal membrane shimmers with shifting color patterns. Treat this ability as a gaze attack. Any opponent subjected to it must make a Will save (DC 18) or become dazed. Anyone falling victim to the effect may make a new saving throw each round to regain their senses.

Swallow Whole (Ex): A siren megalodon can try to swallow a grabbed target of Large or smaller size by making a successful grapple check. Once inside, the opponent takes 1d8+6 points of bludgeoning damage plus 2d4 points of acid damage per round. A swallowed target can cut its way out using natural attacks or a Small or Tiny weapon by dealing 25 points of damage to the siren megalodon's digestive tract, which has an AC 14. A siren megalodon can hold 2 Medium, 4 Small, 8 Tiny, or 16 Diminutive or smaller creatures in its stomach at one time.

Ventral Barbs (Ex): The siren megalodon has a row of barbs on each side and will sometimes sideswipe a target with these barbs before going in for the kill. Any creature adjacent to the megalodon on any turn it moves suffers 1d4 points of slashing damage for each 5 feet that moves by it up to a maximum of 3d4. A successful Reflex save (DC 24) halves the damage.

Bonus Feat: Siren megalodons gain the bonus feat Improved Initiative.

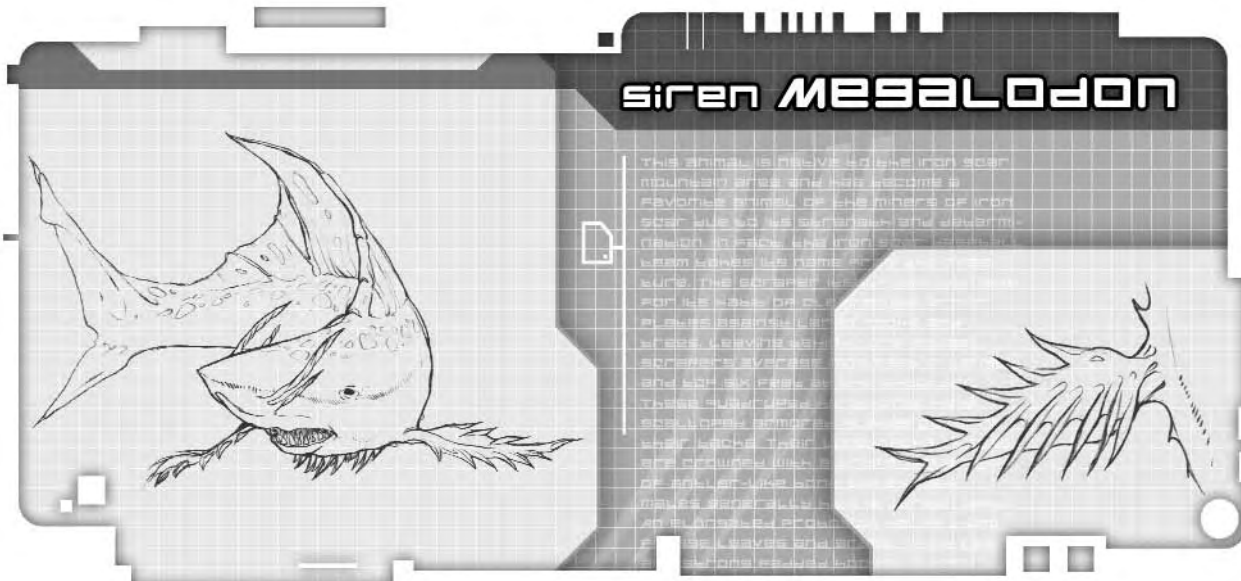

Siren Megalodon ♦ CR 10

Huge animal; HD 12d8+60; hp 114; MAS 21; Init +5; Spd swim 80 ft.; Defense 17, touch 9, flat-footed 16 (+1 Dex, -2 size, +8 natural); BAB +9; Grap +25; Atk +15 melee (2d6+12, bite); Full Atk +15 melee (2d6+12, bite); FS 15 ft. by 15 ft.; Reach 10 ft.; SQ aquatic, bio-electric sense, improved grab, low-light vision, regenerative metabolism, siren's sail, swallow whole, ventral barbs; AL none; SV Fort +13, Ref +9, Will +3; AP 0; Rep +0; Str 27, Dex 12 Con 21, Int 2, Wis 8, Cha 14.

Skills: Listen +5, Spot +5, Swim +19.

Feats: Improved Initiative.

Advancement: 13-16 HD (Huge).

♦ SLOTH ROACH

These vermin stalk the floors and treetops of tropical forests in the equatorial regions of Eos, eating pectar fruits or occasionally feasting on the sickly-sweet rotting flesh of fallen animals. The sloth roach derives its name from its habit of hanging upside-down from trees. "Monkey roach" is another popular name, though people tend to laugh when hearing it. The insect's carapace resembles the large leaves found on some vegetation in its native environment, and their underbody is covered with long tufts of fibrous brown hair, giving them excellent camouflage in jungle conditions. Two large climbing limbs allow them to scale trees and swing from branch to branch. Their six legs, much smaller than their arms, are mainly used for balance while climbing.

There are common, normal-sized versions of both genders, but the rarer, giant versions examined by scientists have only been female. Dawning Star researchers and terraformers theorize that the females spontaneously undergo a growth spurt during gestation of their brood, resulting from a combi-

nation of increased food consumption and hormonal changes. Curiously, the smaller sloth roaches continue to interact with the larger versions even after the transformation, hitching migratory rides on their hairy underbellies and bringing them additional food.

Giant sloth roaches have only been known to attack other creatures when protecting a cluster of common sloth roaches. Sloth roaches do not normally pose a threat to humans and avoid them when possible. However, they are attracted to both the smell of blood and pectar fruit, resulting in some encounters with humans. Giant sloth roaches will attack wounded creatures to feed upon them and will defend pectar fruit trees from other animals, including humans trying to harvest the fruit. Even when attacking, sloth roaches are not particularly dangerous, but most pectar fruit farmers find them to be a great nuisance.

The velin tend to avoid sloth roaches, knowing that there are always other pectar fruit to pick. Some velin tribes make camouflaged hunting outfits from the carapace of the sloth roach, but many consider its carcass too distasteful to work.

Species Traits

Camouflage (Ex): A motionless sloth roach looks like nothing more than a cluster of leaves. A roach that has remained motionless for one full round enjoys the benefits of one-half concealment and gains a +5 species bonus to Hide checks.

Repellent Spray (Ex): Enemies who surprise sloth roaches often find themselves greeted with a spray of sticky ichor, which irritates their eyes and flesh. The substance is ejected from an orifice set between the creature's eyes. To hit, the roach must make a successful ranged touch attack against a target within 10 ft.

Anyone with exposed skin, who is struck by the

SLOTH ROACH

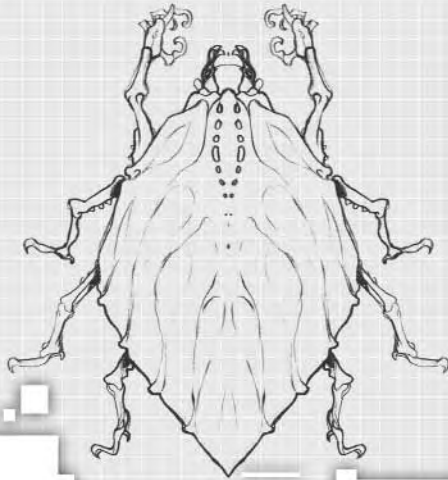

These vermin scurry the floors and
 crevices of artificial worlds in the
 shadows of corners of the halls
 and in the dark, usually staying
 out of sight until they are
 needed. They are a common
 pest in the halls of the
 velin, and their presence is
 often a sign of a vermin
 infestation. They are a
 common pest in the halls of
 the velin, and their presence is
 often a sign of a vermin
 infestation. They are a common
 pest in the halls of the velin,
 and their presence is often a
 sign of a vermin infestation.

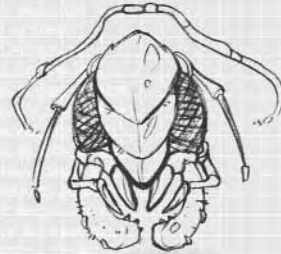

spray, suffers one point of acid damage and must make a Fortitude save (DC 11) to avoid an adverse reaction. Targets who fail the save suffer a -2 circumstance penalty on all attack rolls and skill checks for 1d6 hours or until treated. Thoroughly washing the affected area for ten minutes negates the effect. Targets with no exposed skin are immune to this effect. A sloth roach can expel its spray once every 1d6 rounds. Using this ability is an attack action that does not provoke an attack of opportunity.

Resistance to massive damage: As a vermin, sloth roaches gain a +5 species bonus on Fortitude saves to negate the effects of massive damage.

Tremorsense (Ex): Using sensitive cilia covering their legs and antennae, sloth roaches automatically sense any movement within 20 feet.

Skill Bonus: Sloth roaches get a +8 species bonus to Climb checks.

Sloth Roach ♦ CR 1

Small vermin; HD 3d8; hp 13; MAS 15; Init +2; Spd 20 ft., climb 20 ft.; Defense 16, touch 13, flat-footed 14 (+2 Dex, +3 natural, +1 size); BAB +2; Grap -3; Atk +2 melee (1d3 -1, bite) or +4 ranged touch (1 acid plus irritation, spray); Full Atk +2 melee (1d3 -1, bite) or +4 ranged touch (1 acid plus irritation, spray); FS 5 ft. by 5 ft.; Reach 5 ft.; SQ camouflage, low-light vision, immune to mind-affecting effects, repellent spray, resistance to massive damage, tremorsense; AL none; SV Fort +3, Ref +3, Will +1; AP 0; Rep +0; Str 8, Dex 14, Con 10, Int -, Wis 10, Cha 2.

Skills: Climb +13, Hide +12.

Feats: None.

Advancement: 4-8 (Small).

♦ SPETSIN

Found in most every velin camp, spetsin are a species of small quadrupeds similar in appearance to a terran boar. Spetsin have thick shocks of dark violet fur around their head and their legs, but most of the rest of their body is covered in harsh, leathery, purple-gray skin similar to that of the velin. This similarity has spawned several velin legends that say the spetsin were created from the velin to serve as assistants and allies. In fact, this legend is grounded in truth, as the spetsin sprang forth from the same cloning facilities that produced the velin. Since the awakening of the velin, the spetsin have been constant allies and have a strong inborn drive to protect and serve the velin. The velin, in turn, respect and care for the spetsin, treating them as adopted family members. Some velin tribes believe that spetsin are the reincarnated spirits of fallen velin, coming back to the physical world to guard their descendants.

The spetsin have large, razor-sharp teeth that fill their menacing jaw, making it easy to take down creatures much larger than themselves. Spetsin also have claws on their feet, but they are used more for digging and climbing rocky surfaces than for combat. Spetsin prefer to eat murcow and Dawson dragon meat when available, but they will eat bugs and terran creatures when pressed. Within the velin tribes, they are often used to track and corner prey, their velin companions coming for the final kill.

Spetsin are largely indifferent to humans and tend to follow the lead of their velin masters when dealing with them. Spetsin are not as welcoming of strangers as terran dogs, something many humans have learned the hard way. Most humans who deal with spetsin do not like them, considering them hyperactive and all too ready to bite. Those humans who deal regularly with the velin do not feel this strongly

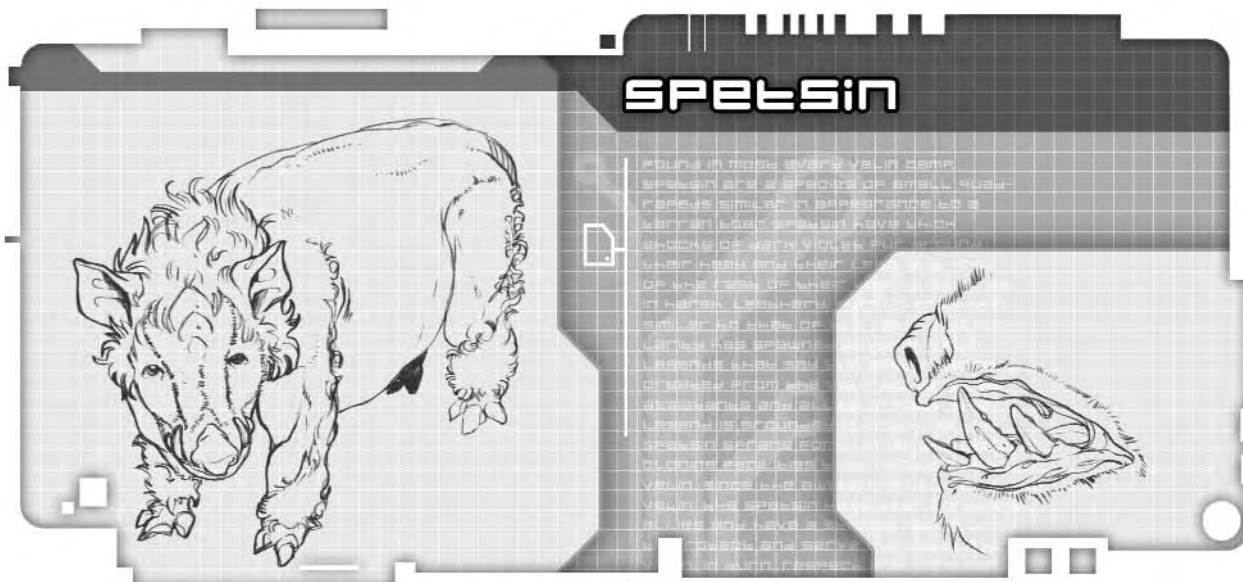

and sometimes even have their own spetsin companions. The vaasi hate spetsin and kill them whenever possible. Vaasi warhounds are known to hold a special hatred for spetsin and battles between the two creatures are bloody and fierce.

Species Traits

Bonus Feat: The spetsin receives the Increased Damage Threshold feat as a bonus feat.

Low-Light Vision (Ex): Spetsin have low-light vision. A spetsin can see twice as far as a human in starlight, moonlight, the light of a glow-stick, and similar conditions of shadowy illumination. Spetsin retain the ability to distinguish color and detail under these conditions.

Scent (Ex): Using their acute sense of smell spetsin can detect approaching enemies, sniff out hidden foes, and track creatures by smell, particularly vaasi and their servitor species. Vaasi creatures are considered to have an overpowering scent for purposes of this ability. See d20 Modern

Skill Bonus: Spetsin gain a +2 species bonus on Survival checks when tracking by scent. This bonus increases to +5 when tracking vaasi creatures.

Trip (Ex): A spetsin that hits with a bite attack can attempt to trip the opponent as a free action without making a touch attack or provoking an attack of opportunity. If the attempt fails, the opponent cannot react to trip the spetsin.

Vaasi Hatred: Spetsin attack vaasi on sight unless directed otherwise by their velin master.

Velin Friendship: Velin receive a +4 circumstance bonus to Handle Animal checks involving spetsin.

Spetsin ♦ CR 2

Medium Animal; HD 3d8+6; hp 19; Mas 18; Init +1; Spd 40 ft.; Defense 15, touch 11, flat-footed 14 (+1 Dex, +4 natural); BAB +2; Grap +4; Atk +4 melee (1d6+3, bite) Full Atk +4 melee (1d6+3, bite); FS 5 ft. by 5 ft.; Reach 5 ft.; SQ low-light vision, scent, trip, vaasi hatred, velin friendship; AL velin tribe or master; SV Fort +5, Ref +4, Will +2; AP 0; Rep +0; Str 15, Dex 13, Con 15, Int 2, Wis 12, Cha 5.

Skills: Jump +6, Listen +3, Spot +6, Survival +5.

Feats: Increased Damage Threshold.

Advancement: 4-8HD (Medium).

♦ SPITTER SPIDER

A small, insectoid creature common in the deepest shadows of the Eotian ruins, the spitter spider is actually a six-limbed beast more similar to an ant than a spider. The spitter spider is able to produce a powerful acidic substance from a gland below its mandibles that it can expel a short distance, bringing down its prey and aiding in the digestive process. This acid is also used to weaken rocks, trees, and metal to create latticed shelters that look like webs. It is this last practice that gives the spitter spider its name. The spitter spider uses these metallic webs to trap its prey by sealing off possible escape routes or forcing into impassable areas.

Spitter spiders are carnivores that prefer mammalian meat and will eat the flesh of velin or humans readily. When possible, spitter spiders prefer eating creatures native to Eos, but when hungry they will eat anything that moves. Spitter spiders are a common threat for relic hunters exploring the ruins of Eos because such ruins are the favored hunting ground of the spitter spiders. They normally lurk in dark places where they have set up a web, waiting for a suitable meal to pass by and leap upon. Spitter spiders will attack most any target of

SPITTER SPIDER

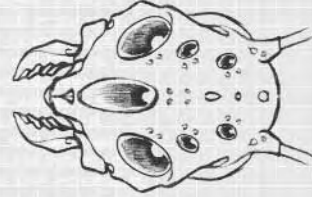
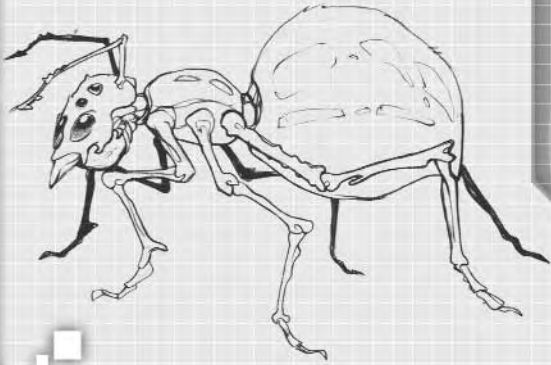

Medium size or smaller, but try to avoid large numbers of enemies. While spitter spiders are solitary, they sometimes build nests in close proximity, if the local food supply can handle it. Such areas are labyrinthine networks of metallic webs, making it easy for prey to get surrounded by the resident spitter spiders.

Most common in city ruins in temperate climates, spitter spiders have few natural predators, but their meat is a favored meal of the vaasi. The velin sometimes use their chitin as armor and harvest their acid glands, which they process and use to coat their weapons. Unfortunately, spitter spiders reproduce quickly and have been known to invade inhabited dwellings, if they cannot find empty buildings. In response to their infestations, a number of extermination agencies have cropped up in Dawning Star and Roger's Point specializing in spitter spider extermination, but this is a rather dangerous career with a tragically short lifespan for many of its practitioners.

Species Traits

Acid Spittle (Ex): Spitter spiders can spit powerful acid as an attack action. This attack has a range of 10 feet, with no range increment, and inflicts 1d6 points of acid damage.

Immunities: Spitter Spiders are immune to mind-affecting effects.

Prodigious Leap (Ex): Spitter spiders can leap great distances. They are treated as having a speed of 30 ft. for purposes of making Jump checks, and they receive a +4 species bonus on Jump checks.

Resistance to Massive Damage (Ex): Spitter spiders gain a +5 species bonus on Fortitude saves to negate the effects of massive damage.

Skill Bonus: Spitter spiders get a +5 species bonus to Climb, Hide, and Move Silently checks.

Tremorsense (Ex): Spitter spiders are sensitive to tiny vibrations. When in contact with any surface, they automatically sense any movement on that same surface within 30 feet.

Spitter Spider ♦ CR1

Small Vermin; HD 2d8; hp 9; Mas 11; Init +1; Spd 20 ft.; Defense 16, touch 12, flat-footed 15 (+1 size, +1 Dex, +4 natural); BAB +1; Grap -4; Atk +1 melee (1d4-1, bite), +3 ranged touch (1d6 acid, spittle); Full Atk +1 melee (1d4-1, bite), +3 ranged touch (1d6 acid, spittle); FS 5 ft. by 5 ft.; Reach 5 ft.; SQ acid spittle, immune to mind affecting effects, prodigious leap, resistance to massive damage, tremorsense; AL none; SV Fort +3, Ref +1, Will +1; AP 0; Rep +0; Str 9, Dex 13, Con 11, Int -, Wis 13, Cha 5.

Skills: Hide +14, Jump +6, Move Silently +10, Spot +4.

Feats: None.

Advancement: 3-4 HD (Large), 5-8 HD (Medium).

♦ SWAMP HULK

The first of these enormous amphibians was encountered in a swamp in the Southern Resource Zone, near one of the crashed spacecraft that dot the surface of Eos. This coincidence has led xenobiologists to debate several theories. Some hypothesize that they are a naturally evolved species; others claim they were an indigenous species whose development was influenced by pollutants from the crashed spacecraft; and still others believe that it is an alien transplant that had been transported on the crashed spacecraft. Initial tests indicate that its genetic makeup has no terran analog, giving credence to the latter theory. Still, despite its alien nature, it has adapted well to Eos and carved out its own niche in the biota.

SWAMP HULK

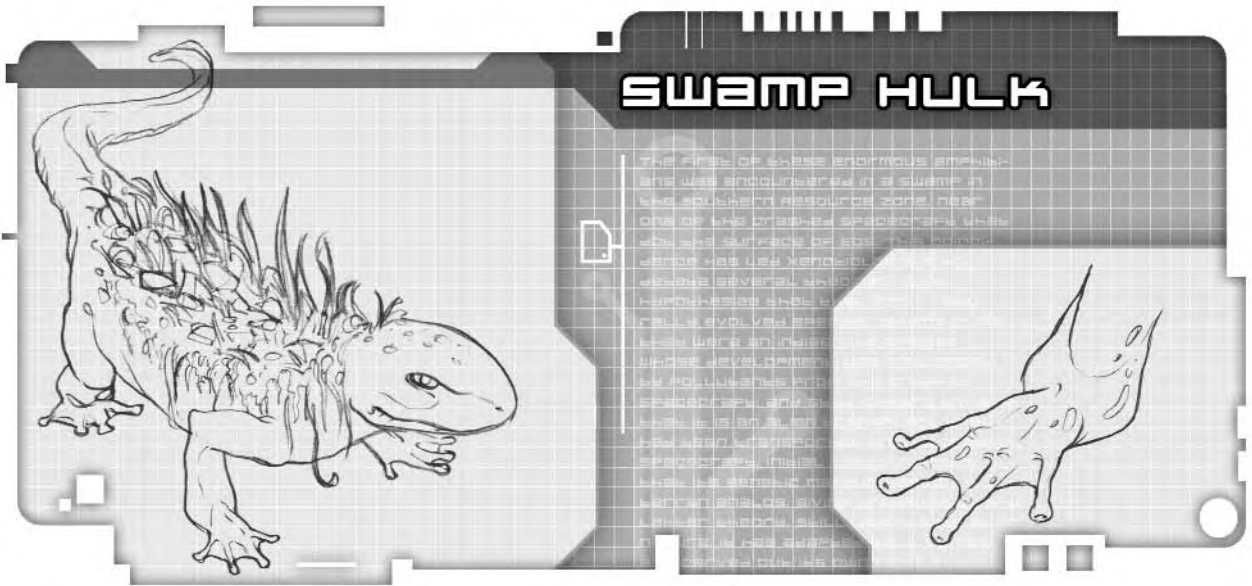

Hidden under a carapace of mud, rock and vegetation, these creatures resemble large, gray-and-brown speckled salamanders. The notable covering of swampy debris, which varies in thickness from inches to a foot or more, helps camouflage them when they are resting or hunting. Xenobiologists have yet to explain how the amphibian supports the weight of the carapace without a more developed skeletal system, though they suspect it has something to do with large liquid-filled bladders that appear throughout its body. The creature never ventures far from swamps, lakes and other bodies of standing water. Those that have been removed from the water for more than few hours have died of dehydration and ultimately being crushed by the soil on their backs.

Swamp hulks prey on anything smaller than themselves, yet they seem to be very picky in their choice of meals. One creature can safely cross before their mouth and never even know the hulk is lurking nearby, while another creature of the same type and taking the same path may find itself in a fight for its life. Typically, the swamp hulk attempts to swallow a single creature and then retreat to digest the prey. It often speeds the process along by flooding its mouth with murky water to drown the prey. Swamp hulks have been known to attack humans, though they rarely confront groups of them. Unfortunately, over the last few years reports of attacks by swamp hulks have increased dramatically. These reports tend to be limited to the same areas over and over again, leading some xenobiologists to theorize that a small part of the swamp hulk population has developed a taste for human flesh, hunting it above all other prey. The Eos Defense Force is considering putting together a hunting expedition to thin the numbers of the swamp hulk. When engaged in combat, swamp

hulks defend themselves with debris encrusted claws and with their heavy tail.

Velin avoid swamps generally, and many say it is because of the threat of the swamp hulks. The creature's voracious appetite has claimed many unaware velin in the past

Species Traits

Artificial Carapace (Ex): Covered with mud, brambles and bits of stone, the swamp hulk has excellent protection, both making it more difficult to hit and absorbing all but the most piercing blows. Swamp Hulks have damage reduction 5/piercing or ballistic.

Improved Grab (Ex): To use this ability, a swamp hulk must hit an opponent of its size or smaller with its bite attack. If successful, the swamp hulk grabs the target in its jaws and can try to swallow the target. See d20 Modern.

Swallow Whole (Ex): A swamp hulk can try to swallow a grabbed target of Medium or smaller size by making a successful grapple check. Once inside, the opponent takes 1d4 points of acid damage per round. Additionally, the swamp hulk can swallow a large amount of water.

Anyone in the swamp hulk's stomach must hold their breath or begin to drown (see d20 Modern). A swallowed target can cut its way out using natural attacks or a Small or Tiny weapon by dealing 18 points of damage to the swamp hulk's rubbery stomach, which has an AC 11 and damage reduction 2/-. A swamp hulk can hold 2 Small, 4 Tiny, or 8 Diminutive or smaller creatures in its stomach at one time.

Skill Bonus: Swamp Hulks get a +8 racial bonus to Hide checks when in swampy regions.

YANORIS RAPTOR



Swamp Hulk ♦ CR 5

Large animal; HD 7d8+21; hp 52; MAS 17; Init +1; Spd 30 ft.; Defense 16, touch 10, flat-footed 15 (+1 Dex, -1 size, +6 natural); BAB +5; Grap +13; Atk +8 melee (1d8+4, bite); Full Atk +8 melee (1d8+4, bite) and +3 melee (1d4+2 tail slap); FS 10 ft. by 10 ft., Reach 10 ft.; SQ artificial carapace, low-light vision, improved grab, swallow whole; AL none; SV Fort +8, Ref +6, Will +2; AP 0; Rep +0; Str 18, Dex 12, Con 17, Int 2, Wis 10, Cha 8.

Skills: Hide +5, Jump +7, Listen +5, Spot +3.

Feats: None.

Advancement: 8-12 HD (Large).

♦ YANORIS RAPTOR

With vicious claws and beaks, this flying reptile is a meat-eating predator found chiefly in the green lands east of Lanner's Crossing and south of Delhi. Clumsy on the ground but swifter in flight, their wings have a leading edge of cartilaginous fibers ending in clawed talons. Their lower bodies are serpentine in appearance, and when they travel along the ground they move in a similar manner. When not hunting, the raptors prefer lounging on large, sun-baked rocks, watching with large eyes set on the sides of their sleek heads. From the tips of their beaks to their tails, they average three feet in length and weigh in at 30 pounds. Black hides with splotches of green help collect warmth from the sun.

They've been known to attack children as well as small animals, and on occasion they swoop from the sky to grab unattended objects. They favor heated objects, such as lamps and other powered objects. The velin name for them translates roughly to "thief." Raptors can be eaten, but most agree the meat is leathery and unsavory. Their claws,

feathers, and beak are sometimes used for trinkets.

Species Traits

Bloodfrenzy (Ex): Yanoris raptors fly into a frenzy when they are injured. Any time they are reduced below their full hit points from an attack, they gain +4 species bonus to their Strength and Constitution scores and suffer a -2 circumstance penalty to their Defense. This frenzy lasts until they or their foe is defeated or for a number of rounds equal to their newly modified Constitution score, whichever occurs first. After the frenzy has passed, raptors become fatigued.

Heat Sense (Ex): Yanoris raptors are able to sense heat signatures within a 30-ft. radius. This allows them to sense warm-blooded creatures within range and acts as blindsight for that purpose.

Bonus Feats: Yanoris raptors receive the bonus feats Mobility and Spring Attack.

Yanoris Raptor ♦ CR 1

Small animal; HD 2d8+4; hp 13; Mas 14; Init +3; Spd 20 ft., fly 40 ft. (poor); Defense 17, touch 14, flat-footed 14 (+1 size, +3 Dex, +3 natural); BAB +1; Grap -4; Atk +1 melee (1d4-1, bite) Full Atk +1 melee (1d4-1, bite), -4 melee (1d3-1, 2 claws); FS 5 ft. by 5 ft.; Reach 5 ft.; SQ bloodfrenzy, heat sense, low-light vision; AL none; SV Fort +5, Ref +6, Will +0; AP 0; Rep +0; Str 8, Dex 17, Con 14, Int 2, Wis 10, Cha 4.

Skills: Balance +4, Spot +8, Survival +3.

Feats: Mobility, Spring Attack.

Advancement: 3-5 HD (Small), 6-7 HD (Medium).

TENTAARI • • •

The Tentaari present themselves to the humans of Eos as being hyper-intelligent creatures of a far advanced civilization. This is both true and misleading. The tentaari were wards of the creatures that originally settled Eos. This guardian species, whose name is now lost to the ages, were members of the now-extinct Star Confederation, which spanned dozens of worlds. However, the tentaari were not active members of the Star Confederation and are only recipients of handed-down technology. When the Star Confederation fell to the vaasi, its member species died off, but the tentaari survived. The last remnants of the Confederation charged the tentaari with keeping the Confederation's technology safe for the next generation of stellar explorers. Unfortunately, the tentaari were not dedicated to this charge and soon grew complacent and lethargic, relying on the wondrously advanced technology they had been given to support their carefree lifestyle. They interfered haphazardly with some of the younger species they discovered, including humans, but their activities rarely were more involved than occasional abductions or experiments. It is a great irony that the tentaari were convinced no other species was ready for the knowledge they controlled, for even the tentaari were not masters of this knowledge.

Over millions of years, the Star Confederation technology began to falter, and the tentaari had no means to repair it. Long ago, the tentaari shirked their duty to act as caretakers of such knowledge, since it seemed unnecessary in the face of the technology's raw power. Even the mighty gateway network is no longer functional in many regions of space. Tentaari enclaves remain isolated in remote stellar systems, where they will slowly die off, unable to stop their own demise due to their own ignorance. Somewhere beyond the Helios system there remain a few tentaari capable of creating nano-machines and incredible feats of genetic engineering, but even those tentaari will eventually succumb, as their machinery breaks down around them. Unfortunately, millions of years of plenty have made the tentaari complacent.

The tentaari in the Helios system number only two dozen, although they try to fool humans into thinking there are many more of them. The tentaari have only two functioning spacecraft of mediumweight size, though they have several smaller shuttles and launches. While the tentaari are progress level 8, some of the remaining Star Confederation technology is progress level 9 or even 10. The tentaari are able to repair most Progress Level 8 items well enough, but anything more advanced is extremely difficult at best. Accordingly, they have a wide variety of very advanced technologies—such as nano-robots and advanced energy weapons—that cannot be

replaced, repaired, or restocked. Due to this limitation, the tentaari are protective of what technology they still possess and take great efforts in avoiding conflict. Often, they will try to dissuade other groups from confronting them by means of intimidation through displays of advanced technology. This tactic has worked well in the Helios system thus far. The tentaari have renewed hope for the future with the arrival of the humans. They believe the humans can help them gather resources with which to repair the gateway network and maybe even aid in the actual repairs. While the tentaari feel like they need the help of the humans and the other races in the Helios system, they are terrified these “lesser” races will rise up against them when faced with the temptation of the advanced technology. So, the tentaari work constantly to keep these races confused, isolated, and scared. They have actively worked to convince humans not to explore the rest of the system, which is one of the main reasons the humans have remained on Eos. While the tentaari fear the vaasi, they are more than willing to sacrifice the humans and the other races to the vaasi, if it means the tentaari can escape. Unfortunately for the tentaari, they are the primary target of the vaasi forces in the Helios system.

The tentaari are a physically small species, with a strange appearance much like the portrayal of gray aliens of popular human culture. The tentaari inspired these stories through past trips to Earth, when the gateway network was fully functional. Most humans find the tentaari oddly terrifying. Their reflective black eyes give away little emotion, and their small mouths almost always seem stuck in a smile of smug arrogance. The tentaari deal with the humans regularly, but only specific humans who have been confirmed of being free from disease, mental derangement, or dangerous genetic elements and who can actually converse with the tentaari. Using this exclusionary tactic, the tentaari have also worked to ensure the human diplomats they deal with are susceptible to their methods of persuasion, including psionic powers on occasion. The tentaari so far have only had contact with representatives of the Dawning Star Republic and do not seem interested in the faction-camps, although the faction-camps are very interested in them. Tentaari are highly communal creatures and the idea of separate settlements at war with each other is deeply unsettling to them, so they ignore the problem.

While the only official contact between humans and tentaari is diplomatic contact carried out in Dawning Star, the tentaari occasionally kidnap individuals from other areas of Eos. These individuals and any technology they possess are examined physically and then released with little or no memory of the occurrence. The tentaari hope that they can learn from the human genetic structure what makes humans so driven and ambitious with the aim of

TENTABARI



The Tentabari presents them- selves as the humans of some worlds, but in truth they are a far advanced civili- zation. They are both true and false. The Tentabari were one of the creatures that once lived on the planet. This was the species whose name is now used for the ones who were members of the now-extinct Star City civilization, which was the source of wor- lds. The Tentabari were not the members of the Star City civilization, and are only re- sults of a genetic down- load. When the Star City civilization fell, the vessel that carried the Tentabari was destroyed, but the Tentabari survived. The last of the Tentabari were con- sidered by the Tentabari with a high level of respect. They were the last of the Tentabari, and were the only ones who were not destroyed. The Tentabari were the last of the Tentabari, and were the only ones who were not destroyed. The Tentabari were the last of the Tentabari, and were the only ones who were not destroyed.



TENTABARI DISINTEGRATOR

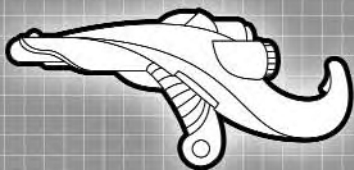

instilling those concepts in themselves. While they could approach the humans about this research, the tentaari are terrified of showing any sort of weakness to humans, thinking it will invite an attack. The tentaari are an intrinsically fearful species.

While the tentaari have a sort of grudging respect for humans, they do not like velin at all. The tentaari see the velin as being usurpers of their place as the race that carries on the tradition of the Star Confederation. At best, the primitive velin are a bad joke. The tentaari have little use for the velin and, in fact, see them as rivals for the limited resources of power in the system. If given the opportunity, the tentaari would wipe the velin out; their alien, amoral minds do not grasp the gravity of genocide. Oddly enough, their fear of the vaasi is the principal factor precluding this course of action. Equally curious, this one-sided rivalry actually drives the tentaari to overcome their current predicament more than any notion of self-preservation.

Tentaari normally have a very long reproductive cycle. Over time, they have come to rely on Star Confederation technology to augment the process. Presently, the tentaari in the Helios system cannot reproduce without outside assistance. The creature tanks may be sufficiently advanced to meet their needs. The tentaari in the Helios system all have at least eight class levels and most are heroes as opposed to ordinary characters. Because of their reproductive limitations and the fact the Helios system is cut off from the rest of tentaari territory, encountering lower level tentaari is unlikely.

Equipment carried by the tentaari is usually progress level 8, but they have some PL 9 and 10 items remaining. They never go anywhere outside their spacecraft without a personal force field. However, such devices have limited availability. Therefore, the tentaari avoid putting themselves in situations where the force fields are necessary.

This section presents the tentaari species traits and a few, sample tentaari NPCs. *DAWNING STAR: HELIOS RISING* will have more information about the tentaari, including their technology and their settlements.

Species Traits

Inscrutable (Ex): All opposed Bluff, Diplomacy, and Sense Motive checks against a tentaari suffer a -4 circumstance penalty.

Low Light Vision (Ex): Tentaari have low-light vision. A tentaari can see twice as far as a human in starlight, moonlight, the light of a glow-stick, and similar conditions of shadowy illumination. They retain the ability to distinguish color and detail under these conditions.

Poison Resistance (Ex): Tentaari physiology is drastically different from other species. Tentaari enjoy a +4 species bonus to Fortitude saves against poison.

Psionic Talent (Su): Tentaari have accessed the psionic potential of their minds and some are capable of using psionic powers. These tentaari have levels in either the Battlemind or Telepath advanced classes. These psionically trained tentaari are very rare, with no more than handful in the Helios system. They can teach psionic skills to other races, but have not done so as yet. Additional information on psionics will appear in *DAWNING STAR: HELIOS RISING*.

Unearned Technology: Tentaari are skilled at using equipment without a true understanding of it. Tentaari have a PL Familiarity of 8. However, they can use technology of any PL without penalty but suffer a -6 species penalty on all Repair and Craft checks for technology higher than PL 8. Tentaari can only select the Builder or Technological Aptitude feats as part of a class ability.

Vulnerability to Disease: Tentaari suffer a -4 species penalty on all Fortitude saves against disease.

Tentaari

Smart Hero 6/Negotiator 6 ♦ CR 12

Small humanoid; HD 6d8+6d6-12; hp 38; MAS 8; Init +1; Spd 20 ft.; Defense 16, touch 16, flat-footed 15 (+1 Dex, +4 class, +1 size); BAB +7; Grap +1; Atk +6 melee (1d3-2, punch), +9 ranged (5d8, disintegrator pistol); Full Atk +6/+1 melee (1d3-2, punch), +9/+4 ranged (5d8, disintegrator pistol); FS 5 ft. by 5 ft.; Reach 5 ft.; SQ inscrutable, low light vision, unearned technology, vulnerability to disease, conceal motive, react first, talk down one opponent, no sweat; AL tentaari; SV Fort +4, Ref +5, Will +12; AP 12; Rep +4; Str 6, Dex 13, Con 8, Int 19, Wis 14, Cha 12.

Occupation: Bureaucrat

Skills: Bluff +18, Computer Use +19, Diplomacy +18, Decipher Script +15, Forgery +13, Gather Information +3, Intimidate +9, Investigate +15, Knowledge (Current Events) +15, Knowledge (Theology and Philosophy) +15, Listen +4, Navigate +13, Read Write Language (15 languages), Research +15, Sense Motive +10, Speak Language (15 languages), Spot +10.

Talents: Exploit Weakness, Linguist, Plan.

Feats: Alertness, Confident, Alien Weapons Proficiency, Attentive, Dodge, Educated, Iron Will, Personal Firearms Proficiency, Starship Gunnery, Studious, Trustworthy.

Advancement: By character class.

Possessions: PDA, personal force field, disintegrator pistol, piercing visor, medicomp sensor, neural computer jack, hologuise, photon shield.

Tentaari

Smart Hero 6/Engineer 6 ♦ CR 12

Small humanoid; HD 6d8+6d6-12; hp 38; MAS 8; Init +1; Spd 20 ft.; Defense 16, touch 16, flat-footed 15 (+1 Dex, +4 class, +1 size); BAB +7; Grap +1; Atk +6 melee (1d3-2, punch), +9 ranged (5d8, disintegrator pistol); Full Atk +6/+1 melee (1d3-2, punch), +9/+4 ranged (5d8, disintegrator pistol); FS 5 ft. by 5 ft.; Reach 5 ft.; SQ inscrutable, low light vision, unearned technology, vulnerability to disease, builder, improve kit +2, quick craft, superior repair, reconfigure weapon, sabotage, craft XP reserve; AL tentaari; SV Fort +4, Ref +6, Will +6; AP 12; Rep +4; Str 6, Dex 13, Con 8, Int 23, Wis 12, Cha 8.

Occupation: Technician

Skills: Computer Use +29, Craft (Electronic) +18, Craft (Mechanical) +18, Craft (Structural) +15, Disable Device +21, Drive +10, Forgery +17, Investigate +15, Knowledge (Physical Sciences) +23, Knowledge (Technology) +24, Navigate +21, Pilot +10, Repair +17, Research +15, Search +17, Speak Language (9 languages).

Talents: Linguist, Plan, Savant (Computer Use).

Feats: Aircraft Operation (spacecraft), Builder, Educated, Gearhead, Meticulous, Salvage, Spacer, Starship Gunnery, Starship Mobility, Starship Operation, Surface Vehicle Operation, Zero-G Training

Advancement: By character class.

Possessions: PDA, electronics kit, mechanical kit, personal force field, disintegrator pistol, piercing visor, medicomp sensor, neural computer jack, hologuise, photon shield

Tentaari

Dedicated Hero 6/Telepath 8 ♦ CR 14

Small humanoid; HD 14d6-24; hp 27; MAS 8; Init +0; Spd 20 ft.; Defense 17, touch 17, flat-footed 17 (+6 class, +1 size); BAB +8; Grap +2; Atk +6 melee (1d3-2, punch), +9 ranged (5d8, disintegrator pistol); Full Atk +6/+1 melee (1d3-2, punch), +9/+4 ranged (5d8, disintegrator pistol); FS 5 ft. by 5 ft.; Reach 5 ft.; SQ inscrutable, low light vision, unearned technology, vulnerability to disease, trigger power (less-

er mindlink, detect thoughts, lesser domination), power crystal, combat manifestation; AL tentaari; SV Fort +3, Ref +4, Will +14; AP 13; Rep +5; Str 6, Dex 11, Con 5, Int 19, Wis 16, Cha 14.

Occupation: Investigative

Skills: Autohypnosis +14, Bluff +22, Concentration +11, Diplomacy +20, Gather Information +16, Investigate +15, Listen +14, Psicraft +15, Sense Motive +25, Speak Language (9 languages), Spot +14.

Talents: Aware, Empathy, Skill Emphasis (Sense Motive)

Feats: Alertness, Attentive, Deceptive, Far Shot, Focused, Iron Will, Personal Firearms Proficiency, Point Blank Shot, Starship Gunnery, Trustworthy, Wild Talent (detect psionics).

Advancement: By character class.

Possessions: PDA, personal force field, disintegrator pistol, piercing visor, medicomp sensor, neural computer jack, hologuise, photon shield.

Psionic Powers: (30 power points, manifester level 8th) 0th – *daze, detect psionics, distract, missive*; 1st – *attraction, charm person, lesser body adjustment, lesser mindlink*; 2nd – *brain lock, detect thoughts, suggestion*; 3rd – *lesser domination, mindlink*; 4th – *domination*.

♦ TENTAARI DISINTEGRATOR PISTOL

Remnants of the Star Confederation armament supply, these PL 9 devices break down molecular bonds, causing targets to disincorporate into their component atoms. These are powerful weapons that deal a gross amount of damage to the target. However, the tentaari only have a score of these weapons remaining and cannot make more. Disintegrator pistols run off of special power packs that the tentaari can recharge but not replicate. If any of the “lesser” species of Helios get their hands on a disintegrator pistol, the tentaari will go to great lengths to reclaim it.

Disintegrator pistols deal a unique type of damage called “disintegration.” No standard form of energy resistance will prevent or reduce it, though some other PL 9 items confer resistance to disintegration attacks. These items have “disintegration resistance.”

TENTAARI WEAPON

Weapon	PL	Damage	Critical	Damage	Range	RoF	Magazine	Size	Weight	Purchase	Restriction
			Type	Increment	Increment					DC	
Tentaari Disintegrator Pistol	9	5d8	20	Disint.	50 feet.	S	-	Small	3 lb.	NA	NA

VAASI • • •

The vaasi are an ancient race from a distant sector of the galactic core that went to war thousands of years ago with the original inhabitants of Eos. The war devastated both cultures and left the vaasi invasion force trapped on the planet after the battles their were over. These vaasi soldiers have been stranded on Eos now for tens of thousands of years. Their technology has crumbled until only a few working relics of it remain, and they have lost much of their culture and heritage. What remains is a burning hatred of those on whom they once waged war, whose reflection they see in the faces of the velin and the humans now on Eos. The vaasi are gearing up for war again, and while their numbers may be small compared to that of the humans, they have been fighting wars since before the first human mastered fire. What's more, reinforcements for the vaasi—launched thousands of years ago from their homeworld using sub-light drives and sleeper ships—have just arrived on the edge of the Helios system and begun fortifying asteroids in its outer orbits. They seek to rejoin their fellows on Eos and wipe out, once and for all, their old enemies who walk Eos again in the shape of their ancestors.

The vaasi are completely alien to humans and the velin, developing on a dark world completely different from Eos or Earth. Because of this, their physiology differs dramatically from that of humans or velin, as does their mindset. The vaasi possess a single-mindedness that most humans would qualify as a mental disorder. Where human psychologists have theorized a collective memory, the vaasi have something of a “collective vendetta.” To them, the war against the original inhabitants of Eos has never ended, the enemy has just changed somewhat. While the technology of the vaasi is not what it once was, it is more advanced than human technology.

The velin know of the vaasi on Eos, and their legends speak of an ancient war against them, one framed as a glorious tale of good versus evil. The origin of this war is long forgotten, but the velin know the vaasi remain on Eos. They hunt the vaasi when possible, but avoid the darklings at all costs if they are not prepared to do battle. The velin forge weapons of lunistone specifically to aid them in hunting vaasi. Both groups favor ruin areas for their homes, and there have been several territorial battles between the vaasi and the velin. The velin have destroyed the corpses of their enemy, fearing the vaasi dead may corrupt Eos with their touch. Because of this, most humans write off the vaasi as velin tales used to scare children.

There is a wide variety of body types and sizes among the vaasi due the common use of genetic engineering among their people. They have created numerous servitor races to do their bidding, using their own genetic structure as a baseline. However, not all these races have remained servile

in the thousands of years the vaasi have been stuck on Eos. The phrenics, for example, have leveraged their psionic abilities to become full members of the vaasi community. Most of the vaasi population on Eos is comprised of these servitor races; there are very few true vaasi on Eos. This is a good thing as “true vaasi” are terrors to behold.

This section presents a few of the basic vaasi species, including the true vaasi and a few of their servitor species. *DAWNING STAR: HELIOS RISING* will have more information about the vaasi, including their ancient past, their technology, and more of their minions.

◇ TRUE VAASI

True vaasi are large, six-limbed insectoid beasts that are covered in chitin plates. The skin and chitin of the vaasi are black or gray, with their four green eyes being the only color on their bodies. Other species have trouble telling individual vaasi apart, but the variations in the black and gray splotches across their face can be used to distinguish them. True vaasi stand ten feet tall when they stand fully erect on their rear legs, but they usually crouch at a more comfortable, eight-foot height. The vaasi run on four legs but stand on two; their middle limbs can serve as either arms or legs as the situation demands. The head of the vaasi is more canine than insectoid in appearance; they have long snouts and tooth-filled maws. They possess two tongues, allowing them to make a wider range of noises than most other species and making sibilant “s” sounds common in their speech. The blood of the vaasi is a yellow, viscous substance that clots quickly. Curiously, the vaasi consider their own blood a delicacy. Cannibalism is a common practice among the species and is actively used to weed out the weakest members. The vaasi culture dictates that the strong do as they please until someone stops them. They have little sense of community or loyalty and instead principally serve their own ambition and greed. Luckily for the vaasi, they can work together frighteningly well when their individual goals may be served by a cooperative front.

In the interest of avoiding direct danger, the vaasi long ago instituted a program of genetically engineering servitor races based on their own genetic material. This process has resulted in the creation of the phrenics, vaasi soldiers, vaasi warhounds, and other species. The vaasi become hermaphroditic toward the end of their lifespan and generally have a high reproductive rate. During this time, an individual vaasi can produce dozens of eggs each year. However, they prefer having their minions do their work for them. In any given vaasi force, there will likely only be one true vaasi for every one hundred servitor creatures. There are only a handful of true vaasi on Eos, though there are many more in the Cronus Belt on the edge of the Helios system.

Vaasi (True)

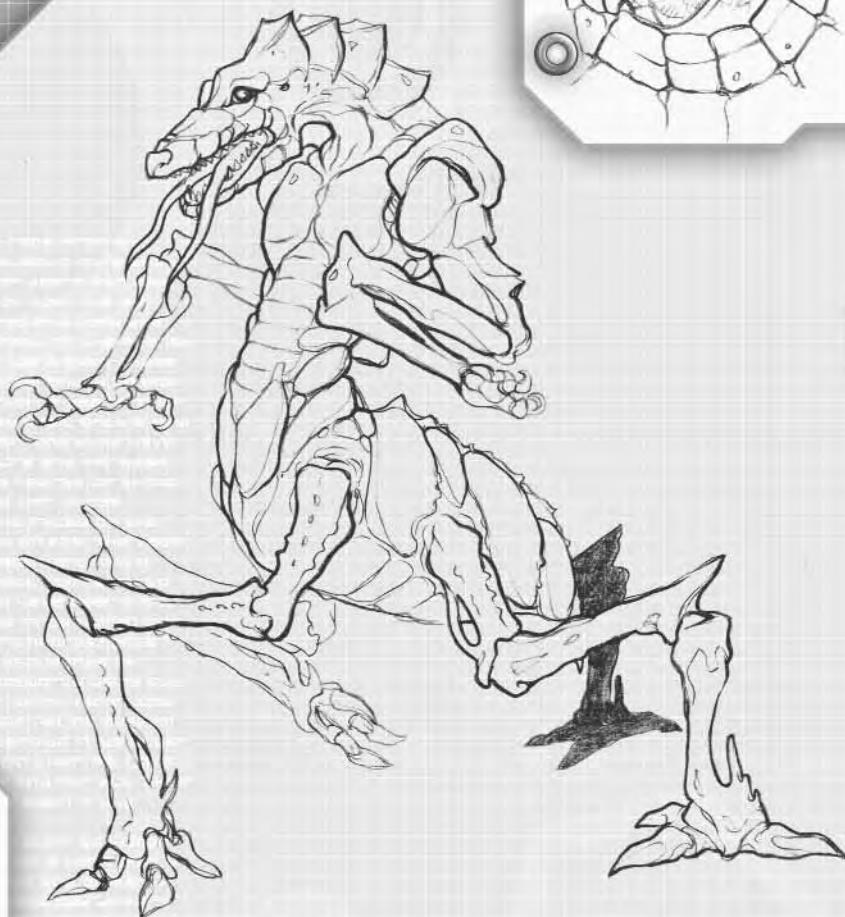
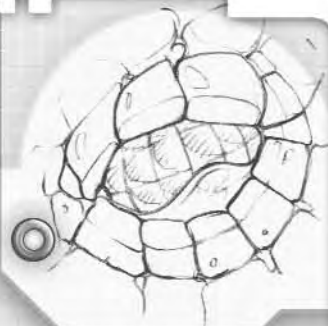

The Vaasi are an ancient warrior race of the planet Vaasi. They are a highly advanced species with a long history of warfare. The Vaasi are a highly advanced species with a long history of warfare. The Vaasi are a highly advanced species with a long history of warfare. The Vaasi are a highly advanced species with a long history of warfare.

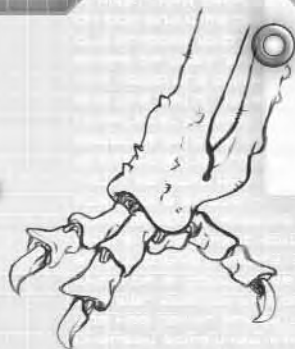

The Vaasi are a highly advanced species with a long history of warfare. The Vaasi are a highly advanced species with a long history of warfare. The Vaasi are a highly advanced species with a long history of warfare. The Vaasi are a highly advanced species with a long history of warfare.

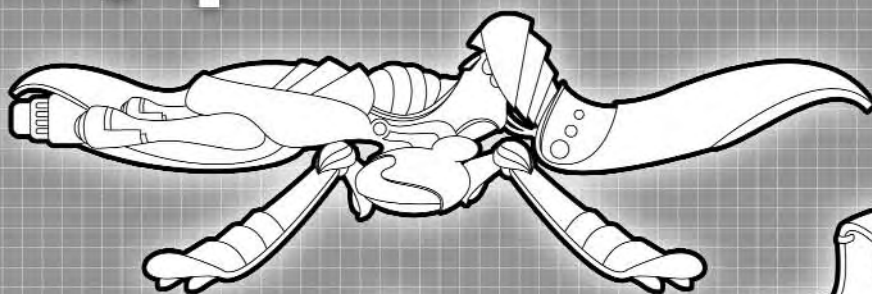

Vaasi Heavy Maser

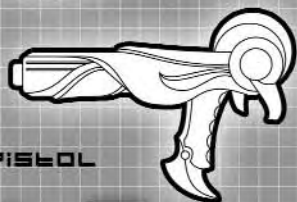

Vaasi Heavy Pistol

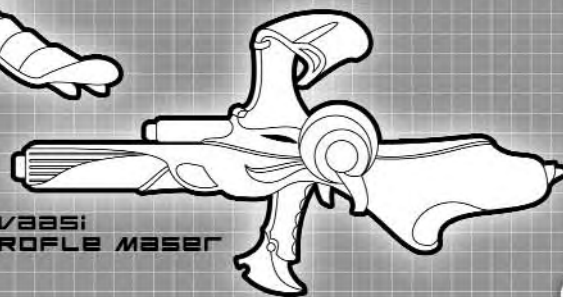

Vaasi Rifle Maser

The true vaasi have little respect or concern for their servitors and are more than willing to sacrifice them when needed. The servitors have been genetically predisposed to follow the orders of a true vaasi. On rare occasions, a servitor creature manages to rebel against its vaasi masters.

True vaasi live for several hundred years. Those true vaasi present on Eos have begun to succumb to the degradation of their technological base. They have a few items from their days of former glory, but these are used sparingly and only in times of great need due to the inability to repair them. In this way, the vaasi are suffering much the same fate as the tentaari, living in the shadows of their once great civilization. Conversely, the vaasi in the Cronus belt have access to the technology they brought with them, which was created shortly after the height of the Vaasi Empire. Thus, they are often outfitted with PL 8 weapons and armor, all custom made for vaasi use. The vaasi also have a number of ships in the Cronus Belt, but are loath to use them for fear of attracting attention before the time to strike is at hand. Where revenge is concerned, the vaasi have learned the value of patience.

True vaasi are cunning, physically powerful creatures that can easily kill most humans or velin. Their weakness lies in their overconfidence, lack of innovation, and poor cooperative skills. True vaasi populate many velin tales of legend, and they are always depicted as great horrors, spreading terror and woe across the land. Like most legends, the stories are grounded in an all-to-true reality.

Species Traits

Extra Limbs (Ex): When a true vaasi uses its middle limbs as arms, it gains a +4 species bonus on grapple checks. When a true vaasi uses its middle limbs as legs its speed increases by +10 feet and gains a +4 stability bonus to Balance checks and on checks to resist being bull rushed or tripped when standing on the ground. A true vaasi can alternate between using its middle limbs as arms and legs as a free action; however, it cannot use them in both ways during the same turn.

Improved Low-Light Vision (Ex): A true vaasi can see ten times farther than normal in poor lighting conditions. True vaasi can still distinguish colors, even in dim lighting.

Increased Massive Damage Threshold (Ex): Due their strange physiology, the true vaasi gain a +3 species bonus to their massive damage threshold.

Light Sensitivity (Ex): True vaasi are weakened by light due the darkened environment they come from. A true vaasi suffers a -2 penalty to all attack rolls, saving throws and skill checks while in direct sunlight or other light sources of similar brightness. This cannot be

alleviated except by seeking cover from the light. Lesser lights do not bother the true vaasi.

Psionic Potential (Su): True vaasi can take levels in both the Telepath and Battlemind advanced classes due to the innate psionic power of their species. The true vaasi do not need to meet the normal requirements for the advanced classes.

Bonus Feat: True vaasi receive the bonus feats Simple Weapons Proficiency and Archaic Weapon Proficiency.

*Equipment marked with an * are found on Cronus Belt vaasi only.*

Grunt True Vaasi ♦ CR 10

Large aberration; HD 10d8+50; hp 102; MAS 23; Init +1; Spd 30 ft.; Defense 22, touch 10, flat-footed 21 (+1 Dex, +12 natural, -1 size); BAB +7; Grap +15; Atk +10 melee (2d6+4, bite) or +7 ranged (5d8/19-20, maser rifle or 1d10/19-20, crossbow); Full Atk +10/+5 melee (2d6+4, bite) or +7/+2 ranged (5d8/19-20, maser rifle or 1d10/19-20, crossbow); FS 10 ft. by 10 ft.; Reach 10 ft.; SQ extra limbs, improved low-light vision, increased massive damage threshold, light sensitivity, psionic potential; AL vaasi; SV Fort +8, Ref +4, Will +12; AP 0; Rep +0; Str 19, Dex 13, Con 20, Int 17, Wis 16, Cha 16.

Skills: Climb +10, Hide +1, Intimidate +11, Jump +10, Knowledge (Tactics) +13, Listen +9, Move Silently +7, Navigate +9, Sense Motive +7, Survival +9.

Feats: Archaic Weapons Proficiency, Great Fortitude, Iron Will, Personal Firearms Proficiency, Point Blank Shot, Track.

Advancement: By character class.

Possessions: Maser rifle* or crossbow, 3 power packs* or 30 bolts, matter shield*, regen wand*, micro-aural communicator*.

Elite True Vaasi Soldier 6 ♦ CR 16

Large aberration; HD 10d8+6d10+80; hp 166; MAS 23; Init +2; Spd 30 ft.; Defense 25, touch 13, flat-footed 24 (+1 Dex, +12 natural, -1 size, +3 class); BAB +11; Grap +20; Atk +15 melee (2d6+5, bite) or +12 ranged (5d8+2/18-20, maser rifle or 1d10+2/17-20, crossbow); Full Atk +15/+10/+5 melee (2d6+4, bite) or +12/+7/+2 ranged (5d8+2/17-20, maser rifle or 1d10+2/18-20, crossbow); FS 10 ft. by 10 ft.; Reach 10 ft.; SQ extra limbs, improved low-light vision, increased massive damage threshold, light sensitivity, psionic potential, weapon specialization (maser rifle or crossbow), tactical aid, improved critical (maser rifle or crossbow); AL vaasi; SV Fort +11, Ref +8, Will +14; AP 9; Rep +1; Str 20, Dex 14, Con

20, Int 18, Wis 16, Cha 16.

Skills: Climb +11, Demolitions +6, Drive +6, Hide +3, Intimidate +17, Jump +10, Knowledge (Tactics) +19, Listen +15, Move Silently +13, Navigate +9, Sense Motive +7, Spot +9, Survival +13.

Feats: Archaic Weapons Proficiency, Dead Aim, Far Shot, Frightful Presence, Great Fortitude, Iron Will, Personal Firearms Proficiency, Point Blank Shot, Power Attack, Track, Weapon Focus (maser rifle or crossbow).

Advancement: By character class.

Possessions: Maser rifle* or crossbow, 3 power packs* or 30 bolts, matter shield*, regen wand*, micro-aural communicator*.

True Vaasi Battle Mind 6 ♦ CR 16

Large aberration; HD 16d8+80; hp 159; MAS 23; Init +2; Spd 30 ft.; Defense 27, touch 15, flat-footed 26 (+2 Dex, +12 natural, -1 size, +4 class); BAB +11; Grap +20; Atk +15 melee (2d8+5/19-20, beam sword) or +11 ranged (5d8/19-20, maser rifle or 1d10/19-20, crossbow); Full Atk +15/+10/+5 melee (2d8+5/19-20, beam sword) or +11/+6/+1 ranged (5d8/19-20, maser rifle or 1d10/19-20, crossbow); FS 10 ft. by 10 ft.; Reach 10 ft.; SQ extra limbs, improved low-light vision, increased massive damage threshold, light sensitivity, psionic potential psi blade +1, imprint tattoo, psychic shield, combat manifestation; AL vaasi; SV Fort +13, Ref +7, Will +15; AP 9; Rep +0; Str 20, Dex 14, Con 20, Int 17, Wis 18, Cha 16.

Skills: Autohypnosis +13, Climb +11, Concentration +11, Hide +2, Intimidate +13, Jump +11, Knowledge (Tactics) +13, Listen +10, Move Silently +8, Navigate +9, Sense Motive +8, Spot +12, Survival +10

Feats: Archaic Weapons Proficiency, Cleave, Combat Reflexes, Focused, Great Fortitude, Iron Will, Personal Firearms Proficiency, Point Blank Shot, Power Attack, Track, Wild Talent (valor).

Advancement: By character class.

Possessions: Maser rifle* or crossbow, 3 power packs* or 30 bolts, matter shield*, regen wand*, micro-aural communicator*, beam sword*

Psionic Powers: (11 power points, manifester level 6th) 0th – *detect psionics, valor, verve*; 1st – *combat precognition, fire bolt, vigor*; 2nd – *combat focus, combat prescience*.

♦ VAASI MASER WEAPONS

The vaasi of the Cronus Belt employ directed-microwave weapons for ranged combat. These weapons fire an intense beam of microwaves that cooks living flesh and fries electronics, but does minimal damage to structures. These weapons are used by vaasi infantry and commonly mounted on their spacecraft as well. These weapons inflict no damage on non-living objects without electrical components, but inflict normal damage on everything else. Maser weapons ignore light armor completely. Masers use vaasi power packs for ammunition which are not interchangeable with other types of power packs and cannot be recharged from anything but vaasi power generators.

Vaasi Maser Pistol

This small weapon was standard issue to vaasi soldiers during the height of the Empire and remains so among the vaasi on the Cronus Belt. The vaasi on Eos have a dozen of these weapons left but no means to recharge power packs.

Vaasi Maser Rifle

A larger version of the maser pistol, this weapon was once used by true vaasi and vaasi soldier assault troops. Now, most have been claimed by true vaasi for their personal use due to their growing scarcity.

Vaasi Heavy Maser

Sometimes carried by true vaasi as a squad support weapon, these weapons were more commonly deployed with a squad of four vaasi soldiers to transport and operate the weapon. Heavy masers can be broken into four primary components for easy transport. Heavy masers use a type of standardized large battery that powers many types of vaasi weapons. The vaasi on Eos have no operable batteries for the few heavy masers still in their possession.

VAASI MASER WEAPONS

Weapon	PL	Damage	Critical	Damage Type	Range Increment	RoF	Magazine	Size	Weight	Purchase DC	Restriction
Pistol	8	5d6	19-20	Rad.	40 feet.	S	20 box	Medium	5 lb.	NA	NA
Rifle	8	5d8	19-20	Rad.	100 feet.	S	20 box	Large	12 lb.	NA	NA
Heavy	8	5d12	19-20	Rad.	200 feet.	S	100 external	Huge	160 lb.	NA	NA

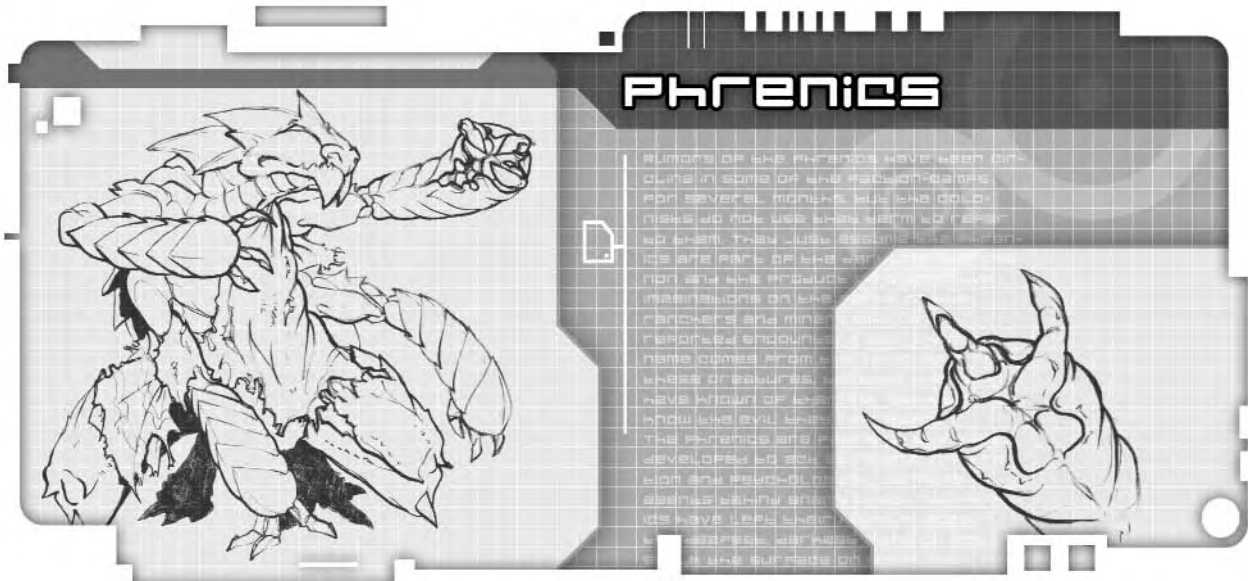

◆ PHRENIC

Rumors of the phrenics have been circling in some of the faction-camps for several months, but the colonists do not use that term to refer to them. They just assume the phrenics are part of the darkling phenomenon and the product of overactive imaginations on the parts of the ranchers and miners who have reported encounters with them. The name comes from the velin term for these creatures, because the velin have known of them for some time and know the evil they represent.

The phrenics are pawns of the vaasi, developed to act as psionic infiltration and psychological-warfare agents behind enemy lines. The phrenics have left their hiding places in the deepest, darkest ruins of Eos to stalk the surface on moonless nights looking for hapless humans to frighten. The phrenics were created to sow terror and confusion, and they have done so among the velin and humans as best they could. However, their limited numbers have caused their attacks to be written off as tall tales. The phrenics are growing more daring, and they will likely infiltrate Dawning Star itself within a few years, if their presence remains unchecked. A few phrenics, loose in Dawning Star, could wreak havoc on the city. To date, the phrenics have mainly struck humans near ruin areas. Most phrenics live near the remaining vaasi settlements on Eos, though they have left their servitor role behind and are now considered equals of the vaasi.

Phrenics resemble the vaasi they were based on, but are smaller and their features more angular. Phrenics have four arms and two legs with a snout-like head perched on a wide, short neck. Phrenics average six feet tall, but they usually stoop and use their secondary arms as supports. Phrenics wear cast-off human and velin clothes, preferring dark materials that allow them to conceal their appearance. Most phrenics reduce the clothes they take to

ragged in a few weeks due to lack of care and their rough, spiked skin.

One of the reasons phrenics hunt humans is that they attain the equivalent of an “emotional high” from extreme emotions. When near a humanoid brain that is experiencing such emotion, they literally feed off the brainwave activity produced by it. Phrenics prefer to experience this directly by touching the head of the victim, but due to their psionic abilities they can gain a lesser benefit even at a distance. Because of this, phrenics prefer to be as close as possible to their victims when they strike.

Species Traits

Blindsight (Sp): By using its psionic abilities to detect nearby objects, a phrenic gains blindsight with a range of 60 feet.

Improved Low-Light Vision (Ex): Phrenics can see ten times farther than normal in poor lighting conditions. The phrenics can still distinguish colors, even in dim lighting.

Increased Massive Damage Threshold (Ex): As phrenics are based on the physiology of the vaasi they gain some of their progenitor’s resistance to massive damage. The phrenic receives a +3 species bonus to its massive damage threshold.

Light Sensitivity (Ex): Like all vaasi servitor races, a phrenic is weakened by light, but not as much as its progenitors. A phrenic suffers a -1 penalty to all attack rolls, saving throws and skill checks while in direct sunlight or other light sources of similar brightness. This cannot be alleviated except by seeking cover from the light. Lesser lights do not bother the phrenic.

Psionics (Sp): A phrenic can use the following psionic powers at will, as though manifested by a 9th-level Telepath (save DC = 10 + Telepath’s key ability modifier + power level):

detect thoughts, distract, inflict pain, false sensory input, forced mindlink, mental blast, tailor memory.

Scent (Ex): This ability allows a phrenic to detect approaching enemies, sniff out hidden foes, and track by sense of smell. See p20 MODERN.

Bonus Feat: Phrenics receive the bonus feat Simple Weapons Proficiency.

Phrenic ♦ CR 9

Large Aberration; HD 9d8+18; hp 58; MAS 18; Init +0; Spd 30 ft.; Defense 18, touch 9, flat-footed 18 (+9 natural, -1 size); BAB +6; Grap +11; Atk +6 melee (2d4+1, bite or by weapon); Full Atk +6/+1 melee (2d4+1, bite or by weapon); FS 5 ft. by 5 ft.; Reach 5 ft.; SQ blind-sight 60 ft., improved low-light vision, increased massive damage threshold, light sensitivity, psionics, scent; AL vaasi; SV Fort +5, Ref +3, Will +9; AP 0; Rep +0; Str 13, Dex 10, Con 15, Int 15, Wis 16, Cha 18.

Skills: Hide +8, Intimidate +14, Listen +5, Move Silently +8, Spot +8, Survival +6.

Feats: Frightful Presence, Iron Will, Simple Weapons Proficiency, Stealthy.

Advancement: By character class.

♦ VAASI SOLDIER

One of the lower ranked vaasi servitor races, vaasi soldiers are the most common type of vaasi on Eos. Millions of them were brought to Eos during the final days of that ancient war, and hundreds of thousands of them remain. While few are still equipped with the gravitic and maser weapons they arrived with, they are still fearsome warriors. Vaasi soldiers spend most of their time in the subterranean vaasi enclaves preparing for the coming battles with the humans above, making weapons, or working to gather food and other resources for their enclave. Vaasi soldiers regularly carry out training exercises in the form of raids on other enclaves during which lethal force is used in order to keep the troops in top shape. Such is the martial mentality of the vaasi.

The vaasi soldiers are growing restless as the humans continue to expand across Eos, gaining in strength and numbers. For the past 20 years, the vaasi soldiers have been sneaking to the surface and attacking outlying human settlements, leading to the growing tales stories of the darklings. They have, thus far, only met real opposition from the velin, who know what the vaasi are and fight them at every opportunity.

Vaasi soldiers look like smaller versions of true vaasi, possessing the same, vaguely-humanoid, six-armed structure. Their skin is covered in a hard bone-like coating that makes them difficult to injure. Vaasi soldiers are gray in color from head to toe

and have four small eyes on the sides of their snout-like face. They usually wear roughly made leather armor and carry bladed weapons and crossbows. However, some vaasi soldiers still have their energy weapons and advanced armors from when they first came to Eos.

Species Traits

Armor and Weapon Restrictions: A vaasi soldier cannot wear armor designed for other species due to their six-limbed structure. Vaasi armor is cut differently and costs more than similar armor sized for a Medium character. Increase the purchase DC of vaasi soldier armor by +2.

Improved Low-Light Vision (Ex): A vaasi soldier can see ten times further than normal in poor lighting conditions. The soldiers can still distinguish colors, even in dim lighting.

Increased Massive Damage Threshold (Ex): Due their strange physiology the vaasi soldiers gain a +3 species bonus to their massive damage threshold.

Light Sensitivity (Ex): Like all vaasi servitor races a vaasi soldier is weakened by light, but not as much as its progenitors. A vaasi soldier suffers a -1 penalty to all attack rolls, saving throws and skill checks while in direct sunlight or other light sources of similar brightness. This cannot be alleviated except by seeking cover from the light. Lesser lights do not bother the vaasi soldiers.

Vaasi Servitor (Ex): A vaasi soldier must make a Will save to disobey a direct order given by a true vaasi (DC 10 + ½ the true vaasi's hit dice + the true vaasi's Charisma bonus).

Bonus Feats: Vaasi soldiers receive the bonus feats Archaic Weapon Proficiency and Simple Weapon Proficiency.

Vaasi Soldier ♦ CR 5

Medium aberration; HD 5d8+15; hp 37; MAS 19; Init +3; Spd 30 ft.; Defense 20, touch 13, flat-footed 17 (+3 Dex, +5 natural, +2 armor); BAB +3; Grap +5; Atk +5 melee (1d6+2/19-20, machete) or +6 ranged (1d10/19-20, crossbow); Full Atk +5 melee (1d6+2/19-20, machete) or +6 ranged (1d10/19-20, crossbow); FS 5 ft. by 5 ft.; Reach 5 ft.; SQ improved low-light vision, increased massive damage threshold, light sensitivity, vaasi servitor; AL vaasi; SV Fort +4, Ref +4, Will +4; AP 0; Rep +0; Str 15, Dex 16, Con 16, Int 9, Wis 10, Cha 8.

Skills: Drive +5, Hide +6, Move Silently +6, Repair +1, Spot +3, Survival +4.

Feats: Archaic Weapon Proficiency, Armor Proficiency (Light), Armor Proficiency (Medium), Simple Weapon Proficiency.

Advancement: By character class.

Equipment: Machete, leather armor, crossbow.

◆ VAASI WARHOUND

In the vaasi warhound, the vaasi have mixed their genetic code with that of a dog-like creature from their homeworld. Although it shares no actual genetic similarity to the terran dog, the result is a creature of above-animal intelligence, with speed, endurance and a strong set of teeth. Vaasi warhounds accompany soldiers on most missions and are nearly omnipresent in vaasi encampments. Unlike their canine analogs, these are not loyal animals. While not as intelligent as most vaasi servitor races, they are cunning enough to manipulate others into getting what they want. Warhounds steal, cheat, and are willfully disobedient as long as they think it will get them what they want. Warhounds are perfectly willing to kill other vaasi for food when needed, something that keeps the vaasi soldiers continually on their toes.

Vaasi warhounds are about the size of terran, large-breed dogs and have a similar snout structure, but there the resemblance ends. Like all vaasi races, warhounds have six limbs, but in the warhound they are all legs. The warhound possesses no limbs suitable for manipulating objects. The warhound has remarkable agility and stability, though, and can leap prodigious distances. The warhound's mouth is filled with sharp, black boned teeth that can easily chew through the flesh of most races. Their skin is the same gray, rough material that covers all vaasi.

Species Traits

Blindsight (Ex): Using echolocation a vaasi warhound can sense all objects within 60 feet.

Improved Low-Light Vision (Ex): A vaasi warhound can see ten times further than normal in poor lighting conditions. Vaasi warhounds cannot distinguish colors.

Increased Massive Damage Threshold (Ex): Due their strange physiology the vaasi warhounds gain a +3 species bonus to their massive damage threshold.

Light Sensitivity (Ex): Like all vaasi servitor races, a warhound is weakened by light, but not as much as its progenitors. A warhound suffers a -1 penalty to all attack rolls, saving throws and skill checks while in direct sunlight or other light sources of similar brightness. This cannot be alleviated except by seeking cover from the light. Lesser lights do not bother the warhound.

Skill Bonus: Vaasi warhounds receive a +6 species bonus on Jump checks.

Vaasi Servitor (Ex): A vaasi warhound must make a Will save to disobey a direct order given by a true vaasi (DC 10 + ½ the true vaasi's hit dice + the true vaasi's Charisma bonus).

Vaasi Warhound ◆ CR 3

Small aberration; HD 3d8+6; hp 19; MAS 17; Init +7; Spd 40 ft.; Defense 19, touch 14, flat-footed 16 (+3 Dex, +5 natural, +1 size); BAB +2; Grap -1; Atk +4 melee (1d6+1, bite); Full Atk +4 melee (1d6+1, bite); FS 5 ft. by 5 ft.; Reach 5 ft.; SQ; blindsight 60 ft., improved low-light vision, increased massive damage threshold, light sensitivity, vaasi servitor; AL vaasi; SV Fort +3, Ref +4, Will +5; AP 0; Rep +0; Str 13, Dex 17, Con 14, Int 5, Wis 14, Cha 6.

Skills: Hide +7, Jump +9, Listen +3, Move Silently +9.

Feats: Improved Initiative.

Advancement: 4-9 HD (Medium).

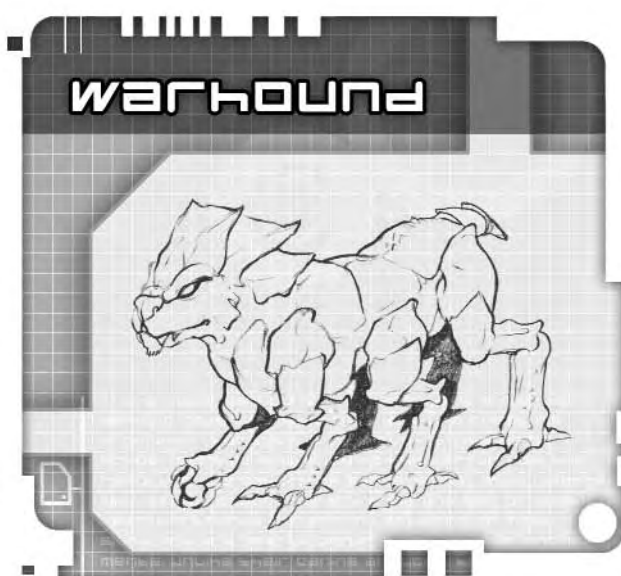
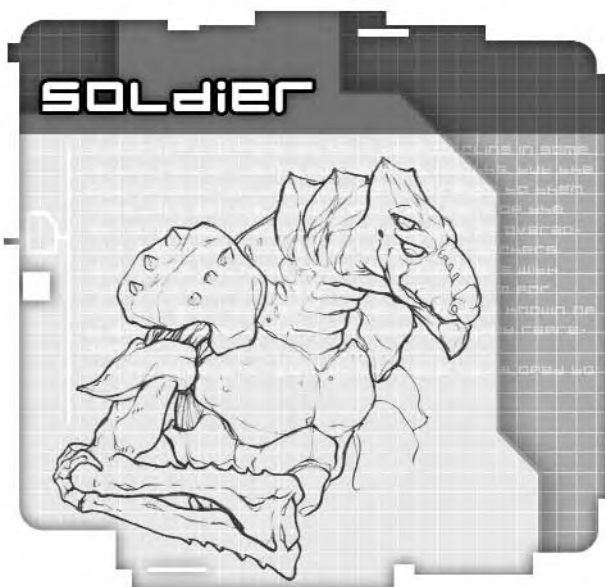



CHAPTER XVII

MASTER CONTROL

"So you're saying you've been here since the ruins were built?"

"Yes." Saerliv, Chief of the Winter Thunder tribe and member of the velin tribal council tightened his face into a bare grimace. He had answered similar questions many times, but the humans never stopped asking them. Never stopped pressing him, testing him as one might test a young warrior.

"So what happened? What caused the destruction? Do your legends speak of any cataclysms or such?" The questioner, a Professor Julius from some school on Dawning Star, was only the tenth to interview Saerliv about such matters. Like the others, he barely paused to permit an answer to the barrage of questions. Such was the curse of leading a tribe that spent most of its time near Dawning Star and the Council Ruins.

"War. With an evil that yet remains." Saerliv's face took on an even, serious cast. He did not dare let his annoyance temper the gravity of his statement.

Professor Julius moved on quickly. The darklings were still a delicate subject, and he had no desire to cut the interview short by some unintended effrontery.

"But why did you regress technologically?" he asked. "Your people clearly know how to use some of the materials from the ruins, but you don't have any other signs of the technologies that build them. Why no computers? Particle weapons?"

"We were here when the science you speak of reached the stars, but we were not here in the way you describe. You humans are too concerned with

the physical world and putting hard concepts into the form of simple truths."

Saerliv rested his wrinkled hand on the professor's. "Of all the ideas our peoples share, I think it is our respective notions of 'truth' that are most alien to one another. Truths are never simple. You were here too back in those ancient days, but you and your people have forgotten. We are warriors, not scientists or historians. Our job is not to find out way or to piece together the past. Our job is to safeguard good from evil. Nothing more."

Saerliv leaned back and took a drink of hot kowi tea from the bone cup at his side. Inevitably, this is where these interviews always concluded.

"So what is the evil you fight?" Professor Julius couldn't resist.

And Saerliv obliged: "The vaasi are evil. You call them darklings and laugh. That is because you are foolish and young in such matters. There will come a time when you stop laughing. You humans are our brothers, returning home after too long an absence. Soon our other brothers will return home and together, we will claim victory where there was once only defeat."

Saerliv finished his tea and set the cup down, his gaze hard and steady on the visitor, a stare that Professor Julius took as a sign this interview was over.

By and large, the humans of Dawning Star think they have a pretty good handle on their situation: a new world to inhabit and explore, curious but friendly indigenous neighbors, new challenges, and a highly advanced alien species of that seems benevolent. The truth is far more complex. This chapter lays out the full story behind the events on Eos, both in the present and the distant past. It imparts advice for GMs on running a *DAWNING STAR* campaign, complete with adventure seeds and tips on designing further adventures. Players are cautioned against reading further, if they wish to avoid having some of *DAWNING STAR*'s secrets revealed.

As with any RPG, GMs should feel free to discard any aspects of the Dawning Star background they don't like. This secret history of Eos brings a number of components into the setting that are not traditionally considered "hard science" and may not mesh with your particular campaign. In short, you should consider this a suggested campaign background, but feel free to take your own campaign in any direction you choose.

THE SECRET HISTORY OF DAWNING STAR • • •

The history of *DAWNING STAR* begins back in an age when the galaxy was much younger, long before Earth bore witness to even the most basic forms of life. During these early days, a number of sentient races developed in the Helios system and its neighbors. These six races established a large, interstellar confederation by building a network of gateway devices. It was this gateway system that was later employed by the *tentaari* and the *Dawning Star*. These six races lived in peace and prosperity for several million years, building massive cities on Eos, Thres, C'thalk, and several of the moons of Hesperos. They expanded the gateway network to include worlds where life might eventually develop and terraformed numerous worlds close to their power base on Eos. For thousands of millennia these six races, called the Star Confederation, had no enemies or rivals. Instead, the races they encountered were protected, even nurtured, as they attempted to find their own way to the stars. It was a time of peace and plenty in the galactic core.

Then, the *vaasi* arrived. An alien race from the edge of the galactic core, the *vaasi* were as technologically advanced as the Star Confederation, if not more so. But their technology was not constrained by any concept of morality. Much of their ships, weapons, and equipment were powered by tapping into the boundless energy of stars, literally sucking out their cores using an artificial wormhole. This process caused the star to explode in a supernova. The *vaasi* cared little for the destruction they left in their swath.

After the *vaasi* had wiped out several dozen solar

systems, some of which contained inhabited planets, the Star Confederation chose to act to defend those life forms that could not defend themselves. In a lightning raid on the *vaasi* fleet, the Star Confederation captured the *vaasi* star harvester device while it was being deployed to harvest another star. Unable to safely destroy the device due to the unstable artificial singularity it contained, the Star Confederation split the device into pieces and hid them on their most heavily fortified planets. The singularity itself was hidden on Eos, deep within one of the planet's fortified cities. The Star Confederation then contacted the *vaasi* and offered to help them find another way to power their society. The *vaasi* response was a swift, brutal attack on the Star Confederation. The war that followed lasted tens of thousands of years and dragged several other neighboring, less advanced species into the conflict, including the *tentaari*. As a last ditch effort to defend Eos - the capital of the Star Confederation and resting spot of the *vaasi* singularity - the Confederation deployed an experimental bio-weapon that rapidly corroded the hull of any ship entering the atmosphere. The *tentaari* were given the means to bypass this defense system, and the humans later learned the secret when they salvaged a crashed *tentaari* ship on Eos. This last ditch effort did slow the *vaasi* assault on Eos, but it could not turn back the dark tide of the *vaasi* force. Millions died in the final battle, and once victorious the *vaasi* assault force found themselves without sufficient resources to leave.

Eventually the Star Confederation fell to the *vaasi* crusade, the six main races hunted to near extinction. Luckily for the *tentaari* and those allied with the Star Confederation, the *vaasi*'s final victory exhausted their last star-heart, and their war machine ground to a halt before they could pursue the Star Confederation's allies. Unable to press their advantage, the *vaasi* forces were left stranded on the worlds they had invaded, unable to be return to the *vaasi* homeworlds. In turn, these strongholds quickly began to degrade as their technologies failed without power. The *vaasi* victory was an empty one, and the once-mighty *vaasi* empire quickly fell into decline.

The Star Confederation had long feared that it would eventually fall to the *vaasi*, so it took several precautions long before its defeat to ensure the Star Confederation would survive in some form. First, the Star Confederation used the gateway network to seed a number of suitable worlds with genetic material designed to influence the development of life on these planets. The genetic material was engineered from all six races of the Star Confederation to ensure these worlds would evolve with a mixture of all of their traits. Additionally, these descendant races were given genetic information so that, when they eventually did encounter one another, they would be predisposed to comprehend and cooperate with one

another. The six races of the Star Confederation were: a race of mammalian humanoids, a race of giant reptiles, a race of insectoids, a race of intelligent plants, a race of mineralized creatures, and a race of creatures partially phased between two dimensions. From a combination of these six races, all the races now found in the Helios system evolved. All, that is, except the tentaari.

THE TENTAARI • • •

During the latter half of the war with the vaasi, the tentaari were one of the Star Confederation's ward species and were protected from the worst of its ravages. During the final days of the struggle, the tentaari were charged with keeping the lore and technology of the Star Confederation safe, so that the descendant races could eventually learn of their heritage from the tentaari. The tentaari agreed, but in the years that followed the fall of the Star Confederation they found themselves overwhelmed by the task. They were like kids who had been given keys to the toy store, and they couldn't play with all the toys fast enough. The tentaari were far more concerned with what they could do instead of what they should do—a flaw they bear to this day. They made regular use of the gateway system. They recalibrated the system, setting all the entry points in the seeded systems to take any ship to a specific habitable world, such as Eos. Ostensibly, this was to help fledgling races make their way around the galaxy by creating natural preserves for them. In truth, it simply facilitated their diversions. With the vaasi threat having faded from their memory, the tentaari quickly became obsessed with their own power and largely ignored their charges. Over time, they transformed from a society of hard-working scientists and laborers to a decadent culture, where the need for research had evaporated. For millions of years, the tentaari lived in luxury, occasionally checking up on other races using the gateway network. They did little to preserve the technology they then possessed.

Eventually, the tentaari's decadence caught up with them as the Star Confederation technology began to fail. The tentaari had not dedicated much effort to keeping relics like the gateway network in proper working order. One by one, network waypoints began to fail, starting with the most commonly used ones. The tentaari no longer had the means or the knowledge to repair this damage. They slowly began losing territory, as system after system lost their entry point to the gateway network. The tentaari eventually recovered enough knowledge of the gateway network to stop the degradation of the system, but not soon enough. Many of the waypoints were fully inoperable; some became an exercise in randomness. The tentaari themselves ended up scattered about the galaxy. Similarly, as the descendant species developed, many of them

encountered the network inadvertently and with disastrous results. Several were drawn by sheer happenstance to the Helios system. Those tentaari surviving outside the Eos system control only a handful of worlds and are obsessed with saving their own technology. They care little for their brethren who may be stuck in backwater systems by the failing gateway network. They are only concerned with their own survival.

When the Helios system waypoint failed there were only three tentaari ships in the system carrying out survey duties on the saurian homeworld. These ships remained trapped in the system ever since, though one was shot down by vaasi on Eos. In the years since, the tentaari have been trying to find a means to repair the entry point to the gateway network, but have had no success due their lack of knowledge and an industrial base to construct the needed parts. The tentaari in the Eos system, like many of their race, had lives of total leisure before being stuck in the system. While they have toughened up in the intervening years, they know how to fix little of their technology. Their demonstrations of advanced technology to the races of Eos are meant to cow these races and make them fear the tentaari, while the tentaari are holding their two remaining ships together with spit and hope. Now, more than ever, the tentaari are a shell of their former selves. The ingenuity and diplomatic nature of the humans has caused the tentaari to hope that maybe the humans can fix the entry point if given the right encouragement. So the tentaari have given preferential treatment to the humans. They play a delicate balancing game, trying to maintain an air of superiority while seeking the assistance they so desperately require.

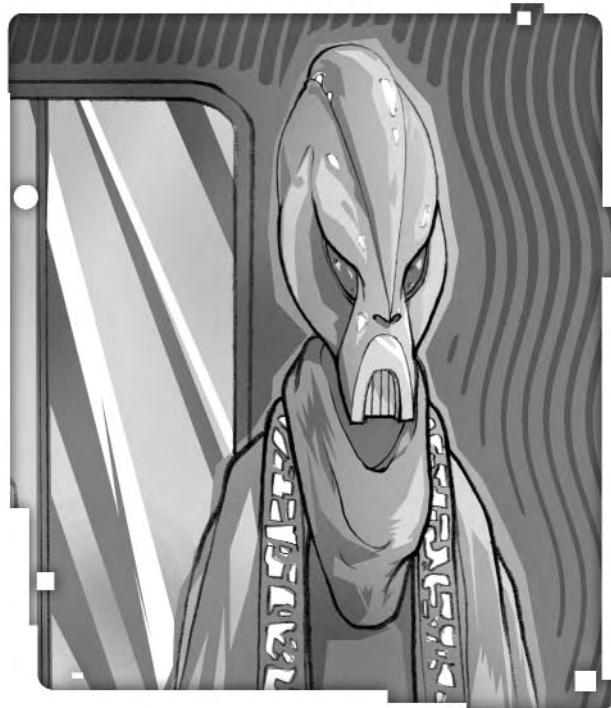

THE VELIN • • •

Humans and the species found on Thres and C'thalk are not native to the Helios system. They are all descended from the bits of genetic material that the Star Confederation inserted into the early ecologies of their homeworlds. The velin, on the other hand, are the true sons and daughters of Eos. They are products of cloning banks beneath the surfaces of Eos, created by the Star Confederation in the hopes that the population of Eos could be quickly restored if it were wiped out. The cloning banks could also be used to create an army of warriors with an innate hatred of the vaasi and an instinctive ability to combat them. The cloning banks on Eos were damaged during the last days of the war and activated long after they were supposed to. The velin they produced awoke far too late to help in the war with the vaasi. In fact, it was the arrival of the *Dawning Star* that stirred them into activating. Because humans were part of the Star Confederation seeding project, the velin were engineered to be compatible with them. As of the humans' first arrival on Eos, the velin had only been active for less than three years, but they possess an implanted memory of their Star Confederation forefathers, Eos, and the vaasi. When the velin emerged from their clone tanks they did so at differing ages and with different specific memories, creating the illusion of a preexisting culture and social structure. Because of this, the velin have a completely formed society after three years and are startlingly homogeneous in their beliefs. Over time, the velin will begin to diverge along geographic lines. For now, the world over, they all speak the exact same language, engage in the exact same customs, and tell the exact same legends—something that the humans who have studied them find very strange. The velin believe they have been on Eos all along, and their memories support this concept, even if all the pieces of the puzzle cannot be reconciled. Velin who have particularly strong memories of the Star Confederation are often thought of as prophets among their own people.

THE VAASI • • •

The vaasi are the “darklings” of Eos, hiding in the shadowy places of that world, a bare skeleton of the fearsome star-harvesting race they once were. The vaasi on Eos have been stuck there for millions of years and have lost almost all of their technology to age and wear. They had originally sought to return home, but hold little hope of that now.

Meanwhile, the vaasi worlds on the edge of the galactic core have not been idle. They have managed to convert some of their technology to other forms of power. However, they still lack the power of a star-heart and have been unable to achieve their former place in the galactic power structure. The vaasi have not been able to replicate the arti-

cial singularity used in the original star harvester, and have been unable to find an energy source of equal power. Luckily for the vaasi, they are a forward thinking race: Shortly before the last of their energy reserves died off, they launched a fleet of sub-light sleeper ships toward Eos in a last ditch effort to ensure the destruction of the Star Confederation, even though it would take millions of years before the ships reached their destination. No longer able to utilize their own gateway network due to lack of energy, they used what low-tech means they could to make a last grab at finding their star harvester and ensure the ultimate victory over the Star Confederation. These ships, in transit for several million years, are just now reaching Eos. At the beginning of the campaign timeline, the vaasi have begun building dome colonies and bases on the edges of the Helios system, hoping to eventually sneak onto Eos and look for the piece of the star harvester hidden there.

The vaasi lurking on Eos remain in the shadows of the world, using a large network of subterranean tunnels and Star Confederation ruins to remain underground. The vaasi initially stayed underground to avoid the sun, which they find painful and annoying, but now they also seek to avoid the velin and the humans that have suddenly appeared on the surface of Eos. The vaasi have claimed many of the Star Confederation ruins as their own, killing those relic hunters they come across to keep their existence secret. The vaasi know that the humans will try to wipe them out if they learn of the vaasi presence on Eos, and while the vaasi are equal to the humans in numbers they lack their opponent's strong industrial base. This, combined with the velin presence and predisposition against vaasi, means that the vaasi must hide and bide their time until they can make a concerted strike against their new enemies. However, the vaasi are a fractious and ambitious species. They fight among themselves as much as against their true enemies. A handful of true vaasi struggle for leadership of the entire population, each “warlord” commanding their own faction of soldiers, phrenics, and warhounds. For now, the vaasi are more interested in fighting among themselves to see who will lead them against the humans. Once the Cronus Belt vaasi make contact with them, the vaasi on Eos will fall quickly under the sway of their better equipped brethren.

THE RUINS OF EOS • • •

All the various ruins of Eos are remnants from the Star Confederation that have survived the millions of years since its collapse. While the Star Confederation had knowledge of building materials that could withstand such a long period of time, many of the more fragile artifacts—such as computers—have not survived the intervening years. The occasional relics found by explorers are the only

remains of the once powerful Star Confederation technology that could, in its day, literally create life from nothingness.

The ruins themselves are found in three varieties as discussed earlier in this book. The most common are city ruins, which are the once great cities of the Star Confederation. Most of the buildings are comprised of materials with a hardness in excess of 40 and with 20 hit points per inch of thickness. City ruins rarely show much damage from battle. Instead, the inexorable assault of erosion is the main cause of their destruction. City ruins are usually made up of several structures, each several hundred stories tall and several miles across at the base, forming something resembling a giant skyscraper. These buildings once were arcologies made largely of transparent materials so that those who lived within could see the world beyond. Now, most of those transparent materials have been destroyed, leaving only a strange metal skeleton still standing. City ruins are labyrinthine and complex, each holding tens of millions of inhabitants in their heyday. A single ruin can take years to explore thoroughly, though most visitors are not so patient. City ruins often hold the remains of vast transportation networks, from personal vehicles to hovertrains to the rare transport pads that allowed instantaneous translocation. Few of such vehicles are still functional and as yet no functional transport pads have been found. Most of the relics found in city ruins involve communication, healing, information, or entertainment. The velin often live on the edge of city ruins, and many creatures have made them their home. The vaasi are rarely found in city ruins unless they have an extensive subterranean area. City ruins are found all over Eos, even in the ice of the polar regions.

The fortress ruins that dot Eos are the remains of the Star Confederation's military bases and its last line of defense on Eos. These ruins tend to be one giant structure made of heavily armored material that has a hardness of 60 and 30 hit points per inch of thickness. This armor plating, called ceratinum by the Star Confederation, is a special metal made by nanites that is currently beyond the ability of anyone in the Helios system to produce, damage, or manipulate. These structures show signs of heavy battle damage but have suffered little wear and tear over the years. All the fortress ruins were the sites of huge battles during the final days of the Star Confederation. Some signs of these battles still remain, but most have been swallowed by time. The fortress ruins are the preferred haunts of the vaasi due to their strong defenses, resistance to orbital bombardment, and extensive subterranean spaces. Invariably, the vaasi have picked clean the useable relics from the ruins they inhabit. When relics are found in fortress ruins, which is rare, they are normally weapons, armor, or some other type of equip-

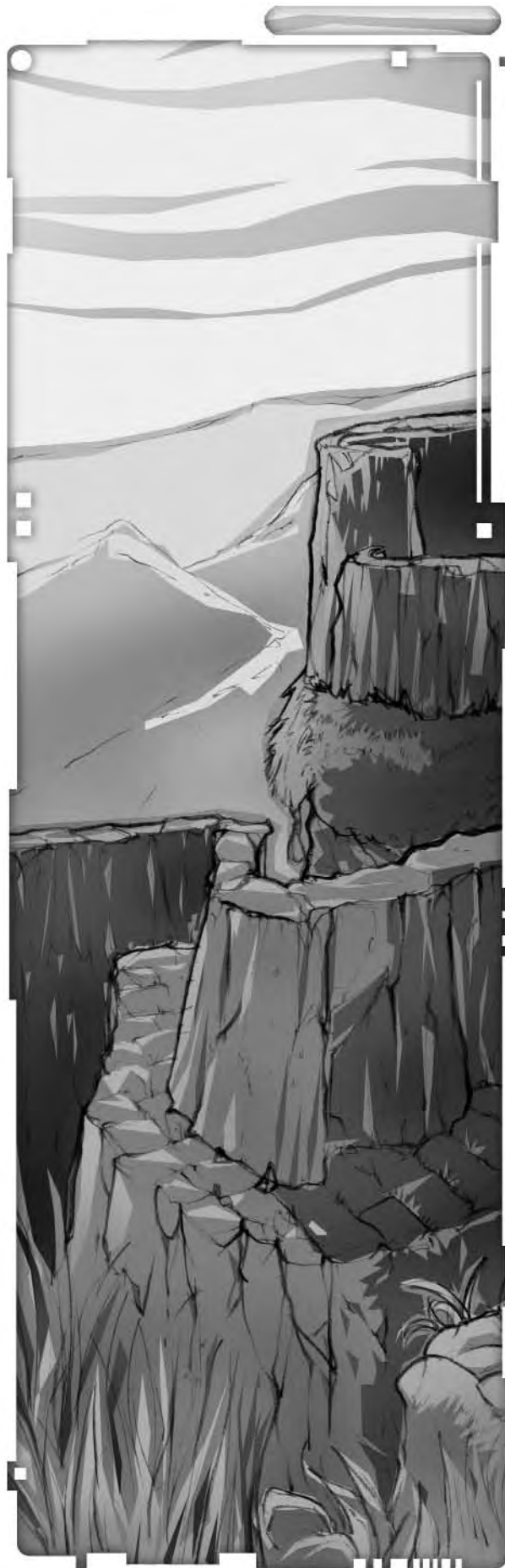

ment related to warfare. Many of the relics collected by the vaasi are discarded if they run out of power or cannot be used. This practice has resulted in large stockpiles that are a relic hunter's dream.

All spacecraft and large combat vehicles have been destroyed or cannibalized for parts by the vaasi, except for a number of mechs which the vaasi have not been able to gain access to. These weapons were developed late in the Star Confederation's war with the vaasi. They are exotic mechanical-organic hybrids with an intrinsic resistance to the vaasi. Only one of these relic mechs has been discovered by the humans or velin, but even its fully secrets and power have not been tapped.

The council ruin is the only building of its type on Eos. It once served as the center of the Star Confederation, delegates from hundreds of planets meeting within its walls to discuss the issues they faced. The council ruin once supported a population of over 30 million, most of which were bureaucrats involved in day-to-day government operations. It was one of the last settlements to fall in the final assault by the vaasi, and it shows signs of heavy damage, though all bodies and other remains have long ago rotted away. The vaasi stay away from the council ruin and believe it to be haunted by the angry spirits of the Star Confederation. In fact, it is protected by a number of advanced security systems that still seek to protect what is stored deep beneath: the unstable singularity of the vaasi star harvester. The vaasi are not aware this is where the singularity is located, but if they were to find out they would attack the ruins with every soldier they could muster in order to get the singularity back. Alternately, the singularity might be used to repair the gateway network station in the Helios system, but even the tentaari do not know the location of the singularity or how such a repair would be accomplished. The council ruin holds a massive amount of information leftover from the Star Confederation and contains a number of relics, but thus far the Dawning Star Republic has limited exploration until archaeological teams escorted by advanced military units can inspect it in depth.

As yet no large human settlements have appeared in any of the ruins, but relic hunters have set up a number of temporary settlements and a number of major faction camps are located in close proximity to ruin areas. Most humans consider the ruins creepy and are rarely comfortable there, while the velin consider them holy sites that may be utilized for shelter and resources but always must be respected. Among both groups, the ruins of Eos are considered dangerous places one does not visit lightly or without weapons, as a number of native creatures have taken up residence within. No transplanted earth species have yet to inhabit any of the ruins, but this expected to occur in due time.

The ruins of Eos can serve a number of purposes for Dawning Star campaigns. In political campaigns, they can serve as background elements in which relics are occasionally found that swing the balance of power between competing entities. In exploratory campaigns, they can serve as areas to be investigated and sources of information about Eotian history. In military campaigns, they become battlegrounds against the vaasi or the faction camps as soldiers fight for the technology and strategic value of the ruins.

CAMPAIGN CONCEPTS • • •

The DAWNING STAR setting contains a number of conflicts and themes that can be incorporated into any campaign. Some of these ideas are discussed below to provide a jumping off point for GMs on what direction to take their DAWNING STAR campaign.

◇ AGAINST THE VAASI

The vaasi are the largest military threat faced by the Dawning Star Republic and its allies. While the vaasi have been quiet for many years and only made a few incursions into human lands, they will not remain so for long. They will continue to test the mettle of these visitors. Eventually, they will strike out at the humans, the hated descendants of the Star Confederation, rekindling a war that already wiped out two civilizations and has lain dormant for millions of years. While the vaasi on Eos are not well equipped and have few pieces of advanced equipment, those on the edge of the Helios system in the Cronus Belt are much better prepared. War is coming to Eos; it is only a matter of time. Because the key component of the star harvester lies in the belly of the planet, the fall of Eos could mean the rebirth of the Vaasi Empire and the renewed destruction of star after star.

If combat against the vaasi is a primary theme, the campaign will have a heavily military tone similar to films such as *Aliens* and books like *Starship Troopers*. As the vaasi from the Cronus Belt get involved, space combat will likely become a factor as well. Characters could even travel to other worlds in the Helios system looking for resources and allies. Details of the system will appear in DAWNING STAR: HELIOS RISING. As characters learn about the history of the aliens they are fighting, the campaign may well turn epic in scope. They are not only fighting to protect their own colony, but the very galaxy. Characters in campaigns concentrating on combat against the vaasi are likely to be members of the Dawning Star military, grizzled velin warriors who join the cause, or faction-camp soldiers who realize the need for a unified front against this common enemy.

For players who are looking for a campaign with tense missions, hunting through ruins for alien strongholds, large battles with armored vehicles,

and blazing dogfights against alien craft, this campaign model is an excellent fit.

◇ BUILDING A NEW WORLD

As far as the humans of Eos know, they are all that's left of the human race. While there were nineteen other ships in the evacuation fleet, the fates of these ships are completely unknown. This drives many of the colonists to go to extreme lengths to make sure their colony survives, since it may very well be the last pocket of human life in the universe.

Campaigns that concentrate on building a new home for humanity on Eos will involve protecting settlers from native threats, helping clear and explore land for settlement, finding resources and enlisting allies, and guarding against all other threats including themselves. These campaigns are likely to involve a number of different adventure styles depending on the needs of the colony at the time. Conflict against the environment takes on a major role in such campaigns, as the characters heroically struggle to tame an alien world full of new and strange threats. This type of campaign will remain primarily on Eos. However, off-world missions may become necessary for badly needed resources.

Rebuilding campaigns can be run with a darker, starker tone by concentrating more on the basics of survival than building a new home for humanity. In such campaigns, finding enough resources to meet the basic needs of the colonists is a daily challenge as characters seek out new food sources, clean water, and raw materials to keep their fellow colonists alive. In such campaigns, the industrial, economic, and military power of the Dawning Star Republic should be stripped to its barest limit. Alternatively, the campaign can focus on a single, remote settlement with little assistance from the Republic. In survival campaigns, characters will be regularly forced to make hard decisions that govern the lives and deaths of others. Trapped on an alien world, hard choices must be made if humankind is to survive.

Combat is likely to be a minor part of campaigns about settling Eos. While combat may occur with native creatures or faction-camps bandits, more often conflict will be in terms of interpersonal conflict or conflict against the Eotian environment. To survive, the colonists must work together, and even on Eos that is often hard to achieve. Characters must become organizers and leaders to keep the people of Eos safe. Terraforming may be a vital part of this campaign type as the characters work to fine tune the world they have inherited.

For players who like low combat campaigns that require leadership, ingenuity, and determination this is an excellent campaign model.

◇ DAWNING STAR VS. FACTION-CAMPS

The primary political dispute on Eos is between the Dawning Star Republic and the faction-camps. Dawning Star is a very ordered and lawful society that, while not tyrannical or despotic, does not allow one the open freedom found beyond its borders. Firearms are severely restricted in Dawning Star, everyone has to pay taxes, and each year the bureaucracy of the city grows. Some colonists miss the freedom of the earlier days of the colony and leave Dawning Star for the faction-camps, trading security and ease for freedom. Others leave Dawning Star to avoid criminal prosecution or to pursue an illicit career where the laws are looser. Unfortunately, most faction-camps are dominated by this second group, many of whom hate the Dawning Star Republic for real or perceived slights and seek to thwart it at every turn. While the faction-camps cannot compete directly against the Republic in terms of military or economic might, they strike back in a number of small economic ways, such as claiming rare resources of valuable territories or interrupting the flow of regulated trade. The Republic usually ignores these challenges, hoping to win the faction-camps back through the promise of economic prosperity, but any violent attack against the Republic or its people receives a violent response. For now, the Dawning Star Republic and the faction-camps are in something of a cold war with neither side wanting to push the other too hard.

In this tense state, characters can become involved in a number of non-military conflicts between the Republic and the faction-camps. Espionage missions are common on both sides, usually in the hope of acquiring relics or advanced technologies. Diplomatic missions are also common, but these are usually empty affairs that serve more as cover for espionage than any real attempts at settling differences diplomatically. Neither group wants open conflict. The faction-camps know they will lose in a face-to-face battle, and the Republic wants to avoid unnecessary death and destruction. Many fear that a civil war is inevitable. The faction-camps will certainly start such a conflict, if they find a relic or other advantage that gives them power over the Republic, and the Republic itself might engage in a pre-emptive strike, if they learn of the faction-camps' own plan of attack.

Characters in a campaign that concentrates on the conflicts between the faction-camps and the Dawning Star Republic will likely be spies, diplomats, or special forces soldiers on either side of the conflict. A mercenary lifestyle is also an exciting option, where the players switch sides several times during the course of the campaign. This type of campaign will likely be one that escalates slowly, beginning with espionage missions and quests for technology, leading to full-blown war once some

crucial advantage has been gained. Such a war could eventually doom the human race, so ending the war quickly with minimal loss of human life is likely to be a primary goal, at least amongst those participants who can see a larger picture. Unfortunately, not all the faction-camps are so enlightened.

For players who want espionage, politics, and combat this is an excellent campaign model.

◆ **EXPLORATION**

Much of Eos has not been explored by its new inhabitants and most of the Helios system has only been observed from afar by the *Sadler Orbital Facility*. Between the many ruins of Eos, the vast stretches of unexplored wilderness, and the neighboring worlds, there are a vast number of places that the characters can be the first to explore. While campaigns exploring Eos should find sufficient information for doing so in this book, exploring the neighboring worlds will be made easier with *DAWNING STAR: HELIOS RISING*. Such a campaign might begin with an exploration of Eos, only reaching the stars after gaining access to some long lost starship.

As a campaign theme, exploration might encompass the widest variety of adventure types, provide the easiest adventure structure, and still tie deeply into the core concepts of *DAWNING STAR*. Exploration campaigns can be a mixture of combat, problem solving, and interpersonal interaction as the characters must combat strange native beasts, avoid traps both natural and artificial, and deal with the intelligent species they encounter. There is vast wealth and artifacts of power hidden in the unexplored regions of Eos. The human settlers are constantly expanding their territories, and they need brave souls to find new lands suitable for colonization. Finding out the true history of Eos and its neighbors cannot be done sitting safely in *Dawning Star*. Exploration campaigns provide easy concepts and hooks for adventures, because there is always some region of Eos that needs to be explored. Characters in exploration campaigns never simply find a hospitable valley after a single day's trek; they find a valley containing ancient ruins that beg to be explored or are home to a nest of exotic creatures. At the end of each adventure, the heroes return home and plan their next mission, creating a very easy structure within which to frame adventures.

For characters who want to experience a wide variety of adventures in a wide variety of locales, the exploration campaign model is an excellent choice.

◆ **RECOVERING THE PAST**

While there is a lot of terrain that is left to be explored on Eos, there also remains a lot of history and information to be uncovered as well. The humans and the velin have little idea of the sheer number of secrets to be revealed on Eos and what

role they play in its history. Discovering the complete history of Eos will require far more than scholarship. It will require penetrating ancient ruins, deciphering ancient texts, hacking into long-dead computer systems, and dealing with aliens who are not nearly as benign as they seem. In short, finding out the true history of Eos and the Star Confederation is not a task for bookworms and academicians, but adventurous scholars with a gun and computer in hand.

This campaign theme can easily be tied in to the other campaign themes described in this chapter, and any campaign will eventually reveal some of the planet's secrets. In other campaigns, these secrets will not be the focus of the campaign but will serve as plot devices to move the campaign forward. In other campaigns, historical information is more a means to an end. In campaigns where uncovering the past is the focus, the discovery is itself the grand prize.

Adventures in historical campaigns are likely to run the gamut from combat-heavy trips into vaasi-inhabited ruins to diplomatic missions with velin tribes in the hopes of acquiring information on their myths and legends. Historical campaigns usually require some sort of instigating element, some piece of revelatory data that spurs the characters to dig deeper. This information might come from a backer, who wants to piece together the Eotian past, or the recovery of some artifact that raises more questions than it answers. Recovering pieces of information on the Star Confederation makes an excellent lure for such a campaign. While the humans of Eos know that it was once inhabited by very advanced beings, they do not realize they are in fact related to these beings and have no knowledge of the war that killed off the original inhabitants. Finding out the true history of Eos will cause a great shakeup of accepted ideas and beliefs among the Eotian inhabitants as entire concepts about life, humanity, and its place in the universe are shifted.

Players interested in discovering secrets, figuring out puzzles, and a variety of adventure styles are well suited to a campaign model in which they rediscover the lost history of Eos.

ADVENTURE HOOKS • • •

Listed below are a number of suggested adventure hooks that may help GMs develop adventures for *DAWNING STAR*, using the tips found in *D20 MODERN*.

◆ **"CATTLE DRIVE"**

Murcows are a major source of food, leather, and economic prosperity on Eos. Many outlying settlements rely on murcows for their livelihood, and these beasts have to get to market somehow. Due to the lack of roads and ground transportation, this is usually accomplished by ranchers making a cat-

tle drive to Dawning Star or Iron Scar. Such trips are fraught with dangers, from rustlers to alien monsters to severe weather. Due to the danger, ranchers are nearly always looking for a few more hands to help out.

The heroes are hired on to help drive a group of murcows to market. En route, a terrible storm separates a pack of the beasts. The head rancher directs the PCs and his right-hand man to go track them down. A few miles off the path, they discover the murcows, slaughtered and eviscerated by some unknown creature.

◆ "A COLD PLACE TO DIE"

While the polar regions of Eos are not heavily populated, there are ruins to be found there as everywhere on Eos. These ruins are often the least picked-over by hunters or the vaasi, making them one of the richest sources of relics. Unfortunately for would be relic hunters, if their transportation breaks down they may be in for a long, cold time. Hostile xenomorphs can only make things worse.

The heroes are on a relic hunt in the coldest climes. They happen upon a subterranean ruin. After they enter, a large elephant-like creature destroys their vehicles. Their efforts to radio for an extraction team get nothing but static. Their predicament is compounded by the true vaasi compound located in the depths of the ruin.

◆ "SUN CITY HOLIDAY"

Sun City is one of the few settlements seen as neutral ground by the Dawning Star Republic and the faction-camps. Because of this, it is a hotbed of espionage activity, a sort-of modern-day Casablanca. This creates an environment where everyone is constantly spying on everyone else, but also has created an odd conduit of communication between the Dawning Star Republic and the faction-camps. Several times the groups have traded messages through these Sun City back channels. There is always some spy being hunted or some secret sought on Sun City, which becomes all the more difficult when one of the tourists becomes involved. Player characters in Sun City are likely to get wrapped up in espionage without even trying.

The heroes are on a much-needed vacation in the resort city. A pleasant day at the beach turns sour, when a mysterious woman approaches one of the PCs, hands him a microdisk, and promptly disappears into the ocean. Finding out what's on the disk is just the beginning of their troubles.

◆ "THE LOST CITY"

There are many settlements on Eos beyond the bounds of the Dawning Star Republic that have not attained the size or recognition of the larger faction-camps. These settlements are often called "no-

name" towns, and they often come and go with the fortunes of those that call them home. Some are wiped out by severe weather, others by local life forms, but some fall victim to more sinister attacks by raiders or vaasi. The Dawning Star Republic is always interested in what happens to even the smallest settlements, knowing that the future of the human race rests on every life.

The heroes are hired on as a freelance investigation team to explore the loss of communication with a no-name in the forest west of Lanner's Crossing. The trek is long and arduous, but when they reach the town they find nothing but bodies.

They bear no wounds but their skin has become black and hardened.

◆ "DEATH IN DAWNING STAR"

While crime exists in Dawning Star, actual murders are rare. When murders do occur it is usually a crime of passion or mental derangement, and the only cases of repeat offenders have been vaasi infiltrators and the legendary Shadow Jack murders. If a new string of murders beings, in Dawning Star, there is likely to be panic and a strong reaction from the government. Such murders are likely to be the work of the vaasi somehow, but tracking the culprit down may prove most difficult. Player characters who are citizens of Dawning Star or members of the Republic military may be called up to help with the investigation, especially if they have experience with some of the stranger life forms on Eos.

The first death caused quite a stir in the small Italian neighborhood. An old woman found dead and horribly disfigured. The second, however, caused a minor panic. A second old woman found just as the first. Who is slaying the elderly women of this small, peaceful section of Dawning Star? And, as important, why?

◆ "THE MAGNIFICENT 7.1"

No-Name towns often have to deal with problems completely on their own, which can prove disastrous when faced with bandits, native monsters, or even vaasi. Their remoteness can be a haven for the unscrupulous and power-mad, seeking to take advantage of the weak.

The heroes are traveling the remote regions of the land and inadvertently stumble across one of these small settlements. They are overwhelmed by the hospitality of the locals, who seem overjoyed to see them. The reason for unmitigated generosity is revealed when the inhabitants offer their family heirlooms and other precious items in order to gain assistance standing up to the a tyrannical gunhand and his cutthroat minions, who rule over the town and a few others in the vicinity.

◇ "TREASURE HUNT"

Whenever new relics or crashed spacecraft are found on Eos, there is a race between the faction-camps and the Dawning Star Republic to see who can claim the prize first.

When these items are found in particularly remote locales, this makes the process even more difficult, requiring both groups to bring in specialists and other outsiders to help them win the race. Player characters may be hired by either side to recover the item, or they might be the ones who recovered it and must now decide who gets their discovery, even as they are beset by others who would wrest it from them by force.

An unidentified incoming object crashes in the peaks of the northern tip of the Iron Scar Mountains. The Dawning Star Republic instructs a local EDF squad to explore and recover the mysterious object. Unfortunately, the communiqué is intercepted by a faction-camp hacker in Rogers Point. They send out their own team, and the race is on. One of the heroes is listening to a music data file, when interference from the Iron Scar Mountain causes the message to play in his headphones.

◇ "LASSITER DOWN"

Spacecraft are one of the most valuable resources on Eos due to their rarity, and when one crashes every group on the planet pays attention. After the crash of the Republic ship *Lassiter*, both the Republic and the faction-camps race to be the first to get to the landing site and recover both the crew and whatever may be salvaged from the ship.

The heroes are serving aboard the *Lassiter*, when a rust spore breach causes it to plummet to the earth on the southern coast of Dawnhome. They're the only survivors of the crash and now find themselves alone and with limited resources. The Republic picks up the distress signal and sends a rescue party, but they're not the only ones interested in the crash. Scavengers from Steel End find the streaking light impossible to resist. Worse yet, a vaasi collective is nearby and goes to investigate.

◇ "X MARKS THE SPOT"

Relics are some of the most highly sought after items on Eos due to the fact they cannot be replicated or created given current technological levels. Instead, they must be salvaged from the ruins of Eos, driving hundreds of relic hunters to the ruins each year looking to make their fortune. Many of these hunters are killed each year by spitter spiders

and other creatures, while others die of exposure and starvation. The miniscule few who do return home with a relic often become wealthy enough to encourage a whole new wave of relic hunters the following year. Player characters may be hired on to help a group of relic hunters or undertake their own expedition, but in either case they are certain to get more than they bargained for.

The heroes are on a mundane trek when they happen upon a blood-streaked pack. Several large slashes on the fabric give some indication of what happened to its owner. Rummaging through the pack reveals a few glowsticks, some protein bars, and a curious map with a large "X" on it and the curious notation "Hyper Light Shield."

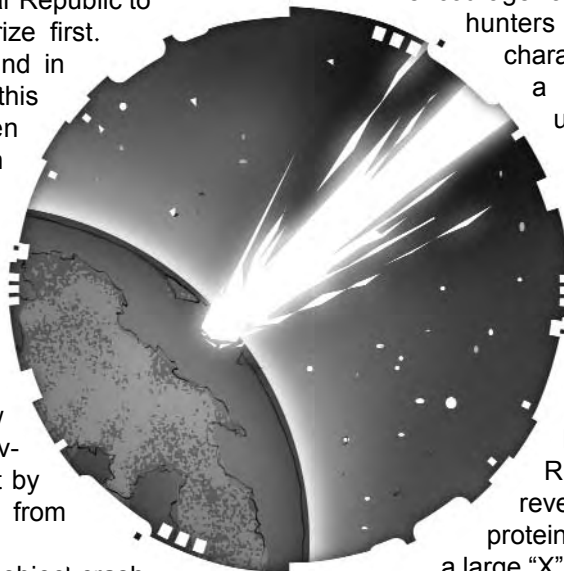

◇ "WHAT'S THE FREQUENCY?"

In a strange, new world, even the mundane and innocuous can be off-putting or distressing. A lost dog. An early nightfall. A phantom radio transmission. Are they the product of mere chance? Or is something more nefarious afoot?

In a remote area of Eos, the heroes are scanning for a weather report when they pick up a strange broadcast, the source of which is unknown. It could be a distress call from a human settlement, a locator beacon from a tentaari probe, or even the vaasi testing out some ancient communication gear. It's a simple matter to modulate the receiver to track the location of origin. Who know what they'll find if they succeed.

◇ "ON SACRED GROUND"

The velin have a deep and complex system of spiritual beliefs. While some humans have studied these beliefs and the Dawning Star Republic has worked to ensure respect for the velin and their ways, misunderstandings do happen. If player characters find themselves trespassing on holy ground or committing some other sin, they may have to atone for their deeds by performing feats of endurance and penance in order to purify that which they have tarnished.

The heroes are on a simple trading run through velin territory, when they find themselves surrounded by a score of the Eotian natives. It seems they have stumbled onto a velin proving ground, reserved for rites of passage into adulthood. The chief is friendly but stern. Each of the heroes must pass the test as well. If they succeed, they'll have made a strong ally, but if they fail....



CHAPTER VIII

A DAY IN THE LIFE



D.S.R. Terraforming Outpost 10-16
AUTHORIZED PERSONNEL ONLY
TRESPASSERS
WILL BE PROSECUTED

D.S.R. Pen. Code #714.1004



"A Day in the Life" is an introductory adventure to provide GMs with a helping hand starting a campaign and communicating the feeling of the setting to the PCs from the start.

IF YOU'RE NOT A GAMEMASTER, STOP READING NOW!

The adventure is intended for four 1st-level characters of any class or species combination. For larger and smaller groups or for groups of different levels, the adventure is easily scalable. For encounters that involve level-dependant variables - such as combat - three options are listed. For groups of six or more players or characters of 2nd-level, use the [HARD] option for each encounter. For a group of four or five 1st-level characters, use the [AVERAGE] option for each encounter. For a group of less than four 1st-level characters, use the [EASY] option for each encounter.

ADVENTURE BACKGROUND • • •

Two days ago, a group of relic hunters and Eos Freedom League members calling themselves "Spelter's Finders" found a strange, rod-shaped relic in a ruin east of Iron Scar. The rod is, in fact, a weather-control device, used by the ancient Eotians to disperse the violent storms that often rocked the planet. The Finders fooled around with several of the dials on the relic, to no apparent effect, before giving up. So the Finders started back to Roger's Point, not paying much attention to the growing cloud cover that seemed to be following them through the desert east of Iron Scar. When the rain started, they realized this was an odd occurrence outside of the rainy season, but continued on. When the full-on thunderstorm began and the Finders witnessed their first flash flood, they decided to look for shelter.

The shelter they happened upon was a terraforming outpost of the Dawning Star Republic. The outpost staff were in the process of battening down the hatches to avoid flood damage and had just begun taking atmospheric readings to try and determine the cause of the unusual storm activity. The Finders managed to bluff their way inside, claiming to be lost ranchers. However, shortly after arriving, the terraformers detected a strange energy reading coming from the weather-control relic. They tried to investigate further, but the Finders thought they were trying to steal the relic, and a fight broke out. During this fight, several of the terraformers were killed or injured, and the weather control relic was damaged, making it impossible to shut off. In addition, the terraformers were prevented from their duties overseeing the atmospheric converter; it is slowly building toward an explosive overload that will destroy the outpost, kill everyone inside, and poison the raging waters around it. These toxic chemicals will then flow into the water supply for Iron Scar, killing or injuring thousands of people.

The rising waters in the area have caused several creatures to seek out higher ground, including

the land surrounding the terraforming outpost. These animals are frightened and hungry, and several of them are injured, so they are not in the best of moods.

The Finders have used the radio in the outpost to call for extraction by the Eos Freedom League; however, due to the weather, the extraction team has been delayed. Two hours after the PCs arrive, a Dromedary air cargo hauler arrives with four Eos Freedom League soldiers and a pilot to pick up the Finders. They are not expecting trouble, but will not react to the PCs well, especially after finding out that some of the terraformers have been killed. The Eos Freedom League will try to eliminate all witnesses to this debacle.

Into this situation walk the PCs, looking for shelter from an unseasonable rain storm. They happen upon the terraforming outpost and end up getting drawn into an already chaotic situation.

SYNOPSIS • • •

The PCs are traveling near Iron Scar when the rains start, driving them to seek shelter after having a nasty run in with a flash flood. The PCs quickly find the terraforming outpost, and after another flash flood it becomes the only shelter available to them. The outpost is on a hilltop that has been surrounded by fiercely running water, making it a risky proposition to get off the hill while the rain continues. In addition to the Finders and the terraformers in the outpost, a pair of Iron Scar chargers, a small group of murcows, and a wounded vaasi warhound have also ended up on the hill. If the PCs wander around outside, they are likely to run into some of these creatures. In any case, the vaasi warhound will eventually venture into the outpost.

Inside the outpost, there are the five Finders and four terraformers. The Finders have locked the terraformers in a closet and will try to pass themselves off as the terraformers to the PCs, but are likely to fail at the ruse. Thus begins a running fight through the outpost between the PCs and the Finders. Once

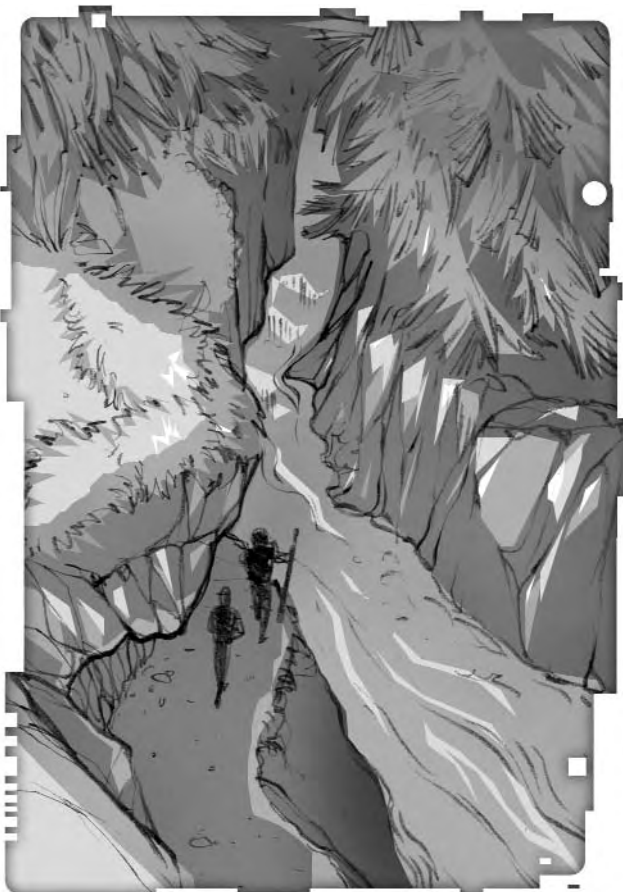

ADVENTURE HOOKS • • •

The PCs can be traveling in the vicinity of the terraforming outpost for any number of reasons. If they are citizens of the Dawning Star Republic, they could be bringing supplies to the terraforming outpost, traveling to Iron Scar to meet family or carry out a business transaction, hunting a herd of lost murcows, or even hunting for relics just like the Finders. If the characters are all faction-campers they are likely have a more nefarious reason for their travels, possibly heading to Iron Scar to spy on Eos Defense Force operations or to make contact with an Eos Freedom League agent in the city. Velin in the group could be taking part in a ritual hunt of some sort, looking for lost tribe members, or possibly acting as a guide for the rest of the characters through the treacherous terrain. Regardless of their origins and allegiance, getting the characters to the desert east of Iron Scar should be easy enough. While non-Dawning Star Republic characters may not be interested in saving a Dawning Star Republic facility, saving themselves and the town of Iron Scar should prove sufficient motivation for the adventure.

ENCOUNTER 1: FLOOD • • •

Once you have established the reason for the PCs traveling through the area read the following aloud:

While the morning started out as one would expect in a desert, hot and dry, the day has become one of wind and clouds faster than naturally possible. It isn't even the rainy season, but by early afternoon the easy trek turned ugly with the sudden appearance of a thunderstorm. Now, as it enters evening, the rain has only increased. The unpaved road has turned to a vat of mud. The road ahead now leads down into a valley, the bottom of which seems to be covered in rushing water several feet deep. To either side of the road, the valley walls rise steeply, and on the top of one hill stands some type of building, illuminated by glow-lamps that mark its exterior. Suddenly, there is a great rumble from behind. The sudden realization can no longer be denied: This isn't a road—it's a creek bed. From back up at the mouth of the valley, a wall of water comes hurtling down the path in a flash.

the PCs find the terraformers, they can learn their story. Additionally, the terraformers will inform the PCs of the need to shut down the atmospheric converter before it explodes and poisons the Iron Scar water supply. The terraformers also tell the PCs that the rains will soon flood the outpost if the rains do not stop. The terraformers know that the device the Finders brought into the outpost was giving off a strange energy reading. If none of the PCs think of it, the terraformers might suggest that the relic is the cause of the rain. The PCs and the terraformers must safely shut down the atmospheric converter, retrieve the relic from the Finders, and destroy it before the facility floods. (They have little chance of repairing it given its advanced technology level.) Once the relic is destroyed, the rain quickly ends, and the flooding stops. During all of this activity, the vaasi warhound also stalks the outpost, looking for victims. It will likely be the wild card in the deck, attacking at just the wrong moment and disappearing in the confusion. But it will give the PCs their first face-to-face encounter with the vaasi threat.

When the PCs begin the adventure, they have four hours before the atmospheric converter explodes. If they do not fix the converter by then, they will have to take extreme measures to stop the chemicals from leaking into the water supply of Iron Scar in addition to avoiding the resulting explosion. Two hours after the PCs arrive, the Eos Freedom League shows up looking for the Finders.

The PCs have four rounds to react before the water reaches them. If the PCs are not out of its path by then, they are carried along 200 feet each round by the rushing waters and must make a Swim check (DC 15) or take 1d6 points of subdual damage. The PCs continue to be carried each round until they can make a successful Swim check followed by a Strength check (DC 10) to pull themselves out of the raging water or until someone else pulls them out of the water. They must then crawl out of the valley.

Climbing the valley walls before the flood reaches the PCs requires a Climb check (DC 12), made difficult only by the muddy surface. The valley walls are 20 feet high. If the PCs choose to climb up the valley wall that does not lead to the terraforming outpost they get to the top of the wall only to find a flood in progress on the other side of the rise as well, trapping them on top with no shelter to speak of. The space between the tops of the valley walls is only 30 feet so characters with rope can easily climb across to the hilltop with the terraforming outpost if they end up on the wrong side.

ENCOUNTER 2: THE HILLTOP • • •

Assuming they reach the top of the valley wall on which the terraforming outposts rests read the following:

This small vaguely elliptical hilltop appears to be a little over 400 feet long and 200 feet wide. It is encircled by raging flood waters. Some of the other areas of the hilltop are not as steep as others, but there are no apparently easy ways off the hilltop. The rain continues to pour down, and the concrete building at the center of the hill is looking more inviting with every water-logged second. The building is perfectly square and nondescript except for a Dawning Star Republic flag painted on the nearest side. The building has some sort of landing pad off to one side, but no vehi-

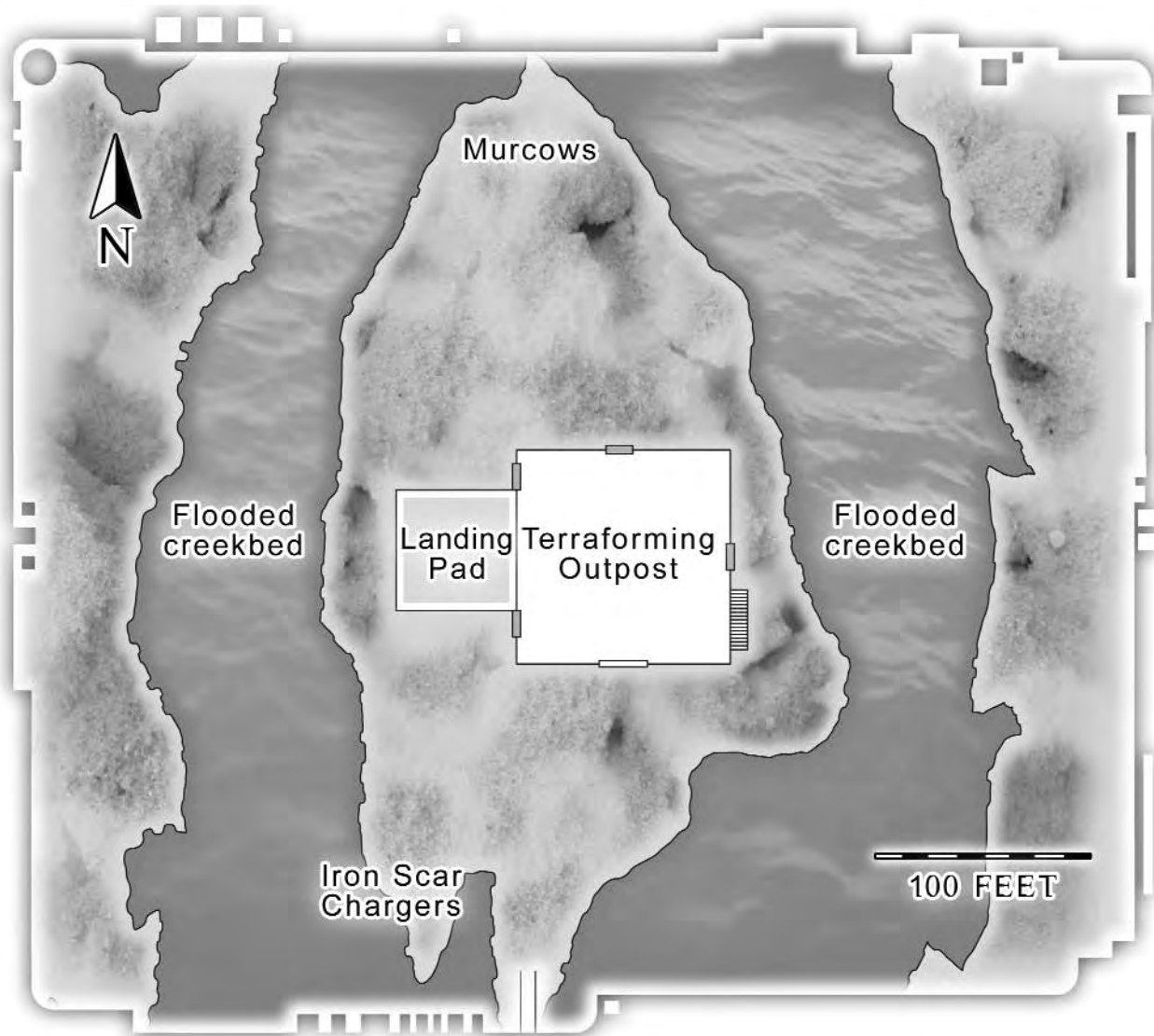

cle currently occupies it. Around the edge of the landing pad, a number of large barrels are stacked. The building bears a large central door. There building has several smokestack-like protrusions jutting from the top and the sides of the building and what appears to be an extensive sensor array on the roof.

Other than the building, the hilltop looks deserted except for some panicked murcows grouped around a stone outcropping a bit to the north. Their nervous braying can just be heard above the crash of the storm.

While out in the rain, the characters suffer a -4 circumstance penalty to Listen and Spot checks, and all ranged targets enjoy one-half concealment. Anyone who takes an extended look at the flooded creek beds will see that the water is slowly rising a few inches per hour; in a few hours, the entire hilltop will be flooded.

In addition to the six murcows, there are a mated pair of Iron Scar chargers and a vaasi warhound stuck on the hilltop. The chargers remain in the southern end of the hilltop. They are considered unfriendly to the PCs, and will change to hostile, if they are approached by more than a single creature or in a threatening manner. The female charger is pregnant, so the two really just want to be left alone.

The vaasi warhound was with a group of vaasi soldiers, hiding in nearby caves to avoid the sunlight. When the clouds rolled in, the war party went out to investigate. The warhound got separated from the other vaasi and was banged around a bit after being caught in flood waters before it ended up here. Unlike the other creatures, who have sought out the hilltop for sanctuary, the warhound is looking for trouble. It will avoid a straight-out confrontation with the PCs, instead following them discreetly until there are weakened or not paying attention. When it determines it can do the most damage, it will strike quickly and retreat. The warhound is cunning and values its life, so it will strike at the most inopportune moments for the PCs. If the PCs go inside the outpost, it will try to follow them, but it will retreat outside if it fears being trapped in the outpost. Assuming the PCs defeat the warhound, unless they take special precautions to keep the corpse, it will wash away in flood waters by the time the adventure is over.

◆ MURCOWS

The murcows on the hilltop were separated from their herd when the storm struck and have wandered on to the hilltop looking to avoid the flood

waters. All six murcows are part of the Flying B Ranch and are branded appropriately. Recognizing the brand requires a Knowledge (Local (Iron Scar) or Business) check, DC 15. The ranch is a short distance from the terraforming outpost and if the PCs return the murcows they will receive a reward from the ranch worth a +1 increase to the PCs Wealth bonuses.

Murcows (6) ◆ CR 2

Large animal; HD 7d8+14; hp 34, 39, 41 (x2), 45, 47; MAS 18; Init +0; Spd 40 ft.; Defense 15, touch 9, flat-footed 15 (+6 natural, -1 size); BAB +5; Grap +10; Atk +5 melee (1d4+1, bite); Full Atk +5 melee (1d4+1, bite); FS 10 ft. by 10 ft.; Reach 5 ft.; SQ good nature, stampede; AL none; SV Fort +7, Ref +5, Will +3; AP 0; Rep +0; Str 13, Dex 10, Con 15, Int 2, Wis 12, Cha 5.
Skills: Climb +2, Listen +6, Spot +5.
Feats: None.

◆ IRON SCAR CHARGERS

The two Iron Scar chargers on the hilltop simply want to be left alone, as the female is pregnant. They will become very agitated if the vaasi warhound approaches them. This may clue the PCs into the fact that there is something else on the hilltop with them, and that it is dangerous.

[HARD] Iron Scar Chargers (2) ◆ CR 3

Small animal; HD 4d8+8; hp 26, 30; MAS 15; Init +4; Spd. 50 ft., climb 20ft.; Defense 16, touch 15, flat-footed 12 (+1 size, +4 Dex, +1 natural); BAB +3; Grap +1; Atk +8 melee (butt 1d4+2); Full Atk +8 melee (butt 1d4+2) and +1 melee (1d3+1, 2 claws); FS 5 ft. by 5 ft.; Reach 5 ft.; SQ adept climber, burst of speed, low-light vision, stunning charge, trip; AL none; SV Fort +6, Ref +8, Will +2; AP 0; Rep +0; Str 14, Dex 19, Con 15, Int 2, Wis 12, Cha 6.
Skills: Climb +14, Spot +5, Hide +6, Move Silently +6, Listen +5.
Feats: Weapon Finesse (butt).

[AVERAGE] Iron Scar Chargers (2)

hp 18, 14.

[Easy] Iron Scar Chargers (2)

hp 8, 5 (injured).

◆ VAASI WARHOUND

The vaasi warhound was separated from its vaasi war party, which was sent by the vaasi leadership to explore the region around Iron Scar. The group was hiding out in some caves, when the clouds started rolling in. So, they took the opportunity to go exploring, not giving much thought as to why the weather was so strange. The soldiers were

caught in a flash flood, drowning several of them, but this warhound managed to escape, getting buffeted by some rocks in the process. The warhound wants to return to the subterranean vaasi encampment a few miles distant, closer to the mountains, but first it has to get off this hilltop.

The warhound will also take an active hand in trying to kill all the humans on the hilltop and will particularly focus its efforts on any velin present. If the PCs do not eliminate the vaasi beforehand, it follows the following schedule of events.

Thirty minutes after the PCs arrive, the warhound begins stalking around the hilltop, causing distress to the other animals. The chargers will begin snorting and stomping to scare off the warhound, while murcows will cry out their nervous calls. All this noise may attract the PCs attention.

One hour after the PCs arrive, the warhound crawls up onto the roof and investigates the various sensory equipment for another thirty minutes before leaping down into the skylight.

Two hours after the PCs arrive, the warhound will head downstairs to investigate the smell of blood coming from the front room. If any of the terraformers are left unarmed and unguarded, it will attack them. Otherwise, it will continue to the entry room. If it runs into any of the Eos Freedom League soldiers, it will attack them if they are wounded or distracted.

Three hours after the PCs arrive, the warhound gets bored and begins hunting on the ground floor, trying to find a lone target to attack. The first person it comes across who is alone it attacks. It continues this process until everyone in the compound is dead or it is killed.

[HARD] Vaasi Warhound ♦ CR 3

Small aberration; HD 3d8+6; hp 19; MAS 17; Init +7; Spd 40 ft.; Defense 19, touch 14, flat-footed 16 (+3 Dex, +5 natural, +1 size); BAB +2; Grap -1; Atk +4 melee (1d6+1, bite); Full Atk +4 melee (1d6+1, bite); FS 5 ft. by 5 ft.; Reach 5 ft.; SQ; blindsight 60 ft., improved low-light vision, increased massive damage threshold, light sensitivity, vaasi servitor; AL vaasi; SV Fort +3, Ref +4, Will +5; AP 0; Rep +0; Str 13, Dex 17, Con 14, Int 5, Wis 14, Cha 6.

Skills: Hide +9, Listen +3, Move Silently +9.

Feats: Improved Initiative.

[AVERAGE] Vaasi Warhound

hp 14.

[EASY] Vaasi Warhound

hp 9.

ENCOUNTER 3: THE TERRAFORMING OUTPOST • • •

The terraforming outpost is a concrete and steel building designed to resist the rainy season and the heat of the desert sun, but it is not a very aesthetically pleasing building. It is large and blocky, with no exterior decoration to speak of except for the flag of the Dawning Star Republic painted on one wall. The structure is two stories tall. In addition to the main door in the south wall, the building has four windows on the ground floor and a skylight on the second floor. The landing pad is used for bringing heavy supplies to the outpost and storage. The containers on the landing pad hold materials used in the terraforming process.

If the PCs approach the front door of the outpost, they should make Spot checks, DC 15. For those who succeed, read the following:

The building seems very solid and easily capable of resisting such a storm, but there are several areas of cracks in its surface. Each of these areas is small, only a few inches in diameter, resembling a bullet hole, and all of them are located on the southern side near the main door. Small red spots are being smeared in the driving rain. Blood.

The front door of the building is a large metal door that was originally a bulkhead door from the *Dawning Star*. It is a heavily-armored, steel door with a toughness of 20 and 50 hit points. It is controlled by a panel next to the door and can be locked from the inside, but when the characters arrive it is not locked. Getting in through a window requires a Climb or Jump check, DC 10. The window in the entry room

TERRAFORMING OUTPOST LEVEL 1

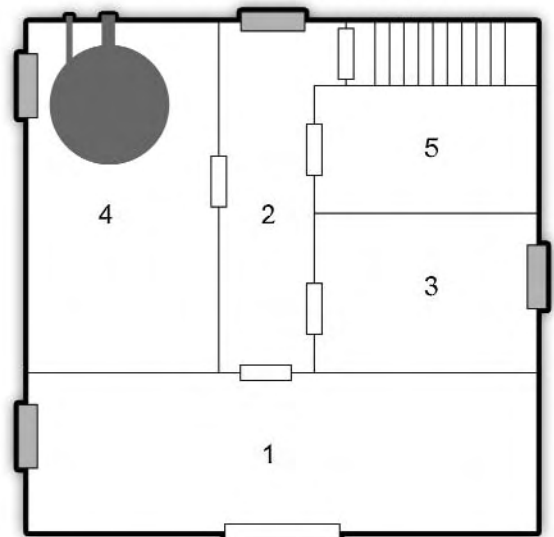

on the first floor was broken in the fight between the terraformers and the Finders, making it easily accessible to the PCs or the warhound. There a set of stairs leading to the roof on the eastern wall that allows access to the skylight and the sensors on the roof. The skylight is broken, allowing easy access to the second floor's main hall.

If the PCs open the main door, go to section 1 of encounter 4. If the PCs use one of the windows to enter the outpost, go to the appropriate section of encounter 4. If they go up and enter through the skylight, go to section 1 of encounter 5.

Any noise in the outpost may attract the attention of the Finders or the warhound, assuming it is in the building. Each time the PCs make a significant amount of noise, make a Listen check for the other characters in the building that have the capacity to respond. Each NPC has noted in their description a reaction to hearing sounds of combat or other noises. Due to the thickness of the walls sounds do not carry well in the outpost.

WHAT'S THAT NOISE?

Type of Noise	Listen DC
Dropping something heavy	10
Gunfire	5
Explosion	3

NPC	Listen Skill Bonus
Marcus Spelter	-1
Dashi Kumar	+0
Nezui Kai	-1
Red Tom	-1
Serge Permant	-1

TERRAFORMING OUTPOST

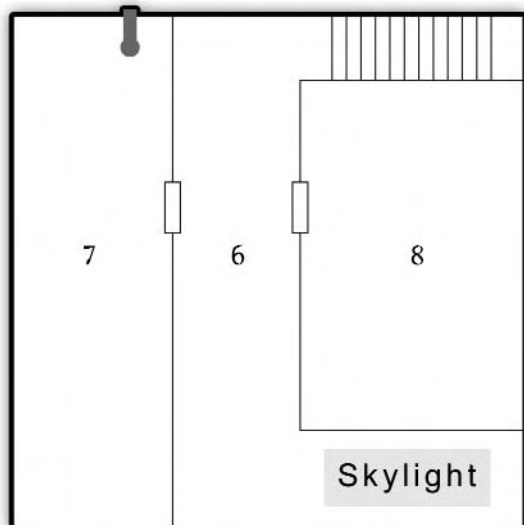

ENCOUNTER 4: 1ST FLOOR OF THE TERRAFORMING OUTPOST • • •

1 ENTRY ROOM

Assuming the PCs enter through the main door, which may be opened with the touch of button, this is the first room they enter.

This room appears to be an entry room for visitors to the building to remove muddy shoes, for storage of hostile-weather gear, and a place for a hot cup of coffee after slogging through the rain. A large wooden chair and a set of chairs dominate the western side of the room, and one of the chairs has been knocked the center of the room where it fell on its back to the floor, blood splattered across its back. In the western wall, is a large window that has been shattered, and some rain now pours through the opening. The eastern wall of the room is nearly covered by a row of storage lockers, one of which is open. The floor is covered in dirt and blood splatters, creating mud of an oddly burgundy color. At the center of the room, above the knocked-over chair stands a large man in a damp set of rough outs, a large pistol at his belt. He is smoking a roughly rolled cigar, but throws it into a puddle on the floor, when he hears the door whoosh open. As he turns, the blood splattered on his clothes is unmistakable. He does his best to smile and appear welcoming.

"Welcome to terraforming outpost 10-16," he says, his voice drenched with a thick Texan twang.

General Description: This room served as the main entry point for the outpost and is where the terraformers stored certain equipment like severe weather gear, extra survival gear, boots, etc. They put several heaters and a coffee maker in here to warm up after going outside during the rainy season and during the cold winter nights. This room is where the showdown between the terraformers and the Finders happened, shortly after the Finders came inside. The fight broke out when the terraformers tried to inspect the weather control relic due to the strange energy readings it was putting

out, but the Finders reacted badly to this and drew their weapons. The terraformers went for the guns in their lockers, but after two of them were shot by the Finders, they surrendered and were locked in the storage closet on the first floor. One of the terraformers managed to flee outside but was confronted by one of the Finders standing watch and killed, hence the bullet holes on the outside of the building. Now, the Finders are waiting for an Eos Freedom League transport to come pick them up, but the arrival of the PCs throws a big monkey wrench into their plans.

The man in the room is Marcus Spelter, the leader of the Finders who has come in to make a pot of coffee, while the rest of his men search the computer room and the living quarters upstairs. Marcus is not a stupid man and will try and convince the PCs that he is one of the terraformers and that they should wait here while he goes and gets the rest of his staff from upstairs. If they let him do this, he will go round up the other members of the Finders and try capturing the PCs so they may be locked up with the other terraformers. This may force an early confrontation with the Finders. If the PCs do not let him leave or if they question him about the blood stains on the floor, he says that they are from an accidental weapons discharge while one of his men was cleaning his weapon. If asked about the damage to the building, he'll claim they were recently attacked by raiders, hence he and his men have started carrying their firearms. If asked for some form of identification, he claims to have left it upstairs and will lead the PCs up there to his men if possible. Marcus will try and bluff the PCs into the optimum ambush set up and has little regard for the lives of his men. Marcus does not believe the terraformers' claims that the atmospheric converter is going to explode and makes no efforts to deal with the problem.

Marcus Spelter is fairly new to relic hunting, having formerly been a rancher, who turned to his new trade after losing his herd to a blood blisters outbreak. Not wanting to follow the guidelines for ruin exploration established by the Dawning Star Republic, he turned to the Eos Freedom League and set up an arrangement to sell relics he finds to Patricia Rogers. Marcus recruited four thugs to join his squad and set out to an area of ruins that he knew of near Iron Scar. Striking pay dirt on their first trip, they found the weather control relic, but now everything seems to have gone downhill. Marcus is a smart man and can think on his feet, but he's not accustomed to leadership and has little clue as to how to get out of this situation, once the PCs get involved, other than violence. Marcus does not wish to kill anyone, but he will do so if he has to, and he has no intention of letting any captives go before he leaves, possibly dooming them to a slow death of starvation and dehydration or a quick death of

drowning. The Eos Freedom League, on the other hand, will kill everyone present to remove all witnesses.

If attacked, Marcus will respond with lethal force and will scream for his companions to join him, which some of them will attempt to do, assuming they hear him. If the PCs begin questioning Marcus in a way that leads him to think they are on to him and about to start a fight, he will try and beat them to it, drawing his gun and then fleeing upstairs.

If the PCs search the floor of the room, a successful Search check (DC 20) reveals fifteen spent shells: 7 of 10mm variety, 4 shotgun shells, and 4 .44 magnum rounds. An Investigation check (DC 20) indicates that the ammo has been fired with the last half hour and that the blood is similarly fresh.

Treasure: The area around the table has little of interest in it besides the coffee pot, which contains a full, steaming pot of coffee.

In the storage lockers there are 5 rough-outs, 5 exposure suits, 5 radios, 5 info-comps, and 2 EDF-9 Autopistols with 2 clips each. This equipment is what the terraformers usually wear when going into the field and is their personal equipment. If the PCs take it, the terraformers will ask for it back after the adventure.

NPCs: Marcus Spelter.

[HARD] Marcus Spelter
(Tough Ordinary 2) ♦ CR 1

Medium humanoid; HD 2d10+4; hp 21; MAS 15; Init +1; Spd 30 ft.; Defense 16, touch 13, flat-footed 15 (+1 Dex, +2 class, +3 armor); BAB +1; Grap +2; Atk +2 melee (1d4+1, knife), +2 ranged (2d6, EDF-9 auto-pistol); Full +2 melee (1d4+1, knife), +2 ranged (2d6, EDF-9 auto-pistol); FS 5 ft. by 5 ft.; Reach 5 ft.; SQ NA; AL Eos Freedom League; SV Fort +4, Ref +1, Will -1; AP 0; Rep +0; Str 12, Dex 13, Con 15, Int 14, Wis 8, Cha 10.

Occupation: Ranch-Hand.

Skills: Bluff +2, Gamble +4, Intimidate +3, Handle Animal +6, Profession (Rancher) +3, Ride +7, Survival +5.

Talents: None.

Feats: Animal Affinity, Armor Proficiency (Light), Personal Firearms Proficiency.

Possessions: EDF-9 auto-pistol and 3 clips, rough outs, survival knife, wide-brimmed hat, 5 days of water and trail rations, hand held navigator, compass, first aid kit.

[AVERAGE] Marcus Spelter
(Tough Ordinary 1) ♦ CR 1/2

Medium humanoid; HD 1d10+2; hp 10; MAS 15; Init +1; Spd 30 ft.; Defense 15, touch 12, flat-footed 14 (+1 Dex, +1 class, +3 armor); BAB +0; Grap +1; Atk +1 melee (1d4+1, knife), +1 ranged (2d6, EDF-9 auto-pistol); Full +1

melee (1d4+1, knife), +1 ranged (2d6, EDF-9 auto-pistol); FS 5 ft. by 5 ft.; Reach 5 ft.; SQ NA; AL Eos Freedom League; SV Fort +3, Ref +1, Will -1; AP 0; Rep +0; Str 12, Dex 13, Con 15, Int 14, Wis 8, Cha 10.

Occupation: Ranch-Hand.

Skills: Gamble +4, Handle Animal +6, Profession (Rancher) +3, Ride +7, Survival +5.

Talents: None.

Feats: Animal Affinity, Armor Proficiency (Light), Personal Firearms Proficiency.

Possessions: EDF-9 auto-pistol and 3 clips, rough outs, survival knife, wide-brimmed hat, 5 days of water and trail rations, hand held navigator, compass, first aid kit.

[EASY] Marcus Spelter (Tough Ordinary 1) ♦ CR 1/2

Medium humanoid; HD 1d10+2; hp 6; MAS 15; Init +1; Spd 30 ft.; Defense 15, touch 12, flat-footed 14 (+1 Dex, +1 class, +3 armor); BAB +0; Grap +1; Atk +1 melee (1d4+1, knife), +1 ranged (2d6, EDF-9 auto-pistol); Full +1 melee (1d4+1, knife), +1 ranged (2d6, EDF-9 auto-pistol); FS 5 ft. by 5 ft.; Reach 5 ft.; SQ NA; AL Eos Freedom League; SV Fort +3, Ref +1, Will -1; AP 0; Rep +0; Str 12, Dex 13, Con 15, Int 14, Wis 8, Cha 10.

Occupation: Ranch-Hand.

Skills: Gamble +4, Handle Animal +6, Profession (Rancher) +3, Ride +7, Survival +5.

Talents: None.

Feats: Animal Affinity, Armor Proficiency (Light), Personal Firearms Proficiency.

Possessions: EDF-9 auto-pistol and 3 clips, rough outs, survival knife, wide-brimmed hat, 5 days of water and trail rations, hand held navigator, compass, first aid kit.

2 MAIN HALL

This long hallway is lined with pictures of different landscapes from across Eos, including a morning shot of the sun rising over Dawning Star and the jungles of the Green Sea. There are four doors in the hallway, three on the right side and one on the left. There are numerous muddy tracks in the room, most of which lead into the second door on the right but some lead also lead to the last door on the right. There are also signs of someone being dragged through the muddy footprints to the third door on the right.

General Description: This room serves as the major traffic area for the outpost's first floor. After the short gunfight in the entryway, the surviving terraformers were marched into the storage room through the second door on the right. A successful Spot check (DC 10) reveals signs of something being dragged into that room.

The only door on this hallway that is locked is the door to the storage room. It remains locked to keep the terraformers inside. The other doors have locks but none of them are engaged.

Treasure: None.

NPCs: None.

3 COMPUTER ROOM

This poorly-lit room is lined with computers, all of which sit on a waist-high desk that wraps around almost the entire room. There are three main computer consoles, one in the middle of each wall except for the wall with the door. Three chairs are placed randomly about the room, and a large window on the far wall reveals the storm continuing outside, the flood waters continuing to rise. Sitting in one of the chairs is a thin man in a rough-out, plugging away at a computer. A shotgun sits next to him on the desk, and his boots are caked in mud.

General Description: This room is the control center for the terraforming outpost, from which the atmospheric converter and all the other necessary functions of the outpost are governed. Normally, it is manned by one of the terraformers at all times to monitor the converter and the other operations of the outpost. Now, the only occupant of the room is the Finder's resident technical expert, Dashi Kumar. A career scavenger and self-proclaimed expert on alien technology, Dashi has spent most of his life in Roger's Point helping out in the various craft houses of the city, sneaking what goods he could out of the workshops and building his own devices with them. Of the Finders, he has the most experience with alien technology, relics, and ruins, which is to say he's been in a ruin once more than the rest of them and heard about a bunch of relics from his friends in Roger's Point. He's parlayed this limited experience into being the resident relic expert for the Finders, though they are starting to realize he is full of murcow droppings. He's currently trying to use the computers to figure out what's going on with the weather and when the rain will stop, but is having little success.

If the PCs attempt to sneak up on Dashi, they can yank the shotgun right out of his reach. As he is

focused on the computer monitor, a successful Move Silently check against Dashi's Listen check is all that is required. Dashi suffers a -2 circumstance penalty to his Listen check due to this distraction. Otherwise, if Dashi is alerted to their presence, he immediately goes for the shotgun and yells for help, opening fire without waiting to parley. If captured or disarmed, Dashi begs for his life and readily offers to sell out the rest of the Finders, telling the PCs their strengths, their weaponry, and about the weather-control relic. Due to his inability to find out what's causing the rainstorm using the outpost's computers, Dashi has come to suspect that the relic is causing the weather disturbance, which he will relate to the PCs if suitably threatened. If Marcus flees upstairs, Dashi will not notice unless there is gunfire involved.

Treasure: The computers in the room are not easily moveable and are good for little else besides terraforming in their current configuration. There is nothing else of value in the room.

NPCs: Dashi Kumar.

[HARD] Dashi Kumar
(Smart Ordinary 2) ♦ CR 1

Medium humanoid; HD 2d6+2; hp 13; MAS 13; Init +2; Spd 30 ft.; Defense 16, touch 13, flat-footed 14 (+1 class, +2 Dex, +3 armor); BAB +1; Grap +2; Atk +2 melee (1d4+1, knife), +3 ranged (2d10, Brase Arms shotgun); Full +2 melee (1d4+1, knife), +3 ranged (2d10, Brase Arms shotgun); FS 5 ft. by 5 ft.; Reach 5 ft.; SQ NA; AL Eos Freedom League; SV Fort +1, Ref +2, Will +1; AP 0; Rep +1; Str 12, Dex 14, Con 13, Int 15, Wis 10, Cha 9.

Occupation: Technician.

Skills: Computer Use +6, Craft (Electronic) +7, Craft (Mechanical) +7, Decipher Script +6, Demolitions +6, Disable Device +6, Knowledge (Relics) +7, Knowledge (Technology) +7, Repair +8, Search +6, Survival +3, Treat Injury +3.

Talents: None.

Feats: Armor Proficiency (Light), Personal Firearms Proficiency.

Possessions: Brase Arms Shotgun and 18 shells, radio, 4 days of trail rations, info-comp, mechanical tool kit, electrical tool kit, flashlight, knife, rough-out. He is also wearing a gold ring that has a Purchase DC of 15.

[Average] Dashi Kumar
(Smart Ordinary 1) ♦ CR 1/2

Medium humanoid; HD 1d6+1; hp 7; MAS 13; Init +2; Spd 30 ft.; Defense 15, touch 12, flat-footed 13 (+2 Dex, +3 armor); BAB +0; Grap +1; Atk +1 melee (1d4+1, knife), +2 ranged (2d10, Brase Arms shotgun); Full +1 melee (1d4+1, knife), +2 ranged (2d10, Brase Arms shotgun); FS 5 ft. by 5 ft.; Reach 5 ft.; SQ NA;

AL Eos Freedom League; SV Fort +1, Ref +2, Will +1; AP 0; Rep +1; Str 12, Dex 14, Con 13, Int 15, Wis 10, Cha 9.

Occupation: Technician.

Skills: Computer Use +6, Craft (Electronic) +6, Craft (Mechanical) +7, Decipher Script +6, Demolitions +6, Disable Device +6, Knowledge (Relics) +6, Knowledge (Technology) +7, Repair +7, Search +6, Survival +2.

Talents: None.

Feats: Armor Proficiency (Light), Personal Firearms Proficiency.

Possessions: Brase Arms Shotgun and 18 shells, radio, 4 days of trail rations, info-comp, mechanical tool kit, electrical tool kit, flashlight, knife, rough-out. He is also wearing a gold ring that has a Purchase DC of 15.

[Easy] Dashi Kumar
(Smart Ordinary 1) ♦ CR 1/2

Medium humanoid; HD 1d6+1; hp 4; MAS 13; Init +2; Spd 30 ft.; Defense 15, touch 12, flat-footed 13 (+2 Dex, +3 armor); BAB +0; Grap +1; Atk +1 melee (1d4+1, knife), +2 ranged (2d10, Brase Arms shotgun); Full +1 melee (1d4+1, knife), +2 ranged (2d10, Brase Arms shotgun); FS 5 ft. by 5 ft.; Reach 5 ft.; SQ NA; AL Eos Freedom League; SV Fort +1, Ref +2, Will +1; AP 0; Rep +1; Str 12, Dex 14, Con 13, Int 15, Wis 10, Cha 9.

Occupation: Technician.

Skills: Computer Use +6, Craft (Electronic) +6, Craft (Mechanical) +7, Decipher Script +6, Demolitions +6, Disable Device +6, Knowledge (Relics) +6, Knowledge (Technology) +7, Repair +7, Search +6, Survival +2.

Talents: None.

Feats: Armor Proficiency (Light), Personal Firearms Proficiency.

Possessions: Brase Arms Shotgun and 18 shells, radio, 4 days of trail rations, info-comp, mechanical tool kit, electrical tool kit, flashlight, knife, rough-out. He is also wearing a gold ring that has a Purchase DC of 15.

4 ATMOSPHERIC CONVERTER

This large room is dominated by an equally large, circular device that fills most of the northern half of the room. The device is covered in pipes, display panels, controls, and grated vents. Across its side "DST-16 ATMOSPHERIC CONVERTER" is written in large, red letters. There are several banks of computers on the west and south walls. The room seems very clean and shows little sign of recent activity.

General Description: This room contains most of the terraforming hardware that the outpost makes use of, including the atmospheric converter, which is the main piece of hardware in the station. The converter is currently online, and unless it is fixed in the four hours after the PCs arrive at the outpost, it will explode (see Events below). Any PC who inspects the controls can make a Computer Use (DC 10) or Terraforming check (DC 8) to discern that the converter will explode and how long until they have until the explosion. The Finders took only a cursory look inside this room and have thereafter ignored it.

5 SUPPLY ROOM

When the PCs arrive, this door is locked from the outside. Assuming they are arriving here from the main hall, it is a simple matter to unlock the door and enter.

This room's walls are lined with metal shelving, filled with a wide variety of boxes, bins, and other containers, while the eastern half of the floor is mostly covered with barrels and crates. This appears to be a storage room, and many of the containers have evidence of recently being rifled through. There are presently five people in the room—two lying stretched on the floor and three leaning against crates. All five of them have blood spatters on their clothing, but the two on the floor have the largest blood stains by far, and one has a badly stained bandage wrapped around his torso. All five individuals are wearing uniforms of the Dawning Star Republic Terraforming Corps.

As you enter, one of the men sitting against the boxes stands up and says:
"What do you want? Are you with them?"

General Description: This room is the primary storeroom for the first floor of the terraforming outpost and now serves as a jail for the surviving staff. It contains boxes of chemicals, spare parts, portable sensor equipment, and similar devices used by the outpost in the terraforming process. There are no weapons in the storeroom, though several objects such as broom handles and cutting tools could be fashioned into clubs or knives with a few minutes work.

If the PCs are captured by the Finders or the Finders happen to walk in on the PCs while they are all in the storage room, the Finders will lock the

PCs in the storage room. Opening the storage door from the inside while it is locked requires a Disable Device check (DC 20).

Of the five terraformers, one is dead (Bert Gomez), and the one with the bandages is badly injured. The other three terraformers have minor injuries but are still mobile. They are terrified about what has happened—none of them are soldiers—and they are worried that the Finders will kill them once they are ready to leave. Assuming the PCs calm the terraformers down and convince them they are not with the Finders, the terraformers will tell the PCs what happened when the Finders entered the outpost. They will also relate that the weather pattern is extremely unusual and not being caused by their terraforming equipment. The terraformers are unsure of the cause but suspect the relic the Finders had with them. The terraformers do know that, unless the atmospheric converter is safely powered down, it will explode within a few hours, killing everyone in the outpost and poisoning the Iron Scar water supply. The terraformers are willing to aid the PCs in working on the relic, fixing the atmospheric converter, or watching the PCs' backs, but they have very limited combat skills and will avoid direct confrontation with the Finders at all costs. Only a particularly clever plan will get them involved.

The severely injured terraformer, Bill Sater, was the only one of the group with security training. He is stable, at -7 hit points. If the PCs can return him to consciousness, he will be more than willing to help them take out the Finders. The other three terraformers, Emily Gibson, Patrick Chung, and Gunther Stewart, are all scientists with little knowledge of combat. They are also scared out of their wits.

If the PCs leave the terraformers in this room without making some effort to secure the door, the terraformers may very well fall victim to the vaasi warhound stalking the area.

Treasure: Other than a lot of spare parts, terraforming equipment, chemicals, and crates there is little of value in this room.

NPCs: Terraformers (4).

Bill Sater (Fast/Smart Ordinary 1/1) ♦ CR 1

Medium humanoid; HD 1d8+1d6+2; hp 11 (-7); MAS 12; Init +2; Spd 30 ft.; Defense 15, touch 15, flat-footed 13 (+2 Dex, +3 class); BAB +0; Grap +0; Atk +0 melee (1d3, punch); Full +0 melee (1d3, punch); FS 5 ft. by 5 ft.; Reach 5 ft.; SQ NA; AL Dawning Star Republic; SV Fort +1, Ref +3, Will +2; AP 0; Rep +1; Str 10, Dex 14, Con 12, Int 15, Wis 13, Cha 9.

Occupation: Terraformer.

Skills: Computer Use +6, Craft (Electronic) +6, Craft (Structural) +6, Drive +6, Investigate +6, Knowledge (Earth and Life Sciences) +8,

Knowledge (Physical Sciences) +6, Navigate +6, Pilot +7, Profession (Terraformer) +5, Repair +6, Ride +4, Terraforming +8.

Talents: None.

Feats: Armor Proficiency (Light), Personal Firearms Proficiency, Terraforming Training.

Possessions: Uniform.

Emily Gibson

(Smart Ordinary 1) ♦ CR 1/2

Medium humanoid; HD 1d6+2; hp 7 (4); MAS 14; Init -1; Spd 30 ft.; Defense 9, touch 9, flat-footed 9 (-1 Dex, +0 class); BAB +0; Grap +0; Atk +0 melee (1d3, punch); Full +0 melee (1d3, punch); FS 5 ft. by 5 ft.; Reach 5 ft.; SQ NA; AL Dawning Star Republic; SV Fort +2, Ref -1, Will +1; AP 0; Rep +1; Str 10, Dex 8, Con 14, Int 15, Wis 13, Cha 12.

Occupation: Terraformer.

Skills: Computer Use +6, Craft (Chemical) +8, Craft (Mechanical) +8, Demolitions +6, Investigate +6, Knowledge (Earth and Life Sciences) +8, Knowledge (History) +6, Knowledge (Physical Sciences) +6, Repair +6, Search +6, Terraforming +8.

Talents: None.

Feats: Builder, Personal Firearms Proficiency, Terraforming Training.

Possessions: Uniform.

Patrick Chung

(Charismatic Ordinary 1) ♦ CR 1/2

Medium humanoid; HD 1d6; hp 4; MAS 10; Init +1; Spd 30 ft.; Defense 11, touch 11, flat-footed 10 (+1 Dex), BAB +0; Grap -1; Atk -1 melee (1d3-1, punch); Full -1 melee (1d3-1, punch); FS 5 ft. by 5 ft.; Reach 5 ft.; SQ NA; AL Dawning Star Republic; SV Fort +1, Ref 2, Will +1; AP 0; Rep +2; Str 8, Dex 12, Con 10, Int 14, Wis 13, Cha 15.

Occupation: Terraformer.

Skills: Bluff +6, Computer Use +4, Diplomacy +6, Gather Information +6, Intimidate +6, Knowledge (Earth and Life Sciences) +8, Perform (Stand-Up) +5, Profession (Terraformer) +6, Terraforming +8.

Talents: None.

Feats: Armor Proficiency (Light), Terraforming Training, Trustworthy.

Possessions: Uniform.

Gunther Stewart

(Dedicated Ordinary 1) ♦ CR 1

Medium humanoid; HD 1d6+1; hp 6 (5); MAS 12; Init +0; Spd 30 ft.; Defense 11, touch 11, flat-footed 11 (+1 class); BAB +0; Grap -1; Atk -1 melee (1d3-1, punch); Full -1 melee (1d3-1, punch); FS 5 ft. by 5 ft.; Reach 5 ft.; SQ NA; AL

Dawning Star Republic; SV Fort +2, Ref +0, Will +1; AP 0; Rep +1; Str 9, Dex 10, Con 12, Int 14, Wis 15, Cha 13.

Occupation: Terraformer.

Skills: Craft (Pharmaceutical) +8, Knowledge (Earth and Life Sciences) +8, Listen +4, Sense Motive +6, Spot +8, Survival +6, Terraforming +8, Treat Injury +8.

Talents: None.

Feats: Alertness, Medical Expert, Terraforming Training.

Possessions: Uniform.

ENCOUNTER 5: TERRAFORMING OUTPOST, SECOND FLOOR • • •

The second floor of the outpost is reached via the stairs through the third door on the right in the main hallway. None of the doors in the stairway are locked.

6 SECOND FLOOR MAIN HALL

This hallway looks very similar to the one on the floor below, including the pictures of distant areas of Eos. Muddy footprints lead from the stairs through both doors in the hallway and to a table and chairs located at the end of the hall. There appears to be a room or alcove off to the left at the end of the hall, from which the sound of rain and dripping water can be heard.

General Description: This room serves as the central traffic area of the second floor, which houses the non-work-related areas of the facility, and it sees heavy use on most days. At the far end of the hallway, there is a small room beneath a skylight, where the terraformers would sometimes sit and read by natural lighting. The skylight was broken several months ago, but since the rainy season is still months away, no one worried about fixing it. Now, the broken skylight lets in a steady downpour of rain through a hole about one foot across. It is possible to climb in or out through the skylight, though reaching it would require a person to stand on a table or chair. Climbing in or out of the skylight requires a Climb check (DC 6).

7 MESS HALL

This long room is in near shambles, as boxes that were once neatly stacked have been cast about violently. At the far left-hand side of the room, a counter wraps around the walls and houses a fully-equipped kitchen, including an oven, refrigerator, and dishwasher. In the center

of the room is a large, wooden table with a bench on each side, creating a place to sit for communal meals. The right-hand side of the room is filled with stacks of boxes and pipes, reaching up through the floor into the ceiling. Across the floor, muddy footprints, packets of freeze-dried food, utensils, and flatware have been scattered. Sitting at the table is a large, dark-skinned man in a rough-out, eating a large bowl of unidentifiable stew. A pistol sits on the table next to him.

General Description: This room served as the mess hall, kitchen, general meeting area, and secondary storage room for the outpost. All meals were cooked in the kitchen and eaten at the table, though these meals were rarely taken in large groups due to the different shifts the terraformers worked. Now, the place has been turned upside-down by the Finders looking for loot. After his exhausting and fruitless search, Nezui Kai has decided to take his frustrations out on a bowl of murcow meat stew.

Nezui is a thug from Roger's Point, who doesn't like all this running around in the wilderness and wants to get back to Roger's Point, so he can find a new job. He's avoiding the other Finders currently, because he is annoyed—wet, tired, and dirty—which he blames them for. He will help them if a fight breaks out, but has little incentive to aid them otherwise. When the PCs enter, unless he knows them to be hostile or they are wearing obvious Dawning Star Republic uniforms or similar regalia, he will assume they are an extraction team from the Eos Freedom League. It should be relatively easy for the PCs to get the drop on him, unless they have already alerted the Finders to their presence with gunfire. If a gun battle breaks out, Nezui will drop down behind the table and use it for cover, gaining one-half cover in the process.

If a fight breaks out in the mess hall, Red Tom and Serge will rush out from the living quarters across the hall and catch the PCs in a cross fire.

Treasure: There is enough food in the kitchen to feed five people for sixty days, all of which is freeze dried and will not go bad. There are also numerous knives in the kitchen that can be used for weapons in a pinch. If the PCs search the storage boxes and succeed in a Search check (DC 15) they find 2 extra suits of rough outs and two smoke grenades.

NPCs: Nezui Kai.

[HARD] Nezui Kai
(Strong Ordinary 2) ♦ CR 2

Medium humanoid; HD 2d8+4; hp 18; MAS 14; Init +1; Spd 30 ft.; Defense 16, touch 13, flat-footed 15 (+1 Dex, +2 class, +3 armor); BAB +2; Grap +4; Atk +4 melee (1d6+2, machete), +3 ranged (2d8, S&W M29 .44 magnum pistol); Full +4 melee (1d6+2, machete), +3 ranged (2d8, S&W M29 .44 magnum pistol); FS 5 ft. by 5 ft.; Reach 5 ft.; SQ NA; AL Eos Freedom League; SV Fort +4, Ref +1, Will -1; AP 0; Rep +0; Str 15, Dex 12, Con 14, Int 10, Wis 8, Cha 13.

Occupation: Criminal.

Skills: Intimidate +4, Knowledge (Streetwise) +5, Profession (Thug) +4.

Talents: None.

Feats: Brawl, Armor Proficiency (Light), Personal Firearms Proficiency.

Possessions: S&W M29 .44 magnum pistol, 18 .44 magnum rounds, rough out, 5 days of water and trail rations, compass, machete, knife, 50 feet of rope.

[AVERAGE] Nezui Kai
(Strong Ordinary 1) ♦ CR 1

Medium humanoid; HD 1d8+2; hp 7; MAS 14; Init +1; Spd 30 ft.; Defense 15, touch 12, flat-footed 14 (+1 Dex, +1 class, +3 armor); BAB +1; Grap +3; Atk +3 melee (1d6+2, machete), +2 ranged (2d8, S&W M29 .44 magnum pistol); Full +3 melee (1d6+2, machete), +2 ranged (2d8, S&W M29 .44 magnum pistol); FS 5 ft. by 5 ft.; Reach 5 ft.; SQ NA; AL Eos Freedom League; SV Fort +3, Ref +1, Will -1; AP 0; Rep +0; Str 15, Dex 12, Con 14, Int 10, Wis 8, Cha 13.

Occupation: Criminal.

Skills: Intimidate +3, Knowledge (Streetwise) +4, Profession (Thug) +3.

Talents: None.

Feats: Brawl, Armor Proficiency (Light), Personal Firearms Proficiency.

Possessions: S&W M29 .44 magnum pistol, 18 .44 magnum rounds, rough out, 5 days of water and trail rations, compass, machete, knife, 50 feet of rope.

[EASY] Nezui Kai
(Strong Ordinary 1) ♦ CR 1

Medium humanoid; HD 1d8+2; hp 5; MAS 14; Init +1; Spd 30 ft.; Defense 15, touch 12, flat-footed 14 (+1 Dex, +1 class, +3 armor); BAB +1; Grap +3; Atk +3 melee (1d4+2, knife), +3 ranged (2d8, S&W M29 .44 magnum pistol); Full +3 melee (1d4+2, knife), +3 ranged (2d8, S&W M29 .44 magnum pistol); FS 5 ft. by 5 ft.; Reach 5 ft.; SQ NA; AL Eos Freedom League; SV Fort +3, Ref +1, Will -1; AP 0; Rep +0; Str 15, Dex 12, Con 14, Int 10, Wis 8, Cha 13.

Occupation: Criminal.

Skills: Intimidate +3, Knowledge (Streetwise) +4, Profession (Thug) +3.

Talents: None.

Feats: Brawl, Armor Proficiency (Light), Personal Firearms Proficiency.

Possessions: S&W M29 .44 magnum pistol, 7 .44 magnum rounds, rough out, 5 days of water and trail rations, compass, knife, 50 feet of rope.

8 LIVING QUARTERS

This large room has three sets of bunk beds, one set against each of the walls other than the wall containing the door. Only five of the six beds have sheets on them. On each end of these bunk beds are wooden or metal footlockers, all of which have been jimmed opened and thoroughly ransacked. There is also a large circular table at the center of the room, on which lies piles of personal effects taken from the foot lockers, including such items as watches, jewelry, and small electronics. At the table, sits a large woman with red hair and a small, dark-haired man. Next to the woman, a pistol sits on the table. A pair of rough-outs hang over the chairs, drying out. A shotgun leans against the bunk bed on the far wall.

General Description: This barracks-like room served as living quarters for the terraformers, and usually one or two of them were asleep here at any given time. Now, the place has been ransacked by Red Tom, the red-haired woman at the table, and Serge Permant, the dark-haired man, who left his shotgun several feet away. They have ransacked the personal belongings of the terraformers for anything of value.

When the PCs enter, Red Tom immediately goes for her pistol and attacks, flipping over the table as a move action to gain cover on her second action. Red Tom knows the PCs are not with the Finders and is paranoid enough to assume they are not Eos Freedom League soldiers. The PCs can try to talk to her through a hail of bullets, but she is not likely to surrender. Serge, on the other hand, suffers -2 circumstance penalty to Spot and Listen checks to avoid being surprised. He spends his first round moving and grabbing his shotgun from off the bed. Neither of them takes the time to put on their armor.

If the two hear combat in other rooms, they rush to take part, not putting their armor on unless they have time to return to the room after the fight, such

as if the PCs retreat out of the outpost.

Red Tom is the unofficial second-in-command of the group. If Marcus Spelter is killed, she assumes command. Red Tom has much more of a shoot-first mentality than Marcus, and she will give the PCs no chance to talk. She is also likely to execute the terraformers, given the chance, once they have outlived any usefulness. Red Tom considers herself a professional assassin, though most of her work has been engaging in extortion, arson, and vandalism for crime bosses in Roger's Point rather than actual killing. She desperately wants to make a reputation as being a dangerous individual, and she thinks killing everyone in the outpost may do that. The possible heat from the Dawning Star Republic that would result from such a massacre is an idea that has not crossed her mind.

Serge, on the other hand, is a professional thief and pickpocket from Roger's Point, and he is the only one in the group who seems really happy with their work so far. He expects to make a wagonload of money from the weather-control relic, plus all these trinkets taken from the terraformers. He considers this job a rousing success. Serge is a coward for the most part and will fight as long as there are other Finders present, but he surrenders as soon as he is alone or in mortal danger.

Treasure: If the PCs take the pile of stuff on the table, an act of pure thievery, it provides a total Wealth bonus of +4. Other than that, there is little in the room besides sheets, clothes, and personal effects. Red Tom carries the weather control relic.

NPCs: Red Tom and Serge Permant.

[HARD] Red Tom (Tough Ordinary 2) ♦ CR 2

Medium humanoid; HD 2d10+4; hp 21; MAS 15; Init +2; Spd 30 ft.; Defense 15, touch 15, flat-footed 13 (+2 Dex, +3 class); BAB +1; Grap +2; Atk +2 melee (1d4+1, knife), +3 ranged (EDF-9 auto-pistol); Full +2 melee (1d4+1, knife), +3 ranged (EDF-9 auto-pistol); FS 5 ft. by 5 ft.; Reach 5 ft.; SQ NA; AL Eos Freedom League; SV Fort +3, Ref +2, Will -1; AP 0; Rep +0; Str 13, Dex 14, Con 15, Int 10, Wis 8, Cha 12.

Occupation: Criminal.

Skills: Bluff +4, Hide +7, Knowledge (Streetwise) +6, Survival +3.

Talents: None.

Feats: Armor Proficiency (Light), Faction Camp Familiarity (Roger's Point), Personal Firearms Proficiency.

Possessions: Rough-out, EDF-9 auto-pistol and 3 clips, 2 knives, fragmentation grenade, 5 days of water and trail rations, flashlight, maps, compass, 2 chemical light sticks, weather-control relic.

Serge Permant**(Fast Ordinary 2) ♦ CR 2**

Medium humanoid; HD 2d8-2; hp 11; MAS 8; Init +2; Spd 30 ft.; Defense 15, touch 15, flat-footed 13 (+2 Dex, +3 class); BAB +1; Grap +1; Atk +1 melee (1d4, knife), +3 ranged (2d10, Brase Arms Shotgun); Full +1 melee (1d4, knife), +3 ranged (2d10, Brase Arms Shotgun); FS 5 ft. by 5 ft.; Reach 5 ft.; SQ NA; AL Eos Freedom League; SV Fort -1, Ref +4, Will +1; AP ; Rep +; Str 10, Dex 15, Con 9, Int 14, Wis 13, Cha 12.

Occupation: Criminal.

Skills: Drive +7, Gamble +7, Hide +9, Knowledge (Streetwise) +7, Move Silently +9, Profession (Thief) +6, Sleight of Hand +8.

Talents: None.

Feats: Armor Proficiency (Light), Personal Firearms Proficiency, Stealthy.

Possessions: Brase Arms shotgun with 7 rounds, rough-out, silver necklace (Purchase DC 11), lock picks, bolt cutters, 5 days of water and trail rations, compass, flashlight.

[AVERAGE] Red Tom**(Tough Ordinary 1) ♦ CR 1**

Medium humanoid; HD 1d10+2; hp 9; MAS 15; Init +2; Spd 30 ft.; Defense 13, touch 13, flat-footed 11 (+2 Dex, +1 class); BAB +0; Grap +1; Atk +1 melee (1d4+1, knife), +2 ranged (EDF-9 auto-pistol); Full +1 melee (1d4+1, knife), +2 ranged (EDF-9 auto-pistol); FS 5 ft. by 5 ft.; Reach 5 ft.; SQ NA; AL Eos Freedom League; SV Fort +3, Ref +2, Will -1; AP 0; Rep +0; Str 13, Dex 14, Con 15, Int 10, Wis 8, Cha 12.

Occupation: Criminal.

Skills: Bluff +3, Hide +6, Knowledge (Streetwise) +5, Survival +3.

Talents: None.

Feats: Armor Proficiency (Light), Faction Camp Familiarity (Roger's Point), Personal Firearms Proficiency.

Possessions: Rough-out, EDF-9 auto-pistol and 3 clips, 2 knives, fragmentation grenade, 5 days of water and trail rations, flashlight, maps, compass, 2 chemical light sticks, weather-control relic.

Serge Permant**(Fast Ordinary 1) ♦ CR 1**

Medium humanoid; HD 1d8-1; hp 5; MAS 8; Init +2; Spd 30 ft.; Defense 15, touch 15, flat-footed 13 (+2 Dex, +3 class); BAB +0; Grap +0; Atk +0 melee (1d4, knife), +2 ranged (2d10, Brase Arms Shotgun); Full +0 melee (1d4, knife), +2 ranged (2d10, Brase Arms Shotgun); FS 5 ft. by 5 ft.; Reach 5 ft.; SQ NA; AL Eos Freedom League; SV Fort -1, Ref +3, Will +1; AP ; Rep +; Str 10, Dex 15, Con 9, Int 14, Wis 13, Cha 12.

Occupation: Criminal.

Skills: Drive +6, Gamble +6, Hide +8, Knowledge (Streetwise) +6, Move Silently +8, Profession (Thief) +5, Sleight of Hand +7.

Talents: None.

Feats: Armor Proficiency (Light), Personal Firearms Proficiency, Stealthy.

Possessions: Brase Arms shotgun with 7 rounds, rough-out, silver necklace (Purchase DC 11), lock picks, bolt cutters, 5 days of water and trail rations, compass, flashlight.

[EASY] Red Tom**(Tough Ordinary 1) ♦ CR 1**

Medium humanoid; HD 1d10+2; hp 6; MAS 15; Init +2; Spd 30 ft.; Defense 13, touch 13, flat-footed 11 (+2 Dex, +1 class); BAB +0; Grap +1; Atk +1 melee (1d3+1, punch), +2 ranged (EDF-9 auto-pistol); Full +1 melee (1d3+1, punch), +2 ranged (EDF-9 auto-pistol); FS 5 ft. by 5 ft.; Reach 5 ft.; SQ NA; AL Eos Freedom League; SV Fort +3, Ref +2, Will -1; AP 0; Rep +0; Str 13, Dex 14, Con 15, Int 10, Wis 9, Cha 12.

Occupation: Criminal.

Skills: Bluff +3, Hide +6, Knowledge (Streetwise) +5, Survival +3.

Talents: None.

Feats: Armor Proficiency (Light), Faction Camp Familiarity (Roger's Point), Personal Firearms Proficiency.

Possessions: Rough-out, EDF-9 auto-pistol and 3 clips, fragmentation grenade, 5 days of water and trail rations, flashlight, maps, compass, 2 chemical light sticks, weather-control relic.

Serge Permant**(Fast Ordinary 1) ♦ CR 1**

Medium-size Humanoid; HD 1d8-1; hp 3; MAS 8; Init +2; Spd 30 ft.; Defense 15, touch 15, flat-footed 13 (+2 Dex, +3 class); BAB +0; Grap +0; Atk +0 melee (1d4, knife), +2 ranged (2d10, Brase Arms Shotgun); Full +0 melee (1d4, knife), +2 ranged (2d10, Brase Arms Shotgun); FS 5 ft. by 5 ft.; Reach 5 ft.; SQ NA; AL Eos Freedom League; SV Fort -1, Ref +3, Will +1; AP ; Rep +; Str 10, Dex 15, Con 9, Int 14, Wis 13, Cha 12.

Occupation: Criminal.

Skills: Drive +6, Gamble +6, Hide +8, Knowledge Streetwise +6, Move Silently +8, Profession (Thief) +5, Sleight of Hand +7.

Talents: None.

Feats: Armor Proficiency (Light), Personal Firearms Proficiency, Stealthy.

Possessions: Brase Arms shotgun with 3 rounds, rough-out, silver necklace (Purchase DC 11), lock picks, bolt cutters, 5 days of water and trail rations, compass, flashlight.

EVENTS • • •

A THE ATMOSPHERIC CONVERTER

Four hours after the PCs arrive, the atmospheric converter explodes if they have not taken the necessary steps to stop it. This explosion deals 16d6 points of damage to everything inside the outpost and levels the building. Creatures within 50 feet of the outpost suffer 4d6 points of damage. This damage is half concussive damage and half fire damage.

To stop this dangerous event, the PCs and the terraformers must complete four steps:

- 1 One character must activate the pressure release valves on the atmospheric converter. This may be accomplished from the computer room or the atmospheric converter room. This requires a Computer Use check (DC 15) or Terraforming check (DC 12) and ten minutes.
- 2 Two characters must run the atmospheric converter through its manual cool-down cycle, which may be done simultaneously with step one. This requires two characters to both make either a Computer Use check (DC 10) or a Terraforming check (DC 8) and takes 20 minutes.
- 3 One character must use the controls in the computer room to normalize the chemicals coming out of the converter, requiring a Terraforming check (DC 15). This process takes 10 minutes and can only be done after the pressure release valves are open (Step 1).
- 4 At least one character must go out on the roof top and manually clean debris from the pipes that function as the converter's emergency release system. The roof is accessed by a staircase abutting one of the exterior walls. This task takes ten minutes for one character to complete. Two characters working on this step together may reduce this time in half. Characters working on cleaning the pipes must make a Fortitude save (DC 10) or take 1d4 points of temporary Constitution damage and become nauseated from the fumes. Characters who attempt to cover their faces enjoy a +2 circumstance bonus to the saving throw. This is an excellent opportunity for the vaasi warhound to cause some chaos, if it has not already been dealt with.

Assuming these steps are completed, the atmospheric converter explosion will be averted. The surviving terraformers are more than willing to help the PCs carry out any of these tasks. If they have been freed and are not engaged in fighting the Finders, they will try to carry out these tasks on their own in order to complete them as soon as possible. If possible, the PCs should be involved in helping shut the converter down, especially going out on the roof to clean the pipes. The terraformers might suggest that they are too injured or weakened to accomplish the task.

B THE WEATHER-CONTROL RELIC

The weather-control relic is a metal rod, three feet long, roughly an inch in diameter, and weighing two pounds. It has five dials along its center, each labeled with alien script and surrounded by single alien characters that represent numbers. The script is that of the original inhabitants of Eos, which can be recognized with a Knowledge (History) check. Unfortunately, not enough is known of the language to decipher these symbols. The five dials control rain, cloud cover, fog, lightning, and wind. Currently the cloud cover and rain dials are turned up to their maximum value, and the damage to the device prevents them from being further adjusted to stop the effect. If the PCs play with the other dials before dismantling or destroying the device, turning the dials increases the fog, lightning, and wind in the area drastically.

After some investigation, it should become obvious that the only way to stop the torrential rains is to repair or disable the relic. Unfortunately, repairing the relic requires a Repair check (DC 40), and suffers a -12 penalty because it is a PL 9 device. This makes any repair attempt well out of the reach of the PCs. Five or more ranks in Craft (Electronic) confers a +2 synergy bonus to the check, and an electronics kit is required to make the repairs.

Alternatively, the PCs can try to destroy the device. The weather-control relic has a hardness of 10 and 4 hit points. Breaking the relic means it cannot be repaired at a later date, though selling its remains will net each of the PCs a Wealth bonus increase of +2.

Instead of using brute force, the PCs can try to use Disable Device to take the relic apart in such a fashion that it may be repaired later. This requires a Disable Device check (DC 20) and suffers a -12 penalty because it is a PL 9 device. If this check is successful, the device may be later repaired with a Repair check, DC 45. Selling it in this condition will net each of the PCs a Wealth bonus increase of +5.

The device allows the user to produce any type of weather over a 100 square mile area for up to five days. Temperature changes cannot be made; only cloud cover, rain, and similar weather factors can be controlled. The weather changes made take one hour to fully form and the device can only function for 24 hours every week.

C THE EOS FREEDOM LEAGUE EXTRACTION TEAM

Four hours after the PCs arrive at the outpost, a Dromedary Air Cargo Hauler lands on the outpost's landing pad and disgorges four Eos Freedom League soldiers to round up the Finders. The pilot of the Dromedary remains on-board, waiting for the soldiers to return. If two of the soldiers are slain and the pilot learns of this either through them not answering his radio calls or through direct observa-

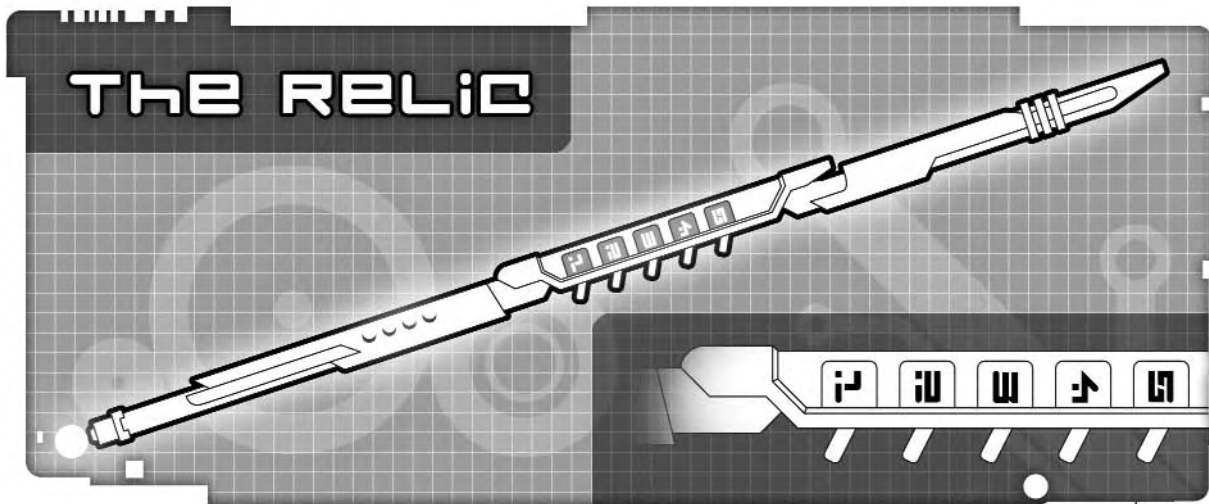

tion, the pilot will give the soldiers one warning to evacuate, wait three rounds, and then flee. The pilot's first concern is the ship, and he is willing to sacrifice the soldiers, if it means saving the Dromedary. The pilot will attack anyone else who attempts to board his ship.

The four soldiers are new recruits for the Eos Freedom League, all eager to prove their mettle. They are mostly dissidents and criminals, all of whom have violent pasts. They have been instructed to leave no witnesses, and they will carry out those orders. The soldiers are not concerned with anything or anyone besides the Finders and the relic they have. If need be, the soldiers will take the relic from the Finders and leave them behind. If two of the soldiers are killed or the Dromedary is threatened, they will all retreat to their ship and try to flee.

The soldiers' plan once they arrive is to go in through the main door and sweep the building, shooting anyone other than the Finders they come across. They will use grenades to clear rooms if need be, but are reluctant to do so because of possible damage to the relic. The likely best strategy for the PCs is to catch them coming off the Dromedary while they are out in the open.

◆ THE DROMEDARY CARGO HAULER

This vectored thrust aircraft has the abilities listed for vehicles of its type listed in Chapter 3 along with alumisteel armor, 6 light rockets, and an EDF-2 heavy machine gun mounted in the doorway of the main cargo entrance. If the GM doesn't want the PCs to come into possession of the Dromedary after the adventure, assuming it doesn't escape, the ship could have a remotely activated self-destruct mechanism or it could be identified as stolen property and repossessed by the Dawning Star Republic.

◆ SHEEVER CROSS, PILOT

Sheever Cross is new at the air runner game, having just inherited the Dromedary from his father.

Not content to be a mail and cargo runner like his father, Sheever left the Dawning Star Republic to find his fortune and ended up in the Eos Freedom League flying secret cargo runs. Sheever tries to keep his nose out of trouble and not ask too many questions, but many of his missions involve activities the Dawning Star Republic would not look well upon. Sheever is not a fighter and flees as soon as a mission turns sour, his prized Dromedary being the most valuable thing in the world to him besides his own life.

Sheever Cross (Fast Ordinary 1) ◆ CR 1

Medium-size Humanoid; HD 1d6+1; hp 5; MAS 13; Init +2; Spd 30 ft.; Defense 17, touch 15, flat-footed 15 (+2 Dex, +3 class, +2 armor); BAB +0; Grap +0; Atk +0 melee (1d4, knife), +2 ranged (2d6, EDF-9 auto-pistol); Full +0 melee (1d4, knife), +2 ranged (2d6, EDF-9 auto-pistol); FS 5 ft. by 5 ft.; Reach 5 ft.; SQ NA; AL Eos Freedom League; SV Fort +1, Ref +3, Will +2; AP 0; Rep +0; Str 10, Dex 15, Con 13, Int 12, Wis 14, Cha 8.

Occupation: Pilot.

Skills: Craft (Mechanical) +5, Drive +6, Navigate +5, Pilot +6, Profession (Pilot) +6, Repair +5.

Talents: None.

Feats: Aircraft Operation, Armor Proficiency (Light), Personal Firearms Proficiency.

Possessions: Flight suit and helmet, EDF-9 with 3 clips, info-comp, knife.

◆ EOS FREEDOM LEAGUE SOLDIERS

These four soldiers are not the most experienced warriors on Eos, but they have the determination to get the job done. They are all dedicated to the mission and have little compunction about killing the PCs, the terraformers, or even the Finders, if required.

[HARD] Eos Freedom League Soldiers
(Tough Ordinary 1) (4) ♦ CR 1

Medium-size Humanoid; HD 1d10+2; hp 11; MAS 15; Init +1; Spd 30 ft.; Defense 15, touch 12, flat-footed 14 (+1 Dex, +1 class, +3 armor); BAB +0; Grap +2; Atk +2 melee (1d4+2), +2 ranged (2d8, EDF-15 Knockoff); Full +2 melee (1d4+2), +2 ranged (2d8, EDF-15 Knockoff); FS 5 ft. by 5 ft.; Reach 5 ft.; SQ NA; AL Eos Freedom League; SV Fort +3, Ref +2, Will +1; AP 0; Rep +0; Str 14, Dex 13, Con 15, Int 10, Wis 12, Cha 8.

Occupation: Military.

Skills: Profession (Soldier) +5, Spot +5, Survival +5.

Talents: None.

Feats: Armor Proficiency (Light), Faction-Camp Familiarity, Personal Firearms Proficiency.

Possessions: Light combat armor, EDF-15 Knockoffs with 2 clips, knife, radios.

[AVERAGE] Eos Freedom League Soldiers
(Tough Ordinary 1) (4) ♦ CR 1

Medium-size Humanoid; HD 1d10+2; hp 7; MAS 15; Init +1; Spd 30 ft.; Defense 15, touch 12, flat-footed 14 (+1 Dex, +1 class, +3 armor); BAB +0; Grap +2; Atk +2 melee (1d4+2), +2 ranged (2d6, EDF-9 Knockoff); Full +2 melee (1d4+2), +2 ranged (2d6, EDF-9 Knockoff); FS 5 ft. by 5 ft.; Reach 5 ft.; SQ NA; AL Eos Freedom League; SV Fort +3, Ref +2, Will +1; AP 0; Rep +0; Str 14, Dex 13, Con 15, Int 10, Wis 12, Cha 8.

Occupation: Military.

Skills: Profession (Soldier) +5, Spot +5, Survival +5.

Talents: None.

Feats: Armor Proficiency (Light), Faction-Camp Familiarity, Personal Firearms Proficiency.

Possessions: Light combat armor, EDF-9 Knockoffs with 2 clips, knife, radios.

[EASY] Eos Freedom League Soldiers
(Tough Ordinary 1) (4) ♦ CR 1

Medium-size Humanoid; HD 1d10+2; hp 5; MAS 15; Init +1; Spd 30 ft.; Defense 14, touch 12, flat-footed 13 (+1 Dex, +1 class, +2 armor); BAB +0; Grap +2; Atk +2 melee (1d4+2), +2 ranged (2d6, EDF-9 Knockoff); Full +2 melee (1d4+2), +2 ranged (2d6, EDF-9 Knockoff); FS 5 ft. by 5 ft.; Reach 5 ft.; SQ NA; AL Eos Freedom League; SV Fort +3, Ref +2, Will +1; AP 0; Rep +0; Str 14, Dex 13, Con 15, Int 10, Wis 12, Cha 8.

Occupation: Military.

Skills: Profession (Soldier) +5, Spot +5, Survival +5.

Talents: None.

Feats: Armor Proficiency (Light), Faction-Camp Familiarity, Personal Firearms Proficiency.

Possessions: Scout armor, EDF-9 Knockoffs with 2 clips, knife, radios.

CONCLUSION • • •

The amount of experience points to award will depend on the level of encounters used and should be determined by the GM based upon the specific course of the adventure. As a guideline, since the adventure is meant to be an introduction to the setting, a reasonable award would place each of the characters halfway to attaining second level.

Assuming the PCs survive the Finders, the Eos Freedom League soldiers, save the converter, and stop the flooding, the rains soon stop and the PCs are home free. The terraformers are very thankful to the PCs and immediately file a report on their behalf with the Dawning Star Republic. Due to the goodwill engendered by their actions the PCs receive a +1 circumstance bonus to Charisma-based skill checks involving members of the Dawning Star Republic government and the citizens of Iron Scar for the next month.

If the Finders or the Eos Freedom League soldiers are still alive, the Eos Defense Force sends out a transport to pick them up for questioning. The Eos Freedom League denies all knowledge of both groups and denies the murder of the terraformer, but no one in the Dawning Star Republic takes their claims seriously. If the Dromedary falls into the hands of the PCs and the GM does not want them to have such a vehicle, the Dawning Star Republic could impound it as stolen property.

Assuming the PCs stop the weather-control relic, the rains cease within an hour of the relic being disabled, and the flooding stops shortly thereafter. The PCs can either walk away from the outpost to continue their original mission, wait for the Republic to send an aircraft to pick them up, or fly out on the Dromedary if they have it.

If the PCs manage to repair the weather-control relic they have a powerful and valuable item in their hands. Finding someone to sell it to may be just as dangerous as acquiring it, as both the Dawning Star Republic and the Eos Freedom League would be interested in such an item. The weather-control relic has a Purchase DC of 52.

Allowing the PCs to retain possession of such a powerful relic in fully-functioning form could have negative implications for the campaign. The GM should encourage the PCs to sell or otherwise turn the device over to another party. A formal request from the Dawning Star Department of Terraforming might do the trick. If the PCs do keep possession, the GM should ensure that the device remains inoperable unless and until it becomes otherwise acceptable. In fact, it could continue to serve as a plot point throughout the remainder of the campaign.

What happens when Freedom Leaguers from Roger's Point hear about their fancy little doodad?

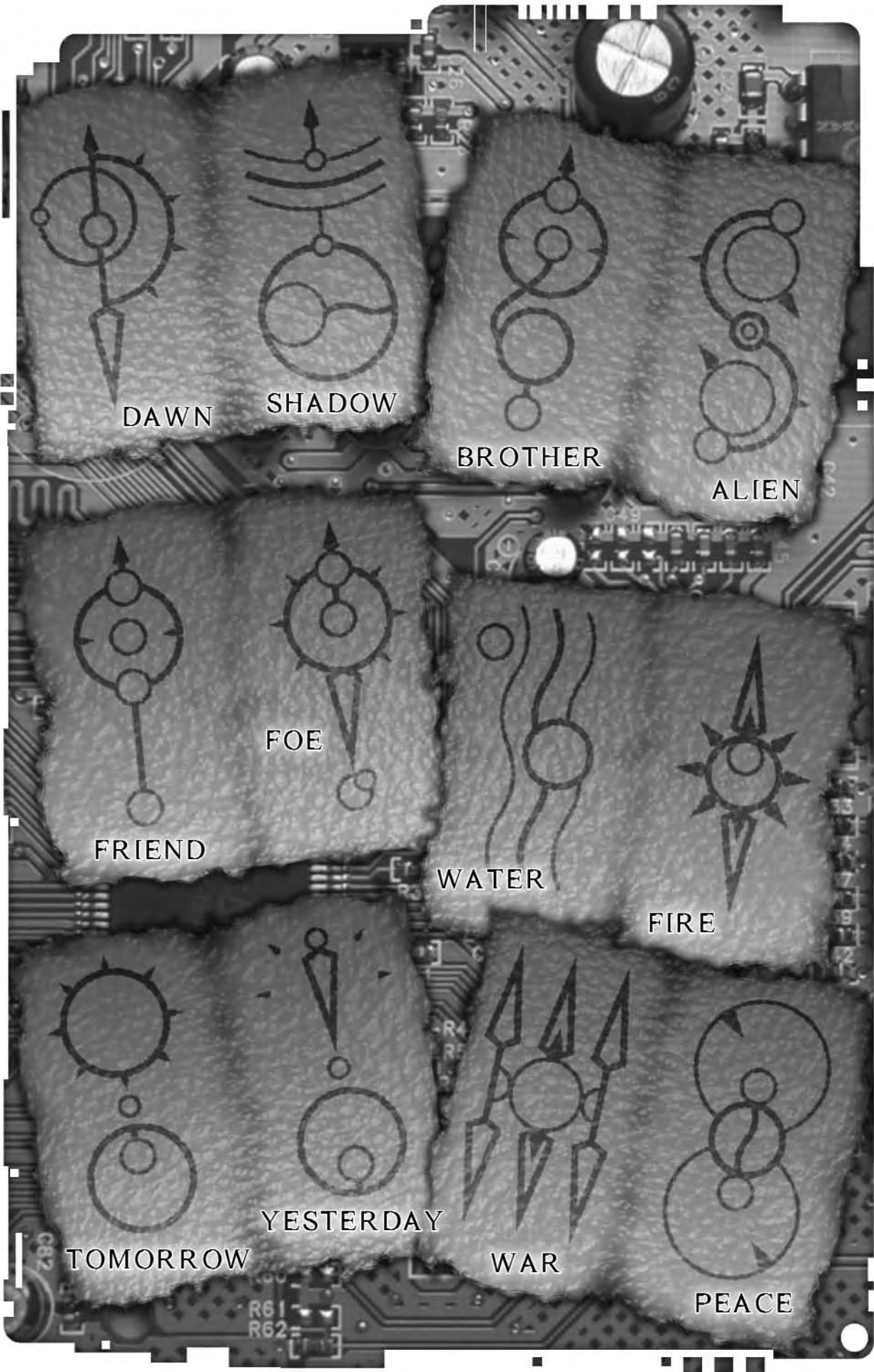

DAWN

SHADOW

BROTHER

ALIEN

FRIEND

FOE

WATER

FIRE

TOMORROW

YESTERDAY

WAR

PEACE





CHARACTER NAME _____ PLAYER _____ CAMPAIGN _____ EXPERIENCE POINTS _____

CLASS _____ CHARACTER LEVEL _____ STARTING OCCUPATION _____ SPECIES _____ PL FAMILIARITY _____ HOME PLANET _____

AGE _____ GENDER _____ HEIGHT _____ WEIGHT _____ EYES _____ HAIR _____ SKIN _____

ABILITIES

	ABILITY SCORE	ABILITY MODIFIER	TEMPORARY SCORE	TEMPORARY MODIFIER
STR STRENGTH				
DEX DEXTERITY				
CON CONSTITUTION				
INT INTELLIGENCE				
WIS WISDOM				
CHA CHARISMA				

HP hit points **TOTAL** **CURRENT HP**

DEFENSE = 10 + + + + + +

INITIATIVE modifier = +

BASE ATTACK bonus

SPEED



SAVING THROWS

	TOTAL	BASE SAVE	ABILITY MODIFIER	MISC MODIFIER
FORTITUDE (CONSTITUTION)	<input type="text"/>	<input type="text"/>	<input type="text"/>	<input type="text"/>
REFLEX (DEXTERITY)	<input type="text"/>	<input type="text"/>	<input type="text"/>	<input type="text"/>
WILL (WISDOM)	<input type="text"/>	<input type="text"/>	<input type="text"/>	<input type="text"/>

REPUTATION

ACTION POINTS

WEALTH BONUS

ATTACKS

MELEE Attack bonus = + + +

RANGED Attack bonus = + + +

WEAPON

PL	ATTACK BONUS	DAMAGE	DMG TYPE	CRITICAL
<input type="text"/>	<input type="text"/>	<input type="text"/>	<input type="text"/>	<input type="text"/>
RANGE	WEIGHT	TYPE	SIZE	SPECIAL PROPERTIES
<input type="text"/>	<input type="text"/>	<input type="text"/>	<input type="text"/>	<input type="text"/>

WEAPON

PL	ATTACK BONUS	DAMAGE	DMG TYPE	CRITICAL
<input type="text"/>	<input type="text"/>	<input type="text"/>	<input type="text"/>	<input type="text"/>
RANGE	WEIGHT	TYPE	SIZE	SPECIAL PROPERTIES
<input type="text"/>	<input type="text"/>	<input type="text"/>	<input type="text"/>	<input type="text"/>

WEAPON

PL	ATTACK BONUS	DAMAGE	DMG TYPE	CRITICAL
<input type="text"/>	<input type="text"/>	<input type="text"/>	<input type="text"/>	<input type="text"/>
RANGE	WEIGHT	TYPE	SIZE	SPECIAL PROPERTIES
<input type="text"/>	<input type="text"/>	<input type="text"/>	<input type="text"/>	<input type="text"/>

ARMOR/PROTECTIVE ITEM

PL	TYPE	EQUIPMENT BONUS	PROFICIENT?		
<input type="text"/>	<input type="text"/>	<input type="text"/>	Yes <input type="checkbox"/> No <input type="checkbox"/>		
ARMOR PENALTY	WEIGHT	SPEED	SIZE	MAX DEX	SPECIAL PROPERTIES
<input type="text"/>	<input type="text"/>	<input type="text"/>	<input type="text"/>	<input type="text"/>	<input type="text"/>

ARMOR/PROTECTIVE ITEM

PL	TYPE	EQUIPMENT BONUS	PROFICIENT?		
<input type="text"/>	<input type="text"/>	<input type="text"/>	Yes <input type="checkbox"/> No <input type="checkbox"/>		
ARMOR PENALTY	WEIGHT	SPEED	SIZE	MAX DEX	SPECIAL PROPERTIES
<input type="text"/>	<input type="text"/>	<input type="text"/>	<input type="text"/>	<input type="text"/>	<input type="text"/>

CROSS-CLASS

SKILLS

SKILL NAME	KEY	SKILL MODIFIER	ABILITY MODIFIER	RANKS MODIFIER	MISC MODIFIER	MAX RANKS
Balance	Dex					
Barter	Cha					
Bluff	Cha					
Climb	Str					
Computer Use	Int					
Concentration	Con					
Craft _____	Int					
Craft _____	Int					
Craft _____	Int					
Decipher Script ♦	Int					
Demolitions ♦	Int					
Diplomacy	Cha					
Disable Device ♦	Int					
Disguise	Cha					
Drive	Dex					
Escape Artist	Dex					
Forgery	Int					
Gamble	Wis					
Gather Information	Cha					
Handle Animal ♦	Cha					
Hide	Dex*					
Intimidate	Cha					
Investigate ♦	Int					
Jump	Str*					
Knowledge _____	Int					
Knowledge _____	Int					
Knowledge _____	Int					
Listen	Wis					
Move Silently	Dex*					
Navigate	Int					
Perform _____	Cha					
Perform _____	Cha					
Perform _____	Cha					
Pilot ♦	Dex					
Profession _____	Wis					
Read/Writing _____	Wis					
Read/Writing _____	Wis					
Read/Writing _____	Wis					
Repair ♦	Int					
Research	Int					
Sense Motive	Wis					
Sleight of Hand ♦	Dex					
Speak Language _____						
Speak Language _____						
Speak Language _____						
Spot	Wis					
Survival	Wis					
Swim	Str*					
Terraforming ♦	Int					
Treat Injury	Wis					
Tumble ♦	Dex*					

Skills marked with ♦ can't be used untrained. * ARMOR PENALTY, if any, applies.

INDEX • • •

“A Day in the Life” (Adventure)	183	Faction Camp Familiarity (Feat)	45
Advanced Classes	50	Fast Hero Talent Trees	29
Adventure Hooks	180	Feats	45
Adventuring Gear	74	Firearms, Eos Defense Force	81
Age Categories	26	Footwork (Talent Tree)	29
Air Runner (Advanced Class)	50	Genetic Engineering	97
Alien Friend (Feat)	45	Geography	120
Ammunition	89	Greenville	128
Animal Husbandry (Talent Tree)	34	Gunhand (Advanced Class)	57
Apollo	146	Gyro-Jet Weapons	84
Armor	90	Hapeville	130
Atlas	146	Harvest Town	128
Atmospheric Vehicles	101	Heavy Gravity Resistance (Talent Tree)	28
Barter (Skill)	42	Height and Weight	27
Barter Jack (Advanced Class)	52	Helios System	142
Blood Blister Survivor (Feat)	45	Helios System (Map)	144
Brase Family Firearms	86	Hephaestus	143
Broken Town	129	Hesperos	145
Bureaucrat (Occupation)	36	Human Survivor (Species Class)	48
C'Thalk	145	Humans	22
Campaign Concepts	178	Hunter (Occupation)	37
Character Sheet	202	Investigation (Talent Tree)	31
Charismatic Hero Talent Trees	34	Iron Scar	127
Climate	120	Iron Scar Charger	150
Colonial Leader (Advanced Class)	54	Iron Scar Familiarity (Feat)	45
Command (Talent Tree)	35	Iron Scar Scrapper	151
Computers	95	Languages	11
Courtier (Occupation)	36	Lanner’s Crossing	130
Craftsman (Feat)	45	Laser Weapons, Eos Defense Force	83
Creature Tanks	14	Law	17
Cronus Belt	146	Lawman (Advanced Class)	59
Cybernetics	97	Map (Dawning Star City)	126
Dawning Star (City)	125	Map (Eos)	122
Dawning Star (Ship)	117	Map (Helios System)	144
Dawning Star City (Map)	126	Markin Belt	143
Dawning Star Familiarity (Feat)	45	Master Craftsman (Feat)	46
Dawning Star Republic	125, 134	Master Trader (Feat)	46
Dawson Dragon	148	Measure of the City (Feat)	46
Dedicated Hero Talent Trees	33	Mecha	108
Delhi	130	Melee Weapons	77
Delhi Beacon	149	Mercantile (Talent Tree)	36
Diplomatic (Talent Tree)	35	Mounted Combat (Feat)	46
Dissident (Occupation)	36	Mounted Gunplay (Feat)	46
Eos	145	Murcow	152
Eos (Map)	122	Naming Conventions	15
Eos Freedom League	134	Nanotechnology	96
Eos Freedom League Member (Feat)	45	Navigation (Talent Tree)	31
Evacuation Fleet	142	Nomad (Occupation)	37
Explorer (Occupation)	37	NPC’s	135
Explorer Training (Feat)	45	Occupations	36
Factions and Federations	133		
Faction Camps	129		

Phrenic	170	Terraformer (Occupation)	38
Pilot (Occupation)	37	Terraformer's Guild	135
Plasma Weapons, Eos Defense Force	83	Terraforming	124
Plus Feats	28	Terraforming (Skill)	44
Poseidon	146	Terraforming Equipment	96
Prestige Classes	67	Terraforming Training (Feat)	47
Progress Levels	24	Thres	145
Psionics	27	Throwing Arm (Talent Tree)	29
Public Speaker (Feat)	46	Time	120
		Timeline	20
Radiation Resistance (Talent Tree)	30	Tough Hero Talent Trees	30
Rancher (Advanced Class)	60	Tough Rage (Talent Tree)	30
Ranch-Hand (Occupation)	38	Treatment (Talent Tree)	34
Ranged Weapons	81	Tribal Leader (Occupation)	39
Rebuilder (Advanced Class)	62	True Vaasi	166
Red Hill	128		
Relics	99	Vaasi	166, 176
Republic Militia Member (Feat)	46	Vaasi Maser Weapons	169
Republic Ranger (Prestige Class)	67	Vaasi Soldier	171
Resource Zones	132	Vaasi Warhound	172
Roger's Point	130	Vehicle Weapons	107
Ruins	133, 176	Velin	24, 176
		Velin Chief (Prestige Class)	69
Sap Trap	153	Velin Exorcism Dancer (Feat)	47
Scholar (Talent Tree)	31	Velin Guardian (Advanced Class)	64
Scientist (Occupation)	38	Velin Hunter (Species Class)	49
Shackleton	131	Velin Runes	201
Sharpshooter (Talent Tree)	29	Velin Tribal Council	135
Shovel-Headed Centipede	154	Velin Tribal Guest (Feat)	47
Siren Megalodon	154	Verdant	143
Skills	39		
Sloth Roach	156	Weapon Gadgets	90
Smart Hero Talent Trees	31	Weapon Materials	77
Spacer (Occupation)	38	Weapons	77
Species	22	Wildlife	148
Species Classes	48		
Species Familiarity (Feat)	46	Xeno-Expert (Occupation)	39
Spetsin	157	Xeno-Tech (Talent Tree)	32
Spitter Spider	158		
Starships	110	Yanoris Raptor	161
Steel End	131		
Street Irregulars (Feat)	46		
Strong Hero Talent Trees	28		
Strong Rage (Talent Tree)	28		
Stun Resistance (Talent Tree)	31		
Sun City	132		
Sunder Ridge	132		
Surface Vehicles	101		
Survival (Talent Tree)	33		
Swamp Hulk	159		
Sworn Enemy (Talent Tree)	33		
Talent Trees	28		
Tangier Family Firearms	87		
Technological Aptitude (Feat)	47		
Tentaari	19, 162, 175		
Tentaari Approved Diplomat (Feat)	47		
Tentaari Disintegrator Pistol	165		
Tentarri Gateway Station	146		

DAWNING STAR

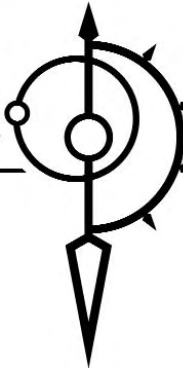

Operation Quick Launch
is just the beginning.
Blue Devil Games
is proud to announce
the full line of Dawning Star
products available this year.

◆ **Helios Rising** ◆ Take your Dawning Star campaign to the stars! Explore the farthest reaches of the Helios system from the Saurian Empire of the planet C'Thalk to the cryptic mechanical metropolis on the moons of Apollo. 11 playable alien species with exhaustive information and rules for each, detailed maps and descriptions of every point of interest in the system.

208 PAGES (HC), \$29.95, MAY 2005.

◆ **Silver Eclipse** ◆ Like the gleam of a night star, a spacecraft streaks through the skies above Eos. Climb aboard a saurian dreadnought or take the helm of a straasian hiveship. Starship templates and floorplans for every major alien species, advanced starship construction rules and mechanics for space warfare.

128 PAGES, \$21.95, JULY 2005.

◆ **Heroes of Helios** ◆ When shadows cast over the land, only the light of true heroes can stand against it. This sourcebook presents a host of new options for your Dawning Star character, including new feats, talent trees, classes, alternate alien species, character concepts, and an extended character record folio.

208 PAGES, \$29.95, AUGUST 2005.

◆ **Shadow Falling** ◆ A quick-and-dirty relic hunt goes horribly wrong, and you are sent in to rescue the excavation team. The activation of some long-dormant transport system leaves you trapped deep beneath the surface of Eos on the outskirts of a vaasi warcamp. Who will come to save you? An entry-level adventure usable in any space-faring campaign.

48 PAGES, \$9.95, AUGUST 2005.

◆ **Dawning Star GM's Screen** ◆ A PL 9 resource for every d20 GM. This landscape-oriented screen features new color art by Danilo Moretti and every table, chart, or rule you'll ever need.

\$9.95, AUGUST 2005.

◆ **Shining Star** ◆ The jewel of the Republic, the city of Dawning Star represents the best of the human spirit. Every day, hard-working citizens strive to rebuild society, from the Chinese grease monkey keeping the machinery running smoothly to the Mexican EDF agent tracking illicit arms shipments within the walls. Detailed city maps and location descriptions, dozens of NPCs, and a host of adventure seeds.

96 PAGES, \$18.95, OCTOBER 2005.

◆ **Rebel Stronghold** ◆ Roger's Point is a bastion of true freedom on Eos ... and they'll have words with anyone who says otherwise. The largest and most powerful faction camp is home to many colorful characters, and this sourcebook serves them all up.

96 PAGES, \$18.95, NOVEMBER 2005.

◆ **Shadow War** ◆ The war between shadow and light ends here and ends now. Spanning from the depths of the Eotian ruins to the heart of the Vaasi Empire, this mega-adventure, complete with side treks, takes characters from levels 1 to 20 and beyond.

208 PAGES, \$29.95, NOVEMBER 2005.

OPEN GAME LICENSE VERSION 1.0A

The following text is the property of Wizards of the Coast, Inc. and is Copyright 2000 Wizards of the Coast, Inc ("Wizards"). All Rights Reserved.

1. Definitions: (a) "Contributors" means the copyright and/or trademark owners who have contributed Open Game Content; (b) "Derivative Material" means copyrighted material including derivative works and translations (including into other computer languages), potation, modification, correction, addition, extension, upgrade, improvement, compilation, abridgment or other form in which an existing work may be recast, transformed or adapted; (c) "Distribute" means to reproduce, license, rent, lease, sell, broadcast, publicly display, transmit or otherwise distribute; (d) "Open Game Content" means the game mechanic and includes the methods, procedures, processes and routines to the extent such content does not embody the Product Identity and is an enhancement over the prior art and any additional content clearly identified as Open Game Content by the Contributor, and means any work covered by this License, including translations and derivative works under copyright law, but specifically excludes Product Identity. (e) "Product Identity" means product and product line names, logos and identifying marks including trade dress; artifacts; creatures characters; stories, storylines, plots, thematic elements, dialogue, incidents, language, artwork, symbols, designs, depictions, likenesses, formats, poses, concepts, themes and graphic, photographic and other visual or audio representations; names and descriptions of characters, spells, enchantments, personalities, teams, personas, likenesses and special abilities; places, locations, environments, creatures, equipment, magical or supernatural abilities or effects, logos, symbols, or graphic designs; and any other trademark or registered trademark clearly identified as Product identity by the owner of the Product Identity, and which specifically excludes the Open Game Content; (f) "Trademark" means the logos, names, mark, sign, motto, designs that are used by a Contributor to identify itself or its products or the associated products contributed to the Open Game License by the Contributor (g) "Use", "Used" or "Using" means to use, Distribute, copy, edit, format, modify, translate and otherwise create Derivative Material of Open Game Content. (h) "You" or "Your" means the licensee in terms of this agreement.

2. The License: This License applies to any Open Game Content that contains a notice indicating that the Open Game Content may only be Used under and in terms of this License. You must affix such a notice to any Open Game Content that you Use. No terms may be added to or subtracted from this License except as described by the License itself. No other terms or conditions may be applied to any Open Game Content distributed using this License.

3. Offer and Acceptance: By Using the Open Game Content You indicate Your acceptance of the terms of this License.

4. Grant and Consideration: In consideration for agreeing to use this License, the Contributors grant You a perpetual, worldwide, royalty-free, non-exclusive license with the exact terms of this License to Use, the Open Game Content.

5. Representation of Authority to Contribute: If You are contributing original material as Open Game Content, You represent that Your Contributions are Your original creation and/or You have sufficient rights to grant the rights conveyed by this License.

6. Notice of License Copyright: You must update the COPYRIGHT NOTICE portion of this License to include the exact text of the COPYRIGHT NOTICE of any Open Game Content You are copying, modifying or distributing, and You must add the title, the copyright date, and the copyright holder's name to the COPYRIGHT NOTICE of any original Open Game Content you Distribute.

7. Use of Product Identity: You agree not to Use any Product Identity, including as an indication as to compatibility, except as expressly licensed in another, independent Agreement with the owner of each element of that Product Identity. You agree not to indicate compatibility or co-adaptability with any Trademark or Registered Trademark in conjunction with a work containing Open Game Content except as expressly licensed in another, independent Agreement with the owner of such Trademark or Registered Trademark. The use of any Product Identity in Open Game Content does not constitute a challenge to the ownership of that Product Identity. The owner of any Product Identity used in Open Game Content shall retain all rights, title and interest in and to that Product Identity.

8. Identification: If you distribute Open Game Content You must clearly indicate which portions of the work that you are distributing are Open Game Content.

9. Updating the License: Wizards or its designated Agents may publish updated versions of this License. You may use any authorized version of this License to copy, modify and distribute any Open Game Content originally distributed under any version of this License.

10. Copy of this License: You MUST include a copy of this License with every copy of the Open Game Content You Distribute.

11. Use of Contributor Credits: You may not market or advertise the Open Game Content using the name of any Contributor unless You have written permission from the Contributor to do so.

12. Inability to Comply: If it is impossible for You to comply with any of the terms of this License with respect to some or all of the Open Game Content due to statute, judicial order, or governmental regulation then You may not Use any Open Game Material so affected.

13. Termination: This License will terminate automatically if You fail to comply with all terms herein and fail to cure such breach within 30 days of becoming aware of the breach. All sublicenses shall survive the termination of this License.

14. Reformation: If any provision of this License is held to be unenforceable, such provision shall be reformed only to the extent necessary to make it enforceable.

15. COPYRIGHT NOTICE

Open Game License v 1.0 Copyright 2000, Wizards of the Coast, Inc.

Modern System Reference Document Copyright 2002-2004, Wizards of the Coast, Inc.; Authors Bill Slavicsek, Jeff Grubb, Rich Redman, Charles Ryan, Eric Cagle, David Noonan, Stan!, Christopher Perkins, Rodney Thompson, and JD Wiker, based on material by Jonathan Tweet, Monte Cook, Skip Williams, Richard Baker, Peter Adkison, Bruce R. Cordell, John Tynes, Andy Collins, and JD Wiker.

Dawning Star: Operation Quick Launch Copyright 2004, Justin D. Jacobson

THRILLING PASSAGES

Adventures Penned by Literary Giants

Summer 2005

Lose Yourself in a Good Book!

BLUE DEVIL GAMES

by Richard Farrese